



**Department of  
Design and  
Construction**

**THE CITY OF NEW YORK  
DEPARTMENT OF DESIGN AND CONSTRUCTION  
DIVISION OF INFRASTRUCTURE**

30-30 THOMSON AVENUE  
LONG ISLAND CITY, NEW YORK 11101-3045  
TELEPHONE (718) 391-1000  
WEBSITE [www1.nyc.gov/site/ddc/index.page](http://www1.nyc.gov/site/ddc/index.page)

**VOLUME 1 OF 3**

**BID BOOKLET**

FOR FURNISHING ALL LABOR AND MATERIALS NECESSARY AND  
REQUIRED FOR:

**PROJECT ID: SANDHW11**

**RECONSTRUCTION OF**

**BEACH CHANNEL DRIVE**

**BETWEEN BEACH 116TH STREET AND BEACH 124TH STREET**

**INCLUDING SEWER, WATER MAIN, TRAFFIC SIGNAL  
AND STREET LIGHTING WORK**

**Together With All Work Incidental Thereto**

**BOROUGH OF QUEENS  
CITY OF NEW YORK**

FOR THE DEPARTMENT OF TRANSPORTATION  
PREPARED BY

*IN-HOUSE DESIGN*

**SEPTEMBER 29, 2016**

NYS DOT PIN X777.44

Fed. Aid Project No. \_\_\_\_\_



**7-053**

**Bid Tab**

**Description** RECONSTRUCTION OF BEACH CHANNEL DRIVE BETWEEN  
BEACH 116TH STREET AND 124TH STREET -BOROUGH OF QUEENS

<b>Bid Date</b>	4/13/2017	<b>FMS ID</b>	SANDHW11
<b>Estimated Cost</b>	\$16,258,360.00	<b>Client Agency</b>	DOT
<b>Bid Security</b>	Not less than 5% of Total Bid Price	<b>PLA</b>	NO
<b>Time Allowed</b>	730CCD	<b>Federal Funded:</b>	Yes
<b>Addendum</b>	2	<b>Contract Manager</b>	Victoria Ayo-Vaughan
<b>PIN</b>	8502017HW0001C	<b>Project Manager</b>	Molene Legros
<b>Selective Bidding</b>	<input type="checkbox"/> Yes <input checked="" type="checkbox"/> No	<b>E-PIN</b>	85017B0031

---

<b>Bid Rank</b>	<b>Vendor</b>	<b>Bid Amount</b>	<b>Security Type</b>
1	NY ASPHALT INC	\$13,639,587.00	Bond
2	J. PIZZIRUSSO LANDSCAPING CORP.	\$15,190,250.00	Bond
3	JR CRUZ CORP	\$15,535,316.89	Bond
4	PERFETTO CONTRACTING CO. INC.	\$16,100,000.00	Bond
5	HALCYON CONSTRUCTION CORP.	\$16,590,000.00	Bond
6	P & T II CONTRACTING CORP.	\$16,793,293.29	Bond
7	C.A.C. INDUSTRIES, INC.	\$17,521,230.60	Bond



**Department of  
Design and  
Construction**

Ana Barrio  
Acting Commissioner

Justin Walter  
Chief Administrative Officer  
Administration

Charlette Hamangian, Esq.  
Agency Chief  
Contracting Officer

Lorraine Holley  
Deputy ACCO  
Competitive Sealed  
Bid Contracts

November 09, 2017

CERTIFIED MAIL - RETURN RECEIPT REQUEST  
NY ASPHALT INC  
366 INDUSTRIAL LOOP  
STATEN ISLAND, NY 10309

RE: FMS ID: SANDHW11  
E-PIN: 85017B0031001  
DDC PIN: 8502017HW0001C  
RECONSTRUCTION OF BEACH  
CHANNEL DRIVE BETWEEN BEACH  
116TH STREET AND 124TH STREET -  
BOROUGH OF QUEENS  
NOTICE OF AWARD

Dear Contractor:

You are hereby awarded the above referenced contract based upon your bid in the amount of \$13,639,587.00 submitted at the bid opening on April 13, 2017. Within ten (10) days of your receipt of this notice of award, you are required to take the actions set forth in Paragraphs (1) through (3) below. For your convenience, attached please find a copy of Schedule A of the General Conditions to the Contract, which sets forth the types and amounts of insurance coverage required for this contract.

- (1) Execute two copies of the Agreement in the Contracts Unit, 30-30 Thomson Avenue, 1<sup>st</sup> Floor, Long Island City, New York (IDCNY Building). A Commissioner of Deeds will be available to witness and notarize your signature. The Agreement must be signed by an officer of the corporation or a partner of the firm.
- (2) Submit to the Contracts Unit two properly executed performance and payment bonds. If required for this contract, copies of performance and payment bonds are attached.
- (3) Submit to the Contracts Unit the following insurance documentation: (a) original certificate of insurance for general liability in the amount required by Schedule A, and (b) original certificates of insurance or other proof of coverage for workers' compensation and disability benefits, as required by New York State Law. The insurance documentation specified in this paragraph is required for registration of the contract with the Comptroller's Office.



On or before the contract commencement date, you are required to submit all other certificates of insurance and/or policies in the types and amounts required by Schedule A. Such certificates of Insurance and/or policies must be submitted to the Agency Chief Contracting Office, Attention: Risk Manager, Fourth Floor at the above indicated department address.

Your attention is directed to the section of the Information for Bidders entitled "Failure to Execute Contract". As indicated in this section, in the event you fail to execute the contract and furnish the required bonds within the (10) days of your receipt of this notice of award, your bid security will be retained by the City and you will be liable for the difference between your bid price and the price for which the contract is subsequently awarded, less the amount of the bid security retained.

Sincerely,

A handwritten signature in black ink, appearing to read "Michael Shipman", is positioned above the printed name and title.

Michael Shipman  
Director of Contracts

# Notices to Bidders

## Pre-Bid Questions (PBQs)

Please be advised that PBQs should be submitted to the Agency Contact Person at least five (5) business days (by 5:00 PM EST) prior to the bid opening date as indicated in ATTACHMENT 1 - BID INFORMATION, page A-1 and SCHEDULE B, page 13, VOLUME 1 OF 3 of this BID BOOKLET.

## Apprenticeship Program

*If Apprenticeship Program is required as noted on Page 19 of this BID BOOKLET, the following notice applies:*

Please be advised that, pursuant to the authority granted to the City under Labor Law §816-b, the New York City Department of Design and Construction hereby requires that the contractor awarded a contract as a result of this solicitation, and any of its subcontractors with subcontracts worth two million dollars or over, have, prior to entering into such contract or subcontract, apprenticeship agreements appropriate for the type and scope of work to be performed that have been registered with, and approved by, the New York State Commissioner of Labor. In addition, the contractor and its subcontractors will be required to show that such apprenticeship program/s have successfully passed the two year Probation period following the initial registration date of such program/s with the New York State Department of Labor.

The failure to prove, upon request, that these requirements have been met shall result in the contract not being awarded to the contractor or the subcontractor not being approved.

Please be further advised that, pursuant to Labor Law §220, the allowable ratio of apprentices to journeypersons in any craft classification shall not be greater than the ratio permitted to the contractor as to its workforce on any job under the registered apprenticeship program.

# Notices to Bidders

## Compliance with HireNYC and Reporting Requirements

The Hiring and Employment Rider shall apply to contracts valued at \$1 million or more for all goods, services and construction except human services contracts that are subject to the Public Assistance Hiring Commitment Rider. The Rider describes the Hire NYC process and obligations, including reporting requirements throughout the life of the contract. The Hire NYC process requires contractors to enroll with the Hire NYC system within thirty days after the registration of the contract subject to this solicitation, to provide information regarding all entry to mid-level job opportunities arising from this contract and located in New York City, and to agree to interview qualified candidates from HireNYC for those opportunities. The Rider also includes reporting requirements unrelated to HireNYC.

## NYC Construction Loan Pilot Program

The New York City Department of Small Business Services (SBS), in conjunction with the New York Business Development Corporation (NYBDC), have established a **NYC Construction Loan** pilot program to provide prime contractors and subcontractors financing for mobilization costs on certain City construction projects.

Under this initiative, loans are available for early stage mobilization needs such as insurance, labor, supplies and equipment. Bidders are strongly encouraged to visit "Growing Your Business" at [www.nyc.gov/nycbusiness](http://www.nyc.gov/nycbusiness) to learn more about the loan or contact [constructionloan@sbs.nyc.gov](mailto:constructionloan@sbs.nyc.gov) / (212) 513-6444 to obtain details and to determine preliminary eligibility.

A successful loan applicant will be required to make an assignment of its contract (or subcontract) payments to the lender NYBDC until the loan is repaid. If the loan is to a subcontractor, a prime contractor must honor the terms of such an assignment.

A prime contractor may not discriminate against a subcontractor or potential subcontractor by reason of the subcontractor's participation, or nonparticipation, in the NYC Construction loan program.

**PROJECT ID: SANDHW11**

**CITY OF NEW YORK  
DEPARTMENT OF DESIGN AND CONSTRUCTION  
DIVISION OF INFRASTRUCTURE**

**BID BOOKLET**

**TABLE OF CONTENTS**

<b>SECTION</b>	<b>PAGE</b>
<b>PART A</b>	
1. Table of Contents.....	1
2. Special Notice to Bidders.....	2
3. Attachment 1 – Bid Information.....	A-1
4. Bid Schedule.....	B-1
5. Bid Form.....	C-1
6. Affirmation.....	C-6
7. Bid Bond .....	C-7
8. M/WBE Program: M/WBE Utilization Plan.....	5
9. Apprenticeship Program Requirements .....	19
<b>PART B</b>	
10. Safety Questionnaire .....	22
11. Pre-award Process.....	25
12. Project Reference Form.....	27
13. Contract Certificate.....	30
14. Vendex Compliance.....	31
15. Iran Divestment Act Compliance Rider .....	32
16. Construction Employment Report.....	34

(NO TEXT ON THIS PAGE)



**CITY OF NEW YORK  
DEPARTMENT OF DESIGN AND CONSTRUCTION  
DIVISION OF INFRASTRUCTURE**

**SPECIAL NOTICE TO BIDDERS – FEDERALLY FUNDED CONTRACTS (Revised 11-2016)**

**BID SUBMISSION REQUIREMENTS**

**THE FOLLOWING DOCUMENTS ARE TO BE COMPLETED AND SUBMITTED WITH THE BID:**

1. Bid Schedule and Bid Form, including Affirmation
2. Bid Security (if required, see Attachment 1 on Page A-1)
3. Debarment History Certification (See Page TF-J1 in the TF-Pages)
4. DBE Schedule of Utilization (See Page TF-D6 in the TF-Pages)

**FAILURE TO SUBMIT ITEMS (1) THROUGH (5)  
WILL RESULT IN THE DISQUALIFICATION OF THE BID.**

5. Safety Questionnaire
6. Construction Employment Report (if bid is \$1,000,000 or more)
7. Contract Certificate (if bid is less than \$1,000,000)
8. Confirmation of Vendex Compliance
9. Bidder's Certification of Compliance with Iran Divestment Act
10. Special Experience Requirements (if applicable)
11. Apprenticeship Program Questionnaire
12. Disclosure of Lobbying Activities (if applicable) (See Page TF-J3 in the TF-Pages)
13. Any addenda issued prior to the receipt of bids

**FAILURE TO SUBMIT ITEMS (5) THROUGH (14)  
MAY RESULT IN THE DISQUALIFICATION OF THE BID.**

**NOTES:**

- (1) All of the above referred to blank forms to be completed and submitted with the bid are included in the BID BOOKLET, except forms for items (3), (4), and (12) which are in the TF-Pages as noted above.
- (2) If the bidder has any questions or requires additional information, please contact the Department of Design and Construction by phone (718-391- 2601) or by fax (718-391-2615).
- (3) **VENDEX QUESTIONNAIRES:** The Bidder is advised that Vendex Questionnaires and procedures have been changed. Vendex Questionnaires, as well as detailed instructions, may be obtained at [www.nyc.gov/vendex](http://www.nyc.gov/vendex). The bidder may also obtain Vendex forms and instructions by contacting the Agency Chief Contracting Officer or the contact person for this contract.
- (4) **SPECIAL EXPERIENCE REQUIREMENTS:** The Bidder is advised that Special Experience Requirements may apply to this contract. Such requirements are set forth on pages 3, 3a, 3b, and 4 of this Bid Booklet.

**SPECIAL NOTICE TO BIDDERS**

**SPECIAL EXPERIENCE REQUIREMENTS (Revised 03/2014)**

- (A) **SPECIAL EXPERIENCE REQUIREMENTS FOR THE BIDDER:** The Special Experience Requirements set forth below apply to the bidder. Compliance with such Special Experience Requirements will be determined solely by the City prior to an award of contract. Failure to comply with the Special Experience Requirements will result in rejection of the bid as non-responsive.

The requirements in this Section (A) apply to this contract where indicated by a blackened box (■).

- The bidder must, within the last seven (7) consecutive years prior to the bid opening, have successfully completed in a timely fashion at least one (1) project similar in scope and type to the required work. Such prior project may have been performed as a prime contractor, subcontractor or sub-subcontractor.

The Special Experience Requirements next to the blackened box below apply to the bidder. If the bidder intends to perform such work itself, it must demonstrate compliance with the Special Experience Requirements. If the bidder intends to subcontract this work, the proposed subcontractor or sub-subcontractor must demonstrate compliance with the Special Experience Requirements. The contractor, subcontractor or sub-subcontractor (hereinafter referred to as the "entity") that will perform any specific area of work indicated by the blackened box below, may have performed the required prior project(s) as a prime contractor, subcontractor or sub-subcontractor. Once approved, no substitution will be permitted, unless the qualifications of the proposed replacement have been approved in writing in advance by the City.

- Trunk Water Main Work:** The entity that will perform the trunk water main work must, within the last seven (7) consecutive years prior to the bid opening, have successfully completed in a timely fashion at least one (1) project similar in scope and type to the required work.
- Best Management Practice Work:** Best Management Practice ("BMP") Work is any item of work in the Bid Schedule that begins with the prefix "BMP". The entity that will perform any BMP Work must, within the last five (5) consecutive years prior to the bid opening, have successfully completed in a timely fashion at least three (3) projects similar in scope and type to the required work.

For professional services in connection with BMP Work, (i.e., monitoring and reporting services), the individual who will perform the required services must, within the last five (5) consecutive years prior to the bid opening, have successfully completed in a timely fashion at least three (3) projects similar in scope and type to the required work. Additional requirements are set forth below.

- The individual serving as the Restoration Specialist (Construction Monitor) must be a Registered Landscape Architect licensed by the state of New York, or must have equivalent professional experience.
- The individual serving as the Erosion and Sediment Control Licensed/Certified Professional must be a Certified Professional in Erosion and Sediment Control (CPESC), certified by CPESC, Inc.
- Micro-Tunneling/Pipe Jacking Work:** The entity that will perform the micro-tunneling/pipe jacking work must, within the last five (5) consecutive years prior to the bid opening, have successfully completed in a timely fashion at least two (2) projects similar in scope and type to the required work.
- OTHER:** \_\_\_\_\_  
\_\_\_\_\_

**(B) SPECIAL EXPERIENCE REQUIREMENTS FOR SPECIFIC AREAS OF WORK (to be provided after an award of contract):**

The requirements in this Section (B) apply to this contract where indicated by a blackened box (■).

The Special Experience Requirements set forth below apply to the contractor, subcontractor or sub-subcontractor that will perform the specific area of work. **Compliance with such Special Experience Requirements will be determined solely by the City after an award of contract.** After an award of contract, when requested by the City, the contractor will be required to submit the qualifications of the contractor, subcontractor or sub-subcontractor that will perform the specific area of work. If the bidder intends to perform such work itself, it must demonstrate compliance with the Special Experience Requirements. If the bidder intends to subcontract this work, the proposed subcontractor or sub-subcontractor must demonstrate compliance with the Special Experience Requirements. Once approved, no substitution will be permitted, unless the qualifications of the proposed replacement have been approved in writing in advance by the City.

Special Experience Requirements apply to the contractor, subcontractor or sub-subcontractor (hereinafter referred to as the "entity") that will perform any specific area of work indicated by a blackened box. The entity may have performed the required prior project(s) as a prime contractor, subcontractor or sub-subcontractor.

■ **Hazmat Work:** Hazmat Work is any item of work in the Bid Schedule that begins with the prefix 8.01. The entity that will perform any Hazmat Work must, within the last three (3) consecutive years prior to the bid opening, have successfully completed in a timely fashion at least five (5) projects similar in scope and type to the required work.

□ **Pile, CFA Pile, and/or Mini-Pile Work:** The entity that will perform the Pile, CFA Pile and/or Mini-Pile Work must, within the last three (3) consecutive years prior to the bid opening, have successfully completed in a timely fashion at least two (2) projects similar in scope and type to the required work.

For professional services in connection with Pile Work, (i.e., engineering and inspection services), the individual who will perform the required services must be a Professional Engineer licensed by the state of New York. Such individual must also comply with the above requirements for prior projects.

□ **Construction Report, Monitoring And Post-Construction Report, and Continuous Real-Time Monitoring For Vibrations And Movements And Post-Construction Report Work:** The entity that will perform the Construction Report, Monitoring For Vibrations And Movements, and Post-Construction Report Work must, within the last three (3) consecutive years prior to the bid opening, have successfully completed in a timely fashion at least two (2) projects similar in scope and type to the required work.

For professional services in connection with Reporting and Monitoring Work, (i.e., engineering and inspection services), the individual who will perform the required services must be a Professional Engineer licensed by the state of New York. Such individual must also comply with the above requirements for prior projects.

□ **OTHER:** \_\_\_\_\_  
\_\_\_\_\_

(C) **SPECIFICATIONS:** In the event of any conflict, omission or inconsistency between (1) the Specifications and/or Contract Drawings, and (2) the Special Experience Requirements in Section (B) of the Special Notice To Bidders, the special experience listed in the Specifications and/or Contract Drawings shall be controlling. The Special Experience Requirements in Section (B) of this Special Notice To Bidders are only for the convenience of the bidders.

(D) **SUBMISSION REQUIREMENTS:** For each project submitted to demonstrate compliance with the Special Experience Requirements, the bidder must complete and submit the Qualification Form included in the Bid Booklet. The City will only evaluate a project if the following criteria are met: (1) the project is described on the Qualification Form, and (2) all information on the Qualification Form is provided. The City will not evaluate any project which does not comply with the criteria set forth herein, including any project which is referred to only on the resume of an individual.

If Special Experience Requirements are indicated for any specific area of work, the submission requirement set forth above shall apply to the entity that will perform the specific area of work.

(E) **CONDITIONS:** In determining compliance with the Special Experience Requirements for the bidder set forth above, the City may consider prior projects completed by principal(s) or other employees of the bidder while affiliated with another entity, subject to the conditions set forth below.

- Any principal or other employee on whose prior experience the bidder is relying to demonstrate compliance with this special experience requirement must have held the following: (a) a significant management role in the prior entity with which he/she was affiliated, and (b) a significant management role in the entity submitting the bid for a period of six (6) months or more from the inception of the bidding entity.
- The bidder may not rely on the experience of its principals or other employees to demonstrate compliance with any other requirements, including without limitation, financial requirements or requirements for a specified minimum amount of annual gross revenues.

(F) **JOINT VENTURES:** In the event the bidder is a joint venture, at least one firm in the joint venture must meet the above described experience requirements.

**Qualification Form**

List previous projects completed to meet the special experience requirements for this contract.  
Please photocopy this form for submission of all required projects.

Name of Contractor: \_\_\_\_\_

Name of Project: \_\_\_\_\_

Location of Project: \_\_\_\_\_

Owner or Owner's representative (Architect or Engineer) who is familiar with the work performed:

Name: \_\_\_\_\_

Title: \_\_\_\_\_ Phone Number: \_\_\_\_\_

Brief description of the Project completed or the Project in progress: \_\_\_\_\_

\_\_\_\_\_

Was the Project performed as a prime, a subcontractor or a sub-subcontractor: \_\_\_\_\_

Amount of Contract, Subcontract or Sub-subcontract: \_\_\_\_\_

Start Date and Completion Date: \_\_\_\_\_

\*\*\*\*\*

Name of Contractor: \_\_\_\_\_

Name of Project: \_\_\_\_\_

Location of Project: \_\_\_\_\_

Owner or Owner's representative (Architect or Engineer) who is familiar with the work performed:

Name: \_\_\_\_\_

Title: \_\_\_\_\_ Phone Number: \_\_\_\_\_

Brief description of the Project completed or the Project in progress: \_\_\_\_\_

\_\_\_\_\_

Was the Project performed as a prime, a subcontractor or a sub-subcontractor: \_\_\_\_\_

Amount of Contract, Subcontract or Sub-subcontract: \_\_\_\_\_

Start Date and Completion Date: \_\_\_\_\_

\_\_\_\_\_

(NO TEXT ON THIS PAGE)

ATTACHMENT 1 - BID INFORMATION

PROJECT ID: SANDHW11

PIN: 8502017HW0001C

Description and Location of Work:

RECONSTRUCTION OF  
BEACH CHANNEL DRIVE  
BETWEEN BEACH 116TH STREET AND BEACH 124TH STREET

INCLUDING SEWER, WATER MAIN, YTAFFIC SIGNAL  
AND STREET LIGHTING WORK

Together With All Work Incidental Thereto

BOROUGH OF QUEENS  
CITY OF NEW YORK

Documents Available At: 30-30 Thomson Avenue  
First Floor Bid Procurement Room  
Long Island City, New York 11101  
8:30 A.M. to 4:00 P.M. – Monday through Friday

Submission of Bids To: 30-30 Thomson Avenue  
First Floor Bid Procurement Room  
Long Island City, New York 11101  
Before 11:00 A.M. on MARCH 31, 2017

Bid Opening: 30-30 Thomson Avenue  
First Floor Bid Procurement Room  
Long Island City, New York 11101  
Time and Date: 11:00 A.M. on MARCH 31, 2017

Pre-Bid Conference: Yes \_\_\_\_\_ No X  
If Yes, Mandatory \_\_\_\_\_ Optional: \_\_\_\_\_  
Time and Date: \_\_\_\_\_  
Location: \_\_\_\_\_

Bid Security: Bid Security is required in the amount set forth below; provided, however, bid security is not required if the TOTAL BID PRICE set forth on the Bid Form is less than \$ 1,000,000.00.

- (1) Bond in an amount not less than 10% of the TOTAL BID PRICE set forth on the Bid Form, OR
- (2) Certified Check in an amount not less than 5% of the TOTAL BID PRICE set forth on the Bid Form.

Performance and Payment Security: Required for contracts in the amount of \$1,000,000 or more. Performance Security and Payment Security shall each be in an amount equal to 100% of the Contract Price.

Agency Contact Person: Lorraine Holley  
Phone: 718-391-2601 FAX: 718-391-2627

(NO TEXT ON THIS PAGE)



LIST OF CONTRACT DRAWINGS		
<u>SHEET NO.</u>	<u>DWG. NO.</u>	<u>DESCRIPTION</u>
1	TTL	TITLE SHEET
2	TC1	LIST OF CONTRACT DRAWINGS AND STANDARD DRAWINGS
3	LAA	LEGEND AND ABBREVIATIONS
4	G1	GENERAL NOTES-1
5	G2	GENERAL NOTES-2
6	G3	NEW YORK CITY TRANSIT GENERAL NOTES
7 - 9	SC1 - SC3	SURVEY CONTROL
10	TRS1	TYPICAL ROADWAY SECTIONS AND DETAILS
11 - 13	R1 - R3	ROADWAY CONSTRUCTION PLANS
14 - 16	RP1 - RP3	ROADWAY CONSTRUCTION PROFILES
17 - 21	U1 - U5	UTILITY PLANS AND PROFILE
22 - 23	PM1 - PM2	PAVEMENT MARKING PLAN
24 - 26	TS1 - TS3	TRAFFIC SIGNAL PLANS
27	SL1	STREET LIGHTING PLANS
28	FDM1	FIRE DEPARTMENT MAPS
29 - 32	TM1 - TM4	TREE INVENTORY AND TREE IMPACT MITIGATION PLANS
33	TM5	TREE IMPACT MITIGATION DETAILS AND PLANTING PLAN
34 - 36	MPT1 - MPT3	MAINTENANCE AND PROTECTION OF TRAFFIC
37	TA1	NEW YORK CITY TRANSIT DUCTS
38 - 41	SB1 - SB4	SOIL BORING RECORD

## LIST OF STANDARD DRAWINGS

<b>Drawing No.</b>	<b>Drawing Description</b>	<b>Agency</b>
H-1003B	PEDESTRIAN CROSSWALKS – MALL TYPE B	NYCDOT
H-1010	STEEL FACED CURB/STEEL FACING TYPE D	NYCDOT
H-1011	SIDEWALK PEDESTRIAN RAMPS	NYCDOT
H-1012	TIMBER CURB	NYCDOT
H-1013	ILLUMINATED TIMBER BARRICADE	NYCDOT
H-1014	TEMPORARY PEDESTRIAN STEEL BARRICADE	NYCDOT
H-1015	STEEL FACED DROP CURB DRIVEWAYS	NYCDOT
H-1031	TYPICAL PAVEMENT KEY	NYCDOT
H-1034	TYPICAL CONSTRUCTION JOINTS FOR CONCRETE BASE FOR PAVEMENT	NYCDOT
H-1035	REINFORCED CONCRETE CURB & DROP CURB	NYCDOT
H-1040	TRANSVERSE CONSTRUCTION JOINT FOR CONCRETE BASE AND PAVEMENT	NYCDOT
H-1042 A	STANDARD TRENCH RESTORATION/LOCAL LAW #14	NYCDOT
H-1042 B	CONCRETE PAVEMENT RESTORATION	NYCDOT
H-1043	STEEL FACED CURB STEEL FACING TYPE D FOR STRUCTURES	
H-1044	CONCRETE CURB	NYCDOT
H-1045	CONCRETE SIDEWALK	NYCDOT
H-1046	STREET TREE PLANTING DETAIL – TYPE I	NYCDOT
H-1046A	PROTECTIVE TREE BARRIER	NYCDOT
H-1047	TYPICAL CURB DETAIL AT EXISTING TREES	NYCDOT
H-1049	PLASTIC BARREL ITEM 6.87	NYCDOT
H-1053	DETAILS FOR CONSTRUCTION AREA OF ADJUSTMENT AND TRANSITION SECTIONS	NYCDOT
H-1054	LIMITS OF MEASUREMENT FOR PAYMENT OF TEMPORARY ASPHALT PAVEMENT	NYCDOT
H-1055	PAVEMENT KEY TPE A, B-1, B-2, C	NYCDOT

<b>Drawing No.</b>	<b>Drawing Description</b>	<b>Agency</b>
H-1057	TEMPORARY STORAGE AREA	NYCDOT
MC-223	TYPICAL PAVEMENT STRIPING DIMENSIONS	NYCDOT
MG-472	WORD MESSAGE – “STOP”	NYCDOT
MG-480	TYPICAL CROSSWALK	NYCDOT
MS-1001	SIDEWALK PAYMENT LIMITS	NYCDOT
M608-3	SIDEWALK CURB DETAIL	NYCDOT
M608-5	DETECTABLE WARNING DETAIL	NYCDOT
TCW-1	TYPICAL PAVEMENT MARKINGS PEDESTRIAN CROSSWALKS AND STRIPING	NYCDOT
TBI-1	TYPICAL TREATMENTS FOR BICYCLE INTERSECTIONS MARKINGS	NYCDOT
TIN-1	TYPICAL PAVEMENT MARKINGS INSTALLATION	NYCDOT
TRF-2	PLANTED PEDESTRIAN ISLAND	NYCDOT
TSC-2	STRIPING & CROSS HATCHING	NYCDOT
TAR-1	TYPICAL PAVEMENT MARKING LANE ARROWS	NYCDOT
TWM-1	TYPICAL PAVEMENT MARKING WORD MESSAGES	NYCDOT
10241-A-Z	HYDRANT VALVE BOX, CAST IRON	NYCDEP
11576-A-Z	FOUNDATIONS FOR VALVE BOXES	NYCDEP
18583-Z	LARGE MANHOLE FRAME & COVER	NYCDEP
19841-Z-B	STANDARD METHODS FOR RECONSTRUCTING CATCH BASIN CONNECTIONS	NYCDEP
26438-Z-A	STANDARD SYMBOLS TO BE USED ON ALL PLANS AND MAPS	NYCDEP
31050-Z	STANDARD METHODS FOR HYDRANT DRAINAGE, 31050-Z SUPERSEDES 11522-Z	NYCDEP
42063-Y	SHALLOW CROSSING FOR WATER MAINS, 24” DIAMETER AND SMALLER	NYCDEP
44292-B-Z	GRAVEL OR BROKEN STONE BEDDING AND FILTER FABRIC, INSTALLATION FOR DUCTILE CAST IRON PIPES	NYCDEP
45161-A-Z	STANDARD STEEL HYDRANT FENDERS	NYCDEP
WM0401	PAVEMENT EXCAVATION LIMITS FOR PERMANENT RESTORATION IN STREETS NOT PROTECTED BY N.Y.C. ADM. CODE 19.144, WATER MAINS 20” AND LESS IN DIAMETER	NYCDEP

<b>Drawing No.</b>	<b>Drawing Description</b>	<b>Agency</b>
SE1	VITRIFIED CLAY PIPE ON CONCRETE CRADLE ON EARTH OR ON ROCK	NYCDEP
SE14	TYPE B-1 AND TYPE B-2 MANHOLES ON 8" DIAMETER TO 30" DIAMETER PIPE SEWERS IN WET LOCATION	
SE16	TYPE C-1 AND TYPE C-2 MANHOLES ON 36" DIAMETER TO 60" DIAMETER PIPE SEWERS	NYCDEP
SE24	DROP PIPE MANHOLE (TYPE 1) ON 10" DIAMETER TO 24" DIAMETER PIPE SEWERS	NYCDEP
SE47	TYPE 1 CATCH BASIN (WITH CURB PIECE)	NYCDEP
SE49	TYPE 3 CATCH BASIN (WITHOUT CURB PIECE)	NYCDEP
SE57	CAST IRON FRAME FOR CATCH BASINS (WITH CURB PIECE)	NYCDEP
SE59	CAST IRON GRATING, BACK PLATE, AND CURB PIECE FOR CATCH BASINS	NYCDEP
SE60	CAST IRON HOOD AND HOOKS FOR CATCH BASINS	NYCDEP
SE68	RECONSTRUCTION OF EXISTING MANHOLE AND REPLACEMENT OF EXISTING MANHOLE FRAME AND COVER	NYCDEP

BID SCHEDULE

NOTICE TO BIDDERS

Items listed in this Bid Schedule which have one (1) digit followed by a decimal (e.g. 4.02 CB), except for items beginning with the number "8.01", shall comply with the requirements of the corresponding numerical Sections of the NYCDOT Standard Highway Specifications, dated August 1, 2015, as amended by I-Pages, herein Volume 3 of 3.

Items listed in this Bid Schedule which have two (2) digits beginning with the number "5" or "6" or "7" followed by a decimal (e.g. 52.11D12, 60.11R608, 73.41AG) shall comply with the requirements of the New York City Department of Environmental Protection (NYCDEP) Standard Sewer and Water Main Specifications, dated July 1, 2014.

Items listed in this Bid Schedule beginning with the number "8.01" followed by a letter (e.g. 8.01 C2) shall comply with the requirements of the corresponding numerical Sections of the DDC Specifications for Handling, Transportation and Disposal of Nonhazardous and Potentially Hazardous Contaminated Materials contained in HAZ-Pages, herein Volume 3 of 3.

Item No. 637.9520 shall comply with the requirements of the corresponding numerical Section contained in I-Pages, herein Volume 3 of 3.

Items listed in this Bid Schedule beginning with the prefix "SL-" (e.g. SL-21.09.05) are Street Lighting Items, less the prefix, which shall be done in accordance with the requirements of Sub-Section 1.06.23.(D) and Section 1.06.49 in the NYCDOT Standard Highway Specifications.

Items listed in this Bid Schedule beginning with the prefix "T-" (e.g. T-3.21) are Traffic Items, less the prefix, which shall be done in accordance with the requirements of Sub-Section 1.06.23.(D) and Section 1.06.49 in the Standard Highway Specifications.

Items listed in this Bid Schedule beginning with the prefix "UTL-" (e.g. UTL-GCS-2WS) are for Gas Cost Sharing (EP-7) work and shall comply with the requirements of EP-7-Pages, herein Volume 3 of 3.

(NO TEXT ON THIS PAGE)

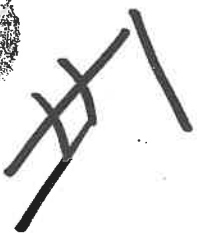

**BID FORM  
THE CITY OF NEW YORK  
DEPARTMENT OF DESIGN AND CONSTRUCTION  
DIVISION OF INFRASTRUCTURE**

**BID FOR FURNISHING ALL LABOR AND  
MATERIAL NECESSARY AND REQUIRED FOR:**

**PROJECT ID: SANDHW11**

**RECONSTRUCTION OF**

**BEACH CHANNEL DRIVE  
BETWEEN BEACH 116TH STREET AND BEACH 124TH STREET**

**INCLUDING SEWER, WATER MAIN, TRAFFIC SIGNAL  
AND STREET LIGHTING WORK**

**Together With All Work Incidental Thereto**

**BOROUGH OF QUEENS  
CITY OF NEW YORK**

Name of Bidder: NY Asphalt, Inc.

Date of Bid Opening: 3/22/17

Bidder is: (Check one, whichever applies) Individual ( ) Partnership ( ) Corporation

Place of Business of Bidder: 366 Industrial Loop, Staten Island, NY 10306

Bidder's Telephone Number: (718) 966-6466 Fax Number: (718) 966-6544

Bidder's E-Mail Address: jgiannetti@nyasphalt.com

Residence of Bidder (If Individual): \_\_\_\_\_

If Bidder is a Partnership, fill in the following blanks:

Names of Partners

Residence of Partners

\_\_\_\_\_

\_\_\_\_\_

\_\_\_\_\_

\_\_\_\_\_

If Bidder is a Corporation, fill in the following blanks:

Organized under the laws of the State of New York

Name and Home Address of President: Michael Thompson, President  
7 Bretwood Dr. No., Colts Neck, NJ 07722

Name and Home Address of Secretary: Amanda Glanz  
1400 Mountaintop Road, Bridgewater, NJ 08807

Name and Home Address of Treasurer: N/A

## BID FORM

The above-named Bidder affirms and declares:

1. The said bidder is of lawful age and the only one interested in this bid; and no person, firm or corporation other than hereinbefore named has any interest in this bid, or in the Contract proposed to be taken.
2. By submission of this bid, each bidder and each person signing on behalf of any bidder certifies, and in the case of a joint bid each party thereto certifies as to its own organization, under penalty of perjury, that to the best of its knowledge and belief: (1) the prices in this bid have been arrived at independently without collusion, consultation, communication or agreement, for the purpose of restricting competition, as to any matter relating to such prices with any other bidder or with any competitor; (2) unless otherwise required by law, the prices quoted in this bid have not been knowingly disclosed by the bidder and will not knowingly be disclosed by the bidder prior to opening, directly or indirectly, to any other bidder or to any competitor; and (3) No attempt has been made or will be made by the bidder to induce any other person, partnership or corporation to submit or not to submit a bid for the purpose of restricting competition.
3. No councilman or other officer or employee or person whose salary is payable in whole or in part from the City Treasury is directly or indirectly interested in this bid, or in the supplies, materials, equipment, work or labor to which it relates, or in any of the profits thereof.
4. The bidder is not in arrears to the City of New York upon debt or contract or taxes, and is not a defaulter, as surety or otherwise, upon any obligation of the City of New York, and has not been declared not responsible, or disqualified, by any agency of the City of New York or State of New York, nor is there any proceeding pending relating to the responsibility or qualification of the bidder to receive public contracts except as set forth on the Affirmation included as page C-6 of this Bid Booklet.

The bidder hereby affirms that it has paid all applicable City income, excise and other taxes for all years it has conducted business activities in New York City.

5. The bidder, as an individual, or as a member, partner, director or officer of the bidder, if the same be a firm, partnership or corporation, executes this document expressly warranting and representing that should this bid be accepted by the City and the Contract awarded to him, he and his subcontractors engaged in the performance: (1) will comply with the provisions of Section 6-108 of the Administrative Code of the City of New York and the non-discrimination provisions of Section 220a of the New York State Labor Law, as more expressly and in detail set forth in the Agreement; (2) will comply with Section 6-109 of the Administrative Code of the City of New York in relation to minimum wages and other stipulations as more expressly and in detail set forth in the Agreement; (3) have complied with the provisions of the aforesaid laws since their respective effective dates, and (4) will post notices to be furnished by the City, setting forth the requirements of the aforesaid laws in prominent and conspicuous places in each and every plant, factory, building and structure where employees engaged in the performance of the Contract can readily view it, and will continue to keep such notices posted until the supplies, materials and equipment, or work labor and services required to be furnished or rendered by the Contractor have been finally accepted by the City. In the event of any breach or violation of the foregoing, the Contractor may be subject to damages, liquidated or otherwise, cancellation of the Contract and suspension as a bidder for a period of three years. (The words, "the bidder", "he", "his", and "him" where used herein shall mean the individual bidder, firm, partnership or corporation executing this bid).



**AFFIRMATION**

**PROJECT ID. SANDHW11**

The undersigned bidder affirms and declares that said bidder is not in arrears to the City of New York upon debt, contract or taxes and is not a defaulter, as surety or otherwise, upon obligation to the City of New York, and has not been declared not responsible, or disqualified, by any agency of the City of New York, nor is there any proceeding pending relating to the responsibility or qualification of the bidder to receive public contracts except: None

(If none, the bidder shall insert the word "None" in the space provided above.)

Full Name of Bidder: NY Asphalt, Inc  
Address: 366 Industrial Loop  
City Staten Island State New York Zip Code 10309

CHECK ONE BOX AND INCLUDE APPROPRIATE NUMBER:

- A - Individual or Sole Proprietorship\*  
SOCIAL SECURITY NUMBER  
-----
- B - Partnership, Joint Venture or other unincorporated organization  
EMPLOYER IDENTIFICATION NUMBER  
-----
- C - Corporation  
EMPLOYER IDENTIFICATION NUMBER  
13-4110973

By: [Signature]  
Signature  
Title: President

If a corporation, place seal here

This affirmation must be signed by an officer or duly authorized representative.

\*Under the Federal Privacy Act the furnishing of Social Security Numbers by bidders on City contracts is voluntary. Failure to provide a Social Security Number will not result in a bidder's disqualification. Social Security Numbers will be used to identify bidders, proposers or vendors to ensure their compliance with laws, to assist the City in enforcement of laws, as well as to provide the City a means of identifying of businesses which seek City contracts.

Qualification Form

List previous projects completed to meet the special experience requirements for this contract. Please photocopy this form for submission of all required projects.

Name of Contractor: NY Asphalt, Inc.

Name of Project: SANDHAW 24

Location of Project: Far Rockaway

Owner or Owner's representative (Architect or Engineer) who is familiar with the work performed:

Name: John Zurrita

Title: G.I.C. Phone Number: (917) 292-7263

Brief description of the Project completed or the Project in progress: Reconstruction of 26 streets in Far Rockaway, all concrete work, excavation, utilities, milling + paving self performed

Was the Project performed as a prime, a subcontractor or a sub-subcontractor: Prime

Amount of Contract, Subcontract or Sub-subcontract: 11,300,000.00

Start Date and Completion Date: 8/1/15 - 12/21/16

\*\*\*\*\*

Name of Contractor: NY Asphalt, Inc.

Name of Project: PUSTA - 1

Location of Project: Corona Park - US Tennis Center perimeter road

Owner or Owner's representative (Architect or Engineer) who is familiar with the work performed:

Name: Harry Gordon

Title: EIC Phone Number: (917) 605-0999

Brief description of the Project completed or the Project in progress: Construction of perimeter road by pass. Excavation + disposal of 20,000 CY contaminated fill, new road construction and utilities.

Was the Project performed as a prime, a subcontractor or a sub-subcontractor: Prime

Amount of Contract, Subcontract or Sub-subcontract: 13,514,169.00

Start Date and Completion Date: 2/4/14 - 10/15/15

## BID SCHEDULE

- NOTE: (1) The Agency may reject a bid if it contains unbalanced bid prices. An unbalanced bid is considered to be one containing lump sum or unit items which do not reflect reasonable actual costs plus a reasonable proportionate share of the Bidder's anticipated profit, overhead costs, and other indirect costs, anticipated for the performance of the items in question.
- (2) The following bid prices on Unit Price Contracts are to be paid for the actual quantities of the item numbers in the completed work or structure, and they cover the cost of all work, labor, material, tools, plant and appliances of every description necessary to complete the entire work, as specified, and the removal of all debris, temporary work and appliances.
- (3) PLEASE BE SURE A LEGIBLE BID IS ENTERED, IN INK, FOR EACH ITEM.  
Alterations must be initialed in ink by the bidder.
- (4) The Extended Amount entered in Column 6 shall be the product of the Estimated Quantity in Column 3 times the Unit Price Bid in Column 5.
- (5) Prospective bidders must examine the Bid Schedule carefully and, before bidding, must advise the Commissioner, in writing, if any pages are missing, and must request that such missing pages be furnished them. The pages of this Bid Schedule are numbered consecutively, as follows:  
B - 3 Through B - 43

PLEASE BE SURE A LEGIBLE BID IS ENTERED FOR EACH ITEM.  
THE BIDDER SHALL INSERT THE TOTAL BID PRICE IN  
THE BID FORM ON PAGE C-4 OF THIS BID BOOKLET.

1/25/2017 11:57 AM

## BID SCHEDULE FORM

COL 1 SEQ. NO.	COL 2 ITEM NUMBER AND DESCRIPTION	COL 3 ENGINEER'S ESTIMATE OF QUANTITY	COL 4 UNIT	COL 5 UNIT PRICE (IN FIGURES) DOLLARS CENTS	COL 6 EXTENDED AMOUNT (IN FIGURES) DOLLARS CENTS
001	4.02 AB-R ASPHALTIC CONCRETE WEARING COURSE, 1-1/2" THICK	1,700.00	S.Y.	\$ 16.50	\$ 28,050.00
002	4.02 AG ASPHALTIC CONCRETE WEARING COURSE, 3" THICK	20,550.00	S.Y.	\$ 24.00	\$ 493,200.00
003	4.02 CB ASPHALTIC CONCRETE MIXTURE	1,453.00	TONS	\$ 200.00	\$ 290,600.00
004	4.04 H CONCRETE BASE FOR PAVEMENT, VARIABLE THICKNESS FOR TRENCH RESTORATION, (HIGH-EARLY STRENGTH)	1,300.00	C.Y.	\$ 70.50	\$ 91,650.00
005	4.04 HA CONCRETE BASE FOR PAVEMENT, 6" THICK (HIGH-EARLY STRENGTH)	410.00	C.Y.	286.50	\$ 117,465.00
006	4.04 HD CONCRETE BASE FOR PAVEMENT, 9" THICK (HIGH-EARLY STRENGTH)	4,400.00	C.Y.	286.50	\$ 1,260,600.00

**BID SCHEDULE FORM**

COL 1 SEQ NO	COL 2 ITEM NUMBER AND DESCRIPTION	COL 3 ENGINEERS ESTIMATE OF QUANTITY	COL 4 UNIT	COL 5 UNIT PRICE (IN FIGURES) DOLLARS	COL 6 EXTENDED AMOUNT (IN FIGURES) DOLLARS
007	4.08 AG CONCRETE CURB (24" DEEP)	500.00	L.F.	\$ 64.90	\$ 32,450.00
008	4.09 AF STRAIGHT STEEL FACED CONCRETE CURB (27" DEEP)	1,750.00	L.F.	\$ 80.30	\$ 140,525.00
009	4.09 BF DEPRESSED STEEL FACED CONCRETE CURB (27" DEEP)	100.00	L.F.	\$ 80.30	\$ 8,030.00
010	4.09 CF CORNER STEEL FACED CONCRETE CURB (27" DEEP)	100.00	L.F.	\$ 117.70	\$ 11,770.00
011	4.09 CGA INTEGRAL STRAIGHT STEEL FACED CONCRETE CURB AND GUTTER	5,350.00	L.F.	\$ 88.00	\$ 470,800.00
012	4.09 CGC INTEGRAL CORNER STEEL FACED CONCRETE CURB AND GUTTER	1,100.00	L.F.	\$ 129.80	\$ 142,780.00



1/25/2017 11:57 AM

## BID SCHEDULE FORM

COL 1 SEQ. NO.	COL 2 ITEM NUMBER and DESCRIPTION	COL 3 ENGINEERS ESTIMATE OF QUANTITY	COL 4 UNIT	COL 5 UNIT PRICE (IN FIGURES) DOLLARS C.I.S.	COL 6 EXTENDED AMOUNT (IN FIGURES) DOLLARS C.I.S.
013	4.09 CGD INTEGRAL DEPRESSED STEEL FACED CONCRETE CURB AND GUTTER	700.00	L.F.	\$ 95.70	\$ 66,990.00
014	4.11 CA FILL, PLACE MEASUREMENT	500.00	C.Y.	\$ 56.10	\$ 28,050.00
015	4.13 AAS 4" CONCRETE SIDEWALK (UNPIGMENTED)	50,000.00	S.F.	\$ 6.27	\$ 313,500.00
016	4.13 BAS 7" CONCRETE SIDEWALK (UNPIGMENTED)	11,000.00	S.F.	\$ 12.10	\$ 133,100.00
017	4.13 DE EMBEDDED PREFORMED DETECTABLE WARNING UNITS	350.00	S.F.	\$ 26.40	\$ 9,240.00
018	4.14 STEEL REINFORCEMENT BARS	1,000.00	LBS.	\$ 3.30	\$ 3,300.00



1/25/2017 11:57 AM

## BID SCHEDULE FORM

COL 1 SEQ. NO.	COL 2 ITEM NUMBER and DESCRIPTION	COL 3 ENGINEER'S ESTIMATE OF QUANTITY	COL 4 UNIT	COL 5 UNIT PRICE (IN FIGURES) DOLLARS (C/S)	COL 6 EXTENDED AMOUNT (IN FIGURES) DOLLARS (C/S)
019	4.14 W WELDED STEEL WIRE FABRIC	500.00	LBS.	\$ 3.30	<del>\$ 1,650.00</del> \$ 1,650.00
020	4.15 TOPSOIL	110.00	C.Y.	\$ 77.00	\$ 8,470.00
021	4.16 AA TREES REMOVED (4" TO UNDER 12" CALIPER)	6.00	EACH	\$ 302.50	\$ 1,815.00
022	4.16 AB TREES REMOVED (12" TO UNDER 18" CALIPER)	1.00	EACH	\$ 544.50	\$ 544.50
023	4.16 CA TREES PLANTED, 3" TO 3-1/2" CALIPER, ALL TYPES	40.00	EACH	\$ 988.90	\$ 39,556.00
024	4.16 STUMP STUMP REMOVAL	1.00	UNITS	\$ 220.00	\$ 220.00



1/25/2017 11:57 AM

NEW YORK CITY DEPARTMENT OF DESIGN AND CONSTRUCTION PROJECT ID: SANDHW11  
 DIVISION OF INFRASTRUCTURE - BUREAU OF DESIGN CONTRACT PIN: 8502017HW0001C

## BID SCHEDULE FORM

COL 1 SEQ. NO.	COL 2 ITEM NUMBER and DESCRIPTION	COL 3 ENGINEERS ESTIMATE OF QUANTITY	COL 4 UNIT	COL 5 UNIT PRICE (IN FIGURES) DOLLARS	COL 6 EXTENDED AMOUNT (IN FIGURES) DOLLARS
025	4.17 AA SHRUBS PLANTED, 15" TO 18" HIGH, ALL TYPES	20.00	EACH	\$ 86.90	\$ 1,738.00
026	4.17 PG1G PERENNIALS OR GROUNDCOVERS, PLANTED, 1 GALLON, ALL TYPES	110.00	EACH	\$ 31.90	\$ 3,509.00
027	4.18 A MAINTENANCE TREE PRUNING (UNDER 12" CAL.)	18.00	EACH	\$ 291.50	\$ 5,247.00
028	4.18 B MAINTENANCE TREE PRUNING (12" TO UNDER 18" CAL.)	3.00	EACH	\$ 401.50	\$ 1,204.50
029	4.18 C MAINTENANCE TREE PRUNING (18" TO UNDER 24" CAL.)	2.00	EACH	\$ 511.50	\$ 1,023.00
030	4.19 SODDING	200.00	S.Y.	\$ 21.00	\$ 4,200.00



**BID SCHEDULE FORM**

COL 1 SEQ. NO.	COL 2 ITEM NUMBER AND DESCRIPTION	COL 3 ENGINEER'S ESTIMATE OF QUANTITY	COL 4 UNIT	COL 5 UNIT PRICE (IN FIGURES) DOLLARS	COL 6 EXTENDED AMOUNT (IN FIGURES) DOLLARS
031	4.21 TREE CONSULTANT	400.00	P/HR	\$ 82.50	\$ 33,000.00
032	50.31SC10 10" E.S.V.P. SANITARY SEWER, ON CONCRETE CRADLE	250.00	L.F.	\$ 1,815.00	\$ 453,750.00
033	50.31SE10 10" E.S.V.P. SANITARY SEWER, ENCASED IN CONCRETE	100.00	L.F.	\$ 3,008.50	\$ 300,850.00
034	50.41M6E12 12" D.I.P. CLASS 56 STORM SEWER, ENCASED IN CONCRETE	275.00	L.F.	\$ 374.00	\$ 102,850.00
035	51.21S0B1000E STANDARD MANHOLE TYPE B-1 ON EXISTING SEWER	4.00	EACH	\$ 14,800.00	\$ 59,200.00
036	51.21S0B1000V STANDARD MANHOLE TYPE B-1	9.00	EACH	\$ 11,400.00	\$ 102,600.00



NEW YORK CITY DEPARTMENT OF DESIGN AND CONSTRUCTION  
 DIVISION OF INFRASTRUCTURE - BUREAU OF DESIGN

PROJECT ID: SANDHW11  
 CONTRACT PIN: 8502017HW0001C

1/25/2017 11:57 AM

## BID SCHEDULE FORM

4763,527.0

COL 1 SEQ. NO.	COL 2 ITEM NUMBER and DESCRIPTION	COL 3 ENGINEERS ESTIMATE QUANTITY	COL 4 UNIT	COL 5 UNIT PRICE (IN FIGURES) DOLLARS	COL 6 EXTENDED AMOUNT (IN FIGURES) DOLLARS	COL 7 CTS
037	51.21S0C1048E STANDARD MANHOLE, TYPE C-1 ON EXISTING 48" SEWER	2.00	EACH	<del>7650.00</del> \$ 22,000.00	\$ 44,000.00	00
038	51.23RF REPLACEMENT OF EXISTING MANHOLE FRAME AND COVER	5.00	EACH	\$ 1,650.00	\$ 8,250.00	00
039	51.31S00100V STANDARD DROP-PIPE MANHOLE TYPE I	1.00	EACH	\$ 26,000.00	\$ 26,000.00	00
040	51.41S001 STANDARD CATCH BASIN, TYPE 1	44.00	EACH	\$ 8,470.00	\$ 372,680.00	00
041	51.42S1S0 INCREMENTAL COST OF STANDARD CATCH BASIN TYPE 3 WITH CURB PIECE IN LIEU OF STANDARD CATCH BASIN TYPE 1	2.00	EACH	\$ 3,740.00	\$ 7,480.00	00
042	52.11D12 12" DUCTILE IRON PIPE BASIN CONNECTION	1,100.00	L.F.	\$ 192.50	\$ 211,750.00	00

**BID SCHEDULE FORM**

COL 1 SEQ. NO.	COL 2 ITEM NUMBER AND DESCRIPTION	COL 3 ENGINEERS ESTIMATE OF QUANTITY	COL 4 UNIT	COL 5 UNIT PRICE (IN FIGURES) DOLLARS CTS	COL 6 EXTENDED AMOUNT (IN FIGURES) DOLLARS CTS
043	52.31V06S10 6" E.S.V.P. SPUR FOR HOUSE CONNECTION ON 10" E.S.V.P. SANITARY SEWER	9.00	EACH	\$ 368.50	\$ 3,316.50
044	52.41V06R 6" E.S.V.P. HOUSE CONNECTION DRAIN ON CONCRETE CRADLE (RECONNECTION)	54.00	L.F.	\$ 176.00	\$ 9,504.00
045	53.11DR TELEVISION INSPECTION AND DIGITAL AUDIO-VISUAL RECORDING OF SEWERS	350.00	L.F.	\$ 16.50	\$ 5,775.00
046	55.11AB ABANDONING BASINS AND INLETS	32.00	EACH	\$ 1,320.00	\$ 42,240.00
047	6.02 AAN UNCLASSIFIED EXCAVATION	9,870.00	C.Y.	<del>\$ 100.00</del> \$ 90	<del>\$ 987,000.00</del> \$ 888,300
048	6.02 XHEC INCREMENTAL COST FOR MODIFYING WORK METHODS NEAR (WITHIN 3 FEET OF) TRANSIT FACILITIES AND BUILDING VAULTS	25.00	C.Y.	\$ 55.00	\$ 1,375.00



1/25/2017 11:57 AM

## BID SCHEDULE FORM

COL 1 SEQ. NO.	COL 2 ITEM NUMBER and DESCRIPTION	COL 3 ENGINEERS ESTIMATE OF QUANTITY	COL 4 UNIT	COL 5 UNIT PRICE (IN FIGURES) DOLLARS CENTS	COL 6 EXTENDED AMOUNT (IN FIGURES) DOLLARS CENTS
049	6.02 XSCW INCREMENTAL COST FOR USING SPECIAL CARE WORK METHODS NEAR (FROM 3 FEET TO 50 FEET) TRANSIT FACILITIES	300.00	C.Y.	\$ 55.00	\$ 16,500.00
050	6.03 AA STRIPPING PAVEMENT SURFACE (ASPHALTIC CONCRETE)	575.00	S.Y.	\$ 38.50	\$ 22,137.50
051	6.09 CONCRETE HEADER (6" WIDE X 15" DEEP)	250.00	L.F.	\$ 88.00	\$ 22,000.00
052	6.22 F ADDITIONAL HARDWARE	2,000.00	LBS.	\$ 7.70	\$ 15,400.00
053	6.25 RS TEMPORARY SIGNS	1,000.00	S.F.	\$ 8.80	\$ 8,800.00
054	6.26 TIMBER CURB	20,200.00	L.F.	\$ 2.50	\$ 50,500.00

## BID SCHEDULE FORM

COL 1 SEQ. NO.	COL 2 ITEM NUMBER and DESCRIPTION	COL 3 ENGINEER'S ESTIMATE OF QUANTITY	COL 4 UNIT	COL 5 UNIT PRICE (IN FIGURES) DOLLARS CTS	COL 6 EXTENDED AMOUNT (IN FIGURES) DOLLARS CTS
055	6.28 AA LIGHTED TIMBER BARRICADES	2,700.00	L.F.	\$ 4.75	\$ 12,825.00
056	6.34 ACT TEMPORARY CHAIN LINK FENCE, 6'-0" HIGH	500.00	L.F.	\$ 22.00	\$ 11,000.00
057	6.36 DR STRUCTURAL REPAIR AND ADJUSTMENT OF UTILITY STRUCTURES	50.00	C.Y.	\$ 330.00	\$ 16,500.00
058	6.40 D ENGINEER'S FIELD OFFICE (TYPE D)	30.00	MONTH	\$ 4,400.00	\$ 132,000.00
059	6.43 PHOTOGRAPHS	1,450.00	SETS	\$ 24.90	\$ 35,380.00
060	6.44 THERMOPLASTIC REFLECTORIZED PAVEMENT MARKINGS (4" WIDE)	20,000.00	L.F.	\$ 1.00	\$ 20,000.00

**BID SCHEDULE FORM**

COL 1 SEQ. NO.	COL 2 ITEM NUMBER AND DESCRIPTION	COL 3 ENGINEER'S ESTIMATE FOR QUANTITY	COL 4 UNIT	COL 5 UNIT PRICE (IN FIGURES) DOLLARS CTS	COL 6 EXTENDED AMOUNT (IN FIGURES) DOLLARS CTS
061	6.49 TEMPORARY PAVEMENT MARKINGS (4" WIDE)	5,550.00	L.F.	\$ 1.00	\$ 5,550.00
062	6.50 CLEANING OF DRAINAGE STRUCTURES	10.00	EACH	\$ 1320.00	\$ 13,200.00
063	6.52 FED UNIFORMED FLAGPERSON PRICE BID SHALL BE FOR THE FIXED SUM OF \$ 500,000.00	1.00	F.S.	500,000.00	\$500,000.00
064	6.53 REMOVE EXISTING LANE MARKINGS (4" WIDE)	5,550.00	L.F.	\$ 1.00	\$ 5,550.00
065	6.55 SAWCUTTING EXISTING PAVEMENT	1,000.00	L.F.	\$ 4.40	\$ 4,400.00

**BID SCHEDULE FORM**

7,374,690.00

COL 1 SEQ NO	COL 2 ITEM NUMBER AND DESCRIPTION	COL 3 ENGINEER'S ESTIMATE OF QUANTITY	COL 4 UNIT	COL 5 UNIT PRICE (IN FIGURES) DOLLARS	COL 6 EXTENDED AMOUNT (IN FIGURES) DOLLARS
066	6.67 SUBBASE COURSE, SELECT GRANULAR MATERIAL	3,350.00	C.Y.	\$ 59.00	\$ 197,650.00
067	6.68 PLASTIC FILTER FABRIC	35,000.00	S.Y.	\$ 0.75	\$ 26,250.00
068	6.82 A REMOVING EXISTING TRAFFIC AND STREET NAME SIGNS	750.00	S.F.	\$ 11.00	\$ 8,250.00
069	6.82 B REMOVING EXISTING TRAFFIC AND STREET NAME SIGN POSTS	840.00	L.F.	\$ 20.00	\$ 16,800.00
070	6.83 AA FURNISHING NEW NON-REFLECTORIZED TRAFFIC SIGNS	190.00	S.F.	\$ 20.00	\$ 3,800.00
071	6.83 AB FURNISHING NEW TRAFFIC SIGN POSTS	680.00	L.F.	\$ 20.00	\$ 13,600.00



1/25/2017 11:57 AM

## BID SCHEDULE FORM

COL 1 SEQ. NO.	COL 2 ITEM NUMBER and DESCRIPTION	COL 3 ENGINEERS ESTIMATE OF QUANTITY	COL 4 UNIT	COL 5 UNIT PRICE (IN FIGURES) DOLLARS CTS	COL 6 EXTENDED AMOUNT (IN FIGURES) DOLLARS CTS
072	6.83 AR FURNISHING NEW REFLECTORIZED TRAFFIC SIGNS	565.00	S.F.	\$ 22.00	\$ 12,430.00
073	6.83 BA INSTALLING TRAFFIC SIGNS	750.00	S.F.	\$ 22.00	\$ 16,500.00
074	6.83 BB INSTALLING TRAFFIC SIGN POSTS	680.00	L.F.	\$ 20.00	\$ 13,600.00
075	6.86 AA FURNISHING NEW STREET NAME SIGNS	200.00	S.F.	\$ 58.50	\$ 11,700.00
076	6.86 AB FURNISHING NEW STREET NAME SIGN POSTS	340.00	L.F.	\$ 20.00	\$ 6,800.00
077	6.86 BA INSTALLING STREET NAME SIGNS	200.00	S.F.	\$ 58.50	\$ 11,700.00



**BID SCHEDULE FORM**

COL 1 SEC. NO.	COL 2 ITEM NUMBER and DESCRIPTION	COL 3 ENGINEERS ESTIMATE OF QUANTITY	COL 4 UNIT	COL 5 UNIT PRICE (IN FIGURES) DOLLARS	COL 6 EXTENDED AMOUNT (IN FIGURES) DOLLARS	CFS
078	6.86 BB INSTALLING STREET NAME SIGN POSTS	340.00	L.F.	\$ 20.00	\$ 6,800.00	
079	6.87 PLASTIC BARRELS	2,750.00	EACH	\$ 11.00	\$ 30,250.00	
080	6.91 REFLECTIVE CRACKING MEMBRANE (18" WIDE)	12,000.00	L.F.	\$ 3.00	\$ 36,000.00	
081	6.99 AUDIO AND VIDEO DOCUMENTATION SURVEY	1.00	L.S.	\$ 8,000.00	\$ 8,000.00	
082	60.11R520 FURNISHING AND DELIVERING 20-INCH DUCTILE IRON RESTRAINED JOINT PIPE (CLASS 55)	3,150.00	L.F.	\$ 178.00	\$ 560,700.00	
083	60.11R524 FURNISHING AND DELIVERING 24-INCH DUCTILE IRON RESTRAINED JOINT PIPE (CLASS 55)	25.00	L.F.	\$ 250.00	\$ 6,250.00	



1/25/2017 11:57 AM

# BID SCHEDULE FORM

8,338,120 ↑

COL 1 SEQ. NO.	COL 2 ITEM NUMBER AND DESCRIPTION	COL 3 ENGINEER'S ESTIMATE OF QUANTITY	COL 4 UNIT	COL 5 UNIT PRICE (IN FIGURES) DOLLARS CENTS	COL 6 EXTENDED AMOUNT (IN FIGURES) DOLLARS CENTS
084	60.11R606 FURNISHING AND DELIVERING 6-INCH DUCTILE IRON RESTRAINED JOINT PIPE (CLASS 56)	250.00	L.F.	\$ 42.00	\$ 10,500.00
085	60.11R608 FURNISHING AND DELIVERING 8-INCH DUCTILE IRON RESTRAINED JOINT PIPE (CLASS 56)	400.00	L.F.	\$ 56.50	\$ 22,600.00
086	60.11R612 FURNISHING AND DELIVERING 12-INCH DUCTILE IRON RESTRAINED JOINT PIPE (CLASS 56)	3,175.00	L.F.	\$ 91.00	\$ 288,925.00
087	60.12D06 LAYING 6-INCH DUCTILE IRON PIPE AND FITTINGS	275.00	L.F.	\$ 110.00	\$ 30,250.00
088	60.12D08 LAYING 8-INCH DUCTILE IRON PIPE AND FITTINGS	450.00	L.F.	\$ 132.00	\$ 59,400.00
089	60.12D12 LAYING 12-INCH DUCTILE IRON PIPE AND FITTINGS	3,540.00	L.F.	\$ 174.00	\$ 615,960.00

**BID SCHEDULE FORM**

GOL-1 SEQ. NO.	GOL-2 ITEM NUMBER and DESCRIPTION	GOL-3 ENGINEER'S ESTIMATE OF QUANTITY	GOL-4 UNIT	GOL-5 UNIT PRICE (IN FIGURES) DOLLARS CENTS	GOL-6 EXTENDED AMOUNT (IN FIGURES) DOLLARS CENTS
090	60.12D20 LAYING 20-INCH DUCTILE IRON PIPE AND FITTINGS	3,500.00	L.F.	\$ 169.00	\$ 591,500.00
091	60.12D24 LAYING 24-INCH DUCTILE IRON PIPE AND FITTINGS	30.00	L.F.	\$ 443.30	\$ 13,299.00
092	60.13M0A24 FURNISHING AND DELIVERING DUCTILE IRON MECHANICAL JOINT 24-INCH DIAMETER AND SMALLER FITTINGS, INCLUDING WEDGE TYPE RETAINER GLANDS	25.00	TONS	\$ 10,000.00	\$ 250,000.00
093	60.18BJC20EL FURNISHING, DELIVERING AND INSTALLING BELL JOINT CLAMPS, COMPLETE FOR 20-INCH PIPE AND LESS	10.00	EACH	\$ 500.00	\$ 5,000.00
094	61.11DMM06 FURNISHING AND DELIVERING 6-INCH MECHANICAL JOINT DUCTILE IRON GATE VALVE COMPLETE WITH WEDGE TYPE RETAINER GLANDS	22.00	EACH	\$ 1,115.00	\$ 24,530.00

**BID SCHEDULE FORM**

COL 1 SEQ. NO.	COL 2 ITEM NUMBER and DESCRIPTION	COL 3 ENGINEER'S ESTIMATE OF QUANTITY	COL 4 UNIT	COL 5 UNIT PRICE (IN FIGURES) DOLLARS CENTS	COL 6 EXTENDED AMOUNT (IN FIGURES) DOLLARS CENTS
095	61.11DMM08 FURNISHING AND DELIVERING 8-INCH MECHANICAL JOINT DUCTILE IRON GATE VALVE COMPLETE WITH WEDGE TYPE RETAINER GLANDS	4.00	EACH	\$ 1,723.00	\$ 6,892.00
096	61.11DMM12 FURNISHING AND DELIVERING 12-INCH MECHANICAL JOINT DUCTILE IRON GATE VALVE COMPLETE WITH WEDGE TYPE RETAINER GLANDS	12.00	EACH	\$ 3,429.00	\$ 41,148.00
097	61.11DMM20 FURNISHING AND DELIVERING 20-INCH MECHANICAL JOINT DUCTILE IRON GATE VALVE COMPLETE WITH WEDGE TYPE RETAINER. GLANDS	9.00	EACH	\$ 18,384.00	\$ 165,456.00
098	61.11TWC03 FURNISHING AND DELIVERING 3-INCH WET CONNECTION TAPPING VALVE COMPLETE WITH WEDGE TYPE RETAINER GLANDS	3.00	EACH	\$ 1,000.00	\$ 3,000.00
099	61.11TWC04 FURNISHING AND DELIVERING 4-INCH WET CONNECTION TAPPING VALVE COMPLETE WITH WEDGE TYPE RETAINER GLANDS	3.00	EACH	\$ 1,000.00	\$ 3,000.00

**BID SCHEDULE FORM**

COL 1 SEQ NO.	COL 2 ITEM NUMBER AND DESCRIPTION	COL 3 ENGINEER'S ESTIMATE OF QUANTITY	COL 4 UNIT	COL 5 UNIT PRICE (IN FIGURES) DOLLARS CENTS	COL 6 EXTENDED AMOUNT (IN FIGURES) DOLLARS CENTS
100	61.11TWC06 FURNISHING AND DELIVERING 6-INCH WET CONNECTION TAPPING VALVE COMPLETE WITH WEDGE TYPE RETAINER GLANDS	1.00	EACH	\$ 1,280.00	\$ 1,280.00
101	61.12DMM06 SETTING 6-INCH MECHANICAL JOINT DUCTILE IRON GATE VALVE COMPLETE WITH WEDGE TYPE RETAINER GLANDS	22.00	EACH	\$ 110.00	\$ 2,420.00
102	61.12DMM08 SETTING 8-INCH MECHANICAL JOINT DUCTILE IRON GATE VALVE COMPLETE WITH WEDGE TYPE RETAINER GLANDS	4.00	EACH	\$ 110.00	\$ 440.00
103	61.12DMM12 SETTING 12-INCH MECHANICAL JOINT DUCTILE IRON GATE VALVE COMPLETE WITH WEDGE TYPE RETAINER GLANDS	12.00	EACH	\$ 880.00	\$ 10,560.00
104	61.12DMM20 SETTING 20-INCH MECHANICAL JOINT DUCTILE IRON GATE VALVE COMPLETE WITH WEDGE TYPE RETAINER GLANDS	9.00	EACH	\$ 1,100.00	\$ 9,900.00
105	61.12TWC03 SETTING 3-INCH WET CONNECTION TAPPING VALVE COMPLETE WITH WEDGE TYPE RETAINER GLANDS	3.00	EACH	\$ 110.00	\$ 330.00



1/25/2017 11:57 AM

## BID SCHEDULE FORM

COL 1 SEQ. NO.	COL 2 ITEM NUMBER AND DESCRIPTION	COL 3 ENGINEER'S ESTIMATE OF QUANTITY	COL 4 UNIT	COL 5 UNIT PRICE (IN FIGURES) DOLLARS CTS	COL 6 EXTENDED AMOUNT (IN FIGURES) DOLLARS CTS
106	61.12TWC04. SETTING 4-INCH WET CONNECTION TAPPING VALVE COMPLETE WITH WEDGE TYPE RETAINER GLANDS	3.00	EACH	\$ 110.00	\$ 330.00
107	61.12TWC06 SETTING 6-INCH WET CONNECTION TAPPING VALVE COMPLETE WITH WEDGE TYPE RETAINER GLANDS	1.00	EACH	\$ 110.00	\$ 110.00
108	62.11SD FURNISHING AND DELIVERING HYDRANTS	22.00	EACH	\$ 3,200.00	\$ 70,400.00
109	62.12SG SETTING HYDRANTS COMPLETE WITH WEDGE TYPE RETAINER GLANDS	22.00	EACH	\$ 2,420.00	\$ 53,240.00
110	62.13RH REMOVING HYDRANTS	17.00	EACH	\$ 2,420.00	\$ 41,140.00
111	62.14FS FURNISHING, DELIVERING AND INSTALLING HYDRANT FENDERS	44.00	EACH	\$ 471.00	\$ 20,724.00

**BID SCHEDULE FORM**

COL 1 SEQ. NO.	COL 2 ITEM NUMBER AND DESCRIPTION	COL 3 ENGINEERS ESTIMATE OF QUANTITY	COL 4 UNIT	COL 5 UNIT PRICE (IN FIGURES) DOLLARS CTS	COL 6 EXTENDED AMOUNT (IN FIGURES) DOLLARS CTS
112	63.11VC FURNISHING AND DELIVERING VARIOUS CASTINGS	40.00	TONS	\$ 5,000.00	\$ 200,000.00
113	637.9520 FIELD INFORMATION MANAGEMENT SYSTEM PRICE BID SHALL BE FOR THE FIXED SUM OF \$ 50,000.00	1.00	F.S.	50,000.00	\$50,000.00
114	64.11EL WITHDRAWING AND REPLACING HOUSE SERVICES USING 1-1/2- INCH OR LARGER SCREW TAPS	10.00	EACH	\$ 550.00	\$ 5,500.00
115	64.11ST WITHDRAWING AND REPLACING HOUSE SERVICES USING SMALLER THAN 1-1/2-INCH SCREW TAPS	67.00	EACH	\$ 495.00	\$ 33,165.00
116	64.12COEG CUTTING AND OFFSETTING HOUSE SERVICE WATER CONNECTIONS (EQUAL TO OR GREATER THAN 3-INCH DIAMETER)	30.00	L.F.	\$ 82.50	2,475.00



Department of  
Design and  
Construction

NEW YORK CITY DEPARTMENT OF DESIGN AND CONSTRUCTION PROJECT ID: SANDHW11  
DIVISION OF INFRASTRUCTURE - BUREAU OF DESIGN CONTRACT PIN: 8502017HW0001C

1/25/2017 11:57 AM

## BID SCHEDULE FORM

COL 1 SEQ. NO.	COL 2 ITEM NUMBER AND DESCRIPTION	COL 3 ENGINEERS ESTIMATE OF QUANTITY	COL 4 UNIT	COL 5 UNIT PRICE (IN FIGURES) DOLLARS CTS	COL 6 EXTENDED AMOUNT (IN FIGURES) DOLLARS CTS
117	64.12COLT CUTTING AND OFFSETTING HOUSE SERVICE WATER CONNECTIONS (LESS THAN 3-INCH DIAMETER)	100.00	L.F.	\$ 82.50	\$ 8,250.00
118	64.12ESEG EXTENDING HOUSE SERVICE WATER CONNECTIONS (EQUAL TO OR GREATER THAN 3-INCH DIAMETER)	220.00	L.F.	\$ 82.50	\$ 18,150.00
119	64.12ESLT EXTENDING HOUSE SERVICE WATER CONNECTIONS (LESS THAN 3- INCH DIAMETER)	90.00	L.F.	\$ 71.50	\$ 6,435.00
120	64.13WC08 FURNISHING, DELIVERING AND INSTALLING WET CONNECTION SLEEVE ON 8-INCH WATER MAIN PIPE WITH VARIOUS OUTLETS	1.00	EACH	\$ 9,900.00	\$ 9,900.00
121	64.13WC12 FURNISHING, DELIVERING AND INSTALLING WET CONNECTION SLEEVE ON 12-INCH WATER MAIN PIPE WITH VARIOUS OUTLETS	3.00	EACH	\$ 11,000.00	\$ 33,000.00
122	64.13WC20 FURNISHING, DELIVERING AND INSTALLING WET CONNECTION SLEEVE ON 20-INCH WATER MAIN PIPE WITH VARIOUS OUTLETS	3.00	EACH	\$ 13,200.00	\$ 39,600.00



## BID SCHEDULE FORM

COL 1 SEQ. NO.	COL 2 ITEM NUMBER and DESCRIPTION	COL 3 ENGINEERS ESTIMATE OF QUANTITY	COL 4 UNIT	COL 5 UNIT PRICE (IN FIGURES) DOLLARS & CENTS	COL 6 EXTENDED AMOUNT (IN FIGURES) DOLLARS & CENTS
123	65.11BR FURNISHING, DELIVERING AND INSTALLING BANDS, RODS, WASHERS, ETC., COMPLETE, FOR RESTRAINING JOINTS	450.00	LBS.	\$ 5.00	\$ 2,250.00
124	65.21PS FURNISHING AND PLACING POLYETHYLENE SLEEVE Unit price bid shall not be less than: \$ 0.50	7,500.00	L.F.	\$ 0.50	\$ 3,750.00
125	65.31FF FURNISHING, DELIVERING AND PLACING FILTER FABRIC Unit price bid shall not be less than: \$ 0.10	215,000.00	S.F.	\$ 0.10	\$ 21,500.00
126	65.71SG FURNISHING, DELIVERING AND PLACING SCREENED GRAVEL OR SCREENED BROKEN STONE BEDDING	1,000.00	C.Y.	\$ 38.50	\$ 38,500.00
127	7.13 B MAINTENANCE OF SITE Unit price bid shall not be less than: \$ 9,600.00	24.00	MONTH	\$ 9,600.00	\$ 230,400.00
128	7.36 PEDESTRIAN STEEL BARRICADES	27,700.00	L.F.	\$ 0.35	\$ 9,695.00



Department of  
Design and  
Construction

NEW YORK CITY DEPARTMENT OF DESIGN AND CONSTRUCTION PROJECT ID: SANDHW11  
DIVISION OF INFRASTRUCTURE - BUREAU OF DESIGN CONTRACT PIN: 8502017HW00001C

1/25/2017 11:57 AM

## BID SCHEDULE FORM

COL. 1 SEQ. NO.	COL. 2 ITEM NUMBER AND DESCRIPTION	COL. 3 ENGINEERS ESTIMATE QTY OF QUANTITY	COL. 4 UNIT	COL. 5 UNIT PRICE (IN FIGURES) DOLLARS CTS	COL. 6 EXTENDED AMOUNT (IN FIGURES) DOLLARS CTS
129	7.88 AA RODENT INFESTATION SURVEY AND MONITORING Unit price bid shall not be less than: \$ 9,000.00	1.00	L.S.	\$ 9,000.00	\$ 9,000.00
130	7.88 AB RODENT BAIT STATIONS Unit price bid shall not be less than: \$ 72.00	1,258.00	EACH	\$ 72.00	\$ 90,576.00
131	7.88 AC BATING OF RODENT BAIT STATIONS Unit price bid shall not be less than: \$ 11.40	1,258.00	EACH	\$ 11.40	\$ 14,341.20
132	7.88 AD WATERBUG BAIT APPLICATIONS Unit price bid shall not be less than: \$ 78.00	476.00	BLOCK	\$ 78.00	\$ 37,128.00
133	70.31FN FENCING. Unit price bid shall not be less than: \$ 2.00	14,700.00	L.F.	\$ 2.00	\$ 29,400.00
134	70.51EO EXCAVATION OF BOULDERS IN OPEN CUT Unit price bid shall not be less than: \$ 75.00	20.00	C.Y.	\$ 75.00	\$ 1,500.00

**BID SCHEDULE FORM**

COL. 1 SEQ. NO.	COL. 2 ITEM NUMBER AND DESCRIPTION	COL. 3 ENGINEERS ESTIMATE OF QUANTITY	COL. 4 UNIT	COL. 5 UNIT PRICE (IN FIGURES) DOLLARS CTS.	COL. 6 EXTENDED AMOUNT (IN FIGURES) DOLLARS CTS.
135	70.61RE ROCK EXCAVATION	10.00	C.Y.	\$ 100.00	\$ 1,000.00
136	70.71SB STONE BALLAST Unit price bid shall not be less than: \$ 15.00	20.00	C.Y.	\$ 47.00	\$ 940.00
137	70.81CB CLEAN BACKFILL Unit price bid shall not be less than: \$ 15.00	2,650.00	C.Y.	\$ 35.00	\$ 92,750.00
138	70.91SW12 FURNISHING AND PLACING SHEETING AND BRACING IN TRENCH FOR WATER MAIN PIPE 12-INCH IN DIAMETER AND LESS	4,600.00	S.F.	\$ 1.00	\$ 4,600.00
139	70.91SW20 FURNISHING AND PLACING SHEETING AND BRACING IN TRENCH FOR WATER MAIN PIPE 20-INCH IN DIAMETER	40,000.00	S.F.	\$ 1.00	\$ 40,000.00
140	72.11HF HYDRAULIC FILL FOR ABANDONED SEWERS AND WATER MAINS	50.00	C.Y.	\$ 190.00	\$ 9,500.00

**BID SCHEDULE FORM**

COL. 1 SEQ. NO.	COL. 2 ITEM NUMBER and DESCRIPTION	COL. 3 ENGINEERS ESTIMATE OF QUANTITY	COL. 4 UNIT	COL. 5 UNIT PRICE (IN FIGURES) DOLLARS CTS	COL. 6 EXTENDED AMOUNT (IN FIGURES) DOLLARS CTS
141	73.11AB ADDITIONAL BRICK MASONRY Unit price bid shall not be less than: \$ 62.50	30.00	C.Y.	\$ 68.75	\$ 2,062.50
142	73.21AC ADDITIONAL CONCRETE Unit price bid shall not be less than: \$ 62.50	30.00	C.Y.	\$ 190.00	\$ 5,700.00
143	73.31AE0 ADDITIONAL EARTH EXCAVATION INCLUDING TEST PITS (ALL DEPTHS) Unit price bid shall not be less than: \$ 20.00	140.00	C.Y.	\$ 110.00	\$ 15,400.00
144	73.41AG ADDITIONAL SELECT GRANULAR BACKFILL Unit price bid shall not be less than: \$ 15.00	110.00	C.Y.	\$ 55.00	\$ 6,050.00
145	73.51AS ADDITIONAL STEEL REINFORCING BARS Unit price bid shall not be less than: \$ 1.00	500.00	LBS.	\$ 1.10	\$ 550.00
146	75.11RT REMOVAL OF ABANDONED TRACKS	500.00	L.F.	\$ 110.00	\$ 55,000.00

**BID SCHEDULE FORM**

COL 1 SEQ. NO.	COL 2 ITEM NUMBER and DESCRIPTION	COL 3 ENGINEERS ESTIMATE OF QUANTITY	COL 4 UNIT	COL 5 UNIT PRICE (IN FIGURES) DOLLARS	COL 6 EXTENDED AMOUNT (IN FIGURES) DOLLARS
147	8.01 C1 HANDLING, TRANSPORTING AND DISPOSAL OF NON-HAZARDOUS CONTAMINATED SOIL	4,000.00	TONS	\$ 61.60	\$ 246,400.00
148	8.01 C2 SAMPLING AND TESTING OF CONTAMINATED/POTENTIALLY HAZARDOUS SOIL FOR DISPOSAL PURPOSES	10.00	SETS	\$ 2,871.00	\$ 28,710.00
149	8.01 H HANDLING, TRANSPORTING AND DISPOSAL OF HAZARDOUS SOIL	200.00	TONS	\$ 201.30	\$ 40,260.00
150	8.01 S HEALTH AND SAFETY	1.00	L.S.	\$ 4,466.00	\$ 4,466.00
151	8.01 W1 REMOVAL, TREATMENT, AND DISCHARGE/DISPOSAL OF CONTAMINATED WATER	21.00	DAY	\$ 2,420.00	\$ 50,820.00
152	8.01 W2 SAMPLING AND TESTING OF CONTAMINATED WATER	5.00	SETS	\$ 610.00	\$ 3,050.00



1/25/2017 11:57 AM

## BID SCHEDULE FORM

COL 1 SEQ. NO.	COL 2 ITEM NUMBER AND DESCRIPTION	COL 3 ENGINEER'S ESTIMATE OF QUANTITY	COL 4 UNIT	COL 5 UNIT PRICE (IN FIGURES) DOLLARS CTS	COL 6 EXTENDED AMOUNT (IN FIGURES) DOLLARS CTS
153	8.02 A SPECIAL CARE EXCAVATION AND RESTORATION FOR SIDEWALK WORK	7,500.00	S.F.	\$ 7.00	\$ 52,500.00
154	8.02 B SPECIAL CARE EXCAVATION AND RESTORATION FOR CURB WORK	1,000.00	L.F.	\$ 19.00	\$ 19,000.00
155	8.32 BARK CHIP MULCH	200.00	S.Y.	\$ 14.00	\$ 2,800.00
156	9.04 HW ALLOWANCE FOR ANTI-FREEZE ADDITIVE IN CONCRETE PRICE BID SHALL BE FOR THE FIXED SUM OF \$ 50,000.00	1.00	F.S.	50,000 00	\$50,000 00
157	HW-900H ALLOWANCE FOR CITY WORK ACCELERATION PRICE BID SHALL BE FOR THE FIXED SUM OF \$ 300,000.00	1.00	F.S.	300,000 00	\$300,000 00



1/25/2017 11:57 AM

## BID SCHEDULE FORM

COL 1 SEQ. NO.	COL 2 ITEM NUMBER AND DESCRIPTION	COL 3 ENGINEER'S ESTIMATE OF QUANTITY	COL 4 UNIT	COL 5 UNIT PRICE (IN FIGURES) DOLLARS CENTS	COL 6 EXTENDED AMOUNT (IN FIGURES) DOLLARS CENTS
158	HW-908 ALLOWANCE FOR EXTRA WORK DUE TO ARCHAEOLOGICAL DISCOVERIES PRICE BID SHALL BE FOR THE FIXED SUM OF \$ 100,000.00	1.00	F.S.	100,000 00	\$ 100,000 00
159	SL-20.06.01 RESET LAMPPOST WITH FOUNDATION WHERE GRADE IS RAISED NOT EXCEEDING EIGHT (8") INCHES.	1.00	EACH	\$ 5,500 00	\$ 5,500. 00
160	SL-21.03.01 INSTALL TYPE FABRICATED STEEL LAMPPOST WITH VARIOUS SIZE ARM(S) WITH TRANSFORMER BASE	1.00	EACH	\$ 1,122 00	\$ 1,122. 00
161	SL-21.09.05 REMOVE STANDARD FABRICATED STEEL, SPUN ALUMINUM NO. 10, ETC. WITH ARM(S), LUMINAIRE(S), CONTROL(S) WITH ALL ATTACHMENTS, IF ANY.	1.00	EACH	\$ 902. 00	\$ 902. 00
162	SL-33.01.02 FURNISH AND INSTALL NO. 6 AWG XLP COPPER CABLE OR EQUAL IN CONDUIT	400.00	L.F.	\$ 39. 00	\$ 15,600 00

**BID SCHEDULE FORM**

COL 1 SEQ. NO.	COL 2 ITEM NUMBER AND DESCRIPTION	COL 3 ENGINEERS ESTIMATE OF QUANTITY	COL 4 UNIT	COL 5 UNIT PRICE (IN FIGURES) DOLLARS CTS	COL 6 EXTENDED AMOUNT (IN FIGURES) DOLLARS CTS
163	SL-33.01.03 FURNISH AND INSTALL NO. 2 AWG XLP COPPER CABLE OR EQUAL IN CONDUIT	2,400.00	L.F.	\$ 42.00	\$ 100,800.00
164	SL-33.03.01 FURNISH AND INSTALL #6 BARE COPPER CONDUCTOR IN CONDUIT OR OVERHEAD.	800.00	L.F.	\$ 39.00	\$ 31,200.00
165	SL-35.03.03 FURNISH AND INSTALL 1-1/2" HOT DIPPED GALVANIZED STEEL CONDUIT IN UNPAVED AREA	400.00	L.F.	\$ 68.00	\$ 27,200.00
166	SL-35.03.04 FURNISH AND INSTALL 2" HOT DIPPED GALVANIZED STEEL CONDUIT IN UNPAVED AREA	800.00	L.F.	\$ 70.50	\$ 56,400.00
167	SL-37.05.13 REMOVE EXISTING FRAME AND COVER FROM CONCRETE BOX, BACKFILL AND THOROUGHLY TAMP THE EARTH, RESTORE SURFACE TO SURROUNDING CONDITIONS.	1.00	EACH	\$ 4,050.00	\$ 4,050.00
168	SL-37.07.03 RAISE ROADWAY TYPE CONCRETE BOX TO GRADE.	1.00	EACH	\$ 3,212.00	\$ 3,212.00



**BID SCHEDULE FORM**

COL 1 SEQ NO	COL 2 ITEM NUMBER AND DESCRIPTION	COL 3 ENGINEERS ESTIMATE OF QUANTITY	COL 4 UNIT	COL 5 UNIT PRICE (IN FIGURES) DOLLARS CENTS	COL 6 EXTENDED AMOUNT (IN FIGURES) DOLLARS CENTS
169	T-1.18 REMOVE TYPE "A", "B", "S" OR "T" SERIES FOUNDATION	1.00	EACH	\$ 2,750.00	\$ 2,750.00
170	T-1.20 REMOVE TYPE "M" SERIES FOUNDATION	2.00	EACH	\$ 2,750.00	\$ 5,500.00
171	T-1.29 RAISE OR LOWER FOUNDATION TO GRADE	2.00	EACH	\$ 4,345.00	\$ 8,690.00
172	T-1.36 INSTALL ONE COASTAL STORM FND FOR S1A POLE	1.00	EACH	\$ 1,575.00	\$ 1,575.00
173	T-1.38 INSTL ONE COASTAL STORM FND FOR S-14A POLE	1.00	EACH	\$ 1,575.00	\$ 1,575.00
174	T-1.39 INSTL ONE COASTAL STORM FND FOR M2-A POLE	2.00	EACH	\$ 1,840.00	\$ 3,680.00



Department of Design and Construction

NEW YORK CITY DEPARTMENT OF DESIGN AND CONSTRUCTION PROJECT ID: SANDHW11  
DIVISION OF INFRASTRUCTURE - BUREAU OF DESIGN CONTRACT PIN: 8502017HW0001C

1/25/2017 11:57 AM

# BID SCHEDULE FORM

COL 1 SEQ. NO.	COL 2 MEMBER AND DESCRIPTION	COL 3 ENGINEERS ESTIMATE OF QUANTITY	COL 4 UNIT	COL 5 UNIT PRICE (IN FIGURES) DOLLARS CTS	COL 6 EXTENDED AMOUNT (IN FIGURES) DOLLARS CTS
175	T-2.1 INSTALL TYPE "S-1" OR "T-1" SERIES POST	1.00	EACH	\$ 517.00	\$ 517.00
176	T-2.2 INSTALL TYPE "S-14" POST	1.00	EACH	\$ 517.00	\$ 517.00
177	T-2.22 REMOVE TYPE "S-1" OR "T-1" SERIES POST	1.00	EACH	\$ 462.00	\$ 462.00
178	T-2.24 REMOVE TYPE "M" SERIES POST	2.00	EACH	\$ 1,034.00	\$ 2,068.00
179	T-2.4 INSTALL TYPE "M-2" POST	2.00	EACH	\$ 2,575.00	\$ 5,150.00
180	T-20000 FURNISH TEN FOOT ALUMINUM SIGNAL POST TYPE "S-1"	1.00	EACH	\$ 1,122.00	\$ 1,122.00

## BID SCHEDULE FORM

COL 1 SEQ. NO.	COL 2 ITEM NUMBER AND DESCRIPTION	COL 3 ENGINEER'S ESTIMATE OF QUANTITY	COL 4 UNIT	COL 5 UNIT PRICE (IN FIGURES) DOLLARS CTS.	COL 6 EXTENDED AMOUNT (IN FIGURES) DOLLARS CTS.
181	T-20020 a) FURNISH 3/4" ANCHOR BOLT ASSEMBLIES FOR S-1 (EACH) (3 REQUIRED PER POST)	3.00	EACH	\$ 55.00	\$ 165.00
182	T-20021 b) FURNISH 1" ANCHOR BOLT ASSEMBLIES FOR F-1 (EACH) (4 REQUIRED PER POST)	4.00	EACH	\$ 77.00	\$ 308.00
183	T-20160 FURNISH 20 FOOT SIGNAL MAST ARM POLE ASSEMBLY TYPE "M-2"	2.00	EACH	\$ 6,900.00	\$ 13,800.00
184	T-20184 a) FURNISH 5' EXTENSION ARM ASSEMBLY WITH FITTINGS	2.00	EACH	\$ 550.00	\$ 1,100.00
185	T-20220 c) FURNISH 1-1/4" ANCHOR BOLT ASSEMBLIES FOR M-2 (EACH) (4 REQUIRED PER POST)	8.00	EACH	\$ 121.00	\$ 968.00
186	T-20640 FURNISH ALUMINUM TRAFFIC SIGNAL POST TYPE "S-14"	1.00	EACH	\$ 1,155.00	\$ 1,155.00



Department of  
Design and  
Construction

NEW YORK CITY DEPARTMENT OF DESIGN AND CONSTRUCTION PROJECT ID: SANDHW11  
DIVISION OF INFRASTRUCTURE - BUREAU OF DESIGN CONTRACT PIN: 8502017HW0001C

1/25/2017 11:57 AM

## BID SCHEDULE FORM

COL 1 SEQ. NO.	COL 2 ITEM NUMBER AND DESCRIPTION	COL 3 ENGINEER'S ESTIMATE OF QUANTITY	COL 4 UNIT	COL 5 UNIT PRICE (IN FIGURES) DOLLARS	COL 6 EXTENDED AMOUNT (IN FIGURES) DOLLARS	COL 7 CTS
187	T-3.1 INSTALL "ONE-WAY" SIGNAL UNIT ON MAST ARM OR TOP OF TRAFFIC POST	6.00	EACH	\$ 385.00	\$ 2,310.00	
188	T-3.18 REMOVE SIGNAL HEAD FROM ANY TYPE POST	5.00	EACH	\$ 319.00	\$ 1,595.00	
189	T-3.2 INSTALL "ONE-WAY" SIGNAL UNIT ON THE SHAFT OF ANY POST	1.00	EACH	\$ 418.00	\$ 418.00	
190	T-3.21 REMOVE PEDESTRIAN SIGNAL OR SIGN UNIT OR OTHER ILLUMINATED SIGNS FROM ANY POST	3.00	EACH	\$ 253.00	\$ 759.00	
191	T-3.37 INSTALL SIGNAL ON MAST ARM USING RIGID MOUNT BRACKETS	1.00	EACH	\$ 924.00	\$ 924.00	
192	T-3.6 INSTALL PEDESTRIAN SIGNAL ON ANY TYPE POST	7.00	EACH	\$ 330.00	\$ 2,310.00	

**BID SCHEDULE FORM**

COL 1 SEQ. NO.	COL 2 ITEM NUMBER and DESCRIPTION	COL 3 ENGINEERS ESTIMATE OF QUANTITY	COL 4 UNIT	COL 5 UNIT PRICE (IN FIGURES) DOLLARS & CENTS	COL 6 EXTENDED AMOUNT (IN FIGURES) DOLLARS & CENTS
193	T-30013L FURNISH ADJUSTABLE 3 SECTION 1-WAY, DIE CAST ALUMINUM TRAFFIC SIGNALS 8" - W/LED LENS :	7.00	EACH	\$ 495.00	\$ 3,465.00
194	T-31175 b) "2SPA"	1.00	EACH	\$ 308.00	\$ 308.00
195	T-31210 h) "HUB" ASSEMBLY *ASSEMBLY IS EQUAL TO ONE PAIR	4.00	EACH	\$ 35.20	\$ 140.80
196	T-31215 b) "2MS"	2.00	EACH	\$ 286.00	\$ 572.00
197	T-31245 FURNISH RIGID MOUNT SIGNAL BRACKETS	1.00	EACH	\$ 308.00	\$ 308.00
198	T-31340 f) "VB-P" ASSEMBLY *ASSEMBLY IS EQUAL TO ONE PAIR	13.00	EACH	\$ 110.00	\$ 1,430.00

1/25/2017 11:57 AM

**BID SCHEDULE FORM**

COL 1 SEQ. NO.	COL 2 ITEM NUMBER and DESCRIPTION	COL 3 ENGINEERS ESTIMATE OF QUANTITY	COL 4 UNIT	COL 5 UNIT PRICE (IN FIGURES) DOLLARS CTS	COL 6 EXTENDED AMOUNT (IN FIGURES) DOLLARS CTS
199	T-31351 g) *VB-2P* ASSEMBLY *ASSEMBLY IS EQUAL TO ONE PAIR	3.00	EACH	\$ 308.00	\$ 924.00
200	T-31500AL FURNISH 12" LENS & SIGNAL SECTION (LED AMBER ARROWS)	2.00	EACH	\$ 308.00	\$ 616.00
201	T-31500GL FURNISH 12" LENS & SIGNAL SECTION (LED GREEN ARROWS)	2.00	EACH	\$ 308.00	\$ 616.00
202	T-33000L FURNISH POLYCARBONATE INCANDESCENT PED SIGNAL W/LED LENS	1.00	EACH	\$ 638.00	\$ 638.00
203	T-33001-L FURNISH POLYCARBONATE PEDESTRIAN SIGNAL (16 X 16) W/LED COUNT LENS (SPECIFICATION A-L)	6.00	EACH	\$ 704.00	\$ 4,224.00
204	T-5.17 FURNISH AND INSTALL 2" RIGID CONDUIT ON A POST	10.00	L.F.	\$ 66.00	\$ 660.00

**BID SCHEDULE FORM**

COL 1 SEQ. NO.	COL 2 ITEM NUMBER and DESCRIPTION	COL 3 ENGINEER'S ESTIMATE OF QUANTITY	COL 4 UNITS	COL 5 UNIT PRICE (IN FIGURES) DOLLARS CENTS	COL 6 EXTENDED AMOUNT (IN FIGURES) DOLLARS CENTS
205	T-5.32 RESTORING PERMANENT ROADWAY (INCLUDING SAWCUT)	180.00	L.F.	\$ 82.50	\$ 14,850.00
206	T-5.49 FURNISH AND INSTALL ADDITIONAL 2" HDPE CONDUIT	20.00	L.F.	\$ 24.20	\$ 484.00
207	T-5.50 FURNISH AND INSTALL 2" HDPE UNDERGROUND CONDUIT IN PAVED ROADWAY	180.00	L.F.	\$ 24.20	\$ 4,356.00
208	T-5.52 FURNISH AND INSTALL 2" HDPE UNDERGROUND CONDUIT IN UNPAVED AREA	240.00	L.F.	\$ 24.20	\$ 5,808.00
209	T-6.1 INSTALL CABLE (INCLUDES OVERHEAD)	1,000.00	L.F.	\$ 8.80	\$ 8,800.00
210	T-6.10 REMOVE CABLE (INCLUDES OVERHEAD)	1,500.00	L.F.	\$ 6.60	\$ 9,900.00



Department of  
Design and  
Construction

NEW YORK CITY DEPARTMENT OF DESIGN AND CONSTRUCTION PROJECT ID: SANDHW11  
DIVISION OF INFRASTRUCTURE - BUREAU OF DESIGN CONTRACT PIN: 8502017HW00001C

1/25/2017 11:57 AM

## BID SCHEDULE FORM

COL 1 SEQ. NO.	COL 2 ITEM NUMBER and DESCRIPTION	COL 3 ENGINEERS ESTIMATE OF QUANTITY	COL 4 UNIT	COL 5 UNIT PRICE (IN FIGURES) DOLLARS - CENTS	COL 6 EXTENDED AMOUNT (IN FIGURES) DOLLARS - CENTS
211	T-6.2 INSTALL MULTIPLE CABLE (INCLUDES OVERHEAD)	1,500.00	L.F.	\$ 9. 90	\$ 14,850. 00
212	T-60000B FURNISH 2 c # 10B (BREAKDOWN = 2#10 WITH 3RD WIRE FOR GROUNDING).	1,500.00	L.F.	\$ 3. 30	\$ 4,950. 00
213	T-60040 e) 7 CONDUCTOR, 14 A.W.G.	1,000.00	L.F.	\$ 3. 30	\$ 3,300. 00
214	T-60190 e) 13 CONDUCTOR, 14 A.W.G.	1,800.00	L.F.	\$ 4. 40	7,920. 00
215	T-8.10 RELOCATE CONCRETE PYLON WITH POST	3.00	EACH	\$ 1,310. 00	3,930. 00
216	T-8.8 INSTALL CONCRETE PYLON	3.00	EACH	\$ 1,078. 00	3,234. 00



**BID SCHEDULE FORM**

COL 1 SEQ. NO.	COL 2 ITEM NUMBER AND DESCRIPTION	COL 3 ENGINEER'S ESTIMATE OR QUANTITY	COL 4 UNIT	COL 5 UNIT PRICE (IN FIGURES) DOLLARS CTS	COL 6 EXTENDED AMOUNT (IN FIGURES) DOLLARS CTS
217	T-8.9 REMOVE CONCRETE PYLON	3.00	EACH	\$ 561.00	\$ 1,683.00
218	T-81000 FURNISH CONCRETE PYLON	3.00	EACH	\$ 1,364.00	\$ 4,092.00
219	UTL-6.01.1 GAS MAIN CROSSING SEWER UP TO 24" IN DIAMETER (\$6.01) Unit price bid shall not be less than: \$ 1,040.00	1.00	EACH	\$ 1,144.00	\$ 1,144.00
220	UTL-6.01.9 GAS MAIN CROSSING WATER MAIN UP TO 20" IN DIAMETER (\$6.01) Unit price bid shall not be less than: \$ 485.00	12.00	EACH	\$ 533.50	\$ 6,402.00
221	UTL-6.02 EXTRA EXCAVATION FOR THE INSTALLATION OF CATCH BASIN SEWER DRAIN PIPES WITH GAS INTERFERENCES (\$6.02) Unit price bid shall not be less than: \$ 715.00	3.00	EACH	<del>786.</del> 786.50	\$ 2,359.50
222	UTL-6.03 REMOVAL OF ABANDONED GAS FACILITIES, ALL SIZES. (\$6.03) Unit price bid shall not be less than: \$ 15.00	1,500.00	L.F.	\$ 16.50	\$ 24,750.00

**BID SCHEDULE FORM**

COL 1 SEQ. NO.	COL 2 ITEM NUMBER AND DESCRIPTION	COL 3 ENGINEER'S ESTIMATE OF QUANTITY	COL 4 UNIT	COL 5 UNIT PRICE (IN FIGURES) DOLLARS CTS	COL 6 EXTENDED AMOUNT (IN FIGURES) DOLLARS CTS
223	UTL-6.03.1 REMOVAL OF ABANDONED GAS FACILITIES WITH POSSIBLE COAL TAR WRAP. ALL SIZES. (FOR NATIONAL GRID WORK ONLY) (\$6.03) Unit price bid shall not be less than: \$ 25.00	700.00	L.F.	\$ 27.50	\$ 19,250.00
224	UTL-6.04 ADJUST HARDWARE TO GRADE USING SPACER RINGS/ADAPTORS. (STREET REPAIRING.) (\$6.04) Unit price bid shall not be less than: \$ 35.00	12.00	EACH	\$ 38.50	462.00
225	UTL-6.05 ADJUST HARDWARE TO GRADE BY RESETTING. (ROAD RECONSTRUCTION.) (\$6.05) Unit price bid shall not be less than: \$ 65.00	13.00	EACH	\$ 71.50	929.50
226	UTL-6.06 SPECIAL CARE EXCAVATION AND BACKFILLING (\$6.06) Unit price bid shall not be less than: \$ 180.00	400.00	C.Y.	\$ 198.00	\$ 79,200.00
227	UTL-6.07 TEST PITS FOR GAS FACILITIES (\$6.07) Unit price bid shall not be less than: \$ 100.00	50.00	C.Y.	\$ 110.00	\$ 5,500.00

## BID SCHEDULE FORM

COL 1 SECTION	COL 2 ITEM NUMBER AND DESCRIPTION	COL 3 ENGINEER'S ESTIMATE OF QUANTITY	COL 4 UNIT	COL 5 UNIT PRICE (IN FIGURES) IN DOLLARS AND CENTS	COL 6 EXTENDED AMOUNT (IN FIGURES) IN DOLLARS AND CENTS
228	UTL-GCS-2WS GAS INTERFERENCES AND ACCOMMODATIONS PRICE BID SHALL BE FOR THE FIXED SUM OF \$ 30,000.00	1.00	F.S.	30,000 00	\$30,000 00

SUB-TOTAL: \$ 13,208,887.50

229	6.39 A MOBILIZATION BID PRICE OF MOBILIZATION SHALL NOT EXCEED 4% OF THE ABOVE SUB-TOTAL PRICE.	1.00	L.S.	\$ 430,699.50	430,699.50
-----	--	------	------	---------------	------------

TOTAL BID PRICE: \$ 13,639,587.00

PLEASE BE SURE A LEGIBLE BID IS ENTERED FOR EACH ITEM.  
THE BIDDER SHALL INSERT THE TOTAL BID PRICE IN  
THE BID FORM ON PAGE C-4 OF THIS BID BOOKLET.

**BID FORM**

**PROJECT ID. SANDHW11**

**TOTAL BID PRICE:** In the space provided below, the Bidder shall indicate its Total Bid Price in figures. Such Total Bid Price is set forth on the final page of the Bid Schedule.

TOTAL BID PRICE:  
(a/k/a BID PROPOSAL)

\$ 13,639,587.00

BB 4/13/17

**BIDDER'S SIGNATURE AND AFFIDAVIT**

Bidder: NY Asphalt Inc.

By:   
(Signature of Partner or corporate officer)

  
Secretary of Corporate Bidder

Attest:  
(Corporate Seal)

Affidavit on the following page should be subscribed  
and sworn to before a Notary Public

**BID FORM (TO BE NOTARIZED)**

AFFIDAVIT WHERE BIDDER IS AN INDIVIDUAL

STATE OF NEW YORK, COUNTY OF \_\_\_\_\_ ss: \_\_\_\_\_ being duly sworn says:  
I am the person described in and who executed the foregoing bid, and the several matters therein stated are in all respects true.

\_\_\_\_\_  
(Signature of the person who signed the Bid)

Subscribed and sworn to before me this \_\_\_\_\_ day of \_\_\_\_\_, \_\_\_\_\_

\_\_\_\_\_  
Notary Public

AFFIDAVIT WHERE BIDDER IS A PARTNERSHIP

STATE OF NEW YORK, COUNTY OF \_\_\_\_\_ ss: \_\_\_\_\_ being duly sworn says:  
I am a member of \_\_\_\_\_ the firm described in and which executed the foregoing bid. I subscribed the name of the firm thereto on behalf of the firm, and the several matters therein stated are in all respects true.

\_\_\_\_\_  
(Signature of Partner who signed the Bid)

Subscribed and sworn to before me this \_\_\_\_\_ day of \_\_\_\_\_, \_\_\_\_\_

\_\_\_\_\_  
Notary Public

AFFIDAVIT WHERE BIDDER IS A CORPORATION

STATE OF NEW YORK, COUNTY OF Richmond ss: Michael Thompson being duly sworn says:  
I am the president of the above named corporation whose name is subscribed to and which executed the foregoing bid. I reside at Colts Neck, NJ.  
I have knowledge of the several matters therein stated, and they are in all respects true.

\_\_\_\_\_  
(Signature of Corporate Officer who signed the Bid)

Subscribed and sworn to before me this 12<sup>th</sup> day of April, 2017

Michele Renna  
Notary Public

MICHELE RENNA  
NOTARY PUBLIC STATE OF NEW YORK  
No. 01RE6110285  
Qualified in Richmond County  
My Commission Expires May 24, 2020

BID BOND 1  
FORM OF BID BOND

KNOW ALL MEN BY THESE PRESENTS. That we, NY Asphalt, Inc.  
366 Industrial Loop  
Staten Island, NY 10309

hereinafter referred to as the "Principal", and Philadelphia Indemnity Insurance Company  
One Bala Plaza, Suite 100  
Bala Cynwyd, PA 19004

hereinafter referred to as the "Surety" are held and firmly bound to THE CITY OF NEW YORK,  
hereinafter referred to as the "CITY", or to its successors and assigns in the penal sum of \_\_\_\_\_

Ten Percent (10%) of Amount Bid

(\$ XXXX ), Dollars lawful money of the United States, for the payment of which said sum of money well and truly to be made, we, and each of us, bind ourselves, our heirs, executors, administrators, successors and assigns, jointly and severally, firmly by these presents.

Whereas, the Principal is about to submit (or has submitted) to the City the accompanying proposal, hereby made a part hereof, to enter into a contract in writing for Project ID: SANDHW11

PIN: 8502017HW0001C Reconstruction of Beach Channel Drive Between 116th Street and  
Beach 124th Street, Borough of Queens

NOW, THEREFORE, the conditions of this obligation are such that if the Principal shall not withdraw said Proposal without the consent of the City for a period of forty-five (45) days after the opening of bids and in the event of acceptance of the Principal's Proposal by the City, if the Principal shall:

(a) Within ten (10) days after notification by the City, execute in quadruplicate and deliver to the City all the executed counterparts of the Contract in the form set forth in the Contract Documents, in accordance with the proposal as accepted, and

(b) Furnish a performance bond and separate payment bond, as may be required by the City, for the faithful performance and proper fulfillment of such Contract, which bonds shall be satisfactory in all respects to the City and shall be executed by good and sufficient sureties, and

(c) In all respects perform the agreement created by the acceptance of said Proposal as provided in the Information for Bidders, bound herewith and made a part hereof, or if the City shall reject the aforesaid Proposal, then this obligation shall be null and void; otherwise to remain in full force and effect.



BID BOND 2

In the event that the Proposal of the Principal shall be accepted and the Contract be awarded to him the Surety hereunder agrees subject only to the payment by the Principal of the premium therefore, if requested by the City, to write the aforementioned performance and payment bonds in the form set forth in the Contract Documents.

It is expressly understood and agreed that the liability of the Surety for any and all claims hereunder shall in no event exceed the penal amount of this obligation as herein stated.

There shall be no liability under this bond if, in the event of the acceptance of the Principal's Proposal by the City, either a performance bond or payment bond, or both, shall not be required by the City on or before the 30th day after the date on which the City signs the Contract.

The surety, for the value received, hereby stipulates and agrees that the obligations of the Surety and its bond shall in no way be impaired or affected by any postponements of the date upon which the City will receive or open bids, or by any extensions of the time within which the City may accept the Principal's Proposal, or by any waiver by the City of any of the requirements of the Information for Bidders, and the Surety hereby waives notice of any such postponements, extensions, or waivers.

IN WITNESS WHEREOF, the Principal and the Surety have hereunto set their hands and seals and such of them as are corporations have caused their corporate seals to be hereto affixed and these presents to be signed by their proper officers the 13th day of April, 2017.

(Seal)

NY Asphalt, Inc. (L.S.)  
Principal

By: 

(Seal)

Philadelphia Indemnity Insurance Comapny

Surety

By: 

Michael Culnen, Attorney-In-Fact





BID BOND 3

ACKNOWLEDGMENT OF PRINCIPAL, IF A CORPORATION

State of New York County of Richmond ss:  
On this 12<sup>th</sup> day of April, 2017, before me personally came  
Michael Thompson to me known, who, being by me duly sworn, did depose and say  
that he resides at Colts Neck, NJ  
that he is the President of NY Asphalt, Inc.  
the corporation described in and which executed the foregoing instrument; that he knows the seal of said  
corporation; that one of the seals affixed to said instrument is such seal; that it was so affixed by order of  
the directors of said corporation, and that he signed his name thereto by like order.

Michele Renna  
Notary Public

MICHELE RENNA  
NOTARY PUBLIC STATE OF NEW YORK  
No. 01RE6110285  
Qualified in Richmond County  
My Commission Expires May 24, 2020

ACKNOWLEDGMENT OF PRINCIPAL, IF A PARTNERSHIP

State of \_\_\_\_\_ County of \_\_\_\_\_ ss:  
On this \_\_\_\_\_ day of \_\_\_\_\_, \_\_\_\_\_, before me personally appeared  
\_\_\_\_\_ to me known and known to me to be one of the members of the  
firm of \_\_\_\_\_ described in and who executed the foregoing  
instrument, and he acknowledged to me that he executed the same as and for the act and deed of said  
firm.

\_\_\_\_\_  
Notary Public

ACKNOWLEDGMENT OF PRINCIPAL, IF AN INDIVIDUAL

State of \_\_\_\_\_ County of \_\_\_\_\_ ss:  
On this \_\_\_\_\_ day of \_\_\_\_\_, \_\_\_\_\_, before me personally appeared  
\_\_\_\_\_ to me known and known to me to be the person described in  
and who executed the foregoing instrument and acknowledged that he executed the same.

\_\_\_\_\_  
Notary Public

AFFIX ACKNOWLEDGMENTS AND JUSTIFICATION OF SURETIES



(NO TEXT ON THIS PAGE)



## SURETY ACKNOWLEDGEMENT

State of **New Jersey**

SS:

County of **Essex**

On this **13th** day of **April, 2017**, before me personally comes **Michael Culnen** to me known, who, being by me duly sworn, deposes and says that he resides in **Mendham Township, NJ** that he is the Attorney-In-Fact of the **Philadelphia Indemnity Insurance Company** the Corporation described in and which executed the foregoing instrument; that he knows that seal of said corporation; that the seal affixed to the said instrument is such Corporate seal; that it was so affixed by the order of the Board of Directors of the said Corporation, and that he signed his name thereto by like order.

**CATHY M KNOKE**  
NOTARY PUBLIC  
STATE OF NEW JERSEY  
ID # 50009608  
MY COMMISSION EXPIRES FEB. 4, 2020

  
(Signature and Title of Official Taking Acknowledgement)



PHILADELPHIA INDEMNITY INSURANCE COMPANY  
One Bala Plaza, Suite 100  
Bala Cynwyd, PA 19004-0950

Power of Attorney

KNOW ALL PERSONS BY THESE PRESENTS: That PHILADELPHIA INDEMNITY INSURANCE COMPANY (the Company), a corporation organized and existing under the laws of the Commonwealth of Pennsylvania, does hereby constitute and appoint Michael Culnen of USI Insurance Services, LLC, its true and lawful Attorney-in-fact with full authority to execute on its behalf bonds, undertakings, recognizances and other contracts of indemnity and writings obligatory in the nature thereof, issued in the course of its business and to bind the Company thereby, in an amount not to exceed \$25,000,000.00.

This Power of Attorney is granted and is signed and sealed by facsimile under and by the authority of the following Resolution adopted by the Board of Directors of PHILADELPHIA INDEMNITY INSURANCE COMPANY on the 14<sup>th</sup> of November, 2016.

**RESOLVED:** That the Board of Directors hereby authorizes the President or any Vice President of the Company: (1) Appoint Attorney(s) in Fact and authorize the Attorney(s) in Fact to execute on behalf of the Company bonds and undertakings, contracts of indemnity and other writings obligatory in the nature thereof and to attach the seal of the Company thereto; and (2) to remove, at any time, any such Attorney-in-Fact and revoke the authority given. And, be it

**FURTHER RESOLVED:** That the signatures of such officers and the seal of the Company may be affixed to any such Power of Attorney or certificate relating thereto by facsimile, and any such Power of Attorney so executed and certified by facsimile signatures and facsimile seal shall be valid and binding upon the Company in the future with respect to any bond or undertaking to which it is attached.

IN TESTIMONY WHEREOF, PHILADELPHIA INDEMNITY INSURANCE COMPANY HAS CAUSED THIS INSTRUMENT TO BE SIGNED AND ITS CORPORATE SEAL TO BE AFFIXED BY ITS AUTHORIZED OFFICE THIS 14<sup>TH</sup> DAY OF NOVEMBER, 2016.



(Seal)

Robert D. O'Leary Jr., President & CEO  
Philadelphia Indemnity Insurance Company

On this 14<sup>th</sup> day of November, 2016, before me came the individual who executed the preceding instrument, to me personally known, and being by me duly sworn said that he is the therein described and authorized officer of the PHILADELPHIA INDEMNITY INSURANCE COMPANY; that the seal affixed to said instrument is the Corporate seal of said Company; that the said Corporate Seal and his signature were duly affixed.

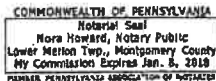

Notary Public:

residing at:

Bala Cynwyd, PA

(Notary Seal)

My commission expires:

January 8, 2018

I, Edward Sayago, Corporate Secretary of PHILADELPHIA INDEMNITY INSURANCE COMPANY, do hereby certify that the foregoing resolution of the Board of Directors and this Power of Attorney issued pursuant thereto on this 14<sup>th</sup> day of November, 2016 are true and correct and are still in full force and effect. I do further certify that Robert D. O'Leary Jr., who executed the Power of Attorney as President, was on the date of execution of the attached Power of Attorney the duly elected President of PHILADELPHIA INDEMNITY INSURANCE COMPANY,

In Testimony Whereof I have subscribed my name and affixed the facsimile seal of each Company this 13th day of April, 2017.



Edward Sayago, Corporate Secretary  
PHILADELPHIA INDEMNITY INSURANCE COMPANY





**PHILADELPHIA INDEMNITY INSURANCE COMPANY**

**Statutory Statements of Admitted Assets, Liabilities and Capital and Surplus**  
(in thousands, except par value and share amounts)

<u>Admitted Assets</u>	<u>As of December 31,</u>	
	<u>2015</u>	<u>2014</u>
Bonds (fair value \$6,007,876 and \$6,153,215)	\$ 5,821,420	\$ 5,869,602
Preferred stocks (fair value \$64,498 and \$59,525)	62,617	59,413
Common stocks (cost \$104,587 and \$110,951)	88,259	97,616
Mortgage loans	154,042	21,402
Other invested assets (cost \$194,804 and \$156,141)	196,159	154,549
Derivatives	185	-
Cash, cash equivalents and short-term investments	32,936	45,054
Cash and invested assets	<u>6,355,618</u>	<u>6,247,636</u>
Premiums receivable, agents' balances and other receivables	734,983	673,590
Reinsurance receivable on paid losses	25,869	27,162
Accrued investment income	67,892	65,074
Receivable from affiliates	393	4,104
Net deferred tax asset	174,553	164,545
Other assets	2,200	106
Total admitted assets	<u>\$ 7,361,508</u>	<u>\$ 7,182,217</u>
 <u>Liabilities and Capital and Surplus</u>		
<b>Liabilities:</b>		
Net unpaid losses and loss adjustment expenses	\$ 3,514,230	\$ 3,169,910
Net unearned premiums	1,342,996	1,260,065
Reinsurance payable on paid loss and loss adjustment expenses	11,618	3,747
Ceded reinsurance premiums payable	63,634	63,104
Commissions payable, contingent commissions and other similar charges	240,901	226,034
Federal income taxes payable	11,612	13,990
Accrued expenses and other liabilities	36,426	50,281
Payable to affiliates	11,824	9,877
Provision for reinsurance	554	1,000
Payable for purchased securities	80,193	46,833
Total liabilities	<u>5,313,988</u>	<u>4,844,841</u>
 <b>Capital:</b>		
Common stock, par value of \$10 per share; 1,000,000 shares authorized, 450,000 shares issued and outstanding	4,500	3,600
<b>Surplus:</b>		
Gross paid-in and contributed surplus	386,071	386,970
Unassigned surplus	<u>1,656,949</u>	<u>1,946,806</u>
Total surplus	<u>2,043,020</u>	<u>2,333,776</u>
Total capital and surplus	<u>2,047,520</u>	<u>2,337,376</u>
Total liabilities and capital and surplus	<u>\$ 7,361,508</u>	<u>\$ 7,182,217</u>

The undersigned, being duly sworn, says: That she is the Executive Vice President and Chief Financial Officer of Philadelphia Indemnity Insurance Company; that said Company is a corporation duly organized in the state of Pennsylvania, and licensed and engaged in the State of Pennsylvania and has duly complied with all the requirements of the laws of the said State applicable of the said Company and is duly qualified to act as Surety under such laws; that said Company has also complied with and is duly qualified to act as Surety under the Act of Congress. And that to the best of her knowledge and belief the above statement is a full, true and correct statement of

Attest:

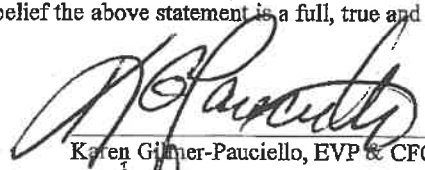
  
Karen Gilmer-Pauciello, EVP & CFO

Sworn to before me this 6th day of June 2016.

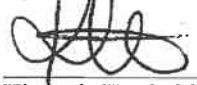
  
Kimberly Kessleski, COMMONWEALTH OF PENNSYLVANIA  
Notarial Seal  
Kimberly A. Kessleski, Notary Public  
Lower Merion Twp., Montgomery County  
My Commission Expires Dec. 18, 2016  
MEMBER, PENNSYLVANIA ASSOCIATION OF NOTARIES



6. Compliance Report

The bidder, as an individual, or as a member, partner, director, or officer of the bidder, if the same be a firm, partnership, or corporation, (1) represents that his attention has been specifically drawn to Executive Order No. 50, dated, April 25, 1980, on Equal Employment Compliance of the contract, and (2) warrants that he will comply with the provisions of Executive Order No. 50. The Employment Report must be submitted as part of the bid.

The bidder, as an individual, or as a member, partner, director, or officer of the bidder, if the same be a firm, partnership, or corporation, executes this document expressly warranting that he will comply with: (1) the provision of the contract on providing records, Chapter 8.

7. By submission of this bid, the bidder certifies that it now has and will continue to have the financial capability to fully perform the work required for this contract. Any award of this contract will be made in reliance upon such certification. Upon request therefor, the bidder will submit written verification of such financial capability in a form that is acceptable to the department.

8. In accordance with Section 165 of the State Finance Law, the bidder agrees that tropical hardwoods, as defined in Section 165 of the State Finance Law, shall not be utilized in the performance of this Contract, except as the same are permitted by the foregoing provision of law.

9. The bidder has visited and examined the site of the work and has carefully examined the Contract in the form approved by the Corporation Counsel, and will execute the Contract and perform all its items, covenants and conditions, and will provide, furnish and deliver all the work, materials, supplies, tools and appliances for all labor and materials necessary or required for the hereinafter named work, all in strict conformity with the Contract, for the prices set forth in the Bid Schedule:

10. M/WBE UTILIZATION PLAN: By signing its bid, the bidder agrees to the Vendor Certification and Required Affirmations set forth below, unless a full waiver of the Participation Goals is granted. The Vendor Certification and Required Affirmations will be deemed to satisfy the requirement to complete Section V of Part II of Schedule B: M/WBE Utilization Plan.

**Section V: Vendor Certification and Required Affirmations:**

I hereby:

- 1) acknowledge my understanding of the M/WBE participation requirements as set forth in this Contract and the pertinent provisions of Section 6-129 of the Administrative Code of the City of New York and the rules promulgated thereunder;
- 2) affirm that the information supplied in support of the M/WBE Utilization Plan is true and correct;
- 3) agree, if awarded this Contract, to comply with the M/WBE participation requirements of this Contract, the pertinent provisions of Section 6-129, and the rules promulgated thereunder, all of which shall be deemed to be material terms of this Contract;
- 4) agree and affirm that it is a material term of this Contract that the Vendor will award the total dollar value of the M/WBE Participation Goals to certified MBEs and/or WBEs, unless a full waiver is obtained or such goals are modified by the Agency; and
- 5) agree and affirm, if awarded this Contract, to make all reasonable, good faith efforts to meet the M/WBE Participation Goals, or If a partial waiver is obtained or such goals are modified by the Agency, to meet the modified Participation Goals by soliciting and obtaining the participation of certified MBE and/or WBE firms.



## M/WBE PROGRAM

### M/WBE UTILIZATION PLAN

**M/WBE Program Requirements:** The requirements for the M/WBE Program are set forth on the following pages of this Bid Booklet, in the section entitled “Notice to All Prospective Contractors”.

**Schedule B: M/WBE Utilization Plan:** Schedule B: M/WBE Utilization Plan for this Contract is set forth in this Bid Booklet on the pages following the section entitled “Notice to All Prospective Contractors”. The M/WBE Utilization Plan (Part I) indicates whether Participation Goals have been established for this Contract. If Participation Goals have been established for this Contract, the bidder must submit an M/WBE Utilization Plan (Part II) with its bid.

**Waiver:** The bidder may seek a full or partial pre-award waiver of the Participation Goals in accordance with the “Notice to All Prospective Contractors” (See Part A, Section 10). The bidder’s request for a waiver must be submitted at least seven (7) calendar days prior to the bid date. Waiver requests submitted after the deadline will not be considered. The form for requesting a waiver of the Participation Goals is set forth in the M/WBE Utilization Plan (Part III).

**Rejection of the Bid:** The bidder must complete Schedule B: M/WBE Utilization Plan (Part II) set forth in this Bid Booklet on the pages following the section entitled “Notice to All Prospective Contractors”. A Schedule B submitted by the bidder which does not include the Vendor Certification and Required Affirmations (See Section V of Part II) will be deemed to be non-responsive, unless a full waiver of the Participation Goals is granted (Schedule B, Part III). In the event that the City determines that the bidder has submitted a Schedule B where the Vendor Certification and Required Affirmations are completed but other aspects of the Schedule B are not complete, or contain a copy or computation error that is at odds with the Vendor Certification and Required Affirmations, the bidder will be notified by the Agency and will be given four (4) calendar days from receipt of notification to cure the specified deficiencies and return a completed Schedule B to the Agency. Failure to do so will result in a determination that the Bid is non-responsive. Receipt of notification is defined as the date notice is emailed or faxed (if the bidder has provided an email address or fax number), or no later than five (5) calendar days from the date of mailing or upon delivery, if delivered.

**Impact on LBE Requirements:** If Participation Goals have been established for the participation of M/WBEs, the contractor is not required to comply with the Locally Based Enterprise Program (“LBE”). The LBE Program is set forth in Article 67 of the Contract.

**NOTICE TO ALL PROSPECTIVE CONTRACTORS**

**PARTICIPATION BY MINORITY-OWNED AND WOMEN-OWNED BUSINESS ENTERPRISES IN CITY PROCUREMENT**

**ARTICLE I. M/WBE PROGRAM**

Local Law No. 129 of 2005 added and Local Law 1 of 2013 amended Section 6-129 of the Administrative Code of the City of New York (hereinafter "Section 6-129"). Section 6-129 establishes the program for participation in City procurement ("M/WBE Program") by minority-owned business enterprises ("MBEs") and women-owned business enterprises ("WBEs"), certified in accordance with Section 1304 of the New York City Charter. As stated in Section 6-129, the intent of the program is to address the impact of discrimination on the City's procurement process, and to promote the public interest in avoiding fraud and favoritism in the procurement process, increasing competition for City business, and lowering contract costs. The contract provisions contained herein are pursuant to Section 6-129, and the rules of the Department of Small Business Services ("DSBS") promulgated thereunder.

If this Contract is subject to the M/WBE Program established by Section 6-129, the specific requirements of MBE and/or WBE participation for this Contract are set forth in Schedule B of the Contract (entitled the "M/WBE Utilization Plan"), and are detailed below. The Contractor must comply with all applicable MBE and WBE requirements for this Contract.

All provisions of Section 6-129 are hereby incorporated in the Contract by reference and all terms used herein that are not defined herein shall have the meanings given such terms in Section 6-129. Article I, Part A, below, sets forth provisions related to the participation goals for construction, standard and professional services contracts. Article I, Part B, below, sets forth miscellaneous provisions related to the M/WBE Program.

**PART A**

**PARTICIPATION GOALS FOR CONSTRUCTION, STANDARD AND PROFESSIONAL SERVICES CONTRACTS OR TASK ORDERS**

1. The MBE and/or WBE Participation Goals established for this Contract or Task Orders issued pursuant to this Contract, ("Participation Goals"), as applicable, are set forth on Schedule B, Part I to this Contract (see Page 1, line 1 Total Participation Goals) or will be set forth on Schedule B, Part I to Task Orders issued pursuant to this Contract, as applicable.

The Participation Goals represent a percentage of the total dollar value of the Contract or Task Order, as applicable, that may be achieved by awarding subcontracts to firms certified with New York City Department of Small Business Services as MBEs and/or WBEs, and/or by crediting the participation of prime contractors and/or qualified joint ventures as provided in Section 3 below, unless the goals have been waived or modified by Agency in accordance with Section 6-129 and Part A, Sections 10 and 11 below, respectively.

2. If Participation Goals have been established for this Contract or Task Orders issued pursuant to this Contract, Contractor agrees or shall agree as a material term of the Contract that Contractor shall be subject to the Participation Goals, unless the goals are waived or modified by Agency in accordance with Section 6-129 and Part A, Sections 10 and 11 below, respectively.

3. If Participation Goals have been established for this Contract or Task Order issued pursuant to this Contract, a Contractor that is an MBE and/or WBE shall be permitted to count its own participation toward fulfillment of the relevant Participation Goal, provided that in accordance with Section 6-129 the value of Contractor's participation shall be determined by subtracting from the total value of the Contract or Task Order, as applicable, any amounts that the Contractor pays to direct subcontractors (as defined in Section 6-129(c)(13)), and provided further that a Contractor that is certified as both an MBE and a WBE may count its own participation either toward the goal for MBEs or the goal for WBEs, but not both.

A Contractor that is a qualified joint venture (as defined in Section 6-129(c)(30)) shall be permitted to count a percentage of its own participation toward fulfillment of the relevant **Participation Goal**. In accordance with Section 6-129, the value of Contractor's participation shall be determined by subtracting from the total value of the Contract or Task Order, as applicable, any amounts that Contractor pays to direct subcontractors, and then multiplying the remainder by the percentage to be applied to total profit to determine the amount to which an MBE or WBE is entitled pursuant to the joint venture agreement, provided that where a participant in a joint venture is certified as both an MBE and a WBE, such amount shall be counted either toward the goal for MBEs or the goal for WBEs, but not both.

4. A. If **Participation Goals** have been established for this Contract, a prospective contractor shall be required to submit with its bid or proposal, as applicable, a completed Schedule B, M/WBE Utilization Plan, Part II (see Pages 2-4) indicating: (a) whether the contractor is an MBE or WBE, or qualified joint venture; (b) the percentage of work it intends to award to direct subcontractors; and (c) in cases where the contractor intends to award direct subcontracts, a description of the type and dollar value of work designated for participation by MBEs and/or WBEs, and the time frames in which such work is scheduled to begin and end. In the event that this M/WBE Utilization Plan indicates that the bidder or proposer, as applicable, does not intend to meet the **Participation Goals**, the bid or proposal, as applicable, shall be deemed non-responsive, unless Agency has granted the bidder or proposer, as applicable, a pre-award waiver of the Participation Goals in accordance with Section 6-129 and Part A, Section 10 below.

B. (i) If this Contract is for a master services agreement or other requirements type contract that will result in the issuance of Task Orders that will be individually registered ("Master Services Agreement") and is subject to M/WBE **Participation Goals**, a prospective contractor shall be required to submit with its bid or proposal, as applicable, a completed Schedule B, M/WBE Participation Requirements for Master Services Agreements That Will Require Individually Registered Task Orders, Part II (page 2) indicating the prospective contractor's certification and required affirmations to make all reasonable good faith efforts to meet participation goals established on each individual Task Order issued pursuant to this Contract, or if a partial waiver is obtained or such goals are modified by the Agency, to meet the modified **Participation Goals** by soliciting and obtaining the participation of certified MBE and/or WBE firms. In the event that the Schedule B indicates that the bidder or proposer, as applicable, does not intend to meet the **Participation Goals** that may be established on Task Orders issued pursuant to this Contract, the bid or proposal, as applicable, shall be deemed nonresponsive.

(ii) **Participation Goals** on a Master Services Agreement will be established for individual Task Orders issued after the Master Services Agreement is awarded. If **Participation Goals** have been established on a Task Order, a contractor shall be required to submit a Schedule B – M/WBE Utilization Plan For Independently Registered Task Orders That Are Issued Pursuant to Master Services Agreements, Part II (see Pages 2-4) indicating: (a) whether the contractor is an MBE or WBE, or qualified joint venture; (b) the percentage of work it intends to award to direct subcontractors; and (c) in cases where the contractor intends to award direct subcontracts, a description of the type and dollar value of work designated for participation by MBEs and/or WBEs, and the time frames in which such work is scheduled to begin and end. The contractor must engage in good faith efforts to meet the **Participation Goals** as established for the Task Order unless Agency has granted the contractor a pre-award waiver of the Participation Goals in accordance with Section 6-129 and Part A, Section 10 below.

C. **THE BIDDER/PROPOSER MUST COMPLETE THE SCHEDULE B INCLUDED HEREIN (SCHEDULE B, PART II). A SCHEDULE B SUBMITTED BY THE BIDDER/PROPOSER WHICH DOES NOT INCLUDE THE VENDOR CERTIFICATION AND REQUIRED AFFIRMATIONS (SEE SECTION V OF PART II) WILL BE DEEMED TO BE NON-RESPONSIVE, UNLESS A FULL WAIVER OF THE PARTICIPATION GOALS IS GRANTED (SCHEDULE B, PART III). IN THE EVENT THAT THE CITY DETERMINES THAT THE BIDDER/PROPOSER HAS SUBMITTED A SCHEDULE B WHERE THE VENDOR CERTIFICATION AND REQUIRED AFFIRMATIONS ARE COMPLETED BUT OTHER ASPECTS OF THE SCHEDULE B ARE NOT COMPLETE, OR CONTAIN A COPY OR COMPUTATION ERROR THAT IS AT ODDS WITH THE VENDOR CERTIFICATION AND AFFIRMATIONS, THE BIDDER/PROPOSER WILL BE NOTIFIED BY THE AGENCY AND WILL BE GIVEN FOUR (4) CALENDAR DAYS FROM RECEIPT OF NOTIFICATION TO CURE THE SPECIFIED DEFICIENCIES AND RETURN A COMPLETED SCHEDULE B TO THE AGENCY. FAILURE TO DO \_**



SO WILL RESULT IN A DETERMINATION THAT THE BID/PROPOSAL IS NON-RESPONSIVE. RECEIPT OF NOTIFICATION IS DEFINED AS THE DATE NOTICE IS E-MAILED OR FAXED (IF THE BIDDER/PROPOSER HAS PROVIDED AN E-MAIL ADDRESS OR FAX NUMBER), OR NO LATER THAN FIVE (5) CALENDAR DAYS FROM THE DATE OF MAILING OR UPON DELIVERY, IF DELIVERED.

5. Where an M/WBE Utilization Plan has been submitted, the Contractor shall, within 30 days of issuance by Agency of a notice to proceed, submit a list of proposed persons or entities to which it intends to award subcontracts within the subsequent 12 months. In the case of multiyear contracts, such list shall also be submitted every year thereafter. The Agency may also require the Contractor to report periodically about the contracts awarded by its direct subcontractors to indirect subcontractors (as defined in Section 6-129(c)(22)). **PLEASE NOTE: If this Contract is a public works project subject to GML §101(5) (i.e., a contract valued at or below \$3M for projects in New York City) or if the Contract is subject to a project labor agreement in accordance with Labor Law §222, and the bidder is required to identify at the time of bid submission its intended subcontractors for the Wicks trades (plumbing and gas fitting; steam heating, hot water heating, ventilating and air conditioning (HVAC); and electric wiring), the Contractor must identify all those to which it intends to award construction subcontracts for any portion of the Wicks trade work at the time of bid submission, regardless of what point in the life of the contract such subcontracts will occur. In identifying intended subcontractors in the bid submission, bidders may satisfy any Participation Goals established for this Contract by proposing one or more subcontractors that are MBEs and/or WBEs for any portion of the Wicks trade work. In the event that the Contractor's selection of a subcontractor is disapproved, the Contractor shall have a reasonable time to propose alternate subcontractors.**

6. MBE and WBE firms must be certified by DSBS in order for the Contractor to credit such firms' participation toward the attainment of the **Participation Goals**. Such certification must occur prior to the firms' commencement of work. A list of MBE and WBE firms may be obtained from the DSBS website at [www.nyc.gov/buycertified](http://www.nyc.gov/buycertified), by emailing DSBS at [buyer@sbs.nyc.gov](mailto:buyer@sbs.nyc.gov), by calling (212) 513-6356, or by visiting or writing DSBS at 110 William St., New York, New York, 10038, 7th floor. Eligible firms that have not yet been certified may contact DSBS in order to seek certification by visiting [www.nyc.gov/getcertified](http://www.nyc.gov/getcertified), emailing [MWBE@sbs.nyc.gov](mailto:MWBE@sbs.nyc.gov), or calling the DSBS certification helpline at (212) 513-6311. A firm that is certified as both an MBE and a WBE may be counted either toward the goal for MBEs or the goal for WBEs, but not both. No credit shall be given for participation by a graduate MBE or graduate WBE, as defined in Section 6-129(c)(20).

7. Where an M/WBE Utilization Plan has been submitted, the Contractor shall, with each voucher for payment, and/or periodically as Agency may require, submit statements, certified under penalty of perjury, which shall include, but not be limited to, the total amount the Contractor paid to its direct subcontractors, and, where applicable pursuant to Section 6-129(j), the total amount direct subcontractors paid to indirect subcontractors; the names, addresses and contact numbers of each MBE or WBE hired as a subcontractor by the Contractor, and, where applicable, hired by any of the Contractor's direct subcontractors; and the dates and amounts paid to each MBE or WBE. The Contractor shall also submit, along with its voucher for final payment: the total amount it paid to subcontractors, and, where applicable pursuant to Section 6-129(j), the total amount its direct subcontractors paid directly to their indirect subcontractors; and a final list, certified under penalty of perjury, which shall include the name, address and contact information of each subcontractor that is an MBE or WBE, the work performed by, and the dates and amounts paid to each.

8. If payments made to, or work performed by, MBEs or WBEs are less than the amount specified in the Contractor's M/WBE Utilization Plan, Agency shall take appropriate action, in accordance with Section 6-129 and Article II below, unless the Contractor has obtained a modification of its M/WBE Utilization Plan in accordance with Section 6-129 and Part A, Section 11 below.

9. Where an M/WBE Utilization Plan has been submitted, and the Contractor requests a change order the value of which exceeds the greater of 10 percent of the Contract or Task Order, as applicable, or \$500,000, Agency shall review the scope of work for the Contract or Task Order, as applicable, and the scale and types of work involved in the change order, and determine whether the **Participation Goals** should be modified.

10. Pre-award waiver of the **Participation Goals**. (a) A bidder or proposer, or contractor with respect to a Task Order, may seek a pre-award full or partial waiver of the **Participation Goals** in accordance with Section 6-129, which requests that Agency change one or more **Participation Goals** on the grounds that the **Participation Goals** are unreasonable in light of the availability of certified firms to perform the services required, or by demonstrating that it has legitimate business reasons for proposing a lower level of subcontracting in its M/WBE Utilization Plan.

(b) To apply for a full or partial waiver of the **Participation Goals**, a bidder, proposer, or contractor, as applicable, must complete Part III (Page 5) of Schedule B and submit such request no later than seven (7) calendar days prior to the date and time the bids, proposals, or Task Orders are due, in writing to the Agency by email at [zhangji@ddc.nyc.gov](mailto:zhangji@ddc.nyc.gov) or via facsimile at (718) 391-1886. Bidders, proposers, or contractors, as applicable, who have submitted requests will receive an Agency response by no later than two (2) calendar days prior to the due date for bids, proposals, or Task Orders; provided, however, that if that date would fall on a weekend or holiday, an Agency response will be provided by close-of-business on the business day before such weekend or holiday date.

(c) If the Agency determines that the **Participation Goals** are unreasonable in light of the availability of certified firms to perform the services required, it shall revise the solicitation and extend the deadline for bids and proposals, or revise the Task Order, as applicable.

(d) Agency may grant a full or partial waiver of the **Participation Goals** to a bidder, proposer or contractor, as applicable, who demonstrates—before submission of the bid, proposal or Task Order, as applicable—that it has legitimate business reasons for proposing the level of subcontracting in its M/WBE Utilization Plan. In making its determination, Agency shall consider factors that shall include, but not be limited to, whether the bidder, proposer or contractor, as applicable, has the capacity and the bona fide intention to perform the Contract without any subcontracting, or to perform the Contract without awarding the amount of subcontracts represented by the **Participation Goals**. In making such determination, Agency may consider whether the M/WBE Utilization Plan is consistent with past subcontracting practices of the bidder, proposer or contractor, as applicable, whether the bidder, proposer or contractor, as applicable, has made efforts to form a joint venture with a certified firm, and whether the bidder, proposer, or contractor, as applicable, has made good faith efforts to identify other portions of the Contract that it intends to subcontract.

11. Modification of M/WBE Utilization Plan. (a) A Contractor may request a modification of its M/WBE Utilization Plan after award of this Contract. **PLEASE NOTE: If this Contract is a public works project subject to GML §101(5) (i.e., a contract valued at or below \$3M for projects in New York City) or if the Contract is subject to a project labor agreement in accordance with Labor Law §222, and the bidder is required to identify at the time of bid submission its intended subcontractors for the Wicks trades (plumbing and gas fitting; steam heating, hot water heating, ventilating and air conditioning (HVAC); and electric wiring), the Contractor may request a Modification of its M/WBE Utilization Plan as part of its bid submission.** The Agency may grant a request for Modification of a Contractor's M/WBE Utilization Plan if it determines that the Contractor has established, with appropriate documentary and other evidence, that it made reasonable, good faith efforts to meet the **Participation Goals**. In making such determination, Agency shall consider evidence of the following efforts, as applicable, along with any other relevant factors:

- (i) The Contractor advertised opportunities to participate in the Contract, where appropriate, in general circulation media, trade and professional association publications and small business media, and publications of minority and women's business organizations;
- (ii) The Contractor provided notice of specific opportunities to participate in the Contract, in a timely manner, to minority and women's business organizations;
- (iii) The Contractor sent written notices, by certified mail or facsimile, in a timely manner, to advise MBEs or WBEs that their interest in the Contract was solicited;
- (iv) The Contractor made efforts to identify portions of the work that could be substituted for portions originally designated for participation by MBEs and/or WBEs in the M/WBE Utilization Plan, and for which the Contractor claims an inability to retain MBEs or WBEs;

- (v) The Contractor held meetings with MBEs and/or WBEs prior to the date their bids or proposals were due, for the purpose of explaining in detail the scope and requirements of the work for which their bids or proposals were solicited;
- (vi) The Contractor made efforts to negotiate with MBEs and/or WBEs as relevant to perform specific subcontracts, or act as suppliers or service providers;
- (vii) Timely written requests for assistance made by the Contractor to Agency's M/WBE liaison officer and to DSBS;
- (viii) Description of how recommendations made by DSBS and Agency were acted upon and an explanation of why action upon such recommendations did not lead to the desired level of participation of MBEs and/or WBEs.

Agency's M/WBE officer shall provide written notice to the Contractor of the determination.

(b) The Agency may modify the **Participation Goals** when the scope of the work has been changed by the Agency in a manner that affects the scale and types of work that the Contractor indicated in its M/WBE Utilization Plan would be awarded to subcontractors.

12. If this Contract is for an indefinite quantity of construction, standard or professional services or is a requirements type contract and the Contractor has submitted an M/WBE Utilization Plan and has committed to subcontract work to MBEs and/or WBEs in order to meet the **Participation Goals**, the Contractor will not be deemed in violation of the M/WBE Program requirements for this Contract with regard to any work which was intended to be subcontracted to an MBE and/or WBE to the extent that the Agency has determined that such work is not needed.

13. If **Participation Goals** have been established for this Contract or a Task Order issued pursuant to this Contract, at least once annually during the term of the Contract or Task Order, as applicable, Agency shall review the Contractor's progress toward attainment of its M/WBE Utilization Plan, including but not limited to, by reviewing the percentage of work the Contractor has actually awarded to MBE and/or WBE subcontractors and the payments the Contractor made to such subcontractors.

14. If **Participation Goals** have been established for this Contract or a Task Order issued pursuant to this Contract, Agency shall evaluate and assess the Contractor's performance in meeting those goals, and such evaluation and assessment shall become part of the Contractor's overall contract performance evaluation.

#### **PART B: MISCELLANEOUS**

1. The Contractor shall take notice that, if this solicitation requires the establishment of an M/WBE Utilization Plan, the resulting contract may be audited by DSBS to determine compliance with Section 6-129. See §6-129(e)(10). Furthermore, such resulting contract may also be examined by the City's Comptroller to assess compliance with the M/WBE Utilization Plan.

2. Pursuant to DSBS rules, construction contracts that include a requirement for an M/WBE Utilization Plan shall not be subject to the law governing Locally Based Enterprises set forth in Section 6-108.1 of the Administrative Code of the City of New York.

3. DSBS is available to assist contractors and potential contractors in determining the availability of MBEs and/or WBEs to participate as subcontractors, and in identifying opportunities that are appropriate for participation by MBEs and/or WBEs in contracts.

4. Prospective contractors are encouraged to enter into qualified joint venture agreements with MBEs and/or WBEs as defined by Section 6-129(c)(30).

5. By submitting a bid or proposal the Contractor hereby acknowledges its understanding of the M/WBE Program requirements set forth herein and the pertinent provisions of Section 6-129, and any rules promulgated thereunder, and if awarded this Contract, the Contractor hereby agrees to comply with the M/WBE Program requirements of this Contract and pertinent provisions of Section 6-129, and any rules promulgated thereunder, all of which shall be deemed to be material terms of this Contract. The Contractor hereby agrees to make all reasonable, good faith efforts to solicit and obtain the participation of MBEs and/or WBEs to meet the required **Participation Goals**.

## ARTICLE II. ENFORCEMENT

1. If Agency determines that a bidder or proposer, as applicable, has, in relation to this procurement, violated Section 6-129 or the DSBS rules promulgated pursuant to Section 6-129, Agency may disqualify such bidder or proposer, as applicable, from competing for this Contract and the Agency may revoke such bidder's or proposer's prequalification status, if applicable.

2. Whenever Agency believes that the Contractor or a subcontractor is not in compliance with Section 6-129 or the DSBS rules promulgated pursuant to Section 6-129, or any provision of this Contract that implements Section 6-129, including, but not limited to any M/WBE Utilization Plan, Agency shall send a written notice to the Contractor describing the alleged noncompliance and offering the Contractor an opportunity to be heard. Agency shall then conduct an investigation to determine whether such Contractor or subcontractor is in compliance.

3. In the event that the Contractor has been found to have violated Section 6-129, the DSBS rules promulgated pursuant to Section 6-129, or any provision of this Contract that implements Section 6-129, including, but not limited to, any M/WBE Utilization Plan, Agency may determine that one of the following actions should be taken:

- (a) entering into an agreement with the Contractor allowing the Contractor to cure the violation;
- (b) revoking the Contractor's pre-qualification to bid or make proposals for future contracts;
- (c) making a finding that the Contractor is in default of the Contract;
- (d) terminating the Contract;
- (e) declaring the Contractor to be in breach of Contract;
- (f) withholding payment or reimbursement;
- (g) determining not to renew the Contract;
- (h) assessing actual and consequential damages;
- (i) assessing liquidated damages or reducing fees, provided that liquidated damages may be based on amounts representing costs of delays in carrying out the purposes of the M/WBE Program, or in meeting the purposes of the Contract, the costs of meeting utilization goals through additional procurements, the administrative costs of investigation and enforcement, or other factors set forth in the Contract;
- (j) exercising rights under the Contract to procure goods, services or construction from another contractor and charge the cost of such contract to the Contractor that has been found to be in noncompliance; or
- (k) taking any other appropriate remedy.

4. If an M/WBE Utilization Plan has been submitted, and pursuant to this Article II, Section 3, the Contractor has been found to have failed to fulfill its **Participation Goals** contained in its M/WBE Utilization Plan or the **Participation Goals** as modified by Agency pursuant to Article I, Part A, Section 11, Agency may assess liquidated damages in the amount of ten percent (10%) of the difference between the dollar amount of work required to be awarded to MBE and/or WBE firms to meet the **Participation Goals** and the dollar amount the Contractor actually awarded and paid, and/or credited, to MBE and/or WBE firms. In view of the difficulty of accurately ascertaining the loss which the City will suffer by reason of Contractor's failure to meet the **Participation Goals**, the foregoing amount is hereby fixed and agreed as the liquidated damages that the City will suffer by reason of such failure, and not as a penalty. Agency may deduct and retain out of any monies which may become due under this Contract the amount of any such liquidated damages; and in case the amount which may become due under this Contract shall be less than the amount of liquidated damages suffered by the City, the Contractor shall be liable to pay the difference.

5. Whenever Agency has reason to believe that an MBE and/or WBE is not qualified for certification, or is participating in a contract in a manner that does not serve a commercially useful function (as defined in Section 6-129(c)(8)), or has violated any provision of Section 6-129, Agency shall notify the Commissioner of DSBS who shall determine whether the certification of such business enterprise should be revoked.

6. Statements made in any instrument submitted to Agency pursuant to Section 6-129 shall be submitted under penalty of perjury and any false or misleading statement or omission shall be grounds for the application of any applicable criminal and/or civil penalties for perjury. The making of a false or fraudulent statement by an MBE and/or WBE in any instrument submitted pursuant to Section 6-129 shall, in addition, be grounds for revocation of its certification.

7. The Contractor's record in implementing its M/WBE Utilization Plan shall be a factor in the evaluation of its performance. Whenever Agency determines that a Contractor's compliance with an M/WBE Utilization Plan has been unsatisfactory, Agency shall, after consultation with the City Chief Procurement Officer, file an advice of caution form for inclusion in VENDEX as caution data.

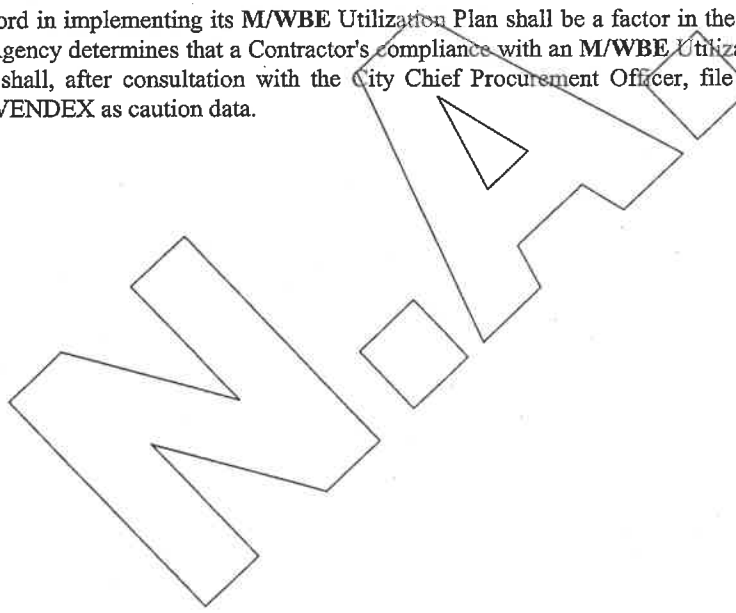

Tax ID #: \_\_\_\_\_

APT E- PIN #: 85017B0031

**SCHEDULE B – M/WBE Utilization Plan**  
**Part I: M/WBE Participation Goals**

**Part I to be completed by contracting agency**

**Contract Overview**

APT E- Pin # 85017B0031 FMS Project ID#: SANDHW11  
 Project Title/ Agency PIN # RECONSTRUCTION OF BEACH CHANNEL DRIVE. / 8502017HW0001C  
 Bid/Proposal Response Date \_\_\_\_\_  
 Contracting Agency Department of Design and Construction  
 Agency Address 30-30 Thomson Ave. City Long Island City State NY Zip Code 11101  
 Contact Person Lea Case Title MWBE Liaison & Compliance Analyst  
 Telephone # (718) 391-1003 Email casele@ddc.nyc.gov

**Project Description** (attach additional pages if necessary)

RECONSTRUCTION OF  
 BEACH CHANNEL DRIVE  
 BETWEEN BEACH 116TH STREET AND BEACH 124TH STREET  
 INCLUDING SEWER, WATER MAIN, TRAFFIC SIGNAL  
 AND STREET LIGHTING WORK  
 Together With All Work Incidental Thereto  
 BOROUGH OF QUEENS  
 CITY OF NEW YORK

**M/WBE Participation Goals for Services**

*Enter the percentage amount for each group or for an unspecified goal. Please note that there are no goals for Asian Americans in Professional Services.*

Prime Contract Industry: Construction

Group	Percentage
<u>Unspecified*</u>	<u>EXEMPT %</u>
or	
<u>Black American</u>	<u>UNSPECIFIED*</u>
<u>Hispanic American</u>	<u>UNSPECIFIED*</u>
<u>Asian American</u>	<u>UNSPECIFIED*</u>
<u>Women</u>	<u>UNSPECIFIED*</u>
<b>Total Participation Goals</b>	<b>EXEMPT %</b>

Line 1

*\*Note: For this procurement, individual ethnicity and gender goals are not specified. The Total Participation Goal for construction contracts may be met by using either Black-American, Hispanic-American, Asian American, or Women certified firms or any combination of such firms.*

Tax ID #: \_\_\_\_\_

APT E-  
PIN #: \_\_\_\_\_

85017B0031

**SCHEDULE B - Part II: M/WBE Participation Plan**

Part II to be completed by the bidder/proposer.

Please note: For Non-M/WBE Prime Contractors who will NOT subcontract any services and will self-perform the entire contract, you must obtain a FULL waiver by completing the Waiver Application on pages 17 and 18 and timely submitting it to the contracting agency pursuant to the Notice to Prospective Contractors. Once a FULL WAIVER is granted, it must be included with your bid or proposal and you do not have to complete or submit this form with your bid or proposal.

Section I: Prime Contractor Contact Information	
Tax ID # _____	FMS Vendor ID # _____
Business Name _____	Contact Person _____
Address _____	
Telephone # _____	Email _____

**Section II: M/WBE Utilization Goal Calculation: Check the applicable box and complete subsection.**

PRIME CONTRACTOR ADOPTING AGENCY M/WBE PARTICIPATION GOALS			
<input type="checkbox"/> For Prime Contractors (including Qualified Joint Ventures and M/WBE firms) adopting Agency M/WBE Participation Goals.  Calculate the total dollar value of your total bid that you agree will be awarded to M/WBE subcontractors for services and/or credited to an M/WBE prime contractor or Qualified Joint Venture.  Please review the Notice to Prospective Contractors for more information on how to obtain credit for M/WBE participation.	Total Bid/Proposal Value	Agency Total Participation Goals (Line 1, Page 13)	Calculated M/WBE Participation Amount
	\$ _____	X	= \$ Line 2

PRIME CONTRACTOR OBTAINED PARTIAL WAIVER APPROVAL: ADOPTING MODIFIED M/WBE PARTICIPATION GOALS			
<input type="checkbox"/> For Prime Contractors (including Qualified Joint Ventures and M/WBE firms) adopting Modified M/WBE Participation Goals.  Calculate the total dollar value of your total bid that you agree will be awarded to M/WBE subcontractors for services and/or credited to an M/WBE prime contractor or Qualified Joint Venture.  Please review the Notice to Prospective Contractors for more information on how to obtain credit for M/WBE participation.	Total Bid/Proposal Value	Adjusted Participation Goal (From Partial Waiver)	Calculated M/WBE Participation Amount
	\$ _____	X	= \$ Line 3

Tax ID #: \_\_\_\_\_

APT E-  
PIN #: \_\_\_\_\_

**Section III: M/WBE Utilization Plan; How Proposer/Bidder Will Fulfill M/WBE Participation Goals. Please review the Notice to Prospective Contractors for more information on how to obtain credit for M/WBE participation. Check applicable box. The Proposer or Bidder will fulfill the M/WBE Participation Goals:**

As an M/WBE Prime Contractor that will self-perform and/or subcontract to other M/WBE firms a portion of the contract the value of which is at least the amount located on Lines 2 or 3 above, as applicable. The value of any work subcontracted to non-M/WBE firms will not be credited towards fulfillment of M/WBE Participation Goals. Please check all that apply to Prime Contractor:

MBE       WBE

As a Qualified Joint Venture with an M/WBE partner, in which the value of the M/WBE partner's participation and/or the value of any work subcontracted to other M/WBE firms is at least the amount located on Lines 2 or 3 above, as applicable. The value of any work subcontracted to non M/WBE firms will not be credited towards fulfillment of M/WBE Participation Goals.

As a non M/WBE Prime Contractor that will enter into subcontracts with M/WBE firms the value of which is at least the amount located on Lines 2 or 3 above, as applicable.

**Section IV: General Contract Information**

What is the expected percentage of the total contract dollar value that you expect to award in subcontracts for services, regardless of M/WBE status? % \_\_\_\_\_

*Enter brief description of the type(s) and dollar value of subcontracts for all/any services you plan on subcontracting if awarded this contract. For each item, indicate whether the work is designated for participation by MBEs and/or WBEs and the time frame in which such work is scheduled to begin and end. Use additional sheets if necessary.*

✓ Scopes of Subcontract Work

1. \_\_\_\_\_
2. \_\_\_\_\_
3. \_\_\_\_\_
4. \_\_\_\_\_
5. \_\_\_\_\_
6. \_\_\_\_\_
7. \_\_\_\_\_
8. \_\_\_\_\_
9. \_\_\_\_\_
10. \_\_\_\_\_
11. \_\_\_\_\_
12. \_\_\_\_\_
13. \_\_\_\_\_
14. \_\_\_\_\_
15. \_\_\_\_\_
16. \_\_\_\_\_
17. \_\_\_\_\_



Tax ID #: \_\_\_\_\_

APT E-  
PIN #: \_\_\_\_\_

**Section V: Vendor Certification and Required Affirmations**

*I hereby:*

- 1) acknowledge my understanding of the M/WBE participation requirements as set forth herein and the pertinent provisions of Section 6-129 of the Administrative Code of the City of New York ("Section 6-129"), and the rules promulgated thereunder;*
- 2) affirm that the information supplied in support of this M/WBE Utilization Plan is true and correct;*
- 3) agree, if awarded this Contract, to comply with the M/WBE participation requirements of this Contract, the pertinent provisions of Section 6-129, and the rules promulgated thereunder, all of which shall be deemed to be material terms of this Contract;*
- 4) agree and affirm that it is a material term of this Contract that the Vendor will award the total dollar value of the M/WBE Participation Goals to certified MBEs and/or WBEs, unless a full waiver is obtained or such goals are modified by the Agency; and*
- 5) agree and affirm, if awarded this Contract, to make all reasonable, good faith efforts to meet the M/WBE Participation Goals, or If a partial waiver is obtained or such goals are modified by the Agency, to meet the modified Participation Goals by soliciting and obtaining the participation of certified MBE and/or WBE firms.*

Signature _____	Date _____
Print Name _____	Title _____

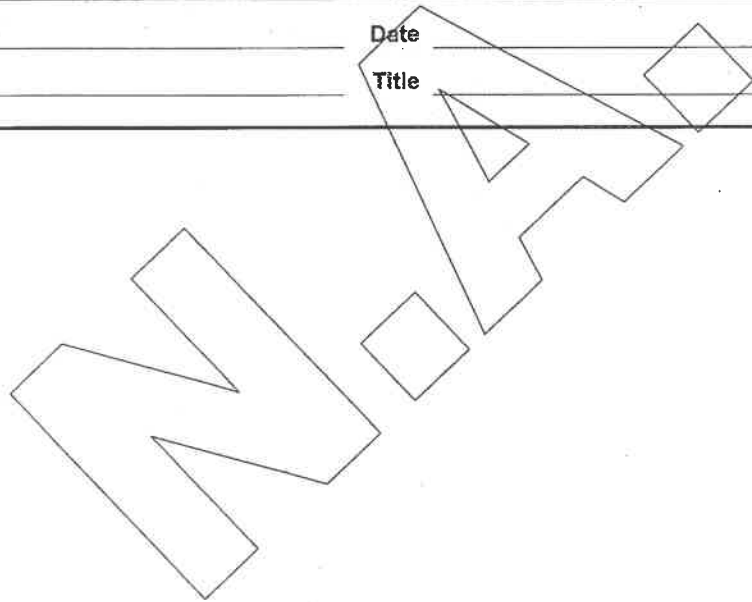

**SCHEDULE B – PART III – REQUEST FOR WAIVER OF M/WBE PARTICIPATION REQUIREMENT**

**Contract Overview**

Tax ID # \_\_\_\_\_ FMS Vendor ID # \_\_\_\_\_  
 Business Name \_\_\_\_\_  
 Contact Name \_\_\_\_\_ Telephone # \_\_\_\_\_ Email \_\_\_\_\_  
 Type of Procurement  Competitive Sealed Bids  Other Bid/Response Due Date \_\_\_\_\_  
 APT E-PIN # (for this procurement): \_\_\_\_\_ Contracting Agency: \_\_\_\_\_

**M/WBE Participation Goals as described in bid/solicitation documents**

\_\_\_\_\_ % Agency M/WBE Participation Goal

**Proposed M/WBE Participation Goal as anticipated by vendor seeking waiver**

\_\_\_\_\_ % of the total contract value anticipated in good faith by the bidder/proposer to be subcontracted for services and/or credited to an M/WBE Prime Contractor or Qualified Joint Venture.

**Basis for Waiver Request: Check appropriate box & explain in detail below (attach additional pages if needed)**

- Vendor does not subcontract services, and has the capacity and good faith intention to perform all such work itself with its own employees.
- Vendor subcontracts some of this type of work but at a lower % than bid/solicitation describes, and has the capacity and good faith intention to do so on this contract. (Attach subcontracting plan outlining services that the vendor will self-perform and subcontract to other vendors or consultants.)
- Vendor has other legitimate business reasons for proposing the M/WBE Participation Goal above. Explain under separate cover.

**References**

List 3 most recent contracts performed for NYC agencies (if any). Include information for each subcontract awarded in performance of such contracts. Add more pages if necessary.

CONTRACT NO.	AGENCY	DATE COMPLETED
Total Contract Amount \$ _____	Total Amount Subcontracted \$ _____	_____
Item of Work Subcontracted and Value of subcontract _____	Item of Work Subcontracted and Value of subcontract _____	Item of Work Subcontracted and Value of subcontract _____
CONTRACT NO. _____	AGENCY _____	DATE COMPLETED _____
Total Contract Amount \$ _____	Total Amount Subcontracted \$ _____	_____
Item of Work Subcontracted and Value of subcontract _____	Item of Work Subcontracted and Value of subcontract _____	Item of Work Subcontracted and Value of subcontract _____
CONTRACT NO. _____	AGENCY _____	DATE COMPLETED _____
Total Contract Amount \$ _____	Total Amount Subcontracted \$ _____	_____
Item of Work Subcontracted and Value of subcontract _____	Item of Work Subcontracted and Value of subcontract _____	Item of Work Subcontracted and Value of subcontract _____

List 3 most recent contracts performed for other entities. Include information for each subcontract awarded in performance of such contracts. Add more pages if necessary.

(Complete ONLY if vendor has performed fewer than 3 New York City contracts.)

<b>TYPE OF Contract</b>	<b>ENTITY</b>	<b>DATE COMPLETED</b>
Manager at entity that hired vendor (Name/Phone No./Email)		
Total Contract Amount \$	Total Amount Subcontracted \$	
Type of Work Subcontracted		

<b>TYPE OF Contract</b>	<b>AGENCY/ENTITY</b>	<b>DATE COMPLETED</b>
Manager at agency/entity that hired vendor (Name/Phone No./Email)		
Total Contract Amount \$	Total Amount Subcontracted \$	
Item of Work Subcontracted and Value of subcontract	Item of Work Subcontracted and Value of subcontract	Item of Work Subcontracted and Value of subcontract

<b>TYPE OF Contract</b>	<b>AGENCY/ENTITY</b>	<b>DATE COMPLETED</b>
Manager at entity that hired vendor (Name/Phone No./Email)		
Total Contract Amount \$	Total Amount Subcontracted \$	
Item of Work Subcontracted and Value of subcontract	Item of Work Subcontracted and Value of subcontract	Item of Work Subcontracted and Value of subcontract

**VENDOR CERTIFICATION:** I hereby affirm that the information supplied in support of this waiver request is true and correct, and that this request is made in good faith.

Signature: \_\_\_\_\_ Date: \_\_\_\_\_  
 Print Name: \_\_\_\_\_ Title: \_\_\_\_\_

**Shaded area below is for agency completion only**

**AGENCY CHIEF CONTRACTING OFFICER APPROVAL**  
 Signature: \_\_\_\_\_ Date: \_\_\_\_\_

**CITY CHIEF PROCUREMENT OFFICER APPROVAL**  
 Signature: \_\_\_\_\_ Date: \_\_\_\_\_

**Waiver Determination**  
 Full Waiver Approved:   
 Waiver Denied:   
 Partial Waiver Approved:   
 Revised Participation Goal: \_\_\_\_\_%

## APPRENTICESHIP PROGRAM REQUIREMENTS

Bidders are advised that the Apprenticeship Program Requirements set forth below apply to each contract for which a check mark is indicated before the word "Yes". Compliance with these requirements will be determined solely by the City.

YES                       NO

### (1) Apprenticeship Program Requirements

Notice to Bidders: Please be advised that, pursuant to the authority granted to the City under Labor Law Section 816-b, the Department of Design and Construction hereby requires that the contractor awarded a contract as a result of this Invitation for Bids, and any of its subcontractors with subcontracts worth two million dollars or over, have, prior to entering into such contract or subcontract, apprenticeship agreements appropriate for the type and scope of work to be performed that have been registered with, and approved by, the New York State Commissioner of Labor. In addition, the contractor and its subcontractors will be required to show that such apprenticeship program/s have successfully passed the two year Probation period following the initial registration date of such program/s with the New York State Department of Labor.

The failure to prove, upon request, that these requirements have been met shall result in the contract not being awarded to the contractor or the subcontract not being approved.

Please be further advised that, pursuant to Labor Law Section 220, the allowable ratio of apprentices to journeypersons in any craft classification shall not be greater than the ratio permitted to the contractor as to its workforce on any job under the registered apprenticeship program.

### (2) Apprenticeship Program Questionnaire

The bidder must submit a completed and signed Apprenticeship Program Questionnaire. The Questionnaire is set forth on the following page of the Bid Booklet.

## APPRENTICESHIP PROGRAM QUESTIONNAIRE ("APQ")

Bidder Name: \_\_\_\_\_

Project ID Number: \_\_\_\_\_

The Bidder MUST complete, sign, and submit this Apprenticeship Program Questionnaire with its bid.

1. Does the bidder have any Apprenticeship Program agreement(s) appropriate for the type and scope of work to be performed? (Note: Participation may be by either direct sponsorship or through collective bargaining agreement(s).)

\_\_\_\_\_ YES \_\_\_\_\_ NO

2. Has/have the bidder's Apprenticeship Program agreement(s) been registered with, and approved by the New York State Commissioner of Labor ("NYSDOL Commissioner")?

\_\_\_\_\_ YES \_\_\_\_\_ NO

3. Has/have the bidder's Apprenticeship Program successfully passed the two-year Probation period following its initial registration with the New York State Department of Labor ("NYSDOL")?

\_\_\_\_\_ YES \_\_\_\_\_ NO

If the answers to Questions 1, 2, and 3 are "Yes". The bidder shall, in the space below (and/or attached herewith where applicable), provide the contact information for such Apprenticeship Program(s) as well as information demonstrating that such Apprenticeship Program(s) have passed the two-year Probation period following its initial registration with the NYSDOL. (The bidder may attach additional pages if necessary).

- **Where the bidder directly sponsors any such apprenticeship Program(s),** the bidder shall provide the following:
  - The trade classification(s) covered by such program(s), and the date(s) such program(s) was/were approved by the NYSDOL Commissioner; and/or
  - A copy of a letter(s) from the NYSDOL, on NYSDOL's letterhead, executed by an official thereof, which verifies/verify the trade classification(s) covered by such program(s), and the date(s) such program(s) was/were approved by the NYSDOL Commissioner and the Active status of such program(s).
- **Where the bidder participates in any such Apprenticeship Program(s) through its membership in an employer organization(s) that directly sponsors such program(s) or where the employer association(s) participates in such program(s) through collective bargaining,** the bidder shall provide the following:
  - The contact information for the employer organization(s), and the apprenticeable trade(s) covered pursuant to the bidder's affiliation therewith, and the date such program(s) was/were approved by the NYSDOL Commissioner; or
  - A letter(s) from such employer organization(s), on letterhead of such organization(s), executed by an officer, delegate or official thereof, which verifies/verify the trade classification(s) covered by such program(s) was/were approved by the NYSDOL Commissioner, and that the bidder is both a member in good standing of the identified employer organization and is subject to the provisions of the Apprenticeship Program agreement(s) sponsored thereby.



## SAFETY QUESTIONNAIRE

The bidder must include, with its bid, all information requested on this Safety Questionnaire. Failure to provide a completed and signed Safety Questionnaire at the time of bid opening may result in disqualification of the bid as non-responsive.

**1. Bidder Information:**

Company Name: \_\_\_\_\_

DDC Project Number: \_\_\_\_\_

Company Size:            \_\_\_\_\_ Ten (10) employees or less  
    \_\_\_\_\_ Greater than ten (10) employees

Company has previously worked for DDC        \_\_\_\_\_ YES                        \_\_\_\_\_ NO

**2. Type(s) of Construction Work**

TYPE OF WORK	LAST 3 YEARS	THIS PROJECT
General Building Construction	_____	_____
Residential Building Construction	_____	_____
Nonresidential Building Construction	_____	_____
Heavy Construction, except building	_____	_____
Highway and Street Construction	_____	_____
Heavy Construction, except highways	_____	_____
Plumbing, Heating, HVAC	_____	_____
Painting and Paper Hanging	_____	_____
Electrical Work	_____	_____
Masonry, Stonework and Plastering	_____	_____
Carpentry and Floor Work	_____	_____
Roofing, Siding, and Sheet Metal	_____	_____
Concrete Work	_____	_____
Specialty Trade Contracting	_____	_____
Asbestos Abatement	_____	_____
<b>Other (specify)</b>	_____	_____
_____	_____	_____

**3. Experience Modification Rate:**

The Experience Modification Rate (EMR) is a rating generated by the National Council of Compensation Insurance (NCCI). This rating is used to determine the contractor's premium for worker's compensation insurance. The contractor may obtain its EMR by contacting its insurance broker or the NCCI. If the contractor cannot obtain its EMR, it must submit a written explanation as to why.

Project ID. \_\_\_\_\_

The Contractor must indicate its Intrastate and Interstate EMR for the past three years. [Note: For contractors with less than three years of experience, the EMR will be considered to be 1.00].

YEAR	<u>INTRASTATE RATE</u>	<u>INTERSTATE RATE</u>
_____	_____	_____
_____	_____	_____
_____	_____	_____

**If the Intrastate and/or Interstate EMR for any of the past three years is greater than 1.00, the contractor must attach, to this questionnaire, a written explanation for the rating and identify what corrective action was taken to correct the situation resulting in that rating.**

**4. OSHA Information:**

\_\_\_ YES · \_\_\_ NO Contractor has received a willful violation issued by OSHA or New York City Department of Buildings (NYCDOB) within the last three years.

\_\_\_ YES \_\_\_ NO Contractor has had an incident requiring OSHA notification within 8 hours (all work-related fatalities) or an incident requiring OSHA notification within 24 hours (all work-related in-patient hospitalizations, all amputations and all losses of an eye).

The Occupational Safety and Health Act (OSHA) of 1970 requires employers with ten or more employees, on a yearly basis to complete and maintain on file the form entitled "Log of Work-related Injuries and Illnesses". This form is commonly referred to as the OSHA 300 Log (OSHA 200 Log for 2001 and earlier).

The OSHA 300 Log must be submitted for the last three years for contractors with more than ten employees.

The Contractor must indicate the total number of hours worked by its employees, as reflected in payroll records for the past three years.

**The contractor must submit the Incident Rate for Lost Time Injuries (the Incident Rate) for the past three years. The Incident Rate is calculated in accordance with the formula set forth below. For each given year, the total number of incidents is the total number of non-fatal injuries and illnesses reported on the OSHA 300 Log. The 200,000 hours represents the equivalent of 100 employees working forty hours a week, fifty weeks per year.**

Incident Rate = 
$$\frac{\text{Total Number of Incidents} \times 200,000}{\text{Total Number of Hours Worked by Employees}}$$

YEAR	TOTAL NUMBERS OF HOURS WORKED BY EMPLOYEES	INCIDENT RATE
_____	_____	_____
_____	_____	_____
_____	_____	_____



Project ID. \_\_\_\_\_

If the contractor's Incident Rate for any of the past three years is one point higher than the Incident Rate for the type of construction it performs (listed below), the contractor must attach, to this questionnaire, a written explanation for the relatively high rate.

General Building Construction	8.5
Residential Building Construction	7.0
Nonresidential Building Construction	10.2
Heavy Construction, except building	8.7
Highway and Street Construction	9.7
Heavy Construction, except highways	8.3
Plumbing, Heating, HVAC	11.3
Painting and Paper Hanging	6.9
Electrical Work	9.5
Masonry, Stonework and Plastering	10.5
Carpentry and Floor Work	12.2
Roofing, Siding, and Sheet Metal	10.3
Concrete Work	8.6
Specialty Trade Contracting	8.6

**5. Safety Performance on Previous DDC Project(s)**

\_\_\_ YES \_\_\_ NO Contractor previously audited by the DDC Office of Site Safety.

DDC Project Number(s): \_\_\_\_\_, \_\_\_\_\_, \_\_\_\_\_

\_\_\_ YES \_\_\_ NO Accident on previous DDC Project(s).

DDC Project Number(s): \_\_\_\_\_, \_\_\_\_\_, \_\_\_\_\_

\_\_\_ YES \_\_\_ NO Fatality or Life-altering Injury on DDC Project(s) within the last three years.  
[Examples of a life-altering injury include loss of limb, loss of a sense (e.g., sight, hearing), or loss of neurological function].

DDC Project Number(s): \_\_\_\_\_, \_\_\_\_\_, \_\_\_\_\_

Date: \_\_\_\_\_

By: \_\_\_\_\_  
(Signature of Owner, Partner, Corporate Officer)

Title: \_\_\_\_\_

## Pre-Award Process

The bidder is advised that as part of the pre-award review of its bid, it may be required to submit the information described in Sections (A) through (D) below. If required, such information must be submitted by the bidder within five (5) business days following receipt of notification from DDC that it is among the low bidders. Such notification from DDC will be by facsimile or in writing and will specify the types of information must be submitted. The types of information the bidder may be required to submit are described below. In the event the bidder fails to submit the required information within the specified time frame, its bid may be rejected as nonresponsive.

\*\*\*\*\*

- (A) **Project Reference Form:** If required, the bidder must complete and submit the Project Reference Form set forth on pages 27 through 29 of this Bid Booklet. The Project Reference Form consists of 3 parts: (1) Contracts Completed by the Bidder, (2) Contracts Currently Under Construction by the Bidder, and (3) Pending Contracts Not Yet Started by the Bidder.
- (B) **Copy of License:** If required, the bidder must submit a copy of the license under which the bidder will be performing the work. Such license must clearly show the following: (1) Name of the Licensee, (2) License Number, and (3) Expiration date of the License. A copy of the license will be required from bidders for the following contracts: Plumbing Work, Electrical Work and Asbestos Abatement.
- (C) **Financial Information:** If required, the bidder must submit the financial information described below:
- (1) **Audited Financial Statements:** Financial statements (Balance Sheet and Income Statement) of the entity submitting the bid, as audited by an independent auditor licensed to practice as a certified public accountant (CPA). Audited financial statements for the three most recent fiscal years must be submitted. Each such financial statement must include the auditor's standard report.

If the bidder does not have audited financial statements, it must submit an affidavit attesting to the fact that the bidder does not have such statements. In addition, the bidder must submit the following documentation covering the three most recent fiscal years: signed federal tax returns, unaudited financial statements, and a "certified review letter" from a certified public accountant (CPA) verifying the unaudited financial statements.

Unless the most recent audited or unaudited financial statement was issued within ninety (90) days, the bidder must submit interim financial information that includes data on financial position and results of operation (income data) for the current fiscal year. Such information may be summarized on a monthly or quarterly basis or at other intervals.

- (2) **Schedule of Aged Accounts Receivable,** including portion due within ninety (90) days.

(D) **Project Specific Information:** If required, the bidder must submit the project specific information described below:

- (1) Statement indicating the number of years of experience the bidder has had and in what type of construction.
- (2) Resumes of all key personnel to be involved in the project, including the proposed project superintendent.
- (3) List of significant pieces of equipment expected to be used for the contract, and whether such equipment is owned or leased.
- (4) Description of work expected to be subcontracted, and to what firms, if known.
- (5) List of key material suppliers.
- (6) Preliminary bar chart time schedule
- (7) Contractor's expected means of financing the project. This should be based on the assumption that the contractor is required to finance 2X average monthly billings throughout the contract period.
- (8) Any other issues the contractor sees as impacting his ability to complete the project according to the contract.

In addition to the information described in Sections (A) through (D) above, the bidder shall submit such additional information as the Commissioner may require, including without limitation, an explanation or justification for specific unit price items.

The bidder is further advised that it may be required to attend a pre-award meeting with DDC representatives. If such a meeting is convened, the bidder will be advised as to any additional material to be provided.





**A. PROJECT REFERENCES – CONTRACTS COMPLETED BY THE BIDDER**

List all contracts substantially completed within the last 4 years, up to a maximum of 10, in descending order of date of substantial completion.

Project & Location	Contract Type	Contract Amount (\$000)	Date Completed	Owner Reference & Tel. No.	Architect/Engineer Reference & Tel. No. if different from owner

**B. PROJECT REFERENCES – CONTRACTS CURRENTLY UNDER CONSTRUCTION BY THE BIDDER**

List all contracts currently under construction even if they are not similar to the contract being awarded.

Project & Location	Contract Type	Contract Amount (\$000)	Subcontracted to Others (\$000)	Uncompleted Portion (\$000)	Date Scheduled to Complete	Owner Reference & Tel. No.	Architect/Engineer Reference & Tel. No. if different from owner

**C. PROJECT REFERENCES – PENDING CONTRACTS NOT YET STARTED BY THE BIDDER**

List all contracts awarded to or won by the bidder but not yet started.

Project & Location	Contract Type	Contract Amount (\$000)	Date Scheduled to Start	Owner Reference & Tel. No.	Architect/Engineer Reference & Tel. No. if different from owner



(NO TEXT ON THIS PAGE)

**OFFICE OF THE MAYOR  
BUREAU OF LABOR SERVICES  
CONTRACT CERTIFICATE**

To be completed if the contract is less than \$1,000,000

Contractor: \_\_\_\_\_

Address: \_\_\_\_\_  
\_\_\_\_\_

Telephone Number: \_\_\_\_\_

Name and Title of Signatory: \_\_\_\_\_  
\_\_\_\_\_

Contracting Agency or Owner: \_\_\_\_\_

Project Number: \_\_\_\_\_

Proposed Contract Amount: \_\_\_\_\_

Description and Address of Proposed Contract: \_\_\_\_\_

Names of Subcontractors in the amount of 750,000 or more on this contract (if not known at this time, so state indicating that trades will be subcontracted):  
\_\_\_\_\_  
\_\_\_\_\_  
\_\_\_\_\_

I, (fill in name of person signing) \_\_\_\_\_,  
hereby affirm that I am authorized by the above-named contractor to certify that said contractor's proposed contract with the above-named owner or city agency is less than \$1,000,000. This affirmation is made in accordance with Executive Order No. 50 (1980) as amended and its implementing regulations.

\_\_\_\_\_  
Date

\_\_\_\_\_  
Signature

**WILLFUL OR FRAUDULENT FALSIFICATION OF ANY DATA OR INFORMATION SUBMITTED HERewith MAY RESULT IN THE TERMINATION OF ANY CONTRACT BETWEEN THE CITY AND THE BIDDER OR CONTRACTOR AND BAR THE BIDDER OR CONTRACTOR FROM PARTICIPATION IN ANY CITY CONTRACT FOR A PERIOD OF UP TO THREE YEARS. FURTHER, SUCH FALSIFICATION MAY RESULT IN CRIMINAL PROSECUTION.**

(NO TEXT ON THIS PAGE)

## VENDEX COMPLIANCE

(A) **Vendex Fees:** Pursuant to Procurement Policy Board Rule 2-08(f)(2), the contractor will be charged a fee for the administration of the VENDEX system, including the Vendor Name Check process, if a Vendor Name Check review is required to be conducted by the Department of Investigation. The contractor shall also be required to pay the applicable required fees for any of its subcontractors for which Vendor Name Check reviews are required. The fee(s) will be deducted from payments made to the contractor under the contract. For contracts with an estimated value of less than or equal to \$1,000,000, the fee will be \$175 per Vendor Name Check review. For contracts with an estimated value of greater than \$1,000,000, the fee will be \$350 per Vendor Name Check review.

(B) **Confirmation of Vendex Compliance:** The Bidder shall submit this Confirmation of Vendex Compliance to the Department of Design and Construction, Contracts Section, 30-30 Thomson Avenue – First Floor, Long Island City, NY 11101.

**Bid Information:** The Bidder shall complete the bid information set forth below.

Name of Bidder: \_\_\_\_\_  
Bidder's Address: \_\_\_\_\_  
Bidder's Telephone Number: \_\_\_\_\_  
Bidder's Fax Number: \_\_\_\_\_  
Date of Bid Opening: \_\_\_\_\_  
PROJECT ID: \_\_\_\_\_

**Vendex Compliance:** To demonstrate compliance with Vendex requirements, the Bidder shall complete either Section (1) or Section (2) below, whichever applies.

- (1) **Submission of Vendex Questionnaires to MOCS:** By signing in the space provided below, the Bidder certifies that as of the date specified below, the Bidder has submitted Vendex Questionnaires to the Mayor's Office of Contract Services, Attn: VENDEX, 253 Broadway, 9<sup>th</sup> Floor, New York, New York 10007.

Date of Submission: \_\_\_\_\_

By: \_\_\_\_\_  
(Signature of Partner or corporate officer)

Print Name: \_\_\_\_\_

- (2) **Submission of Certification of No Change to DDC:** By signing in the space provided below, the Bidder certifies that it has read the instructions in a "Vendor's Guide to Vendex" and that such instructions do not require the Bidder to submit Vendex Questionnaires. The Bidder has completed **TWO ORIGINALS** of the Certification of No Change set forth on the next page of this Bid Booklet.

By: \_\_\_\_\_  
(Signature of Partner or corporate officer)

Print Name: \_\_\_\_\_

**(NO TEXT ON THIS PAGE)**

# Certificate of No Change Form



- Please submit two completed forms. Copies will not be accepted.
- Please send both copies to the agency that requested it, unless you are advised to send it directly to the Mayor's Office of Contract Services (MOCS).
- A materially false statement willfully or fraudulently made in connection with this certification, and/or the failure to conduct appropriate due diligence in verifying the information that is the subject of this certification, may result in rendering the submitting entity non-responsible for the purpose of contract award.
- A materially false statement willfully or fraudulently made in connection with this certification may subject the person making the false statement to criminal charges

I, \_\_\_\_\_, being duly sworn, state that I have read  
*Enter Your Name*

and understand all the items contained in the vendor questionnaire and any submission of change as identified on page one of this form and certify that as of this date, these items have not changed. I further certify that, to the best of my knowledge, information and belief, those answers are full, complete, and accurate; and that, to the best of my knowledge, information, and belief, those answers continue to be full, complete, and accurate.

In addition, I further certify on behalf of the submitting vendor that the information contained in the principal questionnaire(s) and any submission of change identified on page two of this form have not changed and have been verified and continue, to the best of my knowledge, to be full, complete and accurate.

I understand that the City of New York will rely on the information supplied in this certification as additional inducement to enter into a contract with the submitting entity.

## **Vendor Questionnaire** *This section is required.*

*This refers to the vendor questionnaire(s) submitted for the vendor doing business with the City.*

Name of Submitting Entity: \_\_\_\_\_

Vendor's Address: \_\_\_\_\_

Vendor's EIN or TIN: \_\_\_\_\_ Requesting Agency: \_\_\_\_\_

Are you submitting this Certification as a parent? (Please circle one)    Yes    No

Signature date on the last full vendor questionnaire signed for the submitting vendor: \_\_\_\_\_

Signature date on change submission for the submitting vendor: \_\_\_\_\_

# Principal Questionnaire

This section refers to the most recent principal questionnaire submissions.



Principal Name	Date of signature on last full Principal Questionnaire	Date(s) of signature on submission of change
1		
2		
3		
4		
5		
6		

Check if additional changes were submitted and attach a document with the date of additional submissions.

## Certification *This section is required.*

*This form must be signed and notarized. Please complete this twice. Copies will not be accepted.*

### Certified By:

\_\_\_\_\_  
*Name (Print)*

\_\_\_\_\_  
*Title*

\_\_\_\_\_  
*Name of Submitting Entity*

\_\_\_\_\_  
*Signature*

\_\_\_\_\_  
*Date*

### Notarized By:

\_\_\_\_\_  
*Notary Public*

\_\_\_\_\_  
*County License Issued*

\_\_\_\_\_  
*License Number*

Sworn to before me on: \_\_\_\_\_  
*Date*

## Certificate of No Change Form

- Please submit two completed forms. Copies will not be accepted.
- Please send both copies to the agency that requested it, unless you are advised to send it directly to the Mayor's Office of Contract Services (MOCS).
- A materially false statement willfully or fraudulently made in connection with this certification, and/or the failure to conduct appropriate due diligence in verifying the information that is the subject of this certification, may result in rendering the submitting entity non-responsible for the purpose of contract award.
- A materially false statement willfully or fraudulently made in connection with this certification may subject the person making the false statement to criminal charges

I, \_\_\_\_\_, being duly sworn, state that I have read  
*Enter Your Name*

and understand all the items contained in the vendor questionnaire and any submission of change as identified on page one of this form and certify that as of this date, these items have not changed. I further certify that, to the best of my knowledge, information and belief, those answers are full, complete, and accurate; and that, to the best of my knowledge, information, and belief, those answers continue to be full, complete, and accurate.

In addition, I further certify on behalf of the submitting vendor that the information contained in the principal questionnaire(s) and any submission of change identified on page two of this form have not changed and have been verified and continue, to the best of my knowledge, to be full, complete and accurate.

I understand that the City of New York will rely on the information supplied in this certification as additional inducement to enter into a contract with the submitting entity.

### **Vendor Questionnaire** *This section is required.*

*This refers to the vendor questionnaire(s) submitted for the vendor doing business with the City.*

Name of Submitting Entity: \_\_\_\_\_

Vendor's Address: \_\_\_\_\_

Vendor's EIN or TIN: \_\_\_\_\_ Requesting Agency: \_\_\_\_\_

Are you submitting this Certification as a parent? (Please circle one)    Yes    No

Signature date on the last full vendor questionnaire signed for the submitting vendor: \_\_\_\_\_

Signature date on change submission for the submitting vendor: \_\_\_\_\_



# Principal Questionnaire

*This section refers to the most recent principal questionnaire submissions.*



Principal Name	Date of signature on last full Principal Questionnaire	Date(s) of signature on submission of change
1		
2		
3		
4		
5		
6		

Check if additional changes were submitted and attach a document with the date of additional submissions.

## **Certification** *This section is required.*

*This form must be signed and notarized. Please complete this twice. Copies will not be accepted.*

### **Certified By:**

\_\_\_\_\_  
*Name (Print)*

\_\_\_\_\_  
*Title*

\_\_\_\_\_  
*Name of Submitting Entity*

\_\_\_\_\_  
*Signature*

\_\_\_\_\_  
*Date*

### **Notarized By:**

\_\_\_\_\_  
*Notary Public*

\_\_\_\_\_  
*County License Issued*

\_\_\_\_\_  
*License Number*

Sworn to before me on: \_\_\_\_\_  
*Date*

**BIDDER'S CERTIFICATION OF COMPLIANCE WITH  
IRAN DIVESTMENT ACT**

Pursuant to General Municipal Law §103-g, which generally prohibits the City from entering into contracts with persons engaged in investment activities in the energy sector of Iran, the bidder/proposer submits the following certification:

[Please Check One]

**BIDDER'S CERTIFICATION**

- By submission of this bid or proposal, each bidder/proposer and each person signing on behalf of any bidder/proposer certifies, and in the case of a joint bid each party thereto certifies as to its own organization, under penalty of perjury, that to the best of its knowledge and belief, that each bidder/proposer is not on the list created pursuant to paragraph (b) of subdivision 3 of Section 165-a of the State Finance Law.
- I am unable to certify that my name and the name of the bidder/proposer does not appear on the list created pursuant to paragraph (b) of subdivision 3 of Section 165-a of the State Finance Law. I have attached a signed statement setting forth in detail why I cannot so certify.

  
\_\_\_\_\_  
SIGNATURE  
Michael Thompson  
\_\_\_\_\_  
PRINTED NAME  
President  
\_\_\_\_\_  
TITLE

Sworn to before me this  
12<sup>th</sup> day of April, 2017

  
\_\_\_\_\_  
Notary Public

Dated: 4/12/17 MICHELE RENNA  
NOTARY PUBLIC STATE OF NEW YORK  
No. 01RE6110285  
Qualified in Richmond County  
My Commission Expires May 24, 2020



**THE CITY OF NEW YORK  
DEPARTMENT OF SMALL BUSINESS SERVICES  
DIVISION OF LABOR SERVICES  
CONTRACT COMPLIANCE UNIT  
110 WILLIAMS STREET  
NEW YORK, NEW YORK 10038  
PHONE: (212) 513-6323  
FAX: (212) 618-8879**

**CONSTRUCTION**

**EMPLOYMENT**

**REPORT**

**(NO TEXT ON THIS PAGE)**

The City of New York  
 Department of Small Business Services  
 Division of Labor Services  
 Contract Compliance Unit  
 110 William Street  
 New York, New York 10038  
 Phone: (212) 513 - 6323  
 Fax: (212) 618-8879

**CONSTRUCTION EMPLOYMENT REPORT  
 INSTRUCTIONS**

**WHO MUST FILE A CONSTRUCTION EMPLOYMENT REPORT**

A Construction Employment Report (ER) must be filed if you meet the following conditions:

CONTRACT FUNDING SOURCE	CONTRACTOR	CONTRACT VALUE	SUBMISSION REQUIREMENT
Federal/Federally assisted	Prime and subcontractors	\$10,000 or greater	Construction Employment Report
City and state funded	Prime contractor	\$1,000,000 or greater	
	Subcontractor	\$750,000 or greater	Less than \$750,000 Certificate (City/State Only)
Less than \$750,000			

Prime Contractor:

- A general contractor or construction manager selected to perform work on a construction project funded (in whole or in part) by the federal government with a proposed contract value of \$10,000 or more.
- A general contractor or construction manager selected to perform work on a construction project funded or assisted by the City of New York with a proposed contract value of \$1,000,000 or more.

Subcontractor:

- A subcontractor selected to perform work on a construction project funded (in whole or in part) by the federal government with a proposed contract value of \$10,000 or more.
- A subcontractor selected to perform work on a construction project funded or assisted by the City of New York with a proposed contract value of \$750,000 or more.
- A subcontractor selected to perform work on a construction project funded or assisted by the City of New York with a proposed contract value of less than \$750,000 must submit a "Less than \$750,000" certificate.

**WHERE TO FILE**

Employment Reports must be filed with the City agency awarding the contract. If you are a contractor or subcontractor who will be working for a private developer in receipt of funding or assistance from the City, the ER must be filed with the City agency with jurisdiction over the developer's project.

**DLS REVIEW PROCESS**

In accordance with Executive Order 50 (EO 50), upon receipt by DLS of a completed ER, DLS conducts a review of the contractor's current employment policies, practices and procedures, as well as perform a statistical analysis of the contractor's workforce, if necessary. The process is as follows:

1. Within five (5) business days, DLS will review the ER for completeness and accuracy. If any information is omitted or incorrect, or if necessary documents are not submitted, the submission shall be deemed incomplete and DLS will inform the contractor. The substantive compliance review does not commence until the submission is complete. An incomplete submission will delay the review process and may preclude or interrupt the contract approval.
2. If the ER submission is complete, the compliance review will proceed, resulting in one of the following:

**Certificate of Approval**

The contractor is found to be in compliance with all applicable laws and regulations. The approval is valid for 36 months.

**Continued Approval Certificate**

The contractor has been issued a Certificate of Approval in the previous 36 months which is good for the applicable contract.

**Conditional Certificate of Compliance**

The contractor is required to take corrective actions in order to be in compliance with EO 50. The contractor must meet the conditions within one month of the issue of the Conditional Certificate.

**Determination of Nonperformance**

The contractor has failed to take the required corrective actions stipulated in the Conditional Certificate. A determination of nonperformance may prevent a contractor from receiving an award of a contract.

## HOW TO COMPLETE THE EMPLOYMENT REPORT

### Contents

**General Information**

**Part I: Contractor/Subcontractor Information**

**Part II: Employment Policies and Practices**

**Part III: Contract Bid Information and Projected and Current Workforce Forms**

**Signature Page**

### PART I: CONTRACTOR/SUBCONTRACTOR INFORMATION

- Questions 7 – 11: Please provide the required contact information for your company. All contracts must have a designated Equal Employment Officer.
- Question 12: If you are a subcontractor, you must state the name of the contractor for whom you are providing the construction services.
- Question 13: Please provide the number of permanent employees in your company.
- Question 14a-g: The Project Identification Number (PIN) and the Contract Registration ID Number (CT#) can be obtained from the City agency. Provide a description of the trade work you will perform on this project and the address where the work will be performed. Subcontractors can obtain this information from the contract they have with the prime contractor.
- Questions 15 – 18: If your company has received a valid Certificate of Approval within the past 36 months, been audited by the United States Department of Labor, Office of Federal Contract Compliance Programs (OFCCP), or if your company has submitted an ER for a different contract for which you have not yet received a compliance certificate, then you only need to complete and submit the following:
- General Information section
  - Part I - Contractor/Subcontractor Information
  - Form B - Projected Workforce
  - Signature Page

If your company is currently waiting for an approval on another contract previously submitted, be certain to identify the date on which you submitted the completed Employment Report, the name of the City contracting agency with which the contract was made, and the name and telephone number of the person to whom the Employment Report was submitted.

If your company was issued a Conditional Certificate of Approval, all required corrective actions must have been taken or DLS will not issue a Continued Certificate.

- Question 18: If the company was audited by the OFCCP, also provide the following:
- Identify the reviewing OFCCP office by its name and address
  - If an unconditional certificate of compliance was issued by the OFCCP, attach a copy of the certificate in lieu of completing Parts II and III;
  - Include copies of all corrective actions and documentation of OFCCP's performance; and
  - Provide a copy of all stated OFCCP findings.

- Question 19: Please provide a copy of any Collective Bargaining Agreement(s) which is negotiated through an employer trade association on behalf of your organization or any of its affiliates.

**PART II: EMPLOYMENT POLICIES AND PRACTICES**

*Remember to label all documents with the question number for which they are submitted.*

Questions 20a – j: You must respond to the questions as to whether or not your firm has documents reflecting written policies, benefits and procedures. If so, then you must identify by name each document in which the policy(ies), procedure(s) and benefit(s) is located and submit copies of all of the document(s). If your firm follows unwritten practices or procedures, include an explanation of how they operate. Please submit the most current document(s), including all applicable amendments. Label each document and/or unwritten practice according to the question to which it corresponds (e.g. 20a, 20b, etc.)

Questions 21a – h: Inquires about the manner/methods by which you comply with the requirements of the Immigration Reform and Control Act of 1986 (IRCA).

Question 22: Inquires into where and how I-9 forms are maintained and stored.

Questions 23a – e: Inquires into whether or not there is a requirement that an applicant or employee be subjected to a medical examination at any given time. Copies of the medical information questionnaire and instructions must be submitted with the Employment Report.

Question 24: Indicate the existence and location of all statements of your firm's Equal Employment Opportunity policy and attach a copy of each statement.

Question 25: Submit any current Affirmative Action Plan(s) created pursuant to Executive Order 11246.

Question 26: If your firm or collective bargaining agreement has an internal grievance procedure, indicate this and submit a copy of the policy and procedure. If unwritten, explain its nature and operation. Explain how your firm's procedure addresses EEO complaints.

Question 27: If your employees have used the procedure in the last three (3) years, please submit an explanation in the format indicated below:

1. Number of complaint(s)	2. Nature of the complaint(s)	3. Position(s) of the complainant(s)	4. Was an investigation conducted? Y/N	5. Current status of the disposition
---------------------------	-------------------------------	--------------------------------------	---	--------------------------------------



Question 28: Indicate whether in the past three (3) years complaints have been filed with a court of law or administrative agency, naming your company as a defendant (or respondent) in a complaint alleging violation of any anti-discrimination or affirmative action laws. If yes, develop and submit a log to show, for each administrative/and or judicial action filed, the following information:

1. Name(s) of complainant(s)	2. Administrative agency or court in which action was filed	3. Nature of the complaint(s)	4. Current status	5. If not pending, the complaint's disposition
------------------------------	---	-------------------------------	-------------------	--

Question 29: Identify each job for which a physical qualification exists. Identify and explain the physical qualification(s) for each stated job. Submit job descriptions for each job and the reasons for the qualifications.

Question 30: Identify each job for which there exists any qualification related to age, race, color, national origin, sex, creed, disability, marital status, sexual orientation or citizenship status. Identify and explain the specific related qualification for each job stated. Submit job descriptions for each job and the reasons for the qualifications.

**PART III: CONTRACT BID INFORMATION AND PROJECTED AND CURRENT WORKFORCE FORMS**

**FORM A: CONTRACT BID INFORMATION – USE OF SUBCONTRACTORS/TRADES**

Your projections for the utilization of subcontractors on the proposed contract are to be provided in this section. A chart has been provided for the identification of subcontractors. Information is to be provided to the extent known at the time the ER is filed for review by DLS. If the subcontractor's name is unknown, then write "unknown". Under "ownership", enter the appropriate race/ethnic and gender code. If the contract is federally funded or assisted and the subcontractor is being utilized in accordance with applicable federal requirements with respect to Minority Business Enterprise or Woman Business Enterprise requirements, enter the appropriate code. This will also apply to state funded contracts with similar requirements for minority and female owned businesses.

**FORM B: PROJECTED WORKFORCE FOR WORK TO BE PERFORMED ON THIS PROJECT**

For each trade to be engaged by your company for this project, enter the projected workforce for Males and Females by trade classification in the charts provided.

**FORM C: CURRENT WORKFORCE FOR WORK TO BE PERFORMED ON THIS PROJECT**

For each trade *currently* engaged by your company for all work performed in NYC, enter the current workforce for Males and Females by trade classification in the charts provided.

**SIGNATURE PAGE**

The signatory of this Employment Report and all other documents submitted to DLS must be an official authorized to enter into a binding legal agreement. The signature page must be completed in its entirety and notarized. Only original signatures will be accepted.

The City of New York Department of Small Business Services  
Division of Labor Services Contract Compliance Unit  
110 William Street, New York, New York 10038  
Phone: (212) 513 - 6323  
Fax: (212) 618-8879

**CONSTRUCTION EMPLOYMENT REPORT**

**GENERAL INFORMATION**

1. Your contractual relationship in this contract is: Prime contractor  Subcontractor
- 1a. Are M/WBE goals attached to this project? Yes  No
2. Please check one of the following if your firm would like information on how to certify with the City of New York as a:  
 Minority Owned Business Enterprise                       Locally Based Business Enterprise  
 Women Owned Business Enterprise                       Emerging Business Enterprise  
 Disadvantaged Business Enterprise
- 2a. If you are certified as an **MBE, WBE, LBE, EBE** or **DBE**, what city/state agency are you certified with? \_\_\_\_\_ Are you DBE certified? Yes  No
3. Please indicate if you would like assistance from SBS in identifying certified M/WBEs for contracting opportunities: Yes  No
4. Is this project subject to a project labor agreement? Yes  No
5. Are you a Union contractor? Yes  No  If yes, please list which local(s) you affiliated with \_\_\_\_\_
6. Are you a Veteran owned company? Yes  No

**PART I: CONTRACTOR/SUBCONTRACTOR INFORMATION**

7. \_\_\_\_\_  
Employer Identification Number or Federal Tax I.D. Email Address
8. \_\_\_\_\_  
Company Name
9. \_\_\_\_\_  
Company Address and Zip Code
10. \_\_\_\_\_  
Chief Operating Officer Telephone Number
11. \_\_\_\_\_  
Designated Equal Opportunity Compliance Officer Telephone Number  
(If same as Item #10, write "same")
12. \_\_\_\_\_  
Name of Prime Contractor and Contact Person  
(If same as Item #8, write "same")

13. Number of employees in your company: \_\_\_\_\_

14. Contract information:

(a) \_\_\_\_\_ (b) \_\_\_\_\_  
Contracting Agency (City Agency) Contract Amount

(c) \_\_\_\_\_ (d) \_\_\_\_\_  
Procurement Identification Number (PIN) Contract Registration Number (CT#)

(e) \_\_\_\_\_ (f) \_\_\_\_\_  
Projected Commencement Date Projected Completion Date

(g) Description and location of proposed contract:

\_\_\_\_\_  
\_\_\_\_\_

15. Has your firm been reviewed by the Division of Labor Services (DLS) within the past 36 months and issued a Certificate of Approval? Yes\_\_\_ No\_\_\_

If yes, attach a copy of certificate.

16. Has DLS within the past month reviewed an Employment Report submission for your company and issued a Conditional Certificate of Approval? Yes\_\_\_ No\_\_\_

If yes, attach a copy of certificate.

**NOTE: DLS WILL NOT ISSUE A CONTINUED CERTIFICATE OF APPROVAL IN CONNECTION WITH THIS CONTRACT UNLESS THE REQUIRED CORRECTIVE ACTIONS IN PRIOR CONDITIONAL CERTIFICATES OF APPROVAL HAVE BEEN TAKEN.**

17. Has an Employment Report already been submitted for a different contract (not covered by this Employment Report) for which you have not yet received compliance certificate?  
Yes\_\_\_ No\_\_\_ If yes,

Date submitted: \_\_\_\_\_

Agency to which submitted: \_\_\_\_\_

Name of Agency Person: \_\_\_\_\_

Contract No: \_\_\_\_\_

Telephone: \_\_\_\_\_

18. Has your company in the past 36 months been audited by the United States Department of Labor, Office of Federal Contract Compliance Programs (OFCCP)? Yes\_\_\_ No\_\_\_

If yes,

(a) Name and address of OFCCP office.

---

---

(b) Was a Certificate of Equal Employment Compliance issued within the past 36 months?  
Yes\_\_\_ No\_\_\_

If yes, attach a copy of such certificate.

(c) Were any corrective actions required or agreed to? Yes\_\_\_ No\_\_\_

If yes, attach a copy of such requirements or agreements.

(d) Were any deficiencies found? Yes\_\_\_ No\_\_\_

If yes, attach a copy of such findings.

19. Is your company or its affiliates a member or members of an employers' trade association which is responsible for negotiating collective bargaining agreements (CBA) which affect construction site hiring? Yes\_\_\_ No\_\_\_

If yes, attach a list of such associations and all applicable CBA's.

## PART II: DOCUMENTS REQUIRED

20. For the following policies or practices, attach the relevant documents (e.g., printed booklets, brochures, manuals, memoranda, etc.). If the policy(ies) are unwritten, attach a full explanation of the practices. See instructions.

- \_\_\_ (a) Health benefit coverage/description(s) for all management, nonunion and union employees (whether company or union administered)
- \_\_\_ (b) Disability, life, other insurance coverage/description
- \_\_\_ (c) Employee Policy/Handbook
- \_\_\_ (d) Personnel Policy/Manual
- \_\_\_ (e) Supervisor's Policy/Manual
- \_\_\_ (f) Pension plan or 401k coverage/description for all management, nonunion and union employees, whether company or union administered
- \_\_\_ (g) Collective bargaining agreement(s).
- \_\_\_ (h) Employment Application(s)
- \_\_\_ (i) Employee evaluation policy/form(s).
- \_\_\_ (j) Does your firm have medical and/or non-medical (i.e. education, military, personal, pregnancy, child care) leave policy?

21. To comply with the Immigration Reform and Control Act of 1986 when and of whom does your firm require the completion of an I-9 Form?

- |  |                |
|--|----------------|
| (a) Prior to job offer                     | Yes ___ No ___ |
| (b) After a conditional job offer          | Yes ___ No ___ |
| (c) After a job offer                      | Yes ___ No ___ |
| (d) Within the first three days on the job | Yes ___ No ___ |
| (e) To some applicants                     | Yes ___ No ___ |
| (f) To all applicants                      | Yes ___ No ___ |
| (g) To some employees                      | Yes ___ No ___ |
| (h) To all employees                       | Yes ___ No ___ |

22. Explain where and how completed I-9 Forms, with their supportive documentation, are maintained and made accessible.

\_\_\_\_\_

23. Does your firm or any of its collective bargaining agreements require job applicants to take a medical examination? Yes \_\_\_ No \_\_\_

If yes, is the medical examination given:

- |                                   |                |
|-----------------------------------|----------------|
| (a) Prior to a job offer          | Yes ___ No ___ |
| (b) After a conditional job offer | Yes ___ No ___ |
| (c) After a job offer             | Yes ___ No ___ |
| (d) To all applicants             | Yes ___ No ___ |
| (e) Only to some applicants       | Yes ___ No ___ |

If yes, list for which applicants below and attach copies of all medical examination or questionnaire forms and instructions utilized for these examinations.

\_\_\_\_\_

24. Do you have a written equal employment opportunity (EEO) policy? Yes \_\_\_ No \_\_\_

If yes, list the document(s) and page number(s) where these written policies are located.

\_\_\_\_\_

25. Does the company have a current affirmative action plan(s) (AAP)

- \_\_\_ Minorities and Women  
\_\_\_ Individuals with handicaps  
\_\_\_ Other. Please specify \_\_\_\_\_

26. Does your firm or collective bargaining agreement(s) have an internal grievance procedure with respect to EEO complaints? Yes \_\_\_ No \_\_\_

If yes, please attach a copy of this policy.

If no, attach a report detailing your firm's unwritten procedure for handling EEO complaints.

27. Has any employee, within the past three years, filed a complaint pursuant to an internal grievance procedure or with any official of your firm with respect to equal employment opportunity? Yes\_\_\_ No\_\_\_

If yes, attach an internal complaint log. See instructions.

28. Has your firm, within the past three years, been named as a defendant (or respondent) in any administrative or judicial action where the complainant (plaintiff) alleged violation of any anti-discrimination or affirmative action laws? Yes\_\_\_ No\_\_\_

If yes, attach a log. See instructions.

29. Are there any jobs for which there are physical qualifications? Yes\_\_\_ No\_\_\_

If yes, list the job(s), submit a job description and state the reason(s) for the qualification(s).

---

30. Are there any jobs for which there are age, race, color, national origin, sex, creed, disability, marital status, sexual orientation, or citizenship qualifications? Yes\_\_\_ No\_\_\_

If yes, list the job(s), submit a job description and state the reason(s) for the qualification(s).

---

**SIGNATURE PAGE**

I, (print name of authorized official signing) \_\_\_\_\_ hereby certify that the information submitted herewith is true and complete to the best of my knowledge and belief and submitted with the understanding that compliance with New York City's equal employment requirements, as contained in Chapter 56 of the City Charter, Executive Order No. 50 (1980), as amended, and the implementing Rules and Regulations, is a contractual obligation. I also agree on behalf of the company to submit a certified copy of payroll records to the Division of Labor Services on a monthly basis.

\_\_\_\_\_  
Contractor's Name

\_\_\_\_\_  
Name of person who prepared this Employment Report

\_\_\_\_\_  
Title

\_\_\_\_\_  
Name of official authorized to sign on behalf of the contractor

\_\_\_\_\_  
Title

\_\_\_\_\_  
Telephone Number

\_\_\_\_\_  
Signature of authorized official

\_\_\_\_\_  
Date

If contractors are found to be underutilizing minorities and females in any given trade based on Chapter 56 Section 3H, the Division of Labor Services reserves the right to request the contractor's workforce data and to implement an employment program.

Contractors who fail to comply with the above mentioned requirements or are found to be in noncompliance may be subject to the withholding of final payment.

Willful or fraudulent falsifications of any data or information submitted herewith may result in the termination of the contract between the City and the bidder or contractor and in disapproval of future contracts for a period of up to five years. Further, such falsification may result in civil and/or criminal prosecution.

To the extent permitted by law and consistent with the proper discharge of DLS' responsibilities under Charter Chapter 56 of the City Charter and Executive Order No. 50 (1980) and the implementing Rules and Regulations, all information provided by a contractor to DLS shall be confidential.

**Only original signatures accepted.**

Sworn to before me this \_\_\_\_\_ day of \_\_\_\_\_ 20 \_\_\_\_\_

\_\_\_\_\_  
Notary Public

\_\_\_\_\_  
Authorized Signature

\_\_\_\_\_  
Date

**FORM A. CONTRACT BID INFORMATION: USE OF SUBCONTRACTORS/TRADES**

1. Do you plan to subcontract work on this contract? Yes  No
2. If yes, complete the chart below.

**NOTE: All proposed subcontractors with a subcontract in excess of \$750,000 must complete an Employment Report for review and approval before the contract may be awarded and work commences.**

SUBCONTRACTOR'S NAME*	OWNERSHIP (ENTER APPROPRIATE CODE LETTERS BELOW)	WORK TO BE PERFORMED BY SUBCONTRACTOR	TRADE PROJECTED FOR USE BY SUBCONTRACTOR	PROJECTED DOLLAR VALUE OF SUBCONTRACT

\*If subcontractor is presently unknown, please enter the trade (craft name).

**OWNERSHIP CODES**

- W: White
- B: Black
- H: Hispanic
- A: Asian
- N: Native American
- F: Female



**FORM B: PROJECTED WORKFORCE**

**TRADE CLASSIFICATION CODES**

- (J) Journeylevel Workers
- (H) Helper
- (TOT) Total by Column
- (A) Apprentice (TRN) Trainee

For each trade to be engaged by your company for this project, enter the projected workforce for Males and Females by trade classification on the charts below.

Trade:	MALES					FEMALES				
	(1) White Non Hisp.	(2) Black Non Hisp.	(3) Hisp.	(4) Asian	(5) Native Amer.	(6) White Non Hisp.	(7) Black Non Hisp.	(8) Hisp.	(9) Asian	(10) Native Amer.
J										
H										
A										
TRN										
TOT										

Total (Col. #1-10):

Total Minority, Male & Female (Col. #2,3,4,5,7,8,9, & 10):

Total Female (Col. #6 - 10):

What are the recruitment sources for you projected hires (i.e., unions, government employment office, job tap center, community outreach)?

**FORM B: PROJECTED WORKFORCE**

Trade: \_\_\_\_\_

Union Affiliation, if applicable \_\_\_\_\_

Total (Col. #1-10): \_\_\_\_\_

Total Minority, Male & Female  
(Col. #2,3,4,5,7,8,9, & 10): \_\_\_\_\_

Total Female  
(Col. #6 - 10): \_\_\_\_\_

	MALES					FEMALES				
	(1) White Non- Hisp.	(2) Black Non- Hisp.	(3) Hisp.	(4) Asian	(5) Native Amer.	(6) White Non- Hisp.	(7) Black Non- Hisp.	(8) Hisp.	(9) Asian	(10) Native Amer.
J										
H										
A										
TRN										
TOT										

What are the recruitment sources for you projected hires (i.e., unions, government employment office, job tap center, community outreach)?

---



---



---

**FORM C: CURRENT WORKFORCE**

**TRADE CLASSIFICATION CODES**

- (J) Journeylevel Workers
- (H) Helper
- (TOT) Total by Column
- (A) Apprentice
- (TRN) Trainee

For each trade currently engaged by your company for all work performed in New York City, enter the current workforce for Males and Females by trade classification on the charts below.

Trade:	MALES					FEMALES				
	(1) White Non Hisp.	(2) Black Non Hisp.	(3) Hisp.	(4) Asian	(5) Native Amer.	(6) White Non Hisp.	(7) Black Non Hisp.	(8) Hisp.	(9) Asian	(10) Native Amer.
J										
H										
A										
TRN										
TOT										

Trade: \_\_\_\_\_

Union Affiliation, if applicable \_\_\_\_\_

Total (Col. #1-10): \_\_\_\_\_

Total Minority, Male & Female  
(Col. #2,3,4,5,7,8,9, & 10): \_\_\_\_\_

Total Female  
(Col. #6 - 10): \_\_\_\_\_

What are the recruitment sources for you projected hires (i.e., unions, government employment office, job tap center, community outreach)?

---



---

**FORM C: CURRENT WORKFORCE**

Trade: \_\_\_\_\_

Union Affiliation, if applicable \_\_\_\_\_

Total (Col. #1-10): \_\_\_\_\_

Total Minority, Male & Female  
(Col. #2,3,4,5,7,8,9, & 10): \_\_\_\_\_

Total Female  
(Col. #6 - 10): \_\_\_\_\_

	MALES					FEMALES				
	(1) White Non Hisp.	(2) Black Non Hisp.	(3) Hisp.	(4) Asian	(5) Native Amer.	(6) White Non Hisp.	(7) Black Non Hisp.	(8) Hisp.	(9) Asian	(10) Native Amer.
J										
H										
A										
TRN										
TOT										

What are the recruitment sources for you projected hires (i.e., unions, government employment office, job tap center, community outreach)?

---



---



---

(NO TEXT ON THIS PAGE)

The City of New York Department of Small Business Services  
Division of Labor Services Contract Compliance Unit  
110 William Street, New York, New York 10038  
Phone: (212) 513 - 6323  
Fax: (212) 618-8879

### CONSTRUCTION EMPLOYMENT REPORT

#### GENERAL INFORMATION

1. Your contractual relationship in this contract is: Prime contractor \_\_\_ Subcontractor x
- 1a. Are M/WBE goals attached to this project? Yes \_\_\_ No \_\_\_
2. Please check one of the following if your firm would like information on how to certify with the City of New York as a:  

<input type="checkbox"/> Minority Owned Business Enterprise	<input type="checkbox"/> Locally Based Business Enterprise
<input type="checkbox"/> Women Owned Business Enterprise	<input type="checkbox"/> Emerging Business Enterprise
<input type="checkbox"/> Disadvantaged Business Enterprise	
- 2a. If you are certified as an **MBE, WBE, LBE, EBE** or **DBE**, what city/state agency are you certified with? \_\_\_\_\_ Are you DBE certified? Yes \_\_\_ No \_\_\_
3. Please indicate if you would like assistance from SBS in identifying certified M/WBEs for contracting opportunities: Yes \_\_\_ No \_\_\_
4. Is this project subject to a project labor agreement? Yes \_\_\_ No \_\_\_
5. Are you a Union contractor? Yes \_\_\_ No \_\_\_ If yes, please list which local(s) you affiliated with \_\_\_\_\_
6. Are you a Veteran owned company? Yes \_\_\_ No \_\_\_

#### PART I: CONTRACTOR/SUBCONTRACTOR INFORMATION

7. \_\_\_\_\_  
Employer Identification Number or Federal Tax I.D. Email Address
8. \_\_\_\_\_  
Company Name
9. \_\_\_\_\_  
Company Address and Zip Code
10. \_\_\_\_\_  
Chief Operating Officer Telephone Number
11. \_\_\_\_\_  
Designated Equal Opportunity Compliance Officer Telephone Number  
(If same as Item #10, write "same")
12. \_\_\_\_\_  
Name of Prime Contractor and Contact Person  
(If same as Item #8, write "same")

13. Number of employees in your company: \_\_\_\_\_

14. Contract information:

(a) \_\_\_\_\_ (b) \_\_\_\_\_  
Contracting Agency (City Agency) Contract Amount

(c) \_\_\_\_\_ (d) \_\_\_\_\_  
Procurement Identification Number (PIN) Contract Registration Number (CT#)

(e) \_\_\_\_\_ (f) \_\_\_\_\_  
Projected Commencement Date Projected Completion Date

(g) Description and location of proposed contract:

\_\_\_\_\_  
\_\_\_\_\_

15. Has your firm been reviewed by the Division of Labor Services (DLS) within the past 36 months and issued a Certificate of Approval? Yes \_\_\_ No \_\_\_

If yes, attach a copy of certificate.

16. Has DLS within the past month reviewed an Employment Report submission for your company and issued a Conditional Certificate of Approval? Yes \_\_\_ No \_\_\_

If yes, attach a copy of certificate.

**NOTE: DLS WILL NOT ISSUE A CONTINUED CERTIFICATE OF APPROVAL IN CONNECTION WITH THIS CONTRACT UNLESS THE REQUIRED CORRECTIVE ACTIONS IN PRIOR CONDITIONAL CERTIFICATES OF APPROVAL HAVE BEEN TAKEN.**

17. Has an Employment Report already been submitted for a different contract (not covered by this Employment Report) for which you have not yet received compliance certificate?  
Yes \_\_\_ No \_\_\_ If yes,

Date submitted: \_\_\_\_\_

Agency to which submitted: \_\_\_\_\_

Name of Agency Person: \_\_\_\_\_

Contract No: \_\_\_\_\_

Telephone: \_\_\_\_\_

18. Has your company in the past 36 months been audited by the United States Department of Labor, Office of Federal Contract Compliance Programs (OFCCP)? Yes \_\_\_ No \_\_\_

If yes,

(a) Name and address of OFCCP office.

\_\_\_\_\_  
\_\_\_\_\_

(b) Was a Certificate of Equal Employment Compliance issued within the past 36 months?  
Yes\_\_\_ No\_\_\_

If yes, attach a copy of such certificate.

(c) Were any corrective actions required or agreed to? Yes\_\_\_ No\_\_\_

If yes, attach a copy of such requirements or agreements.

(d) Were any deficiencies found? Yes\_\_\_ No\_\_\_

If yes, attach a copy of such findings.

19. Is your company or its affiliates a member or members of an employers' trade association which is responsible for negotiating collective bargaining agreements (CBA) which affect construction site hiring? Yes\_\_\_ No\_\_\_

If yes, attach a list of such associations and all applicable CBA's.

## PART II: DOCUMENTS REQUIRED

20. For the following policies or practices, attach the relevant documents (e.g., printed booklets, brochures, manuals, memoranda, etc.). If the policy(ies) are unwritten, attach a full explanation of the practices. See instructions.

- \_\_\_ (a) Health benefit coverage/description(s) for all management, nonunion and union employees (whether company or union administered).
- \_\_\_ (b) Disability, life, other insurance coverage/description
- \_\_\_ (c) Employee Policy/Handbook
- \_\_\_ (d) Personnel Policy/Manual
- \_\_\_ (e) Supervisor's Policy/Manual
- \_\_\_ (f) Pension plan or 401k coverage/description for all management, nonunion and union employees, whether company or union administered
- \_\_\_ (g) Collective bargaining agreement(s).
- \_\_\_ (h) Employment Application(s)
- \_\_\_ (i) Employee evaluation policy/form(s).
- \_\_\_ (j) Does your firm have medical and/or non-medical (i.e. education, military, personal, pregnancy, child care) leave policy?



21. To comply with the Immigration Reform and Control Act of 1986 when and of whom does your firm require the completion of an I-9 Form?

- |  |                |
|--|----------------|
| (a) Prior to job offer                     | Yes ___ No ___ |
| (b) After a conditional job offer          | Yes ___ No ___ |
| (c) After a job offer                      | Yes ___ No ___ |
| (d) Within the first three days on the job | Yes ___ No ___ |
| (e) To some applicants                     | Yes ___ No ___ |
| (f) To all applicants                      | Yes ___ No ___ |
| (g) To some employees                      | Yes ___ No ___ |
| (h) To all employees                       | Yes ___ No ___ |

22. Explain where and how completed I-9 Forms, with their supportive documentation, are maintained and made accessible.

---

---

23. Does your firm or any of its collective bargaining agreements require job applicants to take a medical examination? Yes \_\_\_ No \_\_\_

If yes, is the medical examination given:

- |                                   |                |
|-----------------------------------|----------------|
| (a) Prior to a job offer          | Yes ___ No ___ |
| (b) After a conditional job offer | Yes ___ No ___ |
| (c) After a job offer             | Yes ___ No ___ |
| (d) To all applicants             | Yes ___ No ___ |
| (e) Only to some applicants       | Yes ___ No ___ |

If yes, list for which applicants below and attach copies of all medical examination or questionnaire forms and instructions utilized for these examinations.

---

---

24. Do you have a written equal employment opportunity (EEO) policy? Yes \_\_\_ No \_\_\_

If yes, list the document(s) and page number(s) where these written policies are located.

---

---

25. Does the company have a current affirmative action plan(s) (AAP)

- \_\_\_ Minorities and Women  
\_\_\_ Individuals with handicaps  
\_\_\_ Other. Please specify \_\_\_\_\_

26. Does your firm or collective bargaining agreement(s) have an internal grievance procedure with respect to EEO complaints? Yes \_\_\_ No \_\_\_

If yes, please attach a copy of this policy.

If no, attach a report detailing your firm's unwritten procedure for handling EEO complaints.

27. Has any employee, within the past three years, filed a complaint pursuant to an internal grievance procedure or with any official of your firm with respect to equal employment opportunity? Yes\_\_\_ No\_\_\_

If yes, attach an internal complaint log. See instructions.

28. Has your firm, within the past three years, been named as a defendant (or respondent) in any administrative or judicial action where the complainant (plaintiff) alleged violation of any anti-discrimination or affirmative action laws? Yes\_\_\_ No\_\_\_

If yes, attach a log. See instructions.

29. Are there any jobs for which there are physical qualifications? Yes\_\_\_ No\_\_\_

If yes, list the job(s), submit a job description and state the reason(s) for the qualification(s).

---

---

30. Are there any jobs for which there are age, race, color, national origin, sex, creed, disability, marital status, sexual orientation, or citizenship qualifications? Yes\_\_\_ No\_\_\_

If yes, list the job(s), submit a job description and state the reason(s) for the qualification(s).

---

---

**SIGNATURE PAGE**

I, (print name of authorized official signing) \_\_\_\_\_ hereby certify that the information submitted herewith is true and complete to the best of my knowledge and belief and submitted with the understanding that compliance with New York City's equal employment requirements, as contained in Chapter 56 of the City Charter, Executive Order No. 50 (1980), as amended, and the implementing Rules and Regulations, is a contractual obligation. I also agree on behalf of the company to submit a certified copy of payroll records to the Division of Labor Services on a monthly basis.

\_\_\_\_\_  
Contractor's Name

\_\_\_\_\_  
Name of person who prepared this Employment Report

\_\_\_\_\_  
Title

\_\_\_\_\_  
Name of official authorized to sign on behalf of the contractor

\_\_\_\_\_  
Title

\_\_\_\_\_  
Telephone Number

\_\_\_\_\_  
Signature of authorized official

\_\_\_\_\_  
Date

If contractors are found to be underutilizing minorities and females in any given trade based on Chapter 56 Section 3H, the Division of Labor Services reserves the right to request the contractor's workforce data and to implement an employment program.

Contractors who fail to comply with the above mentioned requirements or are found to be in noncompliance may be subject to the withholding of final payment.

Willful or fraudulent falsifications of any data or information submitted herewith may result in the termination of the contract between the City and the bidder or contractor and in disapproval of future contracts for a period of up to five years. Further, such falsification may result in civil and/or criminal prosecution.

To the extent permitted by law and consistent with the proper discharge of DLS' responsibilities under Charter Chapter 56 of the City Charter and Executive Order No. 50 (1980) and the implementing Rules and Regulations, all information provided by a contractor to DLS shall be confidential.

**Only original signatures accepted.**

Sworn to before me this \_\_\_\_\_ day of \_\_\_\_\_ 20 \_\_\_\_\_

\_\_\_\_\_  
Notary Public

\_\_\_\_\_  
Authorized Signature

\_\_\_\_\_  
Date

**FORM A. CONTRACT BID INFORMATION: USE OF SUBCONTRACTORS/TRADES**

1. Do you plan to subcontractor work on this contract? Yes \_\_\_ No \_\_\_
2. If yes, complete the chart below.

**NOTE: All proposed subcontractors with a subcontract in excess of \$750,000 must complete an Employment Report for review and approval before the contract may be awarded and work commences.**

SUBCONTRACTOR'S NAME*	OWNERSHIP (ENTER APPROPRIATE CODE LETTERS BELOW)	WORK TO BE PERFORMED BY SUBCONTRACTOR	TRADE PROJECTED FOR USE BY SUBCONTRACTOR	PROJECTED DOLLAR VALUE OF SUBCONTRACT

\*If subcontractor is presently unknown, please enter the trade (craft name).

**OWNERSHIP CODES**

- W: White
- B: Black
- H: Hispanic
- A: Asian
- N: Native American
- F: Female

**FORM B: PROJECTED WORKFORCE**

**TRADE CLASSIFICATION CODES**

- (J) Journey/level Workers
- (H) Helper
- (A) Apprentice
- (TRN) Trainee
- (TOT) Total by Column

For each trade to be engaged by your company for this project, enter the projected workforce for Males and Females by trade classification on the charts below.

Trade:	MALES					FEMALES				
	(1) White Non Hisp.	(2) Black Non Hisp.	(3) Hisp.	(4) Asian	(5) Native Amer.	(6) White Non Hisp.	(7) Black Non Hisp.	(8) Hisp.	(9) Asian	(10) Native Amer.
J										
H										
A										
TRN										
TOT										

Total (Col. #1-10):

Total Minority, Male & Female  
(Col. #2,3,4,5,7,8,9, & 10):

Total Female  
(Col. #6 - 10):

What are the recruitment sources for you projected hires (i.e., unions, government employment office, job tap center, community outreach)?

---



---

**FORM B: PROJECTED WORKFORCE**

Trade:	MALES					FEMALES				
	(1)	(2)	(3)	(4)	(5)	(6)	(7)	(8)	(9)	(10)
	White Non Hisp.	Black Non Hisp.	Hisp.	Asian	Native Amer.	White Non Hisp.	Black Non Hisp.	Hisp.	Asian	Native Amer.
J										
H										
A										
TRN										
TOT										

Union Affiliation, if applicable

Total (Col. #1-10):

Total Minority, Male & Female  
(Col. #2,3,4,5,7,8,9, & 10):

Total Female  
(Col. #6 - 10):

What are the recruitment sources for you projected hires (i.e., unions, government employment office, job tap center, community outreach)?

**FORM C: CURRENT WORKFORCE**

**TRADE CLASSIFICATION CODES**

- (J) Journeylevel Workers
- (H) Helper
- (TOT) Total by Column
- (A) Apprentice
- (TRN) Trainee

For each trade currently engaged by your company for all work performed in New York City, enter the current workforce for Males and Females by trade classification on the charts below.

Trade:	MALES					FEMALES				
	(1)	(2)	(3)	(4)	(5)	(6)	(7)	(8)	(9)	(10)
	White Non Hisp.	Black Non Hisp.	Hisp.	Asian	Native Amer.	White Non Hisp.	Black Non Hisp.	Hisp.	Asian	Native Amer.
J										
H										
A										
TRN										
TOT										

Total (Col. #1-10): \_\_\_\_\_

Total Minority, Male & Female  
(Col. #2, 3, 4, 5, 7, 8, 9, & 10): \_\_\_\_\_

Total Female  
(Col. #6 - 10): \_\_\_\_\_

What are the recruitment sources for you projected hires (i.e., unions, government employment office, job tap center, community outreach)?

---



---

**FORM C: CURRENT WORKFORCE**

Trade: \_\_\_\_\_

Union Affiliation, if applicable \_\_\_\_\_

Total (Col. #1-10): \_\_\_\_\_

Total Minority, Male & Female  
(Col. #2,3,4,5,7,8,9, & 10): \_\_\_\_\_

Total Female  
(Col. #6 - 10): \_\_\_\_\_

	MALES					FEMALES				
	(1)	(2)	(3)	(4)	(5)	(6)	(7)	(8)	(9)	(10)
	White Non Hisp.	Black Non Hisp.	Hisp.	Asian	Native Amer.	White Non Hisp.	Black Non Hisp.	Hisp.	Asian	Native Amer.
J										
H										
A										
TRN										
TOT										

What are the recruitment sources for you projected hires (i.e., unions, government employment office, job tap center, community outreach)?



(NO TEXT ON THIS PAGE)

The City of New York Department of Small Business Services  
Division of Labor Services Contract Compliance Unit  
110 William Street, New York, New York 10038  
Phone: (212) 513 - 6323 Fax: (212) 618-8879

Date \_\_\_\_\_

File Number \_\_\_\_\_

**LESS THAN \$750,000 SUBCONTRACT CERTIFICATE  
(CITY, STATE AND ICIP ONLY)**

Are you currently certified as one of the following? Please check yes or no:

MBE Yes \_\_\_ No \_\_\_      WBE Yes \_\_\_ No \_\_\_      LBE Yes \_\_\_ No \_\_\_

DBE Yes \_\_\_ No \_\_\_      EBE Yes \_\_\_ No \_\_\_

If you are certified as an MBE, WBE, LBE, EBE or DBE, what city/state agency are you certified with?

\_\_\_\_\_

Please check one of the following if your firm would like information on how to certify with the City of New York as a:

\_\_\_ Minority Owned Business Enterprise

\_\_\_ Locally based Business Enterprise

\_\_\_ Women Owned Business Enterprise

\_\_\_ Emerging Business Enterprise

\_\_\_ Disadvantaged Business Enterprise

Company Name \_\_\_\_\_

Employer Identification Number or Federal Tax I.D. \_\_\_\_\_

Company Address and Zip Code \_\_\_\_\_

Contact Person (First Name, Last Name) \_\_\_\_\_

Telephone Number \_\_\_\_\_

Fax Number \_\_\_\_\_

E-mail Address \_\_\_\_\_

Description and location of proposed subcontract: \_\_\_\_\_

\_\_\_\_\_

Are you a Union contractor? Yes \_\_\_ No \_\_\_ If yes, please list which local(s) you affiliated with

\_\_\_\_\_

Are you a Veteran owned company? Yes \_\_\_ No \_\_\_

Procurement Identification Number (PIN)  
(City contracts only) \_\_\_\_\_

Contract Registration Number (CT#)  
(City contracts only) \_\_\_\_\_

Revised 8/13

FOR OFFICIAL USE ONLY: File No. \_\_\_\_\_

Block and Lot Number  
(ICIP projects only)

Contract Amount

I, (print name of authorized official signing) \_\_\_\_\_ hereby certify that I am authorized by the above-named subcontractor to certify that said subcontractor's proposed contract with the above named owner or City agency is less than \$750,000. This affirmation is made in accordance with NYC Charter Chapter 56, Executive Order No. 50 (1980) and the implementing Rules.

Willful or fraudulent falsifications of any data or information submitted herewith may result in the termination of the contract between the City and the bidder or contractor and in disapproval of future contracts for a period of up to five years. Further, such falsification may result in civil and/or criminal prosecution.

Signature of authorized official

Date

<b>Only original signatures accepted</b>		
Sworn to before me this _____	day of _____	20____
Notary Public	Authorized Signature	Date





Department of  
Design and  
Construction

---

INFRASTRUCTURE DIVISION  
BUREAU OF DESIGN

---

VOLUME 1 OF 3

PROJECT ID: SANDHW11

RECONSTRUCTION OF

BEACH CHANNEL DRIVE  
BETWEEN BEACH 116TH STREET AND BEACH 124TH STREET

INCLUDING SEWER, WATER MAIN, TRAFFIC SIGNAL  
AND STREET LIGHTING WORK

Together With All Work Incidental Thereto

BOROUGH OF QUEENS  
CITY OF NEW YORK

---

*Contractor.*

---

Dated \_\_\_\_\_, 20\_\_\_\_

---



**Department of  
Design and  
Construction**

**THE CITY OF NEW YORK  
DEPARTMENT OF DESIGN AND CONSTRUCTION  
DIVISION OF INFRASTRUCTURE**

30-30 THOMSON AVENUE  
LONG ISLAND CITY, NEW YORK 11101-3045  
TELEPHONE (718) 391-1000  
WEBSITE [www1.nyc.gov/site/ddc/index.page](http://www1.nyc.gov/site/ddc/index.page)

**VOLUME 2 OF 3**

**INFORMATION FOR BIDDERS  
CONTRACT  
PERFORMANCE AND PAYMENT BONDS  
PREVAILING WAGE SCHEDULE**

FOR FURNISHING ALL LABOR AND MATERIALS NECESSARY AND  
REQUIRED FOR:

**PROJECT ID: SANDHW11**

**RECONSTRUCTION OF**

**BEACH CHANNEL DRIVE  
BETWEEN BEACH 116TH STREET AND BEACH 124TH STREET**

**INCLUDING SEWER, WATER MAIN, TRAFFIC SIGNAL  
AND STREET LIGHTING WORK  
Together With All Work Incidental Thereto**

**BOROUGH OF QUEENS  
CITY OF NEW YORK**

FOR THE DEPARTMENT OF TRANSPORTATION  
PREPARED BY

*IN-HOUSE DESIGN.*

**SEPTEMBER 29, 2016**

NYS DOT PIN X777.44  
Fed. Aid Project No. \_\_\_\_\_



7-053



**Department of  
Design and  
Construction**

**THE CITY OF NEW YORK  
DEPARTMENT OF DESIGN AND CONSTRUCTION  
DIVISION OF INFRASTRUCTURE**

30-30 THOMSON AVENUE  
LONG ISLAND CITY, NEW YORK 11101-3045  
TELEPHONE (718) 391-1000  
WEBSITE [www.nyc.gov/buildnyc](http://www.nyc.gov/buildnyc)

**VOLUME 2 OF 3**

**INFORMATION FOR BIDDERS  
CONTRACT  
PERFORMANCE AND PAYMENT BONDS  
PREVAILING WAGE SCHEDULE**

FOR FURNISHING ALL LABOR AND MATERIALS NECESSARY AND REQUIRED FOR:

**PROJECT ID:**



FOR THE DEPARTMENT OF TRANSPORTATION  
PREPARED BY

January 30, 2016

## PAID SICK LEAVE LAW CONTRACT RIDER

### Introduction and General Provisions

The Earned Sick Time Act, also known as the Paid Sick Leave Law ("PSLL"), requires covered employees who annually perform more than 80 hours of work in New York City to be provided with paid sick time.<sup>1</sup> Contractors of the City of New York or of other governmental entities may be required to provide sick time pursuant to the PSLL.

The PSLL became effective on April 1, 2014, and is codified at Title 20, Chapter 8, of the New York City Administrative Code. It is administered by the City's Department of Consumer Affairs ("DCA"); DCA's rules promulgated under the PSLL are codified at Chapter 7 of Title 6 of the Rules of the City of New York ("Rules").

Contractor agrees to comply in all respects with the PSLL and the Rules, and as amended, if applicable, in the performance of this agreement. Contractor further acknowledges that such compliance is a material term of this agreement and that failure to comply with the PSLL in performance of this agreement may result in its termination.

Contractor must notify the Agency Chief Contracting Officer of the City agency or other entity with whom it is contracting in writing within ten (10) days of receipt of a complaint (whether oral or written) regarding the PSLL involving the performance of this agreement. Additionally, Contractor must cooperate with DCA's education efforts and must comply with DCA's subpoenas and other document demands as set forth in the PSLL and Rules.

The PSLL is summarized below for the convenience of Contractor. Contractor is advised to review the PSLL and Rules in their entirety. On the website [www.nyc.gov/PaidSickLeave](http://www.nyc.gov/PaidSickLeave) there are links to the PSLL and the associated Rules as well as additional resources for employers, such as Frequently Asked Questions, timekeeping tools and model forms, and an event calendar of upcoming presentations and webinars at which Contractor can get more information about how to comply with the PSLL. Contractor acknowledges that it is responsible for compliance with the PSLL notwithstanding any inconsistent language contained herein.

Pursuant to the PSLL and the Rules:

### Applicability, Accrual, and Use

An employee who works within the City of New York for more than eighty hours in any consecutive 12-month period designated by the employer as its "calendar year" pursuant to the PSLL ("Year") must be provided sick time. Employers must provide a minimum of one hour of sick time for every 30 hours worked by an employee and compensation for such sick time must

---

<sup>1</sup> Pursuant to the PSLL, if fewer than five employees work for the same employer, as determined pursuant to New York City Administrative Code §20-912(g), such employer has the option of providing such employees uncompensated sick time.



be provided at the greater of the employee's regular hourly rate or the minimum wage. Employers are not required to provide more than forty hours of sick time to an employee in any Year.

An employee has the right to determine how much sick time he or she will use, provided that employers may set a reasonable minimum increment for the use of sick time not to exceed four hours per day. In addition, an employee may carry over up to forty hours of unused sick time to the following Year, provided that no employer is required to allow the use of more than forty hours of sick time in a Year or carry over unused paid sick time if the employee is paid for such unused sick time and the employer provides the employee with at least the legally required amount of paid sick time for such employee for the immediately subsequent Year on the first day of such Year.

An employee entitled to sick time pursuant to the PSSL may use sick time for any of the following:

- such employee's mental illness, physical illness, injury, or health condition or the care of such illness, injury, or condition or such employee's need for medical diagnosis or preventive medical care;
- such employee's care of a family member (an employee's child, spouse, domestic partner, parent, sibling, grandchild or grandparent, or the child or parent of an employee's spouse or domestic partner) who has a mental illness, physical illness, injury or health condition or who has a need for medical diagnosis or preventive medical care;
- closure of such employee's place of business by order of a public official due to a public health emergency; or
- such employee's need to care for a child whose school or childcare provider has been closed due to a public health emergency.

An employer must not require an employee, as a condition of taking sick time, to search for a replacement. However, an employer may require an employee to provide: reasonable notice of the need to use sick time; reasonable documentation that the use of sick time was needed for a reason above if for an absence of more than three consecutive work days; and/or written confirmation that an employee used sick time pursuant to the PSSL. However, an employer may not require documentation specifying the nature of a medical condition or otherwise require disclosure of the details of a medical condition as a condition of providing sick time and health information obtained solely due to an employee's use of sick time pursuant to the PSSL must be treated by the employer as confidential.

If an employer chooses to impose any permissible discretionary requirement as a condition of using sick time, it must provide to all employees a written policy containing those requirements, using a delivery method that reasonably ensures that employees receive the policy. If such employer has not provided its written policy, it may not deny sick time to an employee because of non-compliance with such a policy.

Sick time to which an employee is entitled must be paid no later than the payday for the next regular payroll period beginning after the sick time was used.

### Exemptions and Exceptions

Notwithstanding the above, the PSLL does not apply to any of the following:

- an independent contractor who does not meet the definition of employee under section 190(2) of the New York State Labor Law;
- an employee covered by a valid collective bargaining agreement in effect on April 1, 2014 until the termination of such agreement;
- an employee in the construction or grocery industry covered by a valid collective bargaining agreement if the provisions of the PSLL are expressly waived in such collective bargaining agreement;
- an employee covered by another valid collective bargaining agreement if such provisions are expressly waived in such agreement and such agreement provides a benefit comparable to that provided by the PSLL for such employee;
- an audiologist, occupational therapist, physical therapist, or speech language pathologist who is licensed by the New York State Department of Education and who calls in for work assignments at will, determines his or her own schedule, has the ability to reject or accept any assignment referred to him or her, and is paid an average hourly wage that is at least four times the federal minimum wage;
- an employee in a work study program under Section 2753 of Chapter 42 of the United States Code;
- an employee whose work is compensated by a qualified scholarship program as that term is defined in the Internal Revenue Code, Section 117 of Chapter 20 of the United States Code; or
- a participant in a Work Experience Program (WEP) under section 336-c of the New York State Social Services Law.

### Retaliation Prohibited

An employer may not threaten or engage in retaliation against an employee for exercising or attempting in good faith to exercise any right provided by the PSLL. In addition, an employer may not interfere with any investigation, proceeding, or hearing pursuant to the PSLL.

### Notice of Rights

An employer must provide its employees with written notice of their rights pursuant to the PSLL. Such notice must be in English and the primary language spoken by an employee, provided that DCA has made available a translation into such language. Downloadable notices are available on DCA's website at <http://www.nyc.gov/html/dca/html/law/PaidSickLeave.shtml>.

Any person or entity that willfully violates these notice requirements is subject to a civil penalty in an amount not to exceed fifty dollars for each employee who was not given appropriate notice.

### Records

An employer must retain records documenting its compliance with the PSSL for a period of at least three years, and must allow DCA to access such records in furtherance of an investigation related to an alleged violation of the PSSL.

#### Enforcement and Penalties

Upon receiving a complaint alleging a violation of the PSSL, DCA has the right to investigate such complaint and attempt to resolve it through mediation. Within 30 days of written notification of a complaint by DCA, or sooner in certain circumstances, the employer must provide DCA with a written response and such other information as DCA may request. If DCA believes that a violation of the PSSL has occurred, it has the right to issue a notice of violation to the employer.

DCA has the power to grant an employee or former employee all appropriate relief as set forth in New York City Administrative Code 20-924(d). Such relief may include, among other remedies, treble damages for the wages that should have been paid, damages for unlawful retaliation, and damages and reinstatement for unlawful discharge. In addition, DCA may impose on an employer found to have violated the PSSL civil penalties not to exceed \$500 for a first violation, \$750 for a second violation within two years of the first violation, and \$1,000 for each succeeding violation within two years of the previous violation.

#### More Generous Policies and Other Legal Requirements

Nothing in the PSSL is intended to discourage, prohibit, diminish, or impair the adoption or retention of a more generous sick time policy, or the obligation of an employer to comply with any contract, collective bargaining agreement, employment benefit plan or other agreement providing more generous sick time. The PSSL provides minimum requirements pertaining to sick time and does not preempt, limit or otherwise affect the applicability of any other law, regulation, rule, requirement, policy or standard that provides for greater accrual or use by employees of sick leave or time, whether paid or unpaid, or that extends other protections to employees. The PSSL may not be construed as creating or imposing any requirement in conflict with any federal or state law, rule or regulation.

## **HIRING AND EMPLOYMENT RIDER:**

### **HIRENYC AND REPORTING REQUIREMENTS**

#### **Introduction**

This Rider shall apply to all contracts for goods, services, and construction with a value of one million dollars (\$1,000,000.00) or more, provided, however, that certain requirements of the Rider shall only apply as indicated below. This Rider addresses the HireNYC process, including reporting obligations under the HireNYC process, and certain other reporting requirements imposed by law. In general, the HireNYC process under this Rider requires the Contractor to enroll with the HireNYC portal for the City of New York ("the City") found within the Department of Small Business Services's ("SBS") website, to disclose all entry to mid-level job opportunities described in this Rider arising from this contract and located in New York City, and to agree to interview qualified candidates from HireNYC for those opportunities.

#### **HireNYC Requirements**

##### **A. Enrollment**

The Contractor shall enroll with the HireNYC system, found at [www.nyc.gov/sbs](http://www.nyc.gov/sbs), within thirty (30) days after the registration of this Contract pursuant to Section 328 of the New York City Charter. The Contractor shall provide information about the business, designate a primary contact and say whether it intends to hire for any entry to mid-level job opportunities arising from this contract and located in New York City, and, if so, the approximate start date of the first hire.

##### **B. Job Posting Requirements**

Once enrolled in HireNYC, the Contractor agrees to update the HireNYC portal with all entry to mid-level job opportunities arising from this contract and located in New York City, if any, which shall be defined as jobs requiring no more than an associate degree, as provided by the New York State Department of Labor (see Column F of <https://labor.ny.gov/stats/2012-2022-NYS-Employment-Prospects.xls>). The information to be updated includes the types of entry and mid-level positions made available from the work arising from the contract and located in New York City, the number of positions, the anticipated schedule of initiating the hiring process for these positions, and the contact information for the Contractor's representative charged with overseeing hiring. The Contractor must update the HireNYC portal with any hiring needs arising from the contract and located in New York City, and the requirements of the jobs to be filled, no less than three weeks prior to the intended first day of employment for each new position, except with the permission of SBS, not to be unreasonably withheld, and must also update the HireNYC portal as set forth below.

After enrollment through HireNYC and submission of relevant information, SBS will work with the Contractor to develop a recruitment plan which will outline the candidate screening process.

and will provide clear instructions as to when, where, and how interviews will take place. HireNYC will screen applicants based on employer requirements and refer applicants whom it believes are qualified to the Contractor for interviews. The Contractor must interview referred applicants whom it believes are qualified.

After completing an interview of a candidate referred by HireNYC, the Contractor must provide feedback via the portal within twenty (20) business days to indicate which candidates were interviewed and hired, if any. In addition, the Contractor shall provide the start date of new hires, and additional information reasonably related to such hires, within twenty (20) business days after the start date. In the event the Contractor does not have any job openings covered by this Rider in any given year, the Contractor shall be required to provide an annual update to HireNYC to that effect. For this purpose, the reporting year shall run from the date of the registration of the contract and each anniversary date.

These requirements do not limit the Contractor's ability to assess the qualifications of prospective workers, and to make final hiring and retention decisions. No provision of this Rider shall be interpreted so as to require the Contractor to employ any particular worker.

In addition, the provisions of this Rider shall not apply to positions that the Contractor intends to fill with employees employed pursuant to the job retention provision of Section 22-505 of the Administrative Code of the City of New York. The Contractor shall not be required to report such openings with HireNYC. However, the Contractor shall enroll with the HireNYC system pursuant to Section A, above, and, if such positions subsequently become open, then the remaining provisions of this Rider will apply.

### **C. Breach and Liquidated Damages**

If the Contractor fails to comply with the terms of the contract and this Rider (1) by not enrolling its business with HireNYC; (2) by not informing HireNYC, as required, of open positions; or (3) by failing to interview a qualified candidate, the contracting agency may assess liquidated damages in the amount of two-thousand five hundred dollars (\$2,500.00) per breach. For all other events of noncompliance with the terms of this Rider, the agency may assess liquidated damages in the amount of five hundred dollars (\$500) per breach.

Furthermore, in the event the Contractor breaches the requirements of this Rider during the term of the contract, the City may hold the Contractor in default of this contract.

### **Audit Compliance**

In addition to the auditing requirements set forth in other parts of the contract, the Contractor shall permit SBS and the City to inspect any and all records concerning or relating to job openings or the hiring of individuals for work arising from the contract and located in New York City. The Contractor shall permit an inspection within seven (7) business days of the request.

### **Other Reporting Requirements**

The Contractor shall report to the City, on a monthly basis, all information reasonably requested by the City that is necessary for the City to comply with any reporting requirements imposed by law or rule, including any requirement that the City maintain a publicly accessible database. In addition, the Contractor agrees to comply with all reporting requirements imposed by law or rule, or as otherwise requested by the City.

### **Construction Requirements**

Construction contractors shall comply with the HireNYC requirements set forth above for all non-trades jobs (e.g., for an administrative position arising out of the work of the contract and located in New York City) as set forth above.

In addition, construction contractors shall reasonably cooperate with SBS and the City on specific outreach events, including Hire on the Spot events, for the hiring of trades workers for the work of this contract.

Further, this contract shall be subject to a project labor agreement if so required elsewhere in this contract.

### **Federal Hiring Requirements**

The Contractor shall comply with all federal hiring requirements as may be set forth elsewhere in this contract, including, as applicable:

- Section 3 of the HUD Act of 1968, which requires, to the greatest extent feasible, economic opportunities for 30 percent of new hires be given to low- and very low-income persons, particularly persons who are recipients of HUD assistance for housing.
- Executive Order 11246, which prohibits discrimination in employment due to race, color, religion, sex or national origin, and requires the implementation of goals for minority and female participation for work involving any Construction trade.

(NO TEXT ON THIS PAGE)

# NOTICE TO BIDDERS

Please be advised that the City of New York has issued a new Standard Construction Contract. The new Contract, which is incorporated in this bid, is significantly different from the 2008 version previously used by the City. A listing of some of the significant changes is provided below. This notice is only a partial listing. Please refer to the Contract itself for a full understanding of the changes and the actual text of the changes that were made. The text of the revised Standard Construction Contract is the controlling document should there be any discrepancies between this notice and the Standard Construction Contract.

Significant changes include the following:

## ARTICLE 11 DAMAGES CAUSED BY DELAYS

In 2008, the City embarked on a pilot project to test the use of new construction contract language altering the allocation of the risk of project delays, as between the City and the contractor. The City has determined to make the pilot project language the standard language for all City construction contracts. Accordingly, there is now one Standard City Construction Contract that is to be used by all agencies for all bids released after the release of the new contract. The damages for delay language is Article 11. Please note that changes have been made to the damages for delay provisions from the pilot to the adopted version.

## ARTICLE 22 INSURANCE

Changes have been made to the insurance provisions, including incorporating requirements that the insurance provided comply with recent NYC Department of Buildings regulations specifying required dollar limits for CGL insurance for certain projects and requiring proof of builder's risk insurance prior to Work commencing rather than within 10 days of award.



**ARTICLE 26        EXTRA WORK**

The percentage paid for overhead for Extra Work pursuant to Section 26.1.11 is increased from 10% to 12% and the calculation of Worker's Compensation insurance costs reimbursed for Extra Work has been clarified.

**ARTICLE 37        LABOR LAW REQUIREMENTS**  
**ARTICLE 38        PAYROLL REPORTS**

The provisions governing Labor Law provisions have been tightened, including requirements the employee identification cards include a photo (unless the requirement is waived), a prohibition on cash payments to employees and subcontractors, and clear enforcement authority requirements.

**ARTICLE 70        ELECTRONIC FILING**

A provision is added to make mandatory the electronic filing of certain alteration permits with the Department of Buildings.

**Other significant changes include the following:**

**ARTICLE 7        INDEMNIFICATION**

Changes have been made to the indemnification provisions.

**ARTICLE 14        FINAL ACCEPTANCE OF WORK**  
**ARTICLE 44        SUBSTANTIAL COMPLETION PAYMENT**

The Commissioner is no longer required to issue a substantial completion determination in addition to the already existing requirement that the Engineer issue a substantial completion determination and reach an agreement on a punch list of remaining work. Now, the Engineer, when issuing the punch list to the Contractor, must also include a proposed schedule for the completion of the punch list. The Contractor may propose an alternative schedule that is subject to the approval of the Engineer. If the Contractor fails to respond to the Engineer's proposed schedule, the Engineer's schedule is deemed accepted.

**ARTICLE 15        LIQUIDATED DAMAGES**

The contract is revised to match Schedule A to provide that liquidated damages are available only until substantial completion.

**ARTICLE 17            SUBCONTRACTS**

The requirements for prior approval of subcontractors, and for contractors to be responsible for the actions of their subcontractors, have been tightened. The requirement that the Contractor list subcontractors in the City's Payee Information Portal has been added; the provision was previously attached as a rider.

**ARTICLE 19            SECURITY DEPOSIT**

The provisions governing the return of bid deposits are clarified.

**ARTICLE 20            PAYMENT GUARANTEE**

The Payment Guaranty provisions, which apply when the City does not require the Contractor to obtain payment bonds, has been significantly revised to track the requirements of State Finance law 137.

**ARTICLE 28            RECORDKEEPING FOR EXTRA OR DISPUTED WORK**

The recordkeeping requirement that currently apply to payments for Time & Materials for extra work are expressly made applicable to regular work that is paid for on a T & M basis.

**ARTICLE 35            EMPLOYEES**

The whistleblower provisions of local law are added to the construction contract. They previously have been attached as a rider.

**ARTICLE 38            PAYROLL REPORTS**  
**ARTICLE 77            RECORDS RETENTION**

Requirements that records be maintained for six years and directions on how such records must be made available.

**ARTICLE 42            PARTIAL PAYMENTS**

Increased flexibility has been provided for when contractors may submit invoices.

**ARTICLE 62            TAX EXEMPTION**

The provisions identifying the State tax exemption for municipalities are revised to more clearly describe State law.

(NO TEXT ON THIS PAGE)

**NEW YORK CITY STANDARD CONSTRUCTION CONTRACT (DEC. 2013)  
INSURANCE RIDER**

[Instructions to Agencies: Please attach this Insurance Rider to the December 2013 version of the New York City Standard Construction Contract. This rider shall not be used with subsequent versions of the New York City Standard Construction Contract.]

The following provisions supersede the corresponding provisions in the December 2013 version of the New York City Standard Construction Contract:

1. Section 22.1.1(c) provides as follows:

22.1.1(c) If the Work requires a permit from the Department of Buildings pursuant to 1 RCNY Section 101-08, the Contractor shall provide Commercial General Liability Insurance with limits of at least those required by 1 RCNY section 101-08 or greater limits provided by the Agency in Schedule A. If the Work does not require such a permit, the minimum limits shall be those provided for in Schedule A.

2. Section 22.3.3 provides as follows:

22.3.3 For policies provided pursuant to all of Article 22.1 other than Article 22.1.2, the Contractor shall submit one or more Certificates of Insurance on forms acceptable to the Commissioner. All such Certificates of Insurance shall certify (a) the issuance and effectiveness of such policies of insurance, each with the specified minimum limits (b) for insurance secured pursuant to Article 22.1.1 that the City and any other entity specified in Schedule A is an Additional Insured thereunder; (c) in the event insurance is required pursuant to Article 22.1.6 and/or Article 22.1.7, that the City is an Additional Insured thereunder; and (d) the company code issued to the insurance company by the National Association of Insurance Commissioners (the NAIC number). All such Certificates of Insurance shall be accompanied by the required additional insured endorsements and either a duly executed "Certification by Insurance Broker or Agent" in the form contained in Part III of Schedule A or copies of all policies referenced in such Certificate of Insurance as certified by an authorized representative of the issuing insurance carrier. If any policy is not available at the time of submission, certified binders may be submitted until such time as the policy is available, at which time a certified copy of the policy shall be submitted.

(NO TEXT ON THIS PAGE)

**CITY OF NEW YORK**

**DEPARTMENT OF  
DESIGN AND CONSTRUCTION  
DIVISION OF INFRASTRUCTURES**

**INFORMATION FOR BIDDERS**

**JUNE 2015**

(NO TEXT ON THIS PAGE)

*CITY OF NEW YORK CITY  
DEPARTMENT OF DESIGN AND CONSTRUCTION  
INFORMATION FOR BIDDERS*

*TABLE OF CONTENTS*

SECTION 1.	DESCRIPTION AND LOCATION OF WORK	1
SECTION 2.	TIME AND PLACE FOR RECEIPT OF BIDS	1
SECTION 3.	DEFINITIONS	1
SECTION 4.	INVITATION FOR BIDS AND CONTRACT DOCUMENTS	1
SECTION 5.	PRE-BID CONFERENCE	2
SECTION 6.	AGENCY CONTACT	2
SECTION 7.	BIDDER'S OATH	2
SECTION 8.	EXAMINATION AND VIEWING OF SITE, CONSIDERATION OF OTHER SOURCES OF INFORMATION AND CHANGED CONDITIONS	2
SECTION 9.	EXAMINATION OF PROPOSED CONTRACT	3
SECTION 10.	FORM OF BID	3
SECTION 11.	IRREVOCABILITY OF BID	3
SECTION 12.	ACKNOWLEDGMENT OF AMENDMENTS	4
SECTION 13.	BID SAMPLES AND DESCRIPTIVE LITERATURE	4
SECTION 14.	PROPRIETARY INFORMATION/TRADE SECRETS	4
SECTION 15.	PRE-OPENING MODIFICATION OR WITHDRAWAL OF BIDS	4
SECTION 16.	BID EVALUATION AND AWARD	4
SECTION 17.	LATE BIDS, LATE WITHDRAWALS AND LATE MODIFICATIONS	5
SECTION 18.	WITHDRAWAL OF BIDS.	5
SECTION 19.	MISTAKE IN BIDS	5
SECTION 20.	LOW TIE BIDS	6
SECTION 21.	REJECTION OF BIDS	6
SECTION 22.	RIGHT TO APPEAL DETERMINATIONS OF NON-RESPONSIVENESS OR NON-RESPONSIBILITY AND RIGHT TO PROTEST SOLICITATIONS AND AWARD	7
SECTION 23.	AFFIRMATIVE ACTION AND EQUAL EMPLOYMENT OPPORTUNITY	7
SECTION 24.	VENDEX QUESTIONNAIRES	7
SECTION 25.	COMPLAINTS ABOUT THE BID PROCESS	8
SECTION 26.	BID, PERFORMANCE AND PAYMENT SECURITY	8
SECTION 27.	FAILURE TO EXECUTE CONTRACT	9
SECTION 28.	BIDDER RESPONSIBILITIES AND QUALIFICATIONS	9
SECTION 29.	EMPLOYMENT REPORT	10
SECTION 30.	LABOR LAW REQUIREMENTS	10
SECTION 31.	INSURANCE	10
SECTION 32.	LUMP SUM CONTRACTS	11
SECTION 33.	UNIT PRICE CONTRACTS	11
SECTION 34.	EXCISE TAX	11
SECTION 35.	LICENSES AND PERMITS	11
SECTION 36.	MULTIPLE PRIME CONTRACTORS	11
SECTION 37.	LOCALLY BASED ENTERPRISE REQUIREMENTS (LBE)	12
SECTION 38.	BID SUBMISSION REQUIREMENTS	13
SECTION 39.	COMPTROLLER'S CERTIFICATE	14
SECTION 40.	PROCUREMENT POLICY BOARD RULES	14
SECTION 41.	DDC SAFETY REQUIREMENTS	14



(NO TEXT ON THIS PAGE)

## INFORMATION FOR BIDDERS

### 1. Description and Location of Work

The description and location of the work for which bids are requested are specified in Attachment 1, "Bid Information". Attachment 1 is included as page A-1 of the Bid Booklet.

### 2. Time and Place for Receipt of Bids

Sealed bids shall be received on or before the date and hour specified in Attachment 1, at which time they will be publicly opened and read aloud in the presence of the Commissioner or his or her representative, and any bidders who may desire to be present.

### 3. Definitions

The definitions set forth in the Procurement Policy Board Rules shall apply to this Invitation For Bids.

### 4. Invitation For Bids and Contract Documents

(A) Except for titles, sub-titles, headings, running headlines, tables of contents and indices (all of which are printed herein merely for convenience) the following, except for such portions thereof as may be specifically excluded, shall be deemed to be part of the Contract and the Invitation for Bids.

- (1) All provisions required by law to be inserted in this Contract, whether actually inserted or not
- (2) The Contract Drawings and Specifications
- (3) The General Conditions, the General Requirements and the Special Conditions, if any
- (4) The Contract
- (5) The Information for Bidders; Request for Proposals; Notice of Solicitation and Proposal For Bids; Bid or Proposal, and, if used, the Bid Booklet
- (6) The Budget Director's Certificate; all Addenda issued prior to the receipt of the bids; the Notice of Award; Performance and Payment Bonds, if required; and the Notice to Proceed with the Work.

(B) For particulars as to this procurement, including quantity and quality of the purchase, extent of the work or labor to be performed, delivery and performance schedule, and any other special instructions, prospective bidders are referred to the Invitation For Bids Documents. A copy of such documents can be obtained at the location set forth in Attachment 1.

(C) Deposit for Copy of Invitation For Bids Documents: Prospective bidders may obtain a copy of the Invitation For Bids Documents by complying with the conditions set forth in the Notice of Solicitation. The deposit must be in the form of a check or money order made payable to the City of New York, and drawn upon a state or national bank or trust company, or a check of such bank or trust company signed by a duly authorized officer thereof.

(D) Return of Invitation For Bids Documents: All Invitation For Bids Documents must be returned to the Department upon request. If the bidder elects not to submit a bid thereunder, the

Invitation For Bids Documents shall be returned to the Department, along with a statement that no bid will be submitted.

(E) Return of Deposit: Such deposit will be returned within 30 days after the award of the contract or the rejection of all bids as set forth in the advertisement, provided the Invitation For Bids Documents are returned to the location specified in Attachment 1, in physical condition satisfactory to the Commissioner.

(F) Additional Copies: Additional copies of the Invitation For Bids Documents may be obtained, subject to the conditions set forth in the advertisement for bids.

5. Pre-Bid Conference

A pre-bid conference shall be held as set forth in Attachment 1. Nothing stated at the pre-bid conference shall change the terms or conditions of the Invitation For Bids Documents, unless a change is made by written amendment as provided in Section 9 below. Failure to attend a mandatory pre-bid conference shall constitute grounds for the rejection of the bid.

6. Agency Contact

Any questions or correspondence relating to this bid solicitation shall be addressed to the Agency Contact person specified in Attachment 1.

7. Bidder's Oath

(A) The bid shall be properly signed by an authorized representative of the bidder and the bid shall be verified by the written oath of the authorized representative who signed the bid, that the several matters stated and information furnished therein are in all aspects true.

(B) A materially false statement willfully or fraudulently made in connection with the bid or any of the forms completed and submitted with the bid may result in the termination of any Contract between the City and the Bidder. As a result, the Bidder may be barred from participating in future City contracts as well as be subject to possible criminal prosecution.

8. Examination and Viewing of Site

(A) Pre-Bidding (Investigation) Viewing of Site -Bidders must carefully view and examine the site of the proposed work, as well as its adjacent area, and seek other usual sources of information, for they will be conclusively presumed to have full knowledge of any and all conditions on, about or above the site relating to or affecting in any way the performance of the work to be done under the Contract which were or should have been indicated to a reasonably prudent bidder. To arrange a date for visiting the work site, bidders are to contact the Agency Contact person specified in Attachment 1.

(B) Should the contractor encounter during the progress of the work subsurface conditions at the site materially differing from any shown on the Contract Drawings or indicated in the Specifications or such subsurface conditions as could not reasonably have been anticipated by the contractor and were not anticipated by the City, which conditions will materially affect the cost of the work to be done under the

Contract, the attention of the Commissioner must be called immediately to such conditions before they are disturbed. The Commissioner shall thereupon promptly investigate the conditions. If he finds that they do so materially differ, or that they could not have been reasonably anticipated by the contractor and were not anticipated by the City, the Contract may be modified with his written approval.

9. Examination of Proposed Contract

(A) Request for Interpretation or Correction: Prospective bidders must examine the Contract Documents carefully and before bidding must request the Commissioner in writing for an interpretation or correction of every patent ambiguity, inconsistency or error therein which should have been discovered by a reasonably prudent bidder. Such interpretation or correction, as well as any additional contract provisions the Commissioner may decide to include, will be issued in writing by the Commissioner as an addendum to the Contract, which will be transmitted to each person recorded as having received a copy of the Contract Documents from the Department. Transmission of such addendum will be by mail, e-mail, facsimile or hand delivery. Such addendum will also be posted at the place where the Contract Documents are available for the inspection of prospective bidders. Upon transmission as provided for herein, such addendum shall become a part of the Contract Documents, and binding on all bidders, whether or not actual notice of such addendum is shown.

(B) Only Commissioner's Interpretation or Correction Binding: Only the written interpretation or correction so given by the Commissioner shall be binding, and prospective bidders are warned that no other officer, agent or employee of the City is authorized to give information concerning, or to explain or interpret, the Contract.

(C) Documents given to a subcontractor for the purpose of soliciting the subcontractor's bid shall include either a copy of the bid cover sheet or a separate information sheet setting forth the project name, the Contract number (if available), the contracting agency and the Project's location.

10. Form of Bid

Each bid must be submitted upon the prescribed form and must contain: a) the name, residence and place of business of the person or persons making the same; b) the names of all persons interested therein, and if no other person is so interested, such fact must be distinctly stated; c) a statement to the effect that it is made without any connection with any other person making a bid for the same purpose and that it is in all respects fair and without collusion or fraud; d) a statement that no Council member or other officer or employee or person whose salary is payable in whole or part from the City Treasury is directly or indirectly interested therein or in the supplies, materials or equipment and work or labor to which it relates, or in any portion of the profits thereof; e) a statement that the bidder is not in arrears to the City or to any agency upon a debt or contract or taxes, and is not a defaulter as surety or otherwise upon any obligation to the City to any agency thereof, except as set forth in the bid.

THE BID SHALL BE TYPEWRITTEN OR WRITTEN LEGIBLY IN INK. THE BID SHALL BE SIGNED IN INK. ERASURES OR ALTERATIONS SHALL BE INITIALED BY THE SIGNER IN INK. FAILURE TO CONFORM TO THE REQUIREMENTS OF THIS SECTION 10 SHALL RESULT IN THE REJECTION OF THE BID.

11. Irrevocability of Bid

The prices set forth in the bid cannot be revoked and shall be effective until the award of the Contract, unless the bid is withdrawn as provided for in Sections 15 and 18 below.

12. Acknowledgment of Amendments

The receipt of any amendment to the Contract Documents shall be acknowledged by the bidder in its bid submission.

13. Bid Samples and Descriptive Literature

Bid samples and descriptive literature shall not be submitted by the bidder, unless expressly requested elsewhere in the Contract or Contract Documents. Any unsolicited bid samples or descriptive literature which are submitted shall not be examined or tested and shall not be deemed to vary any of the provisions of this Contract.

14. Proprietary Information/Trade Secrets

(A) The bidder shall identify those portions of the bid which it deems to be confidential, proprietary information or trade secrets, and provide justification why such materials shall not be disclosed by the City. All such materials shall be clearly indicated by stamping the pages on which such information appears, at the top and bottom thereof with the word "Confidential". Such materials stamped "Confidential" must be easily separable from the non-confidential sections of the bid.

(B) All such materials so indicated shall be reviewed by the Agency and any decision not to honor a request for confidentiality shall be communicated in writing to the bidder. For those bids which are unsuccessful, all such confidential materials shall be returned to the bidder. Prices, makes and model or catalog numbers of the items offered, deliveries, and terms of payment shall be publicly available after bid opening, regardless of any designation of confidentiality made by the bidder.

15. Pre-Opening Modification or Withdrawal of Bids

Bids may be modified or withdrawn by written notice received in the office designated in Attachment 1, before the time and date set for the bid opening. If a bid is withdrawn in accordance with this Section, the bid security, if any, shall be returned to the bidder.

16. Bid Evaluation and Award

In accordance with the New York City Charter, the Procurement Policy Board Rules and the terms and conditions of this Invitation For Bids, this Contract shall be awarded, if at all, to the responsible bidder whose bid meets the requirements and evaluation criteria set forth in the Invitation For Bids, and whose bid price is either the most favorable bid price or, if the Invitation For Bids so states, the most favorable evaluated bid price. A bid may not be evaluated for any requirement or criterion that is not disclosed in the Invitation For Bids.

Restriction: No negotiations with any bidder shall be allowed to take place except under the circumstances and in the manner set forth in Section 21. Nothing in this Section shall be deemed to permit a contract award to a bidder submitting a higher quality item than that designated in the Invitation For Bids, if that bid is not also the most favorable bid.

17. Late Bids, Late Withdrawals and Late Modifications

Any bid received at the place designated in the solicitation after the time and date set for receipt of bids is late and shall not be considered. Any request for withdrawal or modification received at the place designated in the solicitation after the time and date set for receipt of bids is late and shall not be considered. The exception to this provision is that a late modification of a successful bid that makes the bid terms more favorable to the City shall be considered at any time it is received.

18. Withdrawal of Bids.

Except as provided for in Section 15, above, a bidder may not withdraw its bid before the expiration of forty-five (45) days after the date of the opening of bids; thereafter, a bidder may withdraw its bid only in writing and in advance of an actual award. If within sixty (60) days after the execution of the Contract, the Commissioner fails to fix the date for commencement of work by written notice to the bidder, the bidder, at his option, may ask to be relieved of his obligation to perform the work called for by written notice to the Commissioner. If such notice is given to the Commissioner, and the request to withdraw is granted, the bidder waives all claims in connection with this Contract.

19. Mistake in Bids

(A) Mistake Discovered Before Bid Opening: A bidder may correct mistakes discovered before the time and date set for bid opening by withdrawing or correcting the bid as provided in Section 15 above.

(B) Mistakes Discovered Before Award

(1) In accordance with General Municipal Law (Section 103, subdivision .11), where a unilateral error or mistake is discovered in a bid, such bid may be withdrawn upon written approval of the Agency Chief Contracting Officer if the following conditions are met:

- (a) The mistake is known or made known to the agency prior to the awarding of the Contract or within 3 days after the opening of the bid, whichever period is shorter; and
- (b) The price bid was based upon an error of such magnitude that enforcement would be unconscionable; and
- (c) The bid was submitted in good faith and the bidder submits credible evidence that the mistake was a clerical error as opposed to a judgment error; and
- (d) The error in the bid is actually due to an unintentional and substantial arithmetic error or an unintentional omission of a substantial quantity of work, labor, material or services made directly in the compilation of the bid, which unintentional arithmetic error or unintentional omission can be clearly shown by objective evidence drawn from inspection of the original work paper, documents, or materials used in the preparation of the bid sought to be withdrawn; and
- (e) It is possible to place the agency in the same position as existed prior to the bid.

(2) Unless otherwise required by law, the sole remedy for a bid mistake in accordance with this Article shall be withdrawal of the bid, and the return of the bid bond, or other security, if any, to the bidder. Thereafter, the agency may, in its discretion, award the Contract to the next lowest bidder or rebid the Contract. Any amendment to or reformation of a bid or a Contract to rectify such an error or mistake

therein is strictly prohibited.

(3) If the mistake and the intended correct bid are clearly evident on the face of the bid document, the bid shall be corrected to the intended correct bid and may not be withdrawn. Examples of mistakes that may be corrected are typographical errors, errors in extending unit prices, transposition errors and arithmetical errors.

20. Low Tie Bids

(A) When two or more low responsive bids from responsible bidders are identical in price, meeting all the requirements and criteria set forth in the Invitation For Bids, the Agency Chief Contracting Officer will break the tie in the following manner and order of priority:

- (1) Award to a certified New York City small, minority or woman-owned business entity bidder;
- (2) Award to a New York City bidder;
- (3) Award to a certified New York State small, minority or woman-owned business bidder;
- (4) Award to a New York State bidder.

(B) If two or more bidders still remain equally eligible after application of paragraph (A) above, award shall be made by a drawing by lot limited to those bidders. The bidders involved shall be invited to attend the drawing. A witness shall be present to verify the drawing and shall certify the results on the bid tabulation sheet.

21. Rejection of Bids

(A) Rejection of Individual Bids: The Agency may reject a bid if:

- (1) The bidder fails to furnish any of the information required pursuant to Section 24 or 28 hereof; or if
- (2) The bidder is determined to be not responsible pursuant to the Procurement Policy Board Rules; or if
- (3) The bid is determined to be non-responsive pursuant to the Procurement Policy Board Rules; or if
- (4) The bid, in the opinion of the Agency Chief Contracting Officer, contains unbalanced bid prices and is thus non-responsive, unless the bidder can show that the prices are not unbalanced for the probable required quantity of items, or if the imbalance is corrected pursuant to Section 15.

(B) Rejection of All Bids: The Agency, upon written approval by the Agency Chief Contracting Officer, may reject all bids and may elect to resolicit bids if in its sole opinion it shall deem it in the best interest of the City so to do.

(C) Rejection of All Bids and Negotiation With All Responsible Bidders: The Agency Head may determine that it is appropriate to cancel the Invitation For Bids after bid opening and before award and to complete the acquisition by negotiation. This determination shall be based on one of the following reasons:

- (1) All otherwise acceptable bids received are at unreasonable prices, or only one bid is received and the Agency Chief Contracting Officer cannot determine the reasonableness of the bid price, or no responsive bid has been received from a responsible bidder; or
- (2) In the judgment of the Agency Chief Contracting Officer, the bids were not independently arrived at in open competition, were collusive, or were submitted in bad faith.

(D) When the Agency has determined that the Invitation for Bids is to be canceled and that use of negotiation is appropriate to complete the acquisition, the contracting officer may negotiate and award the Contract without issuing a new solicitation, subject to the following conditions:

- (1) prior notice of the intention to negotiate and a reasonable opportunity to negotiate have been given by the contracting officer to each responsible bidder that submitted a bid in response to the Invitation for Bids;
- (2) the negotiated price is the lowest negotiated price offered by a responsible bidder; and
- (3) the negotiated price is lower than the lowest rejected bid price of a responsible bidder that submitted a bid in response to the Invitation for Bids.

22. Right to Appeal Determinations of Non-Responsiveness or Non-Responsibility and Right to Protest Solicitations and Award

The bidder has the right to appeal a determination of non-responsiveness or non-responsibility and has the right to protest a solicitation and award. For further information concerning these rights, the bidder is directed to the Procurement Policy Board Rules.

23. Affirmative Action and Equal Employment Opportunity

This Invitation For Bids is subject to applicable provisions of Federal, State and Local Laws and executive orders requiring affirmative action and equal employment opportunity.

24. VENDEX Questionnaires

(A) Requirement: Pursuant to Administrative Code Section 6-116.2 and the PPB Rules, bidders may be obligated to complete and submit VENDEX Questionnaires. Generally, if this bid is \$100,000 or more; or if this bid when added to the sum total of all contracts, concessions and franchises the bidder has received from the City and any subcontracts received from City contractors over the past twelve months, equals or exceeds \$100,000, Vendex Questionnaires must be completed. If required, Vendex Questionnaires must be completed and submitted before any award of contract may be made or before approval is given for a proposed subcontractor. Non-compliance with these submission requirements may result in the disqualification of the bid, disapproval of a subcontractor, subsequent withdrawal of approval for the use of an approved subcontractor, or the cancellation of the contract after its award.

(B) Submission: Vendex Questionnaires must be submitted directly to the Mayor's Office of Contract Services, ATTN: Vendex, 253 Broadway, 9th Floor, New York, New York 10007. In addition, the bidder must submit a Confirmation of Vendex Compliance to the agency. A form for this confirmation is set forth in the Bid Booklet.

(C) Obtaining Forms: Vendex Questionnaires, as well as detailed instructions, may be obtained at [www.nyc.gov/vendex](http://www.nyc.gov/vendex). The bidder may also obtain Vendex forms and instructions by contacting the



Agency Chief Contracting Office or the contract person for this contract.

25. Complaints About the Bid Process

The New York City Comptroller is charged with the audit of contracts in New York City. Any vendor who believes that there has been unfairness, favoritism or impropriety in the bid process should inform the Comptroller, Office of Contract Administration, One Centre Street, Room 835, New York, New York; telephone number (212)669-2797.

26. Bid, Performance and Payment Security

(A) Bid Security: Each bid must be accompanied by bid security in an amount and type specified in Attachment 1 (page A-1 of the Bid Booklet). The bid security shall assure the City of New York of the adherence of the bidder to its proposal, the execution of the Contract, and the furnishing of Performance and Payment Bonds by the bidder, if required in Attachment 1. Bid security shall be returned to the bidder as follows:

- (1) Within ten (10) days after the bid opening, the Comptroller will be notified to return the deposits of all but the three (3) lowest bidders. Within five (5) days after the award, the Comptroller will be notified to return the deposits of the remaining two unsuccessful bidders.
- (2) Within five (5) days after the execution of the Contract and acceptance of the Contractor's bonds, the Comptroller will be notified to return the bid security of the successful bidder or, if performance and payment bonds are not required, only after the sum retained under Article 21 of the Contract equals the amount of the bid security.
- (3) Where all bids are rejected, the Comptroller will be notified to return the deposit of the three (3) lowest bidders at the time of rejection.

(B) Performance and Payment Security: Performance and Payment Security must be provided in an amount and type specified in Attachment 1 (page A-1 of the Bid Booklet). The performance and payment security shall be delivered by the contractor prior to or at the time of execution of the Contract. If a contractor fails to deliver the required performance and payment security, its bid security shall be enforced, and an award of Contract may be made to the next lowest responsible and responsive bidder, or the contract may be rebid.

(C) Acceptable Types of Security: Acceptable types of security for bids, performance, and payment shall be limited to the following:

- (1) a one-time bond in a form satisfactory to the City;
- (2) a bank certified check or money order;
- (3) obligations of the City of New York; or
- (4) other financial instruments as determined by the Office of Construction in consultation with the Comptroller.

Whenever the successful bidder deposits obligations of the City of New York as performance and payment security, the Comptroller may sell and use the proceeds thereof for any purpose for which the principal or surety on such bond would be liable under the terms of the Contract. If the money is deposited with the Comptroller, the successful bidder shall not be entitled to receive interest on such money from the City.

(D) Form of Bonds: Security provided in the form of bonds must be prepared on the form of bonds authorized by the City of New York. Forms for bid, performance, and payment bonds are included in the Invitation for Bids Documents. Such bonds must have as surety thereunder such surety company or companies as are: (1) approved by the City of New York; (2) authorized to do business in the State of New York, and (3) approved by the Department of the Treasury of the United States. Premiums for any required bonds must be included in the base bid.

The bidder is advised that submission of a bid bond where the surety on such bond fails to meet the criteria set forth herein, shall result in the rejection of the bid as non-responsive.

The Department of the Treasury of the United States advises that information concerning approved surety companies may be obtained as follows: (1) from the Government Printing Office at 202-512-1800; (2) through the Internet at <http://www.fms.treas.gov/c570/index.html>, and (3) through a computerized public bulletin board, which can be accessed by using your computer modem and dialing 202-874-6887.

(E) Power of Attorney: Attorneys in fact who sign bid, performance, or payment bonds must file with each bond a certified copy of their power of attorney to sign said bonds.

27. Failure to Execute Contract

In the event of failure of the successful bidder to execute the Contract and furnish the required security within ten (10) days after notice of the award of the Contract, the deposit of the successful bidder or so much thereof as shall be applicable to the amount of the award made shall be retained by the City, and the successful bidder shall be liable for and hereby agrees to pay on demand the difference between the price bid and the price for which such Contract shall be subsequently awarded, including the cost of any required reletting and less the amount of such deposit. No plea of mistake in such accepted bid shall be available to the bidder for the recovery of the deposit or as a defense to any action based upon such accepted bid. Further, should the bidder's failure to comply with this Section cause any funding agency, body or group (Federal, State, City, Public, Private, etc.) to terminate, cancel or reduce the funding on this project, the bidder in such event shall be liable also to the City for the amount of actual funding withdrawn by such agency on this project, less the amount of the forfeited deposit.

28. Bidder Responsibilities and Qualifications

(A) Bidders must include with their bids all information necessary for a determination of bidder responsibility, as set forth in the Specifications.

(B) The Agency may require any bidder or prospective bidder to furnish all books of account, records, vouchers, statements or other information concerning the bidder's financial status for examination as may be required by the Agency to ascertain the bidder's responsibility and capability to perform the Contract. If required, a bidder must also submit a sworn statement setting forth such information as the Agency may require concerning present and proposed plant and equipment, the personnel and qualifications of his working organizations, prior experience and performance record.

(C) Oral Examination on Qualifications: In addition thereto, and when directed by the Agency, the bidder, or a responsible officer, agent or employee of the bidder, must submit to an oral examination to be conducted by the Agency in relation to his proposed tentative plan and schedule of

operations, and such other matters as the Agency may deem necessary in order to determine the bidder's ability and responsibility to perform the work in accordance with the Contract. Each person so examined must sign and verify a stenographic transcript of such examination noting thereon such corrections as such person may desire to make.

(D) If the bidder fails or refuses to supply any of the documents or information set forth in paragraph (B) hereof or fails to comply with any of the requirements thereof, the Agency may reject the bid.

29. Employment Report

In accordance with Executive Order No. 50 (1980) as modified by Executive Order 108 (1986), the filing of a completed Employment Report (ER) is a requirement of doing business with the City of New York for construction contractors with contracts of \$1,000,000 or more and subcontractors with construction subcontracts of \$750,000 or more. The required forms and information are included in the Bid Booklet.

30. Labor Law Requirements

(A) General: The successful bidder will be required to comply strictly with all Federal, State and local labor laws and regulations.

(B) New York State Labor Law: This Contract is subject to New York State Labor Law Section 220, which requires that construction workers on the site be paid prevailing wages and supplements. The Contractor is reminded that all wage provisions of this Contract will be enforced strictly and failure to comply will be considered when evaluating performance. Noncompliance may result in the contractor being debarred by the City from future contracts. Complaints filed with the Comptroller may result in decisions which may debar a contractor from bidding contracts with any state governmental entity and other political subdivisions.

(C) Records: The Contractor is expected to submit accurate payroll reports and other required documents and verify attendance and job classifications being utilized in compliance with the law, Contract provisions and agency procedures.

31. Insurance

(A) Bidders are advised that the insurance requirements contained herein are regarded as material terms of the Contract. As required by Article 22 of the Contract, the contractor must effect and maintain with companies licensed and authorized to do business in the State of New York, the types of insurance set forth therein, when required by and in the amounts set forth in Schedule A of the General Conditions. Such required insurance must be provided from the date the contractor is ordered to commence work and up to the date of final acceptance of all required work.

(B) The contractor must, within ten days of receipt of the notice of award, submit the following insurance documentation: (a) original certificate of insurance for general liability in the amount required by Schedule A of the General Conditions, and (b) original certificates of insurance or other proof of coverage for workers' compensation and disability benefits, as required by Section 57 of the New York State Workers' Compensation Law and Section 220 of the Disability Benefits Law.

32. Lump Sum Contracts

(A) Comparison of Bids: Bids on Lump Sum Contracts will be compared on the basis of the lump sum price bid, adjusted for alternate prices bid, if any.

(B) Lump Sum Bids for "General Construction Work" which include excavation shall include all necessary excavation work defined in the Specifications as being included in the lump sum bid. The bidder shall also bid a unit price for the additional cost of excavating material which is defined in the Specifications as excavation for which additional payment will be made. The total estimated additional cost of removing such material will be taken as the quantity set forth in the Engineer's Estimate multiplied by the unit price bid. This total estimated cost of additional excavation shall be added to the lump sum bid for the General Construction Work for the purpose of comparing bids to determine the low bidder.

(C) Variations from Engineer's Estimate: The Engineer's Estimate of the quantity of excavation for which additional payment will be made is approximate only and is given solely to be used as a uniform basis for the comparison of bids and such estimate is not to be considered as part of this contract. The quantities actually required to complete the contract work may be more or less than the quantities in the Engineer's Estimate and, if so, no action for damages or for loss of profits shall accrue to the contractor by reason thereof.

33. Unit Price Contracts

(A) Comparison of Bids: Bids on Unit Price Contracts will be compared on the basis of a total estimated price, arrived at by taking the sum of the estimated quantities of such items, in accordance with the Engineer's Estimate of Quantities set forth in the Bid Schedule, multiplied by the corresponding unit prices, and including any lump sum bids on individual items.

(B) Variations from Engineer's Estimate: Bidders are warned that the Engineer's Estimate of Quantities on the various items of work and materials is approximate only, given solely to be used as a uniform basis for the comparison of bids, and is not be considered part of this contract. The quantities actually required to complete the contract work may be less or more than so estimated, and if so, no action for damages or for loss of profits shall accrue to the contractor by reason thereof.

(C) Overruns: The terms and conditions applicable to overruns of unit price items are set forth in Article 26 of the Contract.

34. Excise Tax

Bidders are referred to the Specifications for information on Federal Excise Tax exemptions.

35. Licenses and Permits

The successful bidder will be required to obtain all necessary licenses and permits necessary to perform the work.

36. Multiple Prime Contractors

If more than one prime contractor will be involved on this project, all contractors are required to examine the Invitation for Bid packages for all other parts of the project.

37. Locally Based Enterprise Requirements (LBE)

This Contract is subject to the requirements of Administrative Code, Section 6-108.1, and the regulations promulgated thereunder. No construction contract will be awarded unless and until these requirements have been complied with in their entirety. The bidder is advised of the provisions set forth below, as well as the provisions with respect to the Locally Based Enterprise Program contained in Article 67 of the Contract. The contractor is advised that:

(A) If any portion of the Contract is subcontracted, not less than ten percent of the total dollar amount of the contract shall be awarded to locally based enterprises ("LBEs"); except, where less than ten percent of the total dollar amount of the Contract is subcontracted, such lesser percentage shall be so awarded.

(B) No contractor shall require performance and payment bonds from LBE subcontractors.

(C) No Contract shall be awarded unless the contractor first identifies in its bid:

- (1) the percentage, dollar amount and type of work to be subcontracted; and
- (2) the percentage, dollar amount and type of work to be subcontracted to LBEs.

(D) Within ten calendar days after notification of low bid, the apparent low bidder shall submit an "LBE Participation Schedule" to the contracting agency. If such schedule does not identify sufficient LBE subcontractors to meet the requirements of Administrative Code Section 6-108.1, the apparent low bidder shall submit documentation of its good faith efforts to meet such requirements.

(1) The "LBE Participation Schedule" shall include:

- (a) the name and address of each LBE that will be given a subcontract,
- (b) the percentage, dollar amount and type of work to be subcontracted to the LBE, and
- (c) the dates when the LBE subcontract work will commence and end.

(2) The following documents shall be attached to the "LBE Participation Schedule":

- (a) verification letters from each subcontractor listed in the "LBE Participation Schedule" stating that the LBE will enter into a formal agreement for work,
- (b) certification documents of any proposed LBE subcontractor which is not on the LBE certified list, and
- (c) copies of the certification letter of any proposed subcontractor which is an LBE.

(3) Documentation of good faith efforts to achieve the required LBE percentage shall include as appropriate but not limited to the following:

- (a) attendance at prebid meetings, when scheduled by the agency, to advise bidders of contract requirements;

- (b) advertisement where appropriate in general circulation media, trade association publications and small business media of the specific subcontracts that would be at least equal to the percentage goal for LBE utilization specified by the contractor;
- (c) written notification to association of small, minority and women contractors soliciting specific subcontractors;
- (d) written notification by certified mail to LBE firms that their interest in the contract is solicited for specific work items and their estimated values;
- (e) demonstration of efforts made to select portions of the work for performance by LBE firms in order to increase the likelihood of achieving the stated goal;
- (f) documented efforts to negotiate with LBE firms for specific subcontracts, including at a minimum:
  - (i) The names, address and telephone numbers of LBE firms that are contacted;
  - (ii) A description of the information provided to LBE firms regarding the plans and specifications for portions of the work to be performed;
  - (iii) Documentation showing that no reasonable price can be obtained from LBE firms;
  - (iv) A statement of why agreements with LBE firms were not reached;
- (g) a statement of the reason for rejecting any LBE firm which the contractor deemed to be unqualified; and
- (h) documentation of efforts made to assist the LBE firms contacted that needed assistance in obtaining required insurance.

(E) Unless otherwise waived by the Commissioner with the approval of the Office of Economic and Financial Opportunity, failure of a proposed contractor to provide the information required by paragraphs (C) and (D) above may render the bid non-responsive and the Contract may not be awarded to the bidder. If the contractor states that it will subcontract a specific portion of the work, but can demonstrate despite good faith efforts it cannot achieve its required LBE percentage for subcontracted work until after award of Contract, the Contract may be awarded, subject to a letter of compliance from the contractor stating that it will comply with Administrative Code Section 6-108.1 and subject to approval by the Commissioner. If the contractor has not met its required LBE percentage prior to award, the contractor shall demonstrate that a good faith effort has been made subsequent to award to obtain LBEs on each subcontract until it meets the required percentage.

(F) When a bidder indicates prior to award that no work will be subcontracted, no work may be subcontracted without the prior written approval of the Commissioner, which shall be granted only if the contractor in good faith seeks LBE subcontractors at least six weeks prior to the start of work.

(G) The contractor may not substitute or change any LBE which was identified prior to award of the contract without the written permission of the Commissioner. The contractor shall make a written application to the Commissioner for permission to make such substitution or change, explaining why the contractor needs to change its LBE subcontractor and how the contractor will meet its LBE subcontracting requirement. Copies of such application must be served on the originally identified LBE by certified mail return receipt requested, as well as the proposed substitute LBE. The Commissioner shall determine whether or not to grant the contractor's request for substitution.

### 38. Bid Submission Requirements

The following forms, all of which are contained in the Bid Booklet, are to be completed and submitted with the bid:

- (1) Bid Schedule and Bid Form, including Affirmation
- (2) Bid Security (if required, see Attachment 1 on Page A-1)
- (3) M/WBE Subcontractor Utilization Plan (if participation goals have been established)

**FAILURE TO SUBMIT ITEMS (1), (2) AND (3)  
WILL RESULT IN THE DISQUALIFICATION OF THE BID.**

- (4) Safety Questionnaire
- (5) Construction Employment Report (if bid is \$1,000,000 or more)
- (6) Contract Certificate (if bid is less than \$1,000,000)
- (7) Confirmation of Vendex Compliance
- (8) Special Experience Requirements (if applicable to this contract)
- (9) Apprenticeship Program Questionnaire (if applicable)

**FAILURE TO SUBMIT ITEMS (4) THROUGH (9)  
MAY RESULT IN THE DISQUALIFICATION OF THE BID.**

39. Comptroller's Certificate

This Contract shall not be binding or of any force unless it is registered by the Comptroller in accordance with Section 328 of the City Charter and the Procurement Policy Board Rules. This Contract shall continue in force only after annual appropriation of funds by the City of New York and certification as hereinabove set forth.

40. Procurement Policy Board Rules

This Invitation For Bids is subject to the Rules of the Procurement Policy Board of the City of New York. In the event of a conflict between said Rules and a provision of this Invitation For Bids, the Rules shall take precedence.

41. DDC Safety Requirements

The DDC Safety Requirements apply to the work to be performed pursuant to the Contract. The DDC Safety Requirements are set forth on the following pages.

**CITY OF NEW YORK**  
**DEPARTMENT OF DESIGN AND CONSTRUCTION**  
**SAFETY REQUIREMENTS**

June 2015

---

*THE DDC SAFETY REQUIREMENTS INCLUDE THE FOLLOWING SECTIONS:*

- I. POLICY ON SITE SAFETY
- II. PURPOSE
- III. DEFINITIONS
- IV. RESPONSIBILITIES
- V. SAFETY QUESTIONNAIRE
- VI. SAFETY PROGRAM AND SITE SAFETY PLAN
- VII. KICK-OFF/PRE-CONSTRUCTION MEETINGS AND SAFETY REVIEW
- VIII. EVALUATION DURING WORK IN PROGRESS
- IX. SAFETY PERFORMANCE EVALUATION



City of New York Department of Design and Construction: Safety Requirements  
Safety and Site Support– Quality Assurance and Construction Safety

**I. POLICY ON SITE SAFETY**

The City of New York Department of Design and Construction (DDC) is committed to a policy of injury and illness prevention and risk management for construction work that will ensure the safety and health of the workers engaged in the projects and the protection of the general public. Therefore, it is DDC's policy that work carried out by Contractors on DDC jobsites must, at a minimum, comply with applicable federal, state and city laws, rules and regulations, including without limitation:

- U. S. Department of Labor 29 Code of Federal Regulations (CFR) Part 1926 and applicable Sub-parts of Part 1910 – U.S. Occupational Safety and Health Administration (OSHA); New York State Department of Labor Industrial Code Rule 23 – Protection in Construction, Demolition and Excavation;
- New York City Construction Codes, Title 28
- NYC Department of Transportation Title 34 Chapter 2 – Highway Rules
- New York State Department of Labor Industrial Code Rule 16 NYCRR Part 753
- Title 15 of the Rules of the City of New York, Chapter 13 Citywide Construction Dust Mitigation
- Manual on Uniform Traffic Control Devices (MUTCD)
- Title 15 of the Rules of the City of New York, Chapter 28 Citywide Construction Noise Mitigation

**II. PURPOSE**

The purpose of this policy is to ensure that Contractors perform their work and supervise their employees in accordance with all applicable federal, state and city rules and regulations. Further, Contractors will be expected to minimize or eliminate jobsite and public hazards, through a planning, inspection, auditing and corrective action process. The goal is to control risks so that injuries, illnesses and accidents to contractors' employees, DDC employees and the general public, as well as damage to city-owned and private property, are reduced to the lowest level feasible.

**III. DEFINITIONS**

**Agency Chief Contracting Officer (ACCO):** The ACCO shall mean the person delegated authority by the Commissioner to organize and supervise the procurement activity of subordinate Agency staff in conjunction with the CCPO.

**Competent Person:** As defined by OSHA, an individual who is capable of identifying existing and predictable hazards in the surroundings or working conditions that are unsanitary, hazardous, or dangerous to employees or the general public, and who has authorization to take prompt corrective measures to eliminate them.

**Construction Safety Auditor:** A representative of the QA&CS Construction Safety Unit who provides inspection and assessment services to enhance health and safety on all DDC construction projects. The activities of the Construction Safety Auditor include performing site surveys, reviewing health and safety plans, reviewing construction permits, and rendering technical advice and assistance to DDC Resident Engineers and Project Managers.

**Construction Safety Unit:** A part of QA&CS within the Division of Program Management/ Safety & Site Support that assesses contractor safety on DDC jobsites and advises responsible parties of needed corrective actions.

City of New York Department of Design and Construction: Safety Requirements  
Safety and Site Support- Quality Assurance and Construction Safety

**Construction Superintendent:** A representative of the contractor responsible for overseeing performance of the required construction work. This individual must engage in sound construction practices, and is responsible to maintain a safe work site. In the case of a project involving the demolition, alteration or new construction of buildings, the Construction Superintendent must be licensed by the NYC Department of Buildings.

**Contractor:** For purposes of these Safety Requirements, the term "Contractor" shall mean any person or entity that enters into a contract for the performance of construction work on a DDC project. The term "Contractor" shall include any person or entity which enters into any of the following types of contracts: (1) a prime construction contract for a specific project, (2) a prime construction contract using the Job Order Contracting System ("JOCS Contract"), and (3) a subcontract with a CM/Builder ("First Tier Subcontract").

**Daily Safety Job Briefing:** Daily jobsite safety meetings, giving to all jobsite personnel by contractor, with the purpose of discussing project specific safety procedures for the scheduled construction work.

**Director - Quality Assurance and Construction Safety (QA&CS):** Responsible for the operations of the QACS Construction Safety Unit and the DDC Site Safety management programs.

**Job Hazard Analysis (JHA):** A process of identifying the major job steps and any potential site-specific hazards that may be present during construction and establishing the means and methods to eliminate or control those hazards.

**Qualified Person:** As defined by OSHA, an individual who, by possession of a recognized degree, certificate, license or professional standing, or who by extensive knowledge, training, and experience, has successfully demonstrated his or her ability to solve problems relating to the subject matter, the work, or the project. Qualified Persons are required under regulation to address issues pertaining, but without limit, to fall protection, scaffold design and trenching and shoring, among others.

**Project Site:** Those areas indicated in the Contract Documents where the Work is to be performed.

**Project Safety Representative:** The designated project safety representative shall have completed an authorized 30 hour OSHA Construction Safety Course and other safety training applicable to Contractor's/subcontractor's project work. Except in instances where a dedicated Project Safety Manager is required, a Project Safety Representative may also function as a superintendent, foreman or crew leader on the Project, but must have sufficient experience and authority to undertake corrective actions and must qualify to be a competent person. No work is to be performed on site when a Project Safety Representative is not present.

**Project Safety Manager:** A dedicated, full-time project safety manager may be a contractual requirement on large projects or projects deemed by DDC to be particularly high risk. This would be in addition or in lieu of a Contractor's Project Safety Representative. This individual shall not have any other assigned duties. This individual shall have received, at a minimum an authorized 30 hour OSHA Construction Safety Course. Other examples of acceptable training are OSHA Safety and Health Standards for the Construction Industry training program (OSHA 510), Certified Safety Professional (CSP), Certified Industrial Hygienist (CIH) or a degree/certificate in a safety and health from a college-level curriculum.

A Project Safety Manager shall possess the additional training, years of experience, and skills necessary to thoroughly understand the health and safety hazards and controls for large construction projects, including the full scope of the specific Work.

**QA&CS - Quality Assurance and Construction Safety of the New York City Department of Design and Construction.**

City of New York Department of Design and Construction: Safety Requirements  
Safety and Site Support– Quality Assurance and Construction Safety

**Resident Engineer (RE) / Construction Project Manager (CPM):** Representative of the Commissioner duly designated by the Commissioner to be his/her representative at the site of the work. (The RE/CPM may be a third-party consultant, including a Construction Management firm, retained by DDC)

**Safety Program:** Established by the Contractor that covers all operations of that Contractor and establishes the Contractor's overall safety policy, regulatory compliance plan and minimum safety standards. The Safety Program must be submitted prior to the commencement of work at the site and is subject to review and acceptance by the Construction Safety Unit.

**Safety Questionnaire:** Used by DDC to evaluate Contractor's current and past safety performance. It is required to be completed by all Contractors initially when submitting bids for Construction work, or when being pre-qualified and updated annually or as requested by the DDC.

**Site Safety Manager:** For certain projects, as defined in NYC Construction Codes – Title 28, the Contractor shall provide a Site Safety Manager with a Site Safety Manager License issued by the NYC Department of Building.

**Site Safety Plan:** A site-specific safety plan developed by the Contractor for a specific project. The Site Safety Plan must identify hazards associated with the project, and include specific safety procedures and training appropriate and necessary to complete the work. The Site Safety Plan must be submitted prior to the commencement of work at the site and is subject to review and acceptance by the Construction Safety Unit.

**Unsafe or Unhealthy Condition:** A condition that could be potentially hazardous to the health and safety of personnel or the public, and/or damaging to equipment, machinery, property or the environment.

**Weekly Safety Meetings:** Weekly documented jobsite safety meetings, given to all jobsite personnel by contractor, with the purpose of discussing general safety topics and job specific requirements encountered at the DDC work site.

**Work:** The construction required by the Contract Documents whether completed or partially completed, performed by the Contractor/ subcontractors. Work refers to the furnishing of labor, furnishing and incorporating materials and equipment into the construction and providing any service required by the Contract Documents to fulfill the Contractor's obligation to complete the Project.

#### IV. RESPONSIBILITIES

All persons who manage, perform, and provide support for construction projects shall conduct operations in compliance with the requirements identified in this Policy and all applicable governing regulatory agency requirements and guidelines pertaining to safety in construction.

##### A. DDC or CM Resident Engineer / Construction Project Manager

- Monitors the issuance of safety-related permits, approvals and drawings and maintains copies on site.
- Monitors construction-related work activities to confirm that they are conducted in accordance with DDC policies and all applicable regulations that pertain to construction safety.
- Maintains documentation and periodically attends weekly safety meetings and daily safety job briefings.
- Notifies the Construction Safety Unit and the ACCO's Insurance and Risk Management Unit of project-related accidents and emergencies, as per DDC's Construction Safety Emergency and Accident Notification and Response Protocol.
- Gathers facts related to all accidents and prepares DDC Construction Accident Report.

City of New York Department of Design and Construction: Safety Requirements  
Safety and Site Support-- Quality Assurance and Construction Safety

- Notifies the Construction Safety Unit within two (2) hours of the start of an inspection by any outside regulatory agency personnel, including OSHA, NYC DOB or others and forwards a copy of the inspection report within three days of its receipt.
- Monitors the conditions at the site for conformance with the contractor's Site Safety Plan and DDC construction documents.
- Notifies the contractor and DDC in the event that any condition or activity exists that is not in compliance with the contractor's Site Safety Plan, applicable federal, state or local codes or any condition that presents a potential risk of injury to the public or workers or possible damage to property.
- Notifies DDC of any unsafe or unhealthy condition and directs the contractor to provide such labor, materials, equipment and supervision to abate such conditions.
- Escort and assist QA&CS Construction Safety Auditors during the field and record inspections.
- Reports emergency conditions to the Construction Safety Unit immediately.

**B. Contractors**

- Submit a completed Safety Questionnaire and other safety performance related documentation with its bid or as part of a pre-qualification package.
- Complete a written Job Hazard Analysis (JHA) that identifies safety hazards for project specific work tasks and hazard control methods. A written JHA shall be available at the site for reference and included in the Site Safety Plan submitted by the contractor.
- Submit a Site Safety Plan and Safety Program within 30 days from the Award Date or as otherwise directed. The Site Safety Plan and Safety Program are subject to review and acceptance by the Construction Safety Unit prior to the commencement of work at the site. The Site Safety Plan shall be revised and updated as necessary.
- Develop project specific safety procedures to protect general public during all construction activities for the duration of the project.
- Ensure that all employees are aware of the hazards associated with the project through documented formal and informal training and/or other communications. Conduct and document weekly safety meetings and daily job briefing sessions for the duration of the project. Documentation to be provided to the RE/CPM on a monthly basis.
- Name the Project Safety Representative and Project Safety Manager, if required. The Contractor will be required to identify the Project Safety Representative and Project Safety Manager in the Site Safety Plan. Resumes, outlining the qualification and experience for the Project Safety Representative and Project Safety Manager, shall be available upon request. DDC reserves the right to request that the Contractor replace any Project Safety Representative or Project Safety Manager for any reason at any time during the project.
- Name a Competent Person(s), The Contractor will be required to identify a Competent Person(s) in the Site Safety Plan.
- Comply with all mandated federal, state and local safety and health rules and regulations.
- Comply with all provisions of the Site Safety Plan.
- Conduct applicable safety training prior to the commencement of work at the site. All training records (OSHA 10-hour, flagger, scaffold, fall protection, confined space entry, etc.) shall be provided to the RE/CPM prior to mobilization, included in the Site Safety Plan, kept current during the course of the project, and available for review. Prior to performing any work on DDC project all employees shall have successfully completed, within the previous five calendar years, a 10 Hour OSHA construction safety course.
- As part of the Site Safety Plan, prepare a site specific programs and plans, such as MPT plan, steel erection plan, confined space program, fall protection plan, demolition plan, etc. (if not otherwise provided in the contract documents) and comply with all of its provisions.
- Conduct and document site-specific safety orientation for Contractor personnel to review the hazards associated with the project as identified in the Site Safety Plan and the specific safety procedures and

City of New York Department of Design and Construction: Safety Requirements  
Safety and Site Support– Quality Assurance and Construction Safety

controls that will be used to protect workers, the general public and property. The Project Safety Representative and/or Project Safety Manager will conduct this training prior to mobilization and provide documentation to the RE/CPM.

- Provide, replace and adequately maintain at or around the project site, suitable and sufficient signage, lights, barricades and enclosures (fences, sidewalk sheds, netting, bracing, etc.).
- Report unsafe or unhealthy conditions to the RE/CPM as soon as practical, but no more than 24 hours after discovery, and take prompt actions to remove or abate such conditions.
- Report any accidents involving injuries to workers or the general public, as well as property damage, to the RE/CPM within one (1) hour.
- Following an accident, the Contractor shall not remove or alter any equipment, structure, material, or evidence related to the accident. Exception: Immediate emergency procedures taken to secure structures, temporary construction, operations, or equipment that pose a continued imminent danger or facilitate assistance for persons who are trapped or who have sustained bodily injury.
- Notify the RE/CPM within one (1) hour of the start of an inspection by any outside regulatory agency personnel, including OSHA, NYC DOB or others.
- Maintain all records pertaining to all required compliance documents and accident and injury reports.
- Address DDC recommendations on safety, which shall in no way relieve the Contractor of its responsibilities for safety on the project. The Contractor has sole responsibility for safety.

#### V. SAFETY QUESTIONNAIRE

DDC requires that all Contractors provide information regarding their current and past safety performance and programs. This will be accomplished by the use of the DDC Safety Questionnaire. As a part of the bid submittal package, the contractor must submit a completed DDC Safety Questionnaire listing company workers' compensation experience modification rating and OSHA Incident Rates for the three (3) years prior to the date of the bid opening. DDC may request a Contractor to update its Questionnaire at any time or to provide more detailed information. The Contractor must provide the requested information within 15 days.

The following criteria will be used by DDC in reviewing the Contractor's responsibility, which will be based on the information provided on the questionnaire:

- Criteria 1: OSHA Injury and Illness Rates (I&IR) are no greater than the average for the industry (based on the most current Bureau of Labor Statistics data for the Contractors SIC code); and
- Criteria 2: Insurance workers compensation Experience Modification Rate (EMR) equal to or less than 1.0; and
- Criteria 3: Any willful violations issued by OSHA or NYC DOB within the last three (3) years; and
- Criteria 4: A fatality (worker or member of public) and injuries, requiring OSHA notification, experienced on or near Contractor's worksite within the last three (3) years; and
- Criteria 5: Past safety performance on DDC projects (accidents; status of safety program and site safety plan submittals; etc.)
- Criteria 6: OSHA violation history for the last three (3) years;
- Criteria 7: Contractor shall provide OSHA Injury and Illness Records (currently OSHA 300 and 300A Logs) for the last three (3) years.

If the Contractor fails to meet the basic criteria listed above, the Construction Safety Unit may request, through the ACCO, more details concerning the Contractor's safety experience. DDC may request the Contractor to provide copies of, among other things, accident investigation reports, OSHA records, OSHA and NYC DOB citations, EPA citations and written corrective action plan.

City of New York Department of Design and Construction: Safety Requirements  
Safety and Site Support- Quality Assurance and Construction Safety

**VI. SAFETY PROGRAM AND SITE SAFETY PLAN**

Within thirty (30) days from the Award Date, or as otherwise directed, the Contractor shall submit the following: (1) Safety Program, and (2) Site Safety Plan. The Safety Program shall set forth the Contractor's overall safety policy, regulatory compliance plan and minimum safety standards. The Site Safety Plan shall identify project work scope, safety hazards associated with the project tasks, and include specific safety procedures and training appropriate and necessary to complete the work. The Safety Program and the Site Safety Plan are subject to review and acceptance by the Construction Safety Unit prior to the commencement of work at the site. Failure by the Contractor to submit an acceptable Site Safety Plan and Safety Program shall be grounds for default.

**Safety Program:** Corporate Safety Program established by the Contractor that includes the Contractor's overall safety policy, regulatory compliance plan and basic safety procedures covering all aspects of construction operations, performed by the Contractor. The Safety Program shall be a written document with a separate section describing each element of the Safety Program. The Safety Program shall have at minimum the following elements applicable to the Contractor's operations:

- Responsibility and Organization – Contractor's company organization chart, including titles, names, contact information, roles and responsibilities for key personnel, etc.
- Safety Training Program – Contractor's corporate training program.
- Hazard Corrective Actions – Criteria for safety inspections, identification of safety non-compliances, implementation and verification of corrective actions, forms to document safety inspections results, etc.
- Accident/Exposure Investigation
- Recordkeeping and Reporting Injuries – Responsible staff; reporting and recording criteria; OSHA 300 and 300A form completion, etc.
- Fire Protection and Prevention Program
- Housekeeping
- Illumination
- Sanitation
- Personal Protective Equipment (PPE) – Company policy for the use of head protection, foot protection, hearing protection, eye and face protection, protective clothing, and any additional protective equipment based on work tasks; PPE inspection and replacement policy.
- Hazard Communication Program
- Employee Emergency Action Plan
- Protection of Underground Facilities and Utilities
- Ionizing/Nonionizing Radiation
- Material Handling, Storage, Use and Disposal
- Tools – Hand and Power
- Signs, Signals, and Barricades
- Scaffold – Local Law 52 requirements, installation, use, inspection, dismantling, training and general safety requirements.
- Welding and Cutting
- Electrical Safety
- Fall Protection
- Cranes, Derrick, Hoists, Elevators, Conveyors
- Excavation Safety
- Concrete and Masonry Construction
- Maintenance and Protection of Traffic
- Steel Erection
- Demolition
- Blasting and the Use of Explosives
- Stairways and Ladders

City of New York Department of Design and Construction: Safety Requirements  
Safety and Site Support– Quality Assurance and Construction Safety

- Toxic and Hazardous Substances
- Alcohol and Drug Abuse Policy
- Rodents and Vermin
- Occupational Noise Exposure
- Confined Space Program – General confined Space Program: training requirements, confined space hazard evaluation procedure, atmospheric testing procedure, confined space classification, permit-required procedure, communication procedure, rescue procedure, forms, etc.
- Construction Vehicles/Heavy Equipment
- Dust Control Procedures

Site Safety Plan: The Site Safety Plan shall be a written document and shall apply to all project specific Contractor and subcontractor operations, and shall have at a minimum, the following elements with each element described in a separate section (It may be necessary to modify the basic format for certain unique or high-risk projects, such as tunnels or high-rise construction):

- Project Work Scope – Detailed information regarding work tasks that will be performed by contractor and subcontractors under the project.
- Responsibility and Organization – Contractor’s organization chart with responsible staff for the project, including titles, names, contact information, roles and responsibilities.
- Safety Training and Education – OSHA 10 Hours training, requirements for daily safety briefings and weekly safety meetings, any work task specific training, responsible staff for implementation of training program for the project.
- Job Hazard Analysis (JHA) – Project specific Job Hazard Analysis including work tasks, identified hazards, hazard control methods (administrative, engineering, PPE), contractor’s name, project id, location, name and signature of a certifying person, hazard assessment date.
- Protection of Public
- Hazard Corrective Actions – Responsible staff, forms, frequency of safety inspections and implementation of corrective actions.
- Accident/Exposure Investigation – Accident/incident notification procedure of DDC project staff. Project specific procedures for accident investigation and implementation of corrective actions.
- First Aid and Medical Attention – Responsible staff, location and inspection of First Aid kit, directions to local hospitals; emergency telephone numbers.
- Project Specific Fire Protection and Prevention Program.
- Project Specific Illumination Procedure.
- Project Specific Sanitation Procedure.
- Personal Protective Equipment (PPE)
- Hazard Communication Program – Responsible staff; training; SDS records, project specific list of chemical; location of the program and SDS records.
- Means of Egress – Information regarding free and unobstructed egress from all parts of the building or structure; exit marking; maintenance of means of egress, etc.
- Employee Emergency Action Plan – Project specific: responsible staff, emergency alarm system, evacuation procedure, procedure to account for employees after evacuation, etc.
- Evacuation Plan – Project specific evacuation plan (drawing/scheme) with exists and evacuation routes.
- Protection of Underground Facilities and Utilities, including responsible staff.
- Ionizing/Nonionizing Radiation – Competent person, license and qualification requirements, type of radiation, employees exposure and protection, etc.
- Material Handling, Storage, Use and Disposal – Project specific information regarding material storage and disposal.
- Signs, Signals, and Barricades – Use of danger/warning signs, sidewalk closure, safety instruction signs, pedestrian fencing and barricades, etc.
- Scaffold – Project specific scaffold types, training, scaffold drawings, competent person, criteria for project specific scaffold, falling object protection.

City of New York Department of Design and Construction: Safety Requirements  
Safety and Site Support- Quality Assurance and Construction Safety

- Welding and Cutting – project specific procedure for welding and cutting, including all necessary safety requirements such as fire prevention, personal protective equipment, hot work permits, FDNY certificate requirements.
- Fall Protection – Project specific information regarding selected fall protection systems, fall protection plan.
- Cranes, Derrick, Hoists, Elevators, Conveyors – project specific equipment information including type, rated load capacity, manufacture specification requirements, competent person, exposure to falling load, inspection, recordkeeping, clearance requirements, communication procedure, ground lines, permits.
- Excavation Safety – Competent person, project specific protective system.
- Maintenance and Protection of Traffic Plan – Project specific MPT plan, flagmen training.
- Steel Erection – Site specific erection plan, requirements for applicable written notifications, competent person.
- Demolition – Engineering survey, including written evidence, disconnection of all effected utilities, identification of all hazardous chemicals, materials, gases, etc., floor openings, chutes, inspection and maintenance of all stairs/passageways, removal of materials/debris/structural elements, lock out/tag out, competent person.
- Blasting and the Use of Explosives – Project specific safety procedures, warning signs, training/qualification, transportation, storage and use of explosives, inspection.
- Toxic and Hazardous Substances – Safety procedures for substances to be used on project.
- Noise Mitigation Plan – Completed project specific Noise Mitigation Plan.
- Confined Space Program – Project specific Confined Space Program, responsible staff, training records, equipment information, rescue procedure, list of project specific confined spaces, forms.
- Construction Vehicles/Heavy Equipment – Type of construction vehicles/heavy equipment to be used on site.
- Dust Mitigation Plan – Completed project specific Dust Mitigation Plan.

The most critical component of the Site Safety Plan is the Job Hazard Analysis (JHA) section. The JHA form is a written document prepared by the contractor. The contractor must conduct a site and task assessment JHA to identify the major job steps and any potential safety or environmental hazards related to performance of the work, eliminate or implement controls for the potential hazards, and identify proper personal protective equipment for the task. The JHA shall be communicated to all contractor/subcontractor personnel on site.

The initial Job Hazard Assessment form shall be included in the contractor's Site Safety Plan and the current form shall be available at the construction site for reference.

Certain DDC programs, such as Job Order Contracting System (JOCS), may not necessarily require Site Safety Plans. The JOCS contractor shall submit a Safety Program. The Site Safety Plan requirement for the JOCS contractor will be determined by QA&CS based on a project work scope, construction activities and project location. In addition, certain DDC Operating Units may establish client-specific program or safety requirements. The contractor's Site Safety Plan must address such client-specific program or safety requirements.

## VII. KICK-OFF MEETINGS/PRE-CONSTRUCTION AND SAFETY REVIEW

RE/CPM shall invite QA&CS Construction Safety Unit to the construction kick-off meeting. A QA&CS representative will participate in this meeting with the Contractor and RE/CPM prior to the start of the project for the purpose of:

- A. Reviewing the safety issues detailed in the contract.
- B. Reviewing the Site Safety Plan.
- C. Reviewing any new issues or information that was not previously addressed.
- D. Discussing planned inspections and audits of the site by QA&CS personnel.



City of New York Department of Design and Construction: Safety Requirements  
Safety and Site Support- Quality Assurance and Construction Safety

**VIII. EVALUATION DURING WORK IN PROGRESS**

The Contractor's adherence to these Safety Requirements will be monitored throughout the project. This will be accomplished by the following:

- A. Use of a safety checklist by a representative of the Construction Safety Unit or other designated DDC representative or Consultant during regular, unannounced inspections of the job site. Field Exit Conferences will be held with the RE/CPM, Contractor Project Safety Representatives.
- B. The RE/CPM will continually monitor the safety and environmental performance of the contractor's employees and work methods. Deficiencies shall be brought to the attention of the contractor's representative on site for immediate correction. The DDC representative will maintain a written record of these deficiencies and have these records available upon request. Any critical deficiencies shall be immediately reported to QA&CS phone# (718) 391-1624 or (718) 391-1911.
- C. If the Contractor's safety performance during the project is not up to DDC standards (safety performance measure, accident/incident rate, etc.) the Director - QA&CS, or his/her designee will meet with the Contractor's Project Safety Representative and or Project Safety Manager, the DDC Project Manager, the RE/CPM, and the DDC Environmental Specialist (if environmental issues are involved). The purpose of this meeting is to 1) determine the level of non-compliance; 2) explain and clarify the safety/environmental provisions; 3) agree on a future course of action to correct the deficiencies.
- D. If the deficiencies continue to occur with inadequate attention by the contractor, this shall, among other remedies available, be grounds for default.
- E. The contractor shall within 1 hour inform the RE/CPM/CM of all accidents/incidents including all fatalities, any injuries to employees or members of the general public, and property damage (e.g., structural damage, equipment rollovers, utility damage, loads dropped from crane). The RE/CPM shall notify the Construction Safety Unit as per DDC's Construction Safety Emergency and Accident Notification and Response Protocol and shall maintain a record of all contractor accidents/incidents for the project.
- F. The Construction Safety Unit shall be notified within two (2) hours of the start of any NYS-DOL/ NYC-COSH/ OSHA/ EPA inspections.

**IX. SAFETY PERFORMANCE EVALUATION**

The contractor's safety record, including accident/incident history and DDC safety inspection results, will be considered as part of the Contractor's performance evaluation at the conclusion of the project. Poor safety performance during the course of the project shall be a reason to rate a Contractor unsatisfactory which may be reflected in the City's Vendex system and will be considered for future procurement actions as set forth in the City's Procurement Policy Board Rules.

**NEW YORK CITY STANDARD CONSTRUCTION CONTRACT (DEC. 2013)  
INSURANCE RIDER**

The following provisions supersede the corresponding provisions in the December 2013 version of the New York City Standard Construction Contract:

1. Section 22.1.1(c) provides as follows:

22.1.1(c) If the **Work** requires a permit from the Department of Buildings pursuant to 1 RCNY Section 101-08, the **Contractor** shall provide Commercial General Liability Insurance with limits of at least those required by 1 RCNY section 101-08 or greater limits provided by the Agency in Schedule A. If the Work does not require such a permit, the minimum limits shall be those provided for in Schedule A.

2. Section 22.3.3 provides as follows:

22.3.3 For policies provided pursuant to all of Article 22.1 other than Article 22.1.2, the **Contractor** shall submit one or more Certificates of Insurance on forms acceptable to the **Commissioner**. All such Certificates of Insurance shall certify (a) the issuance and effectiveness of such policies of insurance, each with the specified minimum limits (b) for insurance secured pursuant to Article 22.1.1 that the **City** and any other entity specified in Schedule A is an Additional Insured thereunder; (c) in the event insurance is required pursuant to Article 22.1.6 and/or Article 22.1.7, that the **City** is an Additional Insured thereunder; and (d) the company code issued to the insurance company by the National Association of Insurance Commissioners (the NAIC number). All such Certificates of Insurance shall be accompanied by the required additional insured endorsements and either a duly executed "Certification by Insurance Broker or Agent" in the form contained in Part III of Schedule A or copies of all policies referenced in such Certificate of Insurance as certified by an authorized representative of the issuing insurance carrier. If any policy is not available at the time of submission, certified binders may be submitted until such time as the policy is available, at which time a certified copy of the policy shall be submitted.

(NO TEXT ON THIS PAGE)

**CITY OF NEW YORK**  
**STANDARD CONSTRUCTION CONTRACT**

**DECEMBER 2013**

**(NO TEXT ON THIS PAGE)**

**CITY OF NEW YORK  
STANDARD CONSTRUCTION CONTRACT**

**TABLE OF CONTENTS**

<b>CHAPTER I</b>		
<b><u>THE CONTRACT AND DEFINITIONS</u></b>		
ARTICLE 1.	THE CONTRACT	1
ARTICLE 2.	DEFINITIONS	1
<b>CHAPTER II</b>		
<b><u>THE WORK AND ITS PERFORMANCE</u></b>		
ARTICLE 3.	CHARACTER OF THE WORK	4
ARTICLE 4.	MEANS AND METHODS OF CONSTRUCTION	4
ARTICLE 5.	COMPLIANCE WITH LAWS	5
ARTICLE 6.	INSPECTION	10
ARTICLE 7.	PROTECTION OF WORK AND OF PERSONS AND PROPERTY; NOTICES AND INDEMNIFICATION	11
<b>CHAPTER III</b>		
<b><u>TIME PROVISIONS</u></b>		
ARTICLE 8.	COMMENCEMENT AND PROSECUTION OF THE WORK	12
ARTICLE 9.	PROGRESS SCHEDULES	12
ARTICLE 10.	REQUESTS FOR INFORMATION OR APPROVAL	13
ARTICLE 11.	NOTICE OF CONDITIONS CAUSING DELAY AND DOCUMENTATION OF DAMAGES CAUSED BY DELAY	13
ARTICLE 12.	COORDINATION WITH OTHER CONTRACTORS	17
ARTICLE 13.	EXTENSION OF TIME FOR PERFORMANCE	18
ARTICLE 14.	COMPLETION AND FINAL ACCEPTANCE OF THE WORK	21
ARTICLE 15.	LIQUIDATED DAMAGES	22
ARTICLE 16.	OCCUPATION OR USE PRIOR TO COMPLETION	22
<b>CHAPTER IV</b>		
<b><u>SUBCONTRACTS AND ASSIGNMENTS</u></b>		
ARTICLE 17.	SUBCONTRACTS	23
ARTICLE 18.	ASSIGNMENTS	25

**CITY OF NEW YORK  
STANDARD CONSTRUCTION CONTRACT**

**TABLE OF CONTENTS**

**CHAPTER V  
CONTRACTOR'S SECURITY AND GUARANTY**

ARTICLE 19.	SECURITY DEPOSIT	26
ARTICLE 20.	PAYMENT GUARANTEE	26
ARTICLE 21.	RETAINED PERCENTAGE	29
ARTICLE 22.	INSURANCE	29
ARTICLE 23.	MONEY RETAINED AGAINST CLAIMS	35
ARTICLE 24.	MAINTENANCE AND GUARANTY	36

**CHAPTER VI  
CHANGES, EXTRA WORK AND DOCUMENTATION OF CLAIM**

ARTICLE 25.	CHANGES	37
ARTICLE 26.	METHODS OF PAYMENT FOR OVERRUNS AND EXTRA WORK	37
ARTICLE 27.	RESOLUTION OF DISPUTES	40
ARTICLE 28.	RECORD KEEPING FOR EXTRA OR DISPUTED WORK OR WORK ON A TIME & MATERIALS BASIS	44
ARTICLE 29.	OMITTED WORK	45
ARTICLE 30.	NOTICE AND DOCUMENTATION OF COSTS AND DAMAGES; PRODUCTION OF FINANCIAL RECORDS	45

**CHAPTER VII  
POWERS OF THE RESIDENT ENGINEER, THE ENGINEER  
OR ARCHITECT AND THE COMMISSIONER**

ARTICLE 31.	THE RESIDENT ENGINEER	46
ARTICLE 32.	THE ENGINEER OR ARCHITECT OR PROJECT MANAGER	47
ARTICLE 33.	THE COMMISSIONER	47
ARTICLE 34.	NO ESTOPPEL	48

**CHAPTER VIII  
LABOR PROVISIONS**

ARTICLE 35.	EMPLOYEES	48
ARTICLE 36.	NO DISCRIMINATION	50
ARTICLE 37.	LABOR LAW REQUIREMENTS	52
ARTICLE 38.	PAYROLL REPORTS	57
ARTICLE 39.	DUST HAZARDS	58

---

**CITY OF NEW YORK  
STANDARD CONSTRUCTION CONTRACT**

**TABLE OF CONTENTS**

**CHAPTER IX**

**PARTIAL AND FINAL PAYMENTS**

ARTICLE 40.	CONTRACT PRICE	58
ARTICLE 41.	BID BREAKDOWN ON LUMP SUM	58
ARTICLE 42.	PARTIAL PAYMENTS	58
ARTICLE 43.	PROMPT PAYMENT	59
ARTICLE 44.	SUBSTANTIAL COMPLETION PAYMENT	59
ARTICLE 45.	FINAL PAYMENT	60
ARTICLE 46.	ACCEPTANCE OF FINAL PAYMENT	61
ARTICLE 47.	APPROVAL BY PUBLIC DESIGN COMMISSION	62

**CHAPTER X**

**CONTRACTOR'S DEFAULT**

ARTICLE 48.	COMMISSIONER'S RIGHT TO DECLARE CONTRACTOR IN DEFAULT	62
ARTICLE 49.	EXERCISE OF THE RIGHT TO DECLARE DEFAULT	64
ARTICLE 50.	QUITTING THE SITE	64
ARTICLE 51.	COMPLETION OF THE WORK	64
ARTICLE 52.	PARTIAL DEFAULT	64
ARTICLE 53.	PERFORMANCE OF UNCOMPLETED WORK	65
ARTICLE 54.	OTHER REMEDIES	65

**CHAPTER XI**

**MISCELLANEOUS PROVISIONS**

ARTICLE 55.	CONTRACTOR'S WARRANTIES	66
ARTICLE 56.	CLAIMS AND ACTIONS THEREON	66
ARTICLE 57.	INFRINGEMENT	66
ARTICLE 58.	NO CLAIM AGAINST OFFICERS, AGENTS OR EMPLOYEES	67
ARTICLE 59.	SERVICE OF NOTICES	67
ARTICLE 60.	UNLAWFUL PROVISIONS DEEMED STRICKEN FROM CONTRACT	67
ARTICLE 61.	ALL LEGAL PROVISIONS DEEMED INCLUDED	67
ARTICLE 62.	TAX EXEMPTION	67
ARTICLE 63.	INVESTIGATION(S) CLAUSE	69
ARTICLE 64.	TERMINATION BY THE CITY	71
ARTICLE 65.	CHOICE OF LAW, CONSENT TO JURISDICTION AND VENUE	73



**CITY OF NEW YORK  
STANDARD CONSTRUCTION CONTRACT**

**TABLE OF CONTENTS**

**CHAPTER XI (CONT'D)  
MISCELLANEOUS PROVISIONS**

<b>ARTICLE 66.</b>	<b>PARTICIPATION IN AN INTERNATIONAL BOYCOTT</b>	<b>74</b>
<b>ARTICLE 67.</b>	<b>LOCALLY BASED ENTERPRISE PROGRAM</b>	<b>74</b>
<b>ARTICLE 68.</b>	<b>ANTITRUST</b>	<b>75</b>
<b>ARTICLE 69.</b>	<b>MACBRIDE PRINCIPLES PROVISIONS</b>	<b>75</b>
<b>ARTICLE 70</b>	<b>ELECTRONIC FILING/NYC DEVELOPMENT HUB</b>	<b>77</b>
<b>ARTICLE 71.</b>	<b>PROHIBITION OF TROPICAL HARDWOODS</b>	<b>77</b>
<b>ARTICLE 72.</b>	<b>CONFLICTS OF INTEREST</b>	<b>78</b>
<b>ARTICLE 73.</b>	<b>MERGER CLAUSE</b>	<b>78</b>
<b>ARTICLE 74.</b>	<b>STATEMENT OF WORK</b>	<b>78</b>
<b>ARTICLE 75.</b>	<b>COMPENSATION TO BE PAID TO CONTRACTOR</b>	<b>78</b>
<b>ARTICLE 76:</b>	<b>ELECTRONIC FUNDS TRANSFER</b>	<b>78</b>
<b>ARTICLE 77:</b>	<b>RECORDS RETENTION</b>	<b>79</b>
<b>ARTICLE 78:</b>	<b>PARTICIPATION BY MINORITY-OWNED AND WOMEN-OWNED BUSINESS ENTERPRISES IN CITY PROCUREMENT</b>	<b>79</b>
<b>SIGNATURES</b>		<b>87</b>
<b>ACKNOWLEDGMENT BY CORPORATION</b>		<b>88</b>
<b>ACKNOWLEDGMENT BY PARTNERSHIP</b>		<b>88</b>
<b>ACKNOWLEDGMENT BY INDIVIDUAL</b>		<b>88</b>
<b>ACKNOWLEDGMENT BY COMMISSIONER</b>		<b>89</b>
<b>AUTHORITY</b>		<b>90</b>
<b>COMPTROLLER'S CERTIFICATE</b>		<b>90</b>
<b>MAYOR'S CERTIFICATE</b>		<b>91</b>
<b>PERFORMANCE BOND #1</b>		<b>92</b>
<b>PERFORMANCE BOND #2</b>		<b>96</b>
<b>PAYMENT BOND</b>		<b>100</b>

**WITNESSETH:**

The parties, in consideration of the mutual agreements contained herein, agree as follows:

**CHAPTER I  
THE CONTRACT AND DEFINITIONS**

**ARTICLE 1. THE CONTRACT**

1.1 Except for titles, subtitles, headings, running headlines, tables of contents and indices (all of which are printed herein merely for convenience), the following, except for such portions thereof as may be specifically excluded, shall be deemed to be part of this Contract:

1.1.1 All provisions required by law to be inserted in this Contract, whether actually inserted or not;

1.1.2 The Contract Drawings and Specifications;

1.1.3 The General Conditions and Special Conditions, if any;

1.1.4 The Contract;

1.1.5 The Information for Bidders; Request for Proposals; Notice of Solicitation and Proposal For Bids; Bid or Proposal, and, if used, the Bid Booklet;

1.1.6 All Addenda issued prior to the receipt of the bids; the Notice of Award; Performance and Payment Bonds, if required; and the Notice to Proceed or the Order to Work.

1.2 Should any conflict occur in or between the Drawings and Specifications, the Contractor shall be deemed to have estimated the most expensive way of doing the Work, unless the Contractor shall have asked for and obtained a decision in writing from the Commissioner of the Agency that is entering into this Contract, before the submission of its bid, as to what shall govern.

**ARTICLE 2. DEFINITIONS**

2.1 The following words and expressions, or pronouns used in their stead, shall, wherever they appear in this Contract, be construed as follows, unless a different meaning is clear from the context:

2.1.1 "**Addendum**" or "**Addenda**" shall mean the additional Contract provisions and/or technical clarifications issued in writing by the Commissioner prior to the receipt of bids.

2.1.2 "**Agency**" shall mean a city, county, borough or other office, position, department, division, bureau, board or commission, or a corporation, institution or agency of government, the expenses of which are paid in whole or in part from the City treasury.

2.1.3 "**Agency Chief Contracting Officer**" (ACCO) shall mean a person delegated authority by the Commissioner to organize and supervise the procurement activity of subordinate Agency staff in conjunction with the CCPO, or his/her duly authorized representative.

2.1.4 **"Allowance"** shall mean a sum of money which the Agency may include in the total amount of the Contract for such specific contingencies as the Agency believes may be necessary to complete the Work, e.g., lead or asbestos remediation, and for which the Contractor will be paid on the basis of stipulated unit prices or a formula set forth in the Contract or negotiated between the parties provided, however, that if the Contractor is not directed to use the Allowance, the Contractor shall have no right to such money and it shall be deducted from the total amount of the Contract.

2.1.5 **"City"** shall mean the City of New York.

2.1.6 **"City Chief Procurement Officer" (CCPO)** shall mean a person delegated authority by the Mayor to coordinate and oversee the procurement activity of Mayoral agency staff, including the ACCO and any offices which have oversight responsibility for the procurement of construction, or his/her duly authorized representative.

2.1.7 **"Commissioner"** shall mean the head of the Agency that has entered into this Contract, or his/her duly authorized representative.

2.1.8 **"Comptroller"** shall mean the Comptroller of the City of New York.

2.1.9 **"Contract"** or **"Contract Documents"** shall mean each of the various parts of the contract referred to in Article 1 hereof, both as a whole and severally.

2.1.10 **"Contract Drawings"** shall mean only those drawings specifically entitled as such and listed in the Specifications or in any Addendum, or any drawings furnished by the Commissioner, pertaining or supplemental thereto.

2.1.11 **"Contract Work"** shall mean everything required to be furnished and done by the Contractor by any one or more of the parts of the Contract referred to in Article 1, except Extra Work as hereinafter defined.

2.1.12 **"Contractor"** shall mean the entity which executed this Contract, whether a corporation, firm, partnership, joint venture, individual, or any combination thereof, and its, their, his/her successors, personal representatives, executors, administrators, and assigns, and any person, firm, partnership, joint venture, individual, or corporation which shall at any time be substituted in the place of the Contractor under this Contract.

2.1.13 **"Days"** shall mean calendar days, except where otherwise specified.

2.1.14 **"Engineer"** or **"Architect"** or **"Project Manager"** shall mean the person so designated in writing by the Commissioner in the Notice to Proceed or the Order to Work to act as such in relation to this Contract, including a private Architect or Engineer or Project Manager, as the case may be. Subject to written approval by the Commissioner, the Engineer, Architect or Project Manager may designate an authorized representative.

2.1.15 **"Engineering Audit Officer" (EAO)** shall mean the person so designated by the Commissioner to perform responsible auditing functions hereunder.

2.1.16 **"Extra Work"** shall mean Work other than that required by the Contract at the time of award which is authorized by the Commissioner pursuant to Chapter VI of this Contract.

2.1.17 **"Federal-Aid Contract"** shall mean a contract in which the United States (federal) Government provides financial funding as so designated in the Information for Bidders.

2.1.18 **"Final Acceptance"** shall mean final written acceptance of all the Work by the Commissioner, a copy of which shall be sent to the Contractor.

2.1.19 **"Final Approved Punch List"** shall mean a list, approved pursuant to Article 14.2.2, specifying those items of Work to be completed by the Contractor after Substantial Completion and dates for the completion of each item of Work.

2.1.20 **"Law"** or **"Laws"** shall mean the Constitution of the State of New York, the New York City Charter, the New York City Administrative Code, a statute of the United States or of the State of New York, a local law of the City of New York, any ordinance, rule or regulation having the force of law, or common law.

2.1.21 **"Materialman"** shall mean any corporation, firm, partnership, joint venture, or individual, other than employees of the Contractor, who or which contracts with the Contractor or any Subcontractor, to fabricate or deliver, or who actually fabricates or delivers, plant, materials or equipment to be incorporated in the Work.

2.1.22 **"Means and Methods of Construction"** shall mean the labor, materials, temporary structures, tools, plant, and construction equipment, and the manner and time of their use, necessary to accomplish the result intended by this Contract.

2.1.23 **"Notice to Proceed"** or **"Order to Work"** shall mean the written notice issued by the Commissioner specifying the time for commencement of the Work and the Engineer, Architect or Project Manager.

2.1.24 **"Other Contractor(s)"** shall mean any contractor (other than the entity which executed this Contract or its Subcontractors) who or which has a contract with the City for work on or adjacent to the building or Site of the Work.

2.1.25 **"Payroll Taxes"** shall mean State Unemployment Insurance (SUI), Federal Unemployment Insurance (FUI), and payments pursuant to the Federal Insurance Contributions Act (FICA).

2.1.26 **"Project"** shall mean the public improvement to which this Contract relates.

2.1.27 **"Procurement Policy Board" (PPB)** shall mean the Agency of the City of New York whose function is to establish comprehensive and consistent procurement policies and rules which shall have broad application throughout the City.

2.1.28 **"Required Quantity"** in a unit price Contract shall mean the actual quantity of any item of Work or materials which is required to be performed or furnished in order to comply with the Contract.

2.1.29 **"Resident Engineer"** shall mean the representative of the Commissioner duly designated by the Commissioner to be his/her representative at the site of the Work.

2.1.30 **"Site"** shall mean the area upon or in which the Contractor's operations are carried on, and such other areas adjacent thereto as may be designated as such by the Engineer.

2.1.31 **"Small Tools"** shall mean items that are ordinarily required for a worker's job function, including but not limited to, equipment that ordinarily has no licensing, insurance

or substantive storage costs associated with it; such as circular and chain saws, impact drills, threaders, benders, wrenches, socket tools, etc.

2.1.32 "**Specifications**" shall mean all of the directions, requirements, and standards of performance applying to the Work as hereinafter detailed and designated under the Specifications.

2.1.33 "**Subcontractor**" shall mean any person, firm or corporation, other than employees of the Contractor, who or which contracts with the Contractor or with its subcontractors to furnish, or actually furnishes labor, or labor and materials, or labor and equipment, or superintendence, supervision and/or management at the Site. Wherever the word Subcontractor appears, it shall also mean sub-Subcontractor.

2.1.34 "**Substantial Completion**" shall mean the written determination by the Engineer that the Work required under this Contract is substantially, but not entirely, complete and the approval of the **Final Approved Punch List**.

2.1.35 "**Work**" shall mean all services required to complete the Project in accordance with the Contract Documents, including without limitation, labor, material, superintendence, management, administration, equipment, and incidentals, and obtaining any and all permits, certifications and licenses as may be necessary and required to complete the Work, and shall include both Contract Work and Extra Work.

## CHAPTER II THE WORK AND ITS PERFORMANCE

### ARTICLE 3. CHARACTER OF THE WORK

3.1 Unless otherwise expressly provided in the **Contract Drawings, Specifications, and Addenda**, the **Work** shall be performed in accordance with the best modern practice, utilizing, unless otherwise specified in writing, new and unused materials of standard first grade quality and workmanship and design of the highest quality, to the satisfaction of the **Commissioner**.

### ARTICLE 4. MEANS AND METHODS OF CONSTRUCTION

4.1 Unless otherwise expressly provided in the **Contract Drawings, Specifications, and Addenda**, the **Means and Methods of Construction** shall be such as the Contractor may choose; subject, however, to the **Engineer's** right to reject the **Means and Methods of Construction** proposed by the Contractor which in the opinion of the **Engineer**:

4.1.1 Will constitute or create a hazard to the **Work**, or to persons or property; or

4.1.2 Will not produce finished **Work** in accordance with the terms of the **Contract**; or

4.1.3 Will be detrimental to the overall progress of the **Project**.

4.2 The **Engineer's** approval of the **Contractor's Means and Methods of Construction**, or his/her failure to exercise his/her right to reject such means or methods, shall not relieve the **Contractor** of its obligation to complete the **Work** as provided in this **Contract**; nor shall the exercise of such right to reject create a cause of action for damages.

## ARTICLE 5. COMPLIANCE WITH LAWS

5.1 The Contractor shall comply with all Laws applicable to this Contract and to the Work to be done hereunder.

5.2 Procurement Policy Board Rules: This Contract is subject to the Rules of the PPB ("PPB Rules") in effect at the time of the bid opening for this Contract. In the event of a conflict between the PPB Rules and a provision of this Contract, the PPB Rules shall take precedence.

5.3 Noise Control Code provisions:

5.3.1 In accordance with the provisions of Section 24-216(b) of the Administrative Code of the City ("Administrative Code"), Noise Abatement Contract Compliance, devices and activities which will be operated, conducted, constructed or manufactured pursuant to this Contract and which are subject to the provisions of the City Noise Control Code shall be operated, conducted, constructed, or manufactured without causing a violation of the Administrative Code. Such devices and activities shall incorporate advances in the art of noise control development for the kind and level of noise emitted or produced by such devices and activities, in accordance with regulations issued by the Commissioner of the City Department of Environmental Protection.

5.3.2 The Contractor agrees to comply with Section 24-219 of the Administrative Code and implementing rules codified at 15 Rules of the City of New York ("RCNY") Section 28-100 *et seq.* In accordance with such provisions, the Contractor, if the Contractor is the responsible party under such regulations, shall prepare and post a Construction Noise Mitigation Plan at each Site, in which the Contractor shall certify that all construction tools and equipment have been maintained so that they operate at normal manufacturers operating specifications. If the Contractor cannot make this certification, it must have in place an Alternative Noise Mitigation Plan approved by the City Department of Environmental Protection. In addition, the Contractor's certified Construction Noise Mitigation Plan is subject inspection by the City Department of Environmental Protection in accordance with Section 28-101 of Title 15 of RCNY. No Contract Work may take place at a Site unless there is a Construction Noise Mitigation Plan or approved Alternative Noise Mitigation Plan in place. In addition, the Contractor shall create and implement a noise mitigation training program. Failure to comply with these requirements may result in fines and other penalties pursuant to the applicable provisions of the Administrative Code and RCNY.

5.4 Ultra Low Sulfur Diesel Fuel: In accordance with the provisions of Section 24-163.3 of the Administrative Code, the Contractor specifically agrees as follows:

5.4.1 Definitions. For purposes of this Article 5.4, the following definitions apply:

5.4.1(a) "Contractor" means any person or entity that enters into a Public Works Contract with a City Agency, or any person or entity that enters into an agreement with such person or entity, to perform work or provide labor or services related to such Public Works Contract.

5.4.1(b) "Motor Vehicle" means any self-propelled vehicle designed for transporting persons or property on a street or highway.

5.4.1(c) "Nonroad Engine" means an internal combustion engine (including the fuel system) that is not used in a Motor Vehicle or a vehicle used solely for competition, or that is not subject to standards promulgated under Section 7411 or Section 7521 of

Title 42 of the United States Code, except that this term shall apply to internal combustion engines used to power generators, compressors or similar equipment used in any construction program or project.

5.4.1(d) "Nonroad Vehicle" means a vehicle that is powered by a Nonroad Engine, fifty (50) horsepower and greater, and that is not a Motor Vehicle or a vehicle used solely for competition, which shall include, but not be limited to, excavators, backhoes, cranes, compressors, generators, bulldozers, and similar equipment, except that this term shall not apply to horticultural maintenance vehicles used for landscaping purposes that are powered by a Nonroad Engine of sixty-five (65) horsepower or less and that are not used in any construction program or project.

5.4.1(e) "Public Works Contract" means a contract with a City Agency for a construction program or project involving the construction, demolition, restoration, rehabilitation, repair, renovation, or abatement of any building, structure, tunnel, excavation, roadway, park or bridge; a contract with a City Agency for the preparation for any construction program or project involving the construction, demolition, restoration, rehabilitation, repair, renovation, or abatement of any building, structure, tunnel, excavation, roadway, park or bridge; or a contract with a City Agency for any final work involved in the completion of any construction program or project involving the construction, demolition, restoration, rehabilitation, repair, renovation, or abatement of any building, structure, tunnel, excavation, roadway, park or bridge.

5.4.1(f) "Ultra Low Sulfur Diesel Fuel" means diesel fuel that has a sulfur content of no more than fifteen parts per million (15 ppm).

#### 5.4.2 Ultra Low Sulfur Diesel Fuel

5.4.2(a) All Contractors shall use Ultra Low Sulfur Diesel Fuel in diesel-powered Nonroad Vehicles in the performance of this Contract.

5.4.2(b) Notwithstanding the requirements of Article 5.4.2(a), Contractors may use diesel fuel that has a sulfur content of no more than thirty parts per million (30 ppm) to fulfill the requirements of this Article 5.4.2, where the Commissioner of the City Department of Environmental Protection ("DEP Commissioner") has issued a determination that a sufficient quantity of Ultra Low Sulfur Diesel Fuel is not available to meet the needs of Agencies and Contractors. Any such determination shall expire after six (6) months unless renewed.

5.4.2(c) Contractors shall not be required to comply with this Article 5.4.2 where the City Agency letting this Contract makes a written finding, which is approved, in writing, by the DEP Commissioner, that a sufficient quantity of Ultra Low Sulfur Diesel Fuel, or diesel fuel that has a sulfur content of no more than thirty parts per million (30 ppm) is not available to meet the requirements of Section 24-163.3 of the Administrative Code, provided that such Contractor in its fulfillment of the requirements of this Contract, to the extent practicable, shall use whatever quantity of Ultra Low Sulfur Diesel Fuel or diesel fuel that has a sulfur content of no more than thirty parts per million (30 ppm) is available. Any finding made pursuant to this Article 5.4.2(c) shall expire after sixty (60) Days, at which time the requirements of this Article 5.4.2 shall be in full force and effect unless the City Agency renews the finding in writing and such renewal is approved by the DEP Commissioner.

5.4.2(d) **Contractors** may check on determinations and approvals issued by the DEP Commissioner pursuant to Section 24-163.3 of the Administrative Code, if any, at [www.dep.nyc.gov](http://www.dep.nyc.gov) or by contacting the **City Agency** letting this **Contract**.

5.4.2(e) The requirements of this Article 5.4.2 do not apply where they are precluded by federal or State funding requirements or where the **Contract** is an emergency procurement.

#### 5.4.3 Best Available Technology

5.4.3(a) All **Contractors** shall utilize the best available technology for reducing the emission of pollutants for diesel-powered Nonroad Vehicles in the performance of this **Contract**. For determinations of best available technology for each type of diesel-powered Nonroad Vehicle, **Contractors** shall comply with the regulations of the **City Department of Environmental Protection**, as and when adopted, Chapter 14 of Title 15 of the **Rules of the City of New York (RCNY)**. The **Contractor** shall fully document all steps in the best available technology selection process and shall furnish such documentation to the **City Agency** or the DEP Commissioner upon request. The **Contractor** shall retain all documentation generated in the best available technology selection process for as long as the selected best available technology is in use.

5.4.3(b) No **Contractor** shall be required to replace best available technology for reducing the emission of pollutants or other authorized technology utilized for a diesel-powered Nonroad Vehicle in accordance with the provisions of this Article 5.4.3 within three (3) years of having first utilized such technology for such vehicle.

5.4.3(c) This Article 5.4.3 shall not apply to any vehicle used to satisfy the requirements of a specific Public Works Contract for fewer than twenty (20) **Days**.

5.4.3(d) The **Contractor** shall not be required to comply with this Article 5.4.3 with respect to a diesel-powered Nonroad Vehicle under the following circumstances:

5.4.3(d)(i) Where the **City Agency** makes a written finding, which is approved, in writing, by the DEP Commissioner, that the best available technology for reducing the emission of pollutants as required by this Article 5.4.3 is unavailable for such vehicle, the **Contractor** shall use whatever technology for reducing the emission of pollutants, if any, is available and appropriate for such vehicle.

5.4.3(d)(ii) Where the DEP Commissioner has issued a written waiver based upon the **Contractor** having demonstrated to the DEP Commissioner that the use of the best available technology for reducing the emission of pollutants might endanger the operator of such vehicle or those working near such vehicle, due to engine malfunction, the **Contractor** shall use whatever technology for reducing the emission of pollutants, if any, is available and appropriate for such vehicle, which would not endanger the operator of such vehicle or those working near such vehicle.

5.4.3(d)(iii) In determining which technology to use for the purposes of Articles 5.4.3(d)(i) and 5.4.3(d)(ii) above, the **Contractor** shall primarily consider the reduction in emissions of particulate matter and secondarily consider the reduction in emissions of nitrogen oxides associated with the use of such



technology, which shall in no event result in an increase in the emissions of either such pollutant.

5.4.3(d)(iv) The **Contractor** shall submit requests for a finding or a waiver pursuant to this Article 5.4.3(d) in writing to the DEP Commissioner, with a copy to the **ACCO** of the **City Agency** letting this **Contract**. Any finding or waiver made or issued pursuant to Articles 5.4.3(d)(i) and 5.4.3(d)(ii) above shall expire after one hundred eighty (180) **Days**, at which time the requirements of Article 5.4.3(a) shall be in full force and effect unless the **City Agency** renews the finding, in writing, and the DEP Commissioner approves such finding, in writing, or the DEP Commissioner renews the waiver, in writing.

5.4.3(e) The requirements of this Article 5.4.3 do not apply where they are precluded by federal or State funding requirements or where the **Contract** is an emergency procurement.

5.4.4 Section 24-163 of the Administrative Code. The **Contractor** shall comply with Section 24-163 of the Administrative Code related to the idling of the engines of motor vehicles while parking.

#### 5.4.5 Compliance

5.4.5(a) The **Contractor's** compliance with Article 5.4 may be independently monitored. If it is determined that the **Contractor** has failed to comply with any provision of Article 5.4, any costs associated with any independent monitoring incurred by the **City** shall be reimbursed by the **Contractor**.

5.4.5(b) Any **Contractor** who violates any provision of Article 5.4, except as provided in Article 5.4.5(c) below, shall be liable for a civil penalty between the amounts of one thousand (\$1,000) and ten thousand (\$10,000) dollars, in addition to twice the amount of money saved by such **Contractor** for failure to comply with Article 5.4.

5.4.5(c) No **Contractor** shall make a false claim with respect to the provisions of Article 5.4 to a **City Agency**. Where a **Contractor** has been found to have done so, such **Contractor** shall be liable for a civil penalty of twenty thousand (\$20,000) dollars, in addition to twice the amount of money saved by such **Contractor** in association with having made such false claim.

#### 5.4.6 Reporting

5.4.6(a) For all Public Works Contracts covered by this Article 5.4, the **Contractor** shall report to the **City Agency** the following information:

5.4.6(a)(i) The total number of diesel-powered Nonroad Vehicles used to fulfill the requirements of this Public Works Contract;

5.4.6(a)(ii) The number of such Nonroad Vehicles that were powered by Ultra Low Sulfur Diesel Fuel;

5.4.6(a)(iii) The number of such Nonroad Vehicles that utilized the best available technology for reducing the emission of pollutants, including a breakdown by vehicle model and the type of technology;

5.4.6(a)(iv) The number of such Nonroad Vehicles that utilized such other authorized technology in accordance with Article 5.4.3, including a breakdown by vehicle model and the type of technology used for each such vehicle;

5.4.6(a)(v) The locations where such Nonroad Vehicles were used; and

5.4.6(a)(vi) Where a determination is in effect pursuant to Article 5.4.2(b) or 5.4.2(c), detailed information concerning the Contractor's efforts to obtain Ultra Low Sulfur Diesel Fuel or diesel fuel that has a sulfur content of no more than thirty parts per million (30 ppm).

5.4.6(b) The Contractor shall submit the information required by Article 5.4.6(a) at the completion of Work under the Public Works Contract and on a yearly basis no later than August 1 throughout the term of the Public Works Contract. The yearly report shall cover Work performed during the preceding fiscal year (July 1 - June 30).

5.5 Ultra Low Sulfur Diesel Fuel. In accordance with the Coordinated Construction Act for Lower Manhattan, as amended:

5.5.1 Definitions. For purposes of this Article 5.5, the following definitions apply:

5.5.1(a) "Lower Manhattan" means the area to the south of and within the following lines: a line beginning at a point where the United States pierhead line in the Hudson River as it exists now or may be extended would intersect with the southerly line of West Houston Street in the Borough of Manhattan extended, thence easterly along the southerly side of West Houston Street to the southerly side of Houston Street, thence easterly along the southerly side of Houston Street to the southerly side of East Houston Street, thence northeasterly along the southerly side of East Houston Street to the point where it would intersect with the United States pierhead line in the East River as it exists now or may be extended, including tax lots within or immediately adjacent thereto.

5.5.1(b) "Lower Manhattan Redevelopment Project" means any project in Lower Manhattan that is funded in whole or in part with federal or State funding, or any project intended to improve transportation between Lower Manhattan and the two air terminals in the City known as LaGuardia Airport and John F. Kennedy International Airport, or between Lower Manhattan and the air terminal in Newark known as Newark Liberty International Airport, and that is funded in whole or in part with federal funding.

5.5.1(c) "Nonroad Engine" means an internal combustion engine (including the fuel system) that is not used in a Motor Vehicle or a vehicle used solely for competition, or that is not subject to standards promulgated under Section 7411 or Section 7521 of Title 42 of the United States Code, except that this term shall apply to internal combustion engines used to power generators, compressors or similar equipment used in any construction program or project.

5.5.1(d) "Nonroad Vehicle" means a vehicle that is powered by a Nonroad Engine, fifty (50) horsepower (HP) and greater, and that is not a Motor Vehicle or a vehicle used solely for competition, which shall include, but not be limited to, excavators, backhoes, cranes, compressors, generators, bulldozers, and similar equipment, except

that this terms shall not apply to horticultural maintenance vehicles used for landscaping purposes that are powered by a Nonroad Engine of sixty-five (65) HP or less and that are not used in any construction program or project.

5.5.1(e) "Ultra Low Sulfur Diesel Fuel" means diesel fuel that has a sulfur content of no more than fifteen parts per million (15 ppm).

5.5.2 Requirements. Contractors and Subcontractors are required to use only Ultra Low Sulfur Diesel Fuel to power the diesel-powered Nonroad Vehicles with engine HP rating of fifty (50) HP and above used on a Lower Manhattan Redevelopment Project and, where practicable, to reduce the emission of pollutants by retrofitting such Nonroad Vehicles with oxidation catalysts, particulate filters, or technology that achieves lowest particulate matter emissions.

5.6 Pesticides. In accordance with Section 17-1209 of the Administrative Code, to the extent that the Contractor or any Subcontractor applies pesticides to any property owned or leased by the City, the Contractor, and any Subcontractor shall comply with Chapter 12 of the Administrative Code.

5.7 Waste Treatment, Storage, and Disposal Facilities and Transporters. In connection with the Work, the Contractor and any Subcontractor shall use only those waste treatment, storage, and disposal facilities and waste transporters that possess the requisite license, permit or other governmental approval necessary to treat, store, dispose, or transport the waste, materials or hazardous substances.

5.8 Environmentally Preferable Purchasing. The Contractor shall ensure that products purchased or leased by the Contractor or any Subcontractor for the Work that are not specified by the City or are submitted as equivalents to a product specified by the City comply with the requirements of the New York City Environmentally Preferable Purchasing Program contained in Chapter 11 of Title 43 of the RCNY, pursuant to Chapter 3 of Title 6 of the Administrative Code.

## ARTICLE 6. INSPECTION

6.1 During the progress of the Work and up to the date of Final Acceptance, the Contractor shall at all times afford the representatives of the City every reasonable, safe, and proper facility for inspecting all Work done or being done at the Site and also for inspecting the manufacture or preparation of materials and equipment at the place of such manufacture or preparation.

6.2 The Contractor's obligation hereunder shall include the uncovering or taking down of finished Work and its restoration thereafter; provided, however, that the order to uncover, take down and restore shall be in writing, and further provided that if Work thus exposed proves satisfactory, and if the Contractor has complied with Article 6.1, such uncovering or taking down and restoration shall be considered an item of Extra Work to be paid for in accordance with the provisions of Article 26. If the Work thus exposed proves unsatisfactory, the City has no obligation to compensate the Contractor for the uncovering, taking down or restoration.

6.3 Inspection and approval by the Commissioner, the Engineer, Project Manager, or Resident Engineer, of finished Work or of Work being performed, or of materials and equipment at the place of manufacture or preparation, shall not relieve the Contractor of its obligation to perform the Work in strict accordance with the Contract. Finished or unfinished Work not found to be in strict accordance with the Contract shall be replaced as directed by the Engineer, even though such Work may have been previously approved and paid for. Such corrective Work is Contract Work and shall not be deemed Extra Work.

6.4 Rejected **Work** and materials shall be promptly taken down and removed from the **Site**, which must at all times be kept in a reasonably clean and neat condition.

**ARTICLE 7. PROTECTION OF WORK AND OF PERSONS  
AND PROPERTY; NOTICES AND INDEMNIFICATION**

7.1 During the performance of the **Work** and up to the date of **Final Acceptance**, the **Contractor** shall be under an absolute obligation to protect the finished and unfinished **Work** against any damage, loss, injury, theft and/or vandalism and in the event of such damage, loss, injury, theft and/or vandalism, it shall promptly replace and/or repair such **Work** at the **Contractor's** sole cost and expense, as directed by the **Resident Engineer**. The obligation to deliver finished **Work** in strict accordance with the **Contract** prior to **Final Acceptance** shall be absolute and shall not be affected by the **Resident Engineer's** approval of, or failure to prohibit, the **Means and Methods of Construction** used by the **Contractor**.

7.2 During the performance of the **Work** and up to the date of **Final Acceptance**, the **Contractor** shall take all reasonable precautions to protect all persons and the property of the **City** and of others from damage, loss or injury resulting from the **Contractor's**, and/or its **Subcontractors'** operations under this **Contract**. The **Contractor's** obligation to protect shall include the duty to provide, place or replace, and adequately maintain at or about the **Site** suitable and sufficient protection such as lights, barricades, and enclosures.

7.3 The **Contractor** shall comply with the notification requirements set forth below in the event of any loss, damage or injury to **Work**, persons or property, or any accidents arising out of the operations of the **Contractor** and/or its **Subcontractors** under this **Contract**.

7.3.1 The **Contractor** shall make a full and complete report in writing to the **Resident Engineer** within three (3) **Days** after the occurrence.

7.3.2 The **Contractor** shall also send written notice of any such event to all insurance carriers that issued potentially responsive policies (including commercial general liability insurance carriers for events relating to the **Contractor's** own employees) no later than twenty (20) days after such event and again no later than twenty (20) days after the initiation of any claim and/or action resulting therefrom. Such notice shall contain the following information: the number of the insurance policy, the name of the Named Insured, the date and location of the incident, and the identity of the persons injured or property damaged. For any policy on which the **City** and/or the **Engineer, Architect, or Project Manager** are Additional Insureds, such notice shall expressly specify that "this notice is being given on behalf of the **City of New York** as Additional Insured, such other Additional Insureds, as well as the Named Insured."

7.3.2(a) Whenever such notice is sent under a policy on which the **City** is an Additional Insured, the **Contractor** shall provide copies of the notice to the **Comptroller, the Commissioner** and the **City Corporation Counsel**. The copy to the **Comptroller** shall be sent to the Insurance Unit, NYC Comptroller's Office, 1 Centre Street – Room 1222, New York, New York, 10007. The copy to the **Commissioner** shall be sent to the address set forth in Schedule A of the General Conditions. The copy to the **City Corporation Counsel** shall be sent to Insurance Claims Specialist, Affirmative Litigation Division, New York City Law Department, 100 Church Street, New York, New York 10007.

7.3.2(b) If the **Contractor** fails to provide any of the foregoing notices to any appropriate insurance carrier(s) in a timely and complete manner, the **Contractor** shall indemnify the **City** for all losses, judgments, settlements, and expenses, including reasonable attorneys' fees, arising from an insurer's disclaimer of coverage citing late notice by or on behalf of the **City**.

7.4 To the fullest extent permitted by law, the **Contractor** shall defend, indemnify, and hold the **City**, its employees, and officials (the "Indemnitees") harmless against any and all claims (including but not limited to claims asserted by any employee of the **Contractor** and/or its **Subcontractors**) and costs and expenses of whatever kind (including but not limited to payment or reimbursement of attorneys' fees and disbursements) allegedly arising out of or in any way related to the operations of the **Contractor** and/or its **Subcontractors** in the performance of this **Contract** or from the **Contractor's** and/or its **Subcontractors'** failure to comply with any of the provisions of this **Contract** or of the **Law**. Such costs and expenses shall include all those incurred in defending the underlying claim and those incurred in connection with the enforcement of this Article 7.4 by way of cross-claim, third-party claim, declaratory action or otherwise. The parties expressly agree that the indemnification obligation hereunder contemplates (1) full indemnity in the event of liability imposed against the Indemnitees without negligence and solely by reason of statute, operation of **Law** or otherwise; and (2) partial indemnity in the event of any actual negligence on the part of the Indemnitees either causing or contributing to the underlying claim (in which case, indemnification will be limited to any liability imposed over and above that percentage attributable to actual fault whether by statute, by operation of **Law**, or otherwise). Where partial indemnity is provided hereunder, all costs and expenses shall be indemnified on a pro rata basis.

7.4.1 Indemnification under Article 7.4 or any other provision of the **Contract** shall operate whether or not **Contractor** or its **Subcontractors** have placed and maintained the insurance specified under Article 22.

7.5 The provisions of this Article 7 shall not be deemed to create any new right of action in favor of third parties against the **Contractor** or the **City**.

### CHAPTER III TIME PROVISIONS

#### ARTICLE 8. COMMENCEMENT AND PROSECUTION OF THE WORK

8.1 The **Contractor** shall commence the **Work** on the date specified in the **Notice to Proceed** or the **Order to Work**. The time for performance of the **Work** under the **Contract** shall be computed from the date specified in the **Notice to Proceed** or the **Order to Work**. **TIME BEING OF THE ESSENCE** to the **City**, the **Contractor** shall thereafter prosecute the **Work** diligently, using such **Means and Methods of Construction** as are in accord with Article 4 herein and as will assure its completion not later than the date specified in this **Contract**, or on the date to which the time for completion may be extended.

#### ARTICLE 9. PROGRESS SCHEDULES

9.1 To enable the **Work** to be performed in an orderly and expeditious manner, the **Contractor**, within fifteen (15) **Days** after the **Notice to Proceed** or **Order to Work**, unless otherwise directed by the **Engineer**, shall submit to the **Engineer** a proposed progress schedule based on the Critical Path Method in the form of a bar graph or in such other form as specified by the **Engineer**, and monthly cash flow requirements, showing:

9.1.1 The anticipated time of commencement and completion of each of the various operations to be performed under this **Contract**; and

9.1.2 The sequence and interrelation of each of these operations with the others and with those of other related contracts; and

9.1.3 The estimated time required for fabrication or delivery, or both, of all materials and equipment required for the **Work**, including the anticipated time for obtaining required approvals pursuant to Article 10; and

9.1.4 The estimated amount in dollars the **Contractor** will claim on a monthly basis.

9.2 The proposed schedule shall be revised as directed by the **Engineer**, until finally approved by the **Engineer**, and after such approval, subject to the provisions of Article 11, shall be strictly adhered to by the **Contractor**.

9.3 If the **Contractor** shall fail to adhere to the approved progress schedule, or to the schedule as revised pursuant to Article 11, it shall promptly adopt such other or additional **Means and Methods of Construction**, at its sole cost and expense, as will make up for the time lost and will assure completion in accordance with the approved progress schedule. The approval by the **City** of a progress schedule which is shorter than the time allotted under the **Contract** shall not create any liability for the **City** if the approved progress schedule is not met.

9.4 The **Contractor** will not receive any payments until the proposed progress schedule is submitted.

#### **ARTICLE 10. REQUESTS FOR INFORMATION OR APPROVAL**

10.1 From time to time as the **Work** progresses and in the sequence indicated by the approved progress schedule, the **Contractor** shall submit to the **Engineer** a specific request in writing for each item of information or approval required by the **Contractor**. These requests shall state the latest date upon which the information or approval is actually required by the **Contractor**, and shall be submitted in a reasonable time in advance thereof to provide the **Engineer** a sufficient time to act upon such submissions, or any necessary re-submissions thereof.

10.2 The **Contractor** shall not have any right to an extension of time on account of delays due to the **Contractor's** failure to submit requests for the required information or the required approval in accordance with the above requirements.

#### **ARTICLE 11. NOTICE OF CONDITIONS CAUSING DELAY AND DOCUMENTATION OF DAMAGES CAUSED BY DELAY**

11.1 After the commencement of any condition which is causing or may cause a delay in completion of the **Work**, including conditions for which the **Contractor** may be entitled to an extension of time, the following notifications and submittals are required:

11.1.1 Within seven (7) **Days** after the commencement of such condition, the **Contractor** must notify the **Engineer** in writing of the existence, nature and effect of such condition upon the approved progress schedule and the **Work**, and must state why and in what respects, if any, the condition is causing or may cause a delay.

11.1.2 If the **Contractor** shall claim to be sustaining damages for delay as provided for in this Article 11, within forty-five (45) **Days** from the time such damages are first incurred, and every thirty (30) **Days** thereafter for as long as such damages are being incurred, the **Contractor** shall submit to the **Commissioner** verified written statements of the details and the amounts of such damages, together with documentary evidence of such damages, ("statement of delay damages") as further detailed in Article 11.6. The **Contractor** may submit any of the above statements within such additional time as may be granted by the **Commissioner** in writing upon written request therefor. On failure of the **Contractor** to strictly comply with all of the foregoing provisions, such claims shall be deemed waived and no right to recover on such claims shall exist. Damages that the **Contractor** may claim in any action arising under or by reason of this **Contract** shall not be different from or in excess of the statements made and documentation provided pursuant to this Article 11.

11.1.3 Within 60 days of submission of the final verified statement of claims pursuant to Article 44, the **Commissioner** shall make a determination as to whether a compensable delay has occurred and, if so, the amount of compensation due the **Contractor**. Notwithstanding the above, the **Commissioner** may make a determination as to whether a compensable delay has occurred at any time after the **Contractor's** first submission of a statement of delay damages provided, however, that the amount of compensation due to the **Contractor** will not be determined until the **Commissioner** determines that the **Work** is delayed after the date set for substantial completion.

11.2 Failure of the **Contractor** to strictly comply with the requirements of Article 11.1.1 may, in the discretion of the **Commissioner**, be deemed sufficient cause to deny any extension of time on account of delay arising out of such condition. Failure of the **Contractor** to strictly comply with the requirements of Articles 11.1.1 and 11.1.2 shall be deemed a conclusive waiver by the **Contractor** of any and all claims for damages for delay arising from such condition and no right to recover on such claims shall exist.

11.3 When appropriate and directed by the **Engineer**, the progress schedule shall be revised by the **Contractor** until finally approved by the **Engineer**. The revised progress schedule must be strictly adhered to by the **Contractor**.

#### 11.4 Compensable Delays

11.4.1 The **Contractor** agrees to make claim only for additional costs attributable to delay in the performance of this **Contract** necessarily extending the time for completion of the **Work** or resulting from acceleration directed by the **Commissioner** and required to maintain the **Project** schedule, occasioned solely by any act or omission to act of the **City** listed below. The **Contractor** also agrees that delay from any other cause shall be compensated, if at all, solely by an extension of time to complete the performance of the **Work**.

11.4.1.1 The failure of the **City** to take reasonable measures to coordinate and progress the **Work**, except that the **City** shall not be responsible for the **Contractor's** obligation to coordinate and progress the **Work** of its **Subcontractors**.

11.4.1.2 Extended delays attributable to the **City** in the review or issuance of change orders, in shop drawing reviews and approvals or as a result of the cumulative impact of multiple change orders, which have a verifiable impact on **Project** costs.

11.4.1.3 The unavailability of the **Site** for an extended period of time that significantly affects the scheduled completion of the **Contract**.

- 11.4.1.4 The issuance by the **Engineer** of a stop work order relative to a substantial portion of the **Work** for a period exceeding thirty (30) **Days**, that was not brought about through any action or omission of the **Contractor**.
- 11.4.1.5 Differing site conditions that were neither known nor reasonably ascertainable on a pre-bid inspection of the **Site** or review of the bid documents or other publicly available sources, and that are not ordinarily encountered in the **Project's** geographical area or neighborhood or in the type of **Work** to be performed.
- 11.4.1.6 Delays caused by the **City's** bad faith or its willful, malicious, or grossly negligent conduct;
- 11.4.1.7 Delays not contemplated by the parties;
- 11.4.1.8 Delays so unreasonable that they constitute an intentional abandonment of the **Contract** by the **City**; and
- 11.4.1.9 Delays resulting from the **City's** breach of a fundamental obligation of the **Contract**.

11.4.2 No claim may be made for any alleged delay in **Substantial Completion** of the **Work** by a date earlier than the date of **Substantial Completion** provided for in Schedule A unless there is a provision in the **Contract** providing for additional compensation for early completion. No claim may be made for any alleged delay in **Substantial Completion** of the **Work** if the work is substantially completed by the date of **Substantial Completion** provided for in Schedule A unless acceleration has been directed by the **Commissioner** to meet the date of **Substantial Completion** set forth in Schedule A.

11.4.3 The provisions of this Article 11 apply only to claims for additional costs attributable to delay and do not preclude determinations by the **Commissioner** allowing reimbursements for additional costs for **Extra Work** pursuant to Articles 25 and 26 of this **Contract**. To the extent that any cost attributable to delay is reimbursed as part of a change order, no additional claim for compensation under this Article 11 shall be allowed.

11.5 **Non-Compensable Delays.** The **Contractor** agrees to make no claim for, and is deemed to have included in its bid prices for the various items of the **Contract**, the extra/additional costs attributable to any delays caused by or attributable to the items set forth below. For such items, the **Contractor** shall be compensated, if at all, solely by an extension of time to complete the performance of the **Work**, in accordance with the provisions of Article 13. Such extensions of time will be granted, if at all, pursuant to the grounds set forth in Article 13.3.

11.5.1 The acts or omissions of any third parties, including but not limited to **Other Contractors**, public/ governmental bodies (other than **City Agencies**), utilities or private enterprises, who are disclosed in the **Contract Documents** or are ordinarily encountered or generally recognized as related to the **Work**;

11.5.2 Any situation which was within the contemplation of the parties at the time of entering into the **Contract**, including any delay indicated or disclosed in the **Contract Documents** or generally recognized as related to the nature of the **Work**, and/or the existence of any facility or appurtenance owned, operated or maintained by any third party, as indicated or disclosed in the **Contract Documents** or ordinarily encountered or generally recognized as related to the nature of the **Work**;

11.5.3 Restraining orders, injunctions or judgments issued by a court which were caused by a Contractor's submission, action or inaction or by a Contractor's **Means and Methods** of



**Construction**, or by third parties, unless such order, injunction or judgment was the result of an action or omission by the City;

11.5.4 Any labor boycott, strike, picketing, lockout or similar situation;

11.5.5 Any shortages of supplies or materials, or unavailability of equipment, required by the **Contract Work**;

11.5.6 Climatic conditions, storms, floods, droughts, tidal waves, fires, hurricanes, earthquakes, landslides or other catastrophes or acts of God, or acts of war or of the public enemy or terrorist acts, including the City's reasonable responses thereto; and

11.5.7 **Extra Work** which does not significantly affect the overall completion of the **Contract**, reasonable delays in the review or issuance of change orders or field orders and/or in shop drawing reviews or approvals.

#### 11.6 Required Content of Submission of Statement of Delay Damages

11.6.1 In the verified written statement of delay damages required by Article 11.1.2, the following information shall be provided by the **Contractor**:

11.6.1.1 For each delay, the start and end dates of the claimed periods of delay and, in addition, a description of the operations that were delayed, an explanation of how they were delayed, and the reasons for the delay, including identifying the applicable act or omission of the City listed in Article 11.4.

11.6.1.2 A detailed factual statement of the claim providing all necessary dates, locations and items of **Work** affected by the claim.

11.6.1.3 The amount of additional compensation sought and a breakdown of that amount into categories as described in Article 26.2, subject to the limitations set forth in Article 11.7.

11.6.1.4 Any additional information requested by the **Commissioner**.

#### 11.7 Recoverable Costs

11.7.1 Delay damages may be recoverable for the following costs actually and necessarily incurred in the performance of the **Work**:

11.7.1.1 Direct labor, including payroll taxes (subject to statutory wage caps) and supplemental benefits, based on time and materials records;

11.7.1.2 Necessary materials (including transportation to the **Site**), based on time and material records;

11.7.1.3 Reasonable rental value of necessary plant and equipment other than small tools, plus fuel/energy costs according to the applicable formula set forth in Articles 26.2.4 and/or 26.2.8, based on time and material records;

11.7.1.4 Insurance and bond costs;

11.7.1.5 Extended field office costs;

11.7.1.6 Extended **Site** overhead; and

11.7.1.7 Extended home office overhead.

11.7.2 Recoverable Subcontractor Costs. When the **Work** is performed by a **Subcontractor**, the **Contractor** may be paid the actual and necessary costs of such subcontracted **Work** as outlined above in Articles 11.7.1.1 through 11.7.1.6, and an

additional overhead of five (5%) percent of the costs outlined in Articles 11.7.1.1 through 11.7.1.3.

11.7.3 Non-Recoverable Costs. The parties agree that the **City** will have no liability for the following items and the **Contractor** agrees it shall make no claim for the following items:

11.7.3.1 Profit, or loss of anticipated or unanticipated profit;

11.7.3.2 Consequential damages, including but not limited to interest on monies in dispute, including interest which is paid on such monies, loss of bonding capacity, bidding opportunities, or interest in investment, or any resulting insolvency;

11.7.3.3 Indirect costs or expenses of any nature;

11.7.3.4 Direct or indirect costs attributable to performance of **Work** where the **Contractor**, because of situations or conditions within its control, has not progressed the **Work** in a satisfactory manner; and

11.7.3.5 Attorneys' fees and dispute and claims preparation expenses.

11.8 Determinations under this Article 11 are not subject to the jurisdiction of the Contract Dispute Resolution Board pursuant to the dispute resolution process set forth in Article 27.

11.9 If the parties agree, pursuant to Article 11.1.3 above, that a compensable delay has occurred and agree on the amount of compensation, payment may be made pursuant to a written change order. Payment pursuant to such change order is subject to pre-audit by the **Engineering Audit Officer**, and may be post-audited by the **Comptroller** and/or the **Agency**.

## ARTICLE 12. COORDINATION WITH OTHER CONTRACTORS

12.1 During the progress of the **Work**, **Other Contractors** may be engaged in performing other work or may be awarded other contracts for additional work on this **Project**. In that event, the **Contractor** shall coordinate the **Work** to be done hereunder with the work of such **Other Contractors** and the **Contractor** shall fully cooperate with such **Other Contractors** and carefully fit its own **Work** to that provided under other contracts as may be directed by the **Engineer**. The **Contractor** shall not commit or permit any act which will interfere with the performance of work by any **Other Contractors**.

12.2 If the **Engineer** determines that the **Contractor** is failing to coordinate its **Work** with the work of **Other Contractors** as the **Engineer** has directed, then the **Commissioner** shall have the right to withhold any payments otherwise due hereunder until the **Contractor** completely complies with the **Engineer's** directions.

12.3 The **Contractor** shall notify the **Engineer** in writing if any **Other Contractor** on this **Project** is failing to coordinate its work with the **Work** of this **Contract**. If the **Engineer** finds such charges to be true, the **Engineer** shall promptly issue such directions to the **Other Contractor** with respect thereto as the situation may require. The **City** shall not, however, be liable for any damages suffered by any **Other Contractor's** failure to coordinate its work with the **Work** of this **Contract** or by reason of the **Other Contractor's** failure to promptly comply with the directions so issued by the **Engineer**, or by reason of any **Other Contractor's** default in performance, it being understood that the **City** does not guarantee the responsibility or continued efficiency of any contractor. The **Contractor** agrees to make no claim against

the City for any damages relating to or arising out of any directions issued by the Engineer pursuant to this Article 12 (including but not limited to the failure of any Other Contractor to comply or promptly comply with such directions), or the failure of the Engineer to issue any directions, or the failure of any Other Contractor to coordinate its work, or the default in performance of any Other Contractor.

12.4 The Contractor shall indemnify and hold the City harmless from any and all claims or judgments for damages and from costs and expenses to which the City may be subjected or which it may suffer or incur by reason of the Contractor's failure to comply with the Engineer's directions promptly; and the Comptroller shall have the right to exercise the powers reserved in Article 23 with respect to any claims which may be made for damages due to the Contractor's failure to comply with the Engineer's directions promptly. Insofar as the facts and Law relating to any claim would preclude the City from being completely indemnified by the Contractor, the City shall be partially indemnified by the Contractor to the fullest extent provided by Law.

12.5 Should the Contractor sustain any damage through any act or omission of any Other Contractor having a contract with the City for the performance of work upon the Site or of work which may be necessary to be performed for the proper prosecution of the Work to be performed hereunder, or through any act or omission of a subcontractor of such Other Contractor, the Contractor shall have no claim against the City for such damage, but shall have a right to recover such damage from the Other Contractor under the provision similar to the following provisions which apply to this Contract and have been or will be inserted in the contracts with such Other Contractors:

12.5.1 Should any Other Contractor having or who shall hereafter have a contract with the City for the performance of work upon the Site sustain any damage through any act or omission of the Contractor hereunder or through any act or omission of any Subcontractor of the Contractor, the Contractor agrees to reimburse such Other Contractor for all such damages and to defend at its own expense any action based upon such claim and if any judgment or claim (even if the allegations of the action are without merit) against the City shall be allowed the Contractor shall pay or satisfy such judgment or claim and pay all costs and expenses in connection therewith and agrees to indemnify and hold the City harmless from all such claims. Insofar as the facts and Law relating to any claim would preclude the City from being completely indemnified by the Contractor, the City shall be partially indemnified by the Contractor to the fullest extent provided by Law.

12.6 The City's right to indemnification hereunder shall in no way be diminished, waived or discharged by its recourse to assessment of liquidated damages as provided in Article 15, or by the exercise of any other remedy provided for by Contract or by Law.

### ARTICLE 13. EXTENSION OF TIME FOR PERFORMANCE

13.1 If performance by the Contractor is delayed for a reason set forth in Article 13.3, the Contractor may be allowed a reasonable extension of time in conformance with this Article 13 and the PPB Rules.

13.2 Any extension of time may be granted only by the ACCO or by the Board for the Extension of Time (hereafter "Board") (as set forth below) upon written application by the Contractor.

13.3 Grounds for Extension: If such application is made, the Contractor shall be entitled to an extension of time for delay in completion of the Work caused solely:

13.3.1 By the acts or omissions of the City, its officials, agents or employees; or

13.3.2 By the act or omissions of **Other Contractors** on this **Project**; or

13.3.3 By supervening conditions entirely beyond the control of either party hereto (such as, but not limited to, acts of God or the public enemy, excessive inclement weather, war or other national emergency making performance temporarily impossible or illegal, or strikes or labor disputes not brought about by any act or omission of the **Contractor**).

13.3.4 The **Contractor** shall, however, be entitled to an extension of time for such causes only for the number of **Days** of delay which the **ACCO** or the Board may determine to be due solely to such causes, and then only if the **Contractor** shall have strictly complied with all of the requirements of Articles 9 and 10.

13.4 The **Contractor** shall not be entitled to receive a separate extension of time for each of several causes of delay operating concurrently, but, if at all, only for the actual period of delay in completion of the **Work** as determined by the **ACCO** or the Board, irrespective of the number of causes contributing to produce such delay. If one of several causes of delay operating concurrently results from any act, fault or omission of the **Contractor** or of its **Subcontractors** or **Materialmen**, and would of itself (irrespective of the concurrent causes) have delayed the **Work**, no extension of time will be allowed for the period of delay resulting from such act, fault or omission.

13.5 The determination made by the **ACCO** or the Board on an application for an extension of time shall be binding and conclusive on the **Contractor**.

13.6 The **ACCO** or the Board acting entirely within their discretion may grant an application for an extension of time for causes of delay other than those herein referred.

13.7 Permitting the **Contractor** to continue with the **Work** after the time fixed for its completion has expired, or after the time to which such completion may have been extended has expired, or the making of any payment to the **Contractor** after such time, shall in no way operate as a waiver on the part of the **City** of any of its rights under this **Contract**.

13.8 Application for Extension of Time:

13.8.1 Before the **Contractor's** time extension request will be considered, the **Contractor** shall notify the **ACCO** of the condition which allegedly has caused or is causing the delay, and shall submit a written application to the **ACCO** identifying:

13.8.1(a) The **Contractor**; the registration number; and **Project** description;

13.8.1(b) Liquidated damage assessment rate, as specified in the **Contract**;

13.8.1(c) Original total bid price;

13.8.1(d) The original **Contract** start date and completion date;

13.8.1(e) Any previous time extensions granted (number and duration); and

13.8.1(f) The extension of time requested.

13.8.2 In addition, the application for extension of time shall set forth in detail:

13.8.2(a) The nature of each alleged cause of delay in completing the **Work**;

13.8.2(b) The date upon which each such cause of delay began and ended and the number of **Days** attributable to each such cause;

13.8.2(c) A statement that the **Contractor** waives all claims except for those delineated in the application, and the particulars of any claims which the **Contractor** does not agree to waive. For time extensions for **Substantial Completion** and final completion payments, the application shall include a detailed statement of the dollar amounts of each element of claim item reserved; and

13.8.2(d) A statement indicating the **Contractor's** understanding that the time extension is granted only for purposes of permitting continuation of **Contract** performance and payment for **Work** performed and that the **City** retains its right to conduct an investigation and assess liquidated damages as appropriate in the future.

### 13.9 Analysis and Approval of Time Extensions:

13.9.1 For time extensions for partial payments, a written determination shall be made by the **ACCO** who may, for good and sufficient cause, extend the time for the performance of the **Contract** as follows:

13.9.1(a) If the **Work** is to be completed within six (6) months, the time for performance may be extended for sixty (60) **Days**;

13.9.1(b) If the **Work** is to be completed within less than one (1) year but more than six (6) months, an extension of ninety (90) **Days** may be granted;

13.9.1(c) If the **Contract** period exceeds one (1) year, besides the extension granted in Article 13.9.1(b), an additional thirty (30) **Days** may be granted for each multiple of six (6) months involved beyond the one (1) year period; or

13.9.1(d) If exceptional circumstances exist, the **ACCO** may extend the time for performance beyond the extensions in Articles 13.9.1(a), 13.9.1(b), and 13.9.1(c). In that event, the **ACCO** shall file with the Mayor's Office of Contract Services a written explanation of the exceptional circumstances.

13.9.2 For extensions of time for **Substantial Completion** and final completion payments, the **Engineer**, in consultation with the **ACCO**, shall prepare a written analysis of the delay (including a preliminary determination of the causes of delay, the beginning and end dates for each such cause of delay, and whether the delays are excusable under the terms of this **Contract**). The report shall be subject to review by and approval of the Board, which shall have authority to question its analysis and determinations and request additional facts or documentation. The report as reviewed and made final by the Board shall be made a part of the **Agency** contract file. Neither the report itself nor anything contained therein shall operate as a waiver or release of any claim the **City** may have against the **Contractor** for either actual or liquidated damages.

13.9.3 Approval Mechanism for Time Extensions for **Substantial Completion** or Final Completion Payments: An extension shall be granted only with the approval of the Board which is comprised of the **ACCO** of the **Agency**, the **City** Corporation Counsel, and the **Comptroller**, or their authorized representatives.

13.9.4 Neither the granting of any application for an extension of time to the **Contractor** or any **Other Contractor** on this **Project** nor the papers, records or reports related to any application for or grant of an extension of time or determination related thereto shall be referred to or offered in evidence by the **Contractor** or its attorneys in any action or proceeding.

13.10 No Damage for Delay: The **Contractor** agrees to make no claim for damages for delay in the performance of this **Contract** occasioned by any act or omission to act of the **City** or any of its representatives, except as provided for in Article 11.

#### **ARTICLE 14. COMPLETION AND FINAL ACCEPTANCE OF THE WORK**

14.1 **Date for Substantial Completion:** The **Contractor** shall substantially complete the **Work** within the time fixed in Schedule A of the General Conditions, or within the time to which such **Substantial Completion** may be extended.

14.2 **Determining the Date of Substantial Completion:** The **Work** will be deemed to be substantially complete when the two conditions set forth below have been met.

14.2.1 **Inspection:** The **Engineer** has inspected the **Work** and has made a written determination that it is substantially complete.

14.2.2 **Approval of Final Approved Punch List and Date for Final Acceptance:** Following inspection of the **Work**, the **Engineer** shall furnish the **Contractor** with a final punch list, specifying all items of **Work** to be completed and proposing dates for the completion of each specified item of **Work**. The **Contractor** shall then submit in writing to the **Engineer** within ten (10) **Days** of the **Engineer** furnishing the final punch list either acceptance of the dates or proposed alternative dates for the completion of each specified item of **Work**. If the **Contractor** proposes alternative dates, then, within a reasonable time after receipt, the **Engineer**, in a written notification to the **Contractor**, shall approve the **Contractor's** completion dates or, if they are unable to agree, the **Engineer** shall establish dates for the completion of each item of **Work**. If the **Contractor** neither accepts the dates nor proposes alternative dates within ten (10) **Days**, the schedule proposed by the **Engineer** shall be deemed accepted. The latest completion date specified shall be the date for **Final Acceptance** of the **Work**.

14.3 **Date of Substantial Completion.** The date of approval of the **Final Approved Punch List**, shall be the date of **Substantial Completion**. The date of approval of the **Final Approved Punch List** shall be either (a) if the **Contractor** approves the final punch list and proposed dates for completion furnished by the **Engineer**, the date of the **Contractor's** approval; or (b) if the **Contractor** neither accepts the dates nor proposes alternative dates, ten (10) **Days** after the **Engineer** furnishes the **Contractor** with a final punch list and proposed dates for completion; or (c) if the **Contractor** proposes alternative dates, the date that the **Engineer** sends written notification to the **Contractor** either approving the **Contractor's** proposed alternative dates or establishing dates for the completion for each item of **Work**.

14.4 **Determining the Date of Final Acceptance:** The **Work** will be accepted as final and complete as of the date of the **Engineer's** inspection if, upon such inspection, the **Engineer** finds that all items on the **Final Approved Punch List** are complete and no further **Work** remains to be done. The **Commissioner** will then issue a written determination of **Final Acceptance**.

14.5 Request for Inspection: Inspection of the Work by the Engineer for the purpose of Substantial Completion or Final Acceptance shall be made within ten (10) Days after receipt of the Contractor's written request therefor.

14.6 Request for Re-inspection: If upon inspection for the purpose of Substantial Completion or Final Acceptance, the Engineer determines that there are items of Work still to be performed, the Contractor shall promptly perform them and then request a re-inspection. If upon re-inspection, the Engineer determines that the Work is substantially complete or finally accepted, the date of such re-inspection shall be the date of Substantial Completion or Final Acceptance. Re-inspection by the Engineer shall be made within ten (10) Days after receipt of the Contractor's written request therefor.

14.7 Initiation of Inspection by the Engineer: If the Contractor does not request inspection or re-inspection of the Work for the purpose of Substantial Completion or Final Acceptance, the Engineer may initiate such inspection or re-inspection.

#### **ARTICLE 15. LIQUIDATED DAMAGES**

15.1 In the event the Contractor fails to substantially complete the Work within the time fixed for such Substantial Completion in Schedule A of the General Conditions, plus authorized time extensions, or if the Contractor, in the sole determination of the Commissioner, has abandoned the Work, the Contractor shall pay to the City the sum fixed in Schedule A of the General Conditions, for each and every Day that the time consumed in substantially completing the Work exceeds the time allowed therefor; which said sum, in view of the difficulty of accurately ascertaining the loss which the City will suffer by reason of delay in the Substantial Completion of the Work hereunder, is hereby fixed and agreed as the liquidated damages that the City will suffer by reason of such delay, and not as a penalty. This Article 15 shall also apply to the Contractor whether or not the Contractor is defaulted pursuant to Chapter X of this Contract. Neither the failure to assess liquidated damages nor the granting of any time extension shall operate as a waiver or release of any claim the City may have against the Contractor for either actual or liquidated damages.

15.2 Liquidated damages received hereunder are not intended to be nor shall they be treated as either a partial or full waiver or discharge of the City's right to indemnification, or the Contractor's obligation to indemnify the City, or to any other remedy provided for in this Contract or by Law.

15.3 The Commissioner may deduct and retain out of the monies which may become due hereunder, the amount of any such liquidated damages; and in case the amount which may become due hereunder shall be less than the amount of liquidated damages suffered by the City, the Contractor shall be liable to pay the difference.

#### **ARTICLE 16. OCCUPATION OR USE PRIOR TO COMPLETION**

16.1 Unless otherwise provided for in the Specifications, the Commissioner may take over, use, occupy or operate any part of the Work at any time prior to Final Acceptance, upon written notification to the Contractor. The Engineer shall inspect the part of the Work to be taken over, used, occupied, or operated, and will furnish the Contractor with a written statement of the Work, if any, which remains to be performed on such part. The Contractor shall not object to, nor interfere with, the Commissioner's decision to exercise the rights granted by Article 16. In the event the Commissioner takes over, uses, occupies, or operates any part of the Work:

16.1.1 the Engineer shall issue a written determination of Substantial Completion with respect to such part of the Work;

16.1.2 the **Contractor** shall be relieved of its absolute obligation to protect such part of the unfinished **Work** in accordance with Article 7;

16.1.3 the **Contractor's** guarantee on such part of the **Work** shall begin on the date of such use by the **City**; and;

16.1.4 the **Contractor** shall be entitled to a return of so much of the amount retained in accordance with Article 21 as it relates to such part of the **Work**, except so much thereof as may be retained under Articles 24 and 44.

## CHAPTER IV SUBCONTRACTS AND ASSIGNMENTS

### ARTICLE 17. SUBCONTRACTS

17.1 The **Contractor** shall not make subcontracts totaling an amount more than the percentage of the total **Contract** price fixed in Schedule A of the General Conditions, without prior written permission from the **Commissioner**. All subcontracts made by the **Contractor** shall be in writing. No **Work** may be performed by a **Subcontractor** prior to the **Contractor** entering into a written subcontract with the **Subcontractor** and complying with the provisions of this Article 17.

17.2 Before making any subcontracts, the **Contractor** shall submit a written statement to the **Commissioner** giving the name and address of the proposed **Subcontractor**; the portion of the **Work** and materials which it is to perform and furnish; the cost of the subcontract; the VENDEX questionnaire if required; the proposed subcontract if requested by the **Commissioner**; and any other information tending to prove that the proposed **Subcontractor** has the necessary facilities, skill, integrity, past experience, and financial resources to perform the **Work** in accordance with the terms and conditions of this **Contract**.

17.3 In addition to the requirements in Article 17.2, **Contractor** is required to list the **Subcontractor** in the web based Subcontractor Reporting System through the City's Payee Information Portal (PIP), available at [www.nyc.gov/pip](http://www.nyc.gov/pip).<sup>1</sup> For each **Subcontractor** listed, **Contractor** is required to provide the following information: maximum contract value, description of **Subcontractor's** Work, start and end date of the subcontract and identification of the **Subcontractor's** industry. Thereafter, **Contractor** will be required to report in the system the payments made to each **Subcontractor** within 30 days of making the payment. If any of the required information changes throughout the Term of the **Contract**, **Contractor** will be required to revise the information in the system.

Failure of the **Contractor** to list a **Subcontractor** and/or to report **Subcontractor** payments in a timely fashion may result in the **Commissioner** declaring the **Contractor** in default of the **Contract** and will subject **Contractor** to liquidated damages in the amount of \$100 per day for each day that the **Contractor** fails to identify a **Subcontractor** along with the required information about the **Subcontractor** and/or fails to report payments to a **Subcontractor**, beyond the time frames set forth herein or in the notice from the **City**. Article 15 shall govern the issue of liquidated damages.

<sup>1</sup> In order to use the new system, a PIP account will be required. Detailed instructions on creating a PIP account and using the new system are also available at [www.nyc.gov/pip](http://www.nyc.gov/pip). Additional assistance with PIP may be obtained by emailing the Financial Information Services Agency Help Desk at [pip@fisa.nyc.gov](mailto:pip@fisa.nyc.gov).



17.4 If an approved **Subcontractor** elects to subcontract any portion of its subcontract, the proposed sub-subcontract shall be submitted in the same manner as directed above.

17.5 The **Commissioner** will notify the **Contractor** in writing whether the proposed **Subcontractor** is approved. If the proposed **Subcontractor** is not approved, the **Contractor** may submit another proposed **Subcontractor** unless the **Contractor** decides to do the **Work**. No **Subcontractor** shall be permitted to enter or perform any work on the **Site** unless approved.

17.6 Before entering into any subcontract hereunder, the **Contractor** shall provide the proposed **Subcontractor** with a complete copy of this document and inform the proposed **Subcontractor** fully and completely of all provisions and requirements of this **Contract** relating either directly or indirectly to the **Work** to be performed and the materials to be furnished under such subcontract, and every such **Subcontractor** shall expressly stipulate that all labor performed and materials furnished by the **Subcontractor** shall strictly comply with the requirements of this **Contract**.

17.7 Documents given to a prospective **Subcontractor** for the purpose of soliciting the **Subcontractor's** bid shall include either a copy of the bid cover or a separate information sheet setting forth the **Project** name, the **Contract** number (if available), the **Agency** (as noted in Article 2.1.6), and the **Project's** location.

17.8 The **Commissioner's** approval of a **Subcontractor** shall not relieve the **Contractor** of any of its responsibilities, duties, and liabilities hereunder. The **Contractor** shall be solely responsible to the **City** for the acts or defaults of its **Subcontractor** and of such **Subcontractor's** officers, agents, and employees, each of whom shall, for this purpose, be deemed to be the agent or employee of the **Contractor** to the extent of its subcontract.

17.9 If the **Subcontractor** fails to maintain the necessary facilities, skill, integrity, past experience, and financial resources (other than due to the **Contractor's** failure to make payments where required) to perform the **Work** in accordance with the terms and conditions of this **Contract**, the **Contractor** shall promptly notify the **Commissioner** and replace such **Subcontractor** with a newly approved **Subcontractor** in accordance with this Article 17.

17.10 The **Contractor** shall be responsible for ensuring that all **Subcontractors** performing **Work** at the **Site** maintain all insurance required by **Law**.

17.11 The **Contractor** shall promptly, upon request, file with the **Engineer** a conformed copy of the subcontract and its cost. The subcontract shall provide the following:

17.11.1 **Payment to Subcontractors:** The agreement between the **Contractor** and its **Subcontractor** shall contain the same terms and conditions as to method of payment for **Work**, labor, and materials, and as to retained percentages, as are contained in this **Contract**.

17.11.2 **Prevailing Rate of Wages:** The agreement between the **Contractor** and its **Subcontractor** shall include the prevailing wage rates and supplemental benefits to be paid in accordance with Labor Law Section 220.

17.11.3 **Section 6-123 of the Administrative Code:** Pursuant to the requirements of Section 6-123 of the Administrative Code, every agreement between the **Contractor** and a **Subcontractor** in excess of fifty thousand (\$50,000) dollars shall include a provision that the **Subcontractor** shall not engage in any unlawful discriminatory practice as defined in Title VIII of the Administrative Code (Section 8-101 *et seq.*).

17.11.4 All requirements required pursuant to federal and/or state grant agreement(s), if applicable to the **Work**.

17.12 The **Commissioner** may deduct from the amounts certified under this **Contract** to be due to the **Contractor**, the sum or sums due and owing from the **Contractor** to the **Subcontractors** according to the terms of the said subcontracts, and in case of dispute between the **Contractor** and its **Subcontractor**, or **Subcontractors**, as to the amount due and owing, the **Commissioner** may deduct and withhold from the amounts certified under this **Contract** to be due to the **Contractor** such sum or sums as may be claimed by such **Subcontractor**, or **Subcontractors**, in a sworn affidavit, to be due and owing until such time as such claim or claims shall have been finally resolved.

17.13 On contracts where performance bonds and payment bonds are executed, the **Contractor** shall include on each requisition for payment the following data: **Subcontractor's** name, value of the subcontract, total amount previously paid to **Subcontractor** for **Work** previously requisitioned, and the amount, including retainage, to be paid to the **Subcontractor** for **Work** included in the requisition.

17.14 On **Contracts** where performance bonds and payment bonds are not executed, the **Contractor** shall include with each requisition for payment submitted hereunder, a signed statement from each and every **Subcontractor** and/or **Materialman** for whom payment is requested in such requisition. Such signed statement shall be on the letterhead of the **Subcontractor** and/or **Materialman** for whom payment is requested and shall (i) verify that such **Subcontractor** and/or **Materialman** has been paid in full for all **Work** performed and/or material supplied to date, exclusive of any amount retained and any amount included on the current requisition, and (ii) state the total amount of retainage to date, exclusive of any amount retained on the current requisition.

## ARTICLE 18. ASSIGNMENTS

18.1 The **Contractor** shall not assign, transfer, convey or otherwise dispose of this **Contract**, or the right to execute it, or the right, title or interest in or to it or any part thereof, or assign, by power of attorney or otherwise any of the monies due or to become due under this **Contract**, unless the previous written consent of the **Commissioner** shall first be obtained thereto, and the giving of any such consent to a particular assignment shall not dispense with the necessity of such consent to any further or other assignments.

18.2 Such assignment, transfer, conveyance or other disposition of this **Contract** shall not be valid until filed in the office of the **Commissioner** and the **Comptroller**, with the written consent of the **Commissioner** endorsed thereon or attached thereto.

18.3 Failure to obtain the previous written consent of the **Commissioner** to such an assignment, transfer, conveyance or other disposition, may result in the revocation and annulment of this **Contract**. The **City** shall thereupon be relieved and discharged from any further liability to the **Contractor**, its assignees, transferees or sublessees, who shall forfeit and lose all monies therefor earned under the **Contract**, except so much as may be required to pay the **Contractor's** employees.

18.4 The provisions of this clause shall not hinder, prevent, or affect an assignment by the **Contractor** for the benefit of its creditors made pursuant to the **Laws** of the State of New York.

18.5 This **Contract** may be assigned by the **City** to any corporation, agency or instrumentality having authority to accept such assignment.

**CHAPTER V  
CONTRACTOR'S SECURITY AND GUARANTEE**

**ARTICLE 19. SECURITY DEPOSIT**

19.1 If performance and payment bonds are required, the City shall retain the bid security to ensure that the successful bidder executes the **Contract** and furnishes the required payment and performance security within ten (10) Days after notice of the award of the **Contract**. If the successful bidder fails to execute the **Contract** and furnish the required payment and performance security, the City shall retain such bid security as set forth in the Information for Bidders. If the successful bidder executes the **Contract** and furnishes the required payment and performance security, the City shall return the bid security within a reasonable time after the furnishing of such bonds and execution of the **Contract** by the City.

19.2 If performance and payment bonds are not required, the bid security shall be retained by the City as security for the Contractor's faithful performance of the **Contract**. If partial payments are provided, the bid security will be returned to the Contractor after the sum retained under Article 21 equals the amount of the bid security, subject to other provisions of this **Contract**. If partial payments are not provided, the bid security will be released when final payment is certified by the City for payment.

19.3 If the Contractor is declared in default under Article 48 prior to the return of the deposit, or if any claim is made such as referred to in Article 23, the amount of such deposit, or so much thereof as the Comptroller may deem necessary, may be retained and then applied by the Comptroller:

19.3.1 To compensate the City for any expense, loss or damage suffered or incurred by reason of or resulting from such default, including the cost of re-letting and liquidated damages; or

19.3.2 To indemnify the City against any and all claims.

**ARTICLE 20. PAYMENT GUARANTEE**

20.1 On **Contracts** where one hundred (100%) percent performance bonds and payment bonds are executed, this Article 20 does not apply.

20.2 In the event the terms of this **Contract** do not require the Contractor to provide a payment bond or where the **Contract** does not require a payment bond for one hundred (100%) percent of the **Contract** price, the City shall, in accordance with the terms of this Article 20, guarantee payment of all lawful claims for:

20.2.1 Wages and compensation for labor performed and/or services rendered; and

20.2.2 Materials, equipment, and supplies provided, whether incorporated into the **Work** or not, when demands have been filed with the City as provided hereinafter by any person, firm, or corporation which furnished labor, material, equipment, supplies, or any combination thereof, in connection with the **Work** performed hereunder (hereinafter referred to as the "beneficiary") at the direction of the City or the Contractor.

20.3 The provisions of Article 20.2 are subject to the following limitations and conditions:

20.3.1 If the **Contractor** provides a payment bond for a value that is less than one hundred (100%) percent of the value of the **Contract Work**, the payment bond provided by the **Contractor** shall be primary (and non-contributing) to the payment guarantee provided under this Article 20.

20.3.2 The guarantee is made for the benefit of all beneficiaries as defined in Article 20.2 provided that those beneficiaries strictly adhere to the terms and conditions of Article 20.3.4 and 20.3.5.

20.3.3 Nothing in this Article 20 shall prevent a beneficiary providing labor, services or material for the **Work** from suing the **Contractor** for any amounts due and owing the beneficiary by the **Contractor**.

20.3.4 Every person who has furnished labor or material, to the **Contractor** or to a **Subcontractor** of the **Contractor**, in the prosecution of the **Work** and who has not been paid in full therefor before the expiration of a period of ninety (90) **Days** after the date on which the last of the labor was performed or material was furnished by him/her for which the claim is made, shall have the right to sue on this payment guarantee in his/her own name for the amount, or the balance thereof, unpaid at the time of commencement of the action; provided, however, that a person having a direct contractual relationship with a **Subcontractor** of the **Contractor** but no contractual relationship express or implied with the **Contractor** shall not have a right of action upon the guarantee unless he/she shall have given written notice to the **Contractor** within one hundred twenty (120) **Days** from the date on which the last of the labor was performed or the last of the material was furnished, for which his/her claim is made, stating with substantial accuracy the amount claimed and the name of the party to whom the material was furnished or for whom the labor was performed. The notice shall be served by delivering the same personally to the **Contractor** or by mailing the same by registered mail, postage prepaid, in an envelope addressed to the **Contractor** at any place where it maintains an office or conducts its business; provided, however, that where such notice is actually received by the **Contractor** by other means, such notice shall be deemed sufficient.

20.3.5 Except as provided in Labor Law Section 220-g, no action on this payment guarantee shall be commenced after the expiration of the one-year limitations period set forth in Section 137(4)(b) of the State Finance Law.

20.3.6 The **Contractor** shall promptly forward to the **City** any notice or demand received pursuant to Article 20.3.4. The **Contractor** shall inform the **City** of any defenses to the notice or demand and shall forward to the **City** any documents the **City** requests concerning the notice or demand.

20.3.7 All demands made against the **City** by a beneficiary of this payment guarantee shall be presented to the **Engineer** along with all written documentation concerning the demand which the **Engineer** deems reasonably appropriate or necessary, which may include, but shall not be limited to: the subcontract; any invoices presented to the **Contractor** for payment; the notarized statement of the beneficiary that the demand is due and payable, that a request for payment has been made of the **Contractor** and that the demand has not been paid by the **Contractor** within the time allowed for such payment by the subcontract; and copies of any correspondence between the beneficiary and the **Contractor** concerning such demand. The **City** shall notify the **Contractor** that a demand has been made. The **Contractor** shall inform the **City** of any defenses to the demand and shall forward to the **City** any documents the **City** requests concerning the demand.

20.3.8 The City shall make payment only if, after considering all defenses presented by the Contractor, it determines that the payment is due and owing to the beneficiary making the demand.

20.3.9 No beneficiary shall be entitled to interest from the City, or to any other costs, including, but not limited to, attorneys' fees, except to the extent required by State Finance Law Section 137.

20.4 Upon the receipt by the City of a demand pursuant to this Article 20, the City may withhold from any payment otherwise due and owing to the Contractor under this Contract an amount sufficient to satisfy the demand.

20.4.1 In the event the City determines that the demand is valid, the City shall notify the Contractor of such determination and the amount thereof and direct the Contractor to immediately pay such amount to the beneficiary. In the event the Contractor, within seven (7) Days of receipt of such notification from the City, fails to pay the beneficiary, such failure shall constitute an automatic and irrevocable assignment of payment by the Contractor to the beneficiary for the amount of the demand determined by the City to be valid. The Contractor, without further notification or other process, hereby gives its unconditional consent to such assignment of payment to the beneficiary and authorizes the City, on its behalf, to take all necessary actions to implement such assignment of payment, including without limitation the execution of any instrument or documentation necessary to effectuate such assignment.

20.4.2 In the event that the amount otherwise due and owing to the Contractor by the City is insufficient to satisfy such demand, the City may, at its option, require payment from the Contractor of an amount sufficient to cover such demand and exercise any other right to require or recover payment which the City may have under Law or Contract.

20.4.3 In the event the City determines that the demand is invalid, any amount withheld pending the City's review of such demand shall be paid to the Contractor; provided, however, no lien has been filed. In the event a claim or an action has been filed, the terms and conditions set forth in Article 23 shall apply. In the event a lien has been filed, the parties will be governed by the provisions of the Lien Law of the State of New York.

20.5 The provisions of this Article 20 shall not prevent the City and the Contractor from resolving disputes in accordance with the PPB Rules, where applicable.

20.6 In the event the City determines that the beneficiary is entitled to payment pursuant to this Article 20, such determination and any defenses and counterclaims raised by the Contractor shall be taken into account in evaluating the Contractor's performance.

20.7 Nothing in this Article 20 shall relieve the Contractor of the obligation to pay the claims of all persons with valid and lawful claims against the Contractor relating to the Work.

20.8 The Contractor shall not require any performance, payment or other bonds of any Subcontractor if this Contract does not require such bonds of the Contractor.

20.9 The payment guarantee made pursuant to this Article 20 shall be construed in a manner consistent with Section 137 of the State Finance Law and shall afford to persons furnishing labor or materials to the Contractor or its Subcontractors in the prosecution of the Work under this Contract all of the rights and remedies afforded to such persons by such section, including but not limited to, the right

to commence an action against the City on the payment guarantee provided by this Article 20 within the one-year limitations period set forth in Section 137(4)(b).

#### **ARTICLE 21. RETAINED PERCENTAGE**

21.1 If this **Contract** requires one hundred (100%) percent performance and payment security, then as further security for the faithful performance of this **Contract**, the **Commissioner** shall deduct, and retain until the substantial completion of the **Work**, five (5%) percent of the value of **Work** certified for payment in each partial payment voucher.

21.2 If this **Contract** does not require one hundred (100%) percent performance and payment security and if the price for which this **Contract** was awarded does not exceed one million (\$1,000,000) dollars, then as further security for the faithful performance of this **Contract**, the **Commissioner** shall deduct, and retain until the substantial completion of the **Work**, five (5%) percent of the value of **Work** certified for payment in each partial payment voucher.

21.3 If this **Contract** does not require one hundred (100%) percent performance and payment security and if the price for which this **Contract** was awarded exceeds one million (\$1,000,000) dollars, then as further security for the faithful performance of this **Contract**, the **Commissioner** shall deduct, and retain until the substantial completion of the **Work**, up to ten (10%) percent of the value of **Work** certified for payment in each partial payment voucher. The percentage to be retained is set forth in Schedule A of the General Conditions.

#### **ARTICLE 22. INSURANCE**

22.1 Types of Insurance: The **Contractor** shall procure and maintain the following types of insurance if, and as indicated, in Schedule A of the General Conditions (with the minimum limits and special conditions specified in Schedule A). Such insurance shall be maintained from the date the **Contractor** is required to provide Proof of Insurance pursuant to Article 22.3.1 through the date of completion of all required **Work** (including punch list work as certified in writing by the **Resident Engineer**), except for insurance required pursuant to Article 22.1.4, which may terminate upon **Substantial Completion** of the **Contract**. All insurance shall meet the requirements set forth in this Article 22. Wherever this Article requires that insurance coverage be "at least as broad" as a specified form (including all ISO forms), there is no obligation that the form itself be used, provided that the **Contractor** can demonstrate that the alternative form or endorsement contained in its policy provides coverage at least as broad as the specified form.

22.1.1 Commercial General Liability Insurance: The **Contractor** shall provide Commercial General Liability Insurance covering claims for property damage and/or bodily injury, including death, which may arise from any of the operations under this **Contract**. Coverage under this insurance shall be at least as broad as that provided by the latest edition of Insurance Services Office ("ISO") Form CG 0001. Such insurance shall be "occurrence" based rather than "claims-made," and include, without limitation, the following types of coverage: premises operations; products and completed operations; contractual liability (including the tort liability of another assumed in a contract); broad form property damage; independent contractors; explosion, collapse and underground (XCU); construction means and methods; and incidental malpractice. Such insurance shall contain a "per project" aggregate limit, as specified in Schedule A, that applies separately to operations under this **Contract**.

22.1.1(a) Such Commercial General Liability Insurance shall name the City as an Additional Insured. Coverage for the City shall specifically include the City's officials and employees, be at least as broad as the latest edition of ISO Form CG 20 10 and provide completed operations coverage at least as broad as the latest edition of ISO Form CG 20 37.

22.1.1(b) Such Commercial General Liability Insurance shall name all other entities designated as additional insureds in Schedule A but only for claims arising from the Contractor's operations under this Contract, with coverage at least as broad as the latest edition of ISO Form CG 20 26.

22.1.1(c) If the Work requires a permit from the Department of Buildings pursuant to 1 RCNY Section 101-08, at [http://www.nyc.gov/html/dob/downloads/rules/1\\_RCNY\\_101-08.pdf](http://www.nyc.gov/html/dob/downloads/rules/1_RCNY_101-08.pdf), the Contractor shall provide Commercial General Liability Insurance with limits of at least those required by 1 RCNY section 101-08. If the Work does not require such a permit, the minimum limits shall be those provided for in Schedule A.

22.1.1(d) If any of the Work includes repair of a waterborne vessel owned by or to be delivered to the City, such Commercial General Liability shall include, or be endorsed to include, Ship Repairer's Legal Liability Coverage to protect against, without limitation, liability arising from navigation of such vessels prior to delivery to and acceptance by the City.

22.1.2 Workers' Compensation Insurance, Employers' Liability Insurance, and Disability Benefits Insurance: The Contractor shall provide, and shall cause its Subcontractors to provide, Workers Compensation Insurance, Employers' Liability Insurance, and Disability Benefits Insurance in accordance with the Laws of the State of New York on behalf of all employees providing services under this Contract (except for those employees, if any, for which the Laws require insurance only pursuant to Article 22.1.3).

22.1.3 United States Longshoremen's and Harbor Workers Act and/or Jones Act Insurance: If specified in Schedule A of the General Conditions or if required by Law, the Contractor shall provide insurance in accordance with the United States Longshoremen's and Harbor Workers Act and/or the Jones Act, on behalf of all qualifying employees providing services under this Contract.

22.1.4 Builders Risk Insurance: If specified in Schedule A of the General Conditions, the Contractor shall provide Builders Risk Insurance on a completed value form for the total value of the Work through Substantial Completion of the Work in its entirety. Such insurance shall be provided on an All Risk basis and include coverage, without limitation, for windstorm (including named windstorm), storm surge, flood and earth movement. Unless waived by the Commissioner, it shall include coverage for ordinance and law, demolition and increased costs of construction, debris removal, pollutant clean up and removal, and expediting costs. Such insurance shall cover, without limitation, (a) all buildings and/or structures involved in the Work, as well as temporary structures at the Site, and (b) any property that is intended to become a permanent part of such building or structure, whether such property is on the Site, in transit or in temporary storage. Policies shall name the Contractor as Named Insured and list the City as both an Additional Insured and a Loss Payee as its interest may appear.

22.1.4(a) Policies of such insurance shall specify that, in the event a loss occurs at an occupied facility, occupancy of such facility is permitted without the consent of the issuing insurance company.

22.1.4(b) Such insurance may be provided through an Installation Floater, at the **Contractor's** option, if it otherwise conforms with the requirements of this Article 22.1.4.

22.1.5 Commercial Automobile Liability Insurance: The **Contractor** shall provide Commercial Automobile Liability Insurance for liability arising out of ownership, maintenance or use of any owned (if any), non-owned and hired vehicles to be used in connection with this **Contract**. Coverage shall be at least as broad as the latest edition of ISO Form CA0001. If vehicles are used for transporting hazardous materials, the Automobile Liability Insurance shall be endorsed to provide pollution liability broadened coverage for covered vehicles (endorsement CA 99 48) as well as proof of MCS 90.

22.1.6 Contractors Pollution Liability Insurance: If specified in Schedule A of the General Conditions, the **Contractor** shall maintain, or cause the **Subcontractor** doing such **Work** to maintain, Contractors Pollution Liability Insurance covering bodily injury and property damage. Such insurance shall provide coverage for actual, alleged or threatened emission, discharge, dispersal, seepage, release or escape of pollutants (including asbestos), including any loss, cost or expense incurred as a result of any cleanup of pollutants (including asbestos) or in the investigation, settlement or defense of any claim, action, or proceedings arising from the operations under this **Contract**. Such insurance shall be in the **Contractor's** name and list the **City** as an Additional Insured and any other entity specified in Schedule A. Coverage shall include, without limitation, (a) loss of use of damaged property or of property that has not been physically injured, (b) transportation, and (c) non-owned disposal sites.

22.1.6(a) Coverage for the **City** as Additional Insured shall specifically include the **City's** officials and employees and be at least as broad as provided to the **Contractor** for this **Project**.

22.1.6(b) If such insurance is written on a claims-made policy, such policy shall have a retroactive date on or before the effective date of this **Contract**, and continuous coverage shall be maintained, or an extended discovery period exercised, for a period of not less than three (3) years from the time the **Work** under this **Contract** is completed.

22.1.7 Marine Insurance:

22.1.7(a) Marine Protection and Indemnity Insurance: If specified in Schedule A of the General Conditions or if the **Contractor** engages in marine operations in the execution of any part of the **Work**, the **Contractor** shall maintain, or cause the **Subcontractor** doing such **Work** to maintain, Marine Protection and Indemnity Insurance with coverage at least as broad as Form SP-23. The insurance shall provide coverage for the **Contractor** or **Subcontractor** (whichever is doing this **Work**) and for the **City** (together with its officials and employees) and any other entity specified in Schedule A as an Additional Insured for bodily injury and property damage arising from marine operations under this **Contract**. Coverage shall include, without limitation, injury or death of crew members (if not fully provided through other insurance), removal of wreck, damage to piers, wharves and other fixed or floating objects and loss of or damage to any other vessel or craft, or to property on such other vessel or craft.



22.1.7(b) Hull and Machinery Insurance: If specified in Schedule A of the General Conditions or if the **Contractor** engages in marine operations in the execution of any part of the **Work**, the **Contractor** shall maintain, or cause the **Subcontractor** doing such **Work** to maintain, Hull and Machinery Insurance with coverage for the **Contractor** or **Subcontractor** (whichever is doing this **Work**) and for the **City** (together with its officials and employees) as Additional Insured at least as broad as the latest edition of American Institute Tug Form for all tugs used under this **Contract** and Collision Liability at least as broad as the latest edition of American Institute Hull Clauses.

22.1.7(c) Marine Pollution Liability Insurance: If specified in Schedule A of the General Conditions or if the **Contractor** engages in marine operations in the execution of any part of the **Work**, the **Contractor** shall maintain, or cause the **Subcontractor** doing such **Work** to maintain, Marine Pollution Liability Insurance covering itself (or the **Subcontractor** doing such **Work**) as Named Insured and the **City** (together with its officials and employees) and any other entity specified in Schedule A as an Additional Insured. Coverage shall be at least as broad as that provided by the latest edition of Water Quality Insurance Syndicate Form and include, without limitation, liability arising from the discharge or substantial threat of a discharge of oil, or from the release or threatened release of a hazardous substance including injury to, or economic losses resulting from, the destruction of or damage to real property, personal property or natural resources.

22.1.8 The **Contractor** shall provide such other types of insurance, at such minimum limits and with such conditions, as are specified in Schedule A of the General Conditions.

## 22.2 General Requirements for Insurance Coverage and Policies:

22.2.1 All required insurance policies shall be maintained with companies that may lawfully issue the required policy and have an A.M. Best rating of at least A-/VII or a Standard and Poor's rating of at least A, unless prior written approval is obtained from the **City** Corporation Counsel.

22.2.2 The **Contractor** shall be solely responsible for the payment of all premiums for all required policies and all deductibles and self-insured retentions to which such policies are subject, whether or not the **City** is an insured under the policy.

22.2.3 In his/her sole discretion, the **Commissioner** may, subject to the approval of the **Comptroller** and the **City** Corporation Counsel, accept Letters of Credit and/or custodial accounts in lieu of required insurance.

22.2.4 The **City's** limits of coverage for all types of insurance required pursuant to Schedule A of the General Conditions shall be the greater of (i) the minimum limits set forth in Schedule A or (ii) the limits provided to the **Contractor** as Named Insured under all primary, excess, and umbrella policies of that type of coverage.

22.2.5 The **Contractor** may satisfy its insurance obligations under this Article 22 through primary policies or a combination of primary and excess/umbrella policies, so long as all policies provide the scope of coverage required herein.

22.2.6 Policies of insurance provided pursuant to this Article 22 shall be primary and non-contributing to any insurance or self-insurance maintained by the **City**.

### 22.3 Proof of Insurance:

22.3.1 For all types of insurance required by Article 22.1 and Schedule A, except for insurance required by Articles 22.1.4 and 22.1.7, the **Contractor** shall file proof of insurance in accordance with this Article 22.3 within ten (10) **Days** of award. For insurance provided pursuant to Articles 22.1.4 and 22.1.7, proof shall be filed by a date specified by the **Commissioner** or ten (10) **Days** prior to the commencement of the portion of the **Work** covered by such policy, whichever is earlier.

22.3.2 For Workers' Compensation Insurance provided pursuant to Article 22.1.2, the **Contractor** shall submit one of the following forms: C-105.2 Certificate of Workers' Compensation Insurance; U-26.3 - State Insurance Fund Certificate of Workers' Compensation Insurance; Request for WC/DB Exemption (Form CE-200); equivalent or successor forms used by the New York State Workers' Compensation Board; or other proof of insurance in a form acceptable to the **Commissioner**. For Disability Benefits Insurance provided pursuant to Article 22.1.2, the Contractor shall submit DB-120.1 - Certificate Of Insurance Coverage Under The NYS Disability Benefits Law, Request for WC/DB Exemption (Form CE-200); equivalent or successor forms used by the New York State Workers' Compensation Board; or other proof of insurance in a form acceptable to the **Commissioner**. ACORD forms are not acceptable.

22.3.3 For policies provided pursuant to all of Article 22.1 other than Article 22.1.2, the **Contractor** shall submit one or more Certificates of Insurance on forms acceptable to the **Commissioner**. All such Certificates of Insurance shall certify (a) the issuance and effectiveness of such policies of insurance, each with the specified minimum limits (b) for insurance secured pursuant to Article 22.1.1 that the **City** and any other entity specified in Schedule A is an Additional Insured with coverage at least as broad as the most recent edition of ISO Forms CG 20 10, CG 20 37, and CG 20 26, as applicable; (c) in the event insurance is required pursuant to Article 22.1.6 and/or Article 22.1.7, that the **City** is an Additional Insured thereunder; (d) the company code issued to the insurance company by the National Association of Insurance Commissioners (the NAIC number); and (e) the number assigned to the **Contract** by the **City**. All such Certificates of Insurance shall be accompanied by either a duly executed "Certification by Broker" in the form contained in Part III of Schedule A or copies of all policies referenced in such Certificate of Insurance as certified by an authorized representative of the issuing insurance carrier. If any policy is not available at the time of submission, certified binders may be submitted until such time as the policy is available, at which time a certified copy of the policy shall be submitted.

22.3.4 Documentation confirming renewals of insurance shall be submitted to the **Commissioner** prior to the expiration date of coverage of policies required under this **Contract**. Such proofs of insurance shall comply with the requirements of Articles 22.3.2 and 22.3.3.

22.3.5 The **Contractor** shall be obligated to provide the **City** with a copy of any policy of insurance provided pursuant to this Article 22 upon the demand for such policy by the **Commissioner** or the **City Corporation Counsel**.

### 22.4 Operations of the Contractor:

22.4.1 The **Contractor** shall not commence the **Work** unless and until all required certificates have been submitted to and accepted by the **Commissioner**. Acceptance by the **Commissioner** of a certificate does not excuse the **Contractor** from securing insurance

consistent with all provisions of this Article 22 or of any liability arising from its failure to do so.

22.4.2 The **Contractor** shall be responsible for providing continuous insurance coverage in the manner, form, and limits required by this **Contract** and shall be authorized to perform **Work** only during the effective period of all required coverage.

22.4.3 In the event that any of the required insurance policies lapse, are revoked, suspended or otherwise terminated, for whatever cause, the **Contractor** shall immediately stop all **Work**, and shall not recommence **Work** until authorized in writing to do so by the **Commissioner**. Upon quitting the **Site**, except as otherwise directed by the **Commissioner**, the **Contractor** shall leave all plant, materials, equipment, tools, and supplies on the **Site**. **Contract** time shall continue to run during such periods and no extensions of time will be granted. The **Commissioner** may also declare the **Contractor** in default for failure to maintain required insurance.

22.4.4 In the event the **Contractor** receives notice, from an insurance company or other person, that any insurance policy required under this Article 22 shall be cancelled or terminated (or has been cancelled or terminated) for any reason, the **Contractor** shall immediately forward a copy of such notice to both the **Commissioner** and the New York City Comptroller, attn: Office of Contract Administration, Municipal Building, One Centre Street, room 1005, New York, New York 10007. Notwithstanding the foregoing, the **Contractor** shall ensure that there is no interruption in any of the insurance coverage required under this Article 22.

22.4.5 Where notice of loss, damage, occurrence, accident, claim or suit is required under an insurance policy maintained in accordance with this Article 22, the **Contractor** shall notify in writing all insurance carriers that issued potentially responsive policies of any such event relating to any operations under this **Contract** (including notice to Commercial General Liability insurance carriers for events relating to the **Contractor's** own employees) no later than 20 days after such event. For any policy where the **City** is an Additional Insured, such notice shall expressly specify that "this notice is being given on behalf of the City of New York as Insured as well as the Named Insured." Such notice shall also contain the following information: the number of the insurance policy, the name of the named insured, the date and location of the damage, occurrence, or accident, and the identity of the persons or things injured, damaged or lost. The **Contractor** shall simultaneously send a copy of such notice to the City of New York c/o Insurance Claims Specialist, Affirmative Litigation Division, New York City Law Department, 100 Church Street, New York, New York 10007.

22.4.6 In the event of any loss, accident, claim, action, or other event that does or can give rise to a claim under any insurance policy required under this Article 22, the **Contractor** shall at all times fully cooperate with the **City** with regard to such potential or actual claim.

22.5 **Subcontractor Insurance:** In the event the **Contractor** requires any **Subcontractor** to procure insurance with regard to any operations under this **Contract** and requires such **Subcontractor** to name the **Contractor** as an **Additional Insured** thereunder, the **Contractor** shall ensure that the **Subcontractor** name the **City**, including its officials and employees, as an **Additional Insured** with coverage at least as broad as the most recent edition of ISO Form CG 20 26.

22.6 Wherever reference is made in Article 7 or this Article 22 to documents to be sent to the **Commissioner** (e.g., notices, filings, or submissions), such documents shall be sent to the address set forth in Schedule A of the General Conditions. In the event no address is set forth in Schedule A, such documents are to be sent to the **Commissioner's** address as provided elsewhere in this **Contract**.

22.7 Apart from damages or losses covered by insurance provided pursuant to Articles 22.1.2, 22.1.3, or 22.1.5, the **Contractor** waives all rights against the **City**, including its officials and employees, for any damages or losses that are covered under any insurance required under this Article 22 (whether or not such insurance is actually procured or claims are paid thereunder) or any other insurance applicable to the operations of the **Contractor** and/or its employees, agents, or **Subcontractors**.

22.8 In the event the **Contractor** utilizes a self-insurance program to satisfy any of the requirements of this Article 22, the **Contractor** shall ensure that any such self-insurance program provides the **City** with all rights that would be provided by traditional insurance under this Article 22, including but not limited to the defense and indemnification obligations that insurers are required to undertake in liability policies.

22.9 Materiality/Non-Waiver: The **Contractor's** failure to secure policies in complete conformity with this Article 22, or to give an insurance company timely notice of any sort required in this **Contract** or to do anything else required by this Article 22 shall constitute a material breach of this **Contract**. Such breach shall not be waived or otherwise excused by any action or inaction by the **City** at any time.

22.10 Pursuant to General Municipal Law Section 108, this **Contract** shall be void and of no effect unless **Contractor** maintains Workers' Compensation Insurance for the term of this **Contract** to the extent required and in compliance with the New York State Workers' Compensation Law.

22.11 Other Remedies: Insurance coverage provided pursuant to this Article 22 or otherwise shall not relieve the **Contractor** of any liability under this **Contract**, nor shall it preclude the **City** from exercising any rights or taking such other actions available to it under any other provisions of this **Contract** or **Law**.

### **ARTICLE 23. MONEY RETAINED AGAINST CLAIMS**

23.1 If any claim shall be made by any person or entity (including **Other Contractors** with the **City** on this **Project**) against the **City** or against the **Contractor** and the **City** for any of the following:

- (a) An alleged loss, damage, injury, theft or vandalism of any of the kinds referred to in Articles 7 and 12, plus the reasonable costs of defending the **City**, which in the opinion of the **Comptroller** may not be paid by an insurance company (for any reason whatsoever); or
- (b) An infringement of copyrights, patents or use of patented articles, tools, etc., as referred to in Article 57; or
- (c) Damage claimed to have been caused directly or indirectly by the failure of the **Contractor** to perform the **Work** in strict accordance with this **Contract**,

the amount of such claim, or so much thereof as the **Comptroller** may deem necessary, may be withheld by the **Comptroller**, as security against such claim, from any money due hereunder. The **Comptroller**, in his/her discretion, may permit the **Contractor** to substitute other satisfactory security in lieu of the monies so withheld.

23.2 If an action on such claim is timely commenced and the liability of the **City**, or the **Contractor**, or both, shall have been established therein by a final judgment of a court of competent jurisdiction, or if such claim shall have been admitted by the **Contractor** to be valid, the **Comptroller**

shall pay such judgment or admitted claim out of the monies retained by the **Comptroller** under the provisions of this Article 23, and return the balance, if any, without interest, to the **Contractor**.

#### ARTICLE 24. MAINTENANCE AND GUARANTY

24.1 The **Contractor** shall promptly repair, replace, restore or rebuild, as the **Commissioner** may determine, any finished **Work** in which defects of materials or workmanship may appear or to which damage may occur because of such defects, during the one (1) year period subsequent to the date of **Substantial Completion** (or use and occupancy in accordance with Article 16), except where other periods of maintenance and guaranty are provided for in Schedule A.

24.2 As security for the faithful performance of its obligations hereunder, the **Contractor**, upon filing its requisition for payment on **Substantial Completion**, shall deposit with the **Commissioner** a sum equal to one (1%) percent of the price (or the amount fixed in Schedule A of the General Conditions) in cash or certified check upon a state or national bank and trust company or a check of such bank and trust company signed by a duly authorized officer thereof and drawn to the order of the **Comptroller**, or obligations of the City, which the **Comptroller** may approve as of equal value with the sum so required.

24.3 In lieu of the above, the **Contractor** may make such security payment to the City by authorizing the **Commissioner** in writing to deduct the amount from the **Substantial Completion** payment which shall be deemed the deposit required above.

24.4 If the **Contractor** has faithfully performed all of its obligations hereunder the **Commissioner** shall so certify to the **Comptroller** within five (5) **Days** after the expiration of one (1) year from the date of **Substantial Completion** and acceptance of the **Work** or within thirty (30) **Days** after the expiration of the guarantee period fixed in the **Specifications**. The security payment shall be repaid to the **Contractor** without interest within thirty (30) **Days** after certification by the **Commissioner** to the **Comptroller** that the **Contractor** has faithfully performed all of its obligations hereunder.

24.5 Notice by the **Commissioner** to the **Contractor** to repair, replace, rebuild or restore such defective or damaged **Work** shall be timely, pursuant to this article, if given not later than ten (10) **Days** subsequent to the expiration of the one (1) year period or other periods provided for herein.

24.6 If the **Contractor** shall fail to repair, replace, rebuild or restore such defective or damaged **Work** promptly after receiving such notice, the **Commissioner** shall have the right to have the **Work** done by others in the same manner as provided for in the completion of a defaulted **Contract**, under Article 51.

24.7 If the security payment so deposited is insufficient to cover the cost of such **Work**, the **Contractor** shall be liable to pay such deficiency on demand by the **Commissioner**.

24.8 The **Engineer's** certificate setting forth the fair and reasonable cost of repairing, replacing, rebuilding or restoring any damaged or defective **Work** when performed by one other than the **Contractor**, shall be binding and conclusive upon the **Contractor** as to the amount thereof.

24.9 The **Contractor** shall obtain all manufacturers' warranties and guaranties of all equipment and materials required by this **Contract** in the name of the City and shall deliver same to the **Commissioner**. All of the City's rights and title and interest in and to said manufacturers' warranties and guaranties may be assigned by the City to any subsequent purchasers of such equipment and materials or lessees of the premises into which the equipment and materials have been installed.

**CHAPTER VI  
CHANGES, EXTRA WORK, AND DOCUMENTATION OF CLAIM**

**ARTICLE 25. CHANGES**

25.1 Changes may be made to this Contract only as duly authorized in writing by the Commissioner in accordance with the Law and this Contract. All such changes, modifications, and amendments will become a part of the Contract. Work so ordered shall be performed by the Contractor.

25.2 Contract changes will be made only for Work necessary to complete the Work included in the original scope of the Contract and/or for non-material changes to the scope of the Contract. Changes are not permitted for any material alteration in the scope of Work in the Contract.

25.3 The Contractor shall be entitled to a price adjustment for Extra Work performed pursuant to a written change order. Adjustments to price shall be computed in one or more of the following ways:

25.3.1 By applicable unit prices specified in the Contract; and/or

25.3.2 By agreement of a fixed price; and/or

25.3.3 By time and material records; and/or

25.3.4 In any other manner approved by the CCPO.

25.4 All payments for change orders are subject to pre-audit by the Engineering Audit Officer and may be post-audited by the Comptroller and/or the Agency.

**ARTICLE 26. METHODS OF PAYMENT FOR OVERRUNS AND EXTRA WORK**

26.1 Overrun of Unit Price Item: An overrun is any quantity of a unit price item which the Contractor is directed to provide which is in excess of one hundred twenty-five (125%) percent of the estimated quantity for that item set forth in the bid schedule.

26.1.1 For any unit price item, the Contractor will be paid at the unit price bid for any quantity up to one hundred twenty-five (125%) percent of the estimated quantity for that item set forth in the bid schedule. If during the progress of the Work, the actual quantity of any unit price item required to complete the Work approaches the estimated quantity for that item, and for any reason it appears that the actual quantity of any unit price item necessary to complete the Work will exceed the estimated quantity for that item by twenty-five (25%) percent, the Contractor shall immediately notify the Engineer of such anticipated overrun. The Contractor shall not be compensated for any quantity of a unit price item provided which is in excess of one hundred twenty-five (125%) percent of the estimated quantity for that item set forth in the bid schedule without written authorization from the Engineer.

26.1.2 If the actual quantity of any unit price item necessary to complete the Work will exceed one hundred twenty five (125%) percent of the estimated quantity for that item set forth in the bid schedule, the City reserves the right and the Contractor agrees to negotiate a new unit price for such item. In no event shall such negotiated new unit price exceed the unit bid price. If the City and Contractor cannot agree on a new unit price, then the City shall order the Contractor and the Contractor agrees to provide additional quantities of the

item on the basis of time and material records for the actual and reasonable cost as determined under Article 26.2, but in no event at a unit price exceeding the unit price bid.

26.2 **Extra Work:** For **Extra Work** where payment is by agreement on a fixed price in accordance with Article 25.3.2, the price to be paid for such **Extra Work** shall be based on the fair and reasonable estimated cost of the items set forth below. For **Extra Work** where payment is based on time and material records in accordance with Article 25.3.3, the price to be paid for such **Extra Work** shall be the actual and reasonable cost of the items set forth below, calculated in accordance with the formula specified therein, if any.

26.2.1 Necessary materials (including transportation to the Site); plus

26.2.2 Necessary direct labor, including payroll taxes (subject to statutory wage caps) and supplemental benefits; plus

26.2.3 Sales and personal property taxes, if any, required to be paid on materials not incorporated into such **Extra Work**; plus

26.2.4 Reasonable rental value of **Contractor**-owned (or **Subcontractor**-owned, as applicable), necessary plant and equipment other than **Small Tools**, plus fuel/energy costs. Except for fuel costs for pick-up trucks which shall be reimbursed based on a consumption of five (5) gallons per shift, fuel costs shall be reimbursed based on actual costs or, in the absence of auditable documentation, the following fuel consumption formula per operating hour:  $(.035) \times (\text{HP rating}) \times (\text{Fuel cost/gallon})$ . Reasonable rental value is defined as the lower of either seventy-five percent of the monthly prorated rental rates established in "The AED Green Book, Rental Rates and Specifications for Construction Equipment" published by Equipment Watch (the "Green Book"), or seventy-five percent of the monthly prorated rental rates established in the "Rental Rate Blue Book for Construction Equipment" published by Equipment Watch (the "Blue Book") (the applicable Blue Book rate being for rental only without the addition of any operational costs listed in the Blue Book). The reasonable rental value is deemed to be inclusive of all operating costs except for fuel/energy consumption and equipment operator's wages/costs. For multiple shift utilization, reimbursement shall be calculated as follows: first shift shall be seventy-five (75%) percent of such rental rates; second shift shall be sixty (60%) percent of the first shift rate; and third shift shall be forty (40%) percent of the first shift rate. Equipment on standby shall be reimbursed at one-third (1/3) the prorated monthly rental rate. **Contractor**-owned (or **Subcontractor**-owned, as applicable) equipment includes equipment from rental companies affiliated with or controlled by the **Contractor** (or **Subcontractor**, as applicable), as determined by the **Commissioner**. In establishing cost reimbursement for non-operating **Contractor**-owned (or **Subcontractor**-owned, as applicable) equipment (scaffolding, sheeting systems, road plates, etc.), the **City** may restrict reimbursement to a purchase-salvage/life cycle basis if less than the computed rental costs; plus

26.2.5 Necessary installation and dismantling of such plant and equipment, including transportation to and from the Site, if any, provided that, in the case of non-**Contractor**-owned (or non-**Subcontractor**-owned, as applicable) equipment rented from a third party, the cost of installation and dismantling are not allowable if such costs are included in the rental rate; plus

26.2.6 Necessary fees charged by governmental entities; plus

26.2.7 Necessary construction-related service fees charged by non-governmental entities, such as landfill tipping fees; plus

26.2.8 Reasonable rental costs of non-Contractor-owned (or non-Subcontractor-owned, as applicable) necessary plant and equipment other than **Small Tools**, plus fuel/energy costs. Except for fuel costs for pick-up trucks which shall be reimbursed based on a consumption of five (5) gallons per shift, fuel costs shall be reimbursed based on actual costs or, in the absence of auditable documentation, the following fuel consumption formula per hour of operation:  $(.035) \times (\text{HP rating}) \times (\text{Fuel cost/gallon})$ . In lieu of renting, the City reserves the right to direct the purchase of non-operating equipment (scaffolding, sheeting systems, road plates, etc.), with payment on a purchase-salvage/life cycle basis, if less than the projected rental costs; plus

26.2.9 Workers' Compensation Insurance, and any insurance coverage expressly required by the City for the performance of the **Extra Work** which is different than the types of insurance required by Article 22 and Schedule A of the General Conditions. The cost of Workers' Compensation Insurance is subject to applicable payroll limitation caps and shall be based upon the carrier's Manual Rate for such insurance derived from the applicable class Loss Cost ("LC") and carrier's Lost Cost Multiplier ("LCM") approved by the New York State Department of Financial Services, and with the exception of experience rating, rate modifiers as promulgated by the New York Compensation Insurance Rating Board ("NYCIRB"); plus

26.2.10 Additional costs incurred as a result of the **Extra Work** for performance and payment bonds; plus

26.2.11 Twelve percent (12%) percent of the total of items in Articles 26.2.1 through 26.2.5 as compensation for overhead, except that no percentage for overhead will be allowed on **Payroll Taxes** or on the premium portion of overtime pay or on sales and personal property taxes. Overhead shall include without limitation, all costs and expenses in connection with administration, management superintendence, small tools, and insurance required by Schedule A of the General Conditions other than Workers' Compensation Insurance; plus

26.2.12 Ten (10%) percent of the total of items in Articles 26.2.1 through 26.2.5, plus the items in Article 26.2.11, as compensation for profit, except that no percentage for profit will be allowed on **Payroll Taxes** or on the premium portion of overtime pay or on sales and personal property taxes; plus

26.2.13 Five (5%) percent of the total of items in Articles 26.2.6 through 26.2.10 as compensation for overhead and profit.

26.3 Where the **Extra Work** is performed in whole or in part by other than the Contractor's own forces pursuant to Article 26.2, the Contractor shall be paid, subject to pre-audit by the **Engineering Audit Officer**, the cost of such Work computed in accordance with Article 26.2 above, plus an additional allowance of five (5%) percent to cover the Contractor's overhead and profit.

26.4 Where a change is ordered, involving both **Extra Work** and omitted or reduced **Contract Work**, the **Contract** price shall be adjusted, subject to pre-audit by the **EAO**, in an amount based on the difference between the cost of such **Extra Work** and of the omitted or reduced **Work**.

26.5 Where the Contractor and the Commissioner can agree upon a fixed price for **Extra Work** in accordance with Article 25.3.2 or another method of payment for **Extra Work** in accordance with Article



25.3.4, or for **Extra Work** ordered in connection with omitted **Work**, such method, subject to pre-audit by the **EAO**, may, at the option of the **Commissioner**, be substituted for the cost plus a percentage method provided in Article 26.2; provided, however, that if the **Extra Work** is performed by a **Subcontractor**, the **Contractor** shall not be entitled to receive more than an additional allowance of five (5%) percent for overhead and profit over the cost of such **Subcontractor's Work** as computed in accordance with Article 26.2.

## ARTICLE 27. RESOLUTION OF DISPUTES

27.1 All disputes between the **City** and the **Contractor** of the kind delineated in this Article 27.1 that arise under, or by virtue of, this **Contract** shall be finally resolved in accordance with the provisions of this Article 27 and the **PPB Rules**. This procedure for resolving all disputes of the kind delineated herein shall be the exclusive means of resolving any such disputes.

27.1.1 This Article 27 shall not apply to disputes concerning matters dealt with in other sections of the **PPB Rules**, or to disputes involving patents, copyrights, trademarks, or trade secrets (as interpreted by the courts of New York State) relating to proprietary rights in computer software.

27.1.2 This Article 27 shall apply only to disputes about the scope of **Work** delineated by the **Contract**, the interpretation of **Contract** documents, the amount to be paid for **Extra Work** or disputed work performed in connection with the **Contract**, the conformity of the **Contractor's Work** to the **Contract**, and the acceptability and quality of the **Contractor's Work**; such disputes arise when the **Engineer, Resident Engineer, Engineering Audit Officer**, or other designee of the **Commissioner** makes a determination with which the **Contractor** disagrees.

27.2 All determinations required by this Article 27 shall be made in writing clearly stated, with a reasoned explanation for the determination based on the information and evidence presented to the party making the determination. Failure to make such determination within the time required by this Article 27 shall be deemed a non-determination without prejudice that will allow application to the next level.

27.3 During such time as any dispute is being presented, heard, and considered pursuant to this Article 27, the **Contract** terms shall remain in force and the **Contractor** shall continue to perform **Work** as directed by the **ACCO** or the **Engineer**. Failure of the **Contractor** to continue **Work** as directed shall constitute a waiver by the **Contractor** of its claim.

### 27.4 Presentation of Disputes to **Commissioner**.

Notice of Dispute and Agency Response. The **Contractor** shall present its dispute in writing ("Notice of Dispute") to the **Commissioner** within thirty (30) Days of receiving written notice of the determination or action that is the subject of the dispute. This notice requirement shall not be read to replace any other notice requirements contained in the **Contract**. The Notice of Dispute shall include all the facts, evidence, documents, or other basis upon which the **Contractor** relies in support of its position, as well as a detailed computation demonstrating how any amount of money claimed by the **Contractor** in the dispute was arrived at. Within thirty (30) Days after receipt of the detailed written submission comprising the complete Notice of Dispute, the **Engineer, Resident Engineer, Engineering Audit Officer**, or other designee of the **Commissioner** shall submit to the **Commissioner** all materials he or she deems pertinent to the dispute. Following initial submissions to the **Commissioner**, either party may demand of the other the production of any document or other material the demanding party believes may be relevant to the dispute. The requested party shall produce all relevant materials that are not otherwise

protected by a legal privilege recognized by the courts of New York State. Any question of relevancy shall be determined by the **Commissioner** whose decision shall be final. Willful failure of the **Contractor** to produce any requested material whose relevancy the **Contractor** has not disputed, or whose relevancy has been affirmatively determined, shall constitute a waiver by the **Contractor** of its claim.

27.4.1 **Commissioner Inquiry.** The **Commissioner** shall examine the material and may, in his or her discretion, convene an informal conference with the **Contractor**, the **ACCO**, and the **Engineer, Resident Engineer, Engineering Audit Officer**, or other designee of the **Commissioner** to resolve the issue by mutual consent prior to reaching a determination. The **Commissioner** may seek such technical or other expertise as he or she shall deem appropriate, including the use of neutral mediators, and require any such additional material from either or both parties as he or she deems fit. The **Commissioner's** ability to render, and the effect of, a decision hereunder shall not be impaired by any negotiations in connection with the dispute presented, whether or not the **Commissioner** participated therein. The **Commissioner** may or, at the request of any party to the dispute, shall compel the participation of any **Other Contractor** with a contract related to the **Work** of this **Contract**, and that **Contractor** shall be bound by the decision of the **Commissioner**. Any **Other Contractor** thus brought into the dispute resolution proceeding shall have the same rights and obligations under this Article 27 as the **Contractor** initiating the dispute.

27.4.2 **Commissioner Determination.** Within thirty (30) **Days** after the receipt of all materials and information, or such longer time as may be agreed to by the parties, the **Commissioner** shall make his or her determination and shall deliver or send a copy of such determination to the **Contractor**, the **ACCO**, and **Engineer, Resident Engineer, Engineering Audit Officer**, or other designee of the **Commissioner**, as applicable, together with a statement concerning how the decision may be appealed.

27.4.3 **Finality of Commissioner's Decision.** The **Commissioner's** decision shall be final and binding on all parties, unless presented to the Contract Dispute Resolution Board pursuant to this Article 27. The **City** may not take a petition to the Contract Dispute Resolution Board. However, should the **Contractor** take such a petition, the **City** may seek, and the Contract Dispute Resolution Board may render, a determination less favorable to the **Contractor** and more favorable to the **City** than the decision of the **Commissioner**.

27.5 **Presentation of Dispute to the Comptroller.** Before any dispute may be brought by the **Contractor** to the Contract Dispute Resolution Board, the **Contractor** must first present its claim to the **Comptroller** for his or her review, investigation, and possible adjustment.

27.5.1 **Time, Form, and Content of Notice.** Within thirty (30) **Days** of its receipt of a decision by the **Commissioner**, the **Contractor** shall submit to the **Comptroller** and to the **Commissioner** a Notice of Claim regarding its dispute with the **Agency**. The Notice of Claim shall consist of (i) a brief written statement of the substance of the dispute, the amount of money, if any, claimed and the reason(s) the **Contractor** contends the dispute was wrongly decided by the **Commissioner**; (ii) a copy of the written decision of the **Commissioner**; and (iii) a copy of all materials submitted by the **Contractor** to the **Agency**, including the Notice of Dispute. The **Contractor** may not present to the **Comptroller** any material not presented to the **Commissioner**, except at the request of the **Comptroller**.

27.5.2 **Response.** Within thirty (30) **Days** of receipt of the Notice of Claim, the **Agency** shall make available to the **Comptroller** a copy of all material submitted by the **Agency** to the **Commissioner** in connection with the dispute. The **Agency** may not present to the

**Comptroller** any material not presented to the **Commissioner** except at the request of the **Comptroller**.

**27.5.3 Comptroller Investigation.** The **Comptroller** may investigate the claim in dispute and, in the course of such investigation, may exercise all powers provided in Sections 7-201 and 7-203 of the Administrative Code. In addition, the **Comptroller** may demand of either party, and such party shall provide, whatever additional material the **Comptroller** deems pertinent to the claim, including original business records of the **Contractor**. Willful failure of the **Contractor** to produce within fifteen (15) **Days** any material requested by the **Comptroller** shall constitute a waiver by the **Contractor** of its claim. The **Comptroller** may also schedule an informal conference to be attended by the **Contractor**, **Agency** representatives, and any other personnel desired by the **Comptroller**.

**27.5.4 Opportunity of Comptroller to Compromise or Adjust Claim.** The **Comptroller** shall have forty-five (45) **Days** from his or her receipt of all materials referred to in Article 27.5.3 to investigate the disputed claim. The period for investigation and compromise may be further extended by agreement between the **Contractor** and the **Comptroller**, to a maximum of ninety (90) **Days** from the **Comptroller's** receipt of all materials. The **Contractor** may not present its petition to the Contract Dispute Resolution Board until the period for investigation and compromise delineated in this Article 27.5.4 has expired. In compromising or adjusting any claim hereunder, the **Comptroller** may not revise or disregard the terms of the **Contract** between the parties.

**27.6 Contract Dispute Resolution Board.** There shall be a Contract Dispute Resolution Board composed of:

**27.6.1** The chief administrative law judge of the Office of Administrative Trials and Hearings (OATH) or his/her designated OATH administrative law judge, who shall act as chairperson, and may adopt operational procedures and issue such orders consistent with this Article 27 as may be necessary in the execution of the Contract Dispute Resolution Board's functions, including, but not limited to, granting extensions of time to present or respond to submissions;

**27.6.2** The **CCPO** or his/her designee; any designee shall have the requisite background to consider and resolve the merits of the dispute and shall not have participated personally and substantially in the particular matter that is the subject of the dispute or report to anyone who so participated; and

**27.6.3** A person with appropriate expertise who is not an employee of the **City**. This person shall be selected by the presiding administrative law judge from a prequalified panel of individuals, established and administered by OATH with appropriate background to act as decision-makers in a dispute. Such individual may not have a contract or dispute with the **City** or be an officer or employee of any company or organization that does, or regularly represents persons, companies, or organizations having disputes with the **City**.

**27.7 Petition to the Contract Dispute Resolution Board.** In the event the claim has not been settled or adjusted by the **Comptroller** within the period provided in this Article 27, the **Contractor**, within thirty (30) **Days** thereafter, may petition the Contract Dispute Resolution Board to review the **Commissioner's** determination.

**27.7.1 Form and Content of Petition by Contractor.** The **Contractor** shall present its dispute to the Contract Dispute Resolution Board in the form of a petition, which shall

include (i) a brief written statement of the substance of the dispute, the amount of money, if any, claimed, and the reason(s) the **Contractor** contends the dispute was wrongly decided by the **Commissioner**; (ii) a copy of the written Decision of the **Commissioner**, (iii) copies of all materials submitted by the **Contractor** to the Agency; (iv) a copy of the written decision of the **Comptroller**, if any, and (v) copies of all correspondence with, or written material submitted by the **Contractor**, to the **Comptroller**. The **Contractor** shall concurrently submit four (4) complete sets of the Petition: one set to the City Corporation Counsel (Attn: Commercial and Real Estate Litigation Division) and three (3) sets to the Contract Dispute Resolution Board at OATH's offices with proof of service on the City Corporation Counsel. In addition, the **Contractor** shall submit a copy of the written statement of the substance of the dispute, cited in (i) above, to both the **Commissioner** and the **Comptroller**.

**27.7.2 Agency Response.** Within thirty (30) Days of its receipt of the Petition by the City Corporation Counsel, the **Agency** shall respond to the brief written statement of the **Contractor** and make available to the Contract Dispute Resolution Board all material it submitted to the **Commissioner** and **Comptroller**. Three (3) complete copies of the **Agency** response shall be provided to the Contract Dispute Resolution Board and one to the **Contractor**. Extensions of time for submittal of the **Agency** response shall be given as necessary upon a showing of good cause or, upon consent of the parties, for an initial period of up to thirty (30) Days.

**27.7.3 Further Proceedings.** The Contract Dispute Resolution Board shall permit the **Contractor** to present its case by submission of memoranda, briefs, and oral argument. The Contract Dispute Resolution Board shall also permit the **Agency** to present its case in response to the **Contractor** by submission of memoranda, briefs, and oral argument. If requested by the City Corporation Counsel, the **Comptroller** shall provide reasonable assistance in the preparation of the **Agency's** case. Neither the **Contractor** nor the **Agency** may support its case with any documentation or other material that was not considered by the **Comptroller**, unless requested by the Contract Dispute Resolution Board. The Contract Dispute Resolution Board, in its discretion, may seek such technical or other expert advice as it shall deem appropriate and may seek, on its own or upon application of a party, any such additional material from any party as it deems fit. The Contract Dispute Resolution Board, in its discretion, may combine more than one dispute between the parties for concurrent resolution.

**27.7.4 Contract Dispute Resolution Board Determination.** Within forty-five (45) Days of the conclusion of all written submissions and oral arguments, the Contract Dispute Resolution Board shall render a written decision resolving the dispute. In an unusually complex case, the Contract Dispute Resolution Board may render its decision in a longer period, not to exceed ninety (90) Days, and shall so advise the parties at the commencement of this period. The Contract Dispute Resolution Board's decision must be consistent with the terms of the **Contract**. Decisions of the Contract Dispute Resolution Board shall only resolve matters before the Contract Dispute Resolution Board and shall not have precedential effect with respect to matters not before the Contract Dispute Resolution Board.

**27.7.5 Notification of Contract Dispute Resolution Board Decision.** The Contract Dispute Resolution Board shall send a copy of its decision to the **Contractor**, the **ACCO**, the Engineer, the **Comptroller**, the City Corporation Counsel, the **CCPO**, and the **PPB**. A decision in favor of the **Contractor** shall be subject to the prompt payment provisions of the **PPB** Rules. The Required Payment Date shall be thirty (30) Days after the date the parties are formally notified of the Contract Dispute Resolution Board's decision.

27.7.6 **Finality of Contract Dispute Resolution Board Decision.** The Contract Dispute Resolution

Board's decision shall be final and binding on all parties. Any party may seek review of the Contract Dispute Resolution Board's decision solely in the form of a challenge, filed within four (4) months of the date of the Contract Dispute Resolution Board's decision, in a court of competent jurisdiction of the State of New York, County of New York pursuant to Article 78 of the Civil Practice Law and Rules. Such review by the court shall be limited to the question of whether or not the Contract Dispute Resolution Board's decision was made in violation of lawful procedure, was affected by an error of Law, or was arbitrary and capricious or an abuse of discretion. No evidence or information shall be introduced or relied upon in such proceeding that was not presented to the Contract Dispute Resolution Board in accordance with this Article 27.

27.8 Any termination, cancellation, or alleged breach of the Contract prior to or during the pendency of any proceedings pursuant to this Article 27 shall not affect or impair the ability of the Commissioner or Contract Dispute Resolution Board to make a binding and final decision pursuant to this Article 27.

**ARTICLE 28. RECORD KEEPING FOR EXTRA OR DISPUTED WORK OR WORK ON A TIME & MATERIALS BASIS**

28.1 While the Contractor or any of its Subcontractors is performing Work on a time and material basis or Extra Work on a time and material basis ordered by the Commissioner under Article 25, or where the Contractor believes that it or any of its Subcontractors is performing Extra Work but a final determination by Agency has not been made, or the Contractor or any of its Subcontractors is performing disputed Work (whether on or off the Site), or complying with a determination or order under protest in accordance with Articles 11, 27, and 30, in each such case the Contractor shall furnish the Resident Engineer daily with three (3) copies of written statements signed by the Contractor's representative at the Site showing:

28.1.1 The name, trade, and number of each worker employed on such Work or engaged in complying with such determination or order, the number of hours employed, and the character of the Work each is doing; and

28.1.2 The nature and quantity of any materials, plant and equipment furnished or used in connection with the performance of such Work or compliance with such determination or order, and from whom purchased or rented.

28.2 A copy of such statement will be countersigned by the Resident Engineer, noting thereon any items not agreed to or questioned, and will be returned to the Contractor within two (2) Days after submission.

28.3 The Contractor and its Subcontractors, when required by the Commissioner, or the Comptroller, shall also produce for inspection, at the office of the Contractor or Subcontractor, any and all of its books, bid documents, financial statements, vouchers, records, daily job diaries and reports, and cancelled checks, and any other documents relating to showing the nature and quantity of the labor, materials, plant and equipment actually used in the performance of such Work, or in complying with such determination or order, and the amounts expended therefor, and shall permit the Commissioner and the Comptroller to make such extracts therefrom, or copies thereof, as they or either of them may desire.

28.4 In connection with the examination provided for herein, the Commissioner, upon demand therefor, will produce for inspection by the Contractor such records as the Agency may have with

respect to such **Extra Work** or disputed **Work** performed under protest pursuant to order of the **Commissioner**, except those records and reports which may have been prepared for the purpose of determining the accuracy and validity of the **Contractor's** claim.

28.5 Failure to comply strictly with these requirements shall constitute a waiver of any claim for extra compensation or damages on account of the performance of such **Work** or compliance with such determination or order.

#### **ARTICLE 29. OMITTED WORK**

29.1 If any **Contract Work** in a lump sum **Contract**, or if any part of a lump sum item in a unit price, lump sum, or percentage-bid **Contract** is omitted by the **Commissioner** pursuant to Article 33, the **Contract** price, subject to audit by the EAO, shall be reduced by a pro rata portion of the lump sum bid amount based upon the percent of **Work** omitted subject to Article 29.4. For the purpose of determining the pro rata portion of the lump sum bid amount, the bid breakdown submitted in accordance with Article 41 shall be considered, but shall not be the determining factor.

29.2 If the whole of a lump sum item or units of any other item is so omitted by the **Commissioner** in a unit price, lump sum, or percentage-bid **Contract**, then no payment will be made therefor except as provided in Article 29.4.

29.3 For units that have been ordered but are only partially completed, the unit price shall be reduced by a pro rata portion of the unit price bid based upon the percentage of **Work** omitted subject to Article 29.4.

29.4 In the event the **Contractor**, with respect to any omitted **Work**, has purchased any non-cancelable material and/or equipment that is not capable of use except in the performance of this **Contract** and has been specifically fabricated for the sole purpose of this **Contract**, but not yet incorporated into the **Work**, the **Contractor** shall be paid for such material and/or equipment in accordance with Article 64.2.1(b); provided, however, such payment is contingent upon the **Contractor's** delivery of such material and/or equipment in acceptable condition to a location designated by the **City**.

29.5 The **Contractor** agrees to make no claim for damages or for loss of overhead and profit with regard to any omitted **Work**.

#### **ARTICLE 30. NOTICE AND DOCUMENTATION OF COSTS AND DAMAGES: PRODUCTION OF FINANCIAL RECORDS**

30.1 If the **Contractor** shall claim to be sustaining damages by reason of any act or omission of the **City** or its agents, it shall submit to the **Commissioner** within forty-five (45) **Days** from the time such damages are first incurred, and every thirty (30) **Days** thereafter for as long as such damages are incurred, verified statements of the details and the amounts of such damages, together with documentary evidence of such damages. The **Contractor** may submit any of the above statements within such additional time as may be granted by the **Commissioner** in writing upon written request therefor. Failure of the **Commissioner** to respond in writing to a written request for additional time within thirty (30) **Days** shall be deemed a denial of the request. On failure of the **Contractor** to strictly comply with the foregoing provisions, such claims shall be deemed waived and no right to recover on such claims shall exist. Damages that the **Contractor** may claim in any action or dispute resolution procedure arising under or by reason of this **Contract** shall not be different from or in excess of the statements and documentation made pursuant to this Article 30.

30.2 In addition to the foregoing statements, the **Contractor** shall, upon notice from the **Commissioner**, produce for examination at the **Contractor's** office, by the **Engineer, Architect or Project Manager**, all of its books of account, bills, invoices, payrolls, subcontracts, time books, daily reports, bank deposit books, bank statements, check books, and cancelled checks, showing all of its acts and transactions in connection with or relating to or arising by reason of this **Contract**, and submit itself and persons in its employment, for examination under oath by any person designated by the **Commissioner** or **Comptroller** to investigate claims made or disputes against the **City** under this **Contract**. At such examination, a duly authorized representative of the **Contractor** may be present.

30.3 In addition to the statements required under Article 28 and this Article 30, the **Contractor** and/or its **Subcontractor** shall, within thirty (30) **Days** upon notice from the **Commissioner** or **Comptroller**, produce for examination at the **Contractor's** and/or **Subcontractor's** office, by a representative of either the **Commissioner** or **Comptroller**, all of its books of account, bid documents, financial statements, accountant workpapers, bills, invoices, payrolls, subcontracts, time books, daily reports, bank deposit books, bank statements, check books, and cancelled checks, showing all of its acts and transactions in connection with or relating to or arising by reason of this **Contract**. Further, the **Contractor** and/or its **Subcontractor** shall submit any person in its employment, for examination under oath by any person designated by the **Commissioner** or **Comptroller** to investigate claims made or disputes against the **City** under this **Contract**. At such examination, a duly authorized representative of the **Contractor** may be present.

30.4 Unless the information and examination required under Article 30.3 is provided by the **Contractor** and/or its **Subcontractor** upon thirty (30) **Days'** notice from the **Commissioner** or **Comptroller**, or upon the **Commissioner's** or **Comptroller's** written authorization to extend the time to comply, the **City** shall be released from all claims arising under, relating to or by reason of this **Contract**, except for sums certified by the **Commissioner** to be due under the provisions of this **Contract**. It is further stipulated and agreed that no person has the power to waive any of the foregoing provisions and that in any action or dispute resolution procedure against the **City** to recover any sum in excess of the sums certified by the **Commissioner** to be due under or by reason of this **Contract**, the **Contractor** must allege in its complaint and prove, at trial or during such dispute resolution procedure, compliance with the provisions of this Article 30.

30.5 In addition, after the commencement of any action or dispute resolution procedure by the **Contractor** arising under or by reason of this **Contract**, the **City** shall have the right to require the **Contractor** to produce for examination under oath, up until the trial of the action or hearing before the Contract Dispute Resolution Board, the books and documents described in Article 30.3 and submit itself and all persons in its employ for examination under oath. If this Article 30 is not complied with as required, then the **Contractor** hereby consents to the dismissal of the action or dispute resolution procedure.

**CHAPTER VII**  
**POWERS OF THE RESIDENT ENGINEER,**  
**THE ENGINEER OR ARCHITECT AND THE COMMISSIONER**

**ARTICLE 31. THE RESIDENT ENGINEER**

31.1 The **Resident Engineer** shall have the power to inspect, supervise, and control the performance of the **Work**, subject to review by the **Commissioner**. The **Resident Engineer** shall not, however, have the power to issue an **Extra Work** order, except as specifically designated in writing by the **Commissioner**.

**ARTICLE 32. THE ENGINEER OR ARCHITECT OR PROJECT MANAGER**

32.1 The **Engineer** or **Architect** or **Project Manager**, in addition to those matters elsewhere herein delegated to the **Engineer** and expressly made subject to his/her determination, direction or approval, shall have the power, subject to review by the **Commissioner**:

32.1.1 To determine the amount, quality, and location of the **Work** to be paid for hereunder; and

32.1.2 To determine all questions in relation to the **Work**, to interpret the **Contract Drawings, Specifications, and Addenda**, and to resolve all patent inconsistencies or ambiguities therein; and

32.1.3 To determine how the **Work** of this **Contract** shall be coordinated with **Work** of **Other Contractors** engaged simultaneously on this **Project**, including the power to suspend any part of the **Work**, but not the whole thereof; and

32.1.4 To make minor changes in the **Work** as he/she deems necessary, provided such changes do not result in a net change in the cost to the **City** or to the **Contractor** of the **Work** to be done under the **Contract**; and

32.1.5 To amplify the **Contract Drawings**, add explanatory information and furnish additional **Specifications** and drawings, consistent with this **Contract**.

32.2 The foregoing enumeration shall not imply any limitation upon the power of the **Engineer** or **Architect** or **Project Manager**, for it is the intent of this **Contract** that all of the **Work** shall generally be subject to his/her determination, direction, and approval, except where the determination, direction or approval of someone other than the **Engineer** or **Architect** or **Project Manager** is expressly called for herein.

32.3 The **Engineer** or **Architect** or **Project Manager** shall not, however, have the power to issue an **Extra Work** order, except as specifically designated in writing by the **Commissioner**.

**ARTICLE 33. THE COMMISSIONER**

33.1 The **Commissioner**, in addition to those matters elsewhere herein expressly made subject to his/her determination, direction or approval, shall have the power:

33.1.1 To review and make determinations on any and all questions in relation to this **Contract** and its performance; and

33.1.2 To modify or change this **Contract** so as to require the performance of **Extra Work** (subject, however, to the limitations specified in Article 25) or the omission of **Contract Work**; and

33.1.3 To suspend the whole or any part of the **Work** whenever in his/her judgment such suspension is required:

33.1.3(a) In the interest of the **City** generally; or



33.1.3(b) To coordinate the **Work** of the various contractors engaged on this **Project** pursuant to the provisions of Article 12; or

33.1.3(c) To expedite the completion of the entire **Project** even though the completion of this particular **Contract** may thereby be delayed.

#### **ARTICLE 34. NO ESTOPPEL**

34.1 Neither the **City** nor any **Agency**, official, agent or employee thereof, shall be bound, precluded or estopped by any determination, decision, approval, order, letter, payment or certificate made or given under or in connection with this **Contract** by the **City**, the **Commissioner**, the **Engineer**, the **Resident Engineer**, or any other official, agent or employee of the **City**, either before or after the final completion and acceptance of the **Work** and payment therefor:

34.1.1 From showing the true and correct classification, amount, quality or character of the **Work** actually done; or that any such determination, decision, order, letter, payment or certificate was untrue, incorrect or improperly made in any particular, or that the **Work**, or any part thereof, does not in fact conform to the requirements of this **Contract**; and

34.1.2 From demanding and recovering from the **Contractor** any overpayment made to it, or such damages as the **City** may sustain by reason of the **Contractor's** failure to perform each and every part of its **Contract**.

### **CHAPTER VIII LABOR PROVISIONS**

#### **ARTICLE 35. EMPLOYEES**

35.1 The **Contractor** and its **Subcontractors** shall not employ on the **Work**:

35.1.1 Anyone who is not competent, faithful and skilled in the **Work** for which he/she shall be employed; and whenever the **Commissioner** shall inform the **Contractor**, in writing, that any employee is, in his/her opinion, incompetent, unfaithful or disobedient, that employee shall be discharged from the **Work** forthwith, and shall not again be employed upon it; or

35.1.2 Any labor, materials or means whose employment, or utilization during the course of this **Contract**, may tend to or in any way cause or result in strikes, work stoppages, delays, suspension of **Work** or similar troubles by workers employed by the **Contractor** or its **Subcontractors**, or by any of the trades working in or about the buildings and premises where **Work** is being performed under this **Contract**, or by **Other Contractors** or their **Subcontractors** pursuant to other contracts, or on any other building or premises owned or operated by the **City**, its **Agencies**, departments, boards or authorities. Any violation by the **Contractor** of this requirement may, upon certification of the **Commissioner**, be considered as proper and sufficient cause for declaring the **Contractor** to be in default, and for the **City** to take action against it as set forth in Chapter X of this **Contract**, or such other article of this **Contract** as the **Commissioner** may deem proper; or

35.1.3 In accordance with Section 220.3-e of the Labor Law of the State of New York (hereinafter "Labor Law"), the **Contractor** and its **Subcontractors** shall not employ on the **Work** any apprentice, unless he/she is a registered individual, under a bona fide program

registered with the New York State Department of Labor. The allowable ratio of apprentices to journey-level workers in any craft classification shall not be greater than the ratio permitted to the **Contractor** as to its work force on any job under the registered program. Any employee listed on a payroll at an apprentice wage rate, who is not registered as above, shall be paid the wage rate determined by the **Comptroller** of the **City** for the classification of **Work** actually performed. The **Contractor** or **Subcontractor** will be required to furnish written evidence of the registration of its program and apprentices as well as all the appropriate ratios and wage rates, for the area of the construction prior to using any apprentices on the **Contract Work**.

35.2 If the total cost of the **Work** under this **Contract** is at least two hundred fifty thousand (\$250,000) dollars, all laborers, workers, and mechanics employed in the performance of the **Contract** on the public work site, either by the **Contractor**, **Subcontractor** or other person doing or contracting to do the whole or a part of the **Work** contemplated by the **Contract**, shall be certified prior to performing any **Work** as having successfully completed a course in construction safety and health approved by the United States Department of Labor's Occupational Safety and Health Administration that is at least ten (10) hours in duration.

35.3 In accordance with Local Law Nos. 30-2012 and 33-2012, codified at sections 6-132 and 12-113 of the Administrative Code, respectively,

35.3.1 The **Contractor** shall not take an adverse personnel action with respect to an officer or employee in retaliation for such officer or employee making a report of information concerning conduct which such officer or employee knows or reasonably believes to involve corruption, criminal activity, conflict of interest, gross mismanagement or abuse of authority by any officer or employee relating to this **Contract** to (a) the Commissioner of the Department of Investigation, (b) a member of the New York City Council, the Public Advocate, or the **Comptroller**, or (c) the CCPO, ACCO, Agency head, or **Commissioner**.

35.3.2 If any of the **Contractor's** officers or employees believes that he or she has been the subject of an adverse personnel action in violation of Article 35.3.1, he or she shall be entitled to bring a cause of action against the **Contractor** to recover all relief necessary to make him or her whole. Such relief may include but is not limited to: (a) an injunction to restrain continued retaliation, (b) reinstatement to the position such employee would have had but for the retaliation or to an equivalent position, (c) reinstatement of full fringe benefits and seniority rights, (d) payment of two times back pay, plus interest, and (e) compensation for any special damages sustained as a result of the retaliation, including litigation costs and reasonable attorney's fees.

35.3.3 The **Contractor** shall post a notice provided by the **City** in a prominent and accessible place on any site where work pursuant to the **Contract** is performed that contains information about:

35.3.3(a) how its employees can report to the New York City Department of Investigation allegations of fraud, false claims, criminality or corruption arising out of or in connection with the **Contract**; and

35.3.3(b) the rights and remedies afforded to its employees under Administrative Code sections 7-805 (the New York City False Claims Act) and 12-113 (the Whistleblower Protection Expansion Act) for lawful acts taken in connection with the reporting of allegations of fraud, false claims, criminality or corruption in connection with the **Contract**.

35.3.4 For the purposes of this Article 35.3, "adverse personnel action" includes dismissal, demotion, suspension, disciplinary action, negative performance evaluation, any action resulting in loss of staff, office space, equipment or other benefit, failure to appoint, failure to promote, or any transfer or assignment or failure to transfer or assign against the wishes of the affected officer or employee.

35.3.5 This Article 35.3 is applicable to all of the **Contractor's Subcontractors** having subcontracts with a value in excess of \$100,000; accordingly, the **Contractor** shall include this rider in all subcontracts with a value a value in excess of \$100,000.

35.4 Article 35.3 is not applicable to this **Contract** if it is valued at \$100,000 or less. Articles 35.3.1, 35.3.2, 35.3.4, and 35.3.5 are not applicable to this **Contract** if it was solicited pursuant to a finding of an emergency.

### ARTICLE 36. NO DISCRIMINATION

36.1 The **Contractor** specifically agrees, as required by Labor Law Section 220-e, as amended, that:

36.1.1 In the hiring of employees for the performance of **Work** under this **Contract** or any subcontract hereunder, neither the **Contractor**, **Subcontractor**, nor any person acting on behalf of such **Contractor** or **Subcontractor**, shall by reason of race, creed, color or national origin discriminate against any citizen of the State of New York who is qualified and available to perform the **Work** to which the employment relates;

36.1.2 Neither the **Contractor**, **Subcontractor**, nor any person on its behalf shall, in any manner, discriminate against or intimidate any employee hired for the performance of **Work** under this **Contract** on account of race, creed, color or national origin;

36.1.3 There may be deducted from the amount payable to the **Contractor** by the **City** under this **Contract** a penalty of fifty (\$50.00) dollars for each person for each **Day** during which such person was discriminated against or intimidated in violation of the provisions of this **Contract**; and

36.1.4 This **Contract** may be cancelled or terminated by the **City** and all moneys due or to become due hereunder may be forfeited, for a second or any subsequent violation of the terms or conditions of this Article 36.

36.1.5 This Article 36 covers all construction, alteration and repair of any public building or public work occurring in the State of New York and the manufacture, sale, and distribution of materials, equipment, and supplies to the extent that such operations are performed within the State of New York pursuant to this **Contract**.

36.2 The **Contractor** specifically agrees, as required by Section 6-108 of the Administrative Code, as amended, that:

36.2.1 It shall be unlawful for any person engaged in the construction, alteration or repair of buildings or engaged in the construction or repair of streets or highways pursuant to a **Contract** with the **City** or engaged in the manufacture, sale or distribution of materials, equipment or supplies pursuant to a **Contract** with the **City** to refuse to employ or to refuse to continue in any employment any person on account of the race, color or creed of such person.

36.2.2 It shall be unlawful for any person or any servant, agent or employee of any person, described in Article 36.1.2, to ask, indicate or transmit, orally or in writing, directly or indirectly, the race, color or creed or religious affiliation of any person employed or seeking employment from such person, firm or corporation.

36.2.3 Breach of the foregoing provisions shall be deemed a violation of a material provision of this **Contract**.

36.2.4 Any person, or the employee, manager or owner of or officer of such firm or corporation who shall violate any of the provisions of this Article 36.2 shall, upon conviction thereof, be punished by a fine of not more than one hundred (\$100.00) dollars or by imprisonment for not more than thirty (30) **Days**, or both.

36.3 This **Contract** is subject to the requirements of Executive Order No. 50 (1980) ("E.O. 50"), as revised, and the rules and regulations promulgated thereunder. No contract will be awarded unless and until these requirements have been complied with in their entirety. By signing this **Contract**, the **Contractor** agrees that it:

36.3.1 Will not engage in any unlawful discrimination against any employee or applicant for employment because of race, creed, color, national origin, sex, age, disability, marital status or sexual orientation with respect to all employment decisions including, but not limited to, recruitment, hiring, upgrading, demotion, downgrading, transfer, training, rates of pay or other forms of compensation, layoff, termination, and all other terms and conditions of employment; and

36.3.2 Will not engage in any unlawful discrimination in the selection of **Subcontractors** on the basis of the owner's race, color, creed, national origin, sex, age, disability, marital status or sexual orientation; and

36.3.3 Will state in all solicitations or advertisements for employees placed by or on behalf of the **Contractor** that all qualified applicants will receive consideration for employment without unlawful discrimination based on race, creed, color, national origin, sex, age, citizens status, disability, marital status, sexual orientation, or that it is an equal employment opportunity employer; and

36.3.4 Will send to each labor organization or representative of workers with which it has a collective bargaining agreement or other contract or memorandum of understanding, written notification of its equal employment opportunity commitments under E.O. 50 and the rules and regulations promulgated thereunder; and

36.3.5 Will furnish, before the award of the **Contract**, all information and reports, including an employment report, that are required by E.O. 50, the rules and regulations promulgated thereunder, and orders of the City Department of Business Services, Division of Labor Services (**DLS**) and will permit access to its books, records, and accounts by the **DLS** for the purposes of investigation to ascertain compliance with such rules, regulations, and orders.

36.4 The **Contractor** understands that in the event of its noncompliance with the nondiscrimination clauses of this **Contract** or with any of such rules, regulations, or orders, such noncompliance shall constitute a material breach of this **Contract** and noncompliance with E.O. 50 and the rules and regulations promulgated thereunder. After a hearing held pursuant to the rules of the **DLS**, the Director of the **DLS** may direct the **Commissioner** to impose any or all of the following sanctions:

36.4.1 Disapproval of the **Contractor**; and/or

36.4.2 Suspension or termination of the **Contract**; and/or

36.4.3 Declaring the **Contractor** in default; and/or

36.4.4 In lieu of any of the foregoing sanctions, the Director of the **DLS** may impose an employment program.

In addition to any actions taken under this **Contract**, failure to comply with E.O. 50 and the rules and regulations promulgated thereunder, in one or more instances, may result in a **City Agency** declaring the **Contractor** to be non-responsible in future procurements. The **Contractor** further agrees that it will refrain from entering into any **Contract** or **Contract** modification subject to E.O. 50 and the rules and regulations promulgated thereunder with a **Subcontractor** who is not in compliance with the requirements of E.O. 50 and the rules and regulations promulgated thereunder.

36.5 The **Contractor** specifically agrees, as required by Section 6-123 of the Administrative Code, that:

36.5.1 The **Contractor** will not engage in any unlawful discriminatory practice in violation of Title 8 of the Administrative Code; and

36.5.2 Any failure to comply with this Article 36.5 may subject the **Contractor** to the remedies set forth in Section 6-123 of the Administrative Code, including, where appropriate, sanctions such as withholding of payment, imposition of an employment program, finding the **Contractor** to be in default, cancellation of the **Contract**, or any other sanction or remedy provided by Law or **Contract**.

#### **ARTICLE 37. LABOR LAW REQUIREMENTS**

37.1 The **Contractor** shall strictly comply with all applicable provisions of the Labor Law, as amended. Such compliance is a material term of this **Contract**.

37.2 The **Contractor** specifically agrees, as required by Labor Law Sections 220 and 220-d, as amended, that:

37.2.1 **Hours of Work:** No laborer, worker, or mechanic in the employ of the **Contractor**, **Subcontractor** or other person doing or contracting to do the whole or a part of the **Work** contemplated by this **Contract** shall be permitted or required to work more than eight (8) hours in any one (1) **Day**, or more than five (5) **Days** in any one (1) week, except as provided in the Labor Law and in cases of extraordinary emergency including fire, flood, or danger to life or property, or in the case of national emergency when so proclaimed by the President of the United States of America.

37.2.2 In situations in which there are not sufficient laborers, workers, and mechanics who may be employed to carry on expeditiously the **Work** contemplated by this **Contract** as a result of such restrictions upon the number of hours and **Days** of labor, and the immediate commencement or prosecution or completion without undue delay of the **Work** is necessary for the preservation of the **Site** and/or for the protection of the life and limb of the persons using the same, such laborers, workers, and mechanics shall be permitted or required to

work more than eight (8) hours in any one (1) Day; or five (5) Days in any one (1) week; provided, however, that upon application of any Contractor, the Commissioner shall have first certified to the Commissioner of Labor of the State of New York (hereinafter "Commissioner of Labor") that such public Work is of an important nature and that a delay in carrying it to completion would result in serious disadvantage to the public; and provided, further, that such Commissioner of Labor shall have determined that such an emergency does in fact exist as provided in Labor Law Section 220.2.

37.2.3 Failure of the Commissioner to make such a certification to the Commissioner of Labor shall not entitle the Contractor to damages for delay or for any cause whatsoever.

37.2.4 Prevailing Rate of Wages: The wages to be paid for a legal day's Work to laborers, workers, or mechanics employed upon the Work contemplated by this Contract or upon any materials to be used thereon shall not be less than the "prevailing rate of wage" as defined in Labor Law Section 220, and as fixed by the Comptroller in the attached Schedule of Wage Rates and in updated schedules thereof. The prevailing wage rates and supplemental benefits to be paid are those in effect at the time the Work is being performed.

37.2.5 Requests for interpretation or correction in the Information for Bidders includes all requests for clarification of the classification of trades to be employed in the performance of the Work under this Contract. In the event that a trade not listed in the Contract is in fact employed during the performance of this Contract, the Contractor shall be required to obtain from the Agency the prevailing wage rates and supplementary benefits for the trades used and to complete the performance of this Contract at the price at which the Contract was awarded.

37.2.6 Minimum Wages: Except for employees whose wage is required to be fixed pursuant to Labor Law Section 220, all persons employed by the Contractor and any Subcontractor in the manufacture or furnishing of the supplies, materials, or equipment, or the furnishing of work, labor, or services, used in the performance of this Contract, shall be paid, without subsequent deduction or rebate unless expressly authorized by Law, not less than the sum mandated by Law.

37.3 Working Conditions: No part of the Work, labor or services shall be performed or rendered by the Contractor in any plants, factories, buildings or surroundings or under working conditions which are unsanitary or hazardous or dangerous to the health and safety of employees engaged in the performance of this Contract. Compliance with the safety, sanitary, and factory inspection Laws of the state in which the Work is to be performed shall be prima facie evidence of compliance with this Article 37.3.

37.4 Prevailing Wage Enforcement: The Contractor agrees to pay for all costs incurred by the City in enforcing prevailing wage requirements, including the cost of any investigation conducted by or on behalf of the Agency or the Comptroller, where the City discovers a failure to comply with any of the requirements of this Article 37 by the Contractor or its Subcontractor(s). The Contractor also agrees that, should it fail or refuse to pay for any such investigation, the Agency is hereby authorized to deduct from a Contractor's account an amount equal to the cost of such investigation.

37.4.1 The Labor Law Section 220 and Section 220-d, as amended, provide that this Contract shall be forfeited and no sum paid for any Work done hereunder on a second conviction for willfully paying less than:

37.4.1(a) The stipulated prevailing wage scale as provided in Labor Law section 220, as amended, or

37.4.1(b) The stipulated minimum hourly wage scale as provided in Labor Law section 220-d, as amended.

37.4.2 For any breach or violation of either working conditions (Article 37.3) or minimum wages (Article 37.2.6) provisions, the party responsible therefor shall be liable to the City for liquidated damages, which may be withheld from any amounts due on any contracts with the City of such party responsible, or may be recovered in actions brought by the City Corporation Counsel in the name of the City, in addition to damages for any other breach of this Contract, for a sum equal to the amount of any underpayment of wages due to any employee engaged in the performance of this Contract. In addition, the Commissioner shall have the right to cancel contracts and enter into other contracts for the completion of the original contract, with or without public letting, and the original Contractor shall be liable for any additional cost. All sums withheld or recovered as deductions, rebates, refunds, or underpayment of wages hereunder, shall be held in a special deposit account and shall be paid without interest, on order of the Comptroller, directly to the employees who have been paid less than minimum rates of pay as set forth herein and on whose account such sums were withheld or recovered, provided that no claims by employees for such payments shall be entertained unless made within two (2) years from the date of actual notice to the Contractor of the withholding or recovery of such sums by the City.

37.4.3 A determination by the Comptroller that a Contractor and/or its Subcontractor willfully violated Labor Law Section 220 will be forwarded to the City's five District Attorneys for review.

37.4.4 The Contractor's or Subcontractor's noncompliance with this Article 37.4 and Labor Law Section 220 may result in an unsatisfactory performance evaluation and the Comptroller may also find and determine that the Contractor or Subcontractor willfully violated the New York Labor Law.

37.4.4(a) An unsatisfactory performance evaluation for noncompliance with this Article 37.4 may result in a determination that the Contractor is a non-responsible bidder on subsequent procurements with the City and thus a rejection of a future award of a contract with the City, as well as any other sanctions provided for by Law.

37.4.4(b) Labor Law Section 220-b, as amended, provides that when two (2) final determinations have been rendered against a Contractor or Subcontractor within any consecutive six (6) year period determining that such Contractor or Subcontractor has willfully failed to pay the prevailing rate of wages or to provide supplements in accordance with the Labor Law and this Article 37.4, whether such failures were concurrent or consecutive and whether or not such final determinations concerning separate public works projects are rendered simultaneously, such Contractor or Subcontractor shall be ineligible to submit a bid on or be awarded any public works contract with the City for a period of five (5) years from the second final determination. If the final determination involves the falsification of payroll records or the kickback of wages or supplements, the Contractor or Subcontractor shall be ineligible to submit a bid on or be awarded any public works contract with the City for a period of five (5) years from the first final determination.

37.4.4(c) Labor Law Section 220, as amended, provides that the Contractor or Subcontractor found to have violated this Article 37.4 may be directed to make payment of wages or supplements including interest found to be due, and the Contractor or Subcontractor may be directed to make payment of a further sum as

a civil penalty in an amount not exceeding twenty-five (25%) percent of the total amount found to be due.

37.5 The **Contractor** and its **Subcontractors** shall within ten (10) **Days** after mailing of a Notice of Award or written order, post in prominent and conspicuous places in each and every plant, factory, building, and structure where employees of the **Contractor** and its **Subcontractors** engaged in the performance of this **Contract** are employed, notices furnished by the **City**, in relation to prevailing wages and supplements, minimum wages, and other stipulations contained in Sections 220 and 220-h of the Labor Law, and the **Contractor** and its **Subcontractors** shall continue to keep such notices posted in such prominent and conspicuous places until **Final Acceptance** of the supplies, materials, equipment, or **Work**, labor, or services required to be furnished or rendered under this **Contract**.

37.6 The **Contractor** shall strictly comply with all of the provisions of Articles 37.6.1 through 37.6.5, and provide for all workers, laborers or mechanics in its employ, the following:

37.6.1 **Notices Posted At Site:** Post, in a location designated by the **City**, schedules of prevailing wages and supplements for this **Project**, a copy of all re-determinations of such schedules for the **Project**, the **Workers' Compensation Law** Section 51 notice, all other notices required by **Law** to be posted at the **Site**, the **City** notice that this **Project** is a public works project on which each worker is entitled to receive the prevailing wages and supplements for the occupation at which he or she is working, and all other notices which the **City** directs the **Contractor** to post. The **Contractor** shall provide a surface for such notices which is satisfactory to the **City**. The **Contractor** shall maintain and keep current such notices in a legible manner and shall replace any notice or schedule which is damaged, defaced, illegible or removed for any reason. The **Contractor** shall post such notices before commencing any **Work** on the **Site** and shall maintain such notices until all **Work** on the **Site** is complete; and

37.6.2 **Daily Site Sign-in Sheets:** Maintain daily **Site** sign-in sheets, and require that **Subcontractors** maintain daily **Site** sign-in sheets for its employees, which include blank spaces for an employee's name to be both printed and signed, job title, date started and Social Security number, the time the employee began work and the time the employee left work, until **Final Acceptance** of the supplies, materials, equipment, or **Work**, labor, or services to be furnished or rendered under this **Contract** unless exception is granted by the **Comptroller** upon application by the **Agency**. In the alternative, subject to the approval of the **CCPO**, the **Contractor** and **Subcontractor** may maintain an electronic or biometric sign-in system, which provides the information required by this Article 37.6.2; and

37.6.3 **Individual Employee Information Notices:** Distribute a notice to each worker, laborer or mechanic employed under this **Contract**, in a form provided by the **Agency**, that this **Project** is a public works project on which each worker, laborer or mechanic is entitled to receive the prevailing rate of wages and supplements for the occupation at which he or she is working. If the total cost of the **Work** under this **Contract** is at least two hundred fifty thousand (\$250,000) dollars, such notice shall also include a statement that each worker, laborer or mechanic must be certified prior to performing any **Work** as having successfully completed a course in construction safety and health approved by the United States Department of Labor's Occupational Safety and Health Administration that is at least ten (10) hours in duration. Such notice shall be distributed to each worker before he or she starts performing any **Work** of this **Contract** and with the first paycheck after July first of each year. "Worker, laborer or mechanic" includes employees of the **Contractor** and all **Subcontractors** and all employees of suppliers entering the **Site**. At the time of distribution, the **Contractor** shall have each worker, laborer or mechanic sign a statement, in a form provided by the **Agency**, certifying that the worker has received the notice required by this



Article 37.6.3, which signed statement shall be maintained with the payroll records required by this Contract; and

37.6.3(a) The Contractor and each Subcontractor shall notify each worker, laborer or mechanic employed under this Contract in writing of the prevailing rate of wages for their particular job classification. Such notification shall be given to every worker, laborer, and mechanic on their first pay stub and with every pay stub thereafter; and

37.6.4 Site Laminated Identification Badges: The Contractor shall provide laminated identification badges which include a photograph of the worker's, laborer's or mechanic's face and indicate the worker's, laborer's or mechanic's name, trade, employer's name, and employment starting date (month/day/year). Further, the Contractor shall require as a condition of employment on the Site, that each and every worker, laborer or mechanic wear the laminated identification badge at all times and that it may be seen by any representative of the City. The Commissioner may grant a written waiver from the requirement that the laminated identification badge include a photograph if the Contractor demonstrates that the identity of an individual wearing a laminated identification badge can be easily verified by another method; and

37.6.5 Language Other Than English Used On Site: Provide the ACCO notice when three (3) or more employees (worker and/or laborer and/or mechanic) on the Site, at any time, speak a language other than English. The ACCO will then provide the Contractor the notices described in Article 37.6.1 in that language or languages as may be required. The Contractor is responsible for all distributions under this Article 37; and

37.6.6 Provision of Records: The Contractor and Subcontractor(s) shall produce within five (5) Days on the Site of the Work and upon a written order of the Engineer, the Commissioner, the ACCO, the Agency EAO, or the Comptroller, such records as are required to be kept by this Article 37.6; and

37.6.7 The Contractor and Subcontractor(s) shall pay employees by check or direct deposit. If this Contract is for an amount greater than one million (\$1,000,000) dollars, checks issued by the Contractor to covered employees shall be generated by a payroll service or automated payroll system (an in-house system may be used if approved by the Agency). For any subcontract for an amount greater than seven hundred fifty thousand (\$750,000) dollars, checks issued by a Subcontractor to covered employees shall be generated by a payroll service or automated payroll system (an in-house system may be used if approved by the Agency); and

37.6.8 The failure of the Contractor or Subcontractor(s) to comply with the provisions of Articles 37.6.1 through 37.6.7 may result in the Commissioner declaring the Contractor in default and/or the withholding of payments otherwise due under the Contract.

37.7 The Contractor and its Subcontractors shall keep such employment and payroll records as are required by Section 220 of the Labor Law. The failure of the Contractor or Subcontractor(s) to comply with the provisions of this Article 37.7 may result in the Commissioner declaring the Contractor in default and/or the withholding of payments otherwise due under the Contract.

37.8 At the time the Contractor makes application for each partial payment and for final payment, the Contractor shall submit to the Commissioner a written payroll certification, in the form provided by this Contract, of compliance with the prevailing wage, minimum wage, and other provisions and stipulations required by Labor Law Section 220 and of compliance with the training requirements of

Labor Law Section 220-h set forth in Article 35.2. This certification of compliance shall be a condition precedent to payment and no payment shall be made to the Contractor unless and until each such certification shall have been submitted to and received by the Commissioner.

37.9 This Contract is executed by the Contractor with the express warranty and representation that the Contractor is not disqualified under the provisions of Section 220 of the Labor Law from the award of the Contract.

37.10 Any breach or violation of any of the foregoing shall be deemed a breach or violation of a material provision of this Contract, and grounds for cancellation thereof by the City.

#### ARTICLE 38. PAYROLL REPORTS

38.1 The Contractor and its Subcontractor(s) shall maintain on the Site during the performance of the Work the original payrolls or transcripts thereof which the Contractor and its Subcontractor(s) are required to maintain and shall submit such original payrolls or transcripts, subscribed and affirmed by it as true, within thirty (30) Days after issuance of its first payroll, and every thirty (30) Days thereafter, pursuant to Labor Law Section 220(3-a)(a)(iii). The Contractor and Subcontractor(s) shall submit such original payrolls or transcripts along with each and every payment requisition. If payment requisitions are not submitted at least once a month, the Contractor and its Subcontractor(s) shall submit original payrolls and transcripts both along with its payment requisitions and independently of its payment requisitions.

38.2 The Contractor shall maintain payrolls or transcripts thereof for six (6) years from the date of completion of the Work on this Contract. If such payrolls and transcripts are maintained outside of New York City after the completion of the Work and their production is required pursuant to this Article 38, the Contractor shall produce such records in New York City upon request by the City.

38.3 The Contractor and Subcontractor(s) shall comply with any written order, direction, or request made by the Engineer, the Commissioner, the ACCO, the Agency EAO, the Agency Labor Law Investigator(s), or the Comptroller, to provide to the requesting party any of the following information and/or records within five (5) Days of such written order, direction, or request:

38.3.1 Such original payrolls or transcripts thereof subscribed and affirmed by it as true and the statements signed by each worker pursuant to this Chapter VIII; and/or

38.3.2 Attendance sheets for each Day on which any employee of the Contractor and/or any of the Subcontractor(s) performed Work on the Site, which attendance sheet shall be in a form acceptable to the Agency and shall provide information acceptable to the Agency to identify each such employee; and/or

38.3.3 Any other information to satisfy the Engineer, the Commissioner, the ACCO, the Agency EAO, the Agency Labor Law Investigator(s) or the Comptroller, that this Chapter VIII and the Labor Law, as to the hours of employment and prevailing rates of wages and/or supplemental benefits, are being observed.

38.4 The failure of the Contractor or Subcontractor(s) to comply with the provisions of Articles 38.1 and/or 38.2 may result in the Commissioner declaring the Contractor in default and/or the withholding of payments otherwise due under the Contract.

### ARTICLE 39. DUST HAZARDS

39.1 Should a harmful dust hazard be created in performing the **Work** of this **Contract**, for the elimination of which appliances or methods have been approved by the Board of Standards and Appeals of the City of New York, such appliances and methods shall be installed, maintained, and effectively operated during the continuance of such harmful dust hazard. Failure to comply with this provision after notice shall make this **Contract** voidable at the sole discretion of the City.

## CHAPTER IX PARTIAL AND FINAL PAYMENTS

### ARTICLE 40. CONTRACT PRICE

40.1 The City shall pay, and the **Contractor** agrees to accept, in full consideration for the **Contractor's** performance of the **Work** subject to the terms and conditions hereof, the lump sum price or unit prices for which this **Contract** was awarded, plus the amount required to be paid for any **Extra Work** ordered by the **Commissioner** under Article 25, less credit for any **Work** omitted pursuant to Article 29.

### ARTICLE 41. BID BREAKDOWN ON LUMP SUM

41.1 Within fifteen (15) **Days** after the commencement date specified in the **Notice to Proceed** or **Order to Work**, unless otherwise directed by the **Resident Engineer**, the **Contractor** shall submit to the **Resident Engineer** a breakdown of its bid price, or of lump sums bid for items of the **Contract**, showing the various operations to be performed under the **Contract**, as directed in the progress schedule required under Article 9, and the value of each of such operations, the total of such items to equal the lump sum price bid. Said breakdown must be approved in writing by the **Resident Engineer**.

41.2 No partial payment will be approved until the **Contractor** submits a bid breakdown that is acceptable to the **Resident Engineer**.

41.3 The **Contractor** shall also submit such other information relating to the bid breakdown as directed by the **Resident Engineer**. Thereafter, the breakdown may be used only for checking the **Contractor's** applications for partial payments hereunder, but shall not be binding upon the City, the **Commissioner**, or the **Engineer** for any purpose whatsoever.

### ARTICLE 42. PARTIAL PAYMENTS

42.1 From time to time as the **Work** progresses satisfactorily, but not more often than once each calendar month (except where the **Commissioner** approves in writing the submission of invoices on a more frequent basis and for invoices relating to **Work** performed pursuant to a change order), the **Contractor** may submit to the **Engineer** a requisition for a partial payment in the prescribed form, which shall contain an estimate of the quantity and the fair value of the **Work** done during the payment period.

42.2 Partial payments may be made for materials, fixtures, and equipment in advance of their actual incorporation in the **Work**, as the **Commissioner** may approve, and upon the terms and conditions set forth in the General Conditions.

42.3 The **Contractor** shall also submit to the **Commissioner** in connection with every application for partial payment a verified statement in the form prescribed by the **Comptroller** setting forth the information required under Labor Law Section 220-a.

42.4 Within thirty (30) **Days** after receipt of a satisfactory payment application, and within sixty (60) **Days** after receipt of a satisfactory payment application in relation to **Work** performed pursuant to a change order, the **Engineer** will prepare and certify, and the **Commissioner** will approve, a voucher for a partial payment in the amount of such approved estimate, less any and all deductions authorized to be made by the **Commissioner** under the terms of this **Contract** or by **Law**.

#### **ARTICLE 43. PROMPT PAYMENT**

43.1 The Prompt Payment provisions of the **PPB Rules** in effect at the time of the bid will be applicable to payments made under this **Contract**. The provisions require the payment to the **Contractor** of interest on payments made after the required payment date, except as set forth in the **PPB Rules**.

43.2 The **Contractor** shall submit a proper invoice to receive payment, except where the **Contract** provides that the **Contractor** will be paid at predetermined intervals without having to submit an invoice for each scheduled payment.

43.3 Determination of interest due will be made in accordance with the **PPB Rules**.

43.4 If the **Contractor** is paid interest, the proportionate share(s) of that interest shall be forwarded by the **Contractor** to its **Subcontractor(s)**.

43.5 The **Contractor** shall pay each **Subcontractor** or **Materialman** not later than seven (7) **Days** after receipt of payment out of amounts paid to the **Contractor** by the **City** for **Work** performed by the **Subcontractor** or **Materialman** under this **Contract**.

43.5.1 If **Contractor** fails to make any payment to any **Subcontractor** or **Materialman** within seven (7) **Days** after receipt of payment by the **City** pursuant to this Article 43.5, then the **Contractor** shall pay interest on amounts due to such **Subcontractor** or **Materialman** at the rate of interest in effect on the date such payment is made by the **Contractor** computed in accordance with Section 756-b (1)(b) of the New York General Business Law. Accrual of interest shall commence on the **Day** immediately following the expiration of the seventh **Day** following receipt of payment by the **Contractor** from the **City** and shall end on the date on which payment is made.

43.6 The **Contractor** shall include in each of its subcontracts a provision requiring each **Subcontractor** to make payment to each of its **Subcontractors** or **Materialmen** for **Work** performed under this **Contract** in the same manner and within the same time period set forth above.

#### **ARTICLE 44. SUBSTANTIAL COMPLETION PAYMENT**

44.1 The **Contractor** shall submit with the **Substantial Completion** requisition:

44.1.1 A final verified statement of any pending Article 27 disputes in accordance with the **PPB Rules** and this **Contract** and any and all alleged claims against the **City**, in any way connected with or arising out of this **Contract** (including those as to which details may have been furnished pursuant to Articles 11, 27, 28, and 30) setting forth with respect to each

such claim the total amount thereof, the various items of labor and materials included therein, and the alleged value of each item; and if the alleged claim be one for delay, the alleged cause of each such delay, the period or periods of time, giving the dates when the Contractor claims the performance of the Work or a particular part thereof was delayed, and an itemized statement and breakdown of the amount claimed for each such delay.

44.1.1(a) With respect to each such claim, the Commissioner, the Comptroller and, in the event of litigation, the City Corporation Counsel shall have the same right to inspect, and to make extracts or copies of, the Contractor's books, vouchers, records, etc., as is referred to in Articles 11, 27, 28, and 30. Nothing contained in this Article 44.1.1(a) is intended to or shall relieve the Contractor from the obligation of complying strictly with Articles 11, 27, 28, and 30. The Contractor is warned that unless such claims are completely set forth as herein required, the Contractor upon acceptance of the Substantial Completion payment pursuant to this Article 44, will have waived any such claims.

44.1.2 A Final Approved Punch List.

44.1.3 Where required, a request for an extension of time to achieve Substantial Completion or final extension of time.

44.2 The Commissioner shall issue a voucher calling for payment of any part or all of the balance due for Work performed under the Contract, including monies retained under Article 21, less any and all deductions authorized to be made by the Commissioner, under this Contract or by Law, and less twice the amount the Commissioner considers necessary to ensure the completion of the balance of the Work by the Contractor. Such a payment shall be considered a partial and not a final payment. No Substantial Completion payment shall be made under this Article 44 where the Contractor failed to complete the Work within the time fixed for such completion in the Schedule A of the General Conditions, or within the time to which completion may have been extended, until an extension or extensions of time for the completion of Work have been acted upon pursuant to Article 13.

44.3 No further partial payments shall be made to the Contractor after Substantial Completion, except the Substantial Completion payment and payment pursuant to any Contractor's requisition that were properly filed with the Commissioner prior to the date of Substantial Completion; however, the Commissioner may grant a waiver for further partial payments after the date of Substantial Completion to permit payments for change order Work and/or release of retainage and deposits pursuant to Articles 21 and 24. Such waiver shall be in writing.

44.4 The Contractor acknowledges that nothing contained in this Article 44 is intended to or shall in any way diminish the force and effect of Article 13.

#### ARTICLE 45. FINAL PAYMENT

45.1 After completion and Final Acceptance of the Work, the Contractor shall submit all required certificates and documents, together with a requisition for the balance claimed to be due under the Contract, less the amount authorized to be retained for maintenance under Article 24. Such submission shall be within 90 days of the date of the Commissioner's written determination of Final Acceptance, or within such additional time as may be granted by the Commissioner in writing. If the Contractor fails to submit all required certificates and documents within the time allowed, no payment of the balance claimed shall be made to the Contractor and the Contractor shall be deemed to have forfeited its right to

payment of any balance claimed. A verified statement similar to that required in connection with applications for partial payments shall also be submitted to the **Commissioner**.

45.2 Amended Verified Statement of Claims: The **Contractor** shall also submit with the final requisition any amendments to the final verified statement of any pending dispute resolution procedures in accordance with the **PPB Rules** and this **Contract** and any and all alleged claims against the **City**, in any way connected with or arising out of this **Contract** (including those as to which details may have been furnished pursuant to Articles 11, 27, 28, and 30) that have occurred subsequent to **Substantial Completion**, setting forth with respect to each such claim the total amount thereof, the various items of labor and materials included therein, and the alleged value of each such item; and if the alleged claim be one for delay, the alleged cause of each such delay, the period or periods of time, giving the dates when the **Contractor** claims the performance of the **Work** or a particular part thereof was delayed, and an itemized statement and breakdown of the amount claimed for each such delay. With reference to each such claim, the **Commissioner**, the **Comptroller** and, in the event of litigation, the **City Corporation Counsel** shall have the same right to inspect, and to make extracts or copies of, the **Contractor's** books, vouchers, records, etc., as is referred to in Articles 11, 27, 28, and 30. Nothing contained in this Article 45.2, is intended to or shall relieve the **Contractor** from the obligation of complying strictly with Articles 11, 27, 28, and 30. The **Contractor** is warned that unless such claims are completely set forth as herein required, the **Contractor**, upon acceptance of the Final Payment pursuant to Article 46, will have waived any such claims.

45.3 Preparation of Final Voucher: Upon determining the balance due hereunder other than on account of claims, the **Engineer** will prepare and certify, for the **Commissioner's** approval, a voucher for final payment in that amount less any and all deductions authorized to be made by the **Commissioner** under this **Contract** or by **Law**. In the case of a lump sum **Contract**, the **Commissioner** shall certify the voucher for final payment within thirty (30) **Days** from the date of completion and acceptance of the **Work**, provided all requests for extensions of time have been acted upon.

45.3.1 All prior certificates and vouchers upon which partial payments were made, being merely estimates made to enable the **Contractor** to prosecute the **Work** more advantageously, shall be subject to correction in the final voucher, and the certification of the **Engineer** thereon and the approval of the **Commissioner** thereof, shall be conditions precedent to the right of the **Contractor** to receive any money hereunder. Such final voucher shall be binding and conclusive upon the **Contractor**.

45.3.2 Payment pursuant to such final voucher, less any deductions authorized to be made by the **Commissioner** under this **Contract** or by **Law**, shall constitute the final payment, and shall be made by the **Comptroller** within thirty (30) **Days** after the filing of such voucher in his/her office.

45.4 The **Contractor** acknowledges that nothing contained in this Article 45 is intended to or shall in any way diminish the force and effect of Article 13.

#### **ARTICLE 46. ACCEPTANCE OF FINAL PAYMENT**

46.1 The acceptance by the **Contractor**, or by anyone claiming by or through it, of the final payment, whether such payment be made pursuant to any judgment of any court, or otherwise, shall constitute and operate as a release of the **City** from any and all claims of and liability to the **Contractor** for anything heretofore done or furnished for the **Contractor** relating to or arising out of this **Contract** and the **Work** done hereunder, and for any prior act, neglect or default on the part of the **City** or any of its officials, agents or employees, excepting only a claim against the **City** for the amounts deducted or retained in accordance with the terms and provisions of this **Contract** or by **Law**, and excepting any

claims, not otherwise waived, or any pending dispute resolution procedures which are contained in the verified statement filed with the **Contractor's** substantial and final requisitions pursuant to Articles 44 and 45.

46.2 The **Contractor** is warned that the execution by it of a release, in connection with the acceptance of the final payment, containing language purporting to reserve claims other than those herein specifically excepted from the operation of this Article 46, or those for amounts deducted by the **Commissioner** from the final requisition or from the final payment as certified by the **Engineer** and approved by the **Commissioner**, shall not be effective to reserve such claims, anything stated to the **Contractor** orally or in writing by any official, agent or employee of the **City** to the contrary notwithstanding.

46.3 Should the **Contractor** refuse to accept the final payment as tendered by the **Comptroller**, it shall constitute a waiver of any right to interest thereon.

46.4 The **Contractor**, however, shall not be barred by this Article 46 from commencing an action for breach of **Contract** to the extent permitted by **Law** and by the terms of the **Contract** for any claims that are contained in the verified statement filed with the **Contractor's** substantial and final requisitions pursuant to Articles 44 and 45 or that arose after submission of the final payment requisition, provided that a detailed and verified statement of claim is served upon the contracting **Agency** and **Comptroller** not later than forty (40) **Days** after the making of such final payment by electronic funds transfer (EFT) or the mailing of such final payment. The statement shall specify the items upon which the claim will be based and any such claim shall be limited to such items.

#### **ARTICLE 47. APPROVAL BY PUBLIC DESIGN COMMISSION**

47.1 All works of art, including paintings, mural decorations, stained glass, statues, bas-reliefs, and other sculptures, monuments, fountains, arches, and other structures of a permanent character intended for ornament or commemoration, and every design of the same to be used in the performance of this **Contract**, and the design of all bridges, approaches, buildings, gates, fences, lamps, or structures to be erected, pursuant to the terms of this **Contract**, shall be submitted to the Art Commission, d/b/a the Public Design Commission of the City of New York, and shall be approved by the Public Design Commission prior to the erection or placing in position of the same. The final payment shall not become due or payable under this **Contract** unless and until the Public Design Commission shall certify that the design for the **Work** herein contracted for has been approved by the said Public Design Commission, and that the same has been executed in substantial accordance with the design so approved, pursuant to the provisions of Chapter 37, Section 854 of the **City Charter**, as amended.

### **CHAPTER X CONTRACTOR'S DEFAULT**

#### **ARTICLE 48. COMMISSIONER'S RIGHT TO DECLARE CONTRACTOR IN DEFAULT**

48.1 In addition to those instances specifically referred to in other Articles herein, the **Commissioner** shall have the right to declare the **Contractor** in default of this **Contract** if:

48.1.1 The **Contractor** fails to commence **Work** when notified to do so by the **Commissioner**; or  
if

48.1.2 The **Contractor** shall abandon the **Work**; or if

48.1.3 The **Contractor** shall refuse to proceed with the **Work** when and as directed by the **Commissioner**; or if

48.1.4 The **Contractor** shall, without just cause, reduce its working force to a number which, if maintained, would be insufficient, in the opinion of the **Commissioner**, to complete the **Work** in accordance with the progress schedule; or if

48.1.5 The **Contractor** shall fail or refuse to increase sufficiently such working force when ordered to do so by the **Commissioner**; or if

48.1.6 The **Contractor** shall sublet, assign, transfer, convert or otherwise dispose of this **Contract** other than as herein specified; or sell or assign a majority interest in the **Contractor**; or if

48.1.7 The **Contractor** fails to secure and maintain all required insurance; or if

48.1.8 A receiver or receivers are appointed to take charge of the **Contractor's** property or affairs; or if

48.1.9 The **Commissioner** shall be of the opinion that the **Contractor** is or has been unnecessarily or unreasonably or willfully delaying the performance and completion of the **Work**, or the award of necessary subcontracts, or the placing of necessary material and equipment orders; or if

48.1.10 The **Commissioner** shall be of the opinion that the **Contractor** is or has been willfully or in bad faith violating any of the provisions of this **Contract**; or if

48.1.11 The **Commissioner** shall be of the opinion that the **Work** cannot be completed within the time herein provided therefor or within the time to which such completion may have been extended; provided, however, that the impossibility of timely completion is, in the **Commissioner's** opinion, attributable to conditions within the **Contractor's** control; or if

48.1.12 The **Work** is not completed within the time herein provided therefor or within the time to which the **Contractor** may be entitled to have such completion extended; or if

48.1.13 Any statement or representation of the **Contractor** in the **Contract** or in any document submitted by the **Contractor** with respect to the **Work**, the **Project**, or the **Contract** (or for purposes of securing the **Contract**) was untrue or incorrect when made; or if

48.1.14 The **Contractor** or any of its officers, directors, partners, five (5%) percent shareholders, principals, or other persons substantially involved in its activities, commits any of the acts or omissions specified as the grounds for debarment in the **PPB Rules**.

48.2 Before the **Commissioner** shall exercise his/her right to declare the **Contractor** in default, the **Commissioner** shall give the **Contractor** an opportunity to be heard, upon not less than two (2) **Days** notice.



#### **ARTICLE 49. EXERCISE OF THE RIGHT TO DECLARE DEFAULT**

49.1 The right to declare the **Contractor** in default for any of the grounds specified or referred to in Article 48 shall be exercised by sending the **Contractor** a notice, signed by the **Commissioner**, setting forth the ground or grounds upon which such default is declared (hereinafter referred to as a "Notice of Default").

49.2 The **Commissioner's** determination that the **Contractor** is in default shall be conclusive, final, and binding on the parties and such a finding shall preclude the **Contractor** from commencing a plenary action for any damages relating to the **Contract**. If the **Contractor** protests the determination of the **Commissioner**, the **Contractor** may commence an action in a court of competent jurisdiction of the State of New York under Article 78 of the New York Civil Practice Law and Rules.

#### **ARTICLE 50. QUITTING THE SITE**

50.1 Upon receipt of such notice the **Contractor** shall immediately discontinue all further operations under this **Contract** and shall immediately quit the **Site**, leaving untouched all plant, materials, equipment, tools, and supplies then on the **Site**.

#### **ARTICLE 51. COMPLETION OF THE WORK**

51.1 The **Commissioner**, after declaring the **Contractor** in default, may then have the **Work** completed by such means and in such manner, by contract with or without public letting, or otherwise, as he/she may deem advisable, utilizing for such purpose such of the **Contractor's** plant, materials, equipment, tools, and supplies remaining on the **Site**, and also such **Subcontractors**, as he/she may deem advisable.

51.2 After such completion, the **Commissioner** shall make a certificate stating the expense incurred in such completion, which shall include the cost of re-letting and also the total amount of liquidated damages (at the rate provided for in the **Contract**) from the date when the **Work** should have been completed by the **Contractor** in accordance with the terms hereof to the date of actual completion of the **Work**. Such certificate shall be binding and conclusive upon the **Contractor**, its sureties, and any person claiming under the **Contractor**, as to the amount thereof.

51.3 The expense of such completion, including any and all related and incidental costs, as so certified by the **Commissioner**, and any liquidated damages assessed against the **Contractor**, shall be charged against and deducted out of monies which are earned by the **Contractor** prior to the date of default. Should the expense of such completion, as certified by the **Commissioner**, exceed the total sum which would have been payable under the **Contract** if it had been completed by the **Contractor**, any excess shall be paid by the **Contractor**.

#### **ARTICLE 52. PARTIAL DEFAULT**

52.1 In case the **Commissioner** shall declare the **Contractor** in default as to a part of the **Work** only, the **Contractor** shall discontinue such part, shall continue performing the remainder of the **Work** in strict conformity with the terms of this **Contract**, and shall in no way hinder or interfere with any **Other**

**Contractor(s)** or persons whom the **Commissioner** may engage to complete the **Work** as to which the **Contractor** was declared in default.

52.2 The provisions of this Chapter relating to declaring the **Contractor** in default as to the entire **Work** shall be equally applicable to a declaration of partial default, except that the **Commissioner** shall be entitled to utilize for completion of the part of the **Work** as to which the **Contractor** was declared in default only such plant, materials, equipment, tools, and supplies as had been previously used by the **Contractor** on such part.

#### **ARTICLE 53. PERFORMANCE OF UNCOMPLETED WORK**

53.1 In completing the whole or any part of the **Work** under the provisions of this Chapter X, the **Commissioner** shall have the power to depart from or change or vary the terms and provisions of this **Contract**, provided, however, that such departure, change or variation is made for the purpose of reducing the time or expense of such completion. Such departure, change or variation, even to the extent of accepting a lesser or different performance, shall not affect the conclusiveness of the **Commissioner's** certificate of the cost of completion referred to in Article 51, nor shall it constitute a defense to an action to recover the amount by which such certificate exceeds the amount which would have been payable to the **Contractor** hereunder but for its default.

#### **ARTICLE 54. OTHER REMEDIES**

54.1 In addition to the right to declare the **Contractor** in default pursuant to this Chapter X, the **Commissioner** shall have the absolute right, in his/her sole discretion and without a hearing, to complete or cause to be completed in the same manner as described in Articles 51 and 53, any or all unsatisfactory or uncompleted punch list **Work** that remains after the completion date specified in the **Final Approved Punch List**. A written notice of the exercise of this right shall be sent to the **Contractor** who shall immediately quit the **Site** in accordance with the provisions of Article 50.

54.2 The expense of completion permitted under Article 54.1, including any and all related and incidental costs, as so certified by the **Commissioner**, shall be charged against and deducted out of monies which have been earned by the **Contractor** prior to the date of the exercise of the right set forth in Article 54.1; the balance of such monies, if any, subject to the other provisions of this **Contract**, to be paid to the **Contractor** without interest after such completion. Should the expense of such completion, as certified by the **Commissioner**, exceed the total sum which would have been payable under the **Contract** if it had been completed by the **Contractor**, any excess shall be paid by the **Contractor**.

54.3 The previous provisions of this Chapter X shall be in addition to any and all other remedies available under **Law** or in equity.

54.4 The exercise by the **City** of any remedy set forth herein shall not be deemed a waiver by the **City** of any other legal or equitable remedy contained in this **Contract** or provided under **Law**.

**CHAPTER XI  
MISCELLANEOUS PROVISIONS**

**ARTICLE 55. CONTRACTOR'S WARRANTIES**

55.1 In consideration of, and to induce, the award of this **Contract** to the **Contractor**, the **Contractor** represents and warrants:

55.1.1 That it is financially solvent, sufficiently experienced and competent to perform the **Work**; and

55.1.2 That the facts stated in its bid and the information given by it pursuant to the Information for Bidders is true and correct in all respects; and

55.1.3 That it has read and complied with all requirements set forth in the **Contract**.

**ARTICLE 56. CLAIMS AND ACTIONS THEREON**

56.1 Any claim, that is not subject to dispute resolution under the **PPB Rules** or this **Contract**, against the **City** for damages for breach of **Contract** shall not be made or asserted in any action, unless the **Contractor** shall have strictly complied with all requirements relating to the giving of notice and of information with respect to such claims, as herein before provided.

56.2 Nor shall any action be instituted or maintained on any such claims unless such action is commenced within six (6) months after **Substantial Completion**; except that:

56.2.1 Any claims arising out of events occurring after **Substantial Completion** and before **Final Acceptance** of the **Work** shall be asserted within six (6) months of **Final Acceptance** of the **Work**;

56.2.2 Any claims for monies deducted, retained or withheld under the provisions of this **Contract** shall be asserted within six (6) months after the date when such monies otherwise become due and payable hereunder; and

56.2.3 If the **Commissioner** exercises his/her right to terminate the **Contract** pursuant to Article 64, any such action shall be commenced within six (6) months of the date the **Commissioner** exercises said right.

**ARTICLE 57. INFRINGEMENT**

57.1 The **Contractor** shall be solely responsible for and shall defend, indemnify, and hold the **City** harmless from any and all claims (even if the allegations of the lawsuit are without merit) and judgments for damages and from costs and expenses to which the **City** may be subject to or which it may suffer or incur allegedly arising out of or in connection with any infringement by the **Contractor** of any copyright, trade secrets, trademark or patent rights or any other property or personal right of any third party by the **Contractor** and/or its **Subcontractors** in the performance or completion of the **Work**. Insofar as the facts or **Law** relating to any claim would preclude the **City** from being completely indemnified by the **Contractor**, the **City** shall be partially indemnified by the **Contractor** to the fullest extent permitted by **Law**.

**ARTICLE 58. NO CLAIM AGAINST OFFICIALS, AGENTS OR EMPLOYEES**

58.1 No claim whatsoever shall be made by the Contractor against any official, agent or employee of the City for, or on account of, anything done or omitted to be done in connection with this Contract.

**ARTICLE 59. SERVICE OF NOTICES**

59.1 The Contractor hereby designates the business address, fax number, and email address specified in its bid, as the place where all notices, directions or other communications to the Contractor may be delivered, or to which they may be mailed. Any notice, direction, or communication from either party to the other shall be in writing and shall be deemed to have been given when (i) delivered personally; (ii) sent by certified mail, return receipt requested; (iii) delivered by overnight or same day courier service in a properly addressed envelope with confirmation; or (iv) sent by fax or email and, unless receipt of the fax or e-mail is acknowledged by the recipient by fax or e-mail, deposited in a post office box regularly maintained by the United States Postal Service in a properly addressed, postage pre-paid envelope.

59.2 Contractor's notice address, email address, or fax number may be changed at any time by an instrument in writing, executed and acknowledged by the Contractor, and delivered to the Commissioner.

59.3 Nothing herein contained shall, however, be deemed to preclude or render inoperative the service of any notice, direction or other communication upon the Contractor personally, or, if the Contractor is a corporation, upon any officer thereof.

**ARTICLE 60. UNLAWFUL PROVISIONS DEEMED STRICKEN FROM CONTRACT**

60.1 If this Contract contains any unlawful provision not an essential part of the Contract and which shall not appear to have been a controlling or material inducement to the making thereof, the same shall be deemed of no effect and shall, upon notice by either party, be deemed stricken from the Contract without affecting the binding force of the remainder.

**ARTICLE 61. ALL LEGAL PROVISIONS DEEMED INCLUDED**

61.1 It is the intent and understanding of the parties to this Contract that each and every provision of Law required to be inserted in this Contract shall be and is inserted herein. Furthermore, it is hereby stipulated that every such provision is to be deemed to be inserted herein, and if, through mistake or otherwise, any such provision is not inserted, or is not inserted in correct form, then this Contract shall forthwith upon the application of either party be amended by such insertion so as to comply strictly with the Law and without prejudice to the rights of either party hereunder.

**ARTICLE 62. TAX EXEMPTION**

62.1 The City is exempt from payment of Federal, State, and local taxes, including sales and compensating use taxes of the State of New York and its cities and counties on all tangible personal property sold to the City pursuant to the provisions of this Contract. These taxes are not to be included in bids. However, this exemption does not apply to tools, machinery, equipment or other property leased by or to the Contractor, Subcontractor or Materialman or to tangible personal property which, even

though it is consumed, is not incorporated into the completed **Work** (consumable supplies) and tangible personal property that the **Contractor** is required to remove from the **Site** during or upon completion of the **Work**. The **Contractor** and its **Subcontractors** and **Materialmen** shall be responsible for and pay any and all applicable taxes, including sales and compensating use taxes, on such leased tools, machinery, equipment or other property and upon all such consumable supplies and tangible personal property that the **Contractor** is required to remove from the **Site** during or upon completion of the **Work**.

62.2 The **Contractor** agrees to sell and the **City** agrees to purchase all tangible personal property, other than consumable supplies and other tangible personal property that the **Contractor** is required to remove from the **Site** during or upon completion of the **Work**, that is required, necessary or proper for or incidental to the construction of the **Project** covered by this **Contract**. The sum paid under this **Contract** for such tangible personal property shall be in full payment and consideration for the sale of such tangible personal property.

62.2.1 The **Contractor** agrees to construct the **Project** and to perform all **Work**, labor and services rendered, necessary, proper or incidental thereto for the sum shown in the bid for the performance of such **Work**, labor, and services, and the sum so paid pursuant to this **Contract** for such **Work**, labor, and services, shall be in full consideration for the performance by the **Contractor** of all its duties and obligations under this **Contract** in connection with said **Work**, labor, and services.

62.3 20 NYCRR Section 541.3(d) provides that a **Contractor's** purchases of tangible personal property that is either incorporated into real property owned by a governmental entity or purchased for and sold to a governmental entity are exempt from sales and use tax. The **City** shall not pay sales tax for any such tangible personal property that it purchases from the **Contractor** pursuant to the **Contract**. With respect to such tangible personal property, the **Contractor**, at the request of the **City**, shall furnish to the **City** such bills of sale and other instruments as may be required by the **City**, properly executed, acknowledged and delivered assuring to the **City** title to such tangible personal property, free of liens and/or encumbrances, and the **Contractor** shall mark or otherwise identify all such tangible personal property as the property of the **City**.

62.4 Title to all tangible personal property to be sold by the **Contractor** to the **City** pursuant to the provisions of the **Contract** shall immediately vest in and become the sole property of the **City** upon delivery of such tangible personal property to the **Site**. Notwithstanding such transfer of title, the **Contractor** shall have the full and continuing responsibility to install such tangible personal property in accordance with the provisions of this **Contract**, protect it, maintain it in a proper condition and forthwith repair, replace and make good any damage thereto, theft or disappearance thereof, and furnish additional tangible personal property in place of any that may be lost, stolen or rendered unusable, without cost to the **City**, until such time as the **Work** covered by the **Contract** is fully accepted by the **City**. Such transfer of title shall in no way affect any of the **Contractor's** obligations hereunder. In the event that, after title has passed to the **City**, any of the tangible personal property is rejected as being defective or otherwise unsatisfactory, title to all such tangible personal property shall be deemed to have been transferred back to the **Contractor**.

62.5 The purchase by **Subcontractors** or **Materialmen** of tangible personal property to be sold hereunder shall be a purchase or procurement for resale to the **Contractor** (either directly or through other **Subcontractors**) and therefore not subject to the aforesaid sales and compensating use taxes, provided that the subcontracts and purchase agreements provide for the resale of such tangible personal property and that such subcontracts and purchase agreements are in a form similar to this **Contract** with respect to the separation of the sale of consumable supplies and tangible personal property that the **Contractor** is required to remove from the **Site** during or upon completion of the **Work** from the **Work** and labor, services, and any other matters to be provided, and provided further that the subcontracts and

purchase agreements provide separate prices for tangible personal property and all other services and matters. Such separation shall actually be followed in practice, including the separation of payments for tangible personal property from the payments for other Work and labor and other things to be provided.

62.6 The Contractor and its Subcontractors and Materialmen shall furnish a Contractor Exempt Purchase Certificate to all persons, firms or corporations from which they purchase tangible personal property for the performance of the Work covered by this Contract.

62.7 In the event any of the provisions of this Article 62 shall be deemed to be in conflict with any other provisions of this Contract or create any ambiguity, then the provisions of this Article 62 shall control.

### ARTICLE 63. INVESTIGATION(S) CLAUSE

63.1 The parties to this Contract agree to cooperate fully and faithfully with any investigation, audit or inquiry conducted by a United States, a State of New York (State) or a City governmental agency or authority that is empowered directly or by designation to compel the attendance of witnesses and to examine witnesses under oath, or conducted by the Inspector General of a governmental agency that is a party in interest to the transaction, submitted bid, submitted proposal, contract, lease, permit or license that is the subject of the investigation, audit or inquiry.

63.2 If any person who has been advised that his/her statement, and any information from such statement, will not be used against him/her in any subsequent criminal proceeding refuses to testify before a grand jury or other governmental agency or authority empowered directly or by designation to compel the attendance of witnesses and to examine witnesses under oath concerning the award of or performance under any transaction, agreement, lease, permit, contract, or license entered into with the City, the State, or any political subdivision or public authority thereof, or the Port Authority of New York and New Jersey, or any local development corporation within the City, or any public benefit corporation organized under the Laws of the State of New York, or;

63.3 If any person refuses to testify for a reason other than the assertion of his/her privilege against self incrimination in an investigation, audit or inquiry conducted by a City or State governmental agency or authority empowered directly or by designation to compel the attendance of witnesses and to take testimony under oath, or by the Inspector General of the governmental agency that is a party in interest in, and is seeking testimony concerning the award of, or performance under any transaction, agreement, lease, permit, contract, or license entered into with the City, the State, or any political subdivision thereof or any local development corporation within the City, then;

63.4 The Commissioner whose Agency is a party in interest to the transaction, submitted bid, submitted proposal, contract, lease, permit, or license shall convene a hearing, upon not less than five (5) Days' written notice to the parties involved to determine if any penalties should attach for the failure of a person to testify.

63.5 If any non-governmental party to the hearing requests an adjournment, the Commissioner who convened the hearing may, upon granting the adjournment, suspend any contract, lease, permit, or license, pending the final determination pursuant to Article 63.7 without the City incurring any penalty or damages for delay or otherwise.

63.6 The penalties which may attach after a final determination by the Commissioner may include but shall not exceed:

63.6.1 The disqualification for a period not to exceed five (5) years from the date of an adverse determination for any person, or any entity of which such person was a member at the time the testimony was sought, from submitting bids for, or transacting business with, or entering into or obtaining any contract, lease, permit or license with or from the City; and/or

63.6.2 The cancellation or termination of any and all such existing City contracts, leases, permits or licenses that the refusal to testify concerns and that have not been assigned as permitted under this Contract, nor the proceeds of which pledged, to an unaffiliated and unrelated institutional lender for fair value prior to the issuance of the notice scheduling the hearing, without the City incurring any penalty or damages on account of such cancellation or termination; monies lawfully due for goods delivered, work done, rentals, or fees accrued prior to the cancellation or termination shall be paid by the City.

63.7 The Commissioner shall consider and address in reaching his/her determination and in assessing an appropriate penalty the factors in Articles 63.7.1 and 63.7.2. The Commissioner may also consider, if relevant and appropriate, the criteria established in Articles 63.7.3 and 63.7.4, in addition to any other information which may be relevant and appropriate:

63.7.1 The party's good faith endeavors or lack thereof to cooperate fully and faithfully with any governmental investigation or audit, including but not limited to the discipline, discharge, or disassociation of any person failing to testify, the production of accurate and complete books and records, and the forthcoming testimony of all other members, agents, assignees or fiduciaries whose testimony is sought.

63.7.2 The relationship of the person who refused to testify to any entity that is a party to the hearing, including but not limited to, whether the person whose testimony is sought has an ownership interest in the entity and/or the degree of authority and responsibility the person has within the entity.

63.7.3 The nexus of the testimony sought to the subject entity and its contracts, leases, permits or licenses with the City.

63.7.4 The effect a penalty may have on an unaffiliated and unrelated party or entity that has a significant interest in an entity subject to penalties under Article 63.6, provided that the party or entity has given actual notice to the Commissioner upon the acquisition of the interest, or at the hearing called for in Article 63.4, gives notice and proves that such interest was previously acquired. Under either circumstance the party or entity shall present evidence at the hearing demonstrating the potential adverse impact a penalty will have on such person or entity.

#### 63.8 Definitions:

63.8.1 The term "license" or "permit" as used in this Article 63 shall be defined as a license, permit, franchise or concession not granted as a matter of right.

63.8.2 The term "person" as used in this Article 63 shall be defined as any natural person doing business alone or associated with another person or entity as a partner, director, officer, principal or employee.

63.8.3 The term "entity" as used in this Article 63 shall be defined as any firm, partnership, corporation, association, joint venture, or person that receives monies, benefits, licenses, leases, or permits from or through the City or otherwise transacts business with the City.

63.8.4 The term "member" as used in this Article 63 shall be defined as any person associated with another person or entity as a partner, director, officer, principal or employee.

63.9 In addition to and notwithstanding any other provision of this **Contract**, the **Commissioner** may in his/her sole discretion terminate this **Contract** upon not less than three (3) **Days**' written notice in the event the **Contractor** fails to promptly report in writing to the **Commissioner** of the Department of Investigations ("DOI") of the City any solicitation of money, goods, requests for future employment or other benefit or thing of value, by or on behalf of any employee of the City or other person, firm, corporation or entity for any purpose which may be related to the procurement or obtaining of this **Contract** by the **Contractor**, or affecting the performance of this **Contract**.

#### **ARTICLE 64. TERMINATION BY THE CITY**

64.1 In addition to termination pursuant to any other article of this **Contract**, the **Commissioner** may, at any time, terminate this **Contract** by written notice to the **Contractor**. In the event of termination, the **Contractor** shall, upon receipt of such notice, unless otherwise directed by the **Commissioner**:

64.1.1 Stop **Work** on the date specified in the notice;

64.1.2 Take such action as may be necessary for the protection and preservation of the City's materials and property;

64.1.3 Cancel all cancelable orders for material and equipment;

64.1.4 Assign to the City and deliver to the Site or another location designated by the **Commissioner**, any non-cancelable orders for material and equipment that is not capable of use except in the performance of this **Contract** and has been specifically fabricated for the sole purpose of this **Contract** and not incorporated in the **Work**;

64.1.5 Take no action which will increase the amounts payable by the City under this **Contract**.

64.2 In the event of termination by the City pursuant to this Article 64, payment to the **Contractor** shall be in accordance with Articles 64.2.1, 64.2.2 or 64.2.3, to the extent that each respective article applies.

64.2.1 Lump Sum Contracts or Items: On all lump sum **Contracts**, or on lump sum items in a **Contract**, the City will pay the **Contractor** the sum of the amounts described in Articles 64.2.1(a) and 64.2.1(b), less all payments previously made pursuant to this **Contract**. On lump sum **Contracts** only, the City will also pay the **Contractor** an additional sum as provided in Article 64.2.1(c).

64.2.1(a) For **Work** completed prior to the notice of termination, the **Contractor** shall be paid a pro rata portion of the lump sum bid amount, plus approved change orders, based upon the percent completion of the **Work**, as determined by the **Commissioner**. For the purpose of determining the pro rata portion of the lump sum bid amount to which the **Contractor** is entitled, the bid breakdown submitted in accordance with Article 41 shall be considered, but shall not be dispositive. The **Commissioner's** determination hereunder shall be final, binding, and conclusive.



64.2.1(b) For non-cancelable material and equipment that is not capable of use except in the performance of this **Contract** and has been specifically fabricated for the sole purpose of this **Contract**, but not yet incorporated in the **Work**, the **Contractor** shall be paid the lesser of the following, less salvage value:

64.2.1(b)(i) The Direct Cost, as defined in Article 64.2.4; or

64.2.1(b)(ii) The fair and reasonable value, if less than Direct Cost, of such material and equipment, plus necessary and reasonable delivery costs.

64.2.1(b)(iii) In addition, the **Contractor** shall be paid five (5%) percent of the amount described in Article 64.2.1(b)(i) or Article 64.2.1(b)(ii), whichever applies.

64.2.1(c) Except as otherwise provided in Article 64.2.1(d), on all lump sum **Contracts**, the **Contractor** shall be paid the percentage indicated below applied to the difference between the total lump sum bid amount and the total of all payments made prior to the notice of termination plus all payments allowed pursuant to Articles 64.2.1(a) and 64.2.1(b):

64.2.1(c)(i) Five (5%) percent of the first five million (\$5,000,000) dollars; and

64.2.1(c)(ii) Three (3%) percent of any amount between five million (\$5,000,000) dollars and fifteen million (\$15,000,000) dollars; plus

64.2.1(c)(iii) One (1%) percent of any amount over fifteen million (\$15,000,000) dollars.

64.2.1(d) In the event the **City** terminates a lump sum **Contract** pursuant to this Article 64 within ninety (90) **Days** after registration of the **Contract** with the **Comptroller**, the **Contractor** shall be paid one (1%) percent of the difference between the lump sum bid amount and the total of all payments made pursuant to this Article 64.2.

64.2.2 Unit Price Contracts or Items: On all unit price **Contracts**, or on unit price items in a **Contract**, the **City** will pay the **Contractor** the sum of the amounts described in Articles 64.2.2(a) and 64.2.2(b), less all payments previously made pursuant to this **Contract**:

64.2.2(a) For all completed units, the unit price stated in the **Contract**, and

64.2.2(b) For units that have been ordered but are only partially completed, the **Contractor** will be paid:

64.2.2(b)(i) A pro rata portion of the unit price stated in the **Contract** based upon the percent completion of the unit and

64.2.2(b)(ii) For non-cancelable material and equipment, payment will be made pursuant to Article 64.2.1(b).

64.2.3 Time and Materials Contracts or Items Based on Time and Material Records: On all **Contracts** or items in a **Contract** where payment for the **Work** is based on time and

material records, the **Contractor** shall be paid in accordance with Article 26, less all payments previously made pursuant to this **Contract**.

64.2.4 Direct Costs: Direct Costs as used in this Article 64.2 shall mean:

64.2.4(a) The actual purchase price of material and equipment, plus necessary and reasonable delivery costs,

64.2.4(b) The actual cost of labor involved in construction and installation at the Site, and

64.2.4(c) The actual cost of necessary bonds and insurance purchased pursuant to requirements of this **Contract** less any amounts that have been or should be refunded by the **Contractor's** sureties or insurance carriers.

64.2.4(d) Direct Costs shall not include overhead.

64.3 In no event shall any payments under this Article 64 exceed the **Contract** price for such items.

64.4 All payments pursuant to Article 64 shall be in the nature of liquidated damages and shall be accepted by the **Contractor** in full satisfaction of all claims against the **City**.

64.5 The **City** may deduct or set off against any sums due and payable pursuant to this Article 64, any deductions authorized by this **Contract** or by **Law** (including but not limited to liquidated damages) and any claims it may have against the **Contractor**. The **City's** exercise of the right to terminate the **Contract** pursuant to this Article 64 shall not impair or otherwise effect the **City's** right to assert any claims it may have against the **Contractor** in a plenary action.

64.6 Where the **Work** covered by the **Contract** has been substantially completed, as determined in writing by the **Commissioner**, termination of the **Work** shall be handled as an omission of **Work** pursuant to Articles 29 and 33, in which case a change order will be issued to reflect an appropriate reduction in the **Contract** sum, or if the amount is determined after final payment, such amount shall be paid by the **Contractor**.

#### **ARTICLE 65. CHOICE OF LAW, CONSENT TO JURISDICTION AND VENUE**

65.1 This **Contract** shall be deemed to be executed in the **City** regardless of the domicile of the **Contractor**, and shall be governed by and construed in accordance with the **Laws** of the State of New York and the **Laws** of the United States, where applicable.

65.2 The parties agree that any and all claims asserted against the **City** arising under this **Contract** or related thereto shall be heard and determined in the courts of the State of New York ("New York State Courts") located in the **City** and County of New York. To effect this **Contract** and intent, the **Contractor** agrees:

65.2.1 If the **City** initiates any action against the **Contractor** in Federal court or in a New York State Court, service of process may be made on the **Contractor** either in person, wherever such **Contractor** may be found, or by registered mail addressed to the **Contractor** at its address as set forth in this **Contract**, or to such other address as the **Contractor** may provide to the **City** in writing; and

65.2.2 With respect to any action between the **City** and the **Contractor** in a New York State Court, the **Contractor** hereby expressly waives and relinquishes any rights it might otherwise have:

65.2.2(a) To move to dismiss on grounds of forum non conveniens;

65.2.2(b) To remove to Federal Court; and

65.2.2(c) To move for a change of venue to a New York State Court outside New York County.

65.2.3 With respect to any action brought by the **City** against the **Contractor** in a Federal Court located in the **City**, the **Contractor** expressly waives and relinquishes any right it might otherwise have to move to transfer the action to a Federal Court outside the **City**.

65.2.4 If the **Contractor** commences any action against the **City** in a court located other than in the **City** and County of New York, upon request of the **City**, the **Contractor** shall either consent to a transfer of the action to a New York State Court of competent jurisdiction located in the **City** and County of New York or, if the Court where the action is initially brought will not or cannot transfer the action, the **Contractor** shall consent to dismiss such action without prejudice and may thereafter reinstate the action in a New York State Court of competent jurisdiction in New York County.

65.3 If any provision(s) of this Article 65 is held unenforceable for any reason, each and all other provision(s) shall nevertheless remain in full force and effect.

#### **ARTICLE 66. PARTICIPATION IN AN INTERNATIONAL BOYCOTT**

66.1 The **Contractor** agrees that neither the **Contractor** nor any substantially owned affiliated company is participating or shall participate in an international boycott in violation of the provisions of the Federal Export Administration Act of 1979, as amended, or the regulations of the United States Department of Commerce (Commerce Department) promulgated thereunder.

66.2 Upon the final determination by the Commerce Department or any other agency of the United States as to, or conviction of the **Contractor** or a substantially-owned affiliated company thereof for participation in an international boycott in violation of the provisions of the Export Administration Act of 1979, as amended, or the regulations promulgated thereunder, the **Comptroller** may, at his/her option, render forfeit and void this **Contract**.

66.3 The **Contractor** shall comply in all respects, with the provisions of Section 6-114 of the Administrative Code and the rules and regulations issued by the **Comptroller** thereunder.

#### **ARTICLE 67. LOCALLY BASED ENTERPRISE PROGRAM**

67.1 This **Contract** is subject to the requirements of Section 6-108.1 of the Administrative Code and regulations promulgated thereunder. No construction contract shall be awarded unless and until these requirements have been complied with in their entirety; however, compliance with this Article 67 is not required if the Agency sets Subcontractor Participation Goals for Minority- and Women-Owned Business Enterprises (M/WBEs).

67.2 Unless specifically waived by the **Commissioner** with the approval of the Division of Economic and Financial Opportunity of the City Department of Business Services, if any portion of the **Contract** is subcontracted, not less than ten (10%) percent of the total dollar amount of the **Contract** shall be awarded to locally based enterprises (LBEs); except that where less than ten (10%) percent of the total dollar amount of the **Contract** is subcontracted, such lesser percentage shall be so awarded.

67.3 The **Contractor** shall not require performance and payment bonds from LBE **Subcontractors**.

67.4 If the **Contractor** has indicated prior to award that no **Work** will be subcontracted, no **Work** shall be subcontracted without the prior approval of the **Commissioner**, which shall be granted only if the **Contractor** makes a good faith effort beginning at least six (6) weeks before the **Work** is to be performed to obtain LBE **Subcontractors** to perform the **Work**.

67.5 If the **Contractor** has not identified sufficient LBE **Subcontractors** prior to award, it shall sign a letter of compliance stating that it complies with Section 6-108.1 of the Administrative Code, recognizes that achieving the LBE requirement is a condition of its **Contract**, and shall submit documentation demonstrating its good faith efforts to obtain LBEs. After award, the **Contractor** shall begin to solicit LBE's to perform subcontracted **Work** at least six (6) weeks before the date such **Work** is to be performed and shall demonstrate that a good faith effort has been made to obtain LBEs on each subcontract until it meets the required percentage.

67.6 Failure of the **Contractor** to comply with the requirements of Section 6-108.1 of the Administrative Code and the regulations promulgated thereunder shall constitute a material breach of this **Contract**. Remedy for such breach may include the imposition of any or all of the following sanctions:

67.6.1 Reducing the **Contractor's** compensation by an amount equal to the dollar value of the percentage of the LBE subcontracting requirement not complied with;

67.6.2 Declaring the **Contractor** in default;

67.6.3 If the **Contractor** is an LBE, de-certifying and declaring the **Contractor** ineligible to participate in the LBE program for a period of up to three (3) years.

#### ARTICLE 68. ANTITRUST

68.1 The **Contractor** hereby assigns, sells, and transfers to the **City** all right, title, and interest in and to any claims and causes of action arising under the antitrust **Laws** of New York State or of the United States relating to the particular goods or services purchased or procured by the **City** under this **Contract**.

#### ARTICLE 69. MacBRIDE PRINCIPLES PROVISIONS

69.1 Notice To All Prospective **Contractors**:

69.1.1 Local Law No. 34 of 1991 became effective on September 10, 1991 and added Section 6-115.1 of the Administrative Code. The local **Law** provides for certain restrictions on **City Contracts** to express the opposition of the people of the **City** to employment discrimination practices in Northern Ireland to promote freedom of work-place opportunity.

69.1.2 Pursuant to Section 6-115.1, prospective **Contractors** for **Contracts** to provide goods or services involving an expenditure of an amount greater than ten thousand

(\$10,000.) dollars, or for construction involving an amount greater than fifteen thousand (\$15,000.) dollars, are asked to sign a rider in which they covenant and represent, as a material condition of their **Contract**, that any business operations in Northern Ireland conducted by the **Contractor** and any individual or legal entity in which the **Contractor** holds a ten (10%) percent or greater ownership interest in the **Contractor** will be conducted in accordance with the MacBride Principles of nondiscrimination in employment.

69.1.3 Prospective **Contractors** are not required to agree to these conditions. However, in the case of **Contracts** let by competitive sealed bidding, whenever the lowest responsible bidder has not agreed to stipulate to the conditions set forth in this notice and another bidder who has agreed to stipulate to such conditions has submitted a bid within five (5%) percent of the lowest responsible bid for a **Contract** to supply goods, services or construction of comparable quality, the **Agency** shall refer such bids to the Mayor, the Speaker or other officials, as appropriate, who may determine, in accordance with applicable **Law**, that it is in the best interest of the **City** that the **Contract** be awarded to other than the lowest responsible pursuant to Section 313(b)(2) of the **City Charter**.

69.1.4 In the case of **Contracts** let by other than competitive sealed bidding, if a prospective **Contractor** does not agree to these conditions, no **Agency**, elected official or the **City Council** shall award the **Contract** to that bidder unless the **Agency** seeking to use the goods, services or construction certifies in writing that the **Contract** is necessary for the **Agency** to perform its functions and there is no other responsible **Contractor** who will supply goods, services or construction of comparable quality at a comparable price.

69.2 In accordance with Section 6-115.1 of the Administrative Code, the **Contractor** stipulates that such **Contractor** and any individual or legal entity in which the **Contractor** holds a ten (10%) percent or greater ownership interest in the **Contractor** either:

69.2.1 Have no business operations in Northern Ireland, or

69.2.2 Shall take lawful steps in good faith to conduct any business operations they have in Northern Ireland in accordance with the MacBride Principles, and shall permit independent monitoring of their compliance with such principles.

69.3 For purposes of this Article, the following terms shall have the following meanings:

69.3.1 "MacBride Principles" shall mean those principles relating to nondiscrimination in employment and freedom of work-place opportunity which require employers doing business in Northern Ireland to:

69.3.1(a) increase the representation of individuals from under-represented religious groups in the workforce, including managerial, supervisory, administrative, clerical and technical jobs;

69.3.1(b) take steps to promote adequate security for the protection of employees from under-represented religious groups both at the work-place and while traveling to and from **Work**;

69.3.1(c) ban provocative religious or political emblems from the workplace;

69.3.1(d) publicly advertise all job openings and make special recruitment efforts to attract applicants from under-represented religious groups;

69.3.1(e) establish layoff, recall, and termination procedures which do not in practice favor a particular religious group;

69.3.1(f) abolish all job reservations, apprenticeship restrictions and different employment criteria which discriminate on the basis of religion;

69.3.1(g) develop training programs that will prepare substantial numbers of current employees from under-represented religious groups for skilled jobs, including the expansion of existing programs and the creation of new programs to train, upgrade, and improve the skills of workers from under-represented religious groups;

69.3.1(h) establish procedures to assess, identify, and actively recruit employees from under-represented religious groups with potential for further advancement; and

69.3.1(i) appoint a senior management staff member to oversee affirmative action efforts and develop a timetable to ensure their full implementation.

69.4 The Contractor agrees that the covenants and representations in Article 69.2 are material conditions to this Contract. In the event the Agency receives information that the Contractor who made the stipulation required by this Article 69 is in violation thereof, the Agency shall review such information and give the Contractor an opportunity to respond. If the Agency finds that a violation has occurred, the Agency shall have the right to declare the Contractor in default and/or terminate this Contract for cause and procure supplies, services or Work from another source in the manner the Agency deems proper. In the event of such termination, the Contractor shall pay to the Agency, or the Agency in its sole discretion may withhold from any amounts otherwise payable to the Contractor, the difference between the Contract price for the uncompleted portion of this Contract and the cost to the Agency of completing performance of this Contract either itself or by engaging another Contractor or Contractors. In the case of a requirement Contract, the Contractor shall be liable for such difference in price for the entire amount of supplies required by the Agency for the uncompleted term of Contractor's Contract. In the case of a construction Contract, the Agency shall also have the right to hold the Contractor in partial or total default in accordance with the default provisions of this Contract, and/or may seek debarment or suspension of the Contractor. The rights and remedies of the Agency hereunder shall be in addition to, and not in lieu of, any rights and remedies the Agency has pursuant to this Contract or by operation of Law.

#### **ARTICLE 70. ELECTRONIC FILING/NYC DEVELOPMENT HUB**

70.1 The Contractor shall electronically file all alteration type-2 and alteration type-3 applications via the New York City Development Hub Web site, except applications for the following types of minor alterations: enlargements, curb cuts, legalizations, fire alarms, builders pavement plans, and jobs filed on Landmark Preservation Commission calendared properties. All such filings must be professionally certified. Information about electronic filing via the New York City Development Hub is available on the City Department of Buildings Web site at [www.nyc.gov/buildings](http://www.nyc.gov/buildings).

#### **ARTICLE 71. PROHIBITION OF TROPICAL HARDWOODS**

71.1 Tropical hardwoods, as defined in Section 165 of the New York State Finance Law (Finance Law), shall not be utilized in the performance of this Contract except as expressly permitted by Section 165 of the Finance Law.

**ARTICLE 72. CONFLICTS OF INTEREST**

72.1 Section 2604 of the City Charter and other related provisions of the City Charter, the Administrative Code, and the Penal Law are applicable under the terms of this Contract in relation to conflicts of interest and shall be extended to Subcontractors authorized to perform Work, labor and services pursuant to this Contract and further, it shall be the duty and responsibility of the Contractor to so inform its respective Subcontractors. Notice is hereby given that, under certain circumstances, penalties may be invoked against the donor as well as the recipient of any form of valuable gift.

**ARTICLE 73. MERGER CLAUSE**

73.1 The written Contract herein, contains all the terms and conditions agreed upon by the parties hereto, and no other agreement, oral or otherwise, regarding the subject matter of this Contract shall be deemed to exist or to bind any of the parties hereto, or to vary any of the terms contained herein.

**ARTICLE 74. STATEMENT OF WORK**

74.1 The Contractor shall furnish all labor and materials and perform all Work in strict accordance with the Specifications and Addenda thereto, numbered ONE THRU TWO.

**ARTICLE 75. COMPENSATION TO BE PAID TO CONTRACTOR**

75.1 The City will pay and the Contractor will accept in full consideration for the performance of the Contract, subject to additions and deductions as provided herein, the total sum of: SEE BELOW Dollars, (\$ 13,639,587.00) this said sum being the amount at which the Contract was awarded to the Contractor at a public letting thereof, based upon the Contractor's bid for the Contract. THIRTY NINE THOUSAND, FIVE HUNDRED EIGHTY

**ARTICLE 76. ELECTRONIC FUNDS TRANSFER**

76.1 In accordance with Section 6-107.1 of the Administrative Code, the Contractor agrees to accept payments under this Contract from the City by electronic funds transfer (EFT). An EFT is any transfer of funds, other than a transaction originated by check, draft or similar paper instrument, which is initiated through an electronic terminal, telephonic instrument or computer or magnetic tape so as to order, instruct or authorize a financial institution to debit or credit an account. Prior to the first payment made under this Contract, the Contractor shall designate one financial institution or other authorized payment agent and shall complete the attached "EFT Vendor Payment Enrollment Form" in order to provide the Commissioner of the City Department of Finance with information necessary for the Contractor to receive electronic funds transfer payments through a designated financial institution or authorized payment agent. The crediting of the amount of a payment to the appropriate account on the books of a financial institution or other authorized payment agent designated by the Contractor shall constitute full satisfaction by the City for the amount of the payment under this Contract. The account information supplied by the Contractor to facilitate the electronic funds transfer shall remain confidential to the fullest extent provided by Law.

76.2 The Commissioner may waive the application of the requirements of this Article 76 to payments on contracts entered into pursuant to Section 315 of the City Charter. In addition, the Commissioner of the Department of Finance and the Comptroller may jointly issue standards pursuant to CITY OF NEW YORK

which the Agency may waive the requirements of this Article 76 for payment in the following circumstances: (i) for individuals or classes of individuals for whom compliance imposes a hardship; (ii) for classifications or types of checks; or (iii) in other circumstances as may be necessary in the interest of the City.

#### ARTICLE 77. RECORDS RETENTION

77.1 The Contractor agrees to retain all books, records, and other documents relevant to this Contract for six years after the final payment or termination of this Contract, whichever is later. City, state, and federal auditors and any other persons duly authorized by the City shall have full access to and the right to examine any such books, records, and other documents during the retention period.

#### ARTICLE 78. PARTICIPATION BY MINORITY-OWNED AND WOMEN-OWNED BUSINESS ENTERPRISES IN CITY PROCUREMENT

##### NOTICE TO ALL PROSPECTIVE CONTRACTORS

#### ARTICLE I. M/WBE PROGRAM

Local Law No. 129 of 2005 added and Local Law 1 of 2013 amended Section 6-129 of the Administrative Code of the City of New York (hereinafter "Section 6-129"). Section 6-129 establishes the program for participation in City procurement ("M/WBE Program") by minority-owned business enterprises ("MBEs") and women-owned business enterprises ("WBEs"), certified in accordance with Section 1304 of the New York City Charter. As stated in Section 6-129, the intent of the program is to address the impact of discrimination on the City's procurement process, and to promote the public interest in avoiding fraud and favoritism in the procurement process, increasing competition for City business, and lowering contract costs. The contract provisions contained herein are pursuant to Section 6-129, and the rules of the Department of Small Business Services ("DSBS") promulgated thereunder.

If this Contract is subject to the M/WBE Program established by Section 6-129, the specific requirements of MBE and/or WBE participation for this Contract are set forth in Schedule B of the Contract (entitled the "M/WBE Utilization Plan"), and are detailed below. The Contractor must comply with all applicable MBE and WBE requirements for this Contract.

All provisions of Section 6-129 are hereby incorporated in the Contract by reference and all terms used herein that are not defined herein shall have the meanings given such terms in Section 6-129. Article I, Part A, below, sets forth provisions related to the participation goals for construction, standard and professional services contracts. Article I, Part B, below, sets forth miscellaneous provisions related to the M/WBE Program.

#### PART A

##### PARTICIPATION GOALS FOR CONSTRUCTION, STANDARD AND PROFESSIONAL SERVICES CONTRACTS OR TASK ORDERS

1. The MBE and/or WBE Participation Goals established for this Contract or Task Orders issued pursuant to this Contract, ("Participation Goals"), as applicable, are set forth on Schedule B, Part I to this Contract (see Page 1, line 1 Total Participation Goals) or will be set forth on Schedule B, Part I to Task Orders issued pursuant to this Contract, as applicable.



The **Participation Goals** represent a percentage of the total dollar value of the Contract or Task Order, as applicable, that may be achieved by awarding subcontracts to firms certified with New York City Department of Small Business Services as MBEs and/or WBEs, and/or by crediting the participation of prime contractors and/or qualified joint ventures as provided in Section 3 below, unless the goals have been waived or modified by Agency in accordance with Section 6-129 and Part A, Sections 10 and 11 below, respectively.

2. If **Participation Goals** have been established for this Contract or Task Orders issued pursuant to this Contract, Contractor agrees or shall agree as a material term of the Contract that Contractor shall be subject to the **Participation Goals**, unless the goals are waived or modified by Agency in accordance with Section 6-129 and Part A, Sections 10 and 11 below, respectively.

3. If **Participation Goals** have been established for this Contract or Task Order issued pursuant to this Contract, a Contractor that is an MBE and/or WBE shall be permitted to count its own participation toward fulfillment of the relevant **Participation Goal**, provided that in accordance with Section 6-129 the value of Contractor's participation shall be determined by subtracting from the total value of the Contract or Task Order, as applicable, any amounts that the Contractor pays to direct subcontractors (as defined in Section 6-129(c)(13)), and provided further that a Contractor that is certified as both an MBE and a WBE may count its own participation either toward the goal for MBEs or the goal for WBEs, but not both.

A Contractor that is a qualified joint venture (as defined in Section 6-129(c)(30)) shall be permitted to count a percentage of its own participation toward fulfillment of the relevant **Participation Goal**. In accordance with Section 6-129, the value of Contractor's participation shall be determined by subtracting from the total value of the Contract or Task Order, as applicable, any amounts that Contractor pays to direct subcontractors, and then multiplying the remainder by the percentage to be applied to total profit to determine the amount to which an MBE or WBE is entitled pursuant to the joint venture agreement, provided that where a participant in a joint venture is certified as both an MBE and a WBE, such amount shall be counted either toward the goal for MBEs or the goal for WBEs, but not both.

4. A. If **Participation Goals** have been established for this Contract, a prospective contractor shall be required to submit with its bid or proposal, as applicable, a completed Schedule B, M/WBE Utilization Plan, Part II (see Pages 2-4) indicating: (a) whether the contractor is an MBE or WBE, or qualified joint venture; (b) the percentage of work it intends to award to direct subcontractors; and (c) in cases where the contractor intends to award direct subcontracts, a description of the type and dollar value of work designated for participation by MBEs and/or WBEs, and the time frames in which such work is scheduled to begin and end. In the event that this M/WBE Utilization Plan indicates that the bidder or proposer, as applicable, does not intend to meet the **Participation Goals**, the bid or proposal, as applicable, shall be deemed non-responsive, unless Agency has granted the bidder or proposer, as applicable, a pre-award waiver of the Participation Goals in accordance with Section 6-129 and Part A, Section 10 below.

B. (i) If this Contract is for a master services agreement or other requirements type contract that will result in the issuance of Task Orders that will be individually registered ("Master Services Agreement") and is subject to M/WBE **Participation Goals**, a prospective contractor shall be required to submit with its bid or proposal, as applicable, a completed Schedule B, M/WBE Participation Requirements for Master Services Agreements That Will Require Individually Registered Task Orders, Part II (page 2) indicating the prospective contractor's certification and required affirmations to make all reasonable good faith efforts to meet participation goals established on each individual Task Order issued pursuant to this Contract, or if a partial waiver is obtained or such goals are modified by the Agency, to meet the modified **Participation Goals** by soliciting and obtaining the participation of certified MBE and/or WBE firms. In the event that the Schedule B indicates that the bidder or proposer, as applicable, does not intend to meet the **Participation Goals** that may be established on Task Orders issued pursuant to this Contract, the bid or proposal, as applicable, shall be deemed nonresponsive.

(ii) **Participation Goals** on a Master Services Agreement will be established for individual Task Orders issued after the Master Services Agreement is awarded. If **Participation Goals** have been established on a Task Order, a contractor shall be required to submit a Schedule B – M/WBE Utilization Plan For Independently Registered Task Orders That Are Issued Pursuant to Master Services Agreements, Part II (see Pages 2-4) indicating: (a) whether the contractor is an MBE or WBE, or qualified joint venture; (b) the percentage of work it intends to award to direct subcontractors; and (c) in cases where the contractor intends to award direct subcontracts, a description of the type and dollar value of work designated for participation by MBEs and/or WBEs, and the time frames in which such work is scheduled to begin and end. The contractor must engage in good faith efforts to meet the **Participation Goals** as established for the Task Order unless Agency has granted the contractor a pre-award waiver of the Participation Goals in accordance with Section 6-129 and Part A, Section 10 below.

**C. THE BIDDER/PROPOSER MUST COMPLETE THE SCHEDULE B INCLUDED HEREIN (SCHEDULE B, PART II). A SCHEDULE B SUBMITTED BY THE BIDDER/PROPOSER WHICH DOES NOT INCLUDE THE VENDOR CERTIFICATION AND REQUIRED AFFIRMATIONS (SEE SECTION V OF PART II) WILL BE DEEMED TO BE NON-RESPONSIVE, UNLESS A FULL WAIVER OF THE PARTICIPATION GOALS IS GRANTED (SCHEDULE B, PART III). IN THE EVENT THAT THE CITY DETERMINES THAT THE BIDDER/PROPOSER HAS SUBMITTED A SCHEDULE B WHERE THE VENDOR CERTIFICATION AND REQUIRED AFFIRMATIONS ARE COMPLETED BUT OTHER ASPECTS OF THE SCHEDULE B ARE NOT COMPLETE, OR CONTAIN A COPY OR COMPUTATION ERROR THAT IS AT ODDS WITH THE VENDOR CERTIFICATION AND AFFIRMATIONS, THE BIDDER/PROPOSER WILL BE NOTIFIED BY THE AGENCY AND WILL BE GIVEN FOUR (4) CALENDAR DAYS FROM RECEIPT OF NOTIFICATION TO CURE THE SPECIFIED DEFICIENCIES AND RETURN A COMPLETED SCHEDULE B TO THE AGENCY. FAILURE TO DO SO WILL RESULT IN A DETERMINATION THAT THE BID/PROPOSAL IS NON-RESPONSIVE. RECEIPT OF NOTIFICATION IS DEFINED AS THE DATE NOTICE IS E-MAILED OR FAXED (IF THE BIDDER/PROPOSER HAS PROVIDED AN E-MAIL ADDRESS OR FAX NUMBER), OR NO LATER THAN FIVE (5) CALENDAR DAYS FROM THE DATE OF MAILING OR UPON DELIVERY, IF DELIVERED.**

5. Where an M/WBE Utilization Plan has been submitted, the Contractor shall, within 30 days of issuance by Agency of a notice to proceed, submit a list of proposed persons or entities to which it intends to award subcontracts within the subsequent 12 months. In the case of multiyear contracts, such list shall also be submitted every year thereafter. The Agency may also require the Contractor to report periodically about the contracts awarded by its direct subcontractors to indirect subcontractors (as defined in Section 6-129(c)(22)). **PLEASE NOTE: If this Contract is a public works project subject to GML §101(5) (i.e., a contract valued at or below \$3M for projects in New York City) or if the Contract is subject to a project labor agreement in accordance with Labor Law §222, and the bidder is required to identify at the time of bid submission its intended subcontractors for the Wicks trades (plumbing and gas fitting; steam heating, hot water heating, ventilating and air conditioning (HVAC); and electric wiring), the Contractor must identify all those to which it intends to award construction subcontracts for any portion of the Wicks trade work at the time of bid submission, regardless of what point in the life of the contract such subcontracts will occur. In identifying intended subcontractors in the bid submission, bidders may satisfy any Participation Goals established for this Contract by proposing one or more subcontractors that are MBEs and/or WBEs for any portion of the Wicks trade work. In the event that the Contractor's selection of a subcontractor is disapproved, the Contractor shall have a reasonable time to propose alternate subcontractors.**

6. MBE and WBE firms must be certified by DSBS in order for the Contractor to credit such firms' participation toward the attainment of the **Participation Goals**. Such certification must occur prior to the

firms' commencement of work. A list of MBE and WBE firms may be obtained from the DSBS website at [www.nyc.gov/buycertified](http://www.nyc.gov/buycertified), by emailing DSBS at [buyer@sbs.nyc.gov](mailto:buyer@sbs.nyc.gov), by calling (212) 513-6356, or by visiting or writing DSBS at 110 William St., New York, New York, 10038, 7th floor. Eligible firms that have not yet been certified may contact DSBS in order to seek certification by visiting [www.nyc.gov/getcertified](http://www.nyc.gov/getcertified), emailing [MWBE@sbs.nyc.gov](mailto:MWBE@sbs.nyc.gov), or calling the DSBS certification helpline at (212) 513-6311. A firm that is certified as both an MBE and a WBE may be counted either toward the goal for MBEs or the goal for WBEs, but not both. No credit shall be given for participation by a graduate MBE or graduate WBE, as defined in Section 6-129(c)(20).

7. Where an M/WBE Utilization Plan has been submitted, the Contractor shall, with each voucher for payment, and/or periodically as Agency may require, submit statements, certified under penalty of perjury, which shall include, but not be limited to, the total amount the Contractor paid to its direct subcontractors, and, where applicable pursuant to Section 6-129(j), the total amount direct subcontractors paid to indirect subcontractors; the names, addresses and contact numbers of each MBE or WBE hired as a subcontractor by the Contractor, and, where applicable, hired by any of the Contractor's direct subcontractors; and the dates and amounts paid to each MBE or WBE. The Contractor shall also submit, along with its voucher for final payment: the total amount it paid to subcontractors, and, where applicable pursuant to Section 6-129(j), the total amount its direct subcontractors paid directly to their indirect subcontractors; and a final list, certified under penalty of perjury, which shall include the name, address and contact information of each subcontractor that is an MBE or WBE, the work performed by, and the dates and amounts paid to each.

8. If payments made to, or work performed by, MBEs or WBEs are less than the amount specified in the Contractor's M/WBE Utilization Plan, Agency shall take appropriate action, in accordance with Section 6-129 and Article II below, unless the Contractor has obtained a modification of its M/WBE Utilization Plan in accordance with Section 6-129 and Part A, Section 11 below.

9. Where an M/WBE Utilization Plan has been submitted, and the Contractor requests a change order the value of which exceeds the greater of 10 percent of the Contract or Task Order, as applicable, or \$500,000, Agency shall review the scope of work for the Contract or Task Order, as applicable, and the scale and types of work involved in the change order, and determine whether the **Participation Goals** should be modified.

10. Pre-award waiver of the **Participation Goals**. (a) A bidder or proposer, or contractor with respect to a Task Order, may seek a pre-award full or partial waiver of the **Participation Goals** in accordance with Section 6-129, which requests that Agency change one or more **Participation Goals** on the grounds that the **Participation Goals** are unreasonable in light of the availability of certified firms to perform the services required, or by demonstrating that it has legitimate business reasons for proposing a lower level of subcontracting in its M/WBE Utilization Plan.

(b) To apply for a full or partial waiver of the **Participation Goals**, a bidder, proposer, or contractor, as applicable, must complete Part III (Page 5) of Schedule B and submit such request no later than seven (7) calendar days prior to the date and time the bids, proposals, or Task Orders are due, in writing to the Agency by email at [poped@ddc.nyc.gov](mailto:poped@ddc.nyc.gov) or via facsimile at (718) 391-1886. Bidders, proposers, or contractors, as applicable, who have submitted requests will receive an Agency response by no later than two (2) calendar days prior to the due date for bids, proposals, or Task Orders; provided, however, that if that date would fall on a weekend or holiday, an Agency response will be provided by close-of-business on the business day before such weekend or holiday date.

(c) If the Agency determines that the **Participation Goals** are unreasonable in light of the availability of certified firms to perform the services required, it shall revise the solicitation and extend the deadline for bids and proposals, or revise the Task Order, as applicable.

(d) Agency may grant a full or partial waiver of the **Participation Goals** to a bidder, proposer or contractor, as applicable, who demonstrates—before submission of the bid, proposal or Task Order, as applicable—that it has legitimate business reasons for proposing the level of subcontracting in its **M/WBE Utilization Plan**. In making its determination, Agency shall consider factors that shall include, but not be limited to, whether the bidder, proposer or contractor, as applicable, has the capacity and the bona fide intention to perform the Contract without any subcontracting, or to perform the Contract without awarding the amount of subcontracts represented by the **Participation Goals**. In making such determination, Agency may consider whether the **M/WBE Utilization Plan** is consistent with past subcontracting practices of the bidder, proposer or contractor, as applicable, whether the bidder, proposer or contractor, as applicable, has made efforts to form a joint venture with a certified firm, and whether the bidder, proposer, or contractor, as applicable, has made good faith efforts to identify other portions of the Contract that it intends to subcontract.

11. **Modification of M/WBE Utilization Plan.** (a) A Contractor may request a modification of its **M/WBE Utilization Plan** after award of this Contract. **PLEASE NOTE: If this Contract is a public works project subject to GML §101(5) (i.e., a contract valued at or below \$3M for projects in New York City) or if the Contract is subject to a project labor agreement in accordance with Labor Law §222, and the bidder is required to identify at the time of bid submission its intended subcontractors for the Wicks trades (plumbing and gas fitting; steam heating, hot water heating, ventilating and air conditioning (HVAC); and electric wiring), the Contractor may request a Modification of its M/WBE Utilization Plan as part of its bid submission.** The Agency may grant a request for Modification of a Contractor's **M/WBE Utilization Plan** if it determines that the Contractor has established, with appropriate documentary and other evidence, that it made reasonable, good faith efforts to meet the **Participation Goals**. In making such determination, Agency shall consider evidence of the following efforts, as applicable, along with any other relevant factors:

- (i) The Contractor advertised opportunities to participate in the Contract, where appropriate, in general circulation media, trade and professional association publications and small business media, and publications of minority and women's business organizations;
- (ii) The Contractor provided notice of specific opportunities to participate in the Contract, in a timely manner, to minority and women's business organizations;
- (iii) The Contractor sent written notices, by certified mail or facsimile, in a timely manner, to advise MBEs or WBEs that their interest in the Contract was solicited;
- (iv) The Contractor made efforts to identify portions of the work that could be substituted for portions originally designated for participation by MBEs and/or WBEs in the **M/WBE Utilization Plan**, and for which the Contractor claims an inability to retain MBEs or WBEs;
- (v) The Contractor held meetings with MBEs and/or WBEs prior to the date their bids or proposals were due, for the purpose of explaining in detail the scope and requirements of the work for which their bids or proposals were solicited;
- (vi) The Contractor made efforts to negotiate with MBEs and/or WBEs as relevant to perform specific subcontracts, or act as suppliers or service providers;
- (vii) Timely written requests for assistance made by the Contractor to Agency's **M/WBE liaison officer** and to DSBS;
- (viii) Description of how recommendations made by DSBS and Agency were acted upon and an explanation of why action upon such recommendations did not lead to the desired level of participation of MBEs and/or WBEs.

Agency's **M/WBE officer** shall provide written notice to the Contractor of the determination.

(b) The Agency may modify the **Participation Goals** when the scope of the work has been changed by the Agency in a manner that affects the scale and types of work that the Contractor indicated in its **M/WBE Utilization Plan** would be awarded to subcontractors.

12. If this Contract is for an indefinite quantity of construction, standard or professional services or is a requirements type contract and the Contractor has submitted an M/WBE Utilization Plan and has committed to subcontract work to MBEs and/or WBEs in order to meet the **Participation Goals**, the Contractor will not be deemed in violation of the M/WBE Program requirements for this Contract with regard to any work which was intended to be subcontracted to an MBE and/or WBE to the extent that the Agency has determined that such work is not needed.

13. If **Participation Goals** have been established for this Contract or a Task Order issued pursuant to this Contract, at least once annually during the term of the Contract or Task Order, as applicable, Agency shall review the Contractor's progress toward attainment of its M/WBE Utilization Plan, including but not limited to, by reviewing the percentage of work the Contractor has actually awarded to MBE and/or WBE subcontractors and the payments the Contractor made to such subcontractors.

14. If **Participation Goals** have been established for this Contract or a Task Order issued pursuant to this Contract, Agency shall evaluate and assess the Contractor's performance in meeting those goals, and such evaluation and assessment shall become part of the Contractor's overall contract performance evaluation.

#### **PART B: MISCELLANEOUS**

1. The Contractor shall take notice that, if this solicitation requires the establishment of an M/WBE Utilization Plan, the resulting contract may be audited by DSBS to determine compliance with Section 6-129. See §6-129(e)(10). Furthermore, such resulting contract may also be examined by the City's Comptroller to assess compliance with the M/WBE Utilization Plan.

2. Pursuant to DSBS rules, construction contracts that include a requirement for an M/WBE Utilization Plan shall not be subject to the law governing Locally Based Enterprises set forth in Section 6-108.1 of the Administrative Code of the City of New York.

3. DSBS is available to assist contractors and potential contractors in determining the availability of MBEs and/or WBEs to participate as subcontractors, and in identifying opportunities that are appropriate for participation by MBEs and/or WBEs in contracts.

4. Prospective contractors are encouraged to enter into qualified joint venture agreements with MBEs and/or WBEs as defined by Section 6-129(c)(30).

5. By submitting a bid or proposal the Contractor hereby acknowledges its understanding of the M/WBE Program requirements set forth herein and the pertinent provisions of Section 6-129, and any rules promulgated thereunder, and if awarded this Contract, the Contractor hereby agrees to comply with the M/WBE Program requirements of this Contract and pertinent provisions of Section 6-129, and any rules promulgated thereunder, all of which shall be deemed to be material terms of this Contract. The Contractor hereby agrees to make all reasonable, good faith efforts to solicit and obtain the participation of MBEs and/or WBEs to meet the required **Participation Goals**.

#### **ARTICLE II. ENFORCEMENT**

1. If Agency determines that a bidder or proposer, as applicable, has, in relation to this procurement, violated Section 6-129 or the DSBS rules promulgated pursuant to Section 6-129, Agency may disqualify such bidder or proposer, as applicable, from competing for this Contract and the Agency may revoke such bidder's or proposer's prequalification status, if applicable.

2. Whenever Agency believes that the Contractor or a subcontractor is not in compliance with Section 6-129 or the DSBS rules promulgated pursuant to Section 6-129, or any provision of this Contract that implements Section 6-129, including, but not limited to any M/WBE Utilization Plan, Agency shall send a written notice to the Contractor describing the alleged noncompliance and offering the Contractor an opportunity to be heard. Agency shall then conduct an investigation to determine whether such Contractor or subcontractor is in compliance.

3. In the event that the Contractor has been found to have violated Section 6-129, the DSBS rules promulgated pursuant to Section 6-129, or any provision of this Contract that implements Section 6-129, including, but not limited to, any M/WBE Utilization Plan, Agency may determine that one of the following actions should be taken:

- (a) entering into an agreement with the Contractor allowing the Contractor to cure the violation;
- (b) revoking the Contractor's pre-qualification to bid or make proposals for future contracts;
- (c) making a finding that the Contractor is in default of the Contract;
- (d) terminating the Contract;
- (e) declaring the Contractor to be in breach of Contract;
- (f) withholding payment or reimbursement;
- (g) determining not to renew the Contract;
- (h) assessing actual and consequential damages;
- (i) assessing liquidated damages or reducing fees, provided that liquidated damages may be based on amounts representing costs of delays in carrying out the purposes of the M/WBE Program, or in meeting the purposes of the Contract, the costs of meeting utilization goals through additional procurements, the administrative costs of investigation and enforcement, or other factors set forth in the Contract;
- (j) exercising rights under the Contract to procure goods, services or construction from another contractor and charge the cost of such contract to the Contractor that has been found to be in noncompliance; or
- (k) taking any other appropriate remedy.

4. If an M/WBE Utilization Plan has been submitted, and pursuant to this Article II, Section 3, the Contractor has been found to have failed to fulfill its **Participation Goals** contained in its M/WBE Utilization Plan or the **Participation Goals** as modified by Agency pursuant to Article I, Part A, Section 11, Agency may assess liquidated damages in the amount of ten percent (10%) of the difference between the dollar amount of work required to be awarded to MBE and/or WBE firms to meet the **Participation Goals** and the dollar amount the Contractor actually awarded and paid, and/or credited, to MBE and/or WBE firms. In view of the difficulty of accurately ascertaining the loss which the City will suffer by reason of Contractor's failure to meet the **Participation Goals**, the foregoing amount is hereby fixed and agreed as the liquidated damages that the City will suffer by reason of such failure, and not as a penalty. Agency may deduct and retain out of any monies which may become due under this Contract the amount of any such liquidated damages; and in case the amount which may become due under this Contract shall be less than the amount of liquidated damages suffered by the City, the Contractor shall be liable to pay the difference.

5. Whenever Agency has reason to believe that an MBE and/or WBE is not qualified for certification, or is participating in a contract in a manner that does not serve a commercially useful function (as defined in Section 6-129(c)(8)), or has violated any provision of Section 6-129, Agency shall notify the Commissioner of DSBS who shall determine whether the certification of such business enterprise should be revoked.

6. Statements made in any instrument submitted to Agency pursuant to Section 6-129 shall be submitted under penalty of perjury and any false or misleading statement or omission shall be grounds for the application of any applicable criminal and/or civil penalties for perjury. The making of a false or fraudulent statement by an MBE and/or WBE in any instrument submitted pursuant to Section 6-129 shall, in addition, be grounds for revocation of its certification.

7. The Contractor's record in implementing its M/WBE Utilization Plan shall be a factor in the evaluation of its performance. Whenever Agency determines that a Contractor's compliance with an M/WBE Utilization Plan has been unsatisfactory, Agency shall, after consultation with the City Chief Procurement Officer, file an advice of caution form for inclusion in VENDEX as caution data.

IN WITNESS WHEREOF, the Commissioner, on behalf of the City of New York, and the Contractor, have executed this agreement in quadruplicate, two parts of which are to remain with the Commissioner, another to be filed with the Comptroller of the City, and the fourth to be delivered to the Contractor.

THE CITY OF NEW YORK

By:   
Deputy Commissioner

CONTRACTOR: NY Asphalt, Inc

By:   
(Member of Firm or Officer of Corporation)

Title: General Manager

(Where Contractor is a Corporation, add):  
Attest:

  
Secretary

(Seal)



ACKNOWLEDGEMENT OF PRINCIPAL, IF A CORPORATION

State of New York County of Queens ss:

On this 11<sup>th</sup> day of Dec., 2017, before me personally came Joseph Bannetti to me known who, being by me duly sworn did depose and say that he resides at W. Orange NS that he is the General Manager of the corporation described in and which executed the foregoing instrument; that he knows the seal of said corporation; that one of the seals affixed to said instrument is such seal; that it was so affixed by order of the directors of said corporation, and that he signed his name thereto by like order.

VICTORIA AYO-VAUGHAN  
Notary Public, State of New York  
Registration #01AY5014042  
Qualified in Queens County  
Commission Expires July 15, 2019

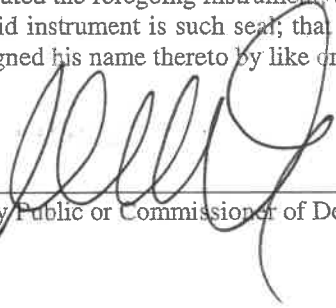
  
\_\_\_\_\_  
Notary Public or Commissioner of Deeds

ACKNOWLEDGEMENT OF PRINCIPAL, IF A PARTNERSHIP

State of \_\_\_\_\_ County of \_\_\_\_\_ ss:

On this \_\_\_\_\_ day of \_\_\_\_\_, \_\_\_\_\_, before me personally appeared \_\_\_\_\_ to me known, and known to me to be one of the members of the firm of \_\_\_\_\_ described in and who executed the foregoing instrument; and he acknowledged to me that he executed the same as and for the act and deed of said firm.

\_\_\_\_\_  
Notary Public or Commissioner of Deeds

ACKNOWLEDGEMENT OF PRINCIPAL, IF AN INDIVIDUAL

State of \_\_\_\_\_ County of \_\_\_\_\_ ss:

On this \_\_\_\_\_ day of \_\_\_\_\_, \_\_\_\_\_, before me personally appeared \_\_\_\_\_ to me known, and known to me to be the person described in and who executed the foregoing instrument; and acknowledged that he executed the same.

\_\_\_\_\_  
Notary Public or Commissioner of Deeds

ACKNOWLEDGEMENT BY COMMISSIONER

State of New York County of Queens ss:

On this 12<sup>th</sup> day of Dec. 2017, before me personally came Eric Macfarlane to me known, and known to be the Deputy Commissioner of the Department of Design and Construction of The City of New York, the person described as such in and who as such executed the foregoing instrument and acknowledged to me that he executed the same as Deputy Commissioner for the purposes therein mentioned.

  
\_\_\_\_\_  
Notary Public or Commissioner of Deeds

VICTORIA AYO-VAUGHAN  
Notary Public, State of New York  
Registration #01AY5014042  
Qualified in Queens County  
Commission Expires July 15, 2019

AUTHORITY

MAYOR'S CERTIFICATE NO. CBX  
BUDGET DIRECTOR'S CERTIFICATE NO.

DATED  
DATED

APPROPRIATION  
COMMISSIONER'S CERTIFICATE

In conformity with the provisions of Section 6-101 of the Administrative Code of the City of New York, it is hereby certified that the estimated cost of the work, materials and supplies required by the within Contract, amounting to

Thirteen Million, Six Hundred  
Thirty Nine Thousand Five Hundred  
Eighty Seven Dollars 00/100  
Dollars (\$ 13,639,587.00)

is chargeable to the fund of the Department of Design and Construction entitled Code

Various

Department of Design and Construction

I hereby certify that the specifications contained herein comply with the terms and conditions of the BUDGET.

  
Deputy Commissioner

COMPTROLLER'S CERTIFICATE

The City of New York \_\_\_\_\_

Pursuant to the provisions of Section 6-101 of the Administrative Code of the City of New York, I hereby certify that there remains unapplied and unexpended a balance of the above mentioned fund applicable to this Contract sufficient to pay the estimated expense of executing the same viz:

\$ \_\_\_\_\_

\_\_\_\_\_  
Comptroller

MAYOR'S CERTIFICATE OR  
CERTIFICATE OF THE DIRECTOR  
OF THE BUDGET

**Performance Bond #1 (Pages 92 to 95): Use if the total contract price is \$5 Million Or Less. Performance Bond #1 has been approved by the U.S. Small Business Administration ("SBA") for participation in its Bond Guarantee Program.**

PERFORMANCE BOND #1 (Page 1)

**PERFORMANCE BOND #1**

**KNOW ALL PERSONS BY THESE PRESENTS:**

That we, \_\_\_\_\_

\_\_\_\_\_

\_\_\_\_\_

hereinafter referred to as the "Principal,"

and, \_\_\_\_\_

\_\_\_\_\_

\_\_\_\_\_

hereinafter referred to as the "Surety" ("Sureties") are held and firmly bound to THE CITY OF NEW YORK, hereinafter referred to as the "City" or to its successors and assigns in the penal sum of \_\_\_\_\_

\_\_\_\_\_

\_\_\_\_\_

(\$ \_\_\_\_\_) Dollars, lawful money of the United States for the payment of which said sum of money well and truly to be made, we, and each of us, bind ourselves, our heirs, executors, administrators, successors and assigns, jointly and severally, firmly by these presents.

**WHEREAS**, the Principal is about to enter, or has entered, into a Contract in writing with the City for

\_\_\_\_\_

\_\_\_\_\_

a copy of which Contract is annexed to and hereby made a part of this bond as though herein set forth in full;

**NOW, THEREFORE**, the conditions of this obligation are such that if the Principal, his or its representatives or assigns, shall well and faithfully perform the said Contract and all modifications, amendments, additions and alterations thereto that may hereafter be made, according to its terms and its true intent and meaning, including repair and or replacement of defective work and guarantees of maintenance for the periods stated in the Contract, and shall fully indemnify and save harmless the City from all cost and damage which it may suffer by reason of the Principal's default of the Contract, and shall fully reimburse and repay the City for all outlay and expense which the City may incur in making

**Performance Bond #2 (Pages 82 to 85): Use if the total contract price is more than \$5 Million.**

Bond No. PB11727800077

PERFORMANCE BOND #2 (Page 1)

**PERFORMANCE BOND #2**

**KNOW ALL PERSONS BY THESE PRESENTS:**

That we, \_\_\_\_\_

NY Asphalt, Inc.

366 Industrial Loop, Staten Island, NY 10309

hereinafter referred to as the "Principal,"

and, \_\_\_\_\_

Philadelphia Indemnity Insurance Company

One Bala Plaza, Suite 100, Bala Cynwyd, PA 19004

hereinafter referred to as the "Surety" ("Sureties") are held and firmly bound to THE CITY OF NEW YORK, hereinafter referred to as the "City" or to its successors and assigns in the penal sum of \_\_\_\_\_

Thirteen Million Six Hundred Thirty Nine Thousand Five Hundred Eighty Seven

Dollars and Zero Cents

(\$ 13,639,587.00) Dollars, lawful money of the United States for the payment of which said sum of money well and truly to be made, we, and each of us, bind ourselves, our heirs, executors, administrators, successors and assigns, jointly and severally, firmly by these presents.

**WHEREAS**, the Principal is about to enter, or has entered, into a Contract in writing with the City for

FMS ID: SANDHW11; E-PIN: 85017B0031001; DDC PIN: 8502017HW0001C Reconstruction of Beach Channel

Drive Between Beach 116th Street and 124th Street - Borough of Queens

a copy of which Contract is annexed to and hereby made a part of this bond as though herein set forth in full;

**NOW, THEREFORE**, the conditions of this obligation are such that if the Principal, his or its representatives or assigns, shall well and faithfully perform the said Contract and all modifications, amendments, additions and alterations thereto that may hereafter be made, according to its terms and its true intent and meaning, including repair and or replacement of defective work and guarantees of maintenance for the periods stated in the Contract, and shall fully indemnify and save harmless the City from all cost and damage which it may suffer by reason of the Principal's default of the Contract, and shall fully reimburse and repay the City for all outlay and expense which the City may incur in making



**Performance Bond #2 (Pages 82 to 85): Use if the total contract price is more than \$5 Million.**

PERFORMANCE BOND #2 (Page 2)

good any such default and shall protect the said City of New York against, and pay any and all amounts, damages, cost and judgments which may or shall be recovered against said City or its officers or agents or which the said City of New York may be called upon to pay any person or corporation by reason of any damages arising or growing out of the Principal's default of the Contract, then this obligation shall be null and void, otherwise to remain in full force and effect.

The Surety (Sureties), for value received, hereby stipulates and agrees, upon written notice from the City that the City has determined that the Principal is in default of the Contract, to either (1) pay the full amount of the above penal sum in complete discharge and exoneration of this bond and of all the liabilities of the Surety relating to this bond, or (2) fully perform and complete the Work to be performed under the Contract, pursuant to the terms, conditions, and covenants thereof. The Surety (Sureties) further agrees, at its option, either to tender the penal sum or to commence and diligently perform the Work specified in the Contract, including physical site work, within twenty-five (25) business days after written notice thereof from the City and to complete all Work within the time set forth in the Contract or such other time as agreed to between the City and Surety in accordance with the Contract. The Surety and the City reserve all rights and defenses each may have against the other; provided, however, that the Surety expressly agrees that its reservation of rights shall not provide a basis for non-performance of its obligation to commence and to complete all Work as provided herein.

The Surety (Sureties), for value received, for itself and its successors and assigns, hereby stipulates and agrees that the obligation of said Surety (Sureties) and its bond shall be in no way impaired or affected by any extension of time, modification, omission, addition, or change in or to the said Contract or the Work to be performed thereunder, or by any payment thereunder before the time required therein, or by any waiver of any provisions thereof, or by any assignment, subletting or other transfer thereof or of any Work to be performed or any moneys due or to become due thereunder; and said Surety (Sureties) does hereby waive notice of any and all of such extensions, modifications, omissions, additions, changes, payments, waivers, assignments, subcontracts and transfers, and hereby expressly stipulates and agrees that any and all things done and omitted to be done by and in relation to assignees, subcontractors, and other transferees shall have the same effect as to said Surety (Sureties) as though done or omitted to be done by or in relation to said Principal.





**Performance Bond #2 (Pages 82 to 85): Use if the total contract price is more than \$5 Million.**

**PERFORMANCE BOND #2 (Page 3)**

IN WITNESS WHEREOF, The Principal and the Surety (Sureties) have hereunto set their hands and seals, and such of them as are corporations have caused their corporate seals to be hereunto affixed and these presents to be signed by their proper officers, this

\_\_\_\_\_ 5th \_\_\_\_\_ day of December \_\_\_\_\_ 20 17 \_\_\_\_\_

(Seal) \_\_\_\_\_  
NY Asphalt, Inc. (L.S.)  
Principal

(Seal) By: \_\_\_\_\_  
Surety

Philadelphia Indemnity Insurance Company  
By: \_\_\_\_\_  
Michael Culnen, Attorney-in-Fact  
Surety

(Seal) By: \_\_\_\_\_  
Surety

(Seal) By: \_\_\_\_\_  
Surety

(Seal) By: \_\_\_\_\_  
Surety

(Seal) By: \_\_\_\_\_

Bond Premium Rate \$25/20/15/10

Bond Premium Cost \$151,896.00

If the Contractor (Principal) is a partnership, the bond should be signed by each of the individuals who are partners.

If the Contractor (Principal) is a corporation, the bond should be signed in its correct corporate name by a duly authorized officer, agent, or attorney-in-fact.

There should be executed an appropriate number of counterparts of the bond corresponding to the number of counterparts of the Contract.



**Performance Bond #2 (Pages 82 to 85): Use if the total contract price is more than \$5 Million.**

PERFORMANCE BOND #2 (Page 4)

**ACKNOWLEDGMENT OF PRINCIPAL IF A CORPORATION**

State of New York County of Richmond ss:

On this 8<sup>th</sup> day of Dec, 2017 before me personally came Michael Thompson to me known, who, being by me duly sworn did depose and say that he resides

at Colts Neck, NJ; that he/she is the president of the corporation described in and which executed the foregoing instrument; that he/she signed his/her name to the foregoing instrument by order of the directors of said corporation as the duly authorized and binding act thereof.

Michele Renna  
Notary Public or Commissioner of Deeds.

MICHELE RENNA  
NOTARY PUBLIC STATE OF NEW YORK  
No. 01RE6110285  
My Commission Expires May 24, 2020

**ACKNOWLEDGMENT OF PRINCIPAL IF A PARTNERSHIP**

State of \_\_\_\_\_ County of \_\_\_\_\_ ss:

On this \_\_\_\_\_ day of \_\_\_\_\_, 20\_\_\_\_ before me personally came \_\_\_\_\_ to me known, who, being by me duly sworn did depose and say that he/she resides at \_\_\_\_\_

\_\_\_\_\_ ; that he/she is \_\_\_\_\_ partner of \_\_\_\_\_, a limited/general partnership existing under the laws of the State of \_\_\_\_\_, the partnership described in and which executed the foregoing instrument; and that he/she signed his/her name to the foregoing instrument as the duly authorized and binding act of said partnership.

\_\_\_\_\_  
Notary Public or Commissioner of Deeds

**ACKNOWLEDGMENT OF PRINCIPAL IF AN INDIVIDUAL**

State of \_\_\_\_\_ County of \_\_\_\_\_ ss:

On this \_\_\_\_\_ day of \_\_\_\_\_, 20\_\_\_\_ before me personally came \_\_\_\_\_ to me known, who, being by me duly sworn did depose and say that he/she resides at \_\_\_\_\_

\_\_\_\_\_ and that he/she is the individual whose name is subscribed to the within instrument and acknowledged to me that by his/her signature on the instrument, said individual executed the instrument.

\_\_\_\_\_  
Notary Public or Commissioner of Deeds

Each executed bond should be accompanied by: (a) appropriate acknowledgments of the respective parties; (b) appropriate duly certified copy of Power of Attorney or other certificate of authority where bond is executed by agent, officer or other representative of Principal or Surety; (c) a duly certified extract from By-Laws or resolutions of Surety under which Power of Attorney or other certificate of authority of its agent, officer or representative was issued, and (d) certified copy of latest published financial statement of assets and liabilities of Surety.

\*\*\*\*\*

Affix Acknowledgments and Justification of Sureties.



# SURETY ACKNOWLEDGEMENT

State of **New Jersey**

SS:

County of **Essex**

On this **5th** day of **December, 2017**, before me personally comes **Michael Culnen** to me known, who, being by me duly sworn, deposes and says that he resides in **Mendham Township, NJ** that he is the Attorney-In-Fact of the **Philadelphia Indemnity Insurance Company** the Corporation described in and which executed the foregoing instrument; that he knows that seal of said corporation; that the seal affixed to the said instrument is such Corporate seal; that it was so affixed by the order of the Board of Directors of the said Corporation, and that he signed his name thereto by like order.

**CATHY M KNOKE**  
NOTARY PUBLIC  
STATE OF NEW JERSEY  
ID # 50009608  
MY COMMISSION EXPIRES FEB. 4. 2020

  
(Signature and Title of Official Taking Acknowledgement)

CATHY M KNOKE

NOTARY PUBLIC  
STATE OF NEW JERSEY  
IN W. JERSEY

0000

7M

PHILADELPHIA INDEMNITY INSURANCE COMPANY  
One Bala Plaza, Suite 100  
Bala Cynwyd, PA 19004-0950

Power of Attorney

KNOW ALL PERSONS BY THESE PRESENTS: That PHILADELPHIA INDEMNITY INSURANCE COMPANY (the Company), a corporation organized and existing under the laws of the Commonwealth of Pennsylvania, does hereby constitute and appoint Michael Culnen and Pamela B. Lipkin-Sauertig of USI Insurance Services, LLC, its true and lawful Attorney-in-fact with full authority to execute on its behalf bonds, undertakings, recognizances and other contracts of indemnity and writings obligatory in the nature thereof, issued in the course of its business and to bind the Company thereby, in an amount not to exceed \$25,000,000.00.

This Power of Attorney is granted and is signed and sealed by facsimile under and by the authority of the following Resolution adopted by the Board of Directors of PHILADELPHIA INDEMNITY INSURANCE COMPANY on the 14<sup>th</sup> of November, 2016.

**RESOLVED:** That the Board of Directors hereby authorizes the President or any Vice President of the Company: (1) Appoint Attorney(s) in Fact and authorize the Attorney(s) in Fact to execute on behalf of the Company bonds and undertakings, contracts of indemnity and other writings obligatory in the nature thereof and to attach the seal of the Company thereto; and (2) to remove, at any time, any such Attorney-in-Fact and revoke the authority given. And, be it

**FURTHER RESOLVED:** That the signatures of such officers and the seal of the Company may be affixed to any such Power of Attorney or certificate relating thereto by facsimile, and any such Power of Attorney so executed and certified by facsimile signatures and facsimile seal shall be valid and binding upon the Company in the future with respect to any bond or undertaking to which it is attached.

IN TESTIMONY WHEREOF, PHILADELPHIA INDEMNITY INSURANCE COMPANY HAS CAUSED THIS INSTRUMENT TO BE SIGNED AND ITS CORPORATE SEAL TO BE AFFIXED BY ITS AUTHORIZED OFFICE THIS 14<sup>TH</sup> DAY OF NOVEMBER, 2016.



Robert D. O'Leary Jr., President & CEO  
Philadelphia Indemnity Insurance Company

On this 14<sup>th</sup> day of November, 2016, before me came the individual who executed the preceding instrument, to me personally known, and being by me duly sworn said that he is the therein described and authorized officer of the PHILADELPHIA INDEMNITY INSURANCE COMPANY; that the seal affixed to said instrument is the Corporate seal of said Company; that the said Corporate Seal and his signature were duly affixed.



Notary Public: Nora Howard  
residing at: Bala Cynwyd, PA  
My commission expires: January 8, 2018

(Notary Seal)

I, Edward Sayago, Corporate Secretary of PHILADELPHIA INDEMNITY INSURANCE COMPANY, do hereby certify that the foregoing resolution of the Board of Directors and this Power of Attorney issued pursuant thereto on this 14<sup>th</sup> day of November, 2016 are true and correct and are still in full force and effect. I do further certify that Robert D. O'Leary Jr., who executed the Power of Attorney as President, was on the date of execution of the attached Power of Attorney the duly elected President of PHILADELPHIA INDEMNITY INSURANCE COMPANY,

In Testimony Whereof I have subscribed my name and affixed the facsimile seal of each Company this 5<sup>th</sup> day of December, 2017.

  
Edward Sayago, Corporate Secretary  
PHILADELPHIA INDEMNITY INSURANCE COMPANY





**PHILADELPHIA INDEMNITY INSURANCE COMPANY**

**Statutory Statements of Admitted Assets, Liabilities and Capital and Surplus  
(in thousands, except par value and share amounts)**

<u>Admitted Assets</u>	As of December 31,	
	2016	2015
Bonds (fair value \$6,366,973 and \$6,007,876)	\$ 6,256,540	\$ 5,821,420
Preferred stocks (fair value \$61,596 and \$64,498)	60,425	62,617
Common stocks (cost \$73,723 and \$104,587)	71,273	88,259
Mortgage loans	358,530	154,042
Real estate	3,518	-
Other invested assets (cost \$210,393 and \$194,804)	216,318	196,159
Receivables for securities	2,527	-
Derivatives	-	185
Cash, cash equivalents and short-term investments	44,778	32,936
Cash and invested assets	<u>7,013,909</u>	<u>6,355,618</u>
Premiums receivable, agents' balances and other receivables	781,505	734,983
Reinsurance receivable on paid losses	23,669	25,869
Accrued investment income	77,957	67,892
Receivable from affiliates	5,883	393
Net deferred tax asset	177,984	174,553
Other assets	93	2,200
Total admitted assets	<u>\$ 8,081,000</u>	<u>\$ 7,361,508</u>

Liabilities and Capital and Surplus

Liabilities:

Net unpaid losses and loss adjustment expenses	\$ 3,856,578	\$ 3,514,230
Net unearned premiums	1,449,732	1,342,996
Reinsurance payable on paid loss and loss adjustment expenses	13,357	11,618
Ceded reinsurance premiums payable	72,331	63,634
Commissions payable, contingent commissions and other similar charges	249,225	240,901
Federal income taxes payable	13,273	11,612
Accrued expenses and other liabilities	92,865	36,426
Payable to affiliates	12,467	11,824
Provision for reinsurance	642	554
Payable for purchased securities	49,033	80,193
Total liabilities	<u>\$ 5,809,503</u>	<u>\$ 5,313,988</u>

Capital:

Common stock, par value of \$10 per share; 1,000,000 shares authorized, 450,000 shares issued and outstanding	4,500	4,500
---	-------	-------

Surplus:

Gross paid-in and contributed surplus	386,071	386,071
Unassigned surplus	<u>1,880,926</u>	<u>1,656,949</u>
Total surplus	<u>2,266,997</u>	<u>2,043,020</u>
Total capital and surplus	<u>2,271,497</u>	<u>2,047,520</u>
Total liabilities and capital and surplus	<u>\$ 8,081,000</u>	<u>\$ 7,361,508</u>

The undersigned, being duly sworn, says: That she is the Executive Vice President and Chief Financial Officer of Philadelphia Indemnity Insurance Company; that said Company is a corporation duly organized in the state of Pennsylvania, and licensed and engaged in the State of Pennsylvania and has duly complied with all the requirements of the laws of the said State applicable of the said Company and is duly qualified to act as Surety under such laws; that said Company has also complied with and is duly qualified to act as Surety under the Act of Congress. And that to the best of her knowledge and belief the above statement is a full, true and correct statement of

Attest:

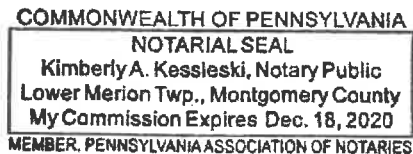

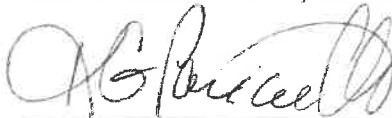
  
 Karen Gilmer-Pauciello, EVP & CFO

  
 Kimberly Kessleski, Notary

Sworn to before me this 2nd day of June 2017.



**Payment Bond (Pages 86 to 89): Use for any contract for which a Payment Bond is required.**

Bond No. PB11727800077

PAYMENT BOND (Page 1)

**PAYMENT BOND**

KNOW ALL PERSONS BY THESE PRESENTS, That we, \_\_\_\_\_

NY Asphalt, Inc.

366 Industrial Loop

Staten Island, NY 10309

hereinafter referred to as the "Principal", and \_\_\_\_\_

Philadelphia Indemnity Insurance Company

One Bala Plaza, Suite 100

Bala Cynwyd, PA 19004

hereinafter referred to as the "Surety" ("Sureties") are held and firmly bound to THE CITY OF NEW YORK, hereinafter referred to as the "City" or to its successors and assigns, in the penal sum of

Thirteen Million Six Hundred Thirty Nine Thousand Five Hundred Eighty Seven

Dollars and Zero Cents

(\$ 13,639,587.00 ) Dollars, lawful money of the United States, for the payment of which said sum of money well and truly to be made, we, and each of us, bind ourselves, our heirs, executors, administrators, successors and assigns, jointly and severally, firmly by these presents.

WHEREAS, the Principal is about to enter, or has entered, into a Contract in writing with the City for

FMS ID: SANDHW11; E-PIN: 85017B0031001; DDC PIN: 8502017HW0001C Reconstruction of

Beach Channel Drive Between Beach 116th Street and 124th Street - Borough of Queens

a copy of which Contract is annexed to and hereby made a part of this bond as though herein set forth in full;

NOW, THEREFORE, the conditions of this obligation are such that if the Principal, his or its representatives or assigns and other Subcontractors to whom Work under this Contract is sublet and his or their successors and assigns shall promptly pay or cause to be paid all lawful claims for

(a) Wages and compensation for labor performed and services rendered by all persons engaged in the prosecution of the Work under said Contract, and any amendment or extension thereof or addition thereto, whether such persons be agents servants or employees of the Principal or any such Subcontractor, including all persons so engaged who perform the work of laborers or mechanics at or in the vicinity of the site



**Payment Bond (Pages 86 to 89): Use for any contract for which a Payment Bond is required.**

PAYMENT BOND (Page 2)

of the Project regardless of any contractual relationship between the Principal or such Subcontractors, or his or their successors or assigns, on the one hand and such laborers or mechanics on the other, but not including office employees not regularly stationed at the site of the project; and

(b) Materials and supplies (whether incorporated in the permanent structure or not), as well as teams, fuels, oils, implements or machinery furnished, used or consumed by said Principal or any subcontractor at or in the vicinity of the site of the Project in the prosecution of the Work under said Contract and any amendment or extension thereof or addition thereto; then this obligation shall be void, otherwise to remain in full force and effect.

This bond is subject to the following additional conditions, limitations and agreements:

(a) The Principal and Surety (Sureties) agree that this bond shall be for the benefit of any materialmen or laborer having a just claim, as well as the City itself.

(b) All persons who have performed labor, rendered services or furnished materials and supplies, as aforesaid, shall have a direct right of action against the Principal and his, its or their successors and assigns, and the Surety (Sureties) herein, or against either or both or any of them and their successors and assigns. Such persons may sue in their own name, and may prosecute the suit to judgment and execution without the necessity of joining with any other persons as party plaintiff.

(c) The Principal and Surety (Sureties) agree that neither of them will hold the City liable for any judgment for costs of otherwise, obtained by either or both of them against a laborer or materialman in a suit brought by either a laborer or materialman under this bond for moneys allegedly due for performing work or furnishing material.

(d) The Surety (Sureties) or its successors and assigns shall not be liable for any compensation recoverable by an employee or laborer under the Workmen's Compensation Law.

(e) In no event shall the Surety (Sureties), or its successors or assigns, be liable for a greater sum than the penalty of this bond or be subject to any suit, action or proceeding hereon that is instituted by any person, firm, or corporation hereunder later than two years after the complete performance of said Contract and final settlement thereof.

The Principal, for himself and his successors and assigns, and the Surety (Sureties), for itself and its successors and assigns, do hereby expressly waive any objection that might be interposed as to the right of the City to require a bond containing the foregoing provisions, and they do hereby further expressly waive any defense which they or either of them might interpose to an action brought hereon by any person, firm or corporation, including subcontractors, materialmen and third persons, for work, labor, services, supplies or material performed rendered, or furnished as aforesaid upon the ground that there is no law authorizing the City to require the foregoing provisions to be place in this bond.

And the Surety (Sureties), for value received, for itself and its successors and assigns, hereby stipulates and agrees that the obligation of said Surety (Sureties), and its bonds shall be in no way impaired or affected by any extension of time, modification, omission, addition, or change in or of the said Contract or the work to be performed thereunder, or by any payment thereunder before the time required therein, or by any waiver of any provisions thereof, or by any assignment, subletting or other transfer thereof or of any part thereof, or of any Work to be performed, or any moneys due to become due thereunder and said Surety (Sureties) does hereby waive notice of any and all of such extensions, modifications, omissions, additions, changes, payments, waivers, assignments, subcontracts and transfers, and hereby expressly stipulates and agrees that any and all things done and omitted to be done by and in relation to assignees, Subcontractors, and other transferees shall have the same effect as to said Surety (Sureties) as though done or omitted to be done or in relation to said Principal.



**Payment Bond (Pages 86 to 89): Use for any contract for which a Payment Bond is required.**

**PAYMENT BOND (Page 3)**

IN WITNESS WHEREOF, the Principal and the Surety (Sureties) have hereunto set their hands and seals, and such of them as are corporations have caused their corporate seals to be hereunto affixed and these presents to be signed by their proper officers, this 5th day of December, 2017.

(Seal) NY Asphalt, Inc. (L.S.)  
Principal  
By: 

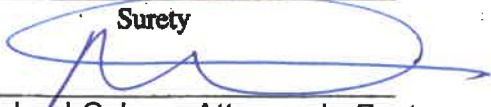
(Seal) Philadelphia Indemnity Insurance Company  
Surety  
By:   
Michael Culnen, Attorney-in-Fact

(Seal) \_\_\_\_\_  
Surety  
By: \_\_\_\_\_

(Seal) \_\_\_\_\_  
Surety  
By: \_\_\_\_\_

(Seal) \_\_\_\_\_  
Surety  
By: \_\_\_\_\_

If the Contractor (Principal) is a partnership, the bond should be signed by each of the individuals who are partners.

If the Contractor (Principal) is a corporation, the bond should be signed in its correct corporate name by a duly authorized officer, agent, or attorney-in-fact.

There should be executed an appropriate number of counterparts of the bond corresponding to the number of counterparts of the Contract.





**Payment Bond (Pages 86 to 89): Use for any contract for which a Payment Bond is required.**

PAYMENT BOND (Page 4)

**ACKNOWLEDGMENT OF PRINCIPAL, IF A CORPORATION**

State of New York County of Richmond ss:

On this 8<sup>th</sup> day of Dec, 2017, before me personally came Michael Thompson to me known, who, being by me duly sworn did depose and say that he resides at Colts Neck, NJ that he is the president of the corporation described in and which executed the foregoing instrument; that he knows the seal of said corporation; that one of the seals affixed to said instrument is such seal; that it was so affixed by order of the directors of said corporation, and that he signed his name thereto by like order.

Michele Renna  
Notary Public or Commissioner of Deeds

MICHELE RENNA  
NOTARY PUBLIC STATE OF NEW YORK  
No. 01RE6110285  
Qualified in Richmond County  
My Commission Expires May 24, 2020

**ACKNOWLEDGMENT OF PRINCIPAL, IF A PARTNERSHIP**

State of \_\_\_\_\_ County of \_\_\_\_\_ ss:

On this \_\_\_\_\_ day of \_\_\_\_\_, \_\_\_\_\_, before me personally appeared \_\_\_\_\_ to me known, and known to me to be one of the members of the firm of \_\_\_\_\_ described in and who executed the foregoing instrument; and he acknowledged to me that he executed the same as and for the act and deed of said firm.

\_\_\_\_\_  
Notary Public or Commissioner of Deeds

**ACKNOWLEDGMENT OF PRINCIPAL, IF AN INDIVIDUAL**

State of \_\_\_\_\_ County of \_\_\_\_\_ ss:

On this \_\_\_\_\_ day of \_\_\_\_\_, \_\_\_\_\_, before me personally appeared \_\_\_\_\_ to me known, and known to me to be the person described in and who executed the foregoing instrument; and acknowledged that he executed the same.

\_\_\_\_\_  
Notary Public or Commissioner of Deeds

Each executed bond should be accompanied by: (a) appropriate acknowledgments of the respective parties; (b) appropriate duly certified copy of Power of Attorney or other certificate of authority where bond is executed by agent, officer or other representative of Principal or Surety; (c) a duly certified extract from By-Laws or resolutions of Surety under which Power of Attorney or other certificate of authority of its agent, officer or representative was issued, and (d) certified copy of latest published financial statement of assets and liabilities of Surety.

\*\*\*\*\*

Affix Acknowledgments and Justification of Sureties.



# SURETY ACKNOWLEDGEMENT

State of **New Jersey**

SS:

County of **Essex**

On this **5th** day of **December, 2017**, before me personally comes **Michael Culnen** to me known, who, being by me duly sworn, deposes and says that he resides in **Mendham Township, NJ** that he is the Attorney-In-Fact of the **Philadelphia Indemnity Insurance Company** the Corporation described in and which executed the foregoing instrument; that he knows that seal of said corporation; that the seal affixed to the said instrument is such Corporate seal; that it was so affixed by the order of the Board of Directors of the said Corporation, and that he signed his name thereto by like order.

**CATHY M KNOKE**  
NOTARY PUBLIC  
STATE OF NEW JERSEY  
ID # 50009608  
MY COMMISSION EXPIRES FEB. 4, 2020

  
\_\_\_\_\_  
(Signature and Title of Official Taking Acknowledgement)

WILSON  
CATHY M. WILSON  
NOTARY PUBLIC  
STATE OF CALIFORNIA  
My Comm. Expires FEB 4 2020

**PHILADELPHIA INDEMNITY INSURANCE COMPANY**  
One Bala Plaza, Suite 100  
Bala Cynwyd, PA 19004-0950

**Power of Attorney**

KNOW ALL PERSONS BY THESE PRESENTS: That **PHILADELPHIA INDEMNITY INSURANCE COMPANY** (the Company), a corporation organized and existing under the laws of the Commonwealth of Pennsylvania, does hereby constitute and appoint **Michael Culnen and Pamela B. Lipkin-Sauertig of USI Insurance Services, LLC**, its true and lawful Attorney-in-fact with full authority to execute on its behalf bonds, undertakings, recognizances and other contracts of indemnity and writings obligatory in the nature thereof, issued in the course of its business and to bind the Company thereby, in an amount not to exceed **\$25,000,000.00**.

This Power of Attorney is granted and is signed and sealed by facsimile under and by the authority of the following Resolution adopted by the Board of Directors of PHILADELPHIA INDEMNITY INSURANCE COMPANY on the 14<sup>th</sup> of November, 2016.

**RESOLVED:** That the Board of Directors hereby authorizes the President or any Vice President of the Company: (1) Appoint Attorney(s) in Fact and authorize the Attorney(s) in Fact to execute on behalf of the Company bonds and undertakings, contracts of indemnity and other writings obligatory in the nature thereof and to attach the seal of the Company thereto; and (2) to remove, at any time, any such Attorney-in-Fact and revoke the authority given. And, be it

**FURTHER RESOLVED:** That the signatures of such officers and the seal of the Company may be affixed to any such Power of Attorney or certificate relating thereto by facsimile, and any such Power of Attorney so executed and certified by facsimile signatures and facsimile seal shall be valid and binding upon the Company in the future with respect to any bond or undertaking to which it is attached.

IN TESTIMONY WHEREOF, PHILADELPHIA INDEMNITY INSURANCE COMPANY HAS CAUSED THIS INSTRUMENT TO BE SIGNED AND ITS CORPORATE SEAL TO BE AFFIXED BY ITS AUTHORIZED OFFICE THIS 14<sup>TH</sup> DAY OF NOVEMBER, 2016.



Robert D. O'Leary Jr., President & CEO  
Philadelphia Indemnity Insurance Company

On this 14<sup>th</sup> day of November, 2016, before me came the individual who executed the preceding instrument, to me personally known, and being by me duly sworn said that he is the therein described and authorized officer of the **PHILADELPHIA INDEMNITY INSURANCE COMPANY**; that the seal affixed to said instrument is the Corporate seal of said Company; that the said Corporate Seal and his signature were duly affixed.

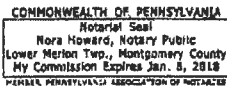

Notary Public: Nora Howard  
residing at: Bala Cynwyd, PA  
My commission expires: January 8, 2018

(Notary Seal)

I, Edward Sayago, Corporate Secretary of PHILADELPHIA INDEMNITY INSURANCE COMPANY, do hereby certify that the foregoing resolution of the Board of Directors and this Power of Attorney issued pursuant thereto on this 14<sup>th</sup> day of November, 2016 are true and correct and are still in full force and effect. I do further certify that Robert D. O'Leary Jr., who executed the Power of Attorney as President, was on the date of execution of the attached Power of Attorney the duly elected President of PHILADELPHIA INDEMNITY INSURANCE COMPANY,

In Testimony Whereof I have subscribed my name and affixed the facsimile seal of each Company this **5th** day of **December**, 20 **17**



Edward Sayago, Corporate Secretary  
PHILADELPHIA INDEMNITY INSURANCE COMPANY



**PHILADELPHIA INDEMNITY INSURANCE COMPANY**

**Statutory Statements of Admitted Assets, Liabilities and Capital and Surplus  
(in thousands, except par value and share amounts)**

<u>Admitted Assets</u>	As of December 31,	
	2016	2015
Bonds (fair value \$6,366,973 and \$6,007,876)	\$ 6,256,540	\$ 5,821,420
Preferred stocks (fair value \$61,596 and \$64,498)	60,425	62,617
Common stocks (cost \$73,723 and \$104,587)	71,273	88,259
Mortgage loans	358,530	154,042
Real estate	3,518	-
Other invested assets (cost \$210,393 and \$194,804)	216,318	196,159
Receivables for securities	2,527	-
Derivatives	-	185
Cash, cash equivalents and short-term investments	44,778	32,936
Cash and invested assets	<u>7,013,909</u>	<u>6,355,618</u>
Premiums receivable, agents' balances and other receivables	781,505	734,983
Reinsurance receivable on paid losses	23,669	25,869
Accrued investment income	77,957	67,892
Receivable from affiliates	5,883	393
Net deferred tax asset	177,984	174,553
Other assets	93	2,200
Total admitted assets	<u>\$ 8,081,000</u>	<u>\$ 7,361,508</u>
 <u>Liabilities and Capital and Surplus</u>		
Liabilities:		
Net unpaid losses and loss adjustment expenses	\$ 3,856,578	\$ 3,514,230
Net unearned premiums	1,449,732	1,342,996
Reinsurance payable on paid loss and loss adjustment expenses	13,357	11,618
Ceded reinsurance premiums payable	72,331	63,634
Commissions payable, contingent commissions and other similar charges	249,225	240,901
Federal income taxes payable	13,273	11,612
Accrued expenses and other liabilities	92,865	36,426
Payable to affiliates	12,467	11,824
Provision for reinsurance	642	554
Payable for purchased securities	49,033	80,193
Total liabilities	<u>\$ 5,809,503</u>	<u>\$ 5,313,988</u>
Capital:		
Common stock, par value of \$10 per share; 1,000,000 shares authorized, 450,000 shares issued and outstanding	4,500	4,500
Surplus:		
Gross paid-in and contributed surplus	386,071	386,071
Unassigned surplus	<u>1,880,926</u>	<u>1,656,949</u>
Total surplus	<u>2,266,997</u>	<u>2,043,020</u>
Total capital and surplus	<u>2,271,497</u>	<u>2,047,520</u>
Total liabilities and capital and surplus	<u>\$ 8,081,000</u>	<u>\$ 7,361,508</u>

The undersigned, being duly sworn, says: That she is the Executive Vice President and Chief Financial Officer of Philadelphia Indemnity Insurance Company; that said Company is a corporation duly organized in the state of Pennsylvania, and licensed and engaged in the State of Pennsylvania and has duly complied with all the requirements of the laws of the said State applicable of the said Company and is duly qualified to act as Surety under such laws; that said Company has also complied with and is duly qualified to act as Surety under the Act of Congress. And that to the best of her knowledge and belief the above statement is a full, true and correct statement of

Attest:

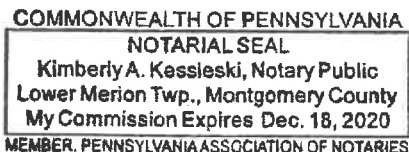

*[Signature]*  
 Karen Gilmer-Pauciello, EVP & CFO

*[Signature]*  
 Kimberly Kessleski, Notary

Sworn to before me this 2nd day of June 2017.



**CERTIFICATE OF LIABILITY INSURANCE**

DATE (MM/DD/YYYY)  
11/16/2017

THIS CERTIFICATE IS ISSUED AS A MATTER OF INFORMATION ONLY AND CONFERS NO RIGHTS UPON THE CERTIFICATE HOLDER. THIS CERTIFICATE DOES NOT AFFIRMATIVELY OR NEGATIVELY AMEND, EXTEND OR ALTER THE COVERAGE AFFORDED BY THE POLICIES BELOW. THIS CERTIFICATE OF INSURANCE DOES NOT CONSTITUTE A CONTRACT BETWEEN THE ISSUING INSURER(S), AUTHORIZED REPRESENTATIVE OR PRODUCER, AND THE CERTIFICATE HOLDER.

**IMPORTANT:** If the certificate holder is an **ADDITIONAL INSURED**, the policy(ies) must be endorsed. If **SUBROGATION IS WAIVED**, subject to the terms and conditions of the policy, certain policies may require an endorsement. A statement on this certificate does not confer rights to the certificate holder in lieu of such endorsement(s).

<b>PRODUCER</b> USI Insurance Svcs - KORE CL 300 Executive Drive West Orange, NJ 07052 973 965-3100	<b>CONTACT NAME:</b> Corynne Albertson <b>PHONE (A/C, No, Ext):</b> 973 965-3165 <b>E-MAIL ADDRESS:</b> corynne.albertson@usi.com	<b>FAX (A/C, No):</b> 610 537-4508
	<b>INSURER(S) AFFORDING COVERAGE</b>	
<b>INSURED</b> NY Asphalt Inc. 366 Industrial Loop Staten Island, NY 10309	<b>INSURER A :</b> Travelers Indemnity Co. of Amer	<b>NAIC #</b> 25666
	<b>INSURER B :</b> Travelers Property Cas. Co. of	25674
	<b>INSURER C :</b> Navigators Insurance Company	42307
	<b>INSURER D :</b> State Insurance Fund of NY	36102
	<b>INSURER E :</b> Shelterpointe Life Insurance	89958
	<b>INSURER F :</b> American Guarantee Insurance Co	35521

**COVERAGES**                      **CERTIFICATE NUMBER:**                      **REVISION NUMBER:**

THIS IS TO CERTIFY THAT THE POLICIES OF INSURANCE LISTED BELOW HAVE BEEN ISSUED TO THE INSURED NAMED ABOVE FOR THE POLICY PERIOD INDICATED. NOTWITHSTANDING ANY REQUIREMENT, TERM OR CONDITION OF ANY CONTRACT OR OTHER DOCUMENT WITH RESPECT TO WHICH THIS CERTIFICATE MAY BE ISSUED OR MAY PERTAIN, THE INSURANCE AFFORDED BY THE POLICIES DESCRIBED HEREIN IS SUBJECT TO ALL THE TERMS, EXCLUSIONS AND CONDITIONS OF SUCH POLICIES. LIMITS SHOWN MAY HAVE BEEN REDUCED BY PAID CLAIMS.

INSR LTR	TYPE OF INSURANCE	ADDL INSR	SUBR WVD	POLICY NUMBER	POLICY EFF (MM/DD/YYYY)	POLICY EXP (MM/DD/YYYY)	LIMITS
A	<input checked="" type="checkbox"/> <b>COMMERCIAL GENERAL LIABILITY</b> <input type="checkbox"/> CLAIMS-MADE <input checked="" type="checkbox"/> OCCUR  GEN'L AGGREGATE LIMIT APPLIES PER: <input type="checkbox"/> POLICY <input checked="" type="checkbox"/> PRO-JECT <input type="checkbox"/> LOC OTHER:			DTCO4E994634IND17	03/10/2017	03/10/2018	EACH OCCURRENCE \$1,000,000 DAMAGE TO RENTED PREMISES (Ea occurrence) \$300,000 MED EXP (Any one person) \$5,000 PERSONAL & ADV INJURY \$1,000,000 GENERAL AGGREGATE \$2,000,000 PRODUCTS - COMP/OP AGG \$2,000,000 \$
A	<b>AUTOMOBILE LIABILITY</b> <input checked="" type="checkbox"/> ANY AUTO <input type="checkbox"/> ALL OWNED AUTOS <input type="checkbox"/> SCHEDULED AUTOS <input checked="" type="checkbox"/> HIRED AUTOS <input checked="" type="checkbox"/> NON-OWNED AUTOS			DT8104E994634IND17	03/10/2017	03/10/2018	COMBINED SINGLE LIMIT (Ea accident) \$1,000,000 BODILY INJURY (Per person) \$ BODILY INJURY (Per accident) \$ PROPERTY DAMAGE (Per accident) \$ \$
A F	<input checked="" type="checkbox"/> <b>UMBRELLA LIAB</b> <input checked="" type="checkbox"/> OCCUR <input type="checkbox"/> EXCESS LIAB <input type="checkbox"/> CLAIMS-MADE DED <input checked="" type="checkbox"/> RETENTION \$10000			DTSMCUP2J342760IND AEC019100601	03/10/2017 03/10/2017	03/10/2018 03/10/2018	EACH OCCURRENCE \$15,000,000 AGGREGATE \$15,000,000 \$
B D	<b>WORKERS COMPENSATION AND EMPLOYERS' LIABILITY</b> ANY PROPRIETOR/PARTNER/EXECUTIVE OFFICER/MEMBER EXCLUDED? <input type="checkbox"/> Y/N (Mandatory in NH) If yes, describe under DESCRIPTION OF OPERATIONS below		N/A	DTJUB7F31022917 23835747	03/10/2017 04/01/2017	03/10/2018 04/01/2018	<input checked="" type="checkbox"/> PER STATUTE <input type="checkbox"/> OTH-ER E.L. EACH ACCIDENT \$1,000,000 E.L. DISEASE - EA EMPLOYEE \$1,000,000 E.L. DISEASE - POLICY LIMIT \$1,000,000
C E	<b>Pollution Liab.</b> <b>NY Disability</b>			NY17ECP0BF8IUNV DBL5929055	07/10/2017 04/15/2017	03/10/2018 Continuous	\$2MM Occ / \$4MM Agg Statutory Limits

DESCRIPTION OF OPERATIONS / LOCATIONS / VEHICLES (ACORD 101, Additional Remarks Schedule, may be attached if more space is required)  
**RE: FMS ID #SANDHW11, E-PIN #85017B0031001, DOC PIN #8502017HW0001C, Reconstruction of Beach, Channel Drive Between Beach, 116th Street and 124th Street - Borough of Queens.**  
 The General Liability, Automobile Liability and Umbrella Liability policy includes an automatic Additional Insured endorsement that provides Additional Insured status to the Certificate Holder, City of New York, including its officials and employees, all persons or organizations, Engineer, Architect, Project Manager, (See Attached Descriptions)

<b>CERTIFICATE HOLDER</b>  Department of Design and Construction 30 - 30 Thomson Ave. Long Island City, NY 11101	<b>CANCELLATION</b>  SHOULD ANY OF THE ABOVE DESCRIBED POLICIES BE CANCELLED BEFORE THE EXPIRATION DATE THEREOF, NOTICE WILL BE DELIVERED IN ACCORDANCE WITH THE POLICY PROVISIONS.  AUTHORIZED REPRESENTATIVE 
--	--

## DESCRIPTIONS (Continued from Page 1)

Resident Engineer, etc., Federal Highway Administration (FHWA) including its officials and employees and National Grid, only when there is a written contract that requires such status, and only with regard to work performed on behalf of the named insured.

THIS ENDORSEMENT CHANGES THE POLICY. PLEASE READ IT CAREFULLY

## BLANKET ADDITIONAL INSURED (CONTRACTORS)

This endorsement modifies insurance provided under the following:

### COMMERCIAL GENERAL LIABILITY COVERAGE PART

1. WHO IS AN INSURED – (Section II) is amended to include any person or organization that you agree in a "written contract requiring insurance" to include as an additional insured on this Coverage Part, but:
  - a) Only with respect to liability for "bodily injury", "property damage" or "personal injury"; and
  - b) If, and only to the extent that, the injury or damage is caused by acts or omissions of you or your subcontractor in the performance of "your work" to which the "written contract requiring insurance" applies. The person or organization does not qualify as an additional insured with respect to the independent acts or omissions of such person or organization.
  - c) The insurance provided to the additional insured does not apply to "bodily injury" or "property damage" caused by "your work" and included in the "products-completed operations hazard" unless the "written contract requiring insurance" specifically requires you to provide such coverage for that additional insured, and then the insurance provided to the additional insured applies only to such "bodily injury" or "property damage" that occurs before the end of the period of time for which the "written contract requiring insurance" requires you to provide such coverage or the end of the policy period, whichever is earlier.
2. The insurance provided to the additional insured by this endorsement is limited as follows:
  - a) In the event that the Limits of Insurance of this Coverage Part shown in the Declarations exceed the limits of liability required by the "written contract requiring insurance", the insurance provided to the additional insured shall be limited to the limits of liability required by that "written contract requiring insurance". This endorsement shall not increase the limits of insurance described in Section III – Limits Of Insurance.
  - b) The insurance provided to the additional insured does not apply to "bodily injury", "property damage" or "personal injury" arising out of the rendering of, or failure to render, any professional architectural, engineering or surveying services, including:
    - I. The preparing, approving, or failing to prepare or approve, maps, shop drawings, opinions, reports, surveys, field orders or change orders, or the preparing, approving, or failing to prepare or approve, drawings and specifications; and
    - II. Supervisory, inspection, architectural or engineering activities.
3. The insurance provided to the additional insured by this endorsement is excess over any valid and collectible "other insurance", whether primary, excess, contingent or on any other basis, that is available to the additional insured for a loss we cover under this endorsement. However, if the "written contract requiring insurance" specifically requires that this insurance apply on a primary basis or a primary and non-contributory basis, this insurance is primary to "other insurance" available to the additional insured which covers that person or organization as a named insured for such loss, and we will not share with that "other insurance". But the insurance provided to the additional insured by this endorsement still is excess over any valid and collectible "other insurance", whether primary, excess, contingent or on any other basis, that is available to the additional insured when that person or organization is an additional insured under such "other insurance".
4. As a condition of coverage provided to the additional insured by this endorsement:
  - a) The additional insured must give us written notice as soon as practicable of an "occurrence" or an offense which may result in a claim. To the extent possible, such notice should include:

Policy Number: DT-8104-E994634-IND-16

COMMERCIAL GENERAL LIABILITY

- i. How, when and where the "occurrence" or offense took place;
  - ii. The names and addresses of any injured persons and witnesses; and
  - iii. The nature and location of any injury or damage arising out of the "occurrence" or offense.
- b) If a claim is made or "suit" is brought against the additional insured, the additional insured must:
- i. Immediately record the specifics of the claim or "suit" and the date received; and
  - ii. Notify us as soon as practicable.
- The additional insured must see to it that we receive written notice of the claim or "suit" as soon as practicable.
- c) The additional insured must immediately send us copies of all legal papers received in connection with the claim or "suit", cooperate with us in the investigation or settlement of the claim or defense against the "suit", and otherwise comply with all policy conditions.
- d) The additional insured must tender the defense and indemnity of any claim or "suit" to

any provider of "other insurance" which would cover the additional insured for a loss we cover under this endorsement. However, this condition does not affect whether the insurance provided to the additional insured by this endorsement is primary to "other insurance" available to the additional insured which covers that person or organization as a named insured as described in paragraph 3. above.

5. The following definition is added to SECTION V. - DEFINITIONS:

"Written contract requiring insurance" means that part of any written contract or agreement under which you are required to include a person or organization as an additional insured on this Coverage Part, provided that the "bodily injury" and "property damage" occurs and the "personal injury" is caused by an offense committed:

- a. After the signing and execution of the contract or agreement by you;
- b. While that part of the contract or agreement is in effect; and
- c. Before the end of the policy period.

**THIS ENDORSEMENT CHANGES THE POLICY. PLEASE READ IT CAREFULLY.**

## **CONTRACTORS XTEND ENDORSEMENT**

This endorsement modifies insurance provided under the following:

### **COMMERCIAL GENERAL LIABILITY COVERAGE PART**

**GENERAL DESCRIPTION OF COVERAGE** – This endorsement broadens coverage. However, coverage for any injury, damage or medical expenses described in any of the provisions of this endorsement may be excluded or limited by another endorsement to this Coverage Part, and these coverage broadening provisions do not apply to the extent that coverage is excluded or limited by such an endorsement. The following listing is a general coverage description only. Limitations and exclusions may apply to these coverages. Read all the provisions of this endorsement and the rest of your policy carefully to determine rights, duties, and what is and is not covered.

- |   |  |
|---|--|
| A. Aircraft Chartered With Pilot  | H. Blanket Additional Insured – Lessors Of Leased Equipment                |
| B. Damage To Premises Rented To You                                     | I. Blanket Additional Insured – States Or Political Subdivisions – Permits |
| C. Increased Supplementary Payments                                     | J. Knowledge And Notice Of Occurrence Or Offense                           |
| D. Incidental Medical Malpractice                                       | K. Unintentional Omission  |
| E. Who Is An Insured – Newly Acquired Or Formed Organizations           | L. Blanket Waiver Of Subrogation   |
| F. Who Is An Insured – Broadened Named Insured – Unnamed Subsidiaries   | M. Amended Bodily Injury Definition  |
| G. Blanket Additional Insured – Owners, Managers Or Lessors Of Premises | N. Contractual Liability – Railroads                                       |

### **PROVISIONS**

#### **A. AIRCRAFT CHARTERED WITH PILOT**

The following is added to Exclusion g., Aircraft, Auto Or Watercraft, in Paragraph 2. of SECTION I – COVERAGES – COVERAGE A BODILY INJURY AND PROPERTY DAMAGE LIABILITY:

This exclusion does not apply to an aircraft that is:

- (a) Chartered with a pilot to any insured;
- (b) Not owned by any insured; and
- (c) Not being used to carry any person or property for a charge.

#### **B. DAMAGE TO PREMISES RENTED TO YOU**

1. The first paragraph of the exceptions in Exclusion j., Damage To Property, in Paragraph 2. of SECTION I – COVERAGES – COVERAGE A BODILY INJURY AND PROPERTY DAMAGE LIABILITY is deleted.
2. The following replaces the last paragraph of Paragraph 2., Exclusions, of SECTION I – COVERAGES – COVERAGE A. BODILY

#### **INJURY AND PROPERTY DAMAGE LIABILITY:**

Exclusions c. and g. through n. do not apply to "premises damage". Exclusion f.(1)(a) does not apply to "premises damage" caused by:

- a. Fire;
- b. Explosion;
- c. Lightning;
- d. Smoke resulting from such fire, explosion, or lightning; or
- e. Water;

unless Exclusion f. of Section I – Coverage A – Bodily Injury And Property Damage Liability is replaced by another endorsement to this Coverage Part that has Exclusion – All Pollution Injury Or Damage or Total Pollution Exclusion in its title.

A separate limit of insurance applies to "premises damage" as described in Paragraph 6. of SECTION III – LIMITS OF INSURANCE.

COMMERCIAL GENERAL LIABILITY

3. The following replaces Paragraph 6. of SECTION III - LIMITS OF INSURANCE:

Subject to 5. above, the Damage To Premises Rented To You Limit is the most we will pay under Coverage A for damages because of "premises damage" to any one premises. The Damage To Premises Rented To You Limit will apply to all "property damage" proximately caused by the same "occurrence", whether such damage results from: fire; explosion; lightning; smoke resulting from such fire, explosion, or lightning; or water; or any combination of any of these causes.

The Damage To Premises Rented To You Limit will be:

- a. The amount shown for the Damage To Premises Rented To You Limit on the Declarations of this Coverage Part; or
- b. \$300,000 if no amount is shown for the Damage To Premises Rented To You Limit on the Declarations of this Coverage Part.

4. The following replaces Paragraph a. of the definition of "insured contract" in the DEFINITIONS Section:

- a. A contract for a lease of premises. However, that portion of the contract for a lease of premises that indemnifies any person or organization for "premises damage" is not an "insured contract";

5. The following is added to the DEFINITIONS Section:

"Premises damage" means "property damage" to:

- a. Any premises while rented to you or temporarily occupied by you with permission of the owner; or
- b. The contents of any premises while such premises is rented to you, if you rent such premises for a period of seven or fewer consecutive days.

6. The following replaces Paragraph 4.b.(1)(b) of SECTION IV - COMMERCIAL GENERAL LIABILITY CONDITIONS:

(b) That is insurance for "premises damage"; or

7. Paragraph 4.b.(1)(c) of SECTION IV - COMMERCIAL GENERAL LIABILITY CONDITIONS is deleted.

C. INCREASED SUPPLEMENTARY PAYMENTS

1. The following replaces Paragraph 1.b. of SUPPLEMENTARY PAYMENTS - COVERAGES A AND B of SECTION I - COVERAGE:

- b. Up to \$2,500 for the cost of bail bonds required because of accidents or traffic law violations arising out of the use of any vehicle to which the Bodily Injury Liability Coverage applies. We do not have to furnish these bonds.

2. The following replaces Paragraph 1.d. of SUPPLEMENTARY PAYMENTS - COVERAGES A AND B of SECTION I - COVERAGES:

- d. All reasonable expenses incurred by the Insured at our request to assist us in the investigation or defense of the claim or "suit", including actual loss of earnings up to \$500 a day because of time off from work.

D. INCIDENTAL MEDICAL MALPRACTICE

1. The following is added to the definition of "occurrence" in the DEFINITIONS Section:

"Occurrence" also means an act or omission committed in providing or failing to provide "incidental medical services", first aid or "Good Samaritan services" to a person.

2. The following is added to Paragraph 2.a.(1) of SECTION II - WHO IS AN INSURED:

Paragraph (1)(d) above does not apply to "bodily injury" arising out of providing or failing to provide:

- (i) "Incidental medical services" by any of your "employees" who is a nurse practitioner, registered nurse, licensed practical nurse, nurse assistant, emergency medical technician or paramedic; or

- (ii) First aid or "Good Samaritan services" by any of your "employees" or "volunteer workers", other than an employed or volunteer doctor. Any such "employees" or "volunteer workers" providing or failing to provide first aid or "Good Samaritan services" during their work hours for you will be deemed to be acting within the scope of their employment by you or performing duties related to the conduct of your business.

3. The following is added to Paragraph 5. of SECTION III – LIMITS OF INSURANCE:

For the purposes of determining the applicable Each Occurrence Limit, all related acts or omissions committed in providing or failing to provide "incidental medical services", first aid or "Good Samaritan services" to any one person will be deemed to be one "occurrence".

4. The following exclusion is added to Paragraph 2., Exclusions, of SECTION I – COVERAGES – COVERAGE A BODILY INJURY AND PROPERTY DAMAGE LIABILITY:

**Sale Of Pharmaceuticals**

"Bodily injury" or "property damage" arising out of the willful violation of a penal statute or ordinance relating to the sale of pharmaceuticals committed by, or with the knowledge or consent of, the insured.

5. The following is added to the DEFINITIONS Section:

"Incidental medical services" means:

- a. Medical, surgical, dental, laboratory, x-ray or nursing service or treatment, advice or instruction, or the related furnishing of food or beverages; or
- b. The furnishing or dispensing of drugs or medical, dental, or surgical supplies or appliances.

"Good Samaritan services" means any emergency medical services for which no compensation is demanded or received.

6. The following is added to Paragraph 4.b., Excess Insurance, of SECTION IV – COMMERCIAL GENERAL LIABILITY CONDITIONS:

The insurance is excess over any valid and collectible other insurance available to the insured, whether primary, excess, contingent or on any other basis, that is available to any of your "employees" or "volunteer workers" for "bodily injury" that arises out of providing or failing to provide "incidental medical services", first aid or "Good Samaritan services" to any person to the extent not subject to Paragraph 2.a.(1) of Section II – Who Is An Insured.

**E. WHO IS AN INSURED – NEWLY ACQUIRED OR FORMED ORGANIZATIONS**

The following replaces Paragraph 4. of SECTION II – WHO IS AN INSURED:

4. Any organization you newly acquire or form, other than a partnership, joint venture or limited liability company, of which you are the sole owner or in which you maintain the majority ownership interest, will qualify as a Named Insured if there is no other insurance which provides similar coverage to that organization. However:

a. Coverage under this provision is afforded only:

- (1) Until the 180th day after you acquire or form the organization or the end of the policy period, whichever is earlier, if you do not report such organization in writing to us within 180 days after you acquire or form it; or

- (2) Until the end of the policy period, when that date is later than 180 days after you acquire or form such organization, if you report such organization in writing to us within 180 days after you acquire or form it, and we agree in writing that it will continue to be a Named Insured until the end of the policy period;

- b. Coverage A does not apply to "bodily injury" or "property damage" that occurred before you acquired or formed the organization; and

- c. Coverage B does not apply to "personal injury" or "advertising injury" arising out of an offense committed before you acquired or formed the organization.

**F. WHO IS AN INSURED – BROADENED NAMED INSURED – UNNAMED SUBSIDIARIES**

The following is added to SECTION II – WHO IS AN INSURED:

Any of your subsidiaries, other than a partnership, joint venture or limited liability company, that is not shown as a Named Insured in the Declarations is a Named Insured if you maintain an ownership interest of more than 50% in such subsidiary on the first day of the policy period.

No such subsidiary is an insured for "bodily injury" or "property damage" that occurred, or "personal injury" or "advertising injury" caused by an offense committed after the date, if any, during the policy period, that you no longer maintain an ownership interest of more than 50% in such subsidiary.

COMMERCIAL GENERAL LIABILITY

**G. BLANKET ADDITIONAL INSURED - OWNERS, MANAGERS OR LESSORS OF PREMISES**

The following is added to SECTION II - WHO IS AN INSURED:

Any person or organization that is a premises owner, manager or lessor and that you have agreed in a written contract or agreement to include as an additional insured on this Coverage Part is an insured, but only with respect to liability for "bodily injury", "property damage", "personal injury" or "advertising injury" that:

- a. Is "bodily injury" or "property damage" that occurs, or is "personal injury" or "advertising injury" caused by an offense that is committed, subsequent to the execution of that contract or agreement; and
- b. Arises out of the ownership, maintenance or use of that part of any premises leased to you.

The insurance provided to such premises owner, manager or lessor is subject to the following provisions:

- a. The limits of insurance provided to such premises owner, manager or lessor will be the minimum limits which you agreed to provide in the written contract or agreement, or the limits shown on the Declarations, whichever are less.
- b. The insurance provided to such premises owner, manager or lessor does not apply to:
  - (1) Any "bodily injury" or "property damage" that occurs, or "personal injury" or "advertising injury" caused by an offense that is committed, after you cease to be a tenant in that premises; or
  - (2) Structural alterations, new construction or demolition operations performed by or on behalf of such premises owner, lessor or manager.
- c. The insurance provided to such premises owner, manager or lessor is excess over any valid and collectible other insurance available to such premises owner, manager or lessor, whether primary, excess, contingent or on any other basis, unless you have agreed in the written contract or agreement that this insurance must be primary to, or non-contributory with, such other insurance, in which case this insurance will be primary to, and non-contributory with, such other insurance.

**H. BLANKET ADDITIONAL INSURED - LESSORS OF LEASED EQUIPMENT**

The following is added to SECTION II - WHO IS AN INSURED:

Any person or organization that is an equipment lessor and that you have agreed in a written contract or agreement to include as an insured on this Coverage Part is an insured, but only with respect to liability for "bodily injury", "property damage", "personal injury" or "advertising injury" that:

- a. Is "bodily injury" or "property damage" that occurs, or is "personal injury" or "advertising injury" caused by an offense that is committed, subsequent to the execution of that contract or agreement; and
- b. Is caused, in whole or in part, by your acts or omissions in the maintenance, operation or use of equipment leased to you by such equipment lessor.

The insurance provided to such equipment lessor is subject to the following provisions:

- a. The limits of insurance provided to such equipment lessor will be the minimum limits which you agreed to provide in the written contract or agreement, or the limits shown on the Declarations, whichever are less.
  - b. The insurance provided to such equipment lessor does not apply to any "bodily injury" or "property damage" that occurs, or "personal injury" or "advertising injury" caused by an offense that is committed, after the equipment lease expires.
  - c. The insurance provided to such equipment lessor is excess over any valid and collectible other insurance available to such equipment lessor, whether primary, excess, contingent or on any other basis, unless you have agreed in the written contract or agreement that this insurance must be primary to, or non-contributory with, such other insurance, in which case this insurance will be primary to, and non-contributory with, such other insurance.
- I. BLANKET ADDITIONAL INSURED - STATES OR POLITICAL SUBDIVISIONS - PERMITS**

The following is added to SECTION II - WHO IS AN INSURED:

Any state or political subdivision that has issued a permit in connection with operations performed by you or on your behalf and that you are required





# New York State Insurance Fund

Workers' Compensation & Disability Benefits Specialists Since 1914

199 CHURCH STREET, NEW YORK, N.Y. 10007-1100

## CERTIFICATE OF WORKERS' COMPENSATION INSURANCE (RENEWED)

\*\*\*\*\* 134110973  
LOVELL SAFETY MGMT CO., LLC  
110 WILLIAM STREET 12TH FLR  
NEW YORK NY 10038



Scan to Validate

<b>POLICYHOLDER</b> NY ASPHALT INC 366 INDUSTRIAL LOOP STATEN ISLAND NY 10309	<b>CERTIFICATE HOLDER</b> NEW YORK CITY DEPARTMENT OF DESIGN & CONSTRUCTION (DDC) 30-30 THOMSON AVE, 4TH FLOOR LONG ISLAND CITY NY 11101
--	--

<b>POLICY NUMBER</b> G2383 574-7	<b>CERTIFICATE NUMBER</b> 137197	<b>POLICY PERIOD</b> 04/01/2017 TO 04/01/2018	<b>DATE</b> 3/9/2017
-------------------------------------	-------------------------------------	--	-------------------------

THIS IS TO CERTIFY THAT THE POLICYHOLDER NAMED ABOVE IS INSURED WITH THE NEW YORK STATE INSURANCE FUND UNDER POLICY NO. 2383 574-7, COVERING THE ENTIRE OBLIGATION OF THIS POLICYHOLDER FOR WORKERS' COMPENSATION UNDER THE NEW YORK WORKERS' COMPENSATION LAW WITH RESPECT TO ALL OPERATIONS IN THE STATE OF NEW YORK, EXCEPT AS INDICATED BELOW.

IF YOU WISH TO RECEIVE NOTIFICATIONS REGARDING SAID POLICY, INCLUDING ANY NOTIFICATION OF CANCELLATIONS, OR TO VALIDATE THIS CERTIFICATE, VISIT OUR WEBSITE AT [HTTPS://WWW.NYSIF.COM/CERT/CERTVAL.ASP](https://www.nysif.com/cert/certval.asp). THE NEW YORK STATE INSURANCE FUND IS NOT LIABLE IN THE EVENT OF FAILURE TO GIVE SUCH NOTIFICATIONS.

THIS POLICY DOES NOT COVER CLAIMS OR SUITS THAT ARISE FROM BODILY INJURY SUFFERED BY THE OFFICERS OF THE INSURED CORPORATION.

PRESIDENT  
MICHAEL THOMPSON  
SOLE E/O OF CIRCLE LINE  
EQUIPMENT INC

THIS CERTIFICATE IS ISSUED AS A MATTER OF INFORMATION ONLY AND CONFERS NO RIGHTS NOR INSURANCE COVERAGE UPON THE CERTIFICATE HOLDER. THIS CERTIFICATE DOES NOT AMEND, EXTEND OR ALTER THE COVERAGE AFFORDED BY THE POLICY.

NEW YORK STATE INSURANCE FUND

DIRECTOR, INSURANCE FUND UNDERWRITING

VALIDATION NUMBER: 354797601



**CERTIFICATE OF INSURANCE COVERAGE UNDER THE NYS DISABILITY BENEFITS LAW**

**PART 1. To be completed by Disability Benefits Carrier or Licensed Insurance Agent of that Carrier**

<p>1a. Legal Name &amp; Address of Insured (use street address only)</p> <p>NY ASPHALT, INC. 366 INDUSTRIAL LOOP STATEN ISLAND, NY 10309-1110</p> <p>Work Location of Insured (Only required if coverage is specifically limited to certain locations in New York State, i.e., a Wrap-Up Policy)</p>	<p>1b. Business Telephone Number of Insured (718) 966-6466</p> <p>1c. NYS Unemployment Insurance Employer Registration Number of Insured 4945872</p> <p>1d. Federal Employer Identification Number of Insured or Social Security Number 134-11-0973</p>
<p>2. Name and Address of Entity Requesting Proof of Coverage (Entity Being Listed as the Certificate Holder)</p> <p>NEW YORK CITY DEPARTMENT OF DESIGN &amp; CONSTRUCTION DIRECTOR - INSURANCE RISK MANAGER 30030 THOMSON AVE LONG ISLAND CITY, NY 11001</p>	<p>3a. Name of Insurance Carrier <b>New York State Insurance Fund (NYSIF)</b></p> <p>3b. Policy Number of Entity Listed in Box "1a" DBL 5929 05 - 5</p> <p>3c. Policy effective period <u>04/15/2010</u> to <u>04/15/2018</u></p>

4. Policy covers:

A. All of the employer's employees eligible under the New York Disability Benefits Law

B. Only the following class or classes of employer's employees:

Under penalty of perjury, I certify that I am an authorized representative or licensed agent of the insurance carrier referenced above and that the named insured has NYS Disability Benefits insurance coverage as described above.

Date Signed 7/21/2017 By *Joseph J. Masi* Joseph J. Masi  
(Signature of insurance carrier's authorized representative or NYS Licensed Insurance Agent of that insurance carrier)

Telephone Number (866) 697-4332 Title Director of NYSIF Disability Benefits Insurance

**IMPORTANT:** If Box "4a" is checked, and this form is signed by the insurance carrier's authorized representative or NYS Licensed Insurance Agent of that carrier, this certificate is COMPLETE. Mail it directly to the certificate holder.  
If Box "4b" is checked, this certificate is NOT COMPLETE for purposes of Section 220, Subd. 8 of the Disability Benefits Law. It must be mailed for completion to the Workers' Compensation Board, DB Plans Acceptance Unit, 328 State Street, Schenectady, NY 12305

**PART 2. To be completed by the NYS Workers' Compensation Board (Only if Box "4b" of Part 1 has been checked)**

**State of New York  
Workers' Compensation Board**

According to information maintained by the NYS Workers' Compensation Board, the above-named employer has complied with the NYS Disability Benefits Law with respect to all of his/her employees.

Date Signed \_\_\_\_\_ By \_\_\_\_\_  
(Signature of NYS Workers' Compensation Board Employee)

Telephone Number \_\_\_\_\_ Title \_\_\_\_\_

**Please Note:** Only insurance carriers licensed to write NYS disability benefits insurance policies and NYS licensed insurance agents of those insurance carriers are authorized to issue Form DB-120.1. **Insurance brokers are NOT authorized to issue this form.**

## Additional Instructions for Form DB-120.1

By signing this form, the insurance carrier identified in box "3" on this form is certifying that it is insuring the business referenced in box "1a" for disability benefits under the New York State Disability Benefits Law. The Insurance Carrier or its licensed agent will send this Certificate of Insurance to the entity listed as the certificate holder in box "2".

Will the carrier notify the certificate holder within 10 days of a policy being cancelled for non-payment of premium or within 30 days if cancelled for any other reason or if the insured is otherwise eliminated from the coverage indicated on this certificate prior to the end of the policy effective period?  YES  NO

This certificate is issued as a matter of information only and confers no rights upon the certificate holder. This certificate does not amend, extend or alter the coverage afforded by the policy listed, nor does it confer any rights or responsibilities beyond those contained in the referenced policy.

This certificate may be used as evidence of a Disability Benefits contract of insurance only while the underlying policy is in effect.

**Please Note: Upon the cancellation of the disability benefits policy indicated on this form, if the business continues to be named on a permit, license or contract issued by a certificate holder, the business must provide that certificate holder with a new Certificate of NYS Disability Benefits Coverage or other authorized proof that the business is complying with the mandatory coverage requirements of the New York State Disability Benefits Law.**

### DISABILITY BENEFITS LAW

#### §220. Subd. 8

(a) The head of a state or municipal department, board, commission or office authorized or required by law to issue any permit for or in connection with any work involving the employment of employees in employment as defined in this article, and notwithstanding any general or special statute requiring or authorizing the issue of such permits, shall not issue such permit unless proof duly subscribed by an insurance carrier is produced in a form satisfactory to the chair, that the payment of disability benefits for all employees has been secured as provided by this article. Nothing herein, however, shall be construed as creating any liability on the part of such state or municipal department, board, commission or office to pay any disability benefits to any such employee if so employed.

(b) The head of a state or municipal department, board, commission or office authorized or required by law to enter into any contract for or in connection with any work involving the employment of employees in employment as defined in this article and notwithstanding any general or special statute requiring or authorizing any such contract, shall not enter into any such contract unless proof duly subscribed by an insurance carrier is produced in a form satisfactory to the chair, that the payment of disability benefits for all employees has been secured as provided by this article.

**CERTIFICATION BY INSURANCE BROKER OR AGENT**

The undersigned insurance broker represents to the City of New York that the attached Certificate of Insurance is accurate in all material respects.

USI Insurance Services, LLC  
[Name of broker or agent (typewritten)]

300 Executive Drive, West Orange, NJ 07052  
[Address of broker or agent (typewritten)]

katlen.yesse@usi.com  
[Email address of broker or agent (typewritten)]

973-965-3166/610-537-4508  
[Phone number/Fax number of broker or agent (typewritten)]

  
[Signature of authorized official, broker, or agent]

Andy Castle, Broker  
[Name and title of authorized official, broker, or agent (typewritten)]

New Jersey  
State of .....)  
Essex ) ss.:  
County of .....

Sworn to before me this 16th day of November, 2017

  
NOTARY PUBLIC FOR THE STATE OF New Jersey

**CATHY M KNOKE**  
NOTARY PUBLIC  
STATE OF NEW JERSEY  
ID # 50009608  
MY COMMISSION EXPIRES FEB. 4, 2020

by any ordinance, law or building code to include as an additional insured on this Coverage Part is an insured, but only with respect to liability for "bodily injury", "property damage", "personal injury" or "advertising injury" arising out of such operations.

The insurance provided to such state or political subdivision does not apply to:

- a. Any "bodily injury", "property damage," "personal injury" or "advertising injury" arising out of operations performed for that state or political subdivision; or
- b. Any "bodily injury" or "property damage" included in the "products-completed operations hazard".

**J. KNOWLEDGE AND NOTICE OF OCCURRENCE OR OFFENSE**

The following is added to Paragraph 2., Duties In The Event of Occurrence, Offense, Claim or Suit, of SECTION IV - COMMERCIAL GENERAL LIABILITY CONDITIONS:

- e. The following provisions apply to Paragraph a. above, but only for the purposes of the insurance provided under this Coverage Part to you or any insured listed in Paragraph 1. or 2. of Section II - Who Is An Insured:

- (1) Notice to us of such "occurrence" or offense must be given as soon as practicable only after the "occurrence" or offense is known by you (if you are an individual), any of your partners or members who is an individual (if you are a partnership or joint venture), any of your managers who is an individual (if you are a limited liability company), any of your "executive officers" or directors (if you are an organization other than a partnership, joint venture or limited liability company) or any "employee" authorized by you to give notice of an "occurrence" or offense.

- (2) If you are a partnership, joint venture or limited liability company, and none of your partners, joint venture members or managers are individuals, notice to us of such "occurrence" or offense must be given as soon as practicable only after the "occurrence" or offense is known by:

- (a) Any individual who is:
  - (i) A partner or member of any partnership or joint venture;

- (ii) A manager of any limited liability company; or

- (iii) An executive officer or director of any other organization;

that is your partner, joint venture member or manager; or

- (b) Any "employee" authorized by such partnership, joint venture, limited liability company or other organization to give notice of an "occurrence" or offense.

- (3) Notice to us of such "occurrence" or of an offense will be deemed to be given as soon as practicable if it is given in good faith as soon as practicable to your workers' compensation insurer. This applies only if you subsequently give notice to us of the "occurrence" or offense as soon as practicable after any of the persons described in Paragraphs e. (1) or (2) above discovers that the "occurrence" or offense may result in sums to which the insurance provided under this Coverage Part may apply.

However, if this Coverage Part includes an endorsement that provides limited coverage for "bodily injury" or "property damage" or pollution costs arising out of a discharge, release or escape of "pollutants" which contains a requirement that the discharge, release or escape of "pollutants" must be reported to us within a specific number of days after its abrupt commencement, this Paragraph e. does not affect that requirement.

**K. UNINTENTIONAL OMISSION**

The following is added to Paragraph 6., Representations, of SECTION IV - COMMERCIAL GENERAL LIABILITY CONDITIONS:

The unintentional omission of, or unintentional error in, any information provided by you which we relied upon in issuing this policy will not prejudice your rights under this insurance. However, this provision does not affect our right to collect additional premium or to exercise our rights of cancellation or nonrenewal in accordance with applicable insurance laws or regulations.

**L. BLANKET WAIVER OF SUBROGATION**

The following is added to Paragraph 8., Transfer Of Rights Of Recovery Against Others To Us, of SECTION IV - COMMERCIAL GENERAL LIABILITY CONDITIONS:

Policy Number: DT-8104-E994634-IND-16

COMMERCIAL GENERAL LIABILITY

If the insured has agreed in a contract or agreement to waive that insured's right of recovery against any person or organization, we waive our right of recovery against such person or organization, but only for payments we make because of:

- a. "Bodily injury" or "property damage" that occurs; or
- b. "Personal injury" or "advertising injury" caused by an offense that is committed; subsequent to the execution of that contract or agreement.

**M. AMENDED BODILY INJURY DEFINITION**

The following replaces the definition of "bodily injury" in the DEFINITIONS Section:

3. "Bodily injury" means bodily injury, mental anguish, mental injury, shock, fright, disability, humiliation, sickness or disease sustained by a person, including death resulting from any of these at any time.

**N. CONTRACTUAL LIABILITY - RAILROADS**

1. The following replaces Paragraph c. of the definition of "insured contract" in the DEFINITIONS Section:
  - c. Any easement or license agreement;
2. Paragraph f.(1) of the definition of "insured contract" in the DEFINITIONS Section is deleted.

**Performance Bond #1 (Pages 92 to 95): Use if the total contract price is \$5 Million Or Less. Performance Bond #1 has been approved by the U.S. Small Business Administration ("SBA") for participation in its Bond Guarantee Program.**

PERFORMANCE BOND #1 (Page 2)

good any such default and shall protect the said City of New York against, and pay any and all amounts, damages, cost and judgments which may or shall be recovered against said City or its officers or agents or which the said City of New York may be called upon to pay any person or corporation by reason of any damages arising or growing out of the Principal's default of the Contract, then this obligation shall be null and void, otherwise to remain in full force and effect.

The Surety (Sureties), for value received, hereby stipulates and agrees, upon written notice from the City that the City has determined that the Principal is in default of the Contract, to (1) pay the City the cost to complete the contract as determined by the City in excess of the balance of the Contract held by the City, plus any damages or costs to which the City is entitled, up to the full amount of the above penal sum, (2) fully perform and complete the Work to be performed under the Contract, pursuant to the terms, conditions, and covenants thereof, or (3) tender a completion Contractor that is acceptable to the City. The Surety (Sureties) further agrees, at its option, either to notify the City that it elects to pay the city the cost of completion plus any applicable damages and costs under option (1) above, or to commence and diligently perform the Work specified in the Contract, including physical site work, within twenty-five (25) business days after written notice thereof from the City and, if the Surety elects to fully perform and complete the Work, then to complete all Work within the time set forth in the Contract or such other time as agreed to between the City and Surety in accordance with the Contract. If the Surety elects to tender payment pursuant to (1) above, then the Surety shall tender such amount within fifteen (15) business days notification from the City of the cost of completion. The Surety and the City reserve all rights and defenses each may have against the other; provided, however, that the Surety expressly agrees that its reservation of rights shall not provide a basis for non-performance of its obligation to pay the City the cost of completion, to commence and complete all Work as provided herein, or to tender a completion contractor.

The Surety (Sureties), for value received, for itself and its successors and assigns, hereby stipulates and agrees that the obligation of said Surety (Sureties) and its bond shall be in no way impaired or affected by any extension of time, modification, omission, addition, or change in or to the said Contract or the Work to be performed thereunder, or by any payment thereunder before the time required therein, or by any waiver of any provisions thereof, or any moneys due or to become due thereunder; and said Surety (Sureties) does hereby waive notice of any and all of such extensions, modifications, omissions, additions, changes, payments, and waivers, and hereby expressly stipulates and agrees that any and all things done and omitted to be done by and in relation to subcontractors shall have the same effect as to said Surety (Sureties) as though done or omitted to be done by or in relation to said Principal. Notwithstanding the above, if the City makes payments to the Principal before the time required by the contract that in the aggregate exceed \$100,000 or 10% of the Contract price, whichever is less, and that have not become earned prior to the Principal being found to be in default, then all payments made to the Principal before the time required by the Contract shall be added to the remaining contract value available to be paid for the completion of the Contract as if such sums had not been paid to the Principal, but shall not provide a basis for non-performance of its obligation to pay the City the cost of completion, to commence and to complete all Work as provided herein, or to tender a completion contractor.

**Performance Bond #1 (Pages 92 to 95): Use if the total contract price is \$5 Million Or Less. Performance Bond #1 has been approved by the U.S. Small Business Administration ("SBA") for participation in its Bond Guarantee Program.**

PERFORMANCE BOND #1 (Page 3)

IN WITNESS WHEREOF, The Principal and the Surety (Sureties) have hereunto set their hands and seals, and such of them as are corporations have caused their corporate seals to be hereunto affixed and these presents to be signed by their proper officers, this

\_\_\_\_\_ day of \_\_\_\_\_, 20\_\_\_\_\_  
(Seal)

\_\_\_\_\_  
Principal (L.S.)

By: \_\_\_\_\_  
(Seal) Surety

By: \_\_\_\_\_  
(Seal) Surety

By: \_\_\_\_\_  
(Seal) Surety

By: \_\_\_\_\_  
(Seal) Surety

By: \_\_\_\_\_  
(Seal) Surety

By: \_\_\_\_\_

Bond Premium Rate \_\_\_\_\_

Bond Premium Cost \_\_\_\_\_

If the Contractor (Principal) is a partnership, the bond should be signed by each of the individuals who are partners.

If the Contractor (Principal) is a corporation, the bond should be signed in its correct corporate name by a duly authorized officer, agent, or attorney-in-fact.

There should be executed an appropriate number of counterparts of the bond corresponding to the number of counterparts of the Contract.



**Performance Bond #1 (Pages 92 to 95):** Use if the total contract price is \$5 Million Or Less. Performance Bond #1 has been approved by the U.S. Small Business Administration ("SBA") for participation in its Bond Guarantee Program.

PERFORMANCE BOND #1 (Page 4)

**ACKNOWLEDGMENT OF PRINCIPAL IF A CORPORATION**

State of \_\_\_\_\_ County of \_\_\_\_\_ ss:

On this \_\_\_\_\_ day of \_\_\_\_\_, 20 \_\_\_\_\_ before me personally came \_\_\_\_\_,

to me known, who, being by me duly sworn did depose and say that he/she resides at \_\_\_\_\_

\_\_\_\_\_ ; that he/she is the \_\_\_\_\_ of the corporation described in and which executed the foregoing instrument; and that he/she signed his/her name to the foregoing instrument by order of the directors of said corporation as the duly authorized and binding act thereof.

\_\_\_\_\_  
Notary Public or Commissioner of Deeds.

**ACKNOWLEDGMENT OF PRINCIPAL IF A PARTNERSHIP**

State of \_\_\_\_\_ County of \_\_\_\_\_ ss:

On this \_\_\_\_\_ day of \_\_\_\_\_, 20 \_\_\_\_\_ before me personally came \_\_\_\_\_,

to me known, who, being by me duly sworn did depose and say that he/she resides at \_\_\_\_\_

\_\_\_\_\_ ; that he/she is \_\_\_\_\_ partner of \_\_\_\_\_, a limited/general partnership existing under the laws of the State of \_\_\_\_\_, the partnership described in and which executed the foregoing instrument; and that he/she signed his/her name to the foregoing instrument as the duly authorized and binding act of said partnership.

\_\_\_\_\_  
Notary Public or Commissioner of Deeds.

**ACKNOWLEDGMENT OF PRINCIPAL IF AN INDIVIDUAL**

State of \_\_\_\_\_ County of \_\_\_\_\_ ss:

On this \_\_\_\_\_ day of \_\_\_\_\_, 20 \_\_\_\_\_ before me personally came \_\_\_\_\_,

to me known, who, being by me duly sworn did depose and say that he/she resides at \_\_\_\_\_

\_\_\_\_\_ and that he/she is the individual whose name is subscribed to the within instrument and acknowledged to me that by his/her signature on the instrument, said individual executed the instrument.

\_\_\_\_\_  
Notary Public or Commissioner of Deeds

Each executed bond should be accompanied by: (a) appropriate acknowledgments of the respective parties; (b) appropriate duly certified copy of Power of Attorney or other certificate of authority where bond is executed by agent, officer or other representative of Principal or Surety; (c) a duly certified extract from By-Laws or resolutions of Surety under which Power of Attorney or other certificate of authority of its agent, officer or representative was issued, and (d) certified copy of latest published financial statement of assets and liabilities of Surety.

\*\*\*\*\*

Affix Acknowledgments and Justification of Sureties.

**Performance Bond #2 (Pages 96 to 99): Use if the total contract price is more than \$5 Million.**

PERFORMANCE BOND #2 (Page 1)

**PERFORMANCE BOND #2**

**KNOW ALL PERSONS BY THESE PRESENTS:**

That we, \_\_\_\_\_  
\_\_\_\_\_  
\_\_\_\_\_

hereinafter referred to as the "Principal,"  
and, \_\_\_\_\_  
\_\_\_\_\_  
\_\_\_\_\_

hereinafter referred to as the "Surety" ("Sureties") are held and firmly bound to THE CITY OF NEW YORK, hereinafter referred to as the "City" or to its successors and assigns in the penal sum of \_\_\_\_\_  
\_\_\_\_\_  
\_\_\_\_\_

(\$ \_\_\_\_\_ ) Dollars, lawful money of the United States for the payment of which said sum of money well and truly to be made, we, and each of us, bind ourselves, our heirs, executors, administrators, successors and assigns, jointly and severally, firmly by these presents.

**WHEREAS**, the Principal is about to enter, or has entered, into a Contract in writing with the City for \_\_\_\_\_  
\_\_\_\_\_

a copy of which Contract is annexed to and hereby made a part of this bond as though herein set forth in full;

**NOW, THEREFORE**, the conditions of this obligation are such that if the Principal, his or its representatives or assigns, shall well and faithfully perform the said Contract and all modifications, amendments, additions and alterations thereto that may hereafter be made, according to its terms and its true intent and meaning, including repair and or replacement of defective work and guarantees of maintenance for the periods stated in the Contract, and shall fully indemnify and save harmless the City from all cost and damage which it may suffer by reason of the Principal's default of the Contract, and shall fully reimburse and repay the City for all outlay and expense which the City may incur in making

**Performance Bond #2 (Pages 96 to 99): Use if the total contract price is more than \$5 Million.**

PERFORMANCE BOND #2 (Page 2)

good any such default and shall protect the said City of New York against, and pay any and all amounts, damages, cost and judgments which may or shall be recovered against said City or its officers or agents or which the said City of New York may be called upon to pay any person or corporation by reason of any damages arising or growing out of the Principal's default of the Contract, then this obligation shall be null and void, otherwise to remain in full force and effect.

The Surety (Sureties), for value received, hereby stipulates and agrees, upon written notice from the City that the City has determined that the Principal is in default of the Contract, to either (1) pay the full amount of the above penal sum in complete discharge and exoneration of this bond and of all the liabilities of the Surety relating to this bond, or (2) fully perform and complete the Work to be performed under the Contract, pursuant to the terms, conditions, and covenants thereof. The Surety (Sureties) further agrees, at its option, either to tender the penal sum or to commence and diligently perform the Work specified in the Contract, including physical site work, within twenty-five (25) business days after written notice thereof from the City and to complete all Work within the time set forth in the Contract or such other time as agreed to between the City and Surety in accordance with the Contract. The Surety and the City reserve all rights and defenses each may have against the other; provided, however, that the Surety expressly agrees that its reservation of rights shall not provide a basis for non-performance of its obligation to commence and to complete all Work as provided herein.

The Surety (Sureties), for value received, for itself and its successors and assigns, hereby stipulates and agrees that the obligation of said Surety (Sureties) and its bond shall be in no way impaired or affected by any extension of time, modification, omission, addition, or change in or to the said Contract or the Work to be performed thereunder, or by any payment thereunder before the time required therein, or by any waiver of any provisions thereof, or by any assignment, subletting or other transfer thereof or of any Work to be performed or any moneys due or to become due thereunder; and said Surety (Sureties) does hereby waive notice of any and all of such extensions, modifications, omissions, additions, changes, payments, waivers, assignments, subcontracts and transfers, and hereby expressly stipulates and agrees that any and all things done and omitted to be done by and in relation to assignees, subcontractors, and other transferees shall have the same effect as to said Surety (Sureties) as though done or omitted to be done by or in relation to said Principal.

**Performance Bond #2 (Pages 96 to 99): Use if the total contract price is more than \$5 Million.**

PERFORMANCE BOND #2 (Page 3)

IN WITNESS WHEREOF, The Principal and the Surety (Sureties) have hereunto set their hands and seals, and such of them as are corporations have caused their corporate seals to be hereunto affixed and these presents to be signed by their proper officers, this

\_\_\_\_\_ day of \_\_\_\_\_ 20\_\_\_\_\_ .

(Seal)

\_\_\_\_\_  
Principal (L.S.)

By: \_\_\_\_\_

(Seal)

Surety

By: \_\_\_\_\_

(Seal)

\_\_\_\_\_  
Surety

By: \_\_\_\_\_

(Seal)

\_\_\_\_\_  
Surety

By: \_\_\_\_\_

(Seal)

\_\_\_\_\_  
Surety

By: \_\_\_\_\_

(Seal)

\_\_\_\_\_  
Surety

By: \_\_\_\_\_

Bond Premium Rate \_\_\_\_\_

Bond Premium Cost \_\_\_\_\_

If the Contractor (Principal) is a partnership, the bond should be signed by each of the individuals who are partners.

If the Contractor (Principal) is a corporation, the bond should be signed in its correct corporate name by a duly authorized officer, agent, or attorney-in-fact.

There should be executed an appropriate number of counterparts of the bond corresponding to the number of counterparts of the Contract.

**Performance Bond #2 (Pages 96 to 99): Use if the total contract price is more than \$5 Million.**

PERFORMANCE BOND #2 (Page 4)

**ACKNOWLEDGMENT OF PRINCIPAL IF A CORPORATION**

State of \_\_\_\_\_ County of \_\_\_\_\_ ss:

On this \_\_\_\_\_ day of \_\_\_\_\_, 20 \_\_\_\_\_ before me personally came \_\_\_\_\_,

to me known, who, being by me duly sworn did depose and say that he resides at \_\_\_\_\_

\_\_\_\_\_ ; that he/she is the \_\_\_\_\_ of the corporation described in and which executed the foregoing instrument; that he/she signed his/her name to the foregoing instrument by order of the directors of said corporation as the duly authorized and binding act thereof.

\_\_\_\_\_  
Notary Public or Commissioner of Deeds.

**ACKNOWLEDGMENT OF PRINCIPAL IF A PARTNERSHIP**

State of \_\_\_\_\_ County of \_\_\_\_\_ ss:

On this \_\_\_\_\_ day of \_\_\_\_\_, 20 \_\_\_\_\_ before me personally came \_\_\_\_\_,

to me known, who, being by me duly sworn did depose and say that he/she resides at \_\_\_\_\_

\_\_\_\_\_ ; that he/she is \_\_\_\_\_ partner of \_\_\_\_\_, a limited/general partnership existing under the laws of the State of \_\_\_\_\_, the partnership described in and which executed the foregoing instrument; and that he/she signed his/her name to the foregoing instrument as the duly authorized and binding act of said partnership.

\_\_\_\_\_  
Notary Public or Commissioner of Deeds

**ACKNOWLEDGMENT OF PRINCIPAL IF AN INDIVIDUAL**

State of \_\_\_\_\_ County of \_\_\_\_\_ ss:

On this \_\_\_\_\_ day of \_\_\_\_\_, 20 \_\_\_\_\_ before me personally came \_\_\_\_\_,

to me known, who, being by me duly sworn did depose and say that he/she resides at \_\_\_\_\_

\_\_\_\_\_ , and that he/she is the individual whose name is subscribed to the within instrument and acknowledged to me that by his/her signature on the instrument, said individual executed the instrument.

\_\_\_\_\_  
Notary Public or Commissioner of Deeds

Each executed bond should be accompanied by: (a) appropriate acknowledgments of the respective parties; (b) appropriate duly certified copy of Power of Attorney or other certificate of authority where bond is executed by agent, officer or other representative of Principal or Surety; (c) a duly certified extract from By-Laws or resolutions of Surety under which Power of Attorney or other certificate of authority of its agent, officer or representative was issued, and (d) certified copy of latest published financial statement of assets and liabilities of Surety.

\*\*\*\*\*

Affix Acknowledgments and Justification of Sureties.

CITY OF NEW YORK

DDC

99

STANDARD CONSTRUCTION CONTRACT

December 2013

**Payment Bond (Pages 100 to 103): Use for any contract for which a Payment Bond is required.**

PAYMENT BOND (Page 1)

PAYMENT BOND

KNOW ALL PERSONS BY THESE PRESENTS, That we, \_\_\_\_\_

\_\_\_\_\_  
\_\_\_\_\_  
\_\_\_\_\_

hereinafter referred to as the "Principal", and \_\_\_\_\_

\_\_\_\_\_  
\_\_\_\_\_  
\_\_\_\_\_

hereinafter referred to as the "Surety" ("Sureties") are held and firmly bound to THE CITY OF NEW YORK, hereinafter referred to as the "City" or to its successors and assigns, in the penal sum of

\_\_\_\_\_  
\_\_\_\_\_  
\_\_\_\_\_

(\$ \_\_\_\_\_) Dollars, lawful money of the United States, for the payment of which said sum of money well and truly to be made, we, and each of us, bind ourselves, our heirs, executors, administrators, successors and assigns, jointly and severally, firmly by these presents.

WHEREAS, the Principal is about to enter, or has entered, into a Contract in writing with the City for

\_\_\_\_\_  
\_\_\_\_\_  
\_\_\_\_\_

a copy of which Contract is annexed to and hereby made a part of this bond as though herein set forth in full;

NOW, THEREFORE, the conditions of this obligation are such that if the Principal, his or its representatives or assigns and other Subcontractors to whom Work under this Contract is sublet and his or their successors and assigns shall promptly pay or cause to be paid all lawful claims for

(a) Wages and compensation for labor performed and services rendered by all persons engaged in the prosecution of the Work under said Contract, and any amendment or extension thereof or addition thereto, whether such persons be agents servants or employees of the Principal or any such Subcontractor, including all persons so engaged who perform the work of laborers or mechanics at or in the vicinity of the site

**Payment Bond (Pages 100 to 103): Use for any contract for which a Payment Bond is required.**

PAYMENT BOND (Page 2)

of the Project regardless of any contractual relationship between the Principal or such Subcontractors, or his or their successors or assigns, on the one hand and such laborers or mechanics on the other, but not including office employees not regularly stationed at the site of the project; and

(b) Materials and supplies (whether incorporated in the permanent structure or not), as well as teams, fuels, oils, implements or machinery furnished, used or consumed by said Principal or any subcontractor at or in the vicinity of the site of the Project in the prosecution of the Work under said Contract and any amendment or extension thereof or addition thereto; then this obligation shall be void, otherwise to remain in full force and effect.

This bond is subject to the following additional conditions, limitations and agreements:

(a) The Principal and Surety (Sureties) agree that this bond shall be for the benefit of any materialmen or laborer having a just claim, as well as the City itself.

(b) All persons who have performed labor, rendered services or furnished materials and supplies, as aforesaid, shall have a direct right of action against the Principal and his, its or their successors and assigns, and the Surety (Sureties) herein, or against either or both or any of them and their successors and assigns. Such persons may sue in their own name, and may prosecute the suit to judgment and execution without the necessity of joining with any other persons as party plaintiff.

(c) The Principal and Surety (Sureties) agree that neither of them will hold the City liable for any judgment for costs of otherwise, obtained by either or both of them against a laborer or materialman in a suit brought by either a laborer or materialman under this bond for moneys allegedly due for performing work or furnishing material.

(d) The Surety (Sureties) or its successors and assigns shall not be liable for any compensation recoverable by an employee or laborer under the Workmen's Compensation Law.

(e) In no event shall the Surety (Sureties), or its successors or assigns, be liable for a greater sum than the penalty of this bond or be subject to any suit, action or proceeding hereon that is instituted by any person, firm, or corporation hereunder later than two years after the complete performance of said Contract and final settlement thereof.

The Principal, for himself and his successors and assigns, and the Surety (Sureties), for itself and its successors and assigns, do hereby expressly waive any objection that might be interposed as to the right of the City to require a bond containing the foregoing provisions, and they do hereby further expressly waive any defense which they or either of them might interpose to an action brought hereon by any person, firm or corporation, including subcontractors, materialmen and third persons, for work, labor, services, supplies or material performed rendered, or furnished as aforesaid upon the ground that there is no law authorizing the City to require the foregoing provisions to be place in this bond.

And the Surety (Sureties), for value received, for itself and its successors and assigns, hereby stipulates and agrees that the obligation of said Surety (Sureties), and its bonds shall be in no way impaired or affected by any extension of time, modification, omission, addition, or change in or of the said Contract or the work to be performed thereunder, or by any payment thereunder before the time required therein, or by any waiver of any provisions thereof, or by any assignment, subletting or other transfer thereof or of any part thereof, or of any Work to be performed, or any moneys due to become due thereunder and said Surety (Sureties) does hereby waive notice of any and all of such extensions, modifications, omissions, additions, changes, payments, waivers, assignments, subcontracts and transfers, and hereby expressly stipulates and agrees that any and all things done and omitted to be done by and in relation to assignees, Subcontractors, and other transferees shall have the same effect as to said Surety (Sureties) as though done or omitted to be done or in relation to said Principal.

**Payment Bond (Pages 100 to 103): Use for any contract for which a Payment Bond is required.**

PAYMENT BOND (Page 3)

IN WITNESS WHEREOF, the Principal and the Surety (Sureties) have hereunto set their hands and seals, and such of them as are corporations have caused their corporate seals to be hereunto affixed and these presents to be signed by their proper officers, this \_\_\_\_\_ day of \_\_\_\_\_, \_\_\_\_\_.

(Seal) \_\_\_\_\_ (L.S.)  
Principal

By: \_\_\_\_\_

(Seal) \_\_\_\_\_  
Surety

By: \_\_\_\_\_

(Seal) \_\_\_\_\_  
Surety

By: \_\_\_\_\_

(Seal) \_\_\_\_\_  
Surety

By: \_\_\_\_\_

(Seal) \_\_\_\_\_  
Surety

By: \_\_\_\_\_

If the Contractor (Principal) is a partnership, the bond should be signed by each of the individuals who are partners.

If the Contractor (Principal) is a corporation, the bond should be signed in its correct corporate name by a duly authorized officer, agent, or attorney-in-fact.

There should be executed an appropriate number of counterparts of the bond corresponding to the number of counterparts of the Contract.



**Payment Bond (Pages 100 to 103): Use for any contract for which a Payment Bond is required.**

PAYMENT BOND (Page 4)

**ACKNOWLEDGMENT OF PRINCIPAL, IF A CORPORATION**

State of \_\_\_\_\_ County of \_\_\_\_\_ ss:

On this \_\_\_\_ day of \_\_\_\_\_, \_\_\_\_\_, before me personally came \_\_\_\_\_ to me known, who, being by me duly sworn did depose and say that he resides at \_\_\_\_\_ that he is the \_\_\_\_\_ of the corporation described in and which executed the foregoing instrument; that he knows the seal of said corporation; that one of the seals affixed to said instrument is such seal; that it was so affixed by order of the directors of said corporation, and that he signed his name thereto by like order.

\_\_\_\_\_  
Notary Public or Commissioner of Deeds

**ACKNOWLEDGMENT OF PRINCIPAL, IF A PARTNERSHIP**

State of \_\_\_\_\_ County of \_\_\_\_\_ ss:

On this \_\_\_\_ day of \_\_\_\_\_, \_\_\_\_\_, before me personally appeared \_\_\_\_\_ to me known, and known to me to be one of the members of the firm of \_\_\_\_\_ described in and who executed the foregoing instrument; and he acknowledged to me that he executed the same as and for the act and deed of said firm.

\_\_\_\_\_  
Notary Public or Commissioner of Deeds

**ACKNOWLEDGMENT OF PRINCIPAL, IF AN INDIVIDUAL**

State of \_\_\_\_\_ County of \_\_\_\_\_ ss:

On this \_\_\_\_ day of \_\_\_\_\_, \_\_\_\_\_, before me personally appeared \_\_\_\_\_ to me known, and known to me to be the person described in and who executed the foregoing instrument; and acknowledged that he executed the same.

\_\_\_\_\_  
Notary Public or Commissioner of Deeds

Each executed bond should be accompanied by: (a) appropriate acknowledgments of the respective parties; (b) appropriate duly certified copy of Power of Attorney or other certificate of authority where bond is executed by agent, officer or other representative of Principal or Surety; (c) a duly certified extract from By-Laws or resolutions of Surety under which Power of Attorney or other certificate of authority of its agent, officer or representative was issued, and (d) certified copy of latest published financial statement of assets and liabilities of Surety.

\*\*\*\*\*

Affix Acknowledgments and Justification of Sureties.

(NO TEXT ON THIS PAGE)

SCHEDULE OF WORKMEN, MECHANICS AND LABORERS

The following is a list of classifications for workmen, mechanics and laborers which are anticipated to be employed in the performance of work under this contract, followed by a schedule of the prevailing wage rates and supplemental benefits for all classifications as established by the Comptroller of the City of New York.

Request for interpretation or correction under Subsection A of Section No. 3 in the Information for Bidders includes all requests for clarification of the classification of trades to be employed in the performance of the work under this contract.

In the event that a trade not listed in the classification of trades required to be used at the time of the award of the contract is in fact employed during the performance of this contract, the Contractor shall be required to obtain from the agency the prevailing wage rates and supplementary benefits for the trades used and to complete the performance of this contract at the price at which the contract was awarded.

<u>CODE</u>	<u>CLASSIFICATION</u>
15 42 001	Rigger
15 42 002	Sign Erector
16 11 001	Gardener
16 11 002	Tree Pruner
16 11 003	Tree Remover
16 11 011	Asphalt Raker (Highway & Paving)
16 11 012	Tamper (Highway & Paving)
16 11 013	Curbsetter (Highway & Paving)
16 11 014	Formsetter (Highway & Paving)
16 11 015	Rammerman (Highway & Paving)
16 11 016	Laborer (Highway & Paving)
16 11 017	ALL OTHER TITLES (Highway & Paving)
16 23 001	Laborer
16 23 002	Operating Engineer (Heavy Construction-Maintenance)
16 23 003	Junior Operating Engineer
16 23 004	Junior Operating Engineer
16 23 005	Junior Operating Engineer
16 23 006	Fireman (Heavy Construction)
16 23 007	Oiler (Heavy Construction)
16 23 051	Surveyor-Heavy Construction
16 23 052	Surveyor-Heavy Construction-Instrument Man
16 23 053	Surveyor-Heavy Construction-Rodman
16 23 057	Surveyor-Land Surveying-Party Chief
16 23 058	Surveyor-Land Surveying-Instrument Man
16 23 059	Surveyor-Land Surveying-Rodman

<u>CODE</u>	<u>CLASSIFICATION</u>
16 23 061	Operating Engineer-Road & Heavy Construction
16 23 062	Operating Engineer-Paving
16 23 063	Operating Engineer-Concrete
16 23 071	Teamster-Heavy Equipment Trailer Driver
16 23 072	Teamster-Dump Truck Driver
16 23 073	Teamster-Flat Bed Trailer Driver (3-Axle)
16 23 074	Teamster-Redi-Mix (Sand and Gravel)
16 29 011	Drill Runners
17 11 001	Plumbers
17 21 001	Painter (Brush & Roller)
17 31 001	Electrician
17 41 001	Bricklayer
17 41 002	Mason Tender
17 41 004	Cement Mason
17 42 002	Metallic Lather
17 51 001	Carpenter
17 51 002	Dock Builder
17 71 001	Cement & Concrete Worker
17 91 001	Structural Iron Worker
17 95 001	Barman
17 96 021	Derrickmen & Riggers
17 99 001	Ornamental Iron Worker
17 99 002	Sandblaster
17 99 005	Pointers (Waterproofer)
17 99 011	Welders

Each classification may include trainees depending upon project staffing schedules and as required by the terms of this contract.

OFFICE OF THE COMPTROLLER, CITY OF NEW YORK  
§220 PREVAILING WAGE SCHEDULE

LABOR LAW §220 PREVAILING WAGE SCHEDULE

Workers, Laborers and Mechanics employed on a public work project must receive not less than the prevailing rate of wage and benefits for the classification of work performed by each upon such public work. Pursuant to Labor Law §220 the Comptroller of the City of New York has promulgated this schedule solely for Workers, Laborers and Mechanics engaged by private contractors on New York City public work contracts.

This schedule is a compilation of separate determinations of the prevailing rate of wage and supplements made by the Comptroller for each trade classification listed herein pursuant to New York State Labor Law section 220 (5). The source of the wage and supplement rates, whether a collective bargaining agreement, survey data or other, is listed at the end of each classification.

Agency Chief Contracting Officers should contact the Bureau of Labor Law's Classification Unit with any questions concerning trade classifications, prevailing rates or prevailing practices with respect to procurement on New York City public works contracts. Contractors are advised to review the Comptroller's Prevailing Wage Schedule before bidding on public works contracts. Contractors with questions concerning trade classifications, prevailing rates or prevailing practices with respect to public works contracts in the procurement stage must contact the contracting agency responsible for the procurement.

Any error as to compensation under the prevailing wage law or other information as to trade classification, made by the contracting agency in the contract documents or in any other communication, will not preclude a finding against the contractor of prevailing wage violation.

Any questions concerning trade classifications, prevailing rates or prevailing practices on New York City public works contracts that have already been awarded may be directed to the Bureau of Labor Law's Classification Unit by calling (212) 669-7974. All callers must have the agency name and contract registration number available when calling with questions on public works contracts. Please direct all other compliance issues to: Bureau of Labor Law, Attn: Wasyl Kinach, P.E., Office of the Comptroller, 1 Centre Street, Room 1122, New York, N.Y. 10007; Fax (212) 669-4002.

The appropriate schedule of prevailing wages and benefits must be posted at all public work sites pursuant to Labor Law §220 (3-a) (a).

This schedule is applicable to work performed during the effective period, unless otherwise noted. Changes to this schedule are published on our web site [www.comptroller.nyc.gov](http://www.comptroller.nyc.gov). Contractors must pay the wages and supplements in effect when the worker, laborer, mechanic performs the work. Preliminary schedules for future one-year periods appear in the City Record on or about June 1 each succeeding year. Final schedules appear on or about July 1 in the City Record and on our web site [www.comptroller.nyc.gov](http://www.comptroller.nyc.gov).

The Comptroller's Office has attempted to include all overtime, shift and night differential, Holiday, Saturday, Sunday or other premium time work. However, this schedule does not set forth every prevailing practice with respect to such rates with which employers must comply. All such practices are nevertheless part of the employer's prevailing wage obligation and contained in the collective bargaining agreements of the prevailing wage unions. These collective bargaining agreements are available for inspection by appointment. Requests for appointments may be made by calling (212) 669-4443, Monday through Friday between the hours of 9 a.m. and 5 p.m.

OFFICE OF THE COMPTROLLER, CITY OF NEW YORK  
§220 PREVAILING WAGE SCHEDULE

Prevailing rates and ratios for apprentices are attached to this schedule in the Appendix. Pursuant to Labor Law §220 (3-e), only apprentices who are individually registered in a bona fide program to which the employer contractor is a participant, registered with the New York State Department of Labor, may be employed on a public work project. Workers who are not journey persons or not registered apprentices pursuant to Labor Law §220 (3-e) may not be substituted for apprentices and must be paid as journey persons.

Public Work construction, reconstruction, demolition, excavation, rehabilitation, repair, renovation, alteration, or improvement contracts awarded pursuant to a Project Labor Agreement ("PLA") in accordance with Labor Law section 222 may have different labor standards for shift, premium and overtime work. Please refer to the PLA's pre-negotiated labor agreements for wage and benefit rates applicable to work performed outside of the regular workday. More information is available at the Mayor's Office of Contract Services (MOCS) web page at <http://www.nyc.gov/html/mocs/html/vendors/pla.shtml>.

All the provisions of Labor Law section 220 remain applicable to PLA work including, but not limited to, the enforcement of prevailing wage requirements by the Comptroller; however, we will enforce shift, premium, overtime and other non-standard rates as they appear in a project's pre-negotiated labor agreement.

In order to meet their obligation to provide prevailing supplemental benefits to each covered employee, employers must either:

- 1) Provide bona-fide benefits which cost the employer no less than the prevailing supplemental benefits rate; or
- 2) Supplement the employee's hourly wage by an amount no less than the prevailing supplemental benefits rate; or
- 3) Provide a combination of bona-fide benefits and wage supplements which cost the employer no less than the prevailing supplemental benefits rate in total.

Particular attention should be given to the supplemental benefits requirement. Although in most instances the payment or provision for supplemental benefits is for each hour worked, some classifications require the payment or provision of supplemental benefits for each hour paid. Consequently, some prevailing practices require benefits to be purchased at the overtime, shift differential, Holiday, Saturday, Sunday or other premium time rate.

Benefits are paid for **EACH HOUR WORKED** unless otherwise noted.

Wasył Kinach, P.E.  
Director of Classifications  
Bureau of Labor Law

OFFICE OF THE COMPTROLLER, CITY OF NEW YORK  
 §220 PREVAILING WAGE SCHEDULE

**TABLE OF CONTENTS**

<u>CLASSIFICATION</u>	<u>PAGE</u>
ASBESTOS HANDLER .....	5
BLASTER .....	5
BOILERMAKER.....	7
BRICKLAYER.....	8
CARPENTER - BUILDING COMMERCIAL .....	9
CARPENTER - HEAVY CONSTRUCTION WORK .....	10
CARPENTER - SIDEWALK SHED, SCAFFOLD AND HOIST.....	11
CEMENT & CONCRETE WORKER.....	12
CEMENT MASON.....	13
CORE DRILLER .....	14
DERRICKPERSON AND RIGGER .....	15
DIVER .....	16
DOCKBUILDER - PILE DRIVER.....	17
DRIVER: TRUCK (TEAMSTER) .....	17
ELECTRICIAN .....	20
ELECTRICIAN - ALARM TECHNICIAN.....	23
ELECTRICIAN-STREET LIGHTING WORKER .....	24
ELEVATOR CONSTRUCTOR .....	26
ELEVATOR REPAIR & MAINTENANCE.....	27
ENGINEER .....	28
ENGINEER - CITY SURVEYOR AND CONSULTANT.....	32
ENGINEER - FIELD (BUILDING CONSTRUCTION) .....	33
ENGINEER - FIELD (HEAVY CONSTRUCTION) .....	34
ENGINEER - FIELD (STEEL ERECTION) .....	35
ENGINEER - OPERATING .....	36
FLOOR COVERER .....	44
GLAZIER .....	45
GLAZIER - REPAIR & MAINTENANCE .....	46
HEAT AND FROST INSULATOR .....	47
HOUSE WRECKER .....	48
IRON WORKER - ORNAMENTAL.....	49
IRON WORKER - STRUCTURAL.....	50
LABORER .....	50

**OFFICE OF THE COMPTROLLER, CITY OF NEW YORK  
§220 PREVAILING WAGE SCHEDULE**

LANDSCAPING .....	51
MARBLE MECHANIC .....	53
MASON TENDER .....	54
MASON TENDER (INTERIOR DEMOLITION WORKER) .....	55
METALLIC LATHER .....	56
MILLWRIGHT .....	57
MOSAIC MECHANIC .....	58
PAINTER .....	59
PAINTER - METAL POLISHER .....	60
PAINTER - STRIPER .....	61
PAINTER - STRUCTURAL STEEL .....	62
PAPERHANGER .....	63
PAVER AND ROADBUILDER .....	64
PLASTERER .....	65
PLASTERER - TENDER .....	66
PLUMBER .....	67
PLUMBER (MECHANICAL EQUIPMENT AND SERVICE) .....	68
PLUMBER (RESIDENTIAL RATES FOR 1, 2 AND 3 FAMILY HOME CONSTRUCTION) .....	69
PLUMBER: PUMP & TANK .....	70
POINTER, WATERPROOFER, CAULKER, SANDBLASTER, STEAMBLASTER .....	70
ROOFER .....	71
SHEET METAL WORKER .....	72
SHEET METAL WORKER - SPECIALTY .....	73
SHIPYARD WORKER .....	74
SIGN ERECTOR .....	75
STEAMFITTER .....	76
STEAMFITTER - REFRIGERATION AND AIR CONDITIONER .....	78
STONE MASON - SETTER .....	80
TAPER .....	81
TELECOMMUNICATION WORKER .....	81
TILE FINISHER .....	83
TILE LAYER - SETTER .....	83
TIMBERPERSON .....	84
TUNNEL WORKER .....	85
WELDER .....	87



OFFICE OF THE COMPTROLLER, CITY OF NEW YORK  
§220 PREVAILING WAGE SCHEDULE

**ASBESTOS HANDLER**

(Hazardous Material; Disturbs, removes, encapsulates, repairs, or encloses friable asbestos material)

**Asbestos Handler**

Effective Period: 7/1/2016 - 6/30/2017

Wage Rate per Hour: **\$36.00**

Supplemental Benefit Rate per Hour: **\$16.45**

**Overtime**

Time and one half the regular rate after an 8 hour day.

Time and one half the regular rate for Sunday.

Time and one half the regular hourly rate after 40 hours in any work week.

**Overtime Holidays**

Time and one half the regular rate for work on the following holiday(s).

New Year's Day

Good Friday

Memorial Day

Independence Day

Labor Day

Thanksgiving Day

Christmas Day

Easter

**Paid Holidays**

None

(Local #78 and Local #12A)

---

---

**BLASTER**

**Blaster**

Effective Period: 7/1/2016 - 6/30/2017

Wage Rate per Hour: **\$44.93**

Supplemental Benefit Rate per Hour: **\$46.24**

**Blaster (Hydraulic)**

Effective Period: 7/1/2016 - 6/30/2017

OFFICE OF THE COMPTROLLER, CITY OF NEW YORK  
§220 PREVAILING WAGE SCHEDULE

Wage Rate per Hour: \$45.78  
Supplemental Benefit Rate per Hour: \$46.24

**Blaster - Trac Drill Hydraulic**

Effective Period: 7/1/2016 - 6/30/2017  
Wage Rate per Hour: \$40.12  
Supplemental Benefit Rate per Hour: \$46.24

**Blaster - Wagon: Air Trac: Quarry Bar: Drillrunners**

Effective Period: 7/1/2016 - 6/30/2017  
Wage Rate per Hour: \$39.31  
Supplemental Benefit Rate per Hour: \$46.24

**Blaster - Operators of Jack Hammers**

Chippers: Spaders: Concrete Breakers: and all other pneumatic tools of like usage: Walk Behind Self Propelled Hydraulic Asphalt and Concrete Breakers: Hydro (Water) Demolition

Effective Period: 7/1/2016 - 6/30/2017  
Wage Rate per Hour: \$38.23  
Supplemental Benefit Rate per Hour: \$46.24

**Blaster - Powder Carriers**

Effective Period: 7/1/2016 - 6/30/2017  
Wage Rate per Hour: \$34.20  
Supplemental Benefit Rate per Hour: \$46.24

**Blaster - Hydraulic Trac Drill Chuck Tender**

Effective Period: 7/1/2016 - 6/30/2017  
Wage Rate per Hour: \$32.88  
Supplemental Benefit Rate per Hour: \$46.24

**Blaster - Chuck Tender & Nipper**

Effective Period: 7/1/2016 - 6/30/2017  
Wage Rate per Hour: \$32.10  
Supplemental Benefit Rate per Hour: \$46.24

**Blaster - Magazine Keepers: (Watch Person)**

Effective Period: 7/1/2016 - 6/30/2017  
Wage Rate per Hour: \$17.80  
Supplemental Benefit Rate per Hour: \$46.24

OFFICE OF THE COMPTROLLER, CITY OF NEW YORK  
§220 PREVAILING WAGE SCHEDULE

### Overtime Description

**Magazine Keepers:**

Time and one half for work performed in excess of forty (40) hours per week and for work performed on Saturdays, Sundays and Holidays.

**All Other Employees:**

Time and one-half for the first two hours of overtime Monday through Friday, the first ten hours, the first ten hours of work on Saturday and for Make-up Time. Double time for all hours over ten Monday through Saturday (except make-up hours) and for all hours worked on Sunday and Holidays.

### Overtime Holidays

Double time the regular rate for work on the following holiday(s).

New Year's Day  
Memorial Day  
Independence Day  
Labor Day  
Columbus Day  
Thanksgiving Day  
Christmas Day

### Paid Holidays

None

### Shift Rates

A single shift shall be 8 hours plus an unpaid lunch, starting at 8:00 A.M (or between 6:00 A.M. and 10:00 A.M. on weekdays). When two (2) shifts are employed, each shift shall be 8 hours plus ½ hour unpaid lunch. When three (3) shifts are employed, each shift will work seven and one-half (7 ½) hours, but will be paid for eight (8) hours, since only one-half (½) hour is allowed for mealtime. When two (2) or more shifts are employed, single time will be paid for each shift. The first 8 hours of any and all work performed Monday through Friday inclusive of any off-shift shall be at the single time rate.

(Local #29)

---

---

## BOILERMAKER

### Boilermaker

Effective Period: 7/1/2016 - 12/31/2016

Wage Rate per Hour: \$53.36

Supplemental Benefit Rate per Hour: \$42.33

Supplemental Note: For time and one half overtime - \$62.88 For double overtime - \$83.42

Effective Period: 1/1/2017 - 6/30/2017

Wage Rate per Hour: \$55.23

Supplemental Benefit Rate per Hour: \$42.96

Supplemental Note: For time and one half overtime - \$63.82 For double overtime - \$84.68

OFFICE OF THE COMPTROLLER, CITY OF NEW YORK  
§220 PREVAILING WAGE SCHEDULE

**Overtime Description**

For Repair and Maintenance work:

Time and one half the regular rate after an 8 hour day.

Time and one half the regular rate for Saturday.

Double time the regular rate for Sunday.

For New Construction work:

Double time the regular rate after an 8 hour day.

Double time the regular time rate for Saturday.

Double time the regular rate for Sunday.

**Overtime Holidays**

Double time the regular rate for work on the following holiday(s).

New Year's Day

President's Day

Memorial Day

Independence Day

Columbus Day

Election Day

Veteran's Day

Thanksgiving Day

Christmas Day

Quadruple time the regular rate for work on the following holiday(s).

Labor Day

**Paid Holidays**

Good Friday

Day after Thanksgiving

Day before Christmas

Day before New Year's Day

**Shift Rates**

When shifts are required, the first shift shall work eight (8) hours at the regular straight-time hourly rate. The second shift shall work seven and one-half (7 ½) hours and receive eight hours at the regular straight time hourly rate plus twenty-five cents (\$0.25) per hour. The third shift shall work seven (7) hours and receive eight hours at the regular straight time hourly rate plus fifty cents (\$0.50) per hour. A thirty (30) minute lunch period shall not be considered as time worked. Work in excess of the above shall be paid overtime at the appropriate new construction work or repair work overtime wage and supplemental benefit hourly rate.

(Local #5)

---

**BRICKLAYER**

**Bricklayer**

Effective Period: 7/1/2016 - 6/30/2017

Wage Rate per Hour: \$52.59

PUBLISH DATE: 7/1/2016

EFFECTIVE PERIOD: JULY 1, 2016 THROUGH JUNE 30, 2017

Page 8 of 87

OFFICE OF THE COMPTROLLER, CITY OF NEW YORK  
§220 PREVAILING WAGE SCHEDULE

Supplemental Benefit Rate per Hour: \$30.00

**Overtime**

Time and one half the regular rate after a 7 hour day.

Time and one half the regular rate for Saturday.

Double time the regular rate for Sunday.

Saturday may be used as a make-up day at straight time when a day is lost during that week to inclement weather.

**Overtime Holidays**

Double time the regular rate for work on the following holiday(s).

New Year's Day

President's Day

Memorial Day

Independence Day

Labor Day

Thanksgiving Day

Christmas Day

**Paid Holidays**

None

**Shift Rates**

Overtime rates to be paid outside the regular scheduled work day.

(Bricklayer District Council)

---

---

**CARPENTER - BUILDING COMMERCIAL**

**Building Commercial**

Effective Period: 7/1/2016 - 6/30/2017

Wage Rate per Hour: \$52.50

Supplemental Benefit Rate per Hour: \$46.28

**Overtime**

Time and one half the regular rate after an 8 hour day.

Time and one half the regular rate for Saturday.

Double time the regular rate for Sunday.

Saturday may be used as a make-up day at straight time when a day is lost during that week to inclement weather.

**Overtime Holidays**

Double time the regular rate for work on the following holiday(s).

New Year's Day

Washington's Birthday

OFFICE OF THE COMPTROLLER, CITY OF NEW YORK  
§220 PREVAILING WAGE SCHEDULE

Memorial Day  
Independence Day  
Labor Day  
Columbus Day  
Presidential Election Day  
Thanksgiving Day  
Day after Thanksgiving  
Christmas Day

**Paid Holidays**

None

**Shift Rates**

The second shift will receive one hour at the double time rate of pay for the last hour of the shift; eight hours pay for seven hours of work, nine hours pay for eight hours of work. There must be a first shift in order to work a second shift.

(Carpenters District Council)

---

---

**CARPENTER - HEAVY CONSTRUCTION WORK**  
(Construction of Engineering Structures and Building Foundations)

**Heavy Construction Work**

Effective Period: 7/1/2016 - 6/30/2017

Wage Rate per Hour: \$51.63

Supplemental Benefit Rate per Hour: \$48.65

**Overtime**

Time and one half the regular rate after an 8 hour day.

Time and one half the regular rate for Saturday.

Double time the regular rate for Sunday.

Saturday may be used as a make-up day at straight time when a day is lost during that week to inclement weather.

**Overtime Holidays**

Double time the regular rate for work on the following holiday(s).

New Year's Day

President's Day

Memorial Day

Independence Day

Labor Day

Columbus Day

Presidential Election Day

Thanksgiving Day

Christmas Day

OFFICE OF THE COMPTROLLER, CITY OF NEW YORK  
§220 PREVAILING WAGE SCHEDULE

**Paid Holidays**

None

**Shift Rates**

Off shift work commencing between 5:00 P.M. and 11:00 P.M. shall work eight and one half hours allowing for one half hour for lunch. The wage rate shall be 113% of the straight time hourly wage rate.

(Carpenters District Council)

---

---

**CARPENTER - SIDEWALK SHED, SCAFFOLD AND HOIST**

**Carpenter - Hod Hoist**

(Assisted by Mason Tender)

Effective Period: 7/1/2016 - 6/30/2017

Wage Rate per Hour: \$50.50

Supplemental Benefit Rate per Hour: \$44.80

**Overtime**

Time and one half the regular rate after an 8 hour day.

Time and one half the regular rate for Saturday.

Double time the regular rate for Sunday.

Saturday may be used as a make-up day at straight time when a day is lost during that week to inclement weather.

**Overtime Holidays**

Double time the regular rate for work on the following holiday(s).

New Year's Day

President's Day

Memorial Day

Independence Day

Labor Day

Columbus Day

Presidential Election Day

Thanksgiving Day

Day after Thanksgiving

Christmas Day

**Paid Holidays**

None

**Shift Rates**

OFFICE OF THE COMPTROLLER, CITY OF NEW YORK  
§220 PREVAILING WAGE SCHEDULE

The second shift will receive one hour at the double time rate of pay for the last hour of the shift; eight hours pay for seven hours of work, nine hours pay for eight hours of work. There must be a first shift in order to work a second shift.

(Carpenters District Council)

---

---

## **CEMENT & CONCRETE WORKER**

### **Cement & Concrete Worker**

Effective Period: 7/1/2016 - 6/30/2017

Wage Rate per Hour: \$42.48

Supplemental Benefit Rate per Hour: \$23.00

Supplemental Note: \$25.75 on Saturdays; \$28.50 on Sundays & Holidays

### **Cement & Concrete Worker - (Hired after 2/6/2016)**

Effective Period: 7/1/2016 - 6/30/2017

Wage Rate per Hour: \$32.00

Supplemental Benefit Rate per Hour: \$16.00

Supplemental Note: \$17.25 on Saturdays; \$18.50 on Sundays & Holidays

### **Overtime Description**

Time and one half the regular rate after 7 hour day (time and one half the regular rate after an 8 hour day when working with Dockbuilders on pile cap forms and for work below street level to the top of the foundation wall, not to exceed 2 feet or 3 feet above the sidewalk-brick shelf, when working on the foundation and structure.)

### **Overtime**

Time and one half the regular rate for Saturday.

Double time the regular rate for Sunday.

### **Overtime Holidays**

Double time the regular rate for work on the following holiday(s).

New Year's Day

President's Day

Good Friday

Memorial Day

Independence Day

Labor Day

Columbus Day

Presidential Election Day

Thanksgiving Day

Christmas Day

### **Paid Holidays**

1/2 day before Christmas Day



OFFICE OF THE COMPTROLLER, CITY OF NEW YORK  
§220 PREVAILING WAGE SCHEDULE

1/2 day before New Year's Day

### Shift Rates

On shift work extending over a twenty-four hour period, all shifts are paid at straight time.

(Cement Concrete Workers District Council)

---

## CEMENT MASON

### Cement Mason

Effective Period: 7/1/2016 - 6/30/2017

Wage Rate per Hour: \$40.72

Supplemental Benefit Rate per Hour: \$38.96

Supplemental Note: For time and one half overtime - \$48.21; For double overtime - \$57.46

### Overtime Description

Time and one-half the regular rate after an 8 hour day, double time the regular rate after 10 hours. Time and one-half the regular rate on Saturday, double time the regular rate after 10 hours. Double time the regular rate on Sunday.

### Overtime Holidays

Double time the regular rate for work on the following holiday(s).

New Year's Day  
President's Day  
Good Friday  
Memorial Day  
Independence Day  
Labor Day  
Columbus Day  
Presidential Election Day  
Thanksgiving Day  
Christmas Day

### Paid Holidays

Any worker who reports to work on Christmas Eve or New Year's Eve pursuant to his employer's instruction shall be entitled to three (3) hours afternoon pay without working.

### Shift Rates

For an off shift day, (work at times other than the regular 7:00 A.M. to 3:30 P.M. work day) a cement mason shall be paid at the regular hourly rate plus a 25% per hour differential. Four Days a week at Ten (10)hour day.

(Local #780) (BCA)

---

OFFICE OF THE COMPTROLLER, CITY OF NEW YORK  
§220 PREVAILING WAGE SCHEDULE

---

## **CORE DRILLER**

### **Core Driller**

Effective Period: 7/1/2016 - 6/30/2017  
Wage Rate per Hour: **\$37.82**  
Supplemental Benefit Rate per Hour: **\$24.00**

### **Core Driller Helper**

Effective Period: 7/1/2016 - 6/30/2017  
Wage Rate per Hour: **\$30.17**  
Supplemental Benefit Rate per Hour: **\$24.00**

### **Core Driller Helper(Third year in the industry)**

Effective Period: 7/1/2016 - 6/30/2017  
Wage Rate per Hour: **\$27.15**  
Supplemental Benefit Rate per Hour: **\$24.00**

### **Core Driller Helper (Second year in the industry)**

Effective Period: 7/1/2016 - 6/30/2017  
Wage Rate per Hour: **\$24.14**  
Supplemental Benefit Rate per Hour: **\$24.00**

### **Core Driller Helper (First year in the industry)**

Effective Period: 7/1/2016 - 6/30/2017  
Wage Rate per Hour: **\$21.12**  
Supplemental Benefit Rate per Hour: **\$24.00**

### **Overtime Description**

Time and one half the regular rate for work on a holiday plus Holiday pay when worked.

### **Overtime**

Time and one half the regular rate after an 8 hour day.  
Time and one half the regular rate for Saturday.  
Double time the regular rate for Sunday.  
Time and one half the regular rate for work on the following holiday(s).

### **Paid Holidays**

New Year's Day  
Memorial Day  
Independence Day  
Labor Day

OFFICE OF THE COMPTROLLER, CITY OF NEW YORK  
§220 PREVAILING WAGE SCHEDULE

Thanksgiving Day  
Christmas Day

### Shift Rates

The shift day shall be the continuous eight and one-half (8½) hours from 6:00 A.M. to 2:30 P.M. and from 2:30 P.M. to 11:00 P.M., including one-half (½) hour of employees regular rate of pay for lunch. When two (2) or more shifts are employed, single time shall be paid for each shift, but those employees employed on a shift other than from 8:00 A.M. to 5:00 P.M. shall, in addition, receive seventy-five cents (\$0.75) per hour differential for each hour worked. When three (3) shifts are needed, each shift shall work seven and one-half (7 ½) hours paid for eight (8) hours of labor and be permitted one-half (½) hour for mealtime.

(Carpenters District Council)

---

---

## DERRICKPERSON AND RIGGER

### Derrick Person & Rigger

Effective Period: 7/1/2016 - 6/30/2017

Wage Rate per Hour: \$45.48

Supplemental Benefit Rate per Hour: \$50.00

Supplemental Note: The above supplemental rate applies for work performed in Manhattan, Bronx, Brooklyn and Queens. \$51.42 - For work performed in Staten Island.

### Overtime Description

The first two hours of overtime on weekdays and the first seven hours of work on Saturdays are paid at time and one half for wages and supplemental benefits. All additional overtimes is paid at double time for wages and supplemental benefits. Deduct \$1.42 from the Staten Island hourly benefits rate before computing overtime.

### Overtime

Double time the regular rate for Sunday.

### Overtime Holidays

Double time the regular rate for work on the following holiday(s).

New Year's Day  
Washington's Birthday  
Good Friday  
Memorial Day  
Independence Day  
Labor Day  
Thanksgiving Day  
Christmas Day

### Paid Holidays

1/2 day on Christmas Eve if work is performed in the A.M.

(Local #197)

OFFICE OF THE COMPTROLLER, CITY OF NEW YORK  
§220 PREVAILING WAGE SCHEDULE

---

---

**DIVER**

**Diver (Marine)**

Effective Period: 7/1/2016 - 6/30/2017

Wage Rate per Hour: \$65.38

Supplemental Benefit Rate per Hour: \$48.65

**Diver Tender (Marine)**

Effective Period: 7/1/2016 - 6/30/2017

Wage Rate per Hour: \$46.44

Supplemental Benefit Rate per Hour: \$48.65

**Overtime**

Time and one half the regular rate after an 8 hour day.

Time and one half the regular rate for Saturday.

Double time the regular rate for Sunday.

Saturday may be used as a make-up day at straight time when a day is lost during that week to inclement weather.

**Overtime Holidays**

Double time the regular rate for work on the following holiday(s).

New Year's Day

President's Day

Memorial Day

Independence Day

Labor Day

Columbus Day

Presidential Election Day

Thanksgiving Day

Christmas Day

**Paid Holidays**

None

**Shift Rates**

When three shifts are utilized each shift shall work seven and one half-hours (7 1/2 hours) and paid for 8 hours, allowing for one half-hour for lunch.

(Carpenters District Council)

---

---

OFFICE OF THE COMPTROLLER, CITY OF NEW YORK  
§220 PREVAILING WAGE SCHEDULE

## **DOCKBUILDER - PILE DRIVER**

### **Dockbuilder - Pile Driver**

Effective Period: 7/1/2016 - 6/30/2017

Wage Rate per Hour: **\$51.63**

Supplemental Benefit Rate per Hour: **\$48.65**

### **Overtime**

Time and one half the regular rate after an 8 hour day.

Time and one half the regular rate for Saturday.

Double time the regular rate for Sunday.

Saturday may be used as a make-up day at straight time when a day is lost during that week to inclement weather.

### **Overtime Holidays**

Double time the regular rate for work on the following holiday(s).

New Year's Day

President's Day

Memorial Day

Independence Day

Labor Day

Columbus Day

Presidential Election Day

Thanksgiving Day

Christmas Day

### **Paid Holidays**

None

### **Shift Rates**

Off shift work commencing between 5:00 P.M. and 11:00 P.M. shall work eight and one half hours allowing for one half hour for lunch. The wage rate shall be 113% of the straight time hourly wage rate.

(Carpenters District Council)

---

---

## **DRIVER: TRUCK (TEAMSTER)**

### **Driver - Dump Truck**

Effective Period: 7/1/2016 - 6/30/2017

Wage Rate per Hour: **\$40.15**

Supplemental Benefit Rate per Hour: **\$43.39**

Supplemental Note: Over 40 hours worked: at time and one half rate - \$18.44; at double time rate - \$24.58

OFFICE OF THE COMPTROLLER, CITY OF NEW YORK  
§220 PREVAILING WAGE SCHEDULE

**Driver - Tractor Trailer**

Effective Period: 7/1/2016 - 6/30/2017

Wage Rate per Hour: \$41.46

Supplemental Benefit Rate per Hour: \$43.65

Supplemental Note: Over 40 hours worked: at time and one half rate - \$16.65; at double time rate - \$22.20

**Driver - Euclid & Turnapull Operator**

Effective Period: 7/1/2016 - 6/30/2017

Wage Rate per Hour: \$42.03

Supplemental Benefit Rate per Hour: \$43.65

Supplemental Note: Over 40 hours worked: at time and one half rate - \$16.65; at double time rate - \$22.20

**Overtime Description**

For Paid Holidays: Holiday pay for all holidays shall be prorated based two hours per day for each day worked in the holiday week, not to exceed 8 hours of holiday pay. For Thanksgiving week, the prorated share shall be 5 1/3 hours of holiday pay for each day worked in Thanksgiving week.

**Overtime**

Time and one half the regular rate after an 8 hour day.

Time and one half the regular rate for Saturday.

Double time the regular rate for Sunday.

**Overtime Holidays**

Double time the regular rate for work on the following holiday(s).

New Year's Day  
President's Day  
Memorial Day  
Independence Day  
Labor Day  
Columbus Day  
Veteran's Day  
Thanksgiving Day  
Day after Thanksgiving  
Christmas Day

**Paid Holidays**

New Year's Day  
President's Day  
Memorial Day  
Independence Day  
Labor Day  
Columbus Day  
Veteran's Day  
Thanksgiving Day  
Day after Thanksgiving  
Christmas Day

**Shift Rates**

Off single shift work commencing between 6:00 P.M. and 5:00 A.M. shall work eight and one half hours allowing for one half hour for lunch and receive 9 hours pay for 8 hours of work.

OFFICE OF THE COMPTROLLER, CITY OF NEW YORK  
§220 PREVAILING WAGE SCHEDULE

---

**Driver Redi-Mix (Sand & Gravel)**

Effective Period: 7/1/2016 - 6/30/2017

Wage Rate per Hour: \$36.30

Supplemental Benefit Rate per Hour: \$40.02

Supplemental Note: Over 40 hours worked: time and one half rate \$13.90, double time rate \$18.53

**Overtime Description**

For Paid Holidays: Employees working two (2) days in the calendar week in which the holiday falls are to be paid for these holidays, provided they shape each remaining workday during that calendar week.

**Overtime**

Time and one half the regular rate after an 8 hour day.

Time and one half the regular rate for Saturday.

Double time the regular rate for Sunday.

**Overtime Holidays**

Double time the regular rate for work on the following holiday(s).

President's Day

Columbus Day

Veteran's Day

Triple time the regular rate for work on the following holiday(s).

New Year's Day

Memorial Day

Independence Day

Labor Day

Thanksgiving Day

Christmas Day

**Paid Holidays**

New Year's Day

President's Day

Memorial Day

Independence Day

Labor Day

Columbus Day

Election Day

Thanksgiving Day

Christmas Day

(Local #282)

---

---

OFFICE OF THE COMPTROLLER, CITY OF NEW YORK  
§220 PREVAILING WAGE SCHEDULE

**ELECTRICIAN**

(Including all low voltage cabling carrying data; video; and voice in combination with data and or video.)

**Electrician "A" (Regular Day)**

Effective Period: 7/1/2016 - 5/10/2017

Wage Rate per Hour: \$54.00

Supplemental Benefit Rate per Hour: \$51.86

Effective Period: 5/11/2017 - 6/30/2017

Wage Rate per Hour: \$56.00

Supplemental Benefit Rate per Hour: \$54.35

**Electrician "A" (Regular Day Overtime)**

Effective Period: 7/1/2016 - 5/10/2017

Wage Rate per Hour: \$81.00

Supplemental Benefit Rate per Hour: \$55.24

Effective Period: 5/11/2017 - 6/30/2017

Wage Rate per Hour: \$84.00

Supplemental Benefit Rate per Hour: \$57.86

**Electrician "A" (Day Shift)**

Effective Period: 7/1/2016 - 5/10/2017

Wage Rate per Hour: \$54.00

Supplemental Benefit Rate per Hour: \$51.86

Effective Period: 5/11/2017 - 6/30/2017

Wage Rate per Hour: \$56.00

Supplemental Benefit Rate per Hour: \$54.35

**Electrician "A" (Day Shift Overtime After 8 hours)**

Effective Period: 7/1/2016 - 5/10/2017

Wage Rate per Hour: \$81.00

Supplemental Benefit Rate per Hour: \$55.24

Effective Period: 5/11/2017 - 6/30/2017

Wage Rate per Hour: \$84.00

Supplemental Benefit Rate per Hour: \$57.86

**Electrician "A" (Swing Shift)**

Effective Period: 7/1/2016 - 5/10/2017



OFFICE OF THE COMPTROLLER, CITY OF NEW YORK  
§220 PREVAILING WAGE SCHEDULE

Wage Rate per Hour: \$63.36  
Supplemental Benefit Rate per Hour: \$59.01

Effective Period: 5/11/2017 - 6/30/2017  
Wage Rate per Hour: \$65.71  
Supplemental Benefit Rate per Hour: \$61.94

**Electrician "A" (Swing Shift Overtime After 7.5 hours)**

Effective Period: 7/1/2016 - 5/10/2017  
Wage Rate per Hour: \$95.04  
Supplemental Benefit Rate per Hour: \$62.98

Effective Period: 5/11/2017 - 6/30/2017  
Wage Rate per Hour: \$98.57  
Supplemental Benefit Rate per Hour: \$66.05

**Electrician "A" (Graveyard Shift)**

Effective Period: 7/1/2016 - 5/10/2017  
Wage Rate per Hour: \$70.97  
Supplemental Benefit Rate per Hour: \$65.05

Effective Period: 5/11/2017 - 6/30/2017  
Wage Rate per Hour: \$73.60  
Supplemental Benefit Rate per Hour: \$68.33

**Electrician "A" (Graveyard Shift Overtime After 7 hours)**

Effective Period: 7/1/2016 - 5/10/2017  
Wage Rate per Hour: \$106.46  
Supplemental Benefit Rate per Hour: \$69.50

Effective Period: 5/11/2017 - 6/30/2017  
Wage Rate per Hour: \$110.40  
Supplemental Benefit Rate per Hour: \$72.95

**Overtime**

Time and one half the regular rate after a 7 hour day.  
Time and one half the regular rate for Saturday.  
Time and one half the regular rate for Sunday.

**Overtime Holidays**

Time and one half the regular rate for work on a holiday.  
New Year's Day  
Martin Luther King Jr. Day  
President's Day  
Memorial Day  
Independence Day  
Labor Day

OFFICE OF THE COMPTROLLER, CITY OF NEW YORK  
\$220 PREVAILING WAGE SCHEDULE

Columbus Day  
Veteran's Day  
Thanksgiving Day  
Day after Thanksgiving  
Christmas Day

**Paid Holidays**

None

**Shift Rates**

When so elected by the Employer, one or more shifts of at least five days duration may be scheduled as follows:  
Day Shift: 8:00 am to 4:30 pm, Swing Shift 4:30 pm to 12:30 am, Graveyard Shift: 12:30 am to 8:00 am.

For multiple shifts of temporary light and/or power, the temporary light and/or power employee shall be paid for 8 hours at the straight time rate. For three or less workers performing 8 hours temporary light and/or power the supplemental benefit rate is \$25.14 and effective 5/11/17 \$25.67.

---

**Electrician "M" (First 8 hours)**

"M" rated work shall be defined as jobbing: electrical work of limited duration and scope, also consisting of repairs and/or replacement of electrical and tele-data equipment. Includes all work necessary to retrofit, service, maintain and repair all kinds of lighting fixtures and local lighting controls and washing and cleaning of foregoing fixtures.

Effective Period: 7/1/2016 - 5/10/2017

Wage Rate per Hour: \$28.00

Supplemental Benefit Rate per Hour: \$21.85

First and Second Year "M" Wage Rate Per Hour: \$23.50

First and Second Year "M" Supplemental Rate: \$19.54

Effective Period: 5/11/2017 - 6/30/2017

Wage Rate per Hour: \$28.50

Supplemental Benefit Rate per Hour: \$22.10

First and Second Year "M" Wage Rate Per Hour: \$24.00

First and Second Year "M" Supplemental Rate: \$19.80

**Electrician "M" (Overtime After First 8 hours)**

"M" rated work shall be defined as jobbing: electrical work of limited duration and scope, also consisting of repairs and/or replacement of electrical and tele-data equipment. Includes all work necessary to retrofit, service, maintain and repair all kinds of lighting fixtures and local lighting controls and washing and cleaning of foregoing fixtures.

Effective Period: 7/1/2016 - 5/10/2017

Wage Rate per Hour: \$42.00

Supplemental Benefit Rate per Hour: \$23.60

First and Second Year "M" Wage Rate Per Hour: \$35.25

First and Second Year "M" Supplemental Rate: \$21.01

OFFICE OF THE COMPTROLLER, CITY OF NEW YORK  
§220 PREVAILING WAGE SCHEDULE

Effective Period: 5/11/2017 - 6/30/2017

Wage Rate per Hour: \$42.75

Supplemental Benefit Rate per Hour: \$23.89

First and Second Year "M" Wage Rate Per Hour: \$36.00

First and Second Year "M" Supplemental Rate: \$21.30

### Overtime

Time and one half the regular rate after an 8 hour day.

Time and one half the regular rate for Saturday.

Time and one half the regular rate for Sunday.

### Overtime Holidays

Time and one half the regular rate for work on the following holiday(s).

New Year's Day

Martin Luther King Jr. Day

President's Day

Memorial Day

Independence Day

Labor Day

Columbus Day

Veteran's Day

Thanksgiving Day

Day after Thanksgiving

Christmas Day

### Paid Holidays

None

(Local #3)

---

## ELECTRICIAN - ALARM TECHNICIAN

(Scope of Work - Inspect, test, repair, and replace defective, malfunctioning, or broken devices, components and controls of Fire, Burglar and Security Systems)

### Alarm Technician

Effective Period: 7/1/2016 - 3/9/2017

Wage Rate per Hour: \$32.00

Supplemental Benefit Rate per Hour: \$15.47

Supplemental Note: \$13.97 only after 8 hours worked in a day

Effective Period: 3/10/2017 - 6/30/2017

Wage Rate per Hour: \$32.40

Supplemental Benefit Rate per Hour: \$16.10

OFFICE OF THE COMPTROLLER, CITY OF NEW YORK  
§220 PREVAILING WAGE SCHEDULE

Supplemental Note: \$14.60 only after 8 hours worked in a day

**Overtime Description**

Time and one half the regular rate for work on the following holidays: Columbus Day, Veterans Day, Day after Thanksgiving.

Double time the regular rate for work on the following holidays: New Year's day, Martin Luther King Jr. Day, President's Day, Memorial Day, Independence Day, Labor Day, Thanksgiving Day, Christmas Day.

**Overtime**

Time and one half the regular rate after an 8 hour day.

Time and one half the regular rate for Saturday.

Double time the regular rate for Sunday.

**Paid Holidays**

- New Year's Day
- Martin Luther King Jr. Day
- President's Day
- Memorial Day
- Independence Day
- Labor Day
- Columbus Day
- Veteran's Day
- Thanksgiving Day
- Day after Thanksgiving
- Christmas Day

**Shift Rates**

Night Differential is based upon a ten percent (10%) differential between the hours of 4:00 P.M. and 12:30 A.M. and a fifteen percent (15%) differential for the hours 12:00 A.M. to 8:00 A.M.

**Vacation**

- At least 1 year of employment.....ten (10) days
- 5 years or more of employment.....fifteen (15) days
- 10 years of employment.....twenty (20) days
- Plus one Personal Day per year

**Sick Days:**

One day per Year. Up to 4 vacation days may be used as sick days.

(Local #3)

---

---

**ELECTRICIAN-STREET LIGHTING WORKER**

**Electrician - Electro Pole Electrician**

Effective Period: 7/1/2016 - 5/17/2017

Wage Rate per Hour: \$54.00

Supplemental Benefit Rate per Hour: \$53.69

OFFICE OF THE COMPTROLLER, CITY OF NEW YORK  
§220 PREVAILING WAGE SCHEDULE

Effective Period: 5/18/2017 - 6/30/2017  
Wage Rate per Hour: \$56.00  
Supplemental Benefit Rate per Hour: \$56.26

**Electrician - Electro Pole Foundation Installer**

Effective Period: 7/1/2016 - 5/17/2017  
Wage Rate per Hour: \$40.93  
Supplemental Benefit Rate per Hour: \$40.12

Effective Period: 5/18/2017 - 6/30/2017  
Wage Rate per Hour: \$41.54  
Supplemental Benefit Rate per Hour: \$41.02

**Electrician - Electro Pole Maintainer**

Effective Period: 7/1/2016 - 5/17/2017  
Wage Rate per Hour: \$35.05  
Supplemental Benefit Rate per Hour: \$36.11

Effective Period: 5/18/2017 - 6/30/2017  
Wage Rate per Hour: \$35.58  
Supplemental Benefit Rate per Hour: \$36.89

**Overtime Description**

Electrician - Electro Pole Electrician: Time and one half the regular rate after a 7 hour day and after 5 consecutive days worked per week.

Electrician - Electro Pole Foundation Installer: Time and one half the regular rate after 8 hours within a 24 hour period and Saturday and Sunday.

Electrician - Electro Pole Maintainer: Time and one half the regular rate after a 7 hour day and after 5 consecutive days worked per week. Saturdays and Sundays may be used as a make-up day at straight time when a day is lost during the week to inclement weather.

**Overtime Holidays**

Time and one half the regular rate for work on the following holiday(s).

New Year's Day  
Martin Luther King Jr. Day  
President's Day  
Memorial Day  
Independence Day  
Labor Day  
Columbus Day  
Veteran's Day  
Thanksgiving Day  
Day after Thanksgiving  
Christmas Day

**Paid Holidays**

None

OFFICE OF THE COMPTROLLER, CITY OF NEW YORK  
§220 PREVAILING WAGE SCHEDULE

(Local #3)

---

---

## ELEVATOR CONSTRUCTOR

### Elevator Constructor

Effective Period: 7/1/2016 - 3/16/2017

Wage Rate per Hour: \$60.96

Supplemental Benefit Rate per Hour: \$32.65

Effective Period: 3/17/2017 - 6/30/2017

Wage Rate per Hour: \$62.64

Supplemental Benefit Rate per Hour: \$34.25

### Overtime Description

For New Construction: work performed after 7 or 8 hour day, Saturday, Sunday or between 4:30pm and 7:00am shall be paid at double time rate.

Existing buildings: work performed after an 8 hour day, Saturday, Sunday or between 5:30pm and 7:00 am shall be paid time and one half.

### Overtime

Double time the regular rate for work on the following holiday(s).

### Paid Holidays

New Year's Day  
President's Day  
Good Friday  
Memorial Day  
Independence Day  
Labor Day  
Columbus Day  
Veteran's Day  
Thanksgiving Day  
Day after Thanksgiving  
Christmas Day

### Vacation

Employer contributes 8% of regular basic hourly rate as vacation pay for employees with more than 15 years of service, and 6% for employees with 5 to 15 years of service, and 4% for employees with less than 5 years of service.

(Local #1)

---

---

OFFICE OF THE COMPTROLLER, CITY OF NEW YORK  
§220 PREVAILING WAGE SCHEDULE

## ELEVATOR REPAIR & MAINTENANCE

### Elevator Service/Modernization Mechanic

Effective Period: 7/1/2016 - 3/16/2017

Wage Rate per Hour: \$47.91

Supplemental Benefit Rate per Hour: \$32.51

Effective Period: 3/17/2017 - 6/30/2017

Wage Rate per Hour: \$49.14

Supplemental Benefit Rate per Hour: \$34.11

### Overtime Description

For Scheduled Service Work: Double time - work scheduled in advance by two or more workers performed on Sundays, Holidays, and between midnight and 7:00am.

### Overtime

Time and one half the regular rate after an 8 hour day.

Time and one half the regular rate for Saturday.

Time and one half the regular rate for Sunday.

Time and one half the regular rate for work on a holiday plus the day's pay.

### Paid Holidays

New Year's Day

President's Day

Good Friday

Memorial Day

Independence Day

Labor Day

Columbus Day

Veteran's Day

Thanksgiving Day

Day after Thanksgiving

Christmas Day

### Shift Rates

Afternoon shift - regularly hourly rate plus a (15%) fifteen percent differential. Graveyard shift - time and one half the regular rate.

### Vacation

Employer contributes 8% of regular basic hourly rate as vacation pay for employees with more than 15 years of service, and 6% for employees with 5 to 15 years of service, and 4% for employees with less than 5 years of service.

(Local #1)

---

---

OFFICE OF THE COMPTROLLER, CITY OF NEW YORK  
§220 PREVAILING WAGE SCHEDULE

## **ENGINEER**

### **Engineer - Heavy Construction Operating Engineer I**

Cherrypickers 20 tons and over and Loaders (rubber tired and/or tractor type with a manufacturer's minimum rated capacity of six cubic yards and over).

Effective Period: 7/1/2016 - 6/30/2017

Wage Rate per Hour: **\$65.94**

Supplemental Benefit Rate per Hour: **\$35.41**

Supplemental Note: \$63.67 on overtime

Shift Wage Rate: **\$105.50**

### **Engineer - Heavy Construction Operating Engineer II**

Backhoes, Basin Machines, Groover, Mechanical Sweepers, Bobcat, Boom Truck, Barrier Transport (Barrier Mover) & machines of similar nature. Operation of Churn Drills and machines of a similar nature, Stetco Silent Hoist and machines of similar nature, Vac-Alls, Meyers Machines, John Beam and machines of a similar nature, Ross Carriers and Travel Lifts and machines of a similar nature, Bulldozers, Scrapers and Turn-a-Pulls: Tugger Hoists (Used exclusively for handling excavated material); Tractors with attachments, Hyster and Roustabout Cranes, Cherrypickers, Austin Western, Grove and machines of a similar nature, Scoopmobiles, Monorails, Conveyors, Trenchers: Loaders-Rubber Tired and Tractor: Barber Greene and Eimco Loaders and Eimco Backhoes; Mighty Midget and similar breakers and Tampers, Curb and Gutter Pavers and Motor Patrol, Motor Graders and all machines of a similar nature. Locomotives 10 Tons or under. Mini-Max, Break-Tech and machines of a similar nature; Milling machines, robotic and demolition machines and machines of a similar nature, shot blaster, skid steer machines and machines of a similar nature including bobcat, pile rig rubber-tired excavator (37,000 lbs. and under), 2 man auger.

Effective Period: 7/1/2016 - 6/30/2017

Wage Rate per Hour: **\$63.98**

Supplemental Benefit Rate per Hour: **\$35.41**

Supplemental Note: \$63.67 on overtime

Shift Wage Rate: **\$102.37**

### **Engineer - Heavy Construction Operating Engineer III**

Minor Equipment such as Tractors, Post Hole Diggers, Ditch Witch (Walk Behind), Road Finishing Machines, Rollers five tons and under, Tugger Hoists, Dual Purpose Trucks, Fork Lifts, and Dempsey Dumpers, Fireperson.

Effective Period: 7/1/2016 - 6/30/2017

Wage Rate per Hour: **\$60.69**

Supplemental Benefit Rate per Hour: **\$35.41**

Supplemental Note: \$63.67 on overtime

Shift Wage Rate: **\$97.10**

### **Engineer - Heavy Construction Maintenance Engineer I**

Installing, Repairing, Maintaining, Dismantling and Manning of all equipment including Steel Cutting, Bending and Heat Sealing Machines, Mechanical Heaters, Grout Pumps, Bentonite Pumps & Plants, Screening Machines, Fusion Coupling Machines, Tunnel Boring Machines Moles and Machines of a similar nature, Power Packs, Mechanical Hydraulic Jacks; all drill rigs including but not limited to Churn, Rotary Caisson, Raised Bore & Drills



OFFICE OF THE COMPTROLLER, CITY OF NEW YORK  
§220- PREVAILING WAGE SCHEDULE

of a similar nature; Personnel, Inspection & Safety Boats or any boats used to perform functions of same, Mine Hoists, Whirlies, all Climbing Cranes, all Tower Cranes, including but not limited to Truck Mounted and Crawler Type and machines of similar nature; Maintaining Hydraulic Drills and machines of a similar nature; Well Point System-Installation and dismantling; Burning, Welding, all Pumps regardless of size and/or motor power, except River Cofferdam Pumps and Wells Point Pumps; Motorized Buggies (three or more); equipment used in the cleaning and televising of sewers, but not limited to jet-rodder/vacuum truck, vacall/vactor, closed circuit television inspection equipment; high powered water pumps, jet pumps; screed machines and concrete finishing machines of a similar nature; vermeers.

Effective Period: 7/1/2016 - 6/30/2017

Wage Rate per Hour: \$63.68

Supplemental Benefit Rate per Hour: \$35.41

Supplemental Note: \$63.67 on overtime

Shift Wage Rate: \$101.89

**Engineer - Heavy Construction Maintenance Engineer II**

On Base Mounted Tower Cranes

Effective Period: 7/1/2016 - 6/30/2017

Wage Rate per Hour: \$83.66

Supplemental Benefit Rate per Hour: \$35.41

Supplemental Note: \$63.67 on overtime

Shift Wage Rate: \$133.86

**Engineer - Heavy Construction Maintenance Engineer III**

On Generators, Light Towers

Effective Period: 7/1/2016 - 6/30/2017

Wage Rate per Hour: \$42.01

Supplemental Benefit Rate per Hour: \$35.41

Supplemental Note: \$63.67 on overtime

Shift Wage Rate: \$67.22

**Engineer - Heavy Construction Maintenance Engineer IV**

On Pumps and Mixers including mud sucking

Effective Period: 7/1/2016 - 6/30/2017

Wage Rate per Hour: \$43.11

Supplemental Benefit Rate per Hour: \$35.41

Supplemental Note: \$63.67 on overtime

Shift Wage Rate: \$68.98

**Engineer - Heavy Construction Oilers I**

Gradalls, Cold Planer Grader, Concrete Pumps, Driving Truck Cranes, Driving and Operating Fuel and Grease Trucks.

Effective Period: 7/1/2016 - 6/30/2017

OFFICE OF THE COMPTROLLER, CITY OF NEW YORK  
\$220 PREVAILING WAGE SCHEDULE

Wage Rate per Hour: \$57.42  
Supplemental Benefit Rate per Hour: \$35.41  
Supplemental Note: \$63.67 on overtime  
Shift Wage Rate: \$91.87

**Engineer - Heavy Construction Oilers II**

All gasoline, electric, diesel or air operated Shovels, Draglines, Backhoes, Keystones, Pavers, Guniting Machines, Battery of Compressors, Crawler Cranes, two-person Trenching Machines.

Effective Period: 7/1/2016 - 6/30/2017  
Wage Rate per Hour: \$39.70  
Supplemental Benefit Rate per Hour: \$35.41  
Supplemental Note: \$63.67 on overtime  
Shift Wage Rate: \$63.52

**Engineer - Steel Erection Maintenance Engineers**

Derrick, Travelers, Tower, Crawler Tower and Climbing Cranes

Effective Period: 7/1/2016 - 6/30/2017  
Wage Rate per Hour: \$61.13  
Supplemental Benefit Rate per Hour: \$35.41  
Supplemental Note: \$63.67 on overtime  
Shift Wage Rate: \$97.81

**Engineer - Steel Erection Oiler I**

On a Truck Crane

Effective Period: 7/1/2016 - 6/30/2017  
Wage Rate per Hour: \$57.21  
Supplemental Benefit Rate per Hour: \$35.41  
Supplemental Note: \$63.67 on overtime  
Shift Wage Rate: \$91.54

**Engineer - Steel Erection Oiler II**

On a Crawler Crane

Effective Period: 7/1/2016 - 6/30/2017  
Wage Rate per Hour: \$43.54  
Supplemental Benefit Rate per Hour: \$35.41  
Supplemental Note: \$63.67 on overtime  
Shift Wage Rate: \$69.66

**Overtime Description**

On jobs of more than one shift, if the next shift employee fails to report for work through any cause over which the employer has no control, the employee on duty who works the next shift continues to work at the single time rate.

OFFICE OF THE COMPTROLLER, CITY OF NEW YORK  
§220 PREVAILING WAGE SCHEDULE

**Overtime**

Double time the regular rate after an 8 hour day.  
Double time the regular time rate for Saturday.  
Double time the regular rate for Sunday.  
Double time the regular rate for work on the following holiday(s).

**Paid Holidays**

New Year's Day  
Lincoln's Birthday  
President's Day  
Memorial Day  
Independence Day  
Labor Day  
Columbus Day  
Veteran's Day  
Thanksgiving Day  
Day after Thanksgiving  
Christmas Day

Employees must work at least one day in the payroll week in which the holiday occurs to receive the paid holiday

---

**Engineer - Building Work Maintenance Engineers I**

Installing, repairing, maintaining, dismantling (of all equipment including: Steel Cutting and Bending Machines, Mechanical Heaters, Mine Hoists, Climbing Cranes, Tower Cranes, Linden Peine, Lorain, Liebherr, Mannes, or machines of a similar nature, Well Point Systems, Deep Well Pumps, Concrete Mixers with loading Device, Concrete Plants, Motor Generators when used for temporary power and lights), skid steer machines of a similar nature including bobcat.

Effective Period: 7/1/2016 - 6/30/2017

Wage Rate per Hour: \$58.30

Supplemental Benefit Rate per Hour: \$35.41

Supplemental Note: \$63.67 on overtime

**Engineer - Building Work Maintenance Engineers II**

On Pumps, Generators, Mixers and Heaters

Effective Period: 7/1/2016 - 6/30/2017

Wage Rate per Hour: \$45.28

Supplemental Benefit Rate per Hour: \$35.41

Supplemental Note: \$63.67 on overtime

**Engineer - Building Work Oilers I**

All gasoline, electric, diesel or air operated Gradealls: Concrete Pumps, Overhead Cranes in Power Houses: Their duties shall be to assist the Engineer in oiling, greasing and repairing of all machines; Driving Truck Cranes: Driving and Operating Fuel and Grease Trucks, Cherrypickers (hydraulic cranes) over 70,000 GVW, and machines of a similar nature.

OFFICE OF THE COMPTROLLER, CITY OF NEW YORK  
§220 PREVAILING WAGE SCHEDULE

Effective Period: 7/1/2016 - 6/30/2017  
Wage Rate per Hour: \$55.42  
Supplemental Benefit Rate per Hour: \$35.41  
Supplemental Note: \$63.67 on overtime

**Engineer - Building Work Oilers II**

Oilers on Crawler Cranes, Backhoes, Trenching Machines, Gunite Machines, Compressors (three or more in Battery).

Effective Period: 7/1/2016 - 6/30/2017  
Wage Rate per Hour: \$41.16  
Supplemental Benefit Rate per Hour: \$35.41  
Supplemental Note: \$63.67 on overtime

**Overtime Description**

On jobs of more than one shift, if an Employee fails to report for work through any cause over which the Employer has no control, the Employee on duty will continue to work at the rate of single time.

**Overtime**

Double time the regular rate after an 8 hour day.  
Double time the regular time rate for Saturday.  
Double time the regular rate for Sunday.  
Double time the regular rate for work on the following holiday(s).

**Paid Holidays**

New Year's Day  
Lincoln's Birthday  
President's Day  
Memorial Day  
Independence Day  
Labor Day  
Columbus Day  
Veteran's Day  
Thanksgiving Day  
Christmas Day

Employees must work at least one day in the payroll week in which the holiday occurs to receive the paid holiday

**Shift Rates**

Off Shift: double time the regular hourly rate.

(Local #15)

---

---

**ENGINEER - CITY SURVEYOR AND CONSULTANT**

OFFICE OF THE COMPTROLLER, CITY OF NEW YORK  
§220 PREVAILING WAGE SCHEDULE

**Party Chief**

Effective Period: 7/1/2016 - 6/30/2017

Wage Rate per Hour: \$38.18

Supplemental Benefit Rate per Hour: \$20.15

Supplemental Note: Overtime Benefit Rate - \$27.65 per hour (time & one half) \$35.15 per hour (double time).

**Instrument Person**

Effective Period: 7/1/2016 - 6/30/2017

Wage Rate per Hour: \$31.47

Supplemental Benefit Rate per Hour: \$20.15

Supplemental Note: Overtime Benefit Rate - \$27.65 per hour (time & one half) \$35.15 per hour (double time).

**Rodperson**

Effective Period: 7/1/2016 - 6/30/2017

Wage Rate per Hour: \$27.24

Supplemental Benefit Rate per Hour: \$20.15

Supplemental Note: Overtime Benefit Rate - \$27.65 per hour (time & one half) \$35.15 per hour (double time).

**Overtime Description**

Time and one half the regular rate after an 8 hour day, Time and one half the regular rate for Saturday for the first eight hours worked, Double time the regular time rate for Saturday for work performed in excess of eight hours, Double time the regular rate for Sunday and Double time the regular rate for work on a holiday.

**Paid Holidays**

New Year's Day  
Lincoln's Birthday  
President's Day  
Memorial Day  
Independence Day  
Labor Day  
Columbus Day  
Veteran's Day  
Thanksgiving Day  
Day after Thanksgiving  
Christmas Day

Employees must work at least one day in the payroll week in which the holiday occurs to receive the paid holiday

(Operating Engineer Local #15-D)

---

---

**ENGINEER - FIELD (BUILDING CONSTRUCTION)**  
**(Construction of Building Projects, Concrete Superstructures, etc.)**

OFFICE OF THE COMPTROLLER, CITY OF NEW YORK  
§220 PREVAILING WAGE SCHEDULE

**Field Engineer - BC Party Chief**

Effective Period: 7/1/2016 - 6/30/2017

Wage Rate per Hour: \$60.10

Supplemental Benefit Rate per Hour: \$32.15

Supplemental Note: Overtime Benefit Rate - \$44.90 per hour (time & one half) \$57.65 per hour (double time).

**Field Engineer - BC Instrument Person**

Effective Period: 7/1/2016 - 6/30/2017

Wage Rate per Hour: \$46.69

Supplemental Benefit Rate per Hour: \$32.15

Supplemental Note: Overtime Benefit Rate - \$44.90 per hour (time & one half) \$57.65 per hour (double time).

**Field Engineer - BC Rodperson**

Effective Period: 7/1/2016 - 6/30/2017

Wage Rate per Hour: \$30.20

Supplemental Benefit Rate per Hour: \$32.15

Supplemental Note: Overtime Benefit Rate - \$44.90 per hour (time & one half) \$57.65 per hour (double time).

**Overtime Description**

Time and one half the regular rate after a 7 hour work and time and one half the regular rate for Saturday for the first seven hours worked, Double time the regular time rate for Saturday for work performed in excess of seven hours, Double time the regular rate for Sunday and Double time the regular rate for work on a holiday.

**Paid Holidays**

New Year's Day

President's Day

Good Friday

Memorial Day

Independence Day

Labor Day

Columbus Day

Veteran's Day

Thanksgiving Day

Christmas Day

Employees must work at least one day in the payroll week in which the holiday occurs to receive the paid holiday

(Operating Engineer Local #15-D)

---

**ENGINEER - FIELD (HEAVY CONSTRUCTION)**

(Construction of Roads, Tunnels, Bridges, Sewers, Building Foundations,  
Engineering Structures etc.)

OFFICE OF THE COMPTROLLER, CITY OF NEW YORK  
\$220 PREVAILING WAGE SCHEDULE

**Field Engineer - HC Party Chief**

Effective Period: 7/1/2016 - 6/30/2017

Wage Rate per Hour: **\$68.09**

Supplemental Benefit Rate per Hour: **\$33.54**

Supplemental Note: Overtime benefit rate - \$46.86 per hour (time & one half), \$60.18 per hour (double time).

**Field Engineer - HC Instrument Person**

Effective Period: 7/1/2016 - 6/30/2017

Wage Rate per Hour: **\$49.98**

Supplemental Benefit Rate per Hour: **\$33.54**

Supplemental Note: Overtime benefit rate - \$46.86 per hour (time & one half), \$60.18 per hour (double time).

**Field Engineer - HC Rodperson**

Effective Period: 7/1/2016 - 6/30/2017

Wage Rate per Hour: **\$41.93**

Supplemental Benefit Rate per Hour: **\$33.54**

Supplemental Note: Overtime benefit rate - \$46.86 per hour (time & one half), \$60.18 per hour (double time).

**Overtime Description**

Time and one half the regular rate after an 8 hour day, Time and one half the regular rate for Saturday for the first eight hours worked, Double time the regular time rate for Saturday for work performed in excess of eight hours, Double time the regular rate for Sunday and Double time the regular rate for work on a holiday.

**Paid Holidays**

New Year's Day  
Lincoln's Birthday  
President's Day  
Memorial Day  
Independence Day  
Labor Day  
Columbus Day  
Veteran's Day  
Thanksgiving Day  
Christmas Day

Employees must work at least one day in the payroll week in which the holiday occurs to receive the paid holiday

(Operating Engineer Local #15-D)

---

---

**ENGINEER - FIELD (STEEL ERECTION)**

**Field Engineer - Steel Erection Party Chief**

OFFICE OF THE COMPTROLLER, CITY OF NEW YORK  
§220 PREVAILING WAGE SCHEDULE

Effective Period: 7/1/2016 - 6/30/2017

Wage Rate per Hour: \$63.64

Supplemental Benefit Rate per Hour: \$33.04

Supplemental Note: Overtime benefit rate - \$46.11 per hour (time & one half), \$59.18 per hour (double time).

**Field Engineer - Steel Erection Instrument Person**

Effective Period: 7/1/2016 - 6/30/2017

Wage Rate per Hour: \$49.59

Supplemental Benefit Rate per Hour: \$33.04

Supplemental Note: Overtime benefit rate - \$46.11 per hour (time & one half), \$59.18 per hour (double time).

**Field Engineer - Steel Erection Rodperson**

Effective Period: 7/1/2016 - 6/30/2017

Wage Rate per Hour: \$33.20

Supplemental Benefit Rate per Hour: \$33.04

Supplemental Note: Overtime benefit rate - \$46.11 per hour (time & one half), \$59.18 per hour (double time).

**Overtime Description**

Time and one half the regular rate for Saturday for the first eight hours worked.  
Double time the regular rate for Saturday for work performed in excess of eight hours.

**Overtime**

Time and one half the regular rate after an 8 hour day.  
Double time the regular rate for Sunday.  
Double time the regular rate for work on the following holiday(s).

**Paid Holidays**

New Year's Day  
Lincoln's Birthday  
President's Day  
Memorial Day  
Independence Day  
Labor Day  
Columbus Day  
Veteran's Day  
Thanksgiving Day  
Christmas Day

Employees must work at least one day in the payroll week in which the holiday occurs to receive the paid holiday

(Operating Engineer Local #15-D)

---

**ENGINEER - OPERATING**

**Operating Engineer - Road & Heavy Construction I**



OFFICE OF THE COMPTROLLER, CITY OF NEW YORK  
§220 PREVAILING WAGE SCHEDULE

Back Filling Machines, Cranes, Mucking Machines and Dual Drum Paver.

Effective Period: 7/1/2016 - 6/30/2017  
Wage Rate per Hour: \$73.90  
Supplemental Benefit Rate per Hour: \$31.10  
Supplemental Note: \$56.50 overtime hours  
Shift Wage Rate: \$118.24

**Operating Engineer - Road & Heavy Construction II**

Backhoes, Power Shovels, Hydraulic Clam Shells, Steel Erection, Moles and machines of a similar nature.

Effective Period: 7/1/2016 - 6/30/2017  
Wage Rate per Hour: \$76.51  
Supplemental Benefit Rate per Hour: \$31.10  
Supplemental Note: \$56.50 overtime hours  
Shift Wage Rate: \$122.42

**Operating Engineer - Road & Heavy Construction III**

Mine Hoists, Cranes, etc. (Used as Mine Hoists)

Effective Period: 7/1/2016 - 6/30/2017  
Wage Rate per Hour: \$78.96  
Supplemental Benefit Rate per Hour: \$31.10  
Supplemental Note: \$56.50 overtime hours  
Shift Wage Rate: \$126.34

**Operating Engineer - Road & Heavy Construction IV**

Gradealls, Keystones, Cranes on land or water (with digging buckets), Bridge Cranes, Vermeer Cutter and machines of a similar nature, Trenching Machines.

Effective Period: 7/1/2016 - 6/30/2017  
Wage Rate per Hour: \$77.07  
Supplemental Benefit Rate per Hour: \$31.10  
Supplemental Note: \$56.50 overtime hours  
Shift Wage Rate: \$123.31

**Operating Engineer - Road & Heavy Construction V**

Pile Drivers & Rigs (employing Dock Builder foreperson): Derrick Boats, Tunnel Shovels.

Effective Period: 7/1/2016 - 6/30/2017  
Wage Rate per Hour: \$75.55  
Supplemental Benefit Rate per Hour: \$31.10  
Supplemental Note: \$56.50 overtime hours  
Shift Wage Rate: \$120.88

OFFICE OF THE COMPTROLLER, CITY OF NEW YORK  
§220 PREVAILING WAGE SCHEDULE

**Operating Engineer - Road & Heavy Construction VI**

Mixers (Concrete with loading attachment), Concrete Pavers, Cableways, Land Derricks, Power Houses (Low Air Pressure Units).

Effective Period: 7/1/2016 - 6/30/2017

Wage Rate per Hour: \$71.78

Supplemental Benefit Rate per Hour: \$31.10

Supplemental Note: \$56.50 overtime hours

Shift Wage Rate: \$114.85

**Operating Engineer - Road & Heavy Construction VII**

Barrier Movers , Barrier Transport and Machines of a Similar Nature.

Effective Period: 7/1/2016 - 6/30/2017

Wage Rate per Hour: \$57.96

Supplemental Benefit Rate per Hour: \$31.10

Supplemental Note: \$56.50 overtime hours

Shift Wage Rate: \$92.74

**Operating Engineer - Road & Heavy Construction VIII**

Utility Compressors

Effective Period: 7/1/2016 - 6/30/2017

Wage Rate per Hour: \$44.98

Supplemental Benefit Rate per Hour: \$31.10

Supplemental Note: \$56.50 overtime hours

Shift Wage Rate: \$56.70

**Operating Engineer - Road & Heavy Construction IX**

Horizontal Boring Rig

Effective Period: 7/1/2016 - 6/30/2017

Wage Rate per Hour: \$68.25

Supplemental Benefit Rate per Hour: \$31.10

Supplemental Note: \$56.50 overtime hours

Shift Wage Rate: \$109.20

**Operating Engineer - Road & Heavy Construction X**

Elevators (manually operated as personnel hoist).

Effective Period: 7/1/2016 - 6/30/2017

Wage Rate per Hour: \$62.73

Supplemental Benefit Rate per Hour: \$31.10

Supplemental Note: \$56.50 overtime hours

Shift Wage Rate: \$100.37

OFFICE OF THE COMPTROLLER, CITY OF NEW YORK  
§220 PREVAILING WAGE SCHEDULE

**Operating Engineer - Road & Heavy Construction XI**

Compressors (Portable 3 or more in battery), Driving of Truck Mounted Compressors, Well-point Pumps, Tugger Machines Well Point Pumps, Churn Drill.

Effective Period: 7/1/2016 - 6/30/2017

Wage Rate per Hour: \$48.73

Supplemental Benefit Rate per Hour: \$31.10

Supplemental Note: \$56.50 overtime hours

Shift Wage Rate: \$77.97

**Operating Engineer - Road & Heavy Construction XII**

All Drills and Machines of a similar nature.

Effective Period: 7/1/2016 - 6/30/2017

Wage Rate per Hour: \$72.53

Supplemental Benefit Rate per Hour: \$31.10

Supplemental Note: \$56.50 overtime hours

Shift Wage Rate: \$116.05

**Operating Engineer - Road & Heavy Construction XIII**

Concrete Pumps, Concrete Plant, Stone Crushers, Double Drum Hoist, Power Houses (other than above).

Effective Period: 7/1/2016 - 6/30/2017

Wage Rate per Hour: \$70.24

Supplemental Benefit Rate per Hour: \$31.10

Supplemental Note: \$56.50 overtime hours

Shift Wage Rate: \$112.38

**Operating Engineer - Road & Heavy Construction XIV**

Concrete Mixer

Effective Period: 7/1/2016 - 6/30/2017

Wage Rate per Hour: \$67.16

Supplemental Benefit Rate per Hour: \$31.10

Supplemental Note: \$56.50 overtime hours

Shift Wage Rate: \$107.46

**Operating Engineer - Road & Heavy Construction XV**

Compressors (Portable Single or two in Battery, not over 100 feet apart), Pumps (River Cofferdam) and Welding Machines, Push Button Machines, All Engines Irrespective of Power (Power-Pac) used to drive auxiliary equipment, Air, Hydraulic, etc.

Effective Period: 7/1/2016 - 6/30/2017

Wage Rate per Hour: \$45.27

OFFICE OF THE COMPTROLLER, CITY OF NEW YORK  
§220 PREVAILING WAGE SCHEDULE

Supplemental Benefit Rate per Hour: **\$31.10**  
Supplemental Note: **\$56.50** overtime hours  
Shift Wage Rate: **\$72.43**

**Operating Engineer - Road & Heavy Construction XVI**

Concrete Breaking Machines, Hoists (Single Drum), Load Masters, Locomotives (over ten tons) and Dinkies over ten tons, Hydraulic Crane-Second Engineer.

Effective Period: 7/1/2016 - 6/30/2017  
Wage Rate per Hour: **\$64.13**  
Supplemental Benefit Rate per Hour: **\$31.10**  
Supplemental Note: **\$56.50** overtime hours  
Shift Wage Rate: **\$102.61**

**Operating Engineer - Road & Heavy Construction XVII**

On-Site concrete plant engineer, On-site Asphalt Plant Engineer, and Vibratory console.

Effective Period: 7/1/2016 - 6/30/2017  
Wage Rate per Hour: **\$64.63**  
Supplemental Benefit Rate per Hour: **\$31.10**  
Supplemental Note: **\$56.50** overtime hours  
Shift Wage Rate: **\$103.41**

**Operating Engineer - Road & Heavy Construction XVIII**

Tower Crane

Effective Period: 7/1/2016 - 6/30/2017  
Wage Rate per Hour: **\$92.76**  
Supplemental Benefit Rate per Hour: **\$31.10**  
Supplemental Note: **\$56.50** overtime hours  
Shift Wage Rate: **\$148.42**

**Operating Engineer - Paving I**

Asphalt Spreaders, Autogrades (C.M.I.), Roto/Mil

Effective Period: 7/1/2016 - 6/30/2017  
Wage Rate per Hour: **\$71.78**  
Supplemental Benefit Rate per Hour: **\$31.10**  
Supplemental Note: **\$56.50** overtime hours  
Shift Wage Rate: **\$114.85**

**Operating Engineer - Paving II**

Asphalt Roller

Effective Period: 7/1/2016 - 6/30/2017

OFFICE OF THE COMPTROLLER, CITY OF NEW YORK  
§220 PREVAILING WAGE SCHEDULE

Wage Rate per Hour: **\$69.91**  
Supplemental Benefit Rate per Hour: **\$31.10**  
Supplemental Note: **\$56.50** overtime hours  
Shift Wage Rate: **\$111.86**

**Operating Engineer - Paving III**

Asphalt Plants

Effective Period: 7/1/2016 - 6/30/2017  
Wage Rate per Hour: **\$59.14**  
Supplemental Benefit Rate per Hour: **\$31.10**  
Supplemental Note: **\$56.50** overtime hours  
Shift Wage Rate: **\$94.62**

**Operating Engineer - Concrete I**

Cranes

Effective Period: 7/1/2016 - 6/30/2017  
Wage Rate per Hour: **\$76.73**  
Supplemental Benefit Rate per Hour: **\$31.10**  
Supplemental Note: **\$56.50** overtime hours

**Operating Engineer - Concrete II**

Compressors

Effective Period: 7/1/2016 - 6/30/2017  
Wage Rate per Hour: **\$45.62**  
Supplemental Benefit Rate per Hour: **\$31.10**  
Supplemental Note: **\$56.50** overtime hours

**Operating Engineer - Concrete III**

Micro-traps (Negative Air Machines), Vac-All Remediation System.

Effective Period: 7/1/2016 - 6/30/2017  
Wage Rate per Hour: **\$61.31**  
Supplemental Benefit Rate per Hour: **\$31.10**  
Supplemental Note: **\$56.50** overtime hours

**Operating Engineer - Steel Erection I**

Three Drum Derricks

Effective Period: 7/1/2016 - 6/30/2017  
Wage Rate per Hour: **\$79.54**  
Supplemental Benefit Rate per Hour: **\$31.10**  
Supplemental Note: **\$56.50** overtime hours

OFFICE OF THE COMPTROLLER, CITY OF NEW YORK  
\$220 PREVAILING WAGE SCHEDULE

Shift Wage Rate: \$127.26

**Operating Engineer - Steel Erection II**

Cranes, 2 Drum Derricks, Hydraulic Cranes, Fork Lifts and Boom Trucks.

Effective Period: 7/1/2016 - 6/30/2017

Wage Rate per Hour: \$76.43

Supplemental Benefit Rate per Hour: \$31.10

Supplemental Note: \$56.50 overtime hours

Shift Wage Rate: \$122.29

**Operating Engineer - Steel Erection III**

Compressors, Welding Machines.

Effective Period: 7/1/2016 - 6/30/2017

Wage Rate per Hour: \$45.34

Supplemental Benefit Rate per Hour: \$31.10

Supplemental Note: \$56.50 overtime hours

Shift Wage Rate: \$72.54

**Operating Engineer - Steel Erection IV**

Compressors - Not Combined with Welding Machine.

Effective Period: 7/1/2016 - 6/30/2017

Wage Rate per Hour: \$43.17

Supplemental Benefit Rate per Hour: \$31.10

Supplemental Note: \$56.50 overtime hours

Shift Wage Rate: \$69.07

**Operating Engineer - Building Work I**

Forklifts, Plaster (Platform machine), Plaster Bucket, Concrete Pump and all other equipment used for hoisting material.

Effective Period: 7/1/2016 - 6/30/2017

Wage Rate per Hour: \$63.12

Supplemental Benefit Rate per Hour: \$31.10

Supplemental Note: \$56.50 overtime hours

**Operating Engineer - Building Work II**

Compressors, Welding Machines (Cutting Concrete-Tank Work), Paint Spraying, Sandblasting, Pumps (with the exclusion of Concrete Pumps), All Engines irrespective of Power (Power-Pac) used to drive Auxiliary Equipment, Air, Hydraulic, Jacking System, etc.

Effective Period: 7/1/2016 - 6/30/2017

Wage Rate per Hour: \$47.26

OFFICE OF THE COMPTROLLER, CITY OF NEW YORK  
§220 PREVAILING WAGE SCHEDULE

Supplemental Benefit Rate per Hour: **\$31.10**  
Supplemental Note: \$56.50 overtime hours

**Operating Engineer - Building Work III**

Double Drum

Effective Period: 7/1/2016 - 6/30/2017  
Wage Rate per Hour: **\$71.85**  
Supplemental Benefit Rate per Hour: **\$31.10**  
Supplemental Note: \$56.50 overtime hours

**Operating Engineer - Building Work IV**

Stone Derrick, Cranes, Hydraulic Cranes Boom Trucks.

Effective Period: 7/1/2016 - 6/30/2017  
Wage Rate per Hour: **\$76.12**  
Supplemental Benefit Rate per Hour: **\$31.10**  
Supplemental Note: \$56.50 overtime hours

**Operating Engineer - Building Work V**

Dismantling and Erection of Cranes, Relief Engineer.

Effective Period: 7/1/2016 - 6/30/2017  
Wage Rate per Hour: **\$70.13**  
Supplemental Benefit Rate per Hour: **\$31.10**  
Supplemental Note: \$56.50 overtime hours

**Operating Engineer - Building Work VI**

4 Pole Hoist, Single Drum Hoists.

Effective Period: 7/1/2016 - 6/30/2017  
Wage Rate per Hour: **\$69.39**  
Supplemental Benefit Rate per Hour: **\$31.10**  
Supplemental Note: \$56.50 overtime hours

**Operating Engineer - Building Work VII**

Rack & Pinion and House Cars

Effective Period: 7/1/2016 - 6/30/2017  
Wage Rate per Hour: **\$55.17**  
Supplemental Benefit Rate per Hour: **\$31.10**  
Supplemental Note: \$56.50 overtime hours  
For New House Car projects Wage Rate per Hour \$44.02

**Overtime Description**

OFFICE OF THE COMPTROLLER, CITY OF NEW YORK  
§220 PREVAILING WAGE SCHEDULE

On jobs of more than one shift, if an Employee fails to report for work through any cause over which the Employer has no control, the Employee on duty will continue to work at the rate of single time.

For House Cars and Rack & Pinion only: Overtime paid at time and one-half for all hours in excess of eight hours in a day, Saturday, Sunday and Holidays worked.

### Overtime

Double time the regular rate after an 8 hour day.

Double time the regular time rate for Saturday.

Double time the regular rate for Sunday.

Double time the regular rate for work on the following holiday(s).

### Paid Holidays

New Year's Day

Lincoln's Birthday

President's Day

Memorial Day

Independence Day

Labor Day

Columbus Day

Veteran's Day

Thanksgiving Day

Day after Thanksgiving

Christmas Day

Employees must work at least one day in the payroll week in which the holiday occurs to receive the paid holiday

### Shift Rates

For Steel Erection Only: Shifts may be worked at the single time rate at other than the regular working hours (8:00 A.M. to 4:30 P.M.) on the following work ONLY: Heavy construction jobs on work below the street level, over railroad tracks and on building jobs.

(Operating Engineer Local #14)

---

---

## FLOOR COVERER

(Interior vinyl composition tile, sheath vinyl linoleum and wood parquet tile including site preparation and synthetic turf not including site preparation)

### Floor Coverer

Effective Period: 7/1/2016 - 6/30/2017

Wage Rate per Hour: \$50.50

Supplemental Benefit Rate per Hour: \$45.88

### Overtime

Time and one half the regular rate after an 8 hour day.



OFFICE OF THE COMPTROLLER, CITY OF NEW YORK  
§220 PREVAILING WAGE SCHEDULE

Time and one half the regular rate for Saturday.  
Double time the regular rate for Sunday.

**Overtime Holidays**

Double time the regular rate for work on the following holiday(s).

- New Year's Day
- President's Day
- Memorial Day
- Independence Day
- Labor Day
- Columbus Day
- Presidential Election Day
- Thanksgiving Day
- Day after Thanksgiving
- Christmas Day

**Paid Holidays**

- 1/2 day on Christmas Eve if work is performed in the A.M.
- 1/2 day on New Year's Eve if work is performed in the A.M.

**Shift Rates**

Two shifts may be utilized with the first shift working 8:00 A.M. to the end of the shift at the straight time of pay. The second shift will receive one hour at double time rate for the last hour of the shift. (eight for seven, nine for eight).

(Carpenters District Council)

---

---

**GLAZIER**  
(New Construction, Remodeling, and Alteration)

Glazier

Effective Period: 7/1/2016 - 6/30/2017

Wage Rate per Hour: **\$44.45**

Supplemental Benefit Rate per Hour: **\$37.84**

Supplemental Note: Supplemental Benefit Overtime Rate: **\$46.84**

**Overtime Description**

An optional 8th hour can be worked at straight time rate. If 9th hour is worked, then both hours or more (8th & 9th or more) will be at the double time rate of pay.

**Overtime**

- Double time the regular rate after a 7 hour day.
- Double time the regular time rate for Saturday.
- Double time the regular rate for Sunday.

OFFICE OF THE COMPTROLLER, CITY OF NEW YORK  
§220 PREVAILING WAGE SCHEDULE

**Overtime Holidays**

Double time the regular rate for work on the following holiday(s).

New Year's Day  
President's Day  
Memorial Day  
Independence Day  
Labor Day  
Thanksgiving Day  
Day after Thanksgiving  
Christmas Day

**Paid Holidays**

None

**Shift Rates**

Shifts shall be any 7 hours beyond 4:00 P.M. for which the glazier shall receive 8 hours pay for 7 hours worked.

(Local #1281)

---

---

**GLAZIER - REPAIR & MAINTENANCE**

(For the Installation of Glass - All repair and maintenance work on a particular building, whenever performed, where the total cumulative contract value is under \$127,628. Except where enumerated (i.e. plate glass windows) does not apply to non-residential buildings.)

**Craft Jurisdiction for repair, maintenance and fabrication**

Plate glass replacement, Residential glass replacement, Residential mirrors and shower doors, Storm windows and storm doors, Residential replacement windows, Herculite door repairs, Door closer repairs, Retrofit apartment house (non commercial buildings), Glass tinting.

Effective Period: 7/1/2016 - 6/30/2017

Wage Rate per Hour: \$23.78

Supplemental Benefit Rate per Hour: \$20.14

**Overtime**

Time and one half the regular rate after an 8 hour day.  
Double time the regular rate for Sunday.  
Time and one half the regular hourly rate after 40 hours in any work week.

**Paid Holidays**

New Year's Day  
President's Day

OFFICE OF THE COMPTROLLER, CITY OF NEW YORK  
\$220 PREVAILING WAGE SCHEDULE

Memorial Day  
Independence Day  
Labor Day  
Thanksgiving Day  
Day after Thanksgiving  
Christmas Day

(Local #1281)

---

---

## HEAT AND FROST INSULATOR

### Heat & Frost Insulator

Effective Period: 7/1/2016 - 6/30/2017

Wage Rate per Hour: **\$57.78**

Supplemental Benefit Rate per Hour: **\$38.96**

### Overtime Description

Double time shall be paid for supplemental benefits during overtime work.  
8th hour paid at time and one half.

### Overtime

Double time the regular rate after an 8 hour day.  
Double time the regular time rate for Saturday.  
Double time the regular rate for Sunday.

### Overtime Holidays

Double time the regular rate for work on the following holiday(s).

New Year's Day  
Martin Luther King Jr. Day  
President's Day  
Memorial Day  
Independence Day  
Columbus Day  
Veteran's Day  
Thanksgiving Day  
Day after Thanksgiving  
Christmas Day

Triple time the regular rate for work on the following holiday(s).

Labor Day

### Paid Holidays

None

### Shift Rates

OFFICE OF THE COMPTROLLER, CITY OF NEW YORK  
§220 PREVAILING WAGE SCHEDULE

The first shift shall work seven hours at the regular straight time rate. The second and third shift shall work seven hours the regular straight time hourly rate plus a fourteen percent wage and benefit premium. Off hour work in occupied or retail buildings may be worked on weekdays with an increment of \$1.00 per hour and eight hours pay for seven (7) hours worked. Double time will apply for over seven (7) hours worked on weekdays, weekends or holidays.

(Local #12) (BCA)

---

---

**HOUSE WRECKER  
(TOTAL DEMOLITION)**

**House Wrecker - Tier A**

On all work sites the first, second, eleventh and every third House Wrecker thereafter will be Tier A House Wreckers (i.e. 1st, 2nd, 11th, 14th etc). Other House Wreckers may be Tier B House Wreckers.

Effective Period: 7/1/2016 - 6/30/2017

Wage Rate per Hour: **\$36.33**

Supplemental Benefit Rate per Hour: **\$27.77**

**House Wrecker - Tier B**

Effective Period: 7/1/2016 - 6/30/2017

Wage Rate per Hour: **\$25.56**

Supplemental Benefit Rate per Hour: **\$20.45**

**Overtime**

Time and one half the regular rate after an 8 hour day.  
Time and one half the regular rate for Saturday.  
Double time the regular rate for Sunday.

**Overtime Holidays**

Double time the regular rate for work on the following holiday(s).

New Year's Day  
President's Day  
Memorial Day  
Independence Day  
Labor Day  
Thanksgiving Day  
Christmas Day

**Paid Holidays**

None

OFFICE OF THE COMPTROLLER, CITY OF NEW YORK  
§220 PREVAILING WAGE SCHEDULE

(Mason Tenders District Council)

---

---

## IRON WORKER - ORNAMENTAL

### Iron Worker - Ornamental

Effective Period: 7/1/2016 - 6/30/2017

Wage Rate per Hour: \$43.75

Supplemental Benefit Rate per Hour: \$49.57

Supplemental Note: Supplemental benefits are to be paid at the applicable overtime rate when overtime is in effect.

### Overtime Description

Time and one half the regular rate after a 7 hour day for a maximum of two hours on any regular work day (the 8th and 9th hour) and double time shall be paid for all work on a regular work day thereafter, time and one half the regular rate for Saturday for the first seven hours of work and double time shall be paid for all work on a Saturday thereafter.

### Overtime

Double time the regular rate for Sunday.

### Overtime Holidays

Double time the regular rate for work on the following holiday(s).

New Year's Day

President's Day

Memorial Day

Independence Day

Labor Day

Thanksgiving Day

Christmas Day

### Paid Holidays

None

### Shift Rates

For off shift work - 8 hours pay for 7 hours of work. When two or three shifts are employed on a job, Monday through Friday, the workday for each shift shall be seven hours and paid for ten and one-half hours at the single time rate. When two or three shifts are worked on Saturday, Sunday or holidays, each shift shall be seven hours and paid fifteen and three-quarters hours.

(Local #580)

---

---

OFFICE OF THE COMPTROLLER, CITY OF NEW YORK  
\$220 PREVAILING WAGE SCHEDULE

## IRON WORKER - STRUCTURAL

### Iron Worker - Structural

Effective Period: 7/1/2016 - 6/30/2017

Wage Rate per Hour: \$49.50

Supplemental Benefit Rate per Hour: \$69.74

Supplemental Note: Supplemental benefits are to be paid at the applicable overtime rate when overtime is in effect.

### Overtime Description

Monday through Friday- the first eight hours are paid at straight time, the 9th and 10th hours are paid at time and one-half the regular rate, all additional weekday overtime is paid at double the regular rate. Saturdays- the first eight hours are paid at time and one-half the regular rate, double time thereafter. Sunday-all shifts are paid at double time.

### Overtime

Time and one half the regular rate after an 8 hour day.

Time and one half the regular rate for Saturday.

Double time the regular rate for Sunday.

### Overtime Holidays

Double time the regular rate for work on the following holiday(s).

New Year's Day

President's Day

Memorial Day

Independence Day

Labor Day

Thanksgiving Day

Christmas Day

### Paid Holidays

1/2 day on Christmas Eve if work is performed in the A.M.

1/2 day on New Year's Eve if work is performed in the A.M.

### Shift Rates

Monday through Friday - First Shift: First eight hours are paid at straight time, the 9th & 10th hours are paid at time and a half, double time paid thereafter. Second and third Shifts: First eight hours are paid at time and one-half, double time thereafter. Saturdays: All shifts, first eight hours paid at time and one-half, double time thereafter: Sunday all shifts are paid at double time.

(Local #40 & #361)

---

## LABORER

(Foundation, Concrete, Excavating, Street Pipe Layer and Common)

OFFICE OF THE COMPTROLLER, CITY OF NEW YORK  
\$220 PREVAILING WAGE SCHEDULE

**Laborer**

Excavation and foundation work for buildings, heavy construction, engineering work, and hazardous waste removal in connection with the above work. Landscaping tasks in connection with heavy construction work, engineering work and building projects. Projects include, but are not limited to pollution plants, sewers, parks, subways, bridges, highways, etc.

Effective Period: 7/1/2016 - 6/30/2017

Wage Rate per Hour: **\$41.00**

Supplemental Benefit Rate per Hour: **\$38.63**

**Overtime**

Time and one half the regular rate after an 8 hour day.

Time and one half the regular rate for Saturday.

Double time the regular rate for Sunday.

**Overtime Holidays**

Double time the regular rate for work on the following holiday(s).

New Year's Day

Memorial Day

Independence Day

Labor Day

Columbus Day

Thanksgiving Day

Christmas Day

**Paid Holidays**

Labor Day

Thanksgiving Day

**Shift Rates**

When two shifts are employed, single time rate shall be paid for each shift. When three shifts are found necessary, each shift shall work seven and one half hours (7 ½), but shall be paid for eight (8) hours of labor, and be permitted one half hour for lunch.

(Local #731)

---

**LANDSCAPING**

(Landscaping tasks, as well as tree pruning, tree removing, spraying and maintenance in connection with the planting of street trees and the planting of trees in city parks but not when such activities are performed as part of, or in connection with, other construction or reconstruction projects.)

OFFICE OF THE COMPTROLLER, CITY OF NEW YORK  
§220 PREVAILING WAGE SCHEDULE

**Landscaper (Above 6 years experience)**

Effective Period: 7/1/2016 - 6/30/2017  
Wage Rate per Hour: \$27.00  
Supplemental Benefit Rate per Hour: \$14.55

**Landscaper (3 - 6 years experience)**

Effective Period: 7/1/2016 - 6/30/2017  
Wage Rate per Hour: \$26.00  
Supplemental Benefit Rate per Hour: \$14.55

**Landscaper (up to 3 years experience)**

Effective Period: 7/1/2016 - 6/30/2017  
Wage Rate per Hour: \$23.50  
Supplemental Benefit Rate per Hour: \$14.55

**Groundperson**

Effective Period: 7/1/2016 - 6/30/2017  
Wage Rate per Hour: \$23.50  
Supplemental Benefit Rate per Hour: \$14.55

**Tree Remover / Pruner**

Effective Period: 7/1/2016 - 6/30/2017  
Wage Rate per Hour: \$32.00  
Supplemental Benefit Rate per Hour: \$14.55

**Landscaper Sprayer (Pesticide Applicator)**

Effective Period: 7/1/2016 - 6/30/2017  
Wage Rate per Hour: \$22.00  
Supplemental Benefit Rate per Hour: \$14.55

**Watering - Plant Maintainer**

Effective Period: 7/1/2016 - 6/30/2017  
Wage Rate per Hour: \$17.00  
Supplemental Benefit Rate per Hour: \$14.55

**Overtime Description**

For all overtime work performed, supplemental benefits shall include an additional seventy-five (\$0.75) cents per hour.

**Overtime**

Time and one half the regular rate after an 8 hour day.



OFFICE OF THE COMPTROLLER, CITY OF NEW YORK  
§220 PREVAILING WAGE SCHEDULE

Time and one half the regular rate for Saturday.  
Double time the regular rate for Sunday.  
Time and one half the regular rate for work on a holiday plus the day's pay.

**Paid Holidays**

New Year's Day  
Memorial Day  
Independence Day  
Labor Day  
Thanksgiving Day  
Christmas Day

**Shift Rates**

Work performed on a 4pm to 12am shift has a 15% differential. Work performed on a 12am to 8am shift has a 20% differential.

(Local #175)

---

---

**MARBLE MECHANIC**

**Marble Setter**

Effective Period: 7/1/2016 - 12/31/2016  
Wage Rate per Hour: **\$52.32**  
Supplemental Benefit Rate per Hour: **\$37.64**

Effective Period: 1/1/2017 - 6/30/2017  
Wage Rate per Hour: **\$52.74**  
Supplemental Benefit Rate per Hour: **\$38.67**

**Marble Finisher**

Effective Period: 7/1/2016 - 12/31/2016  
Wage Rate per Hour: **\$41.11**  
Supplemental Benefit Rate per Hour: **\$35.91**

Effective Period: 1/1/2017 - 6/30/2017  
Wage Rate per Hour: **\$41.46**  
Supplemental Benefit Rate per Hour: **\$36.64**

**Marble Polisher**

Effective Period: 7/1/2016 - 12/31/2016  
Wage Rate per Hour: **\$37.49**  
Supplemental Benefit Rate per Hour: **\$27.80**

OFFICE OF THE COMPTROLLER, CITY OF NEW YORK  
§220 PREVAILING WAGE SCHEDULE

Effective Period: 1/1/2017 - 6/30/2017

Wage Rate per Hour: \$37.93

Supplemental Benefit Rate per Hour: \$28.33

### Overtime Description

Supplemental Benefit contributions are to be made at the applicable overtime rates. Time and one half the regular rate after a 7 hour day or time and one half the regular rate after an 8 hour day - chosen by Employer at the start of the project and then would last for the full duration of the project.

### Overtime

Time and one half the regular rate for Saturday.  
Double time the regular rate for Sunday.

### Overtime Holidays

Double time the regular rate for work on the following holiday(s).

New Year's Day  
President's Day  
Good Friday  
Memorial Day  
Independence Day  
Labor Day  
Columbus Day  
Veteran's Day  
Thanksgiving Day  
Day after Thanksgiving  
Christmas Day

### Paid Holidays

None

(Local #7)

---

---

## MASON TENDER

### Mason Tender

Effective Period: 7/1/2016 - 6/30/2017

Wage Rate per Hour: \$37.55

Supplemental Benefit Rate per Hour: \$29.04

### Overtime

Time and one half the regular rate after an 8 hour day.  
Time and one half the regular rate for Saturday.  
Double time the regular rate for Sunday.

OFFICE OF THE COMPTROLLER, CITY OF NEW YORK  
§220 PREVAILING WAGE SCHEDULE

Saturday may be used as a make-up day at straight time when a day is lost during that week to inclement weather.

**Overtime Holidays**

Double time the regular rate for work on the following holiday(s).

New Year's Day  
President's Day  
Memorial Day  
Independence Day  
Labor Day  
Thanksgiving Day  
Christmas Day

**Paid Holidays**

None

**Shift Rates**

The Employer may work two (2) shifts with the first shift at the straight time wage rate and the second shift receiving eight (8) hours paid for seven (7) hours work at the straight time wage rate.

(Local #79)

---

---

**MASON TENDER (INTERIOR DEMOLITION WORKER)**

(The erection, building, moving, servicing and dismantling of enclosures, scaffolding, barricades, protection and site safety structures etc., on Interior Demolition jobs.)

**Mason Tender Tier A**

Effective Period: 7/1/2016 - 6/30/2017

Wage Rate per Hour: \$36.19

Supplemental Benefit Rate per Hour: \$22.95

**Mason Tender Tier B**

On Interior Demolition job sites 33 1/3 % of the employees shall be classified as Tier A Interior Demolition Workers and 66 2/3 % shall be classified as Tier B Interior Demolition Workers; provided that the employer may employ more than 33 1/3 % Tier A Interior Demolition Workers on the job site. Where the number of employees on a job site is not divisible by 3, the first additional employee (above the number of employees divisible by three) shall be a Tier B Interior Demolition Worker, and the second additional employee shall be a Tier A Interior Demolition Worker.

Effective Period: 7/1/2016 - 6/30/2017

Wage Rate per Hour: \$25.38

OFFICE OF THE COMPTROLLER, CITY OF NEW YORK  
§220 PREVAILING WAGE SCHEDULE

Supplemental Benefit Rate per Hour: \$17.27

**Overtime**

Time and one half the regular rate after an 8 hour day.  
Time and one half the regular rate for Sunday.

**Overtime Holidays**

Double time the regular rate for work on the following holiday(s).

New Year's Day  
President's Day  
Memorial Day  
Independence Day  
Labor Day  
Thanksgiving Day  
Christmas Day

**Paid Holidays**

None

(Local #79)

---

---

**METALLIC LATHER**

**Metallic Lather**

Effective Period: 7/1/2016 - 6/30/2017

Wage Rate per Hour: \$44.53

Supplemental Benefit Rate per Hour: \$42.67

Supplemental Note: Supplemental benefits for overtime are paid at the appropriate overtime rate.

**Overtime Description**

Overtime would be time and one half the regular rate after a seven (7) or eight (8) hours workday, which would be set at the start of the job.

**Overtime**

Time and one half the regular rate for Saturday.  
Double time the regular rate for Sunday.

**Overtime Holidays**

Double time the regular rate for work on the following holiday(s).

New Year's Day  
Washington's Birthday  
Memorial Day  
Independence Day  
Labor Day  
Columbus Day

OFFICE OF THE COMPTROLLER, CITY OF NEW YORK  
\$220 PREVAILING WAGE SCHEDULE

Thanksgiving Day  
Christmas Day

### **Paid Holidays**

1/2 day on Christmas Eve if work is performed in the A.M.  
1/2 day on New Year's Eve if work is performed in the A.M.

### **Shift Rates**

There will be no shift differential paid on the first shift if more than one shift is employed. The shift differential will remain \$12/hour on the second and third shift for the first eight (8) hours if worked. There will be no pyramiding on overtime worked on second and third shifts. The time and one half (1.5x) rate will be against the base wage rate, not the shift differential

(Local #46)

---

---

## **MILLWRIGHT**

### **Millwright**

Effective Period: 7/1/2016 - 6/30/2017

Wage Rate per Hour: \$51.50

Supplemental Benefit Rate per Hour: \$52.41

### **Overtime**

Time and one half the regular rate after an 8 hour day.

Time and one half the regular rate for Saturday.

Double time the regular rate for Sunday.

Saturday may be used as a make-up day at straight time when a day is lost during that week to inclement weather.

### **Overtime Holidays**

Double time the regular rate for work on the following holiday(s).

New Year's Day

President's Day

Good Friday

Memorial Day

Independence Day

Labor Day

Columbus Day

Presidential Election Day

Thanksgiving Day

Christmas Day

### **Paid Holidays**

1/2 day on Christmas Eve if work is performed in the A.M.

1/2 day on New Year's Eve if work is performed in the A.M.

OFFICE OF THE COMPTROLLER, CITY OF NEW YORK  
§220 PREVAILING WAGE SCHEDULE

### Shift Rates

The first shift shall receive the straight time rate of pay. The second shift receives the straight time rate of pay plus fifteen (15%) per cent. Members of the second shift shall be allowed one half hour to eat, with this time being included in the hours of the workday established. There must be a first shift to work a second shift. All additional hours worked shall be paid at the time and one-half rate of pay plus fifteen (15%) per cent for weekday hours.

(Local #740)

---

## MOSAIC MECHANIC

### Mosaic Mechanic - Mosaic & Terrazzo Mechanic

Effective Period: 7/1/2016 - 6/30/2017

Wage Rate per Hour: \$46.52

Supplemental Benefit Rate per Hour: \$39.84

Supplemental Note: Supplemental benefits for overtime to be paid at the rate of \$50.86 per hour.

### Mosaic Mechanic - Mosaic & Terrazzo Finisher

Effective Period: 7/1/2016 - 6/30/2017

Wage Rate per Hour: \$44.91

Supplemental Benefit Rate per Hour: \$39.83

Supplemental Note: Supplemental benefits for overtime to be paid at the rate of \$50.85 per hour.

### Mosaic Mechanic - Machine Operator Grinder

Effective Period: 7/1/2016 - 6/30/2017

Wage Rate per Hour: \$44.91

Supplemental Benefit Rate per Hour: \$39.83

Supplemental Note: Supplemental benefits for overtime to be paid at the rate of \$50.85 per hour.

### Overtime

Time and one half the regular rate after a 7 hour day.

Time and one half the regular rate for Saturday.

Double time the regular rate for Sunday.

### Overtime Holidays

Double time the regular rate for work on the following holiday(s).

New Year's Day

Washington's Birthday

Good Friday

Independence Day

Labor Day

Columbus Day

OFFICE OF THE COMPTROLLER, CITY OF NEW YORK  
\$220 PREVAILING WAGE SCHEDULE

Veteran's Day  
Thanksgiving Day  
Day after Thanksgiving  
Christmas Day

**Paid Holidays**  
None

(Local #7)

---

---

## **PAINTER**

### **Painter - Brush & Roller**

Effective Period: 7/1/2016 - 4/30/2017  
Wage Rate per Hour: \$42.50  
Supplemental Benefit Rate per Hour: \$26.62  
Supplemental Note: \$31.25 on overtime

Effective Period: 5/1/2017 - 6/30/2017  
Wage Rate per Hour: \$44.10  
Supplemental Benefit Rate per Hour: \$27.02  
Supplemental Note: \$ 31.65 on overtime

### **Spray & Scaffold / Decorative / Sandblast**

Effective Period: 7/1/2016 - 4/30/2017  
Wage Rate per Hour: \$45.50  
Supplemental Benefit Rate per Hour: \$26.62  
Supplemental Note: \$ 31.25 on overtime

Effective Period: 5/1/2017 - 6/30/2017  
Wage Rate per Hour: \$47.10  
Supplemental Benefit Rate per Hour: \$27.02  
Supplemental Note: \$ 31.65 on overtime

### **Overtime**

Time and one half the regular rate after a 7 hour day.  
Time and one half the regular rate for Saturday.  
Time and one half the regular rate for Sunday.

### **Overtime Holidays**

Time and one half the regular rate for work on the following holiday(s).  
New Year's Day  
President's Day  
Memorial Day

OFFICE OF THE COMPTROLLER, CITY OF NEW YORK  
§220 PREVAILING WAGE SCHEDULE

Independence Day  
Labor Day  
Columbus Day  
Thanksgiving Day  
Christmas Day

**Paid Holidays**

None

(District Council of Painters #9)

---

---

**PAINTER - METAL POLISHER**

**METAL POLISHER**

Effective Period: 7/1/2016 - 6/30/2017

Wage Rate per Hour: \$28.88

Supplemental Benefit Rate per Hour: \$6.96

**METAL POLISHER - NEW CONSTRUCTION**

Effective Period: 7/1/2016 - 6/30/2017

Wage Rate per Hour: \$29.83

Supplemental Benefit Rate per Hour: \$6.96

**METAL POLISHER - SCAFFOLD OVER 34 FEET**

Effective Period: 7/1/2016 - 6/30/2017

Wage Rate per Hour: \$32.38

Supplemental Benefit Rate per Hour: \$6.96

**Overtime Description**

All work performed on Saturdays shall be paid at time-in-a half. The exception being; for suspended scaffold work and work deemed as a construction project; an eight (8) hour shift lost during the week due to circumstances beyond the control of the employer, up to a maximum of eight (8) hours per week, may be worked on Saturday at the straight time rate.

**Overtime**

Time and one half the regular rate after an 8 hour day.

Time and one half the regular rate for Saturday.

Double time the regular rate for Sunday.

Saturday may be used as a make-up day at straight time when a day is lost during that week to inclement weather.

Triple time the regular rate for work on the following holiday(s).



OFFICE OF THE COMPTROLLER, CITY OF NEW YORK  
§220 PREVAILING WAGE SCHEDULE

**Paid Holidays**

New Year's Day  
Martin Luther King Jr. Day  
President's Day  
Memorial Day  
Independence Day  
Labor Day  
Columbus Day  
Veteran's Day  
Thanksgiving Day  
Day after Thanksgiving  
Christmas Day

**Shift Rates**

Four Days a week at Ten (10) hours straight a day.

Local 8A-28A

---

---

**PAINTER - STRIPER**

**Striper (paint)**

Effective Period: 7/1/2016 - 6/30/2017

Wage Rate per Hour: \$35.00

Supplemental Benefit Rate per Hour: \$12.32

Supplemental Note: Overtime Supplemental Benefit rate - \$8.02; New Hire Rate (0-3 months) - \$0.00

**Lineperson (thermoplastic)**

Effective Period: 7/1/2016 - 6/30/2017

Wage Rate per Hour: \$39.00

Supplemental Benefit Rate per Hour: \$12.32

Supplemental Note: Overtime Supplemental Benefit rate - \$8.02; New Hire Rate (0-3 months) - \$0.00

**Overtime**

Time and one half the regular rate after an 8 hour day.

Time and one half the regular rate for Saturday.

Double time the regular rate for Sunday.

Time and one half the regular rate for work on the following holiday(s).

**Paid Holidays**

New Year's Day  
Good Friday  
Memorial Day  
Independence Day  
Labor Day

OFFICE OF THE COMPTROLLER, CITY OF NEW YORK  
\$220 PREVAILING WAGE SCHEDULE

Columbus Day  
Presidential Election Day  
Thanksgiving Day  
Day after Thanksgiving  
Christmas Day

### Shift Rates

Employees hired before April 1, 2003: 15% night shift premium differential for work commenced at 9:00 PM or later.

### Vacation

Employees with one to two years service shall accrue vacation based on hours worked: 250 hours worked - 1 day vacation; 500 hours worked - 2 days vacation; 750 hours worked - 3 days vacation; 900 hours worked - 4 days vacation; 1,000 hours worked - 5 days vacation. Employees with two to five years service receive two weeks vacation. Employees with five to twenty years service receive three weeks vacation. Employees with twenty to twenty-five years service receive four weeks vacation. Employees with 25 or more years service receive five weeks vacation. Vacation must be taken during winter months. 2 Personal Days except employees hired after 4/1/12 who do not have 2 years of service.

(Local #917)

---

---

## PAINTER - STRUCTURAL STEEL

### Painters on Structural Steel

Effective Period: 7/1/2016 - 6/30/2017  
Wage Rate per Hour: **\$49.00**  
Supplemental Benefit Rate per Hour: **\$36.08**

### Painter - Power Tool

Effective Period: 7/1/2016 - 6/30/2017  
Wage Rate per Hour: **\$55.00**  
Supplemental Benefit Rate per Hour: **\$36.08**

### Overtime Description

Supplemental Benefits shall be paid for each hour worked, up to forty (40) hours per week for the period of May 1st to November 15th or up to fifty (50) hours per week for the period of November 16th to April 30th.

### Overtime

Time and one half the regular rate after a 7 hour day.  
Time and one half the regular rate for Saturday.  
Time and one half the regular rate for Sunday.

### Overtime Holidays

Double time the regular rate for work on the following holiday(s).  
New Year's Day

OFFICE OF THE COMPTROLLER, CITY OF NEW YORK  
§220 PREVAILING WAGE SCHEDULE

Memorial Day  
Independence Day  
Labor Day  
Thanksgiving Day  
Christmas Day

**Paid Holidays**

None

**Shift Rates**

Regular hourly rates plus a ten per cent (10%) differential

(Local #806)

---

---

**PAPERHANGER**

**Paperhanger**

Effective Period: 7/1/2016 - 6/30/2017

Wage Rate per Hour: **\$43.58**

Supplemental Benefit Rate per Hour: **\$30.73**

Supplemental Note: Supplemental benefits are to be paid at the appropriate straight time and overtime rate.

**Overtime**

Time and one half the regular rate after a 7 hour day.

Time and one half the regular rate for Saturday.

Time and one half the regular rate for Sunday.

**Overtime Holidays**

Time and one half the regular rate for work on the following holiday(s).

New Year's Day  
President's Day  
Memorial Day  
Independence Day  
Labor Day  
Thanksgiving Day  
Day after Thanksgiving  
Christmas Day

**Paid Holidays**

None

**Shift Rates**

Evening shift - 4:30 P.M. to 12:00 Midnight (regular rate of pay); any work performed before 7:00 A.M. shall be at time and one half the regular base rate of pay.

OFFICE OF THE COMPTROLLER, CITY OF NEW YORK  
§220 PREVAILING WAGE SCHEDULE

(District Council of Painters #9)

---

---

## **PAVER AND ROADBUILDER**

### **Paver & Roadbuilder - Formsetter**

Effective Period: 7/1/2016 - 6/30/2017

Wage Rate per Hour: **\$45.35**

Supplemental Benefit Rate per Hour: **\$38.95**

### **Paver & Roadbuilder - Laborer**

Paving and road construction work, regardless of material used, including but not limited to preparation of job sites, removal of old surfaces, asphalt and/or concrete, by whatever method, including but not limited to milling; laying of concrete; laying of asphalt for temporary, patchwork, and utility paving (but not production paving); site preparation and incidental work before the installation of rubberized materials and similar surfaces; installation and repair of temporary construction fencing; slurry seal coating, maintenance of safety surfaces; play equipment installation, and other related work.

Effective Period: 7/1/2016 - 6/30/2017

Wage Rate per Hour: **\$41.48**

Supplemental Benefit Rate per Hour: **\$38.95**

### **Production Paver & Roadbuilder - Screed Person**

(Production paving is asphalt paving when using a paving machine or on a project where a paving machine is traditionally used)

Adjustment of paving machinery on production paving jobs.

Effective Period: 7/1/2016 - 6/30/2017

Wage Rate per Hour: **\$45.95**

Supplemental Benefit Rate per Hour: **\$38.95**

### **Production Paver & Roadbuilder - Raker**

Effective Period: 7/1/2016 - 6/30/2017

Wage Rate per Hour: **\$45.35**

Supplemental Benefit Rate per Hour: **\$38.95**

### **Production Paver & Roadbuilder - Shoveler**

General laborer (except removal of surfaces - see Paver and Roadbuilder-Laborer) including but not limited to tamper, AC paint and liquid tar work.

Effective Period: 7/1/2016 - 6/30/2017

OFFICE OF THE COMPTROLLER, CITY OF NEW YORK  
§220 PREVAILING WAGE SCHEDULE

Wage Rate per Hour: \$42.06

Supplemental Benefit Rate per Hour: \$38.95

### Overtime Description

If an employee works New Year's Day or Christmas Day, they receive the single time rate plus 25%.

### Overtime

Time and one half the regular rate after an 8 hour day.

Time and one half the regular rate for Saturday.

Double time the regular rate for Sunday.

### Overtime Holidays

Double time the regular rate for work on the following holiday(s).

Memorial Day

Independence Day

Labor Day

Columbus Day

Thanksgiving Day

### Shift Rates

When two shifts are employed, the work period for each shift shall be a continuous eight (8) hours. When three shifts are employed, each shift will work seven and one half (7 ½) hours but will be paid for eight (8) hours since only one half (1/2) hour is allowed for meal time.

When two or more shifts are employed, single time will be paid for each shift.

Night Work - On night work, the first eight (8) hours of work will be paid for at the single time rate, except that production paving work shall be paid at 10% over the single time rate for the screed person, rakers and shovelers directly involved only. This differential is to be paid when there is only one shift and the shift works at night. All other workers will be exempt. Hours worked over eight (8) hours during said shift shall be paid for at the time and one-half rate.

(Local #1010)

---

## PLASTERER

### Plasterer

Effective Period: 7/1/2016 - 6/30/2017

Wage Rate per Hour: \$43.93

Supplemental Benefit Rate per Hour: \$28.10

### Overtime

Time and one half the regular rate after a 7 hour day.

Time and one half the regular rate for Saturday.

Double time the regular rate for Sunday.

OFFICE OF THE COMPTROLLER, CITY OF NEW YORK  
§220 PREVAILING WAGE SCHEDULE

Saturday may be used as a make-up day at straight time when a day is lost during that week to inclement weather.

### Overtime Holidays

Double time the regular rate for work on the following holiday(s).

New Year's Day  
Martin Luther King Jr. Day  
President's Day  
Good Friday  
Memorial Day  
Independence Day  
Labor Day  
Columbus Day  
Presidential Election Day  
Thanksgiving Day  
Christmas Day

### Paid Holidays

None

### Shift Rates

When it is not possible to conduct alteration work during regular work hours, in a building occupied by tenants, said work shall proceed on a shift basis: however work over seven (7) hours in any twenty four (24) hour period, the time after seven (7) hours shall be considered overtime.

The second shift shall start at a time between 3:30 p.m. and 7:00 p.m. and shall consist of seven (7) working hours and shall receive eight (8) hours of wages and benefits at the straight time rate. The workers on the second shift shall be allowed one-half (½) hour to eat with this time being included in the seven (7) hours of work.

(Local #262)

---

---

## PLASTERER - TENDER

### Plasterer - Tender

Effective Period: 7/1/2016 - 6/30/2017

Wage Rate per Hour: \$37.55

Supplemental Benefit Rate per Hour: \$29.04

### Overtime

Time and one half the regular rate after an 8 hour day.

Time and one half the regular rate for Saturday.

Double time the regular rate for Sunday.

Saturday may be used as a make-up day at straight time when a day is lost during that week to inclement weather.

### Overtime Holidays

OFFICE OF THE COMPTROLLER, CITY OF NEW YORK  
§220 PREVAILING WAGE SCHEDULE

Double time the regular rate for work on the following holiday(s).

New Year's Day  
Washington's Birthday  
Memorial Day  
Independence Day  
Labor Day  
Presidential Election Day  
Thanksgiving Day  
Christmas Day

**Paid Holidays**

None

**Shift Rates**

When work commences outside regular work hours, workers receive an hour additional (differential) wage and supplement payment. Eight hours pay for seven hours work or nine hours pay for eight hours work.

(Mason Tenders District Council)

---

---

**PLUMBER**

**Plumber**

Effective Period: 7/1/2016 - 6/30/2017

Wage Rate per Hour: \$65.67

Supplemental Benefit Rate per Hour: \$29.28

Supplemental Note: Overtime supplemental benefit rate per hour: \$58.28

**Plumber - Temporary Services**

Temporary Services - When there are no Plumbers on the job site, there may be three shifts designed to cover the entire twenty-four hour period, including weekends if necessary, at the following rate straight time.

Effective Period: 7/1/2016 - 6/30/2017

Wage Rate per Hour: \$52.56

Supplemental Benefit Rate per Hour: \$23.40

**Overtime Description**

Double time the regular rate after a 7 hour day - unless for new construction site work where the plumbing contract price is \$1.5 million or less, the hours of labor can be 8 hours per day at the employers option. On Alteration jobs when other mechanical trades at the site are working an eighth hour at straight time, then the plumber shall also work an eighth hour at straight time.

**Overtime**

Double time the regular time rate for Saturday.

Double time the regular rate for Sunday.

OFFICE OF THE COMPTROLLER, CITY OF NEW YORK  
§220 PREVAILING WAGE SCHEDULE

**Overtime Holidays**

Double time the regular rate for work on the following holiday(s).

New Year's Day  
President's Day  
Memorial Day  
Independence Day  
Labor Day  
Columbus Day  
Veteran's Day  
Thanksgiving Day  
Day after Thanksgiving  
Christmas Day

**Shift Rates**

Shift work, when directly specified in public agency or authority documents where plumbing contract is \$8 million or less, will be permitted. 30% shift premium shall be paid for wages and fringe benefits for 4:00 pm and midnight shifts Monday to Friday. 50% shift premium shall be paid for wages and fringe benefits for 4:00 pm and midnight shift work performed on weekends. For shift work on holidays, double time wages and fringe benefits shall be paid.

(Plumbers Local #1)

---

**PLUMBER (MECHANICAL EQUIPMENT AND SERVICE)**  
(Mechanical Equipment and Service work shall include any repair and/or replacement of the present plumbing system.)

**Plumber**

Effective Period: 7/1/2016 - 6/30/2017

Wage Rate per Hour: \$39.42

Supplemental Benefit Rate per Hour: \$14.19

**Overtime**

Time and one half the regular rate after an 8 hour day.  
Time and one half the regular rate for Saturday.  
Time and one half the regular rate for Sunday.

**Overtime Holidays**

Time and one half the regular rate for work on the following holiday(s).  
New Year's Day  
President's Day  
Memorial Day  
Independence Day  
Thanksgiving Day



OFFICE OF THE COMPTROLLER, CITY OF NEW YORK  
§220 PREVAILING WAGE SCHEDULE

Day after Thanksgiving  
Christmas Day

**Paid Holidays**

None.

(Plumbers Local # 1)

---

---

**PLUMBER (RESIDENTIAL RATES FOR 1, 2 AND 3 FAMILY HOME CONSTRUCTION)**

Effective Period: 7/1/2016 - 6/30/2017

Wage Rate per Hour: \$45.47

Supplemental Benefit Rate per Hour: \$21.26

**Overtime**

Double time the regular rate after an 8 hour day.

Double time the regular time rate for Saturday.

Double time the regular rate for Sunday.

**Overtime Holidays**

Double time the regular rate for work on the following holiday(s).

New Year's Day

President's Day

Memorial Day

Independence Day

Labor Day

Columbus Day

Veteran's Day

Thanksgiving Day

Day after Thanksgiving

Christmas Day

**Paid Holidays**

None

**Shift Rates**

30% shift premium shall be paid for wages and fringe benefits for 4:00 pm and midnight shifts Monday to Friday.

50% shift premium shall be paid for wages and fringe benefits for 4:00 pm and midnight shift work performed on weekends. For shift work on holidays, double time wages and fringe benefits shall be paid.

(Plumbers Local #1)

---

---

**PLUMBER: PUMP & TANK**  
Oil Trades (Installation and Maintenance)

**Plumber - Pump & Tank**

Effective Period: 7/1/2016 - 6/30/2017

Wage Rate per Hour: **\$63.52**

Supplemental Benefit Rate per Hour: **\$22.91**

**Overtime**

Time and one half the regular rate after an 8 hour day.

Time and one half the regular rate for Saturday.

Time and one half the regular rate for Sunday.

**Overtime Holidays**

Time and one half the regular rate for work on the following holiday(s).

New Year's Day

President's Day

Memorial Day

Independence Day

Labor Day

Columbus Day

Veteran's Day

Thanksgiving Day

Day after Thanksgiving

Christmas Day

**Paid Holidays**

None

**Shift Rates**

All work outside the regular workday (8:00 A.M. to 3:30 P.M.) is to be paid at time and one half the regular hourly rate

(Plumbers Local #1)

---

**POINTER, WATERPROOFER, CAULKER, SANDBLASTER,  
STEAMBLASTER**  
(Exterior Building Renovation)

**Journey person**

OFFICE OF THE COMPTROLLER, CITY OF NEW YORK  
§220 PREVAILING WAGE SCHEDULE

Effective Period: 7/1/2016 - 6/30/2017

Wage Rate per Hour: \$50.04

Supplemental Benefit Rate per Hour: \$26.15

### Overtime

Time and one half the regular rate after an 8 hour day.

Time and one half the regular rate for Saturday.

Time and one half the regular rate for Sunday.

Saturday may be used as a make-up day at straight time when a day is lost during that week to inclement weather.

### Overtime Holidays

Time and one half the regular rate for work on the following holiday(s).

New Year's Day

Martin Luther King Jr. Day

President's Day

Memorial Day

Independence Day

Labor Day

Thanksgiving Day

Christmas Day

### Paid Holidays

None

### Shift Rates

All work outside the regular work day (an eight hour workday between the hours of 6:00 A.M. and 4:30 P.M.) is to be paid at time and one half the regular rate.

(Bricklayer District Council)

---

---

## ROOFER

### Roofer

Effective Period: 7/1/2016 - 6/30/2017

Wage Rate per Hour: \$40.70

Supplemental Benefit Rate per Hour: \$30.17

### Overtime

Time and one half the regular rate after an 8 hour day.

Time and one half the regular rate for Saturday.

Time and one half the regular rate for Sunday.

### Overtime Holidays

OFFICE OF THE COMPTROLLER, CITY OF NEW YORK  
§220 PREVAILING WAGE SCHEDULE

Time and one half the regular rate for work on the following holiday(s).

New Year's Day  
President's Day  
Memorial Day  
Independence Day  
Labor Day  
Presidential Election Day  
Thanksgiving Day  
Christmas Day

**Paid Holidays**

None

**Shift Rates**

Second shift - Regular hourly rate plus a 10% differential. Third shift - Regular hourly rate plus a 15% differential.

(Local #8)

---

---

**SHEET METAL WORKER**

**Sheet Metal Worker**

Effective Period: 7/1/2016 - 6/30/2017

Wage Rate per Hour: \$47.70

Supplemental Benefit Rate per Hour: \$46.45

Supplemental Note: Supplemental benefit contributions are to be made at the applicable overtime rates.

**Sheet Metal Worker - Fan Maintenance**

(The temporary operation of fans or blowers in new or existing buildings for heating and/or ventilation, and/or air conditioning prior to the completion of the project.)

Effective Period: 7/1/2016 - 6/30/2017

Wage Rate per Hour: \$38.16

Supplemental Benefit Rate per Hour: \$46.45

**Sheet Metal Worker - Duct Cleaner**

Effective Period: 7/1/2016 - 6/30/2017

Wage Rate per Hour: \$12.90

Supplemental Benefit Rate per Hour: \$8.07

**Overtime**

Time and one half the regular rate after an 8 hour day.  
Time and one half the regular rate for Saturday.  
Double time the regular rate for Sunday.

OFFICE OF THE COMPTROLLER, CITY OF NEW YORK  
§220 PREVAILING WAGE SCHEDULE

**Overtime Holidays**

Double time the regular rate for work on the following holiday(s).

New Year's Day  
Martin Luther King Jr. Day  
President's Day  
Memorial Day  
Independence Day  
Labor Day  
Columbus Day  
Veteran's Day  
Thanksgiving Day  
Day after Thanksgiving  
Christmas Day

**Paid Holidays**

None

**Shift Rates**

Work that can only be performed outside regular working hours (eight hours of work between 7:30 A.M. and 3:30 P.M.) - First shift (work between 3:30 P.M. and 11:30 P.M.) - 10% differential above the established hourly rate.  
Second shift (work between 11:30 P.M. and 7:30 A.M.) - 15% differential above the established hourly rate.

For Fan Maintenance: On all full shifts of fan maintenance work the straight time hourly rate of pay will be paid for each shift, including nights, Saturdays, Sundays, and holidays.

(Local #28)

---

**SHEET METAL WORKER - SPECIALTY**  
**(Decking & Siding)**

**Sheet Metal Specialty Worker**

The first worker to perform this work must be paid at the rate of the Sheet Metal Worker. The second and third workers shall be paid the Specialty Worker Rate. The ratio of One Sheet Metal Worker, then Two Specialty Workers shall be utilized thereafter.

Effective Period: 7/1/2016 - 6/30/2017

Wage Rate per Hour: \$43.25

Supplemental Benefit Rate per Hour: \$24.41

Supplemental Note: Supplemental benefit contributions are to be made at the applicable overtime rates.

**Overtime**

Time and one half the regular rate after an 8 hour day.

Time and one half the regular rate for Saturday.

Double time the regular rate for Sunday.

OFFICE OF THE COMPTROLLER, CITY OF NEW YORK  
§220 PREVAILING WAGE SCHEDULE

**Overtime Holidays**

Double time the regular rate for work on the following holiday(s).

New Year's Day  
Martin Luther King Jr. Day  
President's Day  
Memorial Day  
Independence Day  
Labor Day  
Columbus Day  
Veteran's Day  
Thanksgiving Day  
Christmas Day

**Paid Holidays**

None

(Local #28)

---

---

**SHIPYARD WORKER**

**Shipyard Mechanic - First Class**

Effective Period: 7/1/2016 - 6/30/2017  
Wage Rate per Hour: **\$28.33**  
Supplemental Benefit Rate per Hour: **\$3.04**

**Shipyard Mechanic - Second Class**

Effective Period: 7/1/2016 - 6/30/2017  
Wage Rate per Hour: **\$22.18**  
Supplemental Benefit Rate per Hour: **\$2.80**

**Shipyard Laborer - First Class**

Effective Period: 7/1/2016 - 6/30/2017  
Wage Rate per Hour: **\$20.45**  
Supplemental Benefit Rate per Hour: **\$2.74**

**Shipyard Laborer - Second Class**

Effective Period: 7/1/2016 - 6/30/2017  
Wage Rate per Hour: **\$14.36**  
Supplemental Benefit Rate per Hour: **\$2.50**

OFFICE OF THE COMPTROLLER, CITY OF NEW YORK  
§220 PREVAILING WAGE SCHEDULE

**Shipyard Dockhand - First Class**

Effective Period: 7/1/2016 - 6/30/2017

Wage Rate per Hour: \$22.70

Supplemental Benefit Rate per Hour: \$2.82

**Shipyard Dockhand - Second Class**

Effective Period: 7/1/2016 - 6/30/2017

Wage Rate per Hour: \$16.01

Supplemental Benefit Rate per Hour: \$2.57

**Overtime Description**

Work performed on holiday is paid double time the regular hourly wage rate plus holiday pay.

**Overtime**

Time and one half the regular rate after an 8 hour day.

Time and one half the regular rate for Saturday.

Double time the regular rate for Sunday.

Time and one half the regular hourly rate after 40 hours in any work week.

**Paid Holidays**

New Year's Day

Martin Luther King Jr. Day

President's Day

Good Friday

Memorial Day

Independence Day

Labor Day

Thanksgiving Day

Day after Thanksgiving

Christmas Day

Based on Survey Data

---

---

**SIGN ERECTOR**

(Sheet Metal, Plastic, Electric, and Neon)

**Sign Erector**

Effective Period: 7/1/2016 - 6/30/2017

Wage Rate per Hour: \$46.85

Supplemental Benefit Rate per Hour: \$48.57

OFFICE OF THE COMPTROLLER, CITY OF NEW YORK  
§220 PREVAILING WAGE SCHEDULE

**Overtime**

Time and one half the regular rate after a 7 hour day.  
Time and one half the regular rate for Saturday.  
Time and one half the regular rate for Sunday.  
Time and one half the regular rate for work on the following holiday(s).

**Paid Holidays**

New Year's Day  
Washington's Birthday  
Memorial Day  
Independence Day  
Labor Day  
Columbus Day  
Election Day  
Thanksgiving Day  
Day after Thanksgiving  
Christmas Day

**Shift Rates**

Time and one half the regular hourly rate is to be paid for all hours worked outside the regular workday either (7:00 A.M. through 2:30 P.M.) or (8:00 A.M. through 3:30 P.M.)

(Local #137)

---

---

**STEAMFITTER**

**Steamfitter I**

Effective Period: 7/1/2016 - 6/30/2017  
Wage Rate per Hour: \$55.50  
Supplemental Benefit Rate per Hour: \$54.29  
Supplemental Note: Overtime supplemental benefit rate: \$107.84

**Steamfitter -Temporary Services**

The steamfitters shall not do any other work and shall not be permitted to work more than one shift in a twenty-four hour day. When steamfitters are present during the regular working day, no temporary services steamfitter will be required

Effective Period: 7/1/2016 - 6/30/2017  
Wage Rate per Hour: \$42.18  
Supplemental Benefit Rate per Hour: \$44.08

**Overtime**

Double time the regular rate after a 7 hour day.  
Double time the regular time rate for Saturday.



OFFICE OF THE COMPTROLLER, CITY OF NEW YORK  
\$220 PREVAILING WAGE SCHEDULE

Double time the regular rate for Sunday.

### Overtime Holidays

Double time the regular rate for work on the following holiday(s).

New Year's Day  
President's Day  
Memorial Day  
Independence Day  
Labor Day  
Columbus Day  
Veteran's Day  
Thanksgiving Day  
Day after Thanksgiving  
Christmas Day

### Paid Holidays

None

### Shift Rates

Work performed between 3:30 P.M. and 7:00 A.M. and on Saturdays, Sundays and Holidays shall be at double time the regular hourly rate and paid at the overtime supplemental benefit rate above.

---

### Steamfitter II

For heating, ventilation, air conditioning and mechanical public works contracts with a dollar value not to exceed \$15,000,000 and for fire protection/sprinkler public works contracts not to exceed \$1,500,000.

Effective Period: 7/1/2016 - 6/30/2017

Wage Rate per Hour: \$55.50

Supplemental Benefit Rate per Hour: \$54.29

Supplemental Note: Overtime supplemental benefit rate: \$107.84

### Steamfitter -Temporary Services

The steamfitters shall not do any other work and shall not be permitted to work more than one shift in a twenty-four hour day. When steamfitters are present during the regular working day, no temporary services steamfitter will be required.

Effective Period: 7/1/2016 - 6/30/2017

Wage Rate per Hour: \$42.18

Supplemental Benefit Rate per Hour: \$44.08

### Overtime

Double time the regular rate after an 8 hour day.

Double time the regular time rate for Saturday.

Double time the regular rate for Sunday.

### Overtime Holidays

OFFICE OF THE COMPTROLLER, CITY OF NEW YORK  
§220 PREVAILING WAGE SCHEDULE

Double time the regular rate for work on the following holiday(s).

New Year's Day  
President's Day  
Memorial Day  
Independence Day  
Labor Day  
Columbus Day  
Veteran's Day  
Thanksgiving Day  
Day after Thanksgiving  
Christmas Day

**Paid Holidays**

None

**Shift Rates**

May be performed outside of the regular workday except Saturday, Sunday and Holidays. A shift shall consist of eight working hours. All work performed in excess of eight hours shall be paid at double time. No shift shall commence after 7:00 P.M. on Friday or 7:00 P.M. the day before holidays. All work performed after 12:01 A.M. Saturday or 12:01 A.M. the day before a Holiday will be paid at double time. When shift work is performed the wage rate for regular time worked is a thirty percent premium together with fringe benefits.

On Transit Authority projects, where work is performed in the vicinity of tracks all shift work on weekends and holidays may be performed at the regular shift rates.

Local #638

---

**STEAMFITTER - REFRIGERATION AND AIR CONDITIONER  
(Maintenance and Installation Service Person)**

**Refrigeration and Air Conditioner Mechanic**

Effective Period: 7/1/2016 - 6/30/2017  
Wage Rate per Hour: **\$39.50**  
Supplemental Benefit Rate per Hour: **\$15.06**

**Refrigeration and Air Conditioner Service Person V**

Effective Period: 7/1/2016 - 6/30/2017  
Wage Rate per Hour: **\$32.46**  
Supplemental Benefit Rate per Hour: **\$13.53**

**Refrigeration and Air Conditioner Service Person IV**

Effective Period: 7/1/2016 - 6/30/2017

OFFICE OF THE COMPTROLLER, CITY OF NEW YORK  
\$220 PREVAILING WAGE SCHEDULE

Wage Rate per Hour: \$26.89  
Supplemental Benefit Rate per Hour: \$12.26

**Refrigeration and Air Conditioner Service Person III**

Filter changing and maintenance thereof, oil and greasing, tower and coil cleaning, scraping and painting, general housekeeping, taking of water samples.

Effective Period: 7/1/2016 - 6/30/2017  
Wage Rate per Hour: \$23.08  
Supplemental Benefit Rate per Hour: \$11.31

**Refrigeration and Air Conditioner Service Person II**

Filter changing and maintenance thereof, oil and greasing, tower and coil cleaning, scraping and painting, general housekeeping, taking of water samples.

Effective Period: 7/1/2016 - 6/30/2017  
Wage Rate per Hour: \$19.14  
Supplemental Benefit Rate per Hour: \$10.43

**Refrigeration and Air Conditioner Service Person I**

Filter changing and maintenance thereof, oil and greasing, tower and coil cleaning, scraping and painting, general housekeeping, taking of water samples.

Effective Period: 7/1/2016 - 6/30/2017  
Wage Rate per Hour: \$14.00  
Supplemental Benefit Rate per Hour: \$9.46

**Overtime**

Time and one half the regular rate after an 8 hour day.  
Time and one half the regular rate for Saturday.  
Double time the regular rate for Sunday.

**Overtime Holidays**

Double time the regular rate for work on the following holiday(s).

New Year's Day  
Independence Day  
Labor Day  
Veteran's Day  
Thanksgiving Day  
Christmas Day

Double time and one half the regular rate for work on the following holiday(s).

Martin Luther King Jr. Day  
President's Day  
Memorial Day  
Columbus Day

**Paid Holidays**

OFFICE OF THE COMPTROLLER, CITY OF NEW YORK  
§220 PREVAILING WAGE SCHEDULE

New Year's Day  
Martin Luther King Jr. Day  
President's Day  
Memorial Day  
Independence Day  
Labor Day  
Columbus Day  
Veteran's Day  
Thanksgiving Day  
Christmas Day

(Local #638B)

---

---

## STONE MASON - SETTER

### Stone Mason - Setters

Effective Period: 7/1/2016 - 6/30/2017  
Wage Rate per Hour: \$51.08  
Supplemental Benefit Rate per Hour: \$38.10

### Overtime

Time and one half the regular rate after a 7 hour day.  
Time and one half the regular rate for Saturday.  
Double time the regular rate for Sunday.

### Overtime Holidays

Double time the regular rate for work on the following holiday(s).

New Year's Day  
Washington's Birthday  
Good Friday  
Memorial Day  
Independence Day  
Labor Day  
Thanksgiving Day  
Christmas Day

### Paid Holidays

1/2 day on Christmas Eve if work is performed in the A.M.

### Shift Rates

For all work outside the regular workday (8:00 A.M. to 3:30 P.M. Monday through Friday), the pay shall be straight time plus a ten percent (10%) differential.

(Bricklayers District Council)

---

OFFICE OF THE COMPTROLLER, CITY OF NEW YORK  
§220 PREVAILING WAGE SCHEDULE

---

## TAPER

### Drywall Taper

Effective Period: 7/1/2016 - 12/27/2016

Wage Rate per Hour: **\$47.32**

Supplemental Benefit Rate per Hour: **\$22.68**

Effective Period: 12/28/2016 - 6/30/2017

Wage Rate per Hour: **\$47.82**

Supplemental Benefit Rate per Hour: **\$22.68**

### Overtime

Time and one half the regular rate after a 7 hour day.

Time and one half the regular rate for Saturday.

Time and one half the regular rate for Sunday.

### Overtime Holidays

Time and one half the regular rate for work on the following holiday(s).

New Year's Day

Martin Luther King Jr. Day

President's Day

Good Friday

Memorial Day

Independence Day

Labor Day

Columbus Day

Thanksgiving Day

Christmas Day

### Paid Holidays

Any worker who reports to work on Christmas Eve or New Year's Eve pursuant to his employer's instruction shall be entitled to three (3) hours afternoon pay without working.

### Shift Rates

Time and one half the regular rate outside the regular work hours (8:00 A.M. through 3:30 P.M.)

(Local #1974)

---

## TELECOMMUNICATION WORKER (Voice Installation Only)

OFFICE OF THE COMPTROLLER, CITY OF NEW YORK  
§220 PREVAILING WAGE SCHEDULE

**Telecommunication Worker**

Effective Period: 7/1/2016 - 6/30/2017

Wage Rate per Hour: \$40.35

Supplemental Benefit Rate per Hour: \$13.19

Supplemental Note: The above rate applies for Manhattan, Bronx, Brooklyn, Queens. \$12.64 for Staten Island only.

**Overtime**

Time and one half the regular rate after a 7 hour day.

Time and one half the regular rate for Saturday.

Time and one half the regular rate for Sunday.

**Overtime Holidays**

Time and one half the regular rate for work on the following holiday(s).

- New Year's Day
- Lincoln's Birthday
- Washington's Birthday
- Memorial Day
- Independence Day
- Labor Day
- Columbus Day
- Election Day
- Veteran's Day
- Thanksgiving Day
- Christmas Day

**Paid Holidays**

- New Year's Day
- Lincoln's Birthday
- Washington's Birthday
- Memorial Day
- Independence Day
- Labor Day
- Columbus Day
- Election Day
- Veteran's Day
- Thanksgiving Day
- Christmas Day

Employees have the option of observing either Martin Luther King's Birthday or the day after Thanksgiving instead of Lincoln's Birthday

**Shift Rates**

For any workday that starts before 8A.M. or ends after 6P.M. there is a 10% differential for the applicable worker's hourly rate.

**Vacation**

- After 6 months.....one week.
- After 12 months but less than 7 years.....two weeks.
- After 7 or more but less than 15 years.....three weeks.
- After 15 years or more but less than 25 years.....four weeks.

OFFICE OF THE COMPTROLLER, CITY OF NEW YORK  
§220 PREVAILING WAGE SCHEDULE

(C.W.A.)

---

---

## TILE FINISHER

### Tile Finisher

Effective Period: 7/1/2016 - 6/30/2017

Wage Rate per Hour: \$40.69

Supplemental Benefit Rate per Hour: \$30.58

### Overtime

Time and one half the regular rate after a 7 hour day.

Time and one half the regular rate for Saturday.

Double time the regular rate for Sunday.

### Overtime Holidays

Double time the regular rate for work on the following holiday(s).

New Year's Day

President's Day

Good Friday

Memorial Day

Independence Day

Labor Day

Columbus Day

Veteran's Day

Thanksgiving Day

Day after Thanksgiving

Christmas Day

### Paid Holidays

None

### Shift Rates

Off shift work day (work performed outside the regular 8:00 A.M. to 3:30 P.M. workday): shift differential of one and one quarter (1¼) times the regular straight time rate of pay for the seven hours of actual off-shift work.

(Local #7)

---

---

## TILE LAYER - SETTER

### Tile Layer - Setter

OFFICE OF THE COMPTROLLER, CITY OF NEW YORK  
§220 PREVAILING WAGE SCHEDULE

Effective Period: 7/1/2016 - 6/30/2017

Wage Rate per Hour: \$52.68

Supplemental Benefit Rate per Hour: \$34.48

### Overtime

Time and one half the regular rate after a 7 hour day.

Time and one half the regular rate for Saturday.

Double time the regular rate for Sunday.

### Overtime Holidays

Double time the regular rate for work on the following holiday(s).

New Year's Day

President's Day

Good Friday

Memorial Day

Independence Day

Labor Day

Columbus Day

Veteran's Day

Thanksgiving Day

Day after Thanksgiving

Christmas Day

### Shift Rates

Off shift work day (work performed outside the regular 8:00 A.M. to 3:30 P.M. workday): shift differential of one and one quarter (1¼) times the regular straight time rate of pay for the seven hours of actual off-shift work.

(Local #7)

---

---

## TIMBERPERSON

### Timberperson

Effective Period: 7/1/2016 - 6/30/2017

Wage Rate per Hour: \$46.99

Supplemental Benefit Rate per Hour: \$48.26

### Overtime

Time and one half the regular rate after an 8 hour day.

Time and one half the regular rate for Saturday.

Double time the regular rate for Sunday.

Saturday may be used as a make-up day at straight time when a day is lost during that week to inclement weather.

Time and one half the regular hourly rate after 40 hours in any work week.



OFFICE OF THE COMPTROLLER, CITY OF NEW YORK  
\$220 PREVAILING WAGE SCHEDULE

**Overtime Holidays**

Double time the regular rate for work on the following holiday(s).

New Year's Day  
President's Day  
Memorial Day  
Independence Day  
Labor Day  
Columbus Day  
Presidential Election Day  
Thanksgiving Day  
Christmas Day

**Paid Holidays**

None

**Shift Rates**

Off shift work commencing between 5:00 P.M. and 11:00 P.M. shall work eight and one half hours allowing for one half hour for lunch. The wage rate shall be 113% of the straight time hourly wage rate.

(Local #1536)

---

---

**TUNNEL WORKER**

**Blasters, Mucking Machine Operators (Compressed Air Rates)**

Effective Period: 7/1/2016 - 6/30/2017

Wage Rate per Hour: \$60.97

Supplemental Benefit Rate per Hour: \$50.72

**Tunnel Workers (Compressed Air Rates)**

Effective Period: 7/1/2016 - 6/30/2017

Wage Rate per Hour: \$58.86

Supplemental Benefit Rate per Hour: \$49.03

**Top Nipper (Compressed Air Rates)**

Effective Period: 7/1/2016 - 6/30/2017

Wage Rate per Hour: \$57.78

Supplemental Benefit Rate per Hour: \$48.16

**Outside Lock Tender, Outside Gauge Tender, Muck Lock Tender (Compressed Air Rates)**

Effective Period: 7/1/2016 - 6/30/2017

OFFICE OF THE COMPTROLLER, CITY OF NEW YORK  
§220 PREVAILING WAGE SCHEDULE

Wage Rate per Hour: \$56.74  
Supplemental Benefit Rate per Hour: \$47.25

**Bottom Bell & Top Bell Signal Person: Shaft Person (Compressed Air Rates)**

Effective Period: 7/1/2016 - 6/30/2017  
Wage Rate per Hour: \$56.74  
Supplemental Benefit Rate per Hour: \$47.25

**Changehouse Attendant: Powder Watchperson (Compressed Air Rates)**

Effective Period: 7/1/2016 - 6/30/2017  
Wage Rate per Hour: \$49.69  
Supplemental Benefit Rate per Hour: \$44.69

**Blasters (Free Air Rates)**

Effective Period: 7/1/2016 - 6/30/2017  
Wage Rate per Hour: \$58.19  
Supplemental Benefit Rate per Hour: \$48.68

**Tunnel Workers (Free Air Rates)**

Effective Period: 7/1/2016 - 6/30/2017  
Wage Rate per Hour: \$55.69  
Supplemental Benefit Rate per Hour: \$46.61

**All Others (Free Air Rates)**

Effective Period: 7/1/2016 - 6/30/2017  
Wage Rate per Hour: \$51.45  
Supplemental Benefit Rate per Hour: \$43.13

**Microtunneling (Free Air Rates)**

Effective Period: 7/1/2016 - 6/30/2017  
Wage Rate per Hour: \$44.55  
Supplemental Benefit Rate per Hour: \$37.29

**Overtime Description**

For Repair-Maintenance Work on Existing Equipment and Facilities - Time and one half the regular rate after a 7 hour day, or for Saturday, or for Sunday. Double time the regular rate for work on a holiday.  
For Small-Bore Micro Tunneling Machines - Time and one-half the regular rate shall be paid for all overtime.

**Overtime**

Double time the regular rate after an 8 hour day.  
Double time the regular time rate for Saturday.  
Double time the regular rate for Sunday.  
Double time the regular rate for work on the following holiday(s).

OFFICE OF THE COMPTROLLER, CITY OF NEW YORK  
§220 PREVAILING WAGE SCHEDULE

**Paid Holidays**

New Year's Day  
Lincoln's Birthday  
President's Day  
Memorial Day  
Independence Day  
Labor Day  
Columbus Day  
Election Day  
Veteran's Day  
Thanksgiving Day  
Christmas Day

(Local #147)

---

---

**WELDER**

**TO BE PAID AT THE RATE OF THE JOURNEYPERSON IN THE TRADE  
PERFORMING THE WORK.**

**(NO TEXT ON THIS PAGE)**

**OFFICE OF THE COMPTROLLER**

**CITY OF NEW YORK**

**220 APPRENTICESHIP PREVAILING WAGE SCHEDULE**

**APPENDIX**

**Pursuant to Labor Law §220 (3-e), only apprentices who are individually registered in a bona fide program to which the employer contractor is a participant and registered with the New York State Department of Labor, may be employed on a public work project.**

**Any employee listed on a payroll at an apprentice wage rate, who is not registered as above, shall be paid the journey person wage rate for the classification of work he actually performed.**

**Apprentice ratios are established to ensure the proper safety, training and supervision of apprentices. A ratio establishes the number of journey workers required for each apprentice in a program and on a job site. Ratios are interpreted as follows: in the case of a 1:1, 1:4 ratio, there must be one journey worker for the first apprentice, and four additional journey workers for each subsequent apprentice.**

OFFICE OF THE COMPTROLLER, CITY OF NEW YORK  
 §220 APPRENTICESHIP PREVAILING WAGE SCHEDULE

**TABLE OF CONTENTS**

<u>CLASSIFICATION</u>	<u>PAGE</u>
ASBESTOS HANDLER .....	3
BOILERMAKER.....	3
BRICKLAYER.....	4
CARPENTER.....	5
CEMENT MASON.....	6
CEMENT AND CONCRETE WORKER.....	7
DERRICKPERSON & RIGGER (STONE) .....	8
DOCKBUILDER/PILE DRIVER .....	8
ELECTRICIAN .....	9
ELEVATOR CONSTRUCTOR.....	12
ELEVATOR REPAIR & MAINTENANCE .....	13
ENGINEER.....	14
ENGINEER - OPERATING .....	14
FLOOR COVERER.....	15
GLAZIER.....	16
HEAT & FROST INSULATOR.....	16
HOUSE WRECKER .....	17
IRON WORKER - ORNAMENTAL .....	18
IRON WORKER - STRUCTURAL .....	18
LABORER (FOUNDATION, CONCRETE, EXCAVATING, STREET PIPE LAYER & COMMON).....	19
MARBLE MECHANICS .....	20
MASON TENDER .....	21
METALLIC LATHER.....	22
MILLWRIGHT.....	22
PAVER AND ROADBUILDER.....	23
PAINTER.....	24
PAINTER - METAL POLISHER.....	25
PAINTER - STRUCTURAL STEEL .....	25
PLASTERER.....	26
PLASTERER - TENDER.....	27
PLUMBER.....	27
POINTER, WATERPROOFER, CAULKER, SANDBLASTER, STEAMBLASTER .....	29
ROOFER.....	29
SHEET METAL WORKER.....	30
SIGN ERECTOR .....	31
STEAMFITTER .....	32
STONE MASON - SETTER .....	33
TAPER .....	34
TILE LAYER - SETTER .....	35
TIMBERPERSON.....	35

OFFICE OF THE COMPTROLLER, CITY OF NEW YORK  
\$220 APPRENTICESHIP PREVAILING WAGE SCHEDULE

**ASBESTOS HANDLER**

(Ratio of Apprentice Journeyperson: 1 to 1, 1 to 3)

**Asbestos Handler (First 1000 Hours)**

Effective Period: 7/1/2016 - 6/30/2017  
Wage Rate Per Hour: 78% of Journeyperson's rate  
Supplemental Benefit Rate Per Hour: \$16.45

**Asbestos Handler (Second 1000 Hours)**

Effective Period: 7/1/2016 - 6/30/2017  
Wage Rate Per Hour: 80% of Journeyperson's rate  
Supplemental Benefit Rate Per Hour: \$16.45

**Asbestos Handler (Third 1000 Hours)**

Effective Period: 7/1/2016 - 6/30/2017  
Wage Rate Per Hour: 83% of Journeyperson's rate  
Supplemental Benefit Rate Per Hour: \$16.45

**Asbestos Handler (Fourth 1000 Hours)**

Effective Period: 7/1/2016 - 6/30/2017  
Wage Rate Per Hour: 89% of Journeyperson's rate  
Supplemental Benefit Rate Per Hour: \$16.45

(Local #78)

---

---

**BOILERMAKER**

(Ratio of Apprentice to Journeyperson: 1 to 1, 1 to 3)

**Boilermaker (First Year)**

Effective Period: 7/1/2016 - 6/30/2017  
Wage Rate Per Hour: 65% of Journeyperson's rate  
Supplemental Benefit Rate Per Hour: \$30.43  
Effective 1/1/2017 - Supplemental Benefit Rate Per Hour: \$30.84

**Boilermaker (Second Year: 1st Six Months)**

Effective Period: 7/1/2016 - 6/30/2017

OFFICE OF THE COMPTROLLER, CITY OF NEW YORK  
§220 APPRENTICESHIP PREVAILING WAGE SCHEDULE

Wage Rate Per Hour: 70% of Journeyman's rate  
Supplemental Benefit Rate Per Hour: \$32.13  
Effective 1/1/2017 - Supplemental Benefit Rate Per Hour: \$32.57

**Boilermaker (Second Year: 2nd Six Months)**

Effective Period: 7/1/2016 - 6/30/2017  
Wage Rate Per Hour: 75% of Journeyman's rate  
Supplemental Benefit Rate Per Hour: \$33.82  
Effective 1/1/2017 - Supplemental Benefit Rate Per Hour: \$34.29

**Boilermaker (Third Year: 1st Six Months)**

Effective Period: 7/1/2016 - 6/30/2017  
Wage Rate Per Hour: 80% of Journeyman's rate  
Supplemental Benefit Rate Per Hour: \$35.53  
Effective 1/1/2017 - Supplemental Benefit Rate Per Hour: \$36.03

**Boilermaker (Third Year: 2nd Six Months)**

Effective Period: 7/1/2016 - 6/30/2017  
Wage Rate Per Hour: 85% of Journeyman's rate  
Supplemental Benefit Rate Per Hour: \$37.23  
Effective 1/1/2017 - Supplemental Benefit Rate Per Hour: \$37.76

**Boilermaker (Fourth Year: 1st Six Months)**

Effective Period: 7/1/2016 - 6/30/2017  
Wage Rate Per Hour: 90% of Journeyman's rate  
Supplemental Benefit Rate Per Hour: \$38.93  
Effective 1/1/2017 - Supplemental Benefit Rate Per Hour: \$39.51

**Boilermaker (Fourth Year: 2nd Six Months)**

Effective Period: 7/1/2016 - 6/30/2017  
Wage Rate Per Hour: 95% of Journeyman's rate  
Supplemental Benefit Rate Per Hour: \$40.63  
Effective 1/1/2017 - Supplemental Benefit Rate Per Hour: \$41.22

(Local #5)

---

---

**BRICKLAYER**

(Ratio of Apprentice to Journeyman: 1 to 1, 1 to 4)

**Bricklayer (First 750 Hours)**



OFFICE OF THE COMPTROLLER, CITY OF NEW YORK  
§220 APPRENTICESHIP PREVAILING WAGE SCHEDULE

Effective Period: 7/1/2016 - 6/30/2017  
Wage Rate Per Hour: 50% of Journeyperson's rate  
Supplemental Benefit Rate Per Hour: \$18.35

**Bricklayer (Second 750 Hours)**

Effective Period: 7/1/2016 - 6/30/2017  
Wage Rate Per Hour: 60% of Journeyperson's rate  
Supplemental Benefit Rate Per Hour: \$18.35

**Bricklayer (Third 750 Hours)**

Effective Period: 7/1/2016 - 6/30/2017  
Wage Rate Per Hour: 70% of Journeyperson's rate  
Supplemental Benefit Rate Per Hour: \$18.35

**Bricklayer (Fourth 750 Hours)**

Effective Period: 7/1/2016 - 6/30/2017  
Wage Rate Per Hour: 80% of Journeyperson's rate  
Supplemental Benefit Rate Per Hour: \$18.35

**Bricklayer (Fifth 750 Hours)**

Effective Period: 7/1/2016 - 6/30/2017  
Wage Rate Per Hour: 90% of Journeyperson's rate  
Supplemental Benefit Rate Per Hour: \$18.35

**Bricklayer (Sixth 750 Hours)**

Effective Period: 7/1/2016 - 6/30/2017  
Wage Rate Per Hour: 95% of Journeyperson's rate  
Supplemental Benefit Rate Per Hour: \$18.35

(Bricklayer District Council)

---

---

**CARPENTER**

(Ratio of Apprentice to Journeyperson: 1 to 1, 1 to 4)

**Carpenter (First Year)**

Effective Period: 7/1/2016 - 6/30/2017  
Wage Rate Per Hour: 40% of Journeyperson's rate  
Supplemental Benefit Rate Per Hour For Building Apprentice: \$31.34

OFFICE OF THE COMPTROLLER, CITY OF NEW YORK  
§220 APPRENTICESHIP PREVAILING WAGE SCHEDULE

Supplemental Benefit Rate Per Hour For Heavy Apprentice: \$32.52

**Carpenter (Second Year)**

Effective Period: 7/1/2016 - 6/30/2017

Wage Rate Per Hour: 50% of Journeyman's rate

Supplemental Benefit Rate Per Hour For Building Apprentice: \$31.34

Supplemental Benefit Rate Per Hour For Heavy Apprentice: \$32.52

**Carpenter (Third Year)**

Effective Period: 7/1/2016 - 6/30/2017

Wage Rate Per Hour: 65% of Journeyman's rate

Supplemental Benefit Rate Per Hour For Building Apprentice: \$31.34

Supplemental Benefit Rate Per Hour For Heavy Apprentice: \$32.52

**Carpenter (Fourth Year)**

Effective Period: 7/1/2016 - 6/30/2017

Wage Rate Per Hour: 80% of Journeyman's rate

Supplemental Benefit Rate Per Hour For Building Apprentice: \$31.34

Supplemental Benefit Rate Per Hour For Heavy Apprentice: \$32.52

(Carpenters District Council)

---

---

**CEMENT MASON**

(Ratio of Apprentice to Journeyman: 1 to 1, 1 to 4)

**Cement Mason (First Year)**

Effective Period: 7/1/2016 - 6/30/2017

Wage and Supplemental Rate Per Hour: 50% of Journeyman's Rate

**Cement Mason (Second Year)**

Effective Period: 7/1/2016 - 6/30/2017

Wage and Supplemental Rate Per Hour: 60% of Journeyman's Rate

**Cement Mason (Third Year)**

Effective Period: 7/1/2016 - 6/30/2017

Wage and Supplemental Rate Per Hour: 70% of Journeyman's Rate

(Local #780)

**CEMENT AND CONCRETE WORKER**  
**(Ratio of Apprentice to Journeyman: 1 to 1, 1 to 3)**

**Cement & Concrete Worker (First 1333 hours)**

Effective Period: 7/1/2016 - 6/30/2017  
Wage Rate Per Hour: 50% of Journeyman's rate  
Supplemental Benefit Rate Per Hour: \$16.25

**Cement & Concrete Worker (Second 1333 hours)**

Effective Period: 7/1/2016 - 6/30/2017  
Wage Rate Per Hour: 65% of Journeyman's rate  
Supplemental Benefit Rate Per Hour: \$21.08

**Cement & Concrete Worker (Last 1334 hours)**

Effective Period: 7/1/2016 - 6/30/2017  
Wage Rate Per Hour: 80% of Journeyman's rate  
Supplemental Benefit Rate Per Hour: \$21.90

**Cement & Concrete Worker (Hired after 2/6/2016 - First 1334 hours)**

Effective Period: 7/1/2016 - 6/30/2017  
Wage Rate Per Hour: \$17.00  
Supplemental Benefit Rate Per Hour: \$10.75

**Cement & Concrete Worker (Hired after 2/6/2016 - Second 1334 hours)**

Effective Period: 7/1/2016 - 6/30/2017  
Wage Rate Per Hour: \$22.10  
Supplemental Benefit Rate Per Hour: \$15.13

**Cement & Concrete Worker (Hired after 2/6/2016 - Last 1334 hours)**

Effective Period: 7/1/2016 - 6/30/2017  
Wage Rate Per Hour: \$27.20  
Supplemental Benefit Rate Per Hour: \$15.63

(Cement Concrete Workers District Council)

---

---

**DERRICKPERSON & RIGGER (STONE)**  
(Ratio of Apprentice to Journeyman: 1 to 1, 1 to 4)

**Derrickperson & Rigger (stone) - First Year**

Effective Period: 7/1/2016 - 6/30/2017  
Wage Rate Per Hour: 50% of Journeyman's rate  
Supplemental Benefit Rate Per Hour: 50% of Journeyman's rate

**Derrickperson & Rigger (stone) - Second Year: 1st Six Months**

Effective Period: 7/1/2016 - 6/30/2017  
Wage Rate Per Hour: 70% of Journeyman's rate  
Supplemental Benefit Rate Per Hour: 75% of Journeyman's rate

**Derrickperson & Rigger (stone) - Second Year: 2nd Six Months**

Effective Period: 7/1/2016 - 6/30/2017  
Wage Rate Per Hour: 80% of Journeyman's rate  
Supplemental Benefit Rate Per Hour: 75% of Journeyman's rate

**Derrickperson & Rigger (stone) - Third Year**

Effective Period: 7/1/2016 - 6/30/2017  
Wage Rate Per Hour: 90% of Journeyman's rate  
Supplemental Benefit Rate Per Hour: 75% of Journeyman's rate

(Local #197)

---

---

**DOCKBUILDER/PILE DRIVER**  
(Ratio of Apprentice to Journeyman: 1 to 1, 1 to 6)

**Dockbuilder/Pile Driver (First Year)**

Effective Period: 7/1/2016 - 6/30/2017  
Wage Rate Per Hour: 40% of Journeyman's rate  
Supplemental Benefit Rate Per Hour: \$32.52

**Dockbuilder/Pile Driver (Second Year)**

Effective Period: 7/1/2016 - 6/30/2017  
Wage Rate Per Hour: 50% of Journeyman's rate

OFFICE OF THE COMPTROLLER, CITY OF NEW YORK  
\$220 APPRENTICESHIP PREVAILING WAGE SCHEDULE

Supplemental Benefit Rate Per Hour: \$32.52

**Dockbuilder/Pile Driver (Third Year)**

Effective Period: 7/1/2016 - 6/30/2017

Wage Rate Per Hour: 65% of Journeyperson's rate

Supplemental Benefit Rate Per Hour: \$32.52

**Dockbuilder/Pile Driver (Fourth Year)**

Effective Period: 7/1/2016 - 6/30/2017

Wage Rate Per Hour: 80% of Journeyperson's rate

Supplemental Benefit Rate Per Hour: \$32.52

(Carpenters District Council)

---

---

**ELECTRICIAN**

(Ratio of Apprentice to Journeyperson: 1 to 1, 1 to 3)

**Electrician (First Term: 0-6 Months)**

Effective Period: 7/1/2016 - 5/10/2017

Wage Rate per Hour: \$13.50

Supplemental Benefit Rate per Hour: \$12.12

Overtime Supplemental Rate Per Hour: \$13.01

Effective Period: 5/11/2017 - 6/30/2017

Wage Rate per Hour: \$14.00

Supplemental Benefit Rate per Hour: \$12.37

Overtime Supplemental Rate Per Hour: \$13.29

**Electrician (First Term: 7-12 Months)**

Effective Period: 7/1/2016 - 5/10/2017

Wage Rate per Hour: \$14.50

Supplemental Benefit Rate per Hour: \$12.63

Overtime Supplemental Rate Per Hour: \$13.58

Effective Period: 5/11/2017 - 6/30/2017

Wage Rate per Hour: \$15.00

Supplemental Benefit Rate per Hour: \$12.88

Overtime Supplemental Rate Per Hour: \$13.87

**Electrician (Second Term: 0-6 Months)**

OFFICE OF THE COMPTROLLER, CITY OF NEW YORK  
§220 APPRENTICESHIP PREVAILING WAGE SCHEDULE

Effective Period: 7/1/2016 - 5/10/2017  
Wage Rate per Hour: \$15.50  
Supplemental Benefit Rate per Hour: \$13.14  
Overtime Supplemental Rate Per Hour: \$14.16

Effective Period: 5/11/2017 - 6/30/2017  
Wage Rate per Hour: \$16.00  
Supplemental Benefit Rate per Hour: \$13.39  
Overtime Supplemental Rate Per Hour: \$14.44

**Electrician (Second Term: 7-12 Months)**

Effective Period: 7/1/2016 - 5/10/2017  
Wage Rate per Hour: \$16.50  
Supplemental Benefit Rate per Hour: \$13.64  
Overtime Supplemental Rate Per Hour: \$14.73

Effective Period: 5/11/2017 - 6/30/2017  
Wage Rate per Hour: \$17.00  
Supplemental Benefit Rate per Hour: \$13.90  
Overtime Supplemental Rate Per Hour: \$15.02

**Electrician (Third Term: 0-6 Months)**

Effective Period: 7/1/2016 - 5/10/2017  
Wage Rate per Hour: \$17.50  
Supplemental Benefit Rate per Hour: \$14.15  
Overtime Supplemental Rate Per Hour: \$15.31

Effective Period: 5/11/2017 - 6/30/2017  
Wage Rate per Hour: \$18.00  
Supplemental Benefit Rate per Hour: \$14.41  
Overtime Supplemental Rate Per Hour: \$15.59

**Electrician (Third Term: 7-12 Months)**

Effective Period: 7/1/2016 - 5/10/2017  
Wage Rate per Hour: \$18.50  
Supplemental Benefit Rate per Hour: \$14.66  
Overtime Supplemental Rate Per Hour: \$15.88

Effective Period: 5/11/2017 - 6/30/2017  
Wage Rate per Hour: \$19.00  
Supplemental Benefit Rate per Hour: \$14.92  
Overtime Supplemental Rate Per Hour: \$16.17

**Electrician (Fourth Term: 0-6 Months)**

Effective Period: 7/1/2016 - 5/10/2017

OFFICE OF THE COMPTROLLER, CITY OF NEW YORK  
\$220 APPRENTICESHIP PREVAILING WAGE SCHEDULE

Wage Rate per Hour: **\$19.50**  
Supplemental Benefit Rate per Hour: **\$15.17**  
Overtime Supplemental Rate Per Hour: **\$16.45**

Effective Period: 5/11/2017 - 6/30/2017  
Wage Rate per Hour: **\$20.00**  
Supplemental Benefit Rate per Hour: **\$15.43**  
Overtime Supplemental Rate Per Hour: **\$16.75**

**Electrician (Fourth Term: 7-12 Months)**

Effective Period: 7/1/2016 - 5/10/2017  
Wage Rate per Hour: **\$21.50**  
Supplemental Benefit Rate per Hour: **\$16.19**  
Overtime Supplemental Rate Per Hour: **\$17.60**

Effective Period: 5/11/2017 - 6/30/2017  
Wage Rate per Hour: **\$22.00**  
Supplemental Benefit Rate per Hour: **\$16.44**  
Overtime Supplemental Rate Per Hour: **\$17.89**

**Electrician (Fifth Term: 0-12 Months)**

Effective Period: 7/1/2016 - 5/10/2017  
Wage Rate per Hour: **\$23.50**  
Supplemental Benefit Rate per Hour: **\$19.54**  
Overtime Supplemental Rate Per Hour: **\$21.01**

Effective Period: 5/11/2017 - 6/30/2017  
Wage Rate per Hour: **\$24.00**  
Supplemental Benefit Rate per Hour: **\$19.80**  
Overtime Supplemental Rate Per Hour: **\$21.30**

**Electrician (Fifth Term: 13-18 Months)**

Effective Period: 7/1/2016 - 5/10/2017  
Wage Rate per Hour: **\$28.00**  
Supplemental Benefit Rate per Hour: **\$21.85**  
Overtime Supplemental Rate Per Hour: **\$23.60**

Effective Period: 5/11/2017 - 6/30/2017  
Wage Rate per Hour: **\$28.50**  
Supplemental Benefit Rate per Hour: **\$22.10**  
Overtime Supplemental Rate Per Hour: **\$23.89**

**Overtime Description**

Overtime Wage paid at time and one half the regular rate

(Local #3)

## **ELEVATOR CONSTRUCTOR** **(Ratio of Apprentice to Journeyman: 1 to 1, 1 to 2)**

### **Elevator (Constructor) - First Year**

Effective Period: 7/1/2016 - 3/16/2017  
Wage Rate Per Hour: 50% of Journeyman's rate  
Supplemental Rate Per Hour: \$28.24

Effective Period: 3/17/2017 - 6/30/2017  
Wage Rate Per Hour: 50% of Journeyman's rate  
Supplemental Rate Per Hour: \$29.72

### **Elevator (Constructor) - Second Year**

Effective Period: 7/1/2016 - 3/16/2017  
Wage Rate Per Hour: 55% of Journeyman's rate  
Supplemental Rate Per Hour: \$28.67

Effective Period: 3/17/2017 - 6/30/2017  
Wage Rate Per Hour: 55% of Journeyman's rate  
Supplemental Rate Per Hour: \$30.15

### **Elevator (Constructor) - Third Year**

Effective Period: 7/1/2016 - 3/16/2017  
Wage Rate Per Hour: 65% of Journeyman's rate  
Supplemental Rate Per Hour: \$29.52

Effective Period: 3/17/2017 - 6/30/2017  
Wage Rate Per Hour: 65% of Journeyman's rate  
Supplemental Rate Per Hour: \$31.03

### **Elevator (Constructor) - Fourth Year**

Effective Period: 7/1/2016 - 3/16/2017  
Wage Rate Per Hour: 75% of Journeyman's rate  
Supplemental Rate Per Hour: \$30.37

Effective Period: 3/17/2017 - 6/30/2017  
Wage Rate Per Hour: 75% of Journeyman's rate  
Supplemental Rate Per Hour: \$31.91

(Local #1)



**ELEVATOR REPAIR & MAINTENANCE**  
**(Ratio of Apprentice to Journeyman: 1 to 1, 1 to 2)**

**Elevator Service/Modernization Mechanic (First Year)**

Effective Period: 7/1/2016 - 3/16/2017  
Wage Rate Per Hour: 50% of Journeyman's rate  
Supplemental Benefit Per Hour: \$28.33

Effective Period: 3/17/2017 - 6/30/2017  
Wage Rate Per Hour: 50% of Journeyman's rate  
Supplemental Benefit Per Hour: \$29.80

**Elevator Service/Modernization Mechanic (Second Year)**

Effective Period: 7/1/2016 - 3/16/2017  
Wage Rate Per Hour: 55% of Journeyman's rate  
Supplemental Benefit Per Hour: \$28.74

Effective Period: 3/17/2017 - 6/30/2017  
Wage Rate Per Hour: 55% of Journeyman's rate  
Supplemental Benefit Per Hour: \$30.23

**Elevator Service/Modernization Mechanic (Third Year)**

Effective Period: 7/1/2016 - 3/16/2017  
Wage Rate Per Hour: 65% of Journeyman's rate  
Supplemental Benefit Per Hour: \$29.58

Effective Period: 3/17/2017 - 6/30/2017  
Wage Rate Per Hour: 65% of Journeyman's rate  
Supplemental Benefit Per Hour: \$31.09

**Elevator Service/Modernization Mechanic (Fourth Year)**

Effective Period: 7/1/2016 - 3/16/2017  
Wage Rate Per Hour: 75% of Journeyman's rate  
Supplemental Benefit Per Hour: \$30.42

Effective Period: 3/17/2017 - 6/30/2017  
Wage Rate Per Hour: 75% of Journeyman's rate  
Supplemental Benefit Per Hour: \$31.95

(Local #1)

---

OFFICE OF THE COMPTROLLER, CITY OF NEW YORK  
§220 APPRENTICESHIP PREVAILING WAGE SCHEDULE

---

**ENGINEER**

(Ratio of Apprentice to Journeyman: 1 to 1, 1 to 5)

**Engineer - First Year**

Effective Period: 7/1/2016 - 6/30/2017

Wage Rate per Hour: \$24.28

Supplemental Benefit Rate per Hour: \$23.41

**Engineer - Second Year**

Effective Period: 7/1/2016 - 6/30/2017

Wage Rate per Hour: \$30.35

Supplemental Benefit Rate per Hour: \$23.41

**Engineer - Third Year**

Effective Period: 7/1/2016 - 6/30/2017

Wage Rate per Hour: \$33.38

Supplemental Benefit Rate per Hour: \$23.41

**Engineer - Fourth Year**

Effective Period: 7/1/2016 - 6/30/2017

Wage Rate per Hour: \$36.41

Supplemental Benefit Rate per Hour: \$23.41

(Local #15)

---

---

**ENGINEER - OPERATING**

(Ratio of Apprentice to Journeyman: 1 to 1, 1 to 5)

**Operating Engineer - First Year**

Effective Period: 7/1/2016 - 6/30/2017

Wage Rate Per Hour 40% of Journeyman's Rate

Supplemental Benefit Per Hour: \$20.85

**Operating Engineer - Second Year**

OFFICE OF THE COMPTROLLER, CITY OF NEW YORK  
\$220 APPRENTICESHIP PREVAILING WAGE SCHEDULE

Effective Period: 7/1/2016 - 6/30/2017  
Wage Rate Per Hour: 50% of Journeyperson's Rate  
Supplemental Benefit Per Hour: \$20.85

**Operating Engineer - Third Year**

Effective Period: 7/1/2016 - 6/30/2017  
Wage Rate Per Hour: 60% of Journeyperson's Rate  
Supplemental Benefit Per Hour: \$20.85

(Local #14)

---

---

**FLOOR COVERER**  
(Ratio of Apprentice to Journeyperson: 1 to 1, 1 to 4)

**Floor Coverer (First Year)**

Effective Period: 7/1/2016 - 6/30/2017  
Wage Rate Per Hour: 40% of Journeyperson's rate  
Supplemental Rate Per Hour: \$31.14

**Floor Coverer (Second Year)**

Effective Period: 7/1/2016 - 6/30/2017  
Wage Rate Per Hour: 50% of Journeyperson's rate  
Supplemental Rate Per Hour: \$31.14

**Floor Coverer (Third Year)**

Effective Period: 7/1/2016 - 6/30/2017  
Wage Rate Per Hour: 65% of Journeyperson's rate  
Supplemental Rate Per Hour: \$31.14

**Floor Coverer (Fourth Year)**

Effective Period: 7/1/2016 - 6/30/2017  
Wage Rate Per Hour: 80% of Journeyperson's rate  
Supplemental Rate Per Hour: \$31.14

(Carpenters District Council)

---

---

OFFICE OF THE COMPTROLLER, CITY OF NEW YORK  
§220 APPRENTICESHIP PREVAILING WAGE SCHEDULE

## **GLAZIER**

**(Ratio of Apprentice to Journeyman: 1 to 1, 1 to 3)**

### **Glazier (First Year)**

Effective Period: 7/1/2016 - 6/30/2017

Wage Rate Per Hour: 40% of Journeyman's rate

Supplemental Rate Per Hour: \$14.14

### **Glazier (Second Year)**

Effective Period: 7/1/2016 - 6/30/2017

Wage Rate Per Hour: 50% of Journeyman's rate

Supplemental Rate Per Hour: \$23.77

### **Glazier (Third Year)**

Effective Period: 7/1/2016 - 6/30/2017

Wage Rate Per Hour: 60% of Journeyman's rate

Supplemental Rate Per Hour: \$26.73

### **Glazier (Fourth Year)**

Effective Period: 7/1/2016 - 6/30/2017

Wage Rate Per Hour: 80% of Journeyman's rate

Supplemental Rate Per Hour: \$32.14

(Local #1281)

---

---

## **HEAT & FROST INSULATOR**

**(Ratio of Apprentice to Journeyman: 1 to 1, 1 to 4)**

### **Heat & Frost Insulator (First Year)**

Effective Period: 7/1/2016 - 6/30/2017

Wage and Supplemental Rate Per Hour: 40% of Journeyman's rate

### **Heat & Frost Insulator (Second Year)**

Effective Period: 7/1/2016 - 6/30/2017

Wage and Supplemental Rate Per Hour: 60% of Journeyman's rate

OFFICE OF THE COMPTROLLER, CITY OF NEW YORK  
\$220 APPRENTICESHIP PREVAILING WAGE SCHEDULE

**Heat & Frost Insulator (Third Year)**

Effective Period: 7/1/2016 - 6/30/2017

Wage and Supplemental Rate Per Hour: 70% of Journeyperson's rate

**Heat & Frost Insulator (Fourth Year)**

Effective Period: 7/1/2016 - 6/30/2017

Wage and Supplemental Rate Per Hour: 80% of Journeyperson's rate

(Local #12)

---

---

**HOUSE WRECKER  
(TOTAL DEMOLITION)  
(Ratio of Apprentice to Journeyperson: 1 to 1, 1 to 3)**

**House Wrecker - First Year**

Effective Period: 7/1/2016 - 6/30/2017

Wage Rate per Hour: \$21.17

Supplemental Benefit Rate per Hour: \$17.99

**House Wrecker - Second Year**

Effective Period: 7/1/2016 - 6/30/2017

Wage Rate per Hour: \$22.32

Supplemental Benefit Rate per Hour: \$17.99

**House Wrecker - Third Year**

Effective Period: 7/1/2016 - 6/30/2017

Wage Rate per Hour: \$23.97

Supplemental Benefit Rate per Hour: \$17.99

**House Wrecker - Fourth Year**

Effective Period: 7/1/2016 - 6/30/2017

Wage Rate per Hour: \$26.53

Supplemental Benefit Rate per Hour: \$17.99

(Mason Tenders District Council)

---

## **IRON WORKER - ORNAMENTAL**

(Ratio of Apprentice to Journeyman: 1 to 1, 1 to 4)

### **Iron Worker (Ornamental) - 1st Ten Months**

Effective Period: 7/1/2016 - 6/30/2017  
Wage Rate Per Hour: 50% of Journeyman's rate  
Supplemental Rate Per Hour: \$37.90

### **Iron Worker (Ornamental) - 11 -16 Months**

Effective Period: 7/1/2016 - 6/30/2017  
Wage Rate Per Hour: 55% of Journeyman's rate  
Supplemental Rate Per Hour: \$39.06

### **Iron Worker (Ornamental) - 17 - 22 Months**

Effective Period: 7/1/2016 - 6/30/2017  
Wage Rate Per Hour: 60% of Journeyman's rate  
Supplemental Rate Per Hour: \$40.23

### **Iron Worker (Ornamental) - 23 - 28 Months**

Effective Period: 7/1/2016 - 6/30/2017  
Wage Rate Per Hour: 70% of Journeyman's rate  
Supplemental Rate Per Hour: \$42.57

### **Iron Worker (Ornamental) - 29 - 36 Months**

Effective Period: 7/1/2016 - 6/30/2017  
Wage Rate Per Hour: 80% of Journeyman's rate  
Supplemental Rate Per Hour: \$44.90

(Local #580)

---

---

## **IRON WORKER - STRUCTURAL**

(Ratio of Apprentice to Journeyman: 1 to 1, 1 to 6)

### **Iron Worker (Structural) - 1st Six Months**

OFFICE OF THE COMPTROLLER, CITY OF NEW YORK  
\$220 APPRENTICESHIP PREVAILING WAGE SCHEDULE

Effective Period: 7/1/2016 - 6/30/2017  
Wage Rate per Hour: \$25.85  
Supplemental Benefit Rate per Hour: \$48.35

**Iron Worker (Structural) - 7- 18 Months**

Effective Period: 7/1/2016 - 6/30/2017  
Wage Rate per Hour: \$26.45  
Supplemental Benefit Rate per Hour: \$48.35

**Iron Worker (Structural) - 19 - 36 months**

Effective Period: 7/1/2016 - 6/30/2017  
Wage Rate per Hour: \$27.05  
Supplemental Benefit Rate per Hour: \$48.35

(Local #40 and #361)

---

---

**LABORER (FOUNDATION, CONCRETE, EXCAVATING, STREET PIPE  
LAYER & COMMON)  
(Ratio Apprentice to Journeyman: 1 to 1, 1 to 3)**

**Laborer (Foundation, Concrete, Excavating, Street Pipe Layer & Common) - First  
1000 hours**

Effective Period: 7/1/2016 - 6/30/2017  
Wage Rate Per Hour: 50% of Journeyman's rate  
Supplemental Rate Per Hour: \$38.63

**Laborer (Foundation, Concrete, Excavating, Street Pipe Layer & Common) -  
Second 1000 hours**

Effective Period: 7/1/2016 - 6/30/2017  
Wage Rate Per Hour: 60% of Journeyman's rate  
Supplemental Rate Per Hour: \$38.63

**Laborer (Foundation, Concrete, Excavating, Street Pipe Layer & Common) -  
Third 1000 hours**

Effective Period: 7/1/2016 - 6/30/2017  
Wage Rate Per Hour: 75% of Journeyman's rate  
Supplemental Rate Per Hour: \$38.63

OFFICE OF THE COMPTROLLER, CITY OF NEW YORK  
§220 APPRENTICESHIP PREVAILING WAGE SCHEDULE

**Laborer (Foundation, Concrete, Excavating, Street Pipe Layer & Common) -  
Fourth 1000 hours**

Effective Period: 7/1/2016 - 6/30/2017  
Wage Rate Per Hour: 90% of Journeyperson's rate  
Supplemental Rate Per Hour: \$38.63

(Local #731)

---

---

**MARBLE MECHANICS  
(Ratio of Apprentice to Journeyperson: 1 to 1, 1 to 4)**

**Cutters & Setters - First 750 Hours**

Effective Period: 7/1/2016 - 6/30/2017  
Wage and Supplemental Rate Per Hour: 50% of Journeyperson's rate

NO BENEFITS PAID DURING THE FIRST TWO MONTHS (PROBATIONARY PERIOD)

**Cutters & Setters - Second 750 Hours**

Effective Period: 7/1/2016 - 6/30/2017  
Wage and Supplemental Rate Per Hour: 55% of Journeyperson's rate

**Cutters & Setters - Third 750 Hours**

Effective Period: 7/1/2016 - 6/30/2017  
Wage and Supplemental Rate Per Hour: 65% of Journeyperson's rate

**Cutters & Setters - Fourth 750 Hours**

Effective Period: 7/1/2016 - 6/30/2017  
Wage and Supplemental Rate Per Hour: 75% of Journeyperson's rate

**Cutters & Setters - Fifth 750 Hours**

Effective Period: 7/1/2016 - 6/30/2017  
Wage and Supplemental Rate Per Hour: 85% of Journeyperson's rate

**Cutters & Setters - Sixth 750 Hours**

Effective Period: 7/1/2016 - 6/30/2017  
Wage and Supplemental Rate Per Hour: 95% of Journeyperson's rate



OFFICE OF THE COMPTROLLER, CITY OF NEW YORK  
§220 APPRENTICESHIP PREVAILING WAGE SCHEDULE

**Polishers & Finishers - First 750 Hours**

Effective Period: 7/1/2016 - 6/30/2017

Wage and Supplemental Rate Per Hour: 50% of Journeyperson's rate

NO BENEFITS PAID DURING THE FIRST TWO MONTHS (PROBATIONARY PERIOD)

**Polishers & Finishers - Second 750 Hours**

Effective Period: 7/1/2016 - 6/30/2017

Wage and Supplemental Rate Per Hour: 60% of Journeyperson's rate

**Polishers & Finishers - Third 750 Hours**

Effective Period: 7/1/2016 - 6/30/2017

Wage and Supplemental Rate Per Hour: 75% of Journeyperson's rate

**Polishers & Finishers - Fourth 750 Hours**

Effective Period: 7/1/2016 - 6/30/2017

Wage and Supplemental Rate Per Hour: 90% of Journeyperson's rate

(Local #7)

---

---

**MASON TENDER**

(Ratio of Apprentice to Journeyperson: 1 to 1, 1 to 3)

**Mason Tender - First Year**

Effective Period: 7/1/2016 - 6/30/2017

Wage Rate per Hour: \$21.39

Supplemental Benefit Rate per Hour: \$19.10

**Mason Tender - Second Year**

Effective Period: 7/1/2016 - 6/30/2017

Wage Rate per Hour: \$22.54

Supplemental Benefit Rate per Hour: \$19.10

**Mason Tender - Third Year**

Effective Period: 7/1/2016 - 6/30/2017

Wage Rate per Hour: \$24.29

Supplemental Benefit Rate per Hour: \$19.15

OFFICE OF THE COMPTROLLER, CITY OF NEW YORK  
§220 APPRENTICESHIP PREVAILING WAGE SCHEDULE

**Mason Tender - Fourth Year**

Effective Period: 7/1/2016 - 6/30/2017

Wage Rate per Hour: **\$26.95**

Supplemental Benefit Rate per Hour: **\$19.15**

(Local #79)

---

---

**METALLIC LATHER**

(Ratio of Apprentice to Journeyman: 1 to 1, 1 to 3)

**Metallic Lather (First Year)**

Effective Period: 7/1/2016 - 6/30/2017

Wage Rate per Hour: **\$23.01**

Supplemental Benefit Rate per Hour: **\$17.95**

**Metallic Lather (Second Year)**

Effective Period: 7/1/2016 - 6/30/2017

Wage Rate per Hour: **\$28.11**

Supplemental Benefit Rate per Hour: **\$17.95**

**Metallic Lather (Third Year)**

Effective Period: 7/1/2016 - 6/30/2017

Wage Rate per Hour: **\$33.21**

Supplemental Benefit Rate per Hour: **\$17.95**

(Local #46)

---

---

**MILLWRIGHT**

(Ratio of Apprentice to Journeyman: 1 to 1, 1 to 4)

**Millwright (First Year)**

OFFICE OF THE COMPTROLLER, CITY OF NEW YORK  
§220 APPRENTICESHIP PREVAILING WAGE SCHEDULE

Effective Period: 7/1/2016 - 6/30/2017  
Wage Rate per Hour: **\$28.33**  
Supplemental Benefit Rate per Hour: **\$34.28**

**Millwright (Second Year)**

Effective Period: 7/1/2016 - 6/30/2017  
Wage Rate per Hour: **\$33.48**  
Supplemental Benefit Rate per Hour: **\$37.88**

**Millwright (Third Year)**

Effective Period: 7/1/2016 - 6/30/2017  
Wage Rate per Hour: **\$38.63**  
Supplemental Benefit Rate per Hour: **\$42.13**

**Millwright (Fourth Year)**

Effective Period: 7/1/2016 - 6/30/2017  
Wage Rate per Hour: **\$48.93**  
Supplemental Benefit Rate per Hour: **\$48.69**

(Local #740)

---

---

**PAVER AND ROADBUILDER**  
(Ratio of Apprentice to Journeyman: 1 to 1, 1 to 3)

**Paver and Roadbuilder - First Year (Minimum 1000 hours)**

Effective Period: 7/1/2016 - 6/30/2017  
Wage Rate per Hour: **\$27.55**  
Supplemental Benefit Rate per Hour: **\$18.20**

**Paver and Roadbuilder - Second Year (Minimum 1000 hours)**

Effective Period: 7/1/2016 - 6/30/2017  
Wage Rate per Hour: **\$29.19**  
Supplemental Benefit Rate per Hour: **\$18.20**

(Local #1010)

---

## **PAINTER**

**(Ratio of Apprentice to Journeyman: 1 to 1, 1 to 3)**

### **Painter - Brush & Roller - First Year**

Effective Period: 7/1/2016 - 4/30/2017

Wage Rate per Hour: **\$17.00**

Supplemental Benefit Rate per Hour: **\$12.38**

Effective Period: 5/1/2017 - 6/30/2017

Wage Rate per Hour: **\$17.64**

Supplemental Benefit Rate per Hour: **\$12.78**

### **Painter - Brush & Roller - Second Year**

Effective Period: 7/1/2016 - 4/30/2017

Wage Rate per Hour: **\$21.25**

Supplemental Benefit Rate per Hour: **\$16.23**

Effective Period: 5/1/2017 - 6/30/2017

Wage Rate per Hour: **\$22.05**

Supplemental Benefit Rate per Hour: **\$16.63**

### **Painter - Brush & Roller - Third Year**

Effective Period: 7/1/2016 - 4/30/2017

Wage Rate per Hour: **\$25.50**

Supplemental Benefit Rate per Hour: **\$19.14**

Effective Period: 5/1/2017 - 6/30/2017

Wage Rate per Hour: **\$26.46**

Supplemental Benefit Rate per Hour: **\$19.54**

### **Painter - Brush & Roller - Fourth Year**

Effective Period: 7/1/2016 - 4/30/2017

Wage Rate per Hour: **\$34.00**

Supplemental Benefit Rate per Hour: **\$24.52**

Effective Period: 5/1/2017 - 6/30/2017

Wage Rate per Hour: **\$35.28**

Supplemental Benefit Rate per Hour: **\$24.92**

(District Council of Painters)

OFFICE OF THE COMPTROLLER, CITY OF NEW YORK  
§220 APPRENTICESHIP PREVAILING WAGE SCHEDULE

---

---

**PAINTER - METAL POLISHER**

(Ratio of Apprentice to Journeyman: 1 to 1, 1 to 3)

**Metal Polisher (First Year)**

Effective Period: 7/1/2016 - 6/30/2017

Wage Rate per Hour: \$11.75

Supplemental Benefit Rate per Hour: \$5.13

**Metal Polisher (Second Year)**

Effective Period: 7/1/2016 - 6/30/2017

Wage Rate per Hour: \$13.00

Supplemental Benefit Rate per Hour: \$5.13

**Metal Polisher (Third Year)**

Effective Period: 7/1/2016 - 6/30/2017

Wage Rate per Hour: \$15.75

Supplemental Benefit Rate per Hour: \$5.13

(Local 8A-28)

---

---

**PAINTER - STRUCTURAL STEEL**

(Ratio of Apprentice to Journeyman: 1 to 1, 1 to 3)

**Painters - Structural Steel (First Year)**

Effective Period: 7/1/2016 - 6/30/2017

Wage and Supplemental Rate Per Hour: 40% of Journeyman's rate

**Painters - Structural Steel (Second Year)**

Effective Period: 7/1/2016 - 6/30/2017

Wage and Supplemental Rate Per Hour: 60% of Journeyman's rate

**Painters - Structural Steel (Third Year)**

OFFICE OF THE COMPTROLLER, CITY OF NEW YORK  
§220 APPRENTICESHIP PREVAILING WAGE SCHEDULE

Effective Period: 7/1/2016 - 6/30/2017  
Wage and Supplemental Rate Per Hour: 80% of Journeyperson's rate

(Local #806)

---

---

**PLASTERER**  
(Ratio of Apprentice to Journeyperson: 1 to 1, 1 to 3)

**Plasterer - First Year: 1st Six Months**

Effective Period: 7/1/2016 - 6/30/2017  
Wage Rate Per Hour: 40% of Journeyperson's rate  
Supplemental Rate Per Hour: \$15.91

**Plasterer - First Year: 2nd Six Months**

Effective Period: 7/1/2016 - 6/30/2017  
Wage Rate Per Hour: 45% of Journeyperson's rate  
Supplemental Rate Per Hour: \$16.39

**Plasterer - Second Year: 1st Six Months**

Effective Period: 7/1/2016 - 6/30/2017  
Wage Rate Per Hour: 55% of Journeyperson's rate  
Supplemental Rate Per Hour: \$18.36

**Plasterer - Second Year: 2nd Six Months**

Effective Period: 7/1/2016 - 6/30/2017  
Wage Rate Per Hour: 60% of Journeyperson's rate  
Supplemental Rate Per Hour: \$19.44

**Plasterer - Third Year: 1st Six Months**

Effective Period: 7/1/2016 - 6/30/2017  
Wage Rate Per Hour: 70% of Journeyperson's rate  
Supplemental Rate Per Hour: \$21.61

**Plasterer - Third Year: 2nd Six Months**

Effective Period: 7/1/2016 - 6/30/2017  
Wage Rate Per Hour: 75% of Journeyperson's rate  
Supplemental Rate Per Hour: \$22.69

OFFICE OF THE COMPTROLLER, CITY OF NEW YORK  
§220 APPRENTICESHIP PREVAILING WAGE SCHEDULE

(Local #530)

---

---

**PLASTERER - TENDER**

(Ratio of Apprentice to Journeyman: 1 to 1, 1 to 3)

**Plasterer Tender - First Year**

Effective Period: 7/1/2016 - 6/30/2017

Wage Rate per Hour: \$21.39

Supplemental Benefit Rate per Hour: \$19.10

**Plasterer Tender - Second Year**

Effective Period: 7/1/2016 - 6/30/2017

Wage Rate per Hour: \$22.54

Supplemental Benefit Rate per Hour: \$19.10

**Plasterer Tender - Third Year**

Effective Period: 7/1/2016 - 6/30/2017

Wage Rate per Hour: \$24.29

Supplemental Benefit Rate per Hour: \$19.15

**Plasterer Tender - Fourth Year**

Effective Period: 7/1/2016 - 6/30/2017

Wage Rate per Hour: \$26.95

Supplemental Benefit Rate per Hour: \$19.15

(Local #79)

---

---

**PLUMBER**

(Ratio of Apprentice to Journeyman: 1 to 1, 1 to 3)

**Plumber - First Year: 1st Six Months**

Effective Period: 7/1/2016 - 6/30/2017

OFFICE OF THE COMPTROLLER, CITY OF NEW YORK  
\$220 APPRENTICESHIP PREVAILING WAGE SCHEDULE

Wage Rate per Hour: \$14.00  
Supplemental Benefit Rate per Hour: \$0.71

**Plumber - First Year: 2nd Six Months**

Effective Period: 7/1/2016 - 6/30/2017  
Wage Rate per Hour: \$14.00  
Supplemental Benefit Rate per Hour: \$2.96

**Plumber - Second Year**

Effective Period: 7/1/2016 - 6/30/2017  
Wage Rate per Hour: \$24.07  
Supplemental Benefit Rate per Hour: \$13.21

**Plumber - Third Year**

Effective Period: 7/1/2016 - 6/30/2017  
Wage Rate per Hour: \$26.17  
Supplemental Benefit Rate per Hour: \$13.21

**Plumber - Fourth Year**

Effective Period: 7/1/2016 - 6/30/2017  
Wage Rate per Hour: \$29.02  
Supplemental Benefit Rate per Hour: \$13.21

**Plumber - Fifth Year: 1st Six Months**

Effective Period: 7/1/2016 - 6/30/2017  
Wage Rate per Hour: \$30.42  
Supplemental Benefit Rate per Hour: \$13.21

**Plumber - Fifth Year: 2nd Six Months**

Effective Period: 7/1/2016 - 6/30/2017  
Wage Rate per Hour: \$42.49  
Supplemental Benefit Rate per Hour: \$13.21

(Plumbers Local #1)

---

---



OFFICE OF THE COMPTROLLER, CITY OF NEW YORK  
\$220 APPRENTICESHIP PREVAILING WAGE SCHEDULE

**POINTER, WATERPROOFER, CAULKER, SANDBLASTER,  
STEAMBLASTER**

(Exterior Building Renovation)

(Ratio of Apprentice to Journeyman: 1 to 1, 1 to 4)

**Pointer, Waterproofer, Caulker, Sandblaster, Steamblaster - First Year**

Effective Period: 7/1/2016 - 6/30/2017

Wage Rate per Hour: \$26.52

Supplemental Benefit Rate per Hour: \$12.10

**Pointer, Waterproofer, Caulker, Sandblaster, Steamblaster - Second Year**

Effective Period: 7/1/2016 - 6/30/2017

Wage Rate per Hour: \$27.89

Supplemental Benefit Rate per Hour: \$16.75

**Pointer, Waterproofer, Caulker, Sandblaster, Steamblaster - Third Year**

Effective Period: 7/1/2016 - 6/30/2017

Wage Rate per Hour: \$33.98

Supplemental Benefit Rate per Hour: \$19.50

**Pointer, Waterproofer, Caulker, Sandblaster, Steamblaster - Fourth Year**

Effective Period: 7/1/2016 - 6/30/2017

Wage Rate per Hour: \$40.80

Supplemental Benefit Rate per Hour: \$20.35

(Bricklayer District Council)

---

---

**ROOFER**

(Ratio of Apprentice to Journeyman: 1 to 1, 1 to 2)

**Roofer - First Year**

Effective Period: 7/1/2016 - 6/30/2017

Wage and Supplemental Rate Per Hour: 35% of Journeyman's Rate

**Roofer - Second Year**

OFFICE OF THE COMPTROLLER, CITY OF NEW YORK  
§220 APPRENTICESHIP PREVAILING WAGE SCHEDULE

Effective Period: 7/1/2016 - 6/30/2017

Wage and Supplemental Rate Per Hour: 50% of Journeyperson's Rate

**Roofer - Third Year**

Effective Period: 7/1/2016 - 6/30/2017

Wage and Supplemental Rate Per Hour: 60% of Journeyperson's Rate

**Roofer - Fourth Year**

Effective Period: 7/1/2016 - 6/30/2017

Wage and Supplemental Rate Per Hour: 75% of Journeyperson's Rate

(Local #8)

---

---

**SHEET METAL WORKER**

(Ratio of Apprentice to Journeyperson: 1 to 1, 1 to 3)

**Sheet Metal Worker (0-6 Months)**

Effective Period: 7/1/2016 - 6/30/2017

Wage Rate Per Hour: 25% of Journeyperson's rate

Supplemental Rate Per Hour: \$6.35

**Sheet Metal Worker (7-18 Months)**

Effective Period: 7/1/2016 - 6/30/2017

Wage Rate Per Hour: 35% of Journeyperson's rate

Supplemental Rate Per Hour: \$17.12

**Sheet Metal Worker (19-30 Months)**

Effective Period: 7/1/2016 - 6/30/2017

Wage Rate Per Hour: 45% of Journeyperson's rate

Supplemental Rate Per Hour: \$23.54

**Sheet Metal Worker (31-36 Months)**

Effective Period: 7/1/2016 - 6/30/2017

Wage Rate Per Hour: 55% of Journeyperson's rate

Supplemental Rate Per Hour: \$27.70

**Sheet Metal Worker (37-42 Months)**

Effective Period: 7/1/2016 - 6/30/2017

OFFICE OF THE COMPTROLLER, CITY OF NEW YORK  
§220 APPRENTICESHIP PREVAILING WAGE SCHEDULE

Wage Rate Per Hour: 60% of Journeyman's rate  
Supplemental Rate Per Hour: \$29.11

**Sheet Metal Worker (43-48 Months)**

Effective Period: 7/1/2016 - 6/30/2017  
Wage Rate Per Hour: 70% of Journeyman's rate  
Supplemental Rate Per Hour: \$33.96

**Sheet Metal Worker (49-54 Months)**

Effective Period: 7/1/2016 - 6/30/2017  
Wage Rate Per Hour: 75% of Journeyman's rate  
Supplemental Rate Per Hour: \$36.07

**Sheet Metal Worker (55-60 Months)**

Effective Period: 7/1/2016 - 6/30/2017  
Wage Rate Per Hour: 80% of Journeyman's rate  
Supplemental Rate Per Hour: \$38.15

(Local #28)

---

---

**SIGN ERECTOR**

(Ratio of Apprentice to Journeyman: 1 to 1, 1 to 4)

**Sign Erector - First Year: 1st Six Months**

Effective Period: 7/1/2016 - 6/30/2017  
Wage Rate Per Hour: 35% of Journeyman's rate  
Supplemental Rate Per Hour: \$13.95

**Sign Erector - First Year: 2nd Six Months**

Effective Period: 7/1/2016 - 6/30/2017  
Wage Rate Per Hour: 40% of Journeyman's rate  
Supplemental Rate Per Hour: \$15.83

**Sign Erector - Second Year: 1st Six Months**

Effective Period: 7/1/2016 - 6/30/2017  
Wage Rate Per Hour: 45% of Journeyman's rate  
Supplemental Rate Per Hour: \$17.72

**Sign Erector - Second Year: 2nd Six Months**

OFFICE OF THE COMPTROLLER, CITY OF NEW YORK  
§220 APPRENTICESHIP PREVAILING WAGE SCHEDULE

Effective Period: 7/1/2016 - 6/30/2017  
Wage Rate Per Hour: 50% of Journeyperson's rate  
Supplemental Rate Per Hour: \$19.60

**Sign Erector - Third Year: 1st Six Months**

Effective Period: 7/1/2016 - 6/30/2017  
Wage Rate Per Hour: 55% of Journeyperson's rate  
Supplemental Rate Per Hour: \$26.23

**Sign Erector - Third Year: 2nd Six Months**

Effective Period: 7/1/2016 - 6/30/2017  
Wage Rate Per Hour: 60% of Journeyperson's rate  
Supplemental Rate Per Hour: \$28.24

**Sign Erector - Fourth Year: 1st Six Months**

Effective Period: 7/1/2016 - 6/30/2017  
Wage Rate Per Hour: 65% of Journeyperson's rate  
Supplemental Rate Per Hour: \$30.98

**Sign Erector - Fourth Year: 2nd Six Months**

Effective Period: 7/1/2016 - 6/30/2017  
Wage Rate Per Hour: 70% of Journeyperson's rate  
Supplemental Rate Per Hour: \$33.06

**Sign Erector - Fifth Year**

Effective Period: 7/1/2016 - 6/30/2017  
Wage Rate Per Hour: 75% of Journeyperson's rate  
Supplemental Rate Per Hour: \$35.15

**Sign Erector - Sixth Year**

Effective Period: 7/1/2016 - 6/30/2017  
Wage Rate Per Hour: 80% of Journeyperson's rate  
Supplemental Rate Per Hour: \$37.22

(Local #137)

---

---

**STEAMFITTER**

(Ratio of Apprentice to Journeyperson: 1 to 1, 1 to 3)

OFFICE OF THE COMPTROLLER, CITY OF NEW YORK  
§220 APPRENTICESHIP PREVAILING WAGE SCHEDULE

**Steamfitter - First Year**

Effective Period: 7/1/2016 - 6/30/2017

Wage Rate and Supplemental Per Hour: 40% of Journeyperson's rate

**Steamfitter - Second Year**

Effective Period: 7/1/2016 - 6/30/2017

Wage Rate and Supplemental Rate Per Hour: 50% of Journeyperson's rate.

**Steamfitter - Third Year**

Effective Period: 7/1/2016 - 6/30/2017

Wage Rate and Supplemental Rate per Hour: 65% of Journeyperson's rate.

**Steamfitter - Fourth Year**

Effective Period: 7/1/2016 - 6/30/2017

Wage Rate and Supplemental Rate Per Hour: 80% of Journeyperson's rate.

**Steamfitter - Fifth Year**

Effective Period: 7/1/2016 - 6/30/2017

Wage Rate and Supplemental Rate Per Hour: 85% of Journeyperson's rate.

(Local #638)

---

---

**STONE MASON - SETTER**

(Ratio Apprentice of Journeyperson: 1 to 1, 1 to 2)

**Stone Mason - Setters - First 750 Hours**

Effective Period: 7/1/2016 - 6/30/2017

Wage and Supplemental Rate Per Hour: 50% of Journeyperson's rate

**Stone Mason - Setters - Second 750 Hours**

Effective Period: 7/1/2016 - 6/30/2017

Wage Rate Per Hour: 60% of Journeyperson's rate

Supplemental Rate Per Hour: 50% of Journeyperson's rate

**Stone Mason - Setters - Third 750 Hours**

OFFICE OF THE COMPTROLLER, CITY OF NEW YORK  
§220 APPRENTICESHIP PREVAILING WAGE SCHEDULE

Effective Period: 7/1/2016 - 6/30/2017  
Wage Rate Per Hour: 70% of Journeyperson's rate  
Supplemental Rate Per Hour: 50% of Journeyperson's rate

**Stone Mason - Setters - Fourth 750 Hours**

Effective Period: 7/1/2016 - 6/30/2017  
Wage Rate Per Hour: 80% of Journeyperson's rate  
Supplemental Rate Per Hour: 50% of Journeyperson's rate

**Stone Mason - Setters - Fifth 750 Hours**

Effective Period: 7/1/2016 - 6/30/2017  
Wage Rate Per Hour: 90% of Journeyperson's rate  
Supplemental Rate Per Hour: 50% of Journeyperson's rate

**Stone Mason - Setters - Sixth 750 Hours**

Effective Period: 7/1/2016 - 6/30/2017  
Wage Rate Per Hour: 100% of Journeyperson's rate  
Supplemental Rate Per Hour: 50% of Journeyperson's rate

(Bricklayers District Council)

---

---

**TAPER**  
**(Ratio of Apprentice to Journeyperson: 1 to 1, 1 to 4)**

**Drywall Taper - First Year**

Effective Period: 7/1/2016 - 6/30/2017  
Wage and Supplemental Rate Per Hour: 40% of Journeyperson's rate

**Drywall Taper - Second Year**

Effective Period: 7/1/2016 - 6/30/2017  
Wage and Supplemental Rate Per Hour: 60% of Journeyperson's rate

**Drywall Taper - Third Year**

Effective Period: 7/1/2016 - 6/30/2017  
Wage and Supplemental Rate Per Hour: 80% of Journeyperson's rate

(Local #1974)

---

OFFICE OF THE COMPTROLLER, CITY OF NEW YORK  
§220 APPRENTICESHIP PREVAILING WAGE SCHEDULE

---

**TILE LAYER - SETTER**

(Ratio of Apprentice to Journeyman: 1 to 1, 1 to 4)

**Tile Layer - Setter - First 750 Hours**

Effective Period: 7/1/2016 - 6/30/2017

Wage and Supplemental Rate Per Hour: 50% of Journeyman's rate

**Tile Layer - Setter - Second 750 Hours**

Effective Period: 7/1/2016 - 6/30/2017

Wage and Supplemental Rate Per Hour: 55% of Journeyman's rate

**Tile Layer - Setter - Third 750 Hours**

Effective Period: 7/1/2016 - 6/30/2017

Wage and Supplemental Rate Per Hour: 65% of Journeyman's rate

**Tile Layer - Setter - Fourth 750 Hours**

Effective Period: 7/1/2016 - 6/30/2017

Wage and Supplemental Rate Per Hour: 75% of Journeyman's rate

**Tile Layer - Setter - Fifth 750 Hours**

Effective Period: 7/1/2016 - 6/30/2017

Wage and Supplemental Rate Per Hour: 85% of Journeyman's rate

**Tile Layer - Setter - Sixth 750 Hours**

Effective Period: 7/1/2016 - 6/30/2017

Wage and Supplemental Rate Per Hour: 95% of Journeyman's rate

(Local #7)

---

---

**TIMBERPERSON**

(Ratio of Apprentice to Journeyman: 1 to 1, 1 to 6)

**Timberperson - First Year**

OFFICE OF THE COMPTROLLER, CITY OF NEW YORK  
§220 APPRENTICESHIP PREVAILING WAGE SCHEDULE

Effective Period: 7/1/2016 - 6/30/2017  
Wage Rate Per Hour: 40% of Journeyperson's rate  
Supplemental Rate Per Hour: \$32.33

**Timberperson - Second Year**

Effective Period: 7/1/2016 - 6/30/2017  
Wage Rate Per Hour: 50% of Journeyperson's rate  
Supplemental Rate Per Hour: \$32.33

**Timberperson - Third Year**

Effective Period: 7/1/2016 - 6/30/2017  
Wage Rate Per Hour: 65% of Journeyperson's rate  
Supplemental Rate Per Hour: \$32.33

**Timberperson - Fourth Year**

Effective Period: 7/1/2016 - 6/30/2017  
Wage Rate Per Hour: 80% of Journeyperson's rate  
Supplemental Rate Per Hour: \$32.33

(Local #1536)



OFFICE OF THE COMPTROLLER, CITY OF NEW YORK  
§230 PREVAILING WAGE SCHEDULE

LABOR LAW §230 AND NYC ADMINISTRATIVE CODE §6-130  
BUILDING SERVICE EMPLOYEES

---

PREVAILING WAGE FOR BUILDING SERVICE EMPLOYEES ON NYC CONTRACTS PURSUANT  
TO LABOR LAW §230 ET SEQ.

Building service employees on public contracts must receive not less than the prevailing rate of wage and supplements for the classification of work performed. In accordance with Labor Law §230 et seq. the Comptroller of the City of New York has promulgated this schedule of prevailing wages and supplemental benefits for building service employees engaged on New York City public building service contracts in excess of \$1,500.00. Prevailing rates are required to be annexed to and form part of the contract pursuant to §231 (4).

This schedule is a compilation of separate determinations of the prevailing rate of wage and supplements made by the Comptroller for each trade classification listed herein pursuant to New York State Labor Law section 234 (1). The source of the wage and supplement rates, whether a collective bargaining agreement, survey data or other, is listed at the end of each classification.

Agency Chief Contracting Officers should contact the Bureau of Labor Law's Classification Unit with any questions concerning trade classifications, prevailing rates or prevailing practices with respect to procurement on New York City building services contracts. Contractors are advised to review the Comptroller's Prevailing Wage Schedule before bidding on building services contracts. Contractors with questions concerning trade classifications, prevailing rates or prevailing practices with respect to building services contracts in the procurement stage must contact the contracting agency responsible for the procurement.

Any error as to compensation under the prevailing wage law or other information as to trade classification, made by the contracting agency in the contract documents or in any other communication, will not preclude a finding against the contractor of prevailing wage violation.

Any questions concerning trade classifications, prevailing rates or prevailing practices on New York City building services contracts that have already been awarded may be directed to the Bureau of Labor Law's Classification Unit by calling (212) 669-7974. All callers must have the agency name and contract registration number available when calling with questions on building services contracts. Please direct all other compliance issues to: Bureau of Labor Law, Attn: Wasyi Kinach, P.E., Office of the Comptroller, 1 Centre Street, Room 1122, New York, N.Y. 10007; Fax (212) 669-4002.

---

PREVAILING WAGE FOR BUILDING SERVICE EMPLOYEES IN BUILDINGS WITH TAX  
ABATEMENTS PURSUANT TO REAL PROPERTY TAX LAW §421-A

Covered Landlords shall ensure that all building service employees performing work in buildings with 50 or more dwelling units for which construction was commenced after December 27, 2007 but no later than December 31, 2015, that receive a tax abatement pursuant to Real Property Tax Law §421-a, are paid no less than the prevailing wage listed in the Labor Law §230 Prevailing Wage Schedule, unless the New York City Department of Housing Preservation and Development certifies that, at initial occupancy, at least 50 percent of the dwelling units are affordable to individuals or families with a gross household income at or below 125 percent of the area median income and that any such units which are

OFFICE OF THE COMPTROLLER, CITY OF NEW YORK  
§230 PREVAILING WAGE SCHEDULE

located in rental buildings will be subject to restrictions to insure that they will remain affordable for the entire period during which they receive benefits under Real Property Tax Law §421-a.

---

**PREVAILING WAGE FOR BUILDING SERVICE EMPLOYEES IN NEW YORK CITY LEASED OR FINANCIALLY ASSISTED FACILITIES PURSUANT TO NYC ADMINISTRATIVE CODE § 6-130**

Covered landlords & covered financial assistance recipients shall ensure that all building service employees performing building service work at the premises to which a lease or financial assistance pertains are paid no less than the prevailing wage listed in the Labor Law §230 Prevailing Wage Schedule.

**Covered Landlords include:**

Businesses (other than not-for-profit organizations) leasing to New York City agencies commercial office space or commercial office facilities of 10,000 square feet or more where the City leases or rents no less than 51% of the total square footage of the building to which the lease applies (no less than 80% in Staten Island or in an area not defined as an exclusion area pursuant to section 421-a of the real property tax law on the date of enactment of the local law).

**Covered Financial Assistance Recipients include:**

Businesses (other than not-for-profit organizations) with annual gross revenues of five million dollars or more who have received financial assistance from the City of New York (as defined in New York City Administrative Code §6-130) with a total value of one million dollars or more.

Exemptions: Business Improvement Districts and employers with manufacturing operations at the premises to which the financial assistance pertains.

The information is intended to assist you in meeting your prevailing wage obligation. You should consult New York City Administrative Code §6-130 to determine whether you are covered by this prevailing wage law. New York City Administrative Code § 6-130 requires the City to maintain an updated list of covered landlords and financial assistance recipients who are subject to the prevailing wage requirement.

---

Labor Law § 231 (6) and NYC Administrative Law §6-130 requires contractors to post on the site of the work a current copy of this schedule of wages and supplements.

This schedule is applicable to work performed during the effective period, unless otherwise noted. Changes to this schedule are published on our web site [www.comptroller.nyc.gov](http://www.comptroller.nyc.gov). Contractors must pay the wages and supplements in effect when the building service employee performs the work. Preliminary schedules for future one-year periods appear in the City Record on or about June 1 each succeeding year. Final schedules appear on or about July 1 in the City Record and on our web site [www.comptroller.nyc.gov](http://www.comptroller.nyc.gov).

Contractors are solely responsible for maintaining original payroll records delineating, among other things, the hours worked by each employee within a given classification.

OFFICE OF THE COMPTROLLER, CITY OF NEW YORK  
§230 PREVAILING WAGE SCHEDULE

Some of the rates in this schedule are based on collective bargaining agreements. The Comptroller's Office has attempted to include all overtime, shift and night differential, Holiday, Saturday, Sunday or other premium time work. However, this schedule does not set forth every prevailing practice with respect to such rates with which employers must comply. All such practices are nevertheless part of the employer's prevailing wage obligation and contained in the collective bargaining agreements of the prevailing wage unions. These collective bargaining agreements are available for inspection by appointment. Requests for appointments may be made by calling (212) 669-4443, Monday through Friday between the hours of 9 a.m. and 5 p.m.

In order to meet their obligation to provide prevailing supplemental benefits to each covered employee, employers must either:

- 1) Provide bona-fide benefits which cost the employer no less than the prevailing supplemental benefits rate; or
- 2) Supplement the employee's hourly wage by an amount no less than the prevailing supplemental benefits rate; or
- 3) Provide a combination of bona-fide benefits and wage supplements which cost the employer no less than the prevailing supplemental benefits rate in total.

Particular attention should be given to the supplemental benefits requirement. Although in most instances the payment or provision for supplemental benefits is for each hour worked, some classifications require the payment or provision of supplemental benefits for each hour paid. Consequently, some prevailing practices require benefits to be purchased at the overtime, shift differential, Holiday, Saturday, Sunday or other premium time rate.

Benefits are paid for **EACH HOUR WORKED** unless otherwise noted.

OFFICE OF THE COMPTROLLER, CITY OF NEW YORK  
§230 PREVAILING WAGE SCHEDULE



The City of New York  
Office of the Comptroller  
Bureau Of Labor Law  
1 Centre Street  
New York, NY 10007

**Scott M. Stringer**  
Comptroller

If you are a Covered Building Service Employee and you have been paid less than the Prevailing Wage and Benefits, please contact us at 212-669-4443 or download our complaint form from our website at [WWW.COMPTROLLER.NYC.GOV](http://WWW.COMPTROLLER.NYC.GOV) (click on the Bureau of Labor Law).

Si es un empleado de servicios a edificios elegible y recibió menos del sueldo prevalente y beneficios, por favor contáctenos en 212-669-4443 o descarga un formulario de reclamo del sitio del Internet [WWW.COMPTROLLER.NYC.GOV](http://WWW.COMPTROLLER.NYC.GOV) (oprime "Oficina de Derecho Laboral").

Wasył Kinach, P.E.  
Director of Classifications  
Bureau of Labor Law

OFFICE OF THE COMPTROLLER, CITY OF NEW YORK  
§230 PREVAILING WAGE SCHEDULE

**TABLE OF CONTENTS**

<b><u>CLASSIFICATION</u></b>	<b><u>PAGE</u></b>
BUILDING CLEANER AND MAINTAINER (OFFICE) .....	6
BUILDING CLEANER AND MAINTAINER (RESIDENTIAL) .....	9
BUILDING HVAC SERVICES OPERATOR .....	11
CLEANER (PARKING GARAGE) .....	13
FUEL OIL .....	13
LANDSCAPING AND GROUNDSKEEPING WORKER.....	15
LOCKSMITH .....	15
MAINTENANCE WORKER, MACHINERY .....	15
MEDICAL WASTE REMOVAL .....	16
MOVER - OFFICE FURNITURE AND EQUIPMENT .....	17
REFUSE REMOVER.....	18
SECURITY GUARD (ARMED).....	18
SECURITY GUARD (UNARMED) .....	19
WINDOW CLEANER .....	21

OFFICE OF THE COMPTROLLER, CITY OF NEW YORK  
§230 PREVAILING WAGE SCHEDULE

## **BUILDING CLEANER AND MAINTAINER (OFFICE)**

### **Office Building Class "A" Handyperson (Over 280,000 square feet gross area)**

Effective Period: 7/1/2016 - 12/31/2016

Wage Rate per Hour: **\$26.95**

Supplemental Benefit Rate per Hour: **\$10.98**

Supplemental Note: for new hire 0-3 months of employment - \$0.00

Effective Period: 1/1/2017 - 6/30/2017

Wage Rate per Hour: **\$27.60**

Supplemental Benefit Rate per Hour: **\$11.56**

Supplemental Note: for new hire 0-3 months of employment - \$0.00

### **Office Building Class "A" Foreperson, Starter (Over 280,000 square feet gross area)**

Effective Period: 7/1/2016 - 12/31/2016

Wage Rate per Hour: **\$26.84**

Supplemental Benefit Rate per Hour: **\$10.98**

Supplemental Note: for new hire 0-3 months of employment - \$0.00

Effective Period: 1/1/2017 - 6/30/2017

Wage Rate per Hour: **\$27.49**

Supplemental Benefit Rate per Hour: **\$11.56**

Supplemental Note: for new hire 0-3 months of employment - \$0.00

### **Office Building Class "A" Cleaner/Porter, Elevator Operator, Exterminator, Fire Safety Director (Over 280,000 square feet gross area)**

Effective Period: 7/1/2016 - 12/31/2016

Wage Rate per Hour: **\$24.62**

Supplemental Benefit Rate per Hour: **\$10.98**

Supplemental Note: for new hire 0-3 months of employment - \$0.00; for new hire 4-12 months of employment - \$8.09; for new hire 13-24 months of employment - \$10.65

**NEW HIRE:** Cleaner/Porter, Elevator Operator, Exterminator, Fire Safety Director may be paid 75% of the wage rate above for the first 21 months of employment, 85% of the wage rate above for the 22nd through 42nd months of employment, and upon the completion of 42 months of employment employee shall be paid the full wage rate.

Effective Period: 1/1/2017 - 6/30/2017

Wage Rate per Hour: **\$25.22**

Supplemental Benefit Rate per Hour: **\$11.56**

Supplemental Note: for new hire 0-3 months of employment - \$0.00; for new hire 4-12 months of employment - \$8.57; for new hire 13-24 months of employment - \$11.23

**NEW HIRE:** Cleaner/Porter, Elevator Operator, Exterminator, Fire Safety Director may be paid 75% of the wage rate above for the first 21 months of employment, 85% of the wage rate above for the 22nd through 42nd months of employment, and upon the completion of 42 months of employment employee shall be paid the full wage rate.

OFFICE OF THE COMPTROLLER, CITY OF NEW YORK  
§230 PREVAILING WAGE SCHEDULE

**Office Building Class "B" Handyperson (Over 120,000 and less than 280,000 square feet gross area)**

Effective Period: 7/1/2016 - 12/31/2016

Wage Rate per Hour: **\$26.92**

Supplemental Benefit Rate per Hour: **\$10.98**

Supplemental Note: for new hire 0-3 months of employment - \$0.00

Effective Period: 1/1/2017 - 6/30/2017

Wage Rate per Hour: **\$27.57**

Supplemental Benefit Rate per Hour: **\$11.56**

Supplemental Note: for new hire 0-3 months of employment - \$0.00

**Office Building Class "B" Foreperson, Starter (Over 120,000 and less than 280,000 square feet gross area)**

Effective Period: 7/1/2016 - 12/31/2016

Wage Rate per Hour: **\$26.80**

Supplemental Benefit Rate per Hour: **\$10.98**

Supplemental Note: for new hire 0-3 months of employment - \$0.00

Effective Period: 1/1/2017 - 6/30/2017

Wage Rate per Hour: **\$27.45**

Supplemental Benefit Rate per Hour: **\$11.56**

Supplemental Note: for new hire 0-3 months of employment - \$0.00

**Office Building Class "B" Cleaner/Porter, Elevator Operator, Exterminator, Fire Safety Director (Over 120,000 and less than 280,000 square feet gross area)**

Effective Period: 7/1/2016 - 12/31/2016

Wage Rate per Hour: **\$24.59**

Supplemental Benefit Rate per Hour: **\$10.98**

Supplemental Note: for new hire 0-3 months of employment - \$0.00; for new hire 4-12 months of employment - \$8.09; for new hire 13-24 months of employment - \$10.65

NEW HIRE: Cleaner/Porter, Elevator Operator, Exterminator, Fire Safety Director may be paid 75% of the wage rate above for the first 21 months of employment, 85% of the wage rate above for the 22nd through 42nd months of employment, and upon the completion of 42 months of employment employee shall be paid the full wage rate.

Effective Period: 1/1/2017 - 6/30/2017

Wage Rate per Hour: **\$25.19**

Supplemental Benefit Rate per Hour: **\$11.56**

Supplemental Note: for new hire 0-3 months of employment - \$0.00; for new hire 4-12 months of employment - \$8.57; for new hire 13-24 months of employment - \$11.23

NEW HIRE: Cleaner/Porter, Elevator Operator, Exterminator, Fire Safety Director may be paid 75% of the wage rate above for the first 21 months of employment, 85% of the wage rate above for the 22nd through 42nd months of employment, and upon the completion of 42 months of employment employee shall be paid the full wage rate.

OFFICE OF THE COMPTROLLER, CITY OF NEW YORK  
§230 PREVAILING WAGE SCHEDULE

**Office Building Class "C" Handyperson (Less than 120,000 square feet gross area)**

Effective Period: 7/1/2016 - 12/31/2016  
Wage Rate per Hour: **\$26.87**  
Supplemental Benefit Rate per Hour: **\$10.98**  
Supplemental Note: for new hire 0-3 months of employment - \$0.00

Effective Period: 1/1/2017 - 6/30/2017  
Wage Rate per Hour: **\$27.52**  
Supplemental Benefit Rate per Hour: **\$11.56**  
Supplemental Note: for new hire 0-3 months of employment - \$0.00

**Office Building Class "C" Foreperson, Starter (Less than 120,000 square feet gross area)**

Effective Period: 7/1/2016 - 12/31/2016  
Wage Rate per Hour: **\$26.76**  
Supplemental Benefit Rate per Hour: **\$10.98**  
Supplemental Note: for new hire 0-3 months of employment - \$0.00

Effective Period: 1/1/2017 - 6/30/2017  
Wage Rate per Hour: **\$27.41**  
Supplemental Benefit Rate per Hour: **\$11.56**  
Supplemental Note: for new hire 0-3 months of employment - \$0.00

**Office Building Class "C" Cleaner/Porter, Elevator Operator, Exterminator, Fire Safety Director (Less than 120,000 square feet gross area)**

Effective Period: 7/1/2016 - 12/31/2016  
Wage Rate per Hour: **\$24.55**  
Supplemental Benefit Rate per Hour: **\$10.98**  
Supplemental Note: for new hire 0-3 months of employment - \$0.00; for new hire 4-12 months of employment - \$8.09; for new hire 13-24 months of employment - \$10.65

NEW HIRE: Cleaner/Porter, Elevator Operator, Exterminator, Fire Safety Director may be paid 75% of the wage rate above for the first 21 months of employment, 85% of the wage rate above for the 22nd through 42nd months of employment, and upon the completion of 42 months of employment employee shall be paid the full wage rate.

Effective Period: 1/1/2017 - 6/30/2017  
Wage Rate per Hour: **\$25.15**  
Supplemental Benefit Rate per Hour: **\$11.56**  
Supplemental Note: for new hire 0-3 months of employment - \$0.00; for new hire 4-12 months of employment - \$8.57; for new hire 13-24 months of employment - \$11.23

NEW HIRE: Cleaner/Porter, Elevator Operator, Exterminator, Fire Safety Director may be paid 75% of the wage rate above for the first 21 months of employment, 85% of the wage rate above for the 22nd through 42nd months of employment, and upon the completion of 42 months of employment employee shall be paid the full wage rate.



OFFICE OF THE COMPTROLLER, CITY OF NEW YORK  
§230 PREVAILING WAGE SCHEDULE

For all BUILDING CLEANER AND MAINTAINER (OFFICE) titles, New Hire shall be defined as an employee who has not worked any hours during the previous six-month period, and Months of Employment shall be defined as an Employee's total length of service with the Employer or at the Facility, whichever is greater.

**Overtime Description**

Supplemental Benefits shall be paid for each hour paid, up to forty (40) paid hours per week.

**Overtime**

- Time and one half the regular rate after an 8 hour day.
- Time and one half the regular rate for Saturday.
- Time and one half the regular rate for Sunday.
- Time and one half the regular rate for work on a holiday plus the day's pay.
- Time and one half the regular hourly rate after 40 hours in any work week.

**Paid Holidays**

- New Year's Day
- President's Day
- Good Friday
- Memorial Day
- Independence Day
- Labor Day
- Columbus Day
- Thanksgiving Day
- Day after Thanksgiving
- Christmas Day

**Vacation**

- Less than 6 months of work.....no vacation
- 6 months of work.....three (3) days
- 1 year of work.....ten (10) days
- 5 years of work.....fifteen (15) days
- 15 years of work.....twenty (20) days
- 21 years of work.....twenty-one (21) days
- 22 years of work.....twenty-two (22) days
- 23 years of work.....twenty-three (23) days
- 24 years of work.....twenty-four (24) days
- 25 years or more of work.....twenty-five (25) days
- Plus two Personal Days per year.

**Sick Leave:**

- 10 sick days per year.
- Unused sick leave paid in the succeeding January, one full day pay for each unused sick day.

(Local #32 B/J)

---

**BUILDING CLEANER AND MAINTAINER (RESIDENTIAL)**

**Residential Building Handyperson**

OFFICE OF THE COMPTROLLER, CITY OF NEW YORK  
§230 PREVAILING WAGE SCHEDULE

Effective Period: 7/1/2016 - 12/31/2016

Wage Rate per Hour: **\$25.43**

Supplemental Benefit Rate per Hour: **\$10.90**

Supplemental Note: for new hire 0-3 months of employment - \$0.00

Effective Period: 1/1/2017 - 4/20/2017

Wage Rate per Hour: **\$25.43**

Supplemental Benefit Rate per Hour: **\$11.48**

Supplemental Note: for new hire 0-3 months of employment - \$0.00

Effective Period: 4/21/2017 - 6/30/2017

Wage Rate per Hour: **\$26.18**

Supplemental Benefit Rate per Hour: **\$11.48**

Supplemental Note: for new hire 0-3 months of employment - \$0.00

**Residential Building Cleaner/Porter, Doorperson, Elevator Operator**

Effective Period: 7/1/2016 - 12/31/2016

Wage Rate per Hour: **\$23.06**

Supplemental Benefit Rate per Hour: **\$10.90**

Supplemental Note: for new hire 0-3 months of employment - \$0.00; for new hire 4-12 months of employment - \$8.09; for new hire 13-24 months of employment - \$10.65

NEW HIRE - Cleaner/Porter, Doorperson, Elevator Operator: 0-21 months may be paid 75% of the hourly wage rate published above, 22-42 months may be paid 85% of the hourly wage rate published above. Upon completion of 42 months of employment, the new hire shall be paid the full wage rate. Upon completion of two years of employment the new hire receives the full supplemental benefit rate.

Effective Period: 1/1/2017 - 4/20/2017

Wage Rate per Hour: **\$23.06**

Supplemental Benefit Rate per Hour: **\$11.48**

Supplemental Note: for new hire 0-3 months of employment - \$0.00; for new hire 4-12 months of employment - \$8.57; for new hire 13-24 months of employment - \$11.23

NEW HIRE - Cleaner/Porter, Doorperson, Elevator Operator: 0-21 months may be paid 75% of the hourly wage rate published above, 22-42 months may be paid 85% of the hourly wage rate published above. Upon completion of 42 months of employment, the new hire shall be paid the full wage rate. Upon completion of two years of employment the new hire receives the full supplemental benefit rate.

Effective Period: 4/21/2017 - 6/30/2017

Wage Rate per Hour: **\$23.75**

Supplemental Benefit Rate per Hour: **\$11.48**

Supplemental Note: for new hire 0-3 months of employment - \$0.00; for new hire 4-12 months of employment - \$8.57; for new hire 13-24 months of employment - \$11.23

NEW HIRE - Cleaner/Porter, Doorperson, Elevator Operator: 0-21 months may be paid 75% of the hourly wage rate published above, 22-42 months may be paid 85% of the hourly wage rate published above. Upon completion of 42 months of employment, the new hire shall be paid the full wage rate. Upon completion of two years of employment the new hire receives the full supplemental benefit rate.

**Overtime Description**

Supplemental Benefits shall be paid for each hour paid, up to forty (40) paid hours per week.

OFFICE OF THE COMPTROLLER, CITY OF NEW YORK  
§230 PREVAILING WAGE SCHEDULE

**Overtime**

Time and one half the regular rate after an 8 hour day.  
Time and one half the regular rate for work on a holiday plus the day's pay.  
Time and one half the regular hourly rate after 40 hours in any work week.

**Paid Holidays**

New Year's Day  
Martin Luther King Jr. Day  
President's Day  
Memorial Day  
Independence Day  
Labor Day  
Columbus Day  
Election Day  
Thanksgiving Day  
Christmas Day

**Vacation**

6 months.....three (3) days  
1 year.....ten (10) days  
5 years.....fifteen (15) days  
15 years.....twenty (20) days  
21 years.....twenty-one (21) days  
22 years.....twenty-two (22) days  
23 years.....twenty-three (23) days  
24 years.....twenty-four (24) days  
25 years.....twenty-five (25) days  
Plus two Personal Days per year.

**SICK LEAVE**

After 1 year of service.....ten (10) days per year

(Local #32 B/J)

---

---

**BUILDING HVAC SERVICES OPERATOR**

**Engineer (Refrigeration)**

Effective Period: 7/1/2016 - 12/31/2016

Wage Rate per Hour: **\$38.96**

Supplemental Benefit Rate per Hour: **\$17.26**

Effective Period: 1/1/2017 - 6/30/2017

Wage Rate per Hour: **\$40.13**

Supplemental Benefit Rate per Hour: **\$17.77**

OFFICE OF THE COMPTROLLER, CITY OF NEW YORK  
§230 PREVAILING WAGE SCHEDULE

NEW HIRE - Engineer (Refrigeration): for the first year may be paid a starting rate of 85% of the hourly wage rate published above.

**Fireperson**

Fireperson (Helper): Assist the Engineer

Effective Period: 7/1/2016 - 12/31/2016

Wage Rate per Hour: **\$30.34**

Supplemental Benefit Rate per Hour: **\$16.86**

Effective Period: 1/1/2017 - 6/30/2017

Wage Rate per Hour: **\$31.25**

Supplemental Benefit Rate per Hour: **\$17.36**

Please note that the NYC Comptroller's Office does not publish rates for the Stationary Engineer title.

**Overtime Description**

All hours worked on a holiday shall be paid at two and one half times the regular wage rate in lieu of the paid day off.

**Overtime**

Time and one half the regular rate after an 8 hour day.

Time and one half the regular rate for Saturday.

Time and one half the regular rate for Sunday.

**Paid Holidays**

New Year's Day

Memorial Day

Independence Day

Labor Day

Thanksgiving Day

Christmas Day

Plus six (6) floating Holidays

**Vacation**

6 months ..... three (3) days

1 year ..... ten (10) days

5 years ..... fifteen (15) days

15 years ..... twenty (20) days

21 years..... twenty-one (21) days

22 years ..... twenty-two (22) days

23 years ..... twenty-three (23) days

24 years ..... twenty-four (24) days

25 years ..... twenty-five (25) days

(Local #94)

---

---

OFFICE OF THE COMPTROLLER, CITY OF NEW YORK  
§230 PREVAILING WAGE SCHEDULE

## **CLEANER (PARKING GARAGE)**

### **Garage Cleaner**

Effective Period: 7/1/2016 - 6/30/2017

Wage Rate per Hour: \$11.23

Supplemental Benefit Rate per Hour: \$1.75

### **Overtime**

Time and one half the regular rate after an 8 hour day.

Time and one half the regular hourly rate after 40 hours in any work week.

(Based on data from NYS Department of Labor Occupational Employment Statistics and US Department of Labor Bureau of Labor Statistics)

---

---

## **FUEL OIL**

### **Fuel Oil, Coal, Fuel Gas, Petroleum Product Chauffeur (5th Year and above)**

Effective Period: 7/1/2016 - 6/30/2017

Wage Rate per Hour: \$32.36

Supplemental Benefit Rate per Hour: \$22.59

### **Fuel Oil, Coal, Fuel Gas, Petroleum Product Chauffeur (4th Year)**

Effective Period: 7/1/2016 - 6/30/2017

Wage Rate per Hour: \$29.75

Supplemental Benefit Rate per Hour: \$22.59

### **Fuel Oil, Coal, Fuel Gas, Petroleum Product Chauffeur (3rd Year)**

Effective Period: 7/1/2016 - 6/30/2017

Wage Rate per Hour: \$27.75

Supplemental Benefit Rate per Hour: \$22.59

### **Fuel Oil, Coal, Fuel Gas, Petroleum Product Chauffeur (2nd Year)**

Effective Period: 7/1/2016 - 6/30/2017

Wage Rate per Hour: \$25.75

Supplemental Benefit Rate per Hour: \$22.59

### **Fuel Oil, Coal, Fuel Gas, Petroleum Product Chauffeur (1st Year)**

Effective Period: 7/1/2016 - 6/30/2017

OFFICE OF THE COMPTROLLER, CITY OF NEW YORK  
§230 PREVAILING WAGE SCHEDULE

Wage Rate per Hour: \$23.75

Supplemental Benefit Rate per Hour: \$22.59

**Overtime**

Time and one half the regular rate after an 8 hour day.

Time and one half the regular rate for Saturday.

Double time the regular rate for Sunday.

**Overtime Holidays**

Double time the regular rate for work on the following holiday(s).

Martin Luther King Jr. Day

Lincoln's Birthday

Washington's Birthday

Memorial Day

Independence Day

Labor Day

Columbus Day

Election Day

Veteran's Day

Triple time the regular rate for work on the following holiday(s).

New Year's Day

Thanksgiving Day

Christmas Day

**Paid Holidays**

New Year's Day

Martin Luther King Jr. Day

Lincoln's Birthday

Washington's Birthday

Memorial Day

Independence Day

Labor Day

Columbus Day

Election Day

Veteran's Day

Thanksgiving Day

Christmas Day

**Vacation**

Less than 75 days worked.....no vacation.

75 days worked, but less than 110 days worked in a calendar year.....five (5) days the following year.

110 days or more worked in a calendar year.....ten (10) days the following year.

**SICK LEAVE:**

1 day sick leave earned for each 40 days worked in the preceding calendar year for a maximum of five (5) days per calendar year.

(Local #553)

OFFICE OF THE COMPTROLLER, CITY OF NEW YORK  
\$230 PREVAILING WAGE SCHEDULE

## LANDSCAPING AND GROUNDSKEEPING WORKER

### Landscaper / Groundskeeper

Effective Period: 7/1/2016 - 6/30/2017

Wage Rate per Hour: \$18.23

Supplemental Benefit Rate per Hour: \$1.75

#### **Overtime**

Time and one half the regular rate after an 8 hour day.

Time and one half the regular hourly rate after 40 hours in any work week.

(Based on data from NYS Department of Labor Occupational Employment Statistics and US Department of Labor Bureau of Labor Statistics)

---

---

## LOCKSMITH

### Locksmith

Effective Period: 7/1/2016 - 6/30/2017

Wage Rate per Hour: \$20.39

Supplemental Benefit Rate per Hour: \$6.12

#### **Overtime**

Time and one half the regular rate after an 8 hour day.

Time and one half the regular hourly rate after 40 hours in any work week.

(Based on data from NYS Department of Labor Occupational Employment Statistics and US Department of Labor Bureau of Labor Statistics)

---

---

## MAINTENANCE WORKER, MACHINERY

### Mechanic

Effective Period: 7/1/2016 - 6/30/2017

Wage Rate per Hour: \$33.00

Supplemental Benefit Rate per Hour: \$6.12

#### **Overtime**

Time and one half the regular rate after an 8 hour day.

OFFICE OF THE COMPTROLLER, CITY OF NEW YORK  
§230 PREVAILING WAGE SCHEDULE

Time and one half the regular hourly rate after 40 hours in any work week.

(Based on data from NYS Department of Labor Occupational Employment Statistics and US Department of Labor Bureau of Labor Statistics)

---

---

## MEDICAL WASTE REMOVAL

### Driver

Effective Period: 7/1/2016 - 6/30/2017

Wage Rate per Hour: \$20.47

Supplemental Benefit Rate per Hour: \$11.32

### Helper

Effective Period: 7/1/2016 - 6/30/2017

Wage Rate per Hour: \$16.72

Supplemental Benefit Rate per Hour: \$11.32

### Tractor Trailer Driver

Effective Period: 7/1/2016 - 6/30/2017

Wage Rate per Hour: \$22.97

Supplemental Benefit Rate per Hour: \$11.32

## Overtime Description

Time and one half the regular hourly rate after an 8 hour day or after 40 hours in any work week. The seventh day of work in a workweek is paid at double time the regular hourly rate. Time and one half the regular hourly rate for work on a holiday plus days pay for below paid holidays.

## Paid Holidays

President's Day  
Memorial Day  
Independence Day  
Labor Day  
Thanksgiving Day  
Christmas Day

## Vacation

1 year of service but less than five years.....ten (10) days  
5 years of service but less than ten years.....fifteen (15) days  
10 years of service.....sixteen (16) days  
11 years.....seventeen (17) days  
12 years.....eighteen (18) days  
13 years.....nineteen (19) days  
14 years.....twenty (20) days



OFFICE OF THE COMPTROLLER, CITY OF NEW YORK  
§230 PREVAILING WAGE SCHEDULE

20 years.....twenty-one (21) days  
21 years.....twenty-two (22) days  
22 years.....twenty-three (23) days  
23 years.....twenty-four (24) days  
24 years.....twenty-five (25) days  
Plus 5 Personal Days

(Local #813)

---

---

## **MOVER - OFFICE FURNITURE AND EQUIPMENT**

### **Heavy and Tractor Trailer Truck Driver**

Tractor-trailer combination or a truck with a capacity of at least 26,000 pounds Gross Vehicle Weight (GVW)

Effective Period: 7/1/2016 - 6/30/2017

Wage Rate per Hour: **\$23.52**

Supplemental Benefit Rate per Hour: **\$5.37**

### **Light Truck Driver**

Effective Period: 7/1/2016 - 6/30/2017

Wage Rate per Hour: **\$18.17**

Supplemental Benefit Rate per Hour: **\$5.37**

### **Laborer and Freight, Stock, and Material Mover, Hand**

Effective Period: 7/1/2016 - 6/30/2017

Wage Rate per Hour: **\$15.52**

Supplemental Benefit Rate per Hour: **\$5.37**

### **Packer and Packager, Hand**

Packs, wraps and labels office furniture and equipment and loads it onto dollies and into elevators.

Effective Period: 7/1/2016 - 6/30/2017

Wage Rate per Hour: **\$11.87**

Supplemental Benefit Rate per Hour: **\$5.37**

### **Overtime**

Time and one half the regular rate after an 8 hour day.

Time and one half the regular hourly rate after 40 hours in any work week.

(Based on data from NYS Department of Labor Occupational Employment Statistics and US Department of Labor Bureau of Labor Statistics)

OFFICE OF THE COMPTROLLER, CITY OF NEW YORK  
§230 PREVAILING WAGE SCHEDULE

---

---

## REFUSE REMOVER

### Refuse Remover

Effective Period: 7/1/2016 - 6/30/2017

Wage Rate per Hour: **\$28.32**

Supplemental Benefit Rate per Hour: **\$5.37**

### Overtime

Time and one half the regular rate after an 8 hour day.

Time and one half the regular hourly rate after 40 hours in any work week.

(Based on data from NYS Department of Labor Occupational Employment Statistics and US Department of Labor Bureau of Labor Statistics)

---

---

## SECURITY GUARD (ARMED)

### Security Guard (Armed)

Effective Period: 7/1/2016 - 12/31/2016

Wage Rate per Hour: **\$28.75**

Supplemental Benefit Rate per Hour: **\$5.48**

Supplemental Note: for new employee 0-30 days of employment - \$4.76; for new employee 31-120 days of employment - \$4.93; for new employee 121 days - 2 years of employment - \$5.04

Effective Period: 1/1/2017 - 6/30/2017

Wage Rate per Hour: **\$29.00**

Supplemental Benefit Rate per Hour: **\$5.66**

Supplemental Note: for new employee 0-30 days of employment - \$4.94; for new employee 31-120 days of employment - \$5.11; for new employee 121 days - 2 years of employment - \$5.22

Months of employment shall be defined as an Employee's length of service with the Employer or at the Facility, whichever is greater.

### Overtime Description

If President's Day is not observed, then the employer may substitute another holiday not listed below. If an employer observes a holiday not listed they may substitute said holiday with one on the list.

A guard is eligible for Paid Holidays after one year of continuous employment.

A guard who works a holiday is paid the regular rate plus receives the paid holiday.

Supplemental Benefits shall be paid for each hour paid, up to forty (40) paid hours per week.

OFFICE OF THE COMPTROLLER, CITY OF NEW YORK  
§230 PREVAILING WAGE SCHEDULE

**Overtime**

Time and one half the regular rate after an 8 hour day.

Time and one half the regular hourly rate after 40 hours in any work week.

**Paid Holidays**

New Year's Day

President's Day

Memorial Day

Independence Day

Labor Day

Thanksgiving Day

Christmas Day

Personal Day

**Vacation**

Months on payroll	Vacation with Pay
6	3 days
12	1 week
24	2 weeks
60	3 weeks
180	4 weeks
300	5 weeks

**Sick Leave**

Employees accrue paid sick leave at the rate of one (1) sick day for every six (6) months worked, up to a maximum of six (6) days a year.

(Local #32B/J)

---

---

**SECURITY GUARD (UNARMED)**

**Security Guard (Unarmed) 0 - 6 months**

Effective Period: 7/1/2016 - 12/31/2016

Wage Rate per Hour: \$14.00

Supplemental Benefit Rate per Hour: \$5.04

Supplemental Note: for new employee 0-30 days of employment - \$4.76; for new employee 31-120 days of employment - \$4.93

Effective Period: 1/1/2017 - 6/30/2017

Wage Rate per Hour: \$14.40

Supplemental Benefit Rate per Hour: \$5.22

Supplemental Note: for new employee 0-30 days of employment - 4.94; for new employee 31-120 days of employment - \$5.11

**Security Guard (Unarmed) 7 - 12 months**

OFFICE OF THE COMPTROLLER, CITY OF NEW YORK  
§230 PREVAILING WAGE SCHEDULE

Effective Period: 7/1/2016 - 12/31/2016  
Wage Rate per Hour: **\$14.30**  
Supplemental Benefit Rate per Hour: **\$5.04**

Effective Period: 1/1/2017 - 6/30/2017  
Wage Rate per Hour: **\$14.40**  
Supplemental Benefit Rate per Hour: **\$5.22**

**Security Guard (Unarmed) 13 - 18 months**

Effective Period: 7/1/2016 - 12/31/2016  
Wage Rate per Hour: **\$14.80**  
Supplemental Benefit Rate per Hour: **\$5.04**

Effective Period: 1/1/2017 - 6/30/2017  
Wage Rate per Hour: **\$15.25**  
Supplemental Benefit Rate per Hour: **\$5.22**

**Security Guard (Unarmed) 19 - 24 months**

Effective Period: 7/1/2016 - 12/31/2016  
Wage Rate per Hour: **\$15.30**  
Supplemental Benefit Rate per Hour: **\$5.04**

Effective Period: 1/1/2017 - 6/30/2017  
Wage Rate per Hour: **\$15.75**  
Supplemental Benefit Rate per Hour: **\$5.22**

**Security Guard (Unarmed) 25 - 30 months**

Effective Period: 7/1/2016 - 12/31/2016  
Wage Rate per Hour: **\$15.80**  
Supplemental Benefit Rate per Hour: **\$5.48**

Effective Period: 1/1/2017 - 6/30/2017  
Wage Rate per Hour: **\$16.25**  
Supplemental Benefit Rate per Hour: **\$5.66**

**Security Guard (Unarmed) 31 months or more**

Effective Period: 7/1/2016 - 12/31/2016  
Wage Rate per Hour: **\$16.45**  
Supplemental Benefit Rate per Hour: **\$5.48**

Effective Period: 1/1/2017 - 6/30/2017  
Wage Rate per Hour: **\$16.90**  
Supplemental Benefit Rate per Hour: **\$5.66**

OFFICE OF THE COMPTROLLER, CITY OF NEW YORK  
§230 PREVAILING WAGE SCHEDULE

Months of employment shall be defined as an Employee's length of service with the Employer or at the Facility, whichever is greater.

### Overtime Description

If President's Day is not observed, then the employer may substitute another holiday not listed below. If an employer observes a holiday not listed they may substitute said holiday with one on the list.

A guard is eligible for Paid Holidays after one year of continuous employment.

A guard who works a holiday is paid the regular rate plus receives the paid holiday.

Supplemental Benefits shall be paid for each hour paid, up to forty (40) paid hours per week.

### Overtime

Time and one half the regular rate after an 8 hour day.

Time and one half the regular hourly rate after 40 hours in any work week.

### Paid Holidays

New Year's Day  
President's Day  
Memorial Day  
Independence Day  
Labor Day  
Thanksgiving Day  
Christmas Day  
Personal Day

### Vacation

Months on payroll	Vacation with Pay
6	3 days
12	1 week
24	2 weeks
60	3 weeks
180	4 weeks
300	5 weeks

### Sick Leave

Employees accrue paid sick leave at the rate of one (1) sick day for every six (6) months worked, up to a maximum of six (6) days a year.

(Local #32B/J)

---

---

## WINDOW CLEANER

### Window Cleaner

Effective Period: 7/1/2016 - 12/31/2016

Wage Rate per Hour: \$28.10

Supplemental Benefit Rate per Hour: \$11.00

Effective Period: 1/1/2017 - 6/30/2017

OFFICE OF THE COMPTROLLER, CITY OF NEW YORK  
\$230 PREVAILING WAGE SCHEDULE

Wage Rate per Hour: **\$28.70**  
Supplemental Benefit Rate per Hour: **\$11.56**

**Power Operated Scaffolds, Manual Scaffolds, and Boatswain Chairs**

Effective Period: 7/1/2016 - 12/31/2016  
Wage Rate per Hour: **\$30.66**  
Supplemental Benefit Rate per Hour: **\$11.00**

Effective Period: 1/1/2017 - 6/30/2017  
Wage Rate per Hour: **\$31.33**  
Supplemental Benefit Rate per Hour: **\$11.56**

**Window Cleaner Apprentice (0 - 3 months)**

Effective Period: 7/1/2016 - 12/31/2016  
Wage Rate per Hour: **\$20.73**  
Supplemental Benefit Rate per Hour: None

Effective Period: 1/1/2017 - 6/30/2017  
Wage Rate per Hour: **\$21.24**  
Supplemental Benefit Rate per Hour: None

**Window Cleaner Apprentice (4 - 7 months)**

Effective Period: 7/1/2016 - 12/31/2016  
Wage Rate per Hour: **\$22.41**  
Supplemental Benefit Rate per Hour: **\$11.00**

Effective Period: 1/1/2017 - 6/30/2017  
Wage Rate per Hour: **\$22.96**  
Supplemental Benefit Rate per Hour: **\$11.56**

**Window Cleaner Apprentice (8 - 11 months)**

Effective Period: 7/1/2016 - 12/31/2016  
Wage Rate per Hour: **\$23.75**  
Supplemental Benefit Rate per Hour: **\$11.00**

Effective Period: 1/1/2017 - 6/30/2017  
Wage Rate per Hour: **\$24.34**  
Supplemental Benefit Rate per Hour: **\$11.56**

**Window Cleaner Apprentice (12 - 15 months)**

Effective Period: 7/1/2016 - 12/31/2016  
Wage Rate per Hour: **\$25.12**  
Supplemental Benefit Rate per Hour: **\$11.00**

OFFICE OF THE COMPTROLLER, CITY OF NEW YORK  
§230 PREVAILING WAGE SCHEDULE

Effective Period: 1/1/2017 - 6/30/2017  
Wage Rate per Hour: \$25.74  
Supplemental Benefit Rate per Hour: \$11.56

**Window Cleaner Apprentice (16 - 17 months)**

Effective Period: 7/1/2016 - 12/31/2016  
Wage Rate per Hour: \$26.47  
Supplemental Benefit Rate per Hour: \$11.00

Effective Period: 1/1/2017 - 6/30/2017  
Wage Rate per Hour: \$27.12  
Supplemental Benefit Rate per Hour: \$11.56

Months of employment shall be defined as an Employee's length of service with the Employer or at the Facility, whichever is greater.

**Overtime**

Time and one half the regular rate after an 8 hour day.  
Time and one half the regular rate for Saturday.  
Double time the regular rate for Sunday.  
Time and one half the regular rate for work on a holiday plus the day's pay.

**Paid Holidays**

New Year's Day  
Martin Luther King Jr. Day  
President's Day  
Good Friday  
Memorial Day  
Independence Day  
Labor Day  
Columbus Day  
Thanksgiving Day  
Day after Thanksgiving  
Christmas Day  
Personal Day

**Vacation**

After 7 months but less than 1 year of service.....five (5) days  
1 year but less than 5 years of service.....ten (10) days  
5 years of service but less than 15 years of service.....fifteen (15) days  
15 years of service but less than 21 years of service.....twenty (20) days  
21 years.....twenty-one (21) days  
22 years.....twenty-two (22) days  
23 years.....twenty-three (23) days  
24 years.....twenty-four (24) days  
25 years or more of service.....twenty-five (25) days  
Plus 1 day per year for medical visit

**SICK LEAVE:**

10 days after one year worked. Unused sick days to be paid in cash.

(Local #32 B/J)

(NO TEXT ON THIS PAGE)





Leonard A. Mancusi  
SENIOR ASSISTANT COMPTROLLER

THE CITY OF NEW YORK  
OFFICE OF THE COMPTROLLER  
1 CENTRE STREET ROOM 1120  
NEW YORK, N.Y. 10007-2341

TELEPHONE: (212) 669-3622  
FAX NUMBER: (212) 669-8496

ALAN G. HEVESI  
COMPTROLLER

**MEMORANDUM**

November 6, 2000

To Agency Chief Contracting Officers

From: Leonard A. Mancusi

Re: Security at Construction Sites

Prior to the enactment of Administrative Code §6-109, security guards on construction sites were not subject to prevailing wages. Security guards under the New York State labor law are covered under §230 which provides that prevailing wages are to be paid for security guards in existing buildings. §6-109 of the Administrative Code which was enacted in 1996 closed this loophole by including all security guards working pursuant to a city contract as a prevailing wage trade.

Although some construction contract boilerplate language has been amended to include §6-109, sub-contractors performing security services have advised us that they were not aware of this provision and, since traditionally, security guards were not a covered trade on construction sites, and they were not advised by a prime contractor that they would have to pay prevailing wages, they have not been doing so.

To avoid the possibility of issuing stop payments against prime contractors for the failure of their security service sub-contractors to pay

*prevailing wages, we suggest that you write to all your existing security guard sub-contractors and their primes and in the future, upon approval of a security guard sub-contractor, advise the contractors of their obligation to pay prevailing wages under §6-109 of the Administrative Code.*

*As always, your cooperation is appreciated.*

**LAM:er**  
**ACCO.SECURITY AT SITES**



**Department of  
Design and  
Construction**

---

**INFRASTRUCTURE DIVISION  
BUREAU OF DESIGN**

---

**VOLUME 2 OF 3**

---

*Contractor.*

---

Dated \_\_\_\_\_, 20\_\_\_\_

---

**APPROVED AS TO FORM  
CERTIFIED AS TO LEGAL AUTHORITY**

---

*Acting Corporation Counsel*

---

Dated \_\_\_\_\_, 20\_\_\_\_

---



**Department of  
Design and  
Construction**

**INFRASTRUCTURE DIVISION  
BUREAU OF DESIGN**

**VOLUME 2 OF 3**

PROJECT ID: SANDHW11

RECONSTRUCTION OF

BEACH CHANNEL DRIVE

BETWEEN BEACH 116TH STREET AND BEACH 124TH STREET

INCLUDING SEWER, WATER MAIN, TRAFFIC SIGNAL  
AND STREET LIGHTING WORK

Together With All Work Incidental Thereto

BOROUGH OF QUEENS  
CITY OF NEW YORK

NY Asphalt, Inc  
8502017HW001C / 85017B00310001 Contractor.

Dated December 14, 2017

APPROVED AS TO FORM  
CERTIFIED AS TO LEGAL AUTHORITY

[Signature]  
Acting Corporation Counsel

[Signature] 1/2/17

Dated January 12, 2017

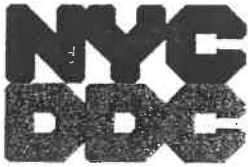

**Department of  
Design and  
Construction**

**THE CITY OF NEW YORK  
DEPARTMENT OF DESIGN AND CONSTRUCTION  
DIVISION OF INFRASTRUCTURE**

30-30 THOMSON AVENUE  
LONG ISLAND CITY, NEW YORK 11101-3045  
TELEPHONE (718) 391-1000  
WEBSITE [www1.nyc.gov/site/ddc/index.page](http://www1.nyc.gov/site/ddc/index.page)

**VOLUME 3 OF 3**

**SCHEDULE A  
SPECIFICATIONS AND  
REVISIONS TO STANDARD SPECIFICATIONS**

FOR FURNISHING ALL LABOR AND MATERIALS NECESSARY AND  
REQUIRED FOR:

**PROJECT ID: SANDHW11**

**RECONSTRUCTION OF**

**BEACH CHANNEL DRIVE  
BETWEEN BEACH 116TH STREET AND BEACH 124TH STREET**

**INCLUDING SEWER, WATER MAIN, TRAFFIC SIGNAL  
AND STREET LIGHTING WORK  
Together With All Work Incidental Thereto**

**BOROUGH OF QUEENS  
CITY OF NEW YORK**

FOR THE DEPARTMENT OF TRANSPORTATION  
PREPARED BY

*IN-HOUSE DESIGN*

**SEPTEMBER 29, 2016**

NYS DOT PIN X777.44  
Fed. Aid Project No. \_\_\_\_\_



## SPECIFICATIONS AND STANDARDS OF NEW YORK CITY

The following New York City Department of Transportation (NYCDOT) reference documents are available on-line at:

<http://www1.nyc.gov/site/ddc/resources/publications.page> or for purchase between 9:00 A.M. and 3:00 P.M. at 55 Water St., Ground Floor, NYC, N.Y. 10041. Contact: Ms Vivian Valdez, Tel. (212) 839-9434

1. NYCDOT Standard Highway Specifications, August 1, 2015
2. NYCDOT Standard Highway Details of Construction, July 1, 2010
3. NYCDOT Division of Street Lighting Specifications
4. NYCDOT Division of Street Lighting Standard Drawings
5. NYCDOT Standard Specifications for Traffic Signals
6. NYCDOT Standard Drawings for Traffic Signals

The following reference documents for New York City Department of Environmental Protection (NYCDEP) are available on-line at:

<http://www1.nyc.gov/site/ddc/resources/publications.page> or for pick up between 8:00 A.M. and 4:00 P.M. at 30-30 Thomson Avenue, 3rd Floor, Division of Infrastructure, Long Island City, N.Y. 11101. Contact: Mr. Nader Soliman, Tel. (718) 391-1179

1. NYCDEP Standard Sewer and Water Main Specifications, July 1, 2014
2. NYCDEP Instructions for Concrete Specifications, Jan. 92
3. NYCDEP General Specification 11-Concrete, November 1991
4. NYCDEP Sewer Design Standards, (September 2007) Revised January 2009

The following reference documents for New York City Department of Environmental Protection (NYCDEP) are available on-line at:

<http://www1.nyc.gov/site/ddc/resources/publications.page> or for pick up between 8:00 A.M. and 4:00 P.M. at 30-30 Thomson Avenue, 3rd Floor, Division of Infrastructure, Long Island City, N.Y. 11101. Contact: Mr. Robert Kuhlmann, Tel. (718) 391-2145

1. NYCDEP Water Main Standard Drawings, November 2010
2. Specifications for Trunk Main Work, July 2014
3. Standard Design and Guidelines for Green Infrastructure Practices, latest version, available only on-line at:  
[http://www.nyc.gov/html/dep/html/stormwater/green\\_infrastructure\\_standards.shtml](http://www.nyc.gov/html/dep/html/stormwater/green_infrastructure_standards.shtml)

Water main work material specifications are available at the Department of Environmental Protection, 59-17 Junction Boulevard, 3rd Floor Low-Rise Building, Flushing, N.Y. 11373-5108.

Contact: Mr. Tarlock Sahansra, P.E., Tel. (718) 595-5302  
E-mail: TSAHANSRA@DEP.NYC.GOV

Standard Specifications and Drawings for New York City Fire Department Communications facilities of New York City are available from the FDNY Facilities Management Bureau, Plant Operations Engineering, 316 Sgt. Beers Avenue Cluster 1 Box 16, Fort Totten, N.Y. 11359.  
Contact: Mr. Ed Durkin, Tel. (718) 281-3933

Tree Planting Standards of the City of New York Parks & Recreation are available at the following Department of Parks & Recreation website:

<http://www.nycgovparks.org/pagefiles/53/Tree-Planting-Standards.pdf>

SPECIFICATIONS AND STANDARDS OF PRIVATE UTILITIES

The Following reference document for Private Utility Work is available for pick up between 8:30 A.M. and 4:00 P.M. at 30-30 Thomson Avenue, First Floor Bid Procurement Room, L.I.C., N.Y. 11101.

1. CET SPECIFICATIONS AND SKETCHES dated November 2010

**VOLUME 3 OF 3**  
**TABLE OF CONTENTS**

<u>SECTION</u>	<u>DESCRIPTION</u>	<u>PAGES</u>
SCHEDULE A	GENERAL CONDITIONS TO CONSTRUCTION CONTRACT	SA-1 to SA-14
R - PAGES	REVISIONS TO STANDARD SPECIFICATIONS	R-1 to R-60
I - PAGES	NEW SECTIONS	I-1 to I-12
S - PAGES	SPECIAL PROVISIONS	S-1 to S-32
TF-PAGES	FHWA FUNDED PROJECTS FHWA FUNDING ATTACHMENTS	TF-1 to TF-K2
SW - PAGES	SEWER AND WATER MAIN SPECIFICATIONS	SW-1 to SW-13
EP7 - PAGES	GAS COST SHARING (EP-7) STANDARD SPECIFICATIONS	EP7-1 to EP7-28B
HAZ - PAGES	SPECIFICATIONS FOR HANDLING, TRANSPORTATION AND DISPOSAL OF NONHAZARDOUS AND POTENTIALLY HAZARDOUS CONTAMINATED MATERIALS	HAZ-1 to HAZ-130
UI - PAGES	UTILITY INTERFERENCE PAGES	UI-1 to UI-42



PROJECT ID.:SANDHW11

(NO TEXT ON THIS PAGE)

**SCHEDULE A****GENERAL CONDITIONS TO CONSTRUCTION CONTRACT**  
**(INCLUDING GENERAL CONDITIONS RELATED TO ARTICLE 22 – INSURANCE)****PART I. REQUIRED INFORMATION**

<p><b><u>INFORMATION FOR BIDDERS SECTION 26</u></b> <b><u>BID SECURITY</u></b></p> <p>The <b>Contractor</b> shall obtain a bid security in the amount indicated to the right.</p>	<p>Required provided the TOTAL BID PRICE set forth on the Bid Form is \$1,000,000 or more.</p> <p>Certified Check: 5% of Bid Amount or Bond: 10% of Bid Amount</p>
<p><b><u>INFORMATION FOR BIDDERS SECTION 26</u></b> <b><u>PERFORMANCE AND PAYMENT BONDS</u></b></p> <p>The <b>Contractor</b> shall obtain performance and payment bonds in the amount indicated to the right.</p>	<p>Required for contracts in the amount of \$1,000,000 or more.</p> <p>Performance Security and Payment Security shall each be in an amount equal to 100% of the Contract Price.</p>
<p><b><u>CONTRACT ARTICLE 14.</u></b> <b><u>DATE FOR SUBSTANTIAL COMPLETION.</u></b></p> <p>The <b>Contractor</b> shall substantially complete the <b>Work</b> in the number of calendar days indicated to the right.</p>	<p>See Page SA-4</p>
<p><b><u>CONTRACT ARTICLE 15.</u></b> <b><u>LIQUIDATED DAMAGES</u></b></p> <p>If the <b>Contractor</b> fails to substantially complete the <b>Work</b> within the time fixed for substantial completion plus authorized time extensions or if the <b>Contractor</b>, in the sole determination of the <b>Commissioner</b>, has abandoned the <b>Work</b>, the <b>Contractor</b> shall pay to the <b>City</b> the amount indicated to the right.</p>	<p>\$4,000.00 for each consecutive calendar day over the Completion Time as set forth for each Task Order</p>
<p><b><u>CONTRACT ARTICLE 17.</u></b> <b><u>SUB-CONTRACTOR</u></b></p> <p>The <b>Contractor</b> shall not make subcontracts totaling an amount more than the percentage of the total <b>Contract</b> price indicated to the right.</p>	<p>Not to exceed <u>49</u> % of the <b>Contract</b> price</p>
<p><b><u>CONTRACT ARTICLE 21.</u></b> <b><u>RETAINAGE</u></b></p> <p>The <b>Commissioner</b> shall deduct and retain until the substantial completion of the <b>Work</b> the percent value of the <b>Work</b> indicated to the right.</p>	<p><u>0</u> % of the value of the <b>Work</b></p>

<p><b><u>CONTRACT ARTICLE 22.</u></b> <b><u>(Per Directions Below)</u></b></p>	<p>See pages SA-5 through SA-13</p>
<p><b><u>CONTRACT ARTICLE 24.</u></b> <b><u>DEPOSIT GUARANTEE</u></b></p> <p>As security for the faithful performance of its obligations, the <b>Contractor</b>, upon filing its requisition for payment on <b>Substantial Completion</b>, shall deposit with the <b>Commissioner</b> a sum equal to the percentage of the <b>Contract</b> price indicated to the right.</p>	<p>1% of <b>Contract</b> price</p>
<p><b><u>CONTRACT ARTICLE 24.</u></b> <b><u>PERIOD OF GUARANTEE</u></b></p> <p>Periods of maintenance and guarantee other than the period set forth in Article 24.1 are indicated to the right.</p>	<p>Twenty-Four (24) Months for Tree Planting.</p>
<p><b><u>CONTRACT ARTICLE 74.</u></b> <b><u>STATEMENT OF WORK</u></b></p> <p>The <b>Contractor</b> shall furnish all labor and materials and perform all <b>Work</b> in strict accordance with the <b>Contract Drawings, Specifications, and all Addenda</b> thereto.</p>	<p>See Contract Article 74</p>
<p><b><u>CONTRACT ARTICLE 75.</u></b> <b><u>COMPENSATION TO BE PAID TO CONTRACTOR</u></b></p> <p>The <b>City</b> shall pay and the <b>Contractor</b> shall accept in full consideration for the performance of the <b>Contract</b>, subject to additions and deductions as provided in Contract Article 75, this said sum being the amount at which the <b>Contract</b> was awarded to the <b>Contractor</b> at a public letting thereof, based upon the <b>Contractor's</b> bid for the <b>Contract</b>.</p>	<p>See Contract Article 75</p>
<p><b><u>CONTRACT ARTICLE 78.</u></b> <b><u>PARTICIPATION BY MINORITY-OWNED AND WOMEN-OWNED BUSINESS ENTERPRISES IN CITY PROCUREMENT</u></b></p>	<p><b>EXEMPT</b> FHWA DBE goal of 13%, see page TF-D1, herein this book Volume 3 of 3</p>

<p align="center"><b><u>STANDARD HIGHWAY SPECIFICATIONS</u></b>  <b><u>SECTION 6.40</u></b>  <b><u>LIQUIDATED DAMAGES FOR</u></b>  <b><u>ENGINEER'S FIELD OFFICE</u></b></p> <p>If the Contractor fails to satisfactorily provide the field office and all equipment specified in <b>Section 6.40 - Engineer's Field Office</b>, and/or if a cited deficiency exceed seventy two (72) hours after notice from the Engineer in writing, or is permitted to recur, liquidated damages will be assessed in the amount specified herein for each subsequent calendar day or part thereof that a cited deficiency resulting in nonpayment, as described in <b>Section 6.40.5</b>, is not corrected.</p>	<p>\$ <u>500.00</u> for each calendar day of deficiency</p>
<p align="center"><b><u>STANDARD HIGHWAY SPECIFICATIONS</u></b>  <b><u>SECTION 6.70</u></b>  <b><u>LIQUIDATED DAMAGES FOR</u></b>  <b><u>MAINTENANCE AND PROTECTION OF TRAFFIC</u></b></p>	<p>\$ <u>250.00</u> for each instance of failure to comply with the Maintenance and Protection of Traffic requirements within three (3) hours after written notice from the Engineer</p> <p>\$ <u>500.00</u> for each and every hour of failing to open the entire width of roadway to traffic the morning following a night/weekend work operation</p>
<p align="center"><b><u>STANDARD HIGHWAY SPECIFICATIONS</u></b>  <b><u>SECTION 7.13</u></b>  <b><u>LIQUIDATED DAMAGES FOR</u></b>  <b><u>MAINTENANCE OF SITE</u></b></p> <p>If the Contractor fails to comply, within three (3) consecutive hours after written notice from the Engineer, with the requirements of <b>Section 7.13 - Maintenance of Site</b>, the Contractor shall pay to the City of New York, until such notice has been complied with or rescinded, the sum specified above per calendar day, for each instance of such failure, as liquidated damages and not as a penalty, for such default.</p>	<p>\$ <u>800.00</u> for each calendar day, for each occurrence</p>

**Date for Substantial Completion (Reference: Article 14)**

The Contractor shall substantially complete the Work within the Final Contract Duration determined in accordance with the terms and conditions set forth herein.

The Base Contract Duration for this project is 730 consecutive calendar days (“ccds”).

The Final Contract Duration shall be the Base Contract Duration when a check mark is indicated before the word “NO”, below, and shall be the Base Contract Duration adjusted by the table set forth below when a check mark is indicated before the word “YES”, below.

YES                       NO

When the Final Contract Duration is indicated above to be adjusted by the table below, the table may increase the Base Contract Duration depending on the date of scheduled substantial completion to avoid a scheduled substantial completion of the Work during the winter months. The date of scheduled substantial completion shall be determined by adding the Base Contract Duration to the date specified to commence work in the written Notice to Proceed. The Final Contract Duration shall then be determined as follows:

- (a) Find the row that corresponds to the month of substantial completion based on the Base Contract Duration added to the date specified to commence work in the written Notice to Proceed.
- (b) Find the number of days to be added to the Base Contract Duration in the table below. Add that number of days to the Base Contract Duration to obtain the Final Contract Duration in consecutive calendar days.

<b>Month of Substantial Completion based on the Base Contract Duration</b>	<b>Number of Days of adjustment</b>
<b>January</b>	150
<b>February</b>	120
<b>March</b>	90
<b>April</b>	60
<b>May</b>	30
<b>June</b>	0
<b>July</b>	0
<b>August</b>	0
<b>September</b>	0
<b>October</b>	0
<b>November –December 15</b>	0
<b>December 16 – December 31</b>	180

In addition, should Item No. 9.30, “Storm Water Pollution Prevention,” exist in the Contract and the required Storm Water Pollution Prevention Plan (SWPPP) does not conform to NYSDEC’s recommended Standards, an additional 60 ccd shall be added to the above Final Contract Duration.

(GENERAL CONDITIONS RELATING TO ARTICLE 22 – INSURANCE)

**PART II. TYPES OF INSURANCE, MINIMUM LIMITS AND SPECIAL CONDITIONS**

**Note:** All certificate(s) of insurance submitted pursuant to Contract Article 22.3.3 must be accompanied by a Certification by Broker consistent with Part III below and include the following information:

- For each insurance policy, the name and NAIC number of issuing company, number of policy, and effective dates;
- Policy limits consistent with the requirements listed below;
- Additional insureds or loss payees consistent with the requirements listed below; and
- The number assigned to the Contract by the City (in the “Description of Operations” field).

Insurance indicated by a blackened box (■) or by X in a □ to left will be required under this contract

Types of Insurance (per Article 22 in its entirety, including listed paragraph)	Minimum Limits and Special Conditions
<p>■ Commercial General Liability      Art. 22.1.1</p>	<p>The minimum limits shall be \$ <u>3,000,000</u> per occurrence and \$ <u>6,000,000</u> per project aggregate applicable to this <b>Contract</b>.                      Additional Insureds:                      1. City of New York, including its officials and employees, with coverage at least as broad as ISO Form CG 20 10 and CG 20 37, and                      2. All person(s) or organization(s), if any, that Article 22.1.1(b) of the <b>Contract</b> requires to be named as Additional Insured(s), with coverage at least as broad as ISO Form CG 20 26. The Additional Insured endorsement shall either specify the entity’s name, if known, or the entity’s title (e.g., Project Manager),                      3. All person(s) or organization(s) serving in the functions defined in Article 2, such as: Engineer, Architect, Project Manager, Resident Engineer, etc.                      4. New York State, including its officials and employees,                      5. Federal Highway Administration (FHWA), its officials and employees.                      6. National Grid</p>

<input checked="" type="checkbox"/> Workers' Compensation	Art. 22.1.2	Workers' Compensation, Employers' Liability, and Disability Benefits Insurance: Statutory per New York State law without regard to jurisdiction.
<input checked="" type="checkbox"/> Disability Benefits Insurance	Art. 22.1.2	<p><b>Note:</b> The following forms are acceptable: (1) New York State Workers' Compensation Board Form No. C-105.2, (2) State Insurance Fund Form No. U-26.3, (3) New York State Workers' Compensation Board Form No. DB-120.1 and (4) Request for WC/DB Exemption Form No. CE-200. The City will not accept an ACORD form as proof of Workers' Compensation or Disability Insurance.</p>
<input checked="" type="checkbox"/> Employers' Liability	Art. 22.1.2	Jones Act and U.S. Longshoremen's and Harbor Workers' Compensation Act: Statutory per U.S. Law.
<input type="checkbox"/> Jones Act	Art. 22.1.3	<input checked="" type="checkbox"/> Additional Requirements:
<input type="checkbox"/> U.S. Longshoremen's and Harbor Workers Compensation Act	Art. 22.1.3	<p>(1) NYCT "OUTSIDE CONTRACT" INSURANCE REQUIREMENTS: Workers' Compensation Insurance (including Employer's Liability Insurance) with limits of not less than \$2,000,000, which limit may be met by a combination of primary and excess insurance meeting the statutory limits of New York State.</p> <p>(2) Two (2) certificates of such insurance shall be furnished to the Director, Risk Management, MTA Risk and Insurance Management Standards, Enforcement and Claims Unit, 2 Broadway, 21<sup>st</sup> Floor, New York, NY 10004.</p>

<input type="checkbox"/> Builders' Risk	Art. 22.1.4	<p>100 % of total value of <b>Work</b></p> <p><b>Contractor</b> the Named Insured; the <b>City</b> both an Additional Insured and one of the loss payees as its interests may appear.</p> <p>If the <b>Work</b> does not involve construction of a new building or gut renovation work, the <b>Contractor</b> may provide an installation floater in lieu of Builders Risk insurance.</p> <p>Note: Builders Risk Insurance may terminate upon <b>Substantial Completion</b> of the <b>Work</b> in its entirety.</p>
<input checked="" type="checkbox"/> Commercial Auto Liability	Art. 22.1.5	<p>\$ <u>2,000,000</u> per accident combined single limit</p> <p>If vehicles are used for transporting hazardous materials, the <b>Contractor</b> shall provide pollution liability broadened coverage for covered vehicles (endorsement CA 99 48) as well as proof of MCS 90</p> <p>Additional Insureds:</p> <ol style="list-style-type: none"> <li>(1) City of New York, including its officials and employees, and</li> <li>(2) New York State, including its officials and employees, and,</li> <li>(3) FHWA, including its officials and employees.</li> </ol>



<input type="checkbox"/> Contractors Pollution Liability      Art. 22.1.6	<p>\$ <u>1,000,000</u> per occurrence          \$ <u>2,000,000</u> aggregate</p> <p>Additional Insureds:          1. City of New York, including its officials and employees, and          2. _____          3. _____</p>
<input type="checkbox"/> Marine Protection and Indemnity      Art. 22.1.7(a)	<p>\$ _____ each occurrence          \$ _____ aggregate</p> <p>Additional Insureds:          1. City of New York, including its officials and employees, and          2. _____          3. _____</p>
<input type="checkbox"/> Hull and Machinery Insurance      Art. 22.1.7(b)	<p>\$ _____ per occurrence          \$ _____ aggregate</p> <p>Additional Insureds:          1. City of New York, including its officials and employees, and          2. _____          3. _____</p>
<input type="checkbox"/> Marine Pollution Liability      Art. 22.1.7(c)	<p>\$ _____ per occurrence          \$ _____ aggregate</p> <p>Additional Insureds:          1. City of New York, including its officials and employees, and          2. _____          3. _____</p>

<p>[OTHER] <span style="float: right;">Art. 22.1.8</span></p> <p>■ <b>Railroad Protection Liability Policy</b></p> <p>(ISO-RIMA or equivalent form) approved by Permitter covering the work to be performed at the designated site and affording protection for damages arising out of bodily injury or death, physical damage to or destruction of property, including damage to the Insured's own property and conforming to the following:</p> <ul style="list-style-type: none"> <li>• Policy Endorsement CG 28 31 - Pollution Exclusion Amendment is required to be endorsed onto the policy when environmental-related work and/or exposures exist.</li> <li>• Indicate the Name and address of the Contractor to perform the work, the Contract # and the name of the railroad property where the work is being performed and the Agency Permit.</li> <li>• Evidence of Railroad Protective Liability Insurance, must be provided in the form of the <u>Original Policy. A detailed Insurance Binder (ACORD or Manuscript Form) will be accepted pending issuance of the Original Policy, which must be provided within 30 days of the Binder Approval.</u></li> </ul>	<p>\$ <u>2,000,000</u> per occurrence</p> <p>\$ <u>6,000,000</u> annual aggregate</p> <p>Named Insureds:</p> <ol style="list-style-type: none"> <li>1. New York City Transit Authority (NYCTA), the Manhattan and Bronx Surface Transit Operation Authority (MaBSTOA), the Staten Island Rapid Transit Operation Authority (SIRTOA), MTA Capital Construction Co., the Metropolitan Transportation Authority (MTA) including its subsidiaries and affiliates, and the City of New York (as Owner) and all other indemnified parties.</li> </ol>
---	---

<p>[OTHER] <span style="float: right;">Art. 22.1.8</span></p> <p><input type="checkbox"/> Professional Liability</p> <p>A. The Contractor's Professional Engineer shall maintain and submit evidence of Professional Liability Insurance in the minimum amount of \$1,000,000 per claim. The policy or policies shall include an endorsement to cover the liability assumed by the Contractor under this Contract arising out of the negligent performance of professional services or caused by an error, omission or negligent act of the Contractor's Professional Engineer or anyone employed by the Contractor's Professional Engineer.</p> <p>B. Claims-made policies will be accepted for Professional Liability Insurance. All such policies shall have an extended reporting period option or automatic coverage of not less than two (2) years. If available as an option, the Contractor's Professional Engineer shall purchase extended reporting period coverage effective on cancellation or termination of such insurance unless a new policy is secured with a retroactive date, including at least the last policy year.</p>	
<p>[OTHER] <span style="float: right;">Art. 22.1.8</span></p> <p><input checked="" type="checkbox"/> Engineer's Field Office</p> <p><b>Section 6.40, Standard Highway Specifications</b></p>	<p>Fire insurance, extended coverage and vandalism, malicious mischief and burglary, and theft insurance coverage in the amount of <u>\$40,000</u></p>
<p>[OTHER] <span style="float: right;">Art. 22.1.8</span></p> <p><input type="checkbox"/> The Following Additional Insurance Must Be Provided:</p> <p><b>Umbrella/Excess Liability Insurance</b> - The Contractor shall provide Umbrella/Excess Liability Insurance in the minimum amount of \$10,000,000 per Occurrence and \$10,000,000 in Aggregate. The policy terms and condition should be at least as broad as the underlying policies. The underlying policies should comply with the insurance provision as outlined by the contract. Defense cost should be in addition to the limit of liability. The City of New York, including its officials and employees, should be included as additional insured as respects to the noted project.</p>	

**SCHEDULE A**  
**(GENERAL CONDITIONS TO CONSTRUCTION CONTRACT)**  
**(GENERAL CONDITIONS RELATING TO ARTICLE 22 – INSURANCE)**

**PART III. CERTIFICATES OF INSURANCE**

All certificates of insurance (except certificates of insurance solely evidencing Workers' Compensation Insurance, Employer's Liability Insurance, and/or Disability Benefits Insurance) must be accompanied by one of the following:

- (1) the Certification by Insurance Broker or Agent on the following page setting forth the required information and signatures;

-- OR --

- (2) copies of all policies as certified by an authorized representative of the issuing insurance carrier that are referenced in such certificate of insurance. If any policy is not available at the time of submission, certified binders may be submitted until such time as the policy is available, at which time a certified copy of the policy shall be submitted.



**SCHEDULE A**

**(GENERAL CONDITIONS TO CONSTRUCTION CONTRACT)**

**PART IV. ADDRESS OF COMMISSIONER**

Wherever reference is made in Article 7 or Article 22 to documents to be sent to the **Commissioner** (e.g., notices, filings, or submissions), such documents shall be sent to the address set forth below or, in the absence of such address, to the **Commissioner's** address as provided elsewhere in this **Contract**.

DDC Director, Insurance Risk Manager

30 – 30 Thomson Avenue, 4th Floor (IDCNY Building)

Long Island City, NY 11101

Project ID.: SANDHW11

(NO TEXT ON THIS PAGE)

**REVISIONS TO STANDARD  
SPECIFICATIONS**

---

**NOTICE**

The Specification Bulletin(s) ("SB(s)") contained in this Section (R-Pages) may consist of revisions to the following Standard Specifications:

- New York City Department of Transportation ("NYC DOT") Standard Highway Specifications, dated 8/1/2015;
- New York City Department of Environmental Protection ("NYC DEP") Standard Sewer and Water Main Specifications, dated 7/1/2014; and
- NYC DEP Specifications for Trunk Main Work, dated 7/2014.



The SB(s) modify and supersede portions of the applicable Standard Specifications. The provisions contained in this Contract's I-Pages, S-Pages and SW-Pages may further modify the applicable Standard Specifications.

The following SB(s) are included as part of this contract:

- SB 16-001 – REVISIONS TO THE NYC DOT STANDARD HIGHWAY SPECIFICATIONS.
- SB 16-002 – REVISIONS TO THE NYC DEP STANDARD SEWER AND WATER MAIN SPECIFICATIONS.
- SB 17-001 – UV CURED-IN-PLACE-PIPE (CIPP) LINING METHOD
- SB 17-002 – RODENT AND WATERBUG PEST CONTROL
- SB 17-003 – ENGINEERS FIELD OFFICE
- SB 17-004 – FIRE DEPARTMENT FACILITIES
- SB 17-005 – DIGITAL PHOTOGRAPHS
- SB 17-006 – RECORDS OF SUBSURFACE STRUCTURES

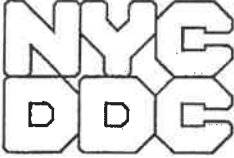
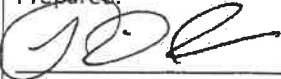

**(NO TEXT ON THIS PAGE)**

	<b>Department of Design and Construction</b>	<b>SPECIFICATION BULLETIN</b>	<b>SB</b>  16-001
Prepared: 	6/29/2016	Approved: 	6/29/2016
Richard Jones, P.E. CWI Director, Specifications – Infrastructure Design	Date	Mohsen Zargareh, P.E. Assistant Commissioner – Infrastructure Design	Date

**APPLICABILITY:**

- This Specification Bulletin (SB) is effective for projects advertised on or after 7/11/16.

**SUPERSEDEANCE:**

- This SB supersedes the following SBs: **NONE**

**REVISIONS TO THE NEW YORK CITY DEPARTMENT OF TRANSPORTATION  
STANDARD HIGHWAY SPECIFICATIONS VOLUME 1 OF 2, DATED 8/1/15:**

All references contained below are to the New York City Department of Transportation Standard Highway Specifications, Dated August 1, 2015. Said Standard Highway Specifications are hereby revised as follows:

- a) Refer to Page 3, Subsection 1.06.3;  
Delete the third paragraph;  
Substitute the following new paragraph:  
"Any doubt as to the meaning of this contract or the specifications thereof, or any obscurity as to the wording of them, or any discrepancy between them, or any discrepancy between figures and drawings will be explained by the Engineer."
- b) Refer to Page 5, Subsection 1.06.8;  
Delete the words "tentative" wherever it occurs in the last paragraph.
- c) Refer to Page 17, Subsection 1.06.23.(G), last paragraph;  
Delete the word "asbestos" wherever it occurs.
- d) Refer to Page 26, Subsection 1.06.29, line number four (4);  
Delete the words and punctuation mark ", and at the prices fixed herein" in its entirety.



**Department of  
Design and  
Construction**

**SPECIFICATION  
BULLETIN**

**SB**

**16-001**

**Title: REVISIONS TO NYC DOT STANDARD HIGHWAY SPECIFICATIONS**

- e) Refer to Page 41 Subsection 1.06.48.(C), 2nd paragraph, 1st line;  
Delete from the first line starting from "have maximum grade of one (1) vertical on three (3) horizontal", in its entirety;  
Substitute the following:  
"have a maximum grade of one (1) vertical on twelve (12) horizontal, for pedestrian ramp and one (1) vertical on six (6) horizontal, for driveway ramp";
- f) Refer to Page 87, Subsection 2.18.3(A), 4th paragraph;  
Change "." to "," after "... and Appeals";  
Add the following words: "and the health standards of OSHA of the U.S. Department of Labor."
- g) Refer to Page 104, Subsection 3.01.3.(C).1.(c), 4<sup>th</sup> paragraph;  
Delete the words "to a maximum of 70%"
- h) Refer to Page 120, Subsection 3.05.5.(A), 2<sup>nd</sup> Table 3.05-V;  
Delete the sentence: "Concrete of Type IA, IIA and IIIA shall have an air entrainment of 4 to 7 percent when the coarse aggregate is 1 1/2" stone and 5 to 7 percent when the coarse aggregate is 3/4" stone, with 6.5 percent desired in either case."  
Substitute the following:  
"Concrete of classes shown in Table 3.05-II shall have an air entrainment of 4 to 7 percent for size 357 coarse aggregate and 5 to 7 percent for size 67 or 57 aggregate; with 6.5 percent desired in either case. If concrete is pumped, air entrainment shall be measured after the pump."
- i) Refer to Page 135, Subsection 3.05.9, 4<sup>th</sup> paragraph;  
Add the following words to the end of the 4<sup>th</sup> paragraph: "Dosing of accelerators and retarders shall be per the manufacturer's published recommendations. Addition of an accelerator or retarder per this subsection will not require a separate mix design, unless requested by the Engineer."
- j) Refer to Page 192, Subsection 4.06.12;  
Delete the Subsection 4.06.12, in its entirety and substitute the words "4.06.12. (NO TEXT)." The use of rubble aggregate will not be permitted.
- k) Refer to Page 282, Subsection 5.02.2.(C), 2<sup>nd</sup> paragraph;  
Add the following words: "6 in x 12 in" after "At least four (4)"

	<b>Department of Design and Construction</b>	<b>SPECIFICATION BULLETIN</b>	<b>SB</b>  <b>16-001</b>
<b>Title: REVISIONS TO NYC DOT STANDARD HIGHWAY SPECIFICATIONS</b>			

- i) Refer to Page 282, Subsection 5.02.2.(C), 2<sup>nd</sup> paragraph;  
Delete the sentence: "Curing boxes shall be furnished in good operating condition, capable of maintaining cylinders under water at a curing temperature of 72°F. ±5°F."  
Substitute the following:  
"Curing boxes meeting the requirements of ASTM C31 and C511 shall be furnished in good operating condition, and shall maintain cylinders under water at a curing temperature of 73.5°F ±3.5°F. Curing boxes with rusted or corroded interior surfaces shall not be used."

**REVISIONS TO THE NEW YORK CITY DEPARTMENT OF TRANSPORTATION  
STANDARD HIGHWAY SPECIFICATIONS VOLUME 2 OF 2, DATED 8/1/15:**

*No Changes.*

**(NO TEXT THIS PAGE)**

	<b>Department of Design and Construction</b>	<b>SPECIFICATION BULLETIN</b>	<b>SB</b>  16-002
Prepared: 	10/11/2016	Approved: 	10/11/2016
Richard Jones, P.E. CWI Director, Specifications – Infrastructure Design	Date	Mohsen Zargarelahi, P.E. Assistant Commissioner – Infrastructure Design	Date

**APPLICABILITY:**

- This Specification Bulletin (SB) is effective for projects advertised on or after 11/14/16.

**SUPERSEDEENCE:**

- This SB supersedes the following SBs: NONE

**ATTACHMENTS:**

- **ATTACHMENT 1:** Revised Section 40.05 – SHEETING AND BRACING  
*Pages A1-1 through A1-7*
- **ATTACHMENT 2:** Revised Section 70.91 – SHEETING  
*Pages A2-1 through A2-3*

**REVISIONS TO THE NEW YORK CITY DEPARTMENT OF ENVIROMENTAL PROTECTION STANDARD SEWER AND WATER MAIN SPECIFICATIONS, DATED 7/1/14:**

All references contained below are to the New York City Department of Environmental Protection Standard Sewer and Water Main Specifications, Dated July 1, 2014. Said Standard Sewer and Water Main Specifications are hereby revised as follows:

- a) **Refer** to Page III-6, Subsection 30.03.1;  
**Add** the text ", C780 Annex 6" to line (2) after the words "C109".
- b) **Refer** to Pages IV-12 through IV-18, Section 40.05 – SHEETING AND BRACING;  
**Delete** in its entirety the Section;  
**Substitute** the revised Section in Attachment 1 (7 pages).
- c) **Refer** to Page V-60, Subsection 50.72.5.(A);  
**Delete** in its entirety the Subsection;  
**Substitute** the revised Subsection:



**Title: REVISIONS TO THE NYC DEP STANDARD SEWER AND WATER MAIN  
SPECIFICATIONS**

“(A) Cement shall be either Type V cement meeting the requirements of ASTM C150 or blended cement containing 8% microsilica that meets the requirements of NYS Department of Transportation Standard Specification 701-03, Type IP (8)”.

- d) **Refer** to Page V-65, Subsection 50.72.7.(N);  
**Delete** the second sentence: “The test cubes shall be 4”x4”x4”.
  
- e) **Refer** to Page V-66, Subsection 50.72.7.(N);  
**Delete** the text:  
Test cubes will be made and stored in accordance with ASTM C31 and tested in accordance with ASTM C39, except as otherwise modified by the Engineer. Each test will consist of three (3) cubes; one (1) to be tested at seven (7) days, the other two (2) at twenty-eight (28) days.  
**Substitute** the revised text:  
“Test cores will be made, cured, and tested in accordance with ASTM C42, except as otherwise modified by the Engineer. Test cores will be made from a shotcrete test board, where the shotcrete thickness matches the placed thickness. Each test will consist of three (3) cores; one (1) to be tested at seven (7) days, the other two (2) at twenty-eight (28) days.”
  
- f) **Refer** to Pages V-65, V-66, and V-67, Subsections 50.72.7.(N), 50.72.9, and 50.72.10;  
**Delete** the text “Test Cube” wherever it appears;  
**Substitute** the text “Test Core”.
  
- g) **Refer** to Page VII-25, Subsection 70.12.5.(B).(2);  
**Delete** the text “and C492”;  
**Substitute** the replacement text “or C780 Annex 6”
  
- h) **Refer** to Page VII-29, Subsection 70.13.4;  
**Add** the text “ or C780 Annex 6” after the words “C109”.
  
- i) **Refer** to Pages VII-48 through VII-51, Section 70.91 – SHEETING;  
**Delete** in its entirety the Section;  
**Substitute** the revised Section in Attachment 2 (3 pages).

**SECTION 40.05  
SHEETING AND BRACING**

**40.05.1 SHEETING AND BRACING**

(A) The sides of the trenches and excavations shall be supported by adequate sheeting and properly braced. All sheeting and bracing systems the Contractor elects to use or are ordered by the Engineer or the Department shall comply with these specifications and must receive the approvals stated herein. Timber sheeting and bracing shall be vertical sheeting with rangers and braces or horizontal sheeting supported by vertical steel soldier beams and the necessary bracing.

(B) Where the material to be excavated is of such character as to render it necessary, the sheeting shall be tongued and grooved and driven to such depths below the subgrade as may be directed.

(C) Where the nature of the material encountered or the safety of the adjacent structure render it necessary, the Contractor may resort to the use of steel sheet piling with prestressed bracing or the Contractor may underpin the structure or buildings.

(D) Other sheeting systems may be permitted upon approval of the Department of Design and Construction. (Trench Boxes will not be permitted for use in trenches and excavations that exceed twelve (12) feet in depth. (See **Subsection 40.05.4(E)**.)

(E) In general, sheeting and bracing in trenches and excavations shall be designed and installed so that the sheeting shall not be braced or blocked against any part of the new structure, or manholes, or chambers. When conditions warrant, bracing against such structures may be permitted following the approval of drawings prepared and submitted by a Professional Engineer licensed in the State of New York, showing the assumed design loads and stresses, and details of such bracing.

(F) If, in the opinion of the Engineer, any of the approved temporary or permanent supporting structures are inadequate or unsuitable for the actual conditions in the field, the Engineer may direct the Contractor to strengthen the supporting structures at no additional cost to the City. The Contractor shall be responsible for the sufficiency of all temporary and permanent supporting structures whether or not directed by the Engineer to strengthen them.

(G) Unless otherwise specified in the plans or these specifications, the Contractor shall remove all sheeting and bracing throughout this project as per **Subsection 40.05.7**.

**40.05.2 SHEETING LEFT IN PLACE**

When sheeting is specifically shown on the plans or specifically described in the specifications or specifically ordered in writing by the Engineer to be left in place, it refers to all sheeting and bracing in trench excavations for water main pipe and sewer conduit including manholes, valves and chambers. Excavations for catch basins, basin connections, house services and other excavations not considered part of the trench excavation for water main pipe and sewer conduit shall have their sheeting and bracing removed entirely.

When sheeting is to be left in place, all elements such as rangers and braces, of the sheeting used, must be left in place, except for such temporary braces that require removal in order to make way for the structure. Where it is necessary to remove such temporary braces, the sheeting shall be rebraced in a manner approved by the Engineer; however, in no case shall the sheeting be braced against the side of the structure unless approved in writing by the Engineer. Where lagging and soldier beams are used, the soldier beams and all the rangers and braces shall also be left in place. Where steel sheeting is used, the rangers and braces shall also be left in place.

When sheeting is to be left in place, the Contractor shall cut sheeting at the elevations ordered in writing by the Engineer; however, in general such cutoffs shall not be less than four (4) feet below the final



grade. Timber sheeting shall be cut off by sawing. Steel sheeting or soldier beams shall be cut off by burning. Breaking off of sheeting will not be permitted. The Contractor shall remove from the trench and away from the site of work, to the Contractor's own place of disposal, all cut sheeting and soldier beams together with all rangers, lagging and braces above the ordered elevation of cut. Where the removal of rangers and braces above the ordered elevation of cut is determined by the Engineer to render the sheeting system unstable, rangers and braces shall be placed prior to cutting at a level below the ordered elevation of cut and left in place.

**(A) FOR SHEETING OF WATER MAIN TRENCHES AND EXCAVATIONS**

Additional payment will be made for sheeting and bracing that is specifically shown on the plans or specifically described in the specifications or ordered in writing by the Engineer, to be left in place in water main trenches and excavations. Payment will be made in accordance with **Section 70.91**.

**(B) FOR SHEETING OF SEWER TRENCHES AND EXCAVATIONS**

No separate or additional payment will be made for sheeting and bracing that is specifically shown on the plans or specifically described in the specifications to be left in place in sewer trenches and excavations, regardless of the type used nor for the removal from the trench and excavation and the disposal away from the job site of the cut sheeting, bracing and rangers. The cost thereof shall be included in the prices bid for all sewer contract items of work, except when separate payment for sheeting and bracing is provided, in this case the cost shall be included therein. When sheeting is specifically ordered by the Engineer, to be left in place in sewer trenches and excavations, the cost for all labor, materials, cutting, removal, disposal, insurance and work required to leave sheeting in place shall be determine in accordance with **Articles 25 and 26** of the Contract.

**40.05.3 MATERIALS**

(A) Timber sheeting and bracing shall be of new or acceptable used timber free from injurious defects.

(B) Steel soldier beams shall comply with the requirements of **Section 23.05 - Structural, Reinforcing And Miscellaneous Steel**, except that approved used material will be permitted. Steel sheet piling shall comply with the requirements of **Section 24.01 - Steel Sheeting**, except that approved used materials will be permitted. Timber and lumber for bracing, shoring, fencing, bridging, and decking shall conform to the requirements of **Section 23.06 - Timber And Lumber**. Steel used for sheeting systems or for any other purposes herein shall conform to the requirements of the ASTM A36 and all other applicable requirements of ASTM.

(C) Steel Plates for use as sheeting will be permitted provided that they are properly installed and supported. The use of steel bracing frames which partially support the steel plates will be permitted up to a depth of twelve (12) feet. The use of steel plates in conjunction with trench boxes will not be permitted (trench boxes can not be considered as steel bracing frames).

(D) Steel Sheeting shall conform to the requirements of **Section 24.01** and shall be installed with continuous interlock.

**40.05.4 CONSTRUCTION METHODS**

(A) **GENERAL** - Timber sheeting and bracing and other sheeting systems shall be of sufficient dimensions and strength, and steel sheeting shall be of sufficient type, size and weight, to support adequately the sides of the trenches and excavations and insure the safety of adjacent structures and shall be installed in accordance with the approved sheeting details. The Contractor shall be solely responsible for the adequacy and sufficiency of all sheeting and bracing used.

(B) **SHEETING** - Unless otherwise specified, timber sheeting and bracing shall be driven or placed ahead of the excavation in such a manner as to prevent the loss or slippage of ground in order to

safeguard adjacent surface and subsurface structures. The sheeting shall be driven to adequate depth below subgrade. As the work progresses, any voids back of the sheeting shall be filled and compacted in accordance with **Section 40.06** and as directed by the Engineer.

(C) Sheeting can be used as forms for concrete work. Whenever sheeting is used as formwork as specified or approved by the Engineer only timber sheeting will be permitted unless otherwise approved or specified in writing by the Engineer. When sheeting is used as formwork, an approved protection shall be placed between the sheeting, bracing or soldier beams and the concrete. In addition, when sheeting is used as formwork for any structure or portion thereof, the thickness of that structure or portion of such structure shall be increased by three (3) inches beyond the original neat line of such structure or portion thereof. In no case shall the sheeting, soldier beams or other bracing encroach upon the original neat line of the structure. In such instances when sheeting, soldier beams or other bracing is found to encroach upon the neat line of the structure, the Engineer shall direct the Contractor to remove such sheeting, soldier beams or other braces and redrive and/or replace the sheeting, soldier beams or other braces outside the neat line of the structure. All sheeting used as formwork shall be removed.

(D) All open cuts shall be excavated with vertical sides and properly supported with close sheeting and bracing in conformity with the requirements of **Section 40.03 - Earth Excavation** and with 23 NYCRR - "Protection of Persons Employed in Construction and Demolition Work" and 16 NYCRR Part 753 - "Protection of Underground Facilities" of the State of New York, Department of Labor, Board of Standards and Appeals.

(E) The Contractor is advised that trench boxes will be permitted for use as a sheeting system provided that the depth of trench does not exceed twelve (12) feet. The use of trench boxes to partially sheet trenches that are greater than twelve (12) feet in depth, will be strictly prohibited.

Should trench boxes meeting the above requirements be utilized, the trench will not have to be sheeted completely to subgrade. The trench box will be permitted to "hang up" to a maximum of two (2) feet above subgrade provided that the existing soil in the area of the subgrade can "stand up" on its own without sheeting. Should running ground be encountered or should the soil in the subgrade area begin to slough off, the Contractor will be required to extend the trench box to subgrade. The Engineer shall always maintain the right to order the Contractor to lower the trench box to subgrade as required.

No deductions will be made from any payment for not sheeting the bottom two (2) feet of trench if approved by the Engineer and no additional payment will be made should the Contractor be directed to sheet completely to subgrade.

All sheeting and bracing drawings submitted for approval which indicate trench boxes must be designed for the full depth of trench (to subgrade) and shall show the trench box extending to subgrade.

(F) **SLOPED SIDES OF TRENCHES OR EXCAVATIONS** - Where the Contractor requests permission not to sheet a trench or excavation, and offers to slope the sides of such trench or excavation in accordance with OSHA Regulations in lieu of such sheeting, the Contractor's request shall be reviewed by the Engineer.

If the Engineer deems such sloping to be acceptable the Engineer shall so notify the Contractor in writing.

Pavement excavation and restoration requirements shall be governed by the width of the trench measured at the bottom of the pavement foundation. Pavement excavation and restoration in excess of those required in connection with standard trench excavation, as specified, shall not be paid for.

In those cases where the Contractor does not request permission to side slope, but the Engineer determines that side sloping is in the best interests of the City, the Engineer shall order the Contractor to proceed using such side sloping. In these cases, the additional pavement excavation and restoration will be paid for at the appropriate bid unit price.

In both of the above cases it shall be presumed that side sloping a trench or excavation is done to obtain a lower cost for the work to be performed. The City shall, therefore, take an appropriate credit to cover the difference in overall costs resulting from the use of side sloping instead of timber sheeting.

#### (G) SHEETING METHODS

The following methods of sheeting trenches are acceptable:

- (a) Vertical Wood Sheeting
- (b) Steel Soldier Beams with Horizontal Wood Lagging
- (c) Interlocking Steel Sheeting
- (d) Trench Boxes for trench depths up to twelve (12) feet
- (e) Steel Soldier Beams with Steel Plates continually supported
- (f) Steel Frames with Steel Plates for trench depths up to twelve (12) feet
- (g) Krings and Icon Type Sheeting Frames and Plates

#### 40.05.5 SHOP DRAWINGS

The Contractor will be required to submit Shop Drawings detailing the sheeting system whenever the depth of cut exceeds five (5) feet.

(A) Before commencing any excavating operation the Contractor shall have approved drawings from the Department of Design and Construction for all types of sheeting and bracing systems, cofferdams, shoring, underpinning, bridging, decking and all other temporary or permanent supporting structures required.

(B) The Contractor shall submit for approval five (5) copies of sheeting and bracing drawings, and other structures (i.e. decking, bridging) drawings that the Contractor proposes to use for the work.

(C) The Contractor shall have these drawings prepared by a Licensed Professional Engineer, currently registered in the State of New York. Such drawings shall be submitted together with design calculations, references, tables and charts. Both drawings and design calculations shall bear the imprint of the Licensed Professional Engineer's seal and signature.

(D) In designing the sheeting stated above, the Contractor's Engineer shall take note of the standard minimum load diagram requirements for Watertight and Non-Watertight sheeting structures. (See Sewer Design Standards.)

(E) The following notes shall be required on all sheeting detail submissions:

- (1) If the actual surcharge is in excess of three hundred thirty (330) pounds per square foot the Contractor shall adequately reinforce the sheeting and bracing as required at no additional cost to the City.
- (2) Maximum pilot cut shall be five (5) feet.

The sheeting and bracing drawings shall also include but not be limited to the following: the density of the soil, the internal angle of friction of the soil, the stress grade and type of lumber, the allowable steel stresses and the sequence of construction operation where required.

(F) Shop drawings of sheeting, bracing and other structures used by the Contractor shall be signed by and carry the seal of a Professional Engineer licensed in the State of New York. These drawings shall be submitted together with proper design computations bearing the same seal and signature. Shop drawings shall be on sheets twenty-seven (27) inches by forty (40) inches with a one-half (1/2) inch marginal space on three (3) sides and a two (2) inch marginal space for binding on the left side.

Shop drawings shall be numbered consecutively and shall accurately and distinctly present the following:

- (1) All working and erection dimensions.
- (2) Arrangement and sectional views.
- (3) Necessary details, including complete information for making connections between work under this contract and work under other contracts.
- (4) Kinds of materials.

(G) Each shop drawing shall be dated and contain:

- (1) The name of this project and this contract number.
- (2) The description name of classified contract item number or numbers under which it is or they are required.
- (3) The locations or points at which the sheeting is to be installed in the work.

(H) All sheeting submissions shall reflect the means and methods chosen by the Contractor and approved by the Engineer. Whenever steel sheeting systems (including trench boxes, frames and plates, etc.) are submitted which would render the crossing of Utilities (i.e. water mains and sewers) impossible the Contractor shall also submit, for approval, a system which can be utilized to permit such crossings (i.e. wood sheeting).

(I) The submission of multiple sheeting systems shall be kept to a minimum. Whenever the Contractor submits multiple systems they must be accompanied with a Location Plan shop drawing to indicate the exact location where these various systems are to be installed. Since the approval of multiple systems will delay the sheeting approval process the Contractor is requested to submit a schedule indicating the time frame that these systems are required. In addition the Contractor will be required to install these multiple systems at the locations indicated on the submitted Location Plan. Should the Contractor request to change the sheeting system at any particular location the Contractor will be required to resubmit the sheeting drawing, for approval, even though the revised sheeting system may have been approved at another location within the project area. The Contractor is reminded that the approval time for any given sheeting system may require up to four (4) weeks.

#### **40.05.6 DESIGN CRITERIA**

The following criteria shall be used in calculating the required sheeting, bracing and/or decking systems.

(A) All compression members (struts) shall be designed with a factor of safety of two (2.0). The factor of safety of two (2.0) shall be a value above and beyond the allowable value for compressive stresses for steel as designated in the "AISC Manual of Steel Construction", and for wood as designated in the "National Design Specification for Stress-Grade Lumber and its Fastening". All other allowable stresses (not including compression members) may be increased by thirty-three and one-third (33-1/3) percent where sheeting and bracing is deemed a temporary structure.

(B) A factor of safety shall be used to determine the minimum embedment for sheeting as follows:

- Vertical Timber - 15%
- Soldier Beams - 20%
- Steel Sheeting - 30%

(C) Embedment shall be calculated in accordance with the procedures and standard minimum load diagrams specified herein. The maximum allowable embedment for vertical timber sheeting shall not exceed three feet six inches (3'-6"). The minimum embedment shall be two (2) feet.

(D) The Contractor is advised that the maximum allowable bending stress ( $F_b$ ) for all timber members shall not exceed one thousand seven hundred fifty (1,750) pounds per square inch. If the Contractor

elects to use a bending stress higher than  $F_b = 1,750$ -psi, written certification of bending stress test results shall be submitted to the Engineer prior to use of such material in construction.

(E) Where it is anticipated that heavier crane or equipment loads will fall within the influence line of the trench, design loads shall be increased accordingly.

(F) The Contractor shall compute and include in the Contractor's submission of drawings and calculations the following:

- (1) Maximum bending stress
- (2) Maximum horizontal shear in wale
- (3) Compression perpendicular to grain
- (4) Maximum vertical shear stress

(G) DECKING

- (1) Unless otherwise specified in the contract documents or approved in writing by the Engineer, the minimum live load on decking shall be AASHTO HS20-44 or Contractor's equipment or heaviest truck loading (i.e. concrete trucks) whichever is greater plus an impact factor of thirty-three (33) percent.
- (2) Unless otherwise approved, timber mats shall extend a minimum of three (3) feet from sheeting line on either side of trench.
- (3) Unless otherwise approved, a minimum one thousand (1,000) pounds per square foot surcharge load shall be used for sheeting below decking.

(H) Maximum trench widths shown on sheeting details shall not exceed those allowed by the standards or specifications.

(I) The Contractor shall provide an individual cross-sectional sheeting (trench) detail for each size water main pipe and sewer conduit to be constructed unless permission to do otherwise is granted.

(J) Where the water table lies above the subgrade of trench and a well point or deep well dewatering system is not used, the Contractor shall include the effect of hydrostatic loading in calculations for both watertight and non-watertight sheeting.

(K) Sheeting details shall accurately depict actual field operations. The Contractor shall be restricted to a maximum five (5) feet deep pilot cut and all details must reflect this. Additional braces and wales may be required to install sheeting due to the five (5) feet maximum pilot cut restriction. The Contractor shall not assume that additional pilot cut depths will be allowed.

#### **40.05.7 REMOVAL OF SHEETING**

All sheeting design and requirements shall be in strict conformance with this section and all appropriate Addenda to the specifications.

Unless otherwise specified in the plans or these specifications, the Contractor shall remove all sheeting and bracing throughout this project.

(A) The sheeting shall be removed in lifts during the backfilling operation in order to permit proper placement and compaction of material against the structure and the earth bank. This work shall be accomplished in conjunction with the removal of wales and braces. In no case shall the lifts for sheeting exceed the specified or otherwise approved depth of compaction layer.

(B) The Contractor shall submit to the Engineer, for approval, the Contractor's method for installation and removal of sheeting and the method for backfilling the trench. The submission shall also specify if there are any location(s) where sheeting cannot be removed and detail the reasons why the sheeting cannot be removed. The submission shall be signed by and carry the seal of a New York State Licensed Professional Engineer. These methods must be strictly adhered to.

(C) The Contractor is advised that the Contractor will be responsible for, and shall solely at the Contractor's own expense, repair, replace and/or relocate all City owned utilities that are damaged and/or disturbed due to the Contractor's removal of sheeting operation.

(D) If the Contractor is required to leave the sheeting system in place in order to protect City owned utility crossings and structures, payment will be made in accordance with **Subsection 40.05.2(A)** and **Subsection 40.05.2(B)**.

(E) This section shall not be construed to relieve the Contractor of the Contractor's obligation under the contract to maintain, protect and support (temporarily and permanently) all City owned utilities within the influence lines of the excavated trenches. The Contractor in accordance with the standards of the agencies having jurisdiction thereof shall perform such maintenance, protection and support.

(F) The cost of maintenance, protection and support (temporarily and permanently) of City owned utilities shall be included in the prices bid for all items for which there are bid prices.

(G) If a soldier beam and lagging sheeting system is utilized then all parts of the system (i.e. soldier beams, bracing, wales and lagging) must be removed.

(H) There shall be no additional payment made for repairing, replacing and/or relocating City owned utilities that may be damaged and disturbed due to the Contractor's removal of sheeting operation, or for work performed by the Contractor as directed in **Subsection 40.05.7(E)** above.

#### **40.05.8 COST INCLUDED**

There shall be no separate payment for the sheeting and bracing of trenches and excavation of water mains larger than 20-inches in diameter and appurtenances thereto including valve chambers, regulator chambers, etc.; and for the sheeting and bracing of trenches and excavation of all sewer conduits and appurtenances thereto including manholes, chambers, catch basins, etc. The cost of all labor, material, plant, equipment and insurance necessary or required to furnish and install all timber and steel sheeting together with all necessary rangers, bracing, lagging, soldier beams, etc., excavation for the placing of sheeting, backfill and compaction behind sheeting to prevent loss of ground, cut off of sheeting as specified, together with all work incidental thereto, all in accordance with the plans and specifications and as directed by the Engineer, shall be deemed included in the prices bid for the respective contract items.

#### **40.05.9 SEPARATE PAYMENT**

Separate payment will be made for the sheeting of water mains 20-inches and smaller in diameter. Payment will be made in accordance with **Section 70.91**.

**(NO TEXT THIS PAGE)**

**SECTION 70.91  
SHEETING**

**70.91.1 DESCRIPTION**

This section describes the use of Sheeting in water main trenches and excavations only.

**70.91.2 MATERIALS**

All sheeting materials shall comply with **Subsection 40.05.3**.

**70.91.3 CONSTRUCTION METHODS**

To prevent injury to workmen or to avoid damaging existing water pipes, structures, and pavements and their foundations through caving or sliding of the banks of a trench or other excavation, protection shall be provided for all excavation work except where a determination is made by the Contractor, the Engineer or the Engineer's inspector at the work site that the nature of the excavation does not require protection.

Excavation protection, when required, shall be provided in accordance with the requirements of:

- (1) U.S. Occupational Safety and Health Administration (OSHA) Construction Safety and Health Regulations, Part No. 1926, Subpart P;
- (2) 23 NYCRR, Subpart 23-4 – Excavation Operations;
- (3) 16 NYCRR, Part 753 – Protection of Underground Facilities;
- (4) Special requirements detailed below.

NOTE: Whenever an interpretation difference exists as to selecting the applicable requirements, that of the most stringent one shall govern.

**(A) SPECIAL REQUIREMENTS**

Unless specifically ordered otherwise by the Engineer or the Engineer's inspector at the work site, the following Special Requirements shall be adhered to:

(a) Trenches For Water Main Pipe 12-Inch In Diameter And Less

In general, such trenches shall not be sheeted since, with the laying depths used, the trench bottoms will be less than five (5) feet below the ground surface. However, removal of existing pipe, or connections to existing pipe may, in some instances result in trench depths of five (5) feet or greater. In such cases, at a minimum, sheeting will be required. If sheeting is required, it shall be of sufficient length so that all ingress and egress is within the sheeted area, and shall extend at least 2 feet beyond all work locations and access points. If workmen are required to transit between sheeted areas, they must exit the trench.

If, in the opinion of the Engineer or the Engineer's inspector at the work site, sheeting is required, for whatever reason, in any trench or other excavation, the Contractor shall install it.

(b) Trenches For Water Main Pipe 16-Inch and 20-Inch In Diameter

All such trenches shall be sheeted, regardless of the depth of the trench.



(c) Trenches For Water Main Pipe Larger Than 20-Inch In Diameter; And Excavations For Chambers And Manholes

All such trenches shall be sheeted, regardless of the depth of the trench.

(d) Detailed Requirements As To Type And Size Of Sheeting

Unless specifically noted otherwise on the contract drawings or in these specifications, the sheeting required in paragraphs (a), (b), and (c) above, shall be furnished and installed in full compliance with the requirements of Section 1926.652 of the OSHA Regulations.

The size and spacing of sheeting, stringers, and cross bracing required for various soil conditions shall meet the latest OSHA Regulation requirements.

(B) **SUBSTITUTION FOR TIMBER SHEETING**

Any substitution for timber sheeting and bracing such as a self-supporting movable shield of timber or metal, etc., must be designed by and stamped with the seal of a Professional Engineer, licensed to practice in the State of New York, and must be approved by the Engineer in writing prior to its being used on the job. Submittal of proposed substitutions shall be made by the Contractor at least four (4) weeks prior to their scheduled use to allow for proper review and approval of it by the Engineer.

(C) **SHEETING LEFT IN PLACE**

Where the sheeting is ordered to be left in place, the full amount of the lumber so left in place will be paid for at fifty percent (50%) of the market value thereof, without any allowance for the cost of delivery or placing in the work. Sheeting left in place shall be cut off in accordance with **Subsection 40.05.2**.

When sheeting is ordered to be left in place, the cost of all work required for the cutting, removal and disposal of the cut sheeting shall be deemed included in the fifty percent (50%) compensation paid above.

**70.91.4 MEASUREMENT**

The quantity of sheeting incorporated into the work, complete, as shown, specified or required shall be computed as twice the depth of trench times the length of the sheeted trench. The depth of trench or excavation to be sheeted shall be from the ground surface to the bottom of the pipe. In those cases where a special foundation, such as a broken stone bed or a concrete cradle or mat is required, the depth of trench or excavation to be sheeted shall be from the ground surface to the bottom of such special foundation.

**70.91.5 PRICE TO COVER**

Payment for sheeting of trenches for water main pipe 12-inch in diameter and less shall be made per square foot under bid Item No. 70.91SW12 - FURNISHING AND PLACING SHEETING AND BRACING IN TRENCH FOR WATER MAIN PIPE 12-INCH IN DIAMETER AND LESS contained in the bid schedule.

Payment for sheeting of trenches for water main pipe 16-Inch and 20-inch in diameter shall be made per square foot under bid Item No. 70.91SW20 - FURNISHING AND PLACING SHEETING AND BRACING IN TRENCH FOR WATER MAIN PIPE 20-INCH IN DIAMETER contained in the bid schedule. Where there is no bid item for such sheeting, because the quantities of such pipe to be installed are very small, or the work involves connecting smaller size pipe to 16-Inch and 20-inch mains or larger, payment for such sheeting will be made at the unit price bid for Item No. 70.91SW12 - FURNISHING AND PLACING SHEETING AND BRACING IN TRENCH FOR WATER MAIN PIPE 12-INCH IN DIAMETER AND LESS.

The Contractor's attention is directed to the fact that the Contractor's bid price for sheeting covers the cost of extra earth excavation and other extra costs involved in laying the pipe, such as but not limited to, lesser pipe footage being installed per day, etc.

All of the above provisions are intended to apply to those instances where sheeting is required in a trench in order to lay pipe. In such instances a wider trench is required (to accommodate the sheeting) than when pipe is laid in unsheeted trenches.

When sheeting is provided in portions of a trench (to protect men inserting taps, etc.) that was originally excavated for laying a water main, and when such trench was not sheeted at the time the water main was laid, payment shall be made only for the amount of sheeting actually placed. In all such cases the payment lines for pavement excavation, pavement restoration, and satisfactory backfill shall be those specified for unsheeted trenches.

Where the OSHA Regulations do not require sheeting, but where the Contractor, for the Contractor's own convenience, installs a more limited type of trench support (stay bracing, etc.) such limited type of trench support will not be paid for. The cost of such limited trench support shall be deemed included in the various unit prices bid.

All sheeting that is to be paid for must meet all requirements of the OSHA Regulations.

**70.91.6 NO SEPARATE PAYMENT**

No separate payment will be made for the sheeting of water main trenches for water mains larger than 20-inches in diameter, the costs thereof shall be deemed included in the prices bid for laying these mains. No payment shall be made for sheeting at chambers and manholes, but payment thereof will be deemed to be included in the various items bid for constructing the chambers and manholes.

*Payment for Furnishing And Placing Sheeting And Bracing In Trench For Water Main Pipe will be made under the Item Number as calculated below:*

The Item Numbers for Furnishing And Placing Sheeting And Bracing In Trench For Water Main Pipe have nine characters. (The decimal point is considered a character, the third character.)

(1) The first five characters shall define Furnishing And Placing Sheeting And Bracing In Trench For Water Main Pipe:

70.91

(2) The sixth and seventh characters shall define Furnishing And Placing Sheeting And Bracing In Trench For Water Main Pipe:

SW - Furnishing And Placing Sheeting And Bracing In Trench For Water Main Pipe



(3) The eighth and ninth characters shall define the Size of Water Main Pipe That Trench Sheeting will be provided for:

12 - 12-Inch In Diameter And Less  
20 16-Inch and 20-Inch In Diameter

(4) The Item Numbers together with Description and Pay Unit as provided in the Bid Schedule are provided below:

Item No.	Description	Pay Unit
70.91SW12	FURNISHING AND PLACING SHEETING AND BRACING IN TRENCH FOR WATER MAIN PIPE 12-INCH IN DIAMETER AND LESS	S.F.
70.91SW20	FURNISHING AND PLACING SHEETING AND BRACING IN TRENCH FOR WATER MAIN PIPE 16-INCH AND 20-INCH IN DIAMETER	S.F..

**(NO TEXT THIS PAGE)**

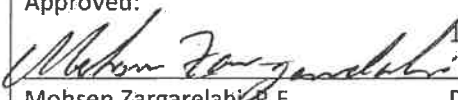
	<b>Department of Design and Construction</b>	<b>SPECIFICATION BULLETIN</b>	<b>SB</b>  <b>17-001</b>
Prepared: 	1/12/2017	Approved: 	1/12/2017
Richard Jones, P.E. CWI Director, Specifications – Infrastructure Design	Date	Mohsen Zargarelahi, P.E. Assistant Commissioner – Infrastructure Design	Date

**APPLICABILITY:**

- This Specification Bulletin (SB) is effective for projects advertised on or after 2/20/17.

**SUPERSEDEENCE:**

- This SB supersedes the following SBs: **NONE**

**ATTACHMENTS:**

- **ATTACHMENT 1:** Revised Section 50.71 - RECONSTRUCTION OF EXISTING SEWERS USING D.E.P. APPROVED CURED-IN-PLACE-PIPE (CIPP) LINING METHOD  
*Pages A1-1 through A1-9*

**REVISIONS TO THE NEW YORK CITY DEPARTMENT OF ENVIRONMENTAL PROTECTION STANDARD SEWER AND WATER MAIN SPECIFICATIONS, DATED 7/1/14:**

All references contained below are to the New York City Department of Environmental Protection Standard Sewer and Water Main Specifications, Dated July 1, 2014. Said Standard Sewer and Water Main Specifications are hereby revised as follows:

- Refer** to Pages V-52 through V-59, Section 50.71 – RECONSTRUCTION OF EXISTING SEWERS USING D.E.P. APPROVED CURED-IN-PLACE-PIPE (CIPP) LINING METHOD;  
**Delete** in its entirety the Section;  
**Substitute** the revised Section in Attachment 1 (9 pages).

**(NO TEXT THIS PAGE)**

## CURED-IN-PLACE-PIPE (CIPP) LINING METHOD

### 50.71.1 INTENT

It is the intent of this section to provide for the reconstruction of existing sewers by the installation of a resin-impregnated flexible tube that is inflated within the existing conduit to form a hard, impermeable, corrosion resistant pipe within a pipe. When cured, the cured-in-place-pipe (CIPP) will be formed to the original conduit.

### 50.71.2 REQUIREMENTS

#### (A) DESCRIPTION OF WORK

Unless otherwise specified in the contract, the Contractor shall use a Department of Environmental Protection (DEP) approved cured-in-place-pipe lining method on all existing sewers shown, specified, or ordered to be reconstructed under this contract by use of an approved lining method. All such work shall comply with the terms of this specification and with the manufacturer's standards set forth for the lining method(s) selected by the Contractor.

Under this method the Contractor shall reconstruct existing sewers by the insertion of either a flexible polyester felt or glass fiber lining tube that has been saturated with either a thermosetting or photosetting resin. The liner shall be inserted into the existing sewer either by direct inversion (ASTM F1216) using a head of water or air, or by pulling the tube into place by winching and then inflating it by inversion of a calibration hose (ASTM F1743). The thermosetting resin shall then be cured by either circulating hot water through the tube or by circulating hot air (a mixture of steam and air), or by circulating steam to cure the resin into a hard impermeable pipe. The photo-initiated resin shall be exposed to an ultraviolet light source to cure the resin into a hard impermeable pipe.

The Contractor shall make all investigations of the existing sewers to be reconstructed and shall determine and select the most effective approved lining method(s) appropriate for installation in the existing sewers to be reconstructed. The Contractor shall be responsible for the successful completion of all work required herein; failure of the Contractor's selected lining method(s) to be satisfactorily installed in the existing sewers shall not relieve the Contractor of the Contractor's responsibility to provide satisfactorily reconstructed sewers.

Any cost associated with the removal of the unsatisfactorily installed liner and the subsequent, satisfactory reinstallation of an approved liner shall be borne solely by the Contractor, and the Contractor shall not make any claim against the City for this additional required work.

Once installed, the liner shall extend from manhole to manhole in a continuous tight fitting watertight pipe-within-a-pipe, and be chemically resistant to sewage gases and materials. During the warranty period any defects that might affect the integrity or strength of the liner shall be immediately repaired or replaced by the Contractor, at the Contractor's expense, pursuant to the manufacturer's recommendations, and to the satisfaction of the Engineer.

#### (B) REFERENCE SPECIFICATIONS AND STANDARDS

The American Society for Testing and Materials Standard Specifications ASTM C581, D638, D790, D2990, D5813, F1216, F1743, and F2019, and the manufacturer's standards are hereby made a part of this specification.

#### (C) LINER SIZE AND LENGTH

The liner shall be fabricated to a size that when installed will neatly fit the internal circumference of the sewer to be lined. The liner thickness shall be designed to adequately resist all external pressures and conditions (e.g. deflection, ring bending, buckling and minimum stiffness). The length of the liner shall be

that deemed necessary to effectively span the distance and carry out the insertion and seal of the liner at the inlet and outlet manholes. The Contractor shall verify the lengths in the field before cutting the liner to length. Prior to the start of work the Contractor will be required to submit design calculations for wall thickness to the Engineer. When UV-cured liners are used, the Contractor must also submit the manufacturer's product specific data regarding the glass fiber tube, the resin and initiator cocktail system and the necessary manufacturer installation reference material detailing the type of light source and the speed in which it will be advanced to insure proper curing.

Allowance for circumferential and longitudinal stretching of the liner during installation shall be made as per the manufacturer's standards for the approved method of lining chosen. Under no circumstances shall the finished wall thickness of liner be less than six (6) millimeters in thickness.

(D) DESIGN PARAMETERS - The following design parameters shall be used in the design of pipe liners in addition to the manufacturer's standards:

(1) Ovality of Existing Pipe	2% Minimum
(2) Existing Pipe Condition	Fully Deteriorated
(3) Modulus of Soil Reaction	700-psi Minimum
(4) Factor of Safety Against Buckling	2 Minimum
(5) Allowable Deflection	5% Maximum
(6) Ratio of Pipe to Soil Strength	10% Minimum
(7) Live Load	AASHTO HS20-44 Loading under Roadways AASHTO E-80 Loading under Railroads
(8) Soil Unit Weight	120-pcf Minimum (If no Boring Data is available in vicinity.)
(9) Creep Reduction Factor	50% Maximum

(E) LINER MATERIAL - The Contractor shall furnish, prior to use of the lining materials, satisfactory written guarantee of the Contractor's compliance with the liner manufacturer's standards for all materials (polyester felt tubing, including the polyurethane covered felt and the thermosetting resin or glass fiber tubing soaked in photosetting resin) and techniques being used in the method.

Prior to the start of work the Contractor will be required to submit to the Engineer the types of resins and the resultant cure schedules for each length and size of sewer to be lined. The finished liner shall incorporate thermosetting materials that will withstand the corrosive effects of the normal existing effluents.

(F) SAFETY - The Contractor shall carry out the Contractor's operations in strict accordance with all OSHA and manufacturer's safety requirements. Emphasis shall be placed upon safety requirements for entering confined spaces and working with hot water, steam, or resins that may cause fumes. The Contractor shall erect such signs and other devices as are necessary for the safety of the work site and shall secure the site and conform all work to the safety requirements of all pertinent regulatory agencies.

(G) AIR QUALITY - The Contractor is advised that all liner installation work shall be carried out in full compliance with all City, State, and Federal laws, rules, and regulations regarding Air Quality and Safety. The contractor shall take all necessary precautions to minimize the release of styrene or other VOC emissions and mitigate odors generated during set and the CIPP lining process. The Contractor shall also take all necessary precautions to prevent such odors from entering structures, businesses or other types of establishments, through service connections or other plumbing fixtures.

(H) FLOW BYPASSING - Prior to the start of work the Contractor will be required to submit a fluming/bypass-pumping detail in accordance with **Subsection 10.13 - (3) Existing Flow**. The Contractor shall provide for the diversion of flow of existing sewers at existing upstream manholes (if available) and pump the flow into an existing downstream manhole. The pumps and bypass lines shall

be of adequate capacity and size to handle the flow. The proposed bypassing system shall be submitted to the Engineer for approval and no work shall commence until such approval is granted.

(I) TELEVISION INSPECTION PRIOR TO INSTALLATION - All bidders are advised that a digital audio-visual inspection was made of the sewers to be reconstructed and that this recording (the "DEP recording") is available for review prior to bid opening. All prospective bidders are urged to view this recording in order to assess the suitability of the lining methods for use on this project. The City of New York does not guarantee the successful use of any particular method on this project and the Contractor shall utilize the Contractor's judgment as to the effective use of the method(s) the Contractor selects.

The Contractor will also be required to perform another television inspection and digital audio-visual recording of the sewer a maximum of seven (7) days prior to the setting up of the liner insertion equipment at the site. This inspection will be performed, utilizing a radial eye camera, to determine the latest condition of the sewer and to accurately identify the location of active service connections. Should the results of this television inspection show a condition different than that shown on the DEP recording, the Contractor shall immediately notify the Engineer.

For each section to be lined, the Contractor shall certify in writing that the DEP approved method the Contractor intends to use is suitable.

(J) CLEANING - The Contractor shall furnish all labor, materials and equipment and shall do all work necessary to remove and dispose of all debris, sediment, silt, refuse, timber, roots, and materials of all kinds which can be removed by conventional non-excavation type pipe cleaning equipment located in the existing sewers and manholes. The Contractor shall immediately notify the Engineer if such debris, etc., cannot be removed by conventional non-excavation type pipe cleaning equipment.

Protruding service connections shall be removed and paid for consistent with **Section 52.51**.

(K) SERVICE CONNECTIONS - The Contractor shall be required to determine which service connections are active and shall be responsible for controlling (or maintaining) the flow for each active service connection along the line of the sewer to be rehabilitated. Where necessary, the flow from an active service connection shall be bypassed to a manhole downstream of the proposed work by means of pumping from the trap located in the basement of the affected building. However, should such bypassing be judged unfeasible by the Engineer, the Contractor shall excavate to the service connection outside the building area (sidewalk or roadway as determined by the Engineer) and bypass the connection from this point. The pump and bypass line for each service connection shall be of adequate capacity and size to handle the flow.

Prior to the commencement of any work, the Contractor shall make all necessary investigations and prepare a plan for the controlling (or maintaining) of the flow and, where necessary, for the bypassing of active service connections. This plan shall be submitted to the Engineer for approval and no work shall commence until such approval is granted.

(L) EQUIPMENT SPECIFICATION - The Contractor shall provide suitable temperature and pressure gauges in accordance with the manufacturer's standards and specifications. High-pressure steam hoses and fittings have to be rated in accordance with the steam generator used. Thermocouples are to be marked for each fluid to be conveyed: RED-steam; BLUE-water; GREEN-air. The pulling winch shall be equipped with a tension gauge (Type-Martin Decker or Approved Equal) - smooth running and variable speed. The cutting device shall be a Gulectron type or approved equal remote monitored device when used inside the lined pipe.

The Contractor shall prepare and inspect all necessary tools and any spare parts that are required for equipment that suffer frequent breakdowns, and shall ensure that said tools and spare parts are available at the site. Supporting equipment, such as pumps and generators, shall be provided at the site in the event there is a fluid surge and pumping is required on an emergency basis. The Contractor shall also prepare and make operable all necessary communication equipment for the Contractor's field crew.



(M) **INSTALLATION OF LINER** - Prior to the installation of liner, the Contractor shall fully comply with **Subsections 50.71.2(C) through 50.71.2(L)**, inclusively, and with any additional requirements set forth in the specific provisions applicable to the respective lining methods. The Contractor shall not proceed with the installation of liner until the Engineer, in writing, certifies such compliance and directs the Contractor to proceed with the lining installation. The approved liner shall be installed pursuant to the specific provisions set forth for the selected lining method. If any problem occurs during the installation operation the Contractor shall investigate with a television camera from the remote manhole.

(N) **PRELIMINARY TELEVISION INSPECTION OF INSTALLED LINER** - After the liner is sufficiently cool (below one hundred degrees Fahrenheit (100°F)) and before opening the service connections, a preliminary television inspection and digital audio-visual recording of the newly installed liner shall be performed to determine if the liner is properly installed.

(O) **SERVICE CONNECTIONS** - After the liner has been installed, the Contractor shall re-open all existing active service connections and those inactive connections ordered by the Engineer. These service connections shall be re-opened and paid for consistent with **Section 52.61**.

(P) **FINAL TELEVISION INSPECTION AFTER INSTALLATION** - A final television inspection and digital audio-visual recording of the newly lined sewer including the restored service connections shall be performed immediately after work is completed. Should the results of this final inspection reveal any defects, as determined by the Engineer, the Contractor will be required to repair or replace these defects as ordered by the Engineer at the sole expense of the Contractor.

Payment for this final television inspection will be made under Item No. 53.11DR - TELEVISION INSPECTION AND DIGITAL AUDIO-VISUAL RECORDING OF SEWERS.

(Q) **WORK SCHEDULE** - The Contractor shall be permitted to occupy the lane immediately above the sewer location and the parking lane immediately adjacent to the site of work unless otherwise specified. No further roadway or traffic restrictions shall be permitted.

### **50.71.3 INSTALLATION**

(1) **PREPARING AND INSERTING THE LINER** - The Contractor shall designate a location where the uncured resin in the original containers and the un-impregnated liner will be impregnated prior to installation. The Contractor shall allow the Engineer and/or the Engineer's representative to inspect the materials and chemical impregnation "wet out" procedure. A resin and catalyst system compatible with the requirement of this method shall be used. The quantities of the liquid thermosetting materials inserted into the lining tube shall be as per manufacturer's standards so as to fully saturate the liner material and provide the lining thickness specified. The contractor shall protect, store and handle materials during transportation and delivery, while stored on-site and during installation following Manufacturer's recommendations. Liners impregnated with thermo-initiated resins shall be stored within the proper temperature range and liners impregnated with photo-initiated resins shall not be exposed to UV-light sources, to insure no premature curing occurs.

Prior to installation of liner, the downstream sewer manhole adjacent to the sewer section to be lined shall be plugged.

The chemical impregnated liner material shall be inserted into the sewer line being reconstructed through the existing manhole by either the direct inversion method or by the pull-in-place method, as recommended by the manufacturer. The head used to extend the liner tube shall be sufficient enough to fully extend the tube both circumferentially and longitudinally. The head used will fall within the manufacturer's guidelines to insure that a proper finished thickness is achieved and that the liner fit snug to the existing pipe wall producing dimples at service connections and flared ends at the entrance and exit manholes.

Winch cable shall be equipped with a tension gauge to measure tension during pull through.

Inflation of liners and heat source method used shall be accomplished in accordance with manufacturer's standards and specifications.

Curing temperatures and pressures shall be monitored so as not to overstress the liner and cause damage or failure of the liner prior to cure.

The use of a lubricant is recommended and such lubricant shall be compatible with liner and resin.

The Contractor will be required to monitor and remove styrene to acceptable levels during the inflation and curing processes. An activated carbon filtration system shall be employed to remove styrene from both the process air flow and condensed steam, prior to release into the air or an adjacent or downstream sanitary or combined sewer manhole.

(2) **CURING OF LINER** - After inflation or inversion is completed, the Contractor shall supply a suitable heat source. The equipment shall be capable of delivering steam or hot water to the far end of the liner to uniformly raise the temperature in the entire liner above the temperature required to initiate and effect curing of the resin system. The temperature shall be determined by the resin/catalyst system employed. The heat source shall be fitted with suitable monitors to gauge the temperature and pressure of the incoming and outgoing heat exchanger circulating heating medium. Thermocouples shall be placed between the liner and the invert at each manhole so as to determine and record the temperature of the liner and time of exotherm. Initial cure shall be deemed to be completed when inspection of the exposed portions of the liner show it to be hard and sound; and when temperature reading(s) at the interface of the liner with the host pipe indicate sufficient heating has occurred. The cure period shall be of a duration recommended by the resin manufacturer; modified for the site specific conditions at the time curing is affected. During this cure time, the temperature inside the liner will be continuously maintained in the range required.

Once the cure is complete, the Contractor shall cool the hardened liner to a temperature below one hundred degrees Fahrenheit (100°F) before relieving the internal pressure. Cool down shall be accomplished as recommended by the manufacturer. Care shall be taken in the release of the internal pressure so that a vacuum will not develop that could damage the newly installed liner.

For UV-light CIPP systems, the intensity and duration of exposure to the photo-initiator's required UV-light wavelength shall be as per the manufacturer's recommendations for the proposed size and thickness of tube, to insure that the liner has been cured completely. The UV-light source shall be fitted with multiple temperature sensors to insure that reaction temperatures stay within the Manufacturer's acceptable range and do not blister the interior liner. All lamps shall be monitored to insure that they are on and functioning properly. In the event that a lamp fails or the reaction temperatures fall below the Manufacturer's acceptable range during CIPP installation, the Contractor shall reduce the speed of the light source (increasing the exposure duration) by the Manufacturer's specified amount. The Manufacturer's recommended cooling phase shall be observed after the last lamp of the light source has been turned off. The finished lining shall be continuous over the entire length and be free from visual defects such as foreign inclusions, dry spots, pinholes and delamination. The lining shall be impervious and free of any leakage from the pipe to the surrounding ground or from the ground to the inside of the lined pipe.

If due to broken or misaligned pipe at the access manhole, the lining fails to make a tight seal, the Contractor shall apply a seal of a resin mixture compatible with the liner.

After the curing has been completed, any residual water and condensation that adheres to the inner wall of the liner shall be removed. This residual water shall be collected and pumped from the channel of the downstream manhole and circulated through a separate carbon filtration unit before discharge into a downstream sanitary or combined sewer manhole. In the case of lining a storm sewer section, the collected filtered residual water and process water shall not be discharged into the downstream manhole or stream, but discharged into a nearby sanitary manhole.

#### 50.71.4 MEASUREMENT

The quantity to be measured for payment shall be the length of reconstructed sewer, accepted by the Engineer, measured horizontally along the centerline of the sewer from inside face of manhole to inside face of manhole.

#### 50.71.5 PRICE TO COVER

The contract price for "RECONSTRUCTION OF EXISTING SEWERS, USING D.E.P. APPROVED CIPP LINING METHOD" shall be the unit price bid per linear foot for each size sewer reconstructed by a cured-in-place-pipe DEP approved lining method and shall cover the cost of all labor, materials, plant, equipment, samples, tests and insurance required or necessary to reconstruct the sewers of the sizes shown including the cleaning of the existing sewers using conventional non-excavation type pipe cleaning equipment; television inspection prior to installation; diversion of flow of existing sewers; controlling (or maintaining) the flow for all active service connections; necessary bypassing and pumping of the existing active service connections; repair of active service connections; all necessary excavation, backfilling and compaction; complete installation of the liner; preliminary television inspection of installed liner; temporary and permanent restoration of all disturbed sidewalk and pavement areas (unless items for temporary and permanent restoration are otherwise provided in the Bid Schedule); cleaning up; and furnishing and installing all other items necessary to complete this work and do all work incidental thereto, all in accordance with the plans and specifications and as directed by the Engineer.

#### 50.71.6 SEPARATE PAYMENT

Payment for this final television inspection will be made under Item No. 53.11DR - TELEVISION INSPECTION AND DIGITAL AUDIO-VISUAL RECORDING OF SEWERS.

*Payment for Reconstruction Of Existing Sewers Using D.E.P. Approved Cured-In-Place-Pipe (CIPP) Lining Method will be made under the Item Number as calculated below:*

The Item Numbers for Reconstruction Of Existing Sewers Using D.E.P. Approved Cured-In-Place-Pipe (CIPP) Lining Method have eleven characters. (The decimal point is considered a character, the third character.)

(1) The first five characters shall define Reconstruction Of Existing Sewers Using D.E.P. Approved Cured-In-Place-Pipe (CIPP) Lining Method:  
50.71

(2) The sixth character shall define the Type of Sewer Effluent:  
S - Sanitary Sewer  
M - Storm Sewer  
C - Combined Sewer  
I - Interceptor Sewer

(3) The seventh and eighth characters shall define either the Diameter of the Sewer for Existing Circular Sewers or the Width of the Sewer for Existing Horizontal Elliptical Sewers, Vertical Elliptical Sewers and Egg-Shaped Sewers. (The seventh and eighth characters representing the unit of inches for either the Diameter of the Sewer for Existing Circular Sewers or the Width of the Sewer for Existing Horizontal Elliptical Sewers, Vertical Elliptical Sewers and Egg-Shaped Sewers.) See examples below:

10 - 10"  
30 - 30"

(4) The ninth character shall define the Shape of the Existing Sewer:  
D - Circular (Diameter)

H - Horizontal Elliptical  
V - Vertical Elliptical  
E - Egg-Shaped  
R - Rectangular

(5) The tenth and eleventh characters shall define either Circular or the Height of the Sewer for Existing Horizontal Elliptical Sewers, Vertical Elliptical Sewers and Egg-Shaped Sewers. (The tenth and eleventh characters representing either Circular or the unit of inches for the Height of the Sewer for Existing Horizontal Elliptical Sewers, Vertical Elliptical Sewers and Egg-Shaped Sewers.) See examples below:

00 - Circular  
19 - 19"  
32 - 32"

(6) Examples of Item Numbers together with Description and Pay Unit as provided in the Bid Schedule are provided below:

Item No.	Description	Pay Unit
50.71S10D00	RECONSTRUCTION OF EXISTING 10" DIAMETER CIRCULAR SANITARY SEWER, USING D.E.P. APPROVED CIPP LINING METHOD	L.F.
50.71S12D00	RECONSTRUCTION OF EXISTING 12" DIAMETER CIRCULAR SANITARY SEWER, USING D.E.P. APPROVED CIPP LINING METHOD	L.F.
50.71S18D00	RECONSTRUCTION OF EXISTING 18" DIAMETER CIRCULAR SANITARY SEWER, USING D.E.P. APPROVED CIPP LINING METHOD	L.F.
50.71S24D00	RECONSTRUCTION OF EXISTING 24" DIAMETER CIRCULAR SANITARY SEWER, USING D.E.P. APPROVED CIPP LINING METHOD	L.F.
50.71S23H14	RECONSTRUCTION OF EXISTING 23"W X 14"H HORIZONTAL ELLIPTICAL SANITARY SEWER, USING D.E.P. APPROVED CIPP LINING METHOD	L.F.
50.71S30H19	RECONSTRUCTION OF EXISTING 30"W X 19"H HORIZONTAL ELLIPTICAL SANITARY SEWER, USING D.E.P. APPROVED CIPP LINING METHOD	L.F.
50.71S14V23	RECONSTRUCTION OF EXISTING 14"W X 23"H VERTICAL ELLIPTICAL SANITARY SEWER, USING D.E.P. APPROVED CIPP LINING METHOD	L.F.
50.71S19V30	RECONSTRUCTION OF EXISTING 19"W X 30"H VERTICAL ELLIPTICAL SANITARY SEWER, USING D.E.P. APPROVED CIPP LINING METHOD	L.F.
50.71S20E29	RECONSTRUCTION OF EXISTING 20"W X 29"H EGG-SHAPED SANITARY SEWER, USING D.E.P. APPROVED CIPP LINING METHOD	L.F.
50.71S24E42	RECONSTRUCTION OF EXISTING 24"W X 42"H EGG-SHAPED SANITARY SEWER, USING D.E.P. APPROVED CIPP LINING METHOD	L.F.
50.71S25E37	RECONSTRUCTION OF EXISTING 25"W X 37"H EGG-SHAPED SANITARY SEWER, USING D.E.P. APPROVED CIPP LINING METHOD	L.F.
50.71S29E40	RECONSTRUCTION OF EXISTING 29"W X 40"H EGG-SHAPED SANITARY SEWER, USING D.E.P. APPROVED CIPP LINING METHOD	L.F.
50.71M15D00	RECONSTRUCTION OF EXISTING 15" DIAMETER CIRCULAR STORM SEWER, USING D.E.P. APPROVED CIPP LINING METHOD	L.F.
50.71M18D00	RECONSTRUCTION OF EXISTING 18" DIAMETER CIRCULAR STORM SEWER, USING D.E.P. APPROVED CIPP LINING METHOD	L.F.
50.71M30D00	RECONSTRUCTION OF EXISTING 30" DIAMETER CIRCULAR STORM SEWER, USING D.E.P. APPROVED CIPP LINING METHOD	L.F.
50.71M42D00	RECONSTRUCTION OF EXISTING 42" DIAMETER CIRCULAR STORM SEWER, USING D.E.P. APPROVED CIPP LINING METHOD	L.F.
50.71M38H24	RECONSTRUCTION OF EXISTING 38"W X 24"H HORIZONTAL ELLIPTICAL STORM SEWER, USING D.E.P. APPROVED CIPP LINING METHOD	L.F.

50.71M53H34	RECONSTRUCTION OF EXISTING 53"W X 34"H HORIZONTAL ELLIPTICAL STORM SEWER, USING D.E.P. APPROVED CIPP LINING METHOD	L.F.
50.71M24V38	RECONSTRUCTION OF EXISTING 24"W X 38"H VERTICAL ELLIPTICAL STORM SEWER, USING D.E.P. APPROVED CIPP LINING METHOD	L.F.
50.71M32V48	RECONSTRUCTION OF EXISTING 32"W X 48"H VERTICAL ELLIPTICAL STORM SEWER, USING D.E.P. APPROVED CIPP LINING METHOD	L.F.
50.71M34V53	RECONSTRUCTION OF EXISTING 34"W X 53"H VERTICAL ELLIPTICAL STORM SEWER, USING D.E.P. APPROVED CIPP LINING METHOD	L.F.
50.71M30E45	RECONSTRUCTION OF EXISTING 30"W X 45"H EGG-SHAPED STORM SEWER, USING D.E.P. APPROVED CIPP LINING METHOD	L.F.
50.71M33E48	RECONSTRUCTION OF EXISTING 33"W X 48"H EGG-SHAPED STORM SEWER, USING D.E.P. APPROVED CIPP LINING METHOD	L.F.
50.71M35E52	RECONSTRUCTION OF EXISTING 35"W X 52"H EGG-SHAPED STORM SEWER, USING D.E.P. APPROVED CIPP LINING METHOD	L.F.
50.71M40E53	RECONSTRUCTION OF EXISTING 40"W X 53"H EGG-SHAPED STORM SEWER, USING D.E.P. APPROVED CIPP LINING METHOD	L.F.
50.71M24R36	RECONSTRUCTION OF EXISTING 24"W X 36"H RECTANGULAR STORM SEWER, USING D.E.P. APPROVED CIPP LINING METHOD	L.F.
50.71M32R48	RECONSTRUCTION OF EXISTING 32"W X 48"H RECTANGULAR STORM SEWER, USING D.E.P. APPROVED CIPP LINING METHOD	L.F.
50.71C16D00	RECONSTRUCTION OF EXISTING 16" DIAMETER CIRCULAR COMBINED SEWER, USING D.E.P. APPROVED CIPP LINING METHOD	L.F.
50.71C24D00	RECONSTRUCTION OF EXISTING 24" DIAMETER CIRCULAR COMBINED SEWER, USING D.E.P. APPROVED CIPP LINING METHOD	L.F.
50.71C36D00	RECONSTRUCTION OF EXISTING 36" DIAMETER CIRCULAR COMBINED SEWER, USING D.E.P. APPROVED CIPP LINING METHOD	L.F.
50.71C48D00	RECONSTRUCTION OF EXISTING 48" DIAMETER CIRCULAR COMBINED SEWER, USING D.E.P. APPROVED CIPP LINING METHOD	L.F.
50.71C45H29	RECONSTRUCTION OF EXISTING 45"W X 29"H HORIZONTAL ELLIPTICAL COMBINED SEWER, USING D.E.P. APPROVED CIPP LINING METHOD	L.F.
50.71C60H38	RECONSTRUCTION OF EXISTING 60"W X 38"H HORIZONTAL ELLIPTICAL COMBINED SEWER, USING D.E.P. APPROVED CIPP LINING METHOD	L.F.
50.71C29V45	RECONSTRUCTION OF EXISTING 29"W X 45"H VERTICAL ELLIPTICAL COMBINED SEWER, USING D.E.P. APPROVED CIPP LINING METHOD	L.F.
50.71C34V53	RECONSTRUCTION OF EXISTING 34"W X 53"H VERTICAL ELLIPTICAL COMBINED SEWER, USING D.E.P. APPROVED CIPP LINING METHOD	L.F.
50.71C38V60	RECONSTRUCTION OF EXISTING 38"W X 60"H VERTICAL ELLIPTICAL COMBINED SEWER, USING D.E.P. APPROVED CIPP LINING METHOD	L.F.
50.71C32E44	RECONSTRUCTION OF EXISTING 32"W X 44"H EGG-SHAPED COMBINED SEWER, USING D.E.P. APPROVED CIPP LINING METHOD	L.F.
50.71C34E46	RECONSTRUCTION OF EXISTING 34"W X 46"H EGG-SHAPED COMBINED SEWER, USING D.E.P. APPROVED CIPP LINING METHOD	L.F.
50.71C38E50	RECONSTRUCTION OF EXISTING 38"W X 50"H EGG-SHAPED COMBINED SEWER, USING D.E.P. APPROVED CIPP LINING METHOD	L.F.
50.71C41E60	RECONSTRUCTION OF EXISTING 41"W X 60"H EGG-SHAPED COMBINED SEWER, USING D.E.P. APPROVED CIPP LINING METHOD	L.F.
50.71C42E56	RECONSTRUCTION OF EXISTING 42"W X 56"H EGG-SHAPED COMBINED SEWER, USING D.E.P. APPROVED CIPP LINING METHOD	L.F.
50.71C30R42	RECONSTRUCTION OF EXISTING 30"W X 42"H RECTANGULAR COMBINED SEWER, USING D.E.P. APPROVED CIPP LINING METHOD	L.F.
50.71C36R48	RECONSTRUCTION OF EXISTING 36"W X 48"H RECTANGULAR COMBINED SEWER, USING D.E.P. APPROVED CIPP LINING METHOD	L.F.
50.71I36D00	RECONSTRUCTION OF EXISTING 36" DIAMETER CIRCULAR	L.F.

50.71148D00	INTERCEPTOR SEWER, USING D.E.P. APPROVED CIPP LINING METHOD RECONSTRUCTION OF EXISTING 48" DIAMETER CIRCULAR INTERCEPTOR SEWER, USING D.E.P. APPROVED CIPP LINING METHOD	L.F.
50.71136R48	RECONSTRUCTION OF EXISTING 36"W X 48"H RECTANGULAR INTERCEPTOR SEWER, USING D.E.P. APPROVED CIPP LINING METHOD	L.F.

**(NO TEXT THIS PAGE)**

	<b>Department of Design and Construction</b>	<b>SPECIFICATION BULLETIN</b>	<b>SB</b>  17-002
Prepared: 	1/12/2017	Approved: 	1/12/2017
Richard Jones, P.E. CWI Director, Specifications – Infrastructure Design	Date	Mohsen Zargarelahi, P.E. Assistant Commissioner – Infrastructure Design	Date

**APPLICABILITY:**

- This Specification Bulletin (SB) is effective for projects advertised on or after 2/20/17.

**SUPERSEDEANCE:**

- This SB supersedes the following SBs: NONE

**ATTACHMENTS:**

- **ATTACHMENT 1:** Revised Section 7.88 – Rodent and Waterbug Pest Control  
*Pages A1-1 through A1-6*

**REVISIONS TO THE NEW YORK CITY DEPARTMENT OF TRANSPORTATION  
STANDARD HIGHWAY SPECIFICATIONS VOLUME 1 OF 2, DATED 8/1/15:**

*No Changes.*

**REVISIONS TO THE NEW YORK CITY DEPARTMENT OF TRANSPORTATION  
STANDARD HIGHWAY SPECIFICATIONS VOLUME 2 OF 2, DATED 8/1/15:**

All references contained below are to the New York City Department of Transportation Standard Highway Specifications, Dated August 1, 2015. Said Standard Highway Specifications are hereby revised as follows:

- a) **Refer** to Pages 515 through 520, Section 7.88 – Rodent and Waterbug Pest Control;  
**Delete** in its entirety the Section;  
**Substitute** the revised Section in Attachment 1 (6 pages).



**(NO TEXT THIS PAGE)**

## SECTION 7.88 - Rodent and Waterbug Pest Control

**7.88.1. DESCRIPTION.** The Contractor shall provide all labor, materials, plant and equipment, and incidentals required to survey and monitor rodent activity and control any infestation or outbreak of rodents and waterbugs (cockroaches) within the project limit.

New York City ("NYC") Local Law 37 of 2005 requires that the Contractor, or any subcontractor that the Contractor hires, shall comply with Chapter 12 of Title 17 of the NYC Administrative Code with respect to the application of pesticides to any property owned or leased by the City of New York..

**7.88.2. MATERIALS.** All materials shall be Registered by the New York State Department of Environmental Conservation ("NYSDEC") and comply with the NYC Health Code for the intended usage. Materials classified as Toxicity Category I, carcinogenic to humans by the US Environmental Protection Agency ("USEPA"), or classified as a developmental toxin by the State of California's Office of Environmental Health Hazard Assessment shall not be used. The Contractor shall verify that materials are:

- "NOT PROHIBITED" by the NYC Department of Health and Mental Hygiene ("NYC-DOHMH") using the NYC-DOHMH's Pesticide Product Search, available at: < <https://a816-healthpsi.nyc.gov/1137/ProductTestPesticide.aspx> >.
- On the NYSDEC's list of Currently Registered Pesticides, available at: < <http://pims.psur.cornell.edu/> >.

Rodenticide weatherproof (wax based) bait blocks shall be multiple dose anticoagulants such as Chlorophacinone, or single feed anticoagulants such as Brodifacoum (Weatherblok XT, Final All-Weather Blox), Bromadiolone (Contract Blox), or an approved equivalent, registered by NYSDEC and not prohibited by NYC-DOHMH. Loose rodenticide meal or rodenticide pellet bait shall not be used.

Tamper proof bait station boxes shall be designed to exclude other mammals and shall be used with poisoned bait to attract rats. Information on "tamper proof bait station boxes" is available from the NYC-DOHMH Office of Pest Control Services (646-632-6600).

Live traps shall be of proper dimensions for trapping rats and mice, and shall not be used with poisoned bait.

Insecticide bait shall be a residual type registered by NYSDEC and not prohibited by NYC-DOHMH.

### (A) SUBMITTALS

Prior to commencement of construction activities the Contractor shall submit to the Engineer manufacturer's installation instructions for all materials required for rodent and waterbug pest control work and product data which shall include illustrations, catalog data, pesticide labels, product characteristics, typical use, performance and limitation criteria of all rodent and waterbug pest control materials required. All pesticides and rodenticide submittals shall be accompanied by a printout from the NYC-DOHMH Pesticide Product Search showing that the specific brand of pesticide and rodenticide is "NOT PROHIBITED."

**7.88.3. PERSONNEL.** The Contractor shall employ two independent licensed exterminators: one to engage in survey and monitoring work to establish the level of infestation of rodents and insects and provide recommendations for specific Integrated Pest Management ("IPM") actions, and one to execute the rodent and waterbug pest control work to deal with such infestations. All pest control personnel employed by each exterminator company shall be licensed by NYSDEC as a Commercial Pesticide Applicator, Commercial Pesticide Technician or Commercial Pesticide Apprentice and must be supervised by an exterminator licensed by NYSDEC as a Commercial Applicator in categories 7A ("Structural & Rodent Control") & 8 ("Public Health Pest Control"). It is recommended (but not required) that all personnel engaged in survey and monitoring work or rodent control work possess a certificate of

completion from the NYC-DOHMH's half-day or three-day "Rodent Academy." The Contractor shall submit the names and license credentials of the two exterminator companies to the Engineer for approval prior to the commencement of any work under this section.

**7.88.4. METHODS.** Application and dosage of all materials shall be done in strict compliance with the manufacturer's recommendations. All surveying, monitoring, baiting, and/or live trapping work shall be performed in the presence of the Engineer, without which no payment will be made under this Section.

(A) GENERAL

The Contractor's construction activity is expected to disturb any established rodent and/or waterbug population that may exist within the project limits, possibly causing their dispersion. The Contractor shall take all appropriate action to eliminate and/or control these populations within the construction corridor: the construction corridor shall be defined as being the full width of streets under the contract and intersecting streets up to the limits of construction, from property line to property line, excluding buildings and under sidewalk building vaults.

Under the Maintenance of Site requirements for the contract, any unsanitary conditions, such as uncollected garbage or debris, resulting from the Contractor's activities which will provide food and shelter to the resident rodent population shall be corrected by the Contractor immediately after notification of such condition by the Engineer. Non-compliance shall be subject to the application of the "Nonconformance" provisions of the Item for Maintenance of Site, and no payment will be made for any additional application of rodenticide or insecticide needed to control resultant infestations.

(B) SURVEY AND MONITORING WORK

(1) Prior to Construction - The Contractor's designated survey and monitoring exterminator shall execute a survey of the project area and estimate the level of rodent (Norway rat, House mouse) infestation and the waterbug population within the construction corridor. An appropriate sample of utility manholes (sewer, electrical, telephone, etc.) and catch basins should be opened and surveyed to the satisfaction of the Engineer. Contractor shall maintain all survey records in the manner described in 7.88.6., Records and Reports.

(2) During Construction - The Contractor shall monitor the rodent activity through trapping (snap, glue traps or live traps), fecal count methods, and inspection of the conditions of all installed baits every week during construction activity or as otherwise directed by the Engineer. Monitoring during construction shall cover Contractor's plant and temporary facilities. Contractor shall maintain all monitoring records in the manner described in Section 7.88.6. on "Records and Reports" of this specification.

(C) RODENT CONTROL WORK

(1) Wetlands, Woodlands and Areas Within Seventy-five (75') feet of a Stream. In wetlands, woodlands and areas adjacent to a stream, special precautions must be taken to protect water quality and to ensure the safety of other wildlife. To prevent poisoned bait from entering streams, no poisoned bait shall be used in areas within seventy-five (75') feet of either streambank. Live traps must be used in these seventy-five (75') feet buffer zone areas and within wetland and woodland areas.

(2) Outside Wetland Areas, Woodland Areas and Beyond Seventy-five (75') feet of a Stream. In areas outside the seventy-five foot zone of protection adjacent to streams, and areas outside wetlands and woodlands, tamper proof bait stations with poisoned bait shall be established during the period of construction and any consumed or decomposed bait shall be replenished as directed.

Rodent control shall be achieved in two stages as follows:

- Stage I. At least one month prior to initiation of the construction work, and periodically thereafter, live traps and/or rodenticide bait, as directed above, shall be placed at locations [e.g., burrows, utility manholes (sewer, electrical, phone, etc.), and catch basins] that are inaccessible to pets, human beings, children and other non-target species, particularly wildlife (e.g., birds) in the construction corridor. Locations of initial bait placement and quantities of bait shall be determined by the survey and monitoring exterminator's written report of his survey and monitoring results, or as otherwise directed by the Engineer.
- Stage II. During Construction - Infested sites as determined by the survey and monitoring exterminator's monitoring report shall be baited and/or rebaited, and live traps shall be collected and replaced, the rates and quantities of which shall be determined by the written monitoring reports submitted weekly or as otherwise directed by the Engineer in consultation with the City's Office of Pest Control.

Bait may be placed in dry manholes without a tamper-proof bait station box, if the manhole configuration does not permit the use of a bait station box. If a sanitary sewer manhole has a concrete invert platform of sufficient size, a bait box shall be used. Bait placed in a manhole outside of a tamper-proof box shall be strung on a stainless-steel wire, and secured to the manhole structure. No separate payment shall be made for the wire or securing the wire to the manhole, and shall be deemed included in the bid price for Baiting of Rodent Base Stations. Rodent control personnel entering manholes shall comply with the confined space requirements required by the Occupational Safety and Health Administration ("OSHA") 29 CFR 1929 - Subpart AA – Confined Spaces in Construction.

The use of tamper proof bait station boxes shall be used with rodenticide in all other cases.

The baiting exterminator shall be responsible for collecting and disposing of all trapped and poisoned rodents found in live traps and tamper proof bait stations. Non-target species captured in live traps shall be released by the baiting exterminator within twenty-four (24) hours after notification by the Engineer. The baiting exterminator shall also be responsible for posting and maintaining signs announcing the baiting of each particular location. The signs shall be placed at least twenty-four (24) hours prior to the application of any pesticide or rodenticide, and shall meet the requirements of Local Law 37 of 2005. NYC-DOHMH provides a sample template sign for pesticide notification purposes in compliance with the law at:  
< <http://www1.nyc.gov/assets/doh/downloads/pdf/pesticide/notification-sign.pdf> >.

The Contractor, under his maintenance of site operations, shall be responsible for the immediate collection and disposal of any visible rodent remains found on streets or sidewalk within the project limits. Any visible remains shall be placed into double plastic bags. No more than five (5) carcasses shall be placed into each bag. Each bag shall be a minimum of three (3) mils thick, black plastic. The bag shall have a note taped on with the contents (e.g., "dead rat"), and disposed as required by the NYC Department of Sanitation. No additional payment will be made for this work.

It is anticipated that public complaints will be addressed to the Engineer's Field Office. The Contractor, where directed by the Engineer, shall take appropriate Integrated Pest Management ("IPM") actions, such as baiting, trapping, proofing, etc., to remedy the source of a complaint within the next six (6) hours of normal working time, which is defined herein, for the purposes of this section, as 7 A.M. to 6 P.M. on Mondays through Saturdays.

(D) WATERBUG CONTROL

Waterbugs shall include American Cockroaches, Oriental Cockroaches, Smoky Brown Cockroaches, Madeira Cockroaches, and other similar species.

Infested sites (e.g., sewers) shall be baited at least two (2) times per month with insecticides, or as directed by the Engineer in consultation with the exterminator monitoring the work and the NYC-DOHMH Office of Pest Control Services.

**7.88.5. EDUCATION & TRAINING.** The Contractor shall post notices in all Construction Bulletin Boards advising workers, employees, and residents to call the Engineer's Field Office to report rodent and waterbug infestations. The Contractor shall provide and distribute literature pertaining to IPM techniques of rodent control to affected businesses and superintendents of nearby residential buildings to ensure their participation in maintaining their establishments free of unsanitary conditions, harborage removal and rodent proofing.

Prior to application of any chemicals, the Contractor shall furnish copies or sample labels for each pesticide, antidote information and Material Data Safety Sheets ("MSDS") for each chemical used.

**7.88.6. RECORDS AND REPORTS.**

(A) GENERAL

The Contractor shall be responsible for assigning within the construction corridor an identifying number to each manhole, catch basin, and other location where bait and/or live trap placement and/or waterbug control work is proposed by the survey and monitoring exterminator. The Contractor shall then provide that list of locations and corresponding reference numbers along with a drawing showing the locations, as a reference for the exterminator(s) performing the work, to indicate locations of bait placement and waterbug control work and rodent and waterbug activity (droppings, bait consumed, dead rodents, etc.)

(B) SURVEY AND MONITORING WORK

(1) Prior to Construction – Contractor shall submit to the Engineer, for approval, a written survey report including proposed IPM procedures, including specific materials, quantities, locations, methods and time schedule for the implementation of the exterminating work. The written report shall also include a survey with a drawing (provided by the Contractor) marked with locations indicating all signs of rodent (Norway rat, House mouse) infestation and waterbug activity discovered during the execution of the survey indicating that rodent and waterbug pest control work is necessary. The report will be developed with input from the NYC-DOHMH Rat Information Portal at: < [http://maps.nyc.gov/doit/nycitymap/template/?applicationName=DOH\\_RIP](http://maps.nyc.gov/doit/nycitymap/template/?applicationName=DOH_RIP) >.

(2) During Construction - Based on monitoring results, Contractor shall submit to the Engineer a weekly written monitoring report identifying all locations and conditions of installed bait and/or other rodent control work. The monitoring report shall also include any other recommended IPM techniques, such as baiting, trapping, proofing, etc., proposed for rodent and waterbug pest control.

The survey and monitoring exterminator shall keep a record of all rodent and waterbug infestation surveys s/he has conducted. The Contractor shall be required to submit a copy of all survey and monitoring reports to the Engineer each week, prior to payment.

(C) RODENT AND WATERBUG CONTROL WORK

The baiting exterminator shall maintain records using the NYC Pesticide Use Reporting System ("NYCPURS"). These records will be kept by the Engineer. A weekly report from NYCPURS shall be prepared, signed and certified by the approved licensed exterminator, and such reports shall be submitted to the Engineer each week, prior to payment.

**7.88.7. NONCONFORMANCE.** If the Contractor fails to perform as directed to control the rodent and/or waterbug population at any location within the project limits for a period of more than one week, the Engineer will correct the adverse conditions by any means he deems appropriate, including but not limited to, the use of "outside services" and shall deduct the cost of the corrective work from any monies due to the Contractor. The deducted cost of this work shall be in addition to the non-payment for rodent and waterbug pest control.

**7.88.8. MEASUREMENT.**

(A) RODENT INFESTATION SURVEY AND MONITORING

The quantity to be measured for payment under Item No. 7.88 AA, RODENT INFESTATION SURVEY AND MONITORING, shall be a Lump Sum measurement.

(B) RODENT BAIT STATIONS

The quantity to be measured for payment under Item No. 7.88 AB, RODENT BAIT STATIONS, shall be the number of tamper-proof rodent bait station boxes and/or live traps satisfactorily installed or reinstalled after inspection within the construction corridor, as approved by the Engineer. However, the initial baiting, and subsequent rebaiting as may be required, of any bait station will be paid for under Item No. 7.88 AC.

(C) BAITING OF RODENT BAIT STATIONS

The quantity to be measured for payment under Item No. 7.88 AC, BAITING OF RODENT BAIT STATIONS, shall be the number of tamper-proof rodent bait station boxes, utility manholes, catch basins, or other locations approved by the Engineer, satisfactorily baited or rebaited to replenish consumed or decomposed bait within the construction corridor, as approved by the Engineer.

(D) WATERBUG BAIT APPLICATION

The quantity to be measured for payment under Item No. 7.88 AD, WATERBUG BAIT APPLICATIONS, shall be the number of blocks satisfactorily treated with insecticide bait within the construction corridor, as approved by the Engineer. A block shall be defined as the area of street, measured between property lines, from intersection to intersection. Each rebaiting of any block shall be considered as a new block for measurement purposes.

**7.88.9. PRICES TO COVER.**

(A) RODENT INFESTATION SURVEY AND MONITORING

Payment will be made at the lump sum price bid for RODENT INFESTATION SURVEY AND MONITORING which shall include the cost of furnishing all the labor, materials, plant, equipment (traps, etc.), insurance, and other incidentals required, including but not limited to providing all required maintenance of traffic equipment, to perform a rodent infestation survey of the project area and then monitor the site each week for rodent activity, all in accordance with the specifications and the directions of the Engineer.

Ten (10%) percent of the lump sum price bid will be paid when the initial survey of the project area has been completed and the written survey report has been submitted to the satisfaction of the Engineer. The remainder will be paid in proportion to the percentage of contract completion.

(B) RODENT BAIT STATIONS

The Contract price bid for RODENT BAIT STATIONS shall be a unit price per each tamper proof bait station box and/ or live trap installed or reinstalled after inspection and shall cover the cost of furnishing

all labor, materials, plant, equipment (bait stations, etc.), insurance, and other incidentals, including but not limited to providing all required maintenance of traffic equipment, required to control the rodent population found within the project limits in accordance with the specifications and the directions of the Engineer.

In addition to the payment for Rodent Bait Stations installed or reinstalled under this Item No. 7.88 AB, the Contractor will also be paid for each baiting or rebaiting, when required, of each bait station, under Item No. 7.88 AC.

(C) BAITING OF RODENT BAIT STATIONS

The Contract price bid for BAITING OF RODENT BAIT STATIONS shall be a unit price per each bait station, utility manhole, catch basin or other location approved by the Engineer satisfactorily baited or rebaited, when required, and shall cover the cost of furnishing all labor, materials, plant, equipment (bait), insurance, NYCPURS recordkeeping, and other incidentals, in accordance with the specifications and directions of the Engineer. Installation or resetting of the bait station will be paid for under Item No. 7.88 AB.

(D) WATERBUG BAIT APPLICATION

The Contract price bid for WATERBUG BAIT APPLICATION shall be a unit price per block treated by the exterminator and shall include the cost of furnishing all the labor, materials, plant, equipment (bait, etc.), insurance, NYCPURS recordkeeping, and other incidentals, including but not limited to providing all required maintenance of traffic equipment, necessary to control the waterbug population found within the project limits for the duration of the contract in accordance with the specifications and the directions of the Engineer.

*Payment will be made under:*

Item No.	Item	Pay Unit
7.88 AA	RODENT INFESTATION SURVEY AND MONITORING	L.S.
7.88 AB	RODENT BAIT STATIONS	EACH
7.88 AC	BAITING OF RODENT BAIT STATIONS	EACH
7.88 AD	WATERBUG BAIT APPLICATION	BLOCK

	<b>Department of Design and Construction</b>	<b>SPECIFICATION BULLETIN</b>	<b>SB</b> 17-003
Prepared: 	1/12/2017	Approved: 	1/12/2017
Richard Jones, P.E. CWI Director, Specifications – Infrastructure Design	Date	Mohsen Zargarelahi, P.E. Assistant Commissioner – Infrastructure Design	Date

**APPLICABILITY:**

- This Specification Bulletin (SB) is effective for projects advertised on or after 2/20/17.

**SUPERSEDEANCE:**

- This SB supersedes the following SBs: **NONE**

**ATTACHMENTS:**

- **ATTACHMENT 1:** Revised Section 6.40 – Engineer's Field Office  
*Pages A1-1 through A1-7*

**REVISIONS TO THE NEW YORK CITY DEPARTMENT OF TRANSPORTATION  
STANDARD HIGHWAY SPECIFICATIONS VOLUME 1 OF 2, DATED 8/1/15:**

*No Changes.*

**REVISIONS TO THE NEW YORK CITY DEPARTMENT OF TRANSPORTATION  
STANDARD HIGHWAY SPECIFICATIONS VOLUME 2 OF 2, DATED 8/1/15:**

All references contained below are to the New York City Department of Transportation Standard Highway Specifications, Dated August 1, 2015. Said Standard Highway Specifications are hereby revised as follows:

- a) **Refer** to Pages 372 through 379, Section 6.40 – Engineer's Field Office;  
**Delete** in its entirety the Section;  
**Substitute** the revised Section in Attachment 1 (7 pages).



**(NO TEXT THIS PAGE)**

## SECTION 6.40 - Engineer's Field Office

**6.40.1. DESCRIPTION.** The Contractor shall provide, furnish and maintain a fully equipped field office (Type A, B, C, CU, D or DU, as specified) for the exclusive use of and occupancy by the Department's engineering personnel and/or Supervising Consultant (herein after called "City personnel"), and by the engineering personnel of private utilities when specified. The field office shall be at a location approved by the Engineer and shall be a commercial building, store front, or with the approval of both Office of Construction Mitigation and Coordination (OCMC) and the Community Board it may be a mobile trailer(s). If a trailer is used it shall be subject to approval by the Engineer, and all necessary permits shall be obtained by the Contractor. The Contractor may have facilities in an adjoining area separated by a lockable door, provided such facilities are in a location approved by the Engineer. The field office shall be within ½ mile of the job site. Field offices located further than ½ mile from the job site shall require approval by the Director or Assistant Commissioner for Construction.

The field office structure and occupancy thereof shall conform to the requirements of all laws, rules, regulations and orders applicable to it.

The field office and all equipment, except as otherwise specified, may be new materials or may be used materials in good condition and satisfactory to the Engineer.

### 6.40.2. MATERIALS.

(A) **GENERAL CONSTRUCTION.** The Engineer's Field Office shall be in an approved and weatherproof building. It shall have a minimum ceiling height of seven (7') feet and be partitioned to provide the number of rooms required for the type of office specified. Floor space for Field Office Types C, CU, D, and DU shall be subdivided into work areas based on a floor plan provided by the City to the Contractor upon notification of space availability.

(B) **GENERAL FACILITIES.** The field office shall contain or have the following facilities incorporated:

(a) Lighting - Electric light, non-glare type luminaries to provide a minimum illumination level of 100 ft.-candles at desk height level.

(b) Heating and Cooling - Adequate equipment to maintain an ambient air temperature of 70° F. ±5°.

(c) Electrical Energy Outlets

(d) Toilet - A separate enclosed room, properly ventilated per code and complying with applicable sanitary codes shall contain a lavatory with a sink that provides running hot and cold water, flush-type toilet, mirror, electric hand dryer, and paper towel dispenser.

(e) Potable Water - Potable water supplied from an existing system or five (5) gallon capacity water cooler of a type to be approved by the Engineer shall be provided for use by City personnel. Replacement bottles of water shall be provided by the Contractor, when required.

(f) Signs - Store front locations shall have a window graphic sign in black and white lettering with the following inscription. Other locations shall have a wood or metal sign affixed on the outside wall of the building with the following inscription painted in black block lettering on a white background. Paints shall be approved exterior enamels.

<b>CITY OF NEW YORK</b>	2-1/2"
<b>DEPARTMENT OF DESIGN AND CONSTRUCTION</b>	3-1/2"
<b>INFRASTRUCTURE</b>	2-1/2"
<b>RESIDENT ENGINEER'S FIELD OFFICE</b>	2-1/2"

(g) Electric Refrigerator - Five (5) cubic feet minimum capacity for use by City personnel.

(h) Microwave, Toaster Oven, and Coffee Maker - Basic reheating kitchen equipment or approved appliances for use by City personnel.

(i) Windows and Doors - All windows and doors shall be weatherproof and each equipped with adequate locking devices. Each window shall be equipped with vertical blinds. Exterior doors shall be provided with two (2) separate "high security" dead bolt type cylinder locks, keyed alike, and three (3) keys shall be furnished for each lock.

(j) Partitions - Partitions for work space enclosures shall be either permanent walls or of the modular type similar to Herman Miller's standard fabric covered line.

(k) Kitchen Sink – Mechanism to provide non-drinking, hot and cold, running water.

(C) OFFICE EQUIPMENT.

(a) Pencil Sharpener - One standard pencil sharpener for use by City personnel.

(b) Telephone Answering Machine - The telephone answering machine to be provided shall be an electronic digital voice machine with emergency call forwarding capability. It shall be operable twenty four (24) hours per day and, when unattended, shall transmit to the caller the following message:

"You have reached the Field Office of the New York City Dept. of Design and Construction. No one is here now. We check our incoming messages frequently. We will get back to you as soon as possible. Please leave your name, message and phone number where you may be reached. In case of emergency, call the New York City Hotline at 311. Again, the emergency number is 311."

(c) Computer Equipment - Computers shall be provided for all contracts regardless of construction duration.

Computers furnished by the Contractor for use by City Personnel, for the duration of the contract, shall be in accordance with Table I - ADDITIONAL SPECIFIC REQUIREMENTS, contained herein, and shall meet the following minimum requirements:

- (1) Personal Computer(s) - Workstation Configuration.
- |     |                               |  |
|-----|-------------------------------|--|
| (a) | <u>Make and Model:</u>        | Dell; HP; Gateway; Acer; or, an approved equivalent. (Note: an approved equivalent requires written approval of the Assistant Commissioner of ITS.)  |
| (b) | <u>Processor:</u>             | i5 ( 4MB Cache, 3.0GHz) or faster computer – Dual Processor.   |
| (c) | <u>System Ram:</u>            | Minimum of 16GB (Gigabytes) Dual Channel DDR3 SDRAM at 1333MHz – 2 DIMMSs  |
| (d) | <u>Hard Disk Drive(s):</u>    | 500 GB (Gigabytes) Serial ATA (7200RPM) w/DataBurst Cache, or larger.  |
| (e) | <u>CD-RW:</u>                 | Internal CD-RW, 48x Speed or faster.   |
| (f) | <u>16X DVD+/-RW</u>           | DVD Burner (with double layer write capability) 16x Speed or faster  |
| (g) | <u>I/O Ports:</u>             | Must have at least one (1) Serial Port, one (1) Parallel Port and three (3) USB Ports.   |
| (h) | <u>Video Display Card:</u>    | HD Graphics (VGA, HDMI) with a minimum of 64 MB of RAM.  |
| (i) | <u>Monitor:</u>               | 22" W, 23.0 Inch VIS, Widescreen, VGA/DVI LCD Monitor.   |
| (j) | <u>Available Exp. Slots:</u>  | System as configured above shall have at least two (2) full size PCI Slots available.  |
| (k) | <u>Network Interface:</u>     | Integrated 10/100/1000 Ethernet card.  |
| (l) | <u>Other Peripherals:</u>     | Optical scroll Mouse, 101 Key Keyboard, Mouse Pad and all necessary cables.  |
| (m) | <u>Software Requirements:</u> | Microsoft Windows 10 Professional, 32 or 64 bit; Microsoft Office Professional 365 ; Microsoft Project 365 ; Basic Adobe Acrobat Package ; Anti-Virus software package with 2 year updates |

subscription; and, either Auto Cad LT or Microsoft Visio Standard Edition, as directed by the Engineer.

- (2) All field offices requiring computers shall be provided with the following:
- (a) One (1) broad-band internet service account. Wideband Internet connectivity at a minimum throughput of 15 Mbps download and 5 Mbps upload is required at each field office location with 1-5 staffers. For larger field offices see table below for minimum required upload speeds. Telephone service should be bundled together with Internet connectivity. Because of throughput requirements Verizon FIOS is the preferred connectivity provider where available.

Office Personnel #	Upload Speeds ( <i>Minimum</i> )
1 – 5	10 Mbps
6 – 10	20 Mbps
11 – 15	25 Mbps
16 – 20	50 Mbps

This account will be active for the life of the project. The e-mail name for the account shall be the DDC Field Office/project Id (- preferably Gmail or Outlook – e.g. HWK666@gmail.com).

- (b) All necessary Cabling.
- (c) Storage Boxes for and Blank CDs/DVDs.
- (d) UPS/Surge Suppressor combo.
- (e) 10 USB Thumb (or Flash) Drive – 16GB each
- (3) All computers required for use in the Engineer's Field Office shall be delivered, installed, and setup in the Field Office by the Contractor.
- (4) All Computer Hardware shall come with a three (3) year warranty for on-site repair or replacement. Additionally, and notwithstanding any terms of the warranty to the contrary, the Contractor is responsible for rectifying all computer problems or equipment failures within one (1) business day.
- (5) An adequate supply of blank CDs/DVDs, and paper and toner cartridges for the printer shall be provided by the Contractor, and shall be replenished by the Contractor as required by the Engineer.
- (6) It is the Contractor's responsibility to ensure that electrical service and phone connections are also available at all times; that is, the Field Office Computer(s) is to be powered and turned on twenty-four (24) hours each day.

Broadband connectivity is preferred at each field office location. Please take into consideration that an extra phone line dedicated to the modem must be ordered as part of the contract unless Internet broadband connectivity, via Cable or FiOS, is available at the planned field office location. Any questions regarding this policy should be directed to the Assistant Commissioner of Information Technology Services at 718-391-1761.

- (d) Data Books - A copy of The AED Green Book, latest edition, published by Machinery Information Division of K-III Directory Corporation, 1735 Technology Drive, Suite 410, San Jose, California 95110-1313, shall be provided for all contracts that have a total Consecutive Calendar Days for General Construction duration as set forth in Schedule A of greater than 365 CCD's. Contracts of lesser duration shall not require any data books.

(D) Field Testing Equipment.

- (a) 2 - Air Entrainment Meters - Pressure Type, with carrying case for use by City personnel. Each meter shall be capable of producing an accurate test result in approximately five (5) minutes and shall comply with ASTM Designation C 231.

- (b) 2 - Slump Test Sets - Slump cone and test sets conforming to the requirements of ASTM Designation C 143, complete with rod and scoop for use by City personnel.
- (c) Thermometers: For use by City personnel.
  - (1) 1 - Minimum-maximum thermometer.
  - (2) 3 - Asphalt thermometers of stainless steel construction with an accuracy of 0.5% of the full scale, able to measure temperatures from 50 to 500 degrees F. in 5 degree increments.
  - (3) 3 - Surface Thermometers able to measure temperatures of flat surfaces similar to Sargent-Weish Model S81441-D, or an approved equivalent.
- (d) Nonsparking Pinch Bar - For use in opening manholes.
- (e) Gas Meters - For use in detecting the presence of explosive gases and vapors for use by City personnel.
- (f) Straight Edge - One 10 foot long straight edge for use by City personnel in detecting pavement surface tolerance.
- (g) 48" Smart Level - For use in determining pedestrian ramp and sidewalk slopes.
- (h) Chlorine Test Kits - For testing residual chlorine levels following water main flushing.
- (i) Green Florescent Power Trace-Dye - For testing sewer connections.
- (j) One Million Candlepower Rechargeable Flashlight.
- (k) Distance Measuring Wheel - For measuring long distances.

**6.40.3. SPECIFIC REQUIREMENTS FOR ENGINEER'S FIELD OFFICE (TYPE A, B, C, CU, D, OR DU).** In addition to the general requirements, each type of Field Office shall have the minimum floor area indicated in Table 6.40-I calculated based on usable area only, excluding any loss factors. Loss factors are defined as those areas such as lobby, sidewalk window ledge, elevator shafts and stairways. The Contractor shall provide and maintain furnishings for each type of Field Office in the quantity specified in Table 6.40-I. The furnishings shall be new or used equipment satisfactory to the Engineer:

- (a) Each Type shall have a minimum of one outside door and four windows.
- (b) Type C shall be partitioned to provide three (3) rooms.
- (c) Type CU shall be partitioned to provide four (4) rooms, one of which shall be at least 150 s.f. in area (for use by private utilities).
- (d) Type D shall be partitioned to provide four (4) rooms.
- (e) Type DU shall be partitioned to provide five (5) rooms, one of which shall be at least 150 s.f. in area (for use by private utilities).

**TABLE 6.40-I  
ADDITIONAL SPECIFIC REQUIREMENTS**

SPECIFIC REQUIREMENTS	FIELD OFFICE TYPE					
	A	B	C	CU	D	DU
Minimum useable floor space (Square Feet)	400	800	1200	1200	1,800	1,800
Office desks, at least 4'-8" x 2'-8", with drawers, locks, and keys.	2	2	4	8*	8	12*
Swivel chairs, with arms, for the above.	2	2	4	8*	8	12*
Office folding chairs, metal, with padded seats and backs.	2	3	6	14**	8	16**
Steel supply cabinets (approximate size 72" high by 36" wide by 18" deep), with four adjustable shelves, tumbler lock and 3 keys.	1	1	1	1	1	1
Fire resistant cabinet, 4-drawer, legal size with lock and three (3) keys, meeting the requirements for "Filing devices, Insulated (36 E 9)" Class D Label, of the Underwriters' Laboratories, Inc. Specifications.	1	1	1	3***	4	6***
Individual lockers (17" wide x 18" deep x 72" high) with flat key locks and two (2) keys each.	1	1	4	4	4	4
Calculating machines, tape type with digital display registering at least ten (10) digits.	1	1	2	2	3	3

Waste paper baskets (metal, approximately 12" square by 16" high).	1	2	2	6*	4	8*
Fire extinguishers, non-toxic, dry chemical type meeting Underwriters Laboratories, Inc., approval for Class A, Class B and Class C fires with a minimum rating of 2A:10B:10C.	1	1	2	3****	4	5****
First Aid Kit kept properly stocked with appropriate first aid supplies at all times.	1	1	1	1	2	2
Drafting tables (3'-0" x 5'-0") with storage drawers and stool.	1	2	2	3****	4	5****
Photocopying Machine – Stand-alone, heavy duty, electric, dry-process color photocopying type with color scan and send capability via e-mail, a minimum production rate of 70 pages per minute and an adequate supply of copy paper, toner, etc. The machine shall be capable of duplex copying paper sizes of 8-1/2 x 11 inches, 8-1/2 x 14 inches and 11 x 17 inches, and have separate trays for each paper size. It shall have a document feeder, collator, stapler, and the capability to reduce/enlarge copies between each paper size. The supply of each size copy paper, toner, etc. shall be replenished and the machines shall be maintained for the duration of the contract by the Contractor as required by the Engineer. Make and model can be Minolta, Canon, IBM, Epson, or an approved equivalent, and shall be networked to the office computers for printing capability.	1	1	1	1	1	1
Standalone networked color laser printer. (Not required if photocopying machine prints in color)	XX	XX	XX	XX	XX	XX
Vertical filing plan racks for six sets of 22"x36" plans each rack.	1	1	2	3****	4	5****
Telephone lines for calls, where one shall be dedicated for the Fax Machine, one for each computer fax/modem and the others for telephone instruments.	4	6	6	7‡	8	9‡
Telephone instruments.	2	2	3	5‡	4	6‡
Telephone answering machine.	1	1	1	1	1	1
Fax Machine - With an adequate supply of copy paper, toner, etc. The supply of copy paper, toner, etc. shall be replenished and the machines shall be maintained for the duration of the contract by the Contractor as required by the Engineer.	1	1	1	1	1	1
Personal Computer - Workstation Configuration	1	3	3	3	4	4
Bottled water with refrigerator unit-hot/cold water. (For private utilities room.)				1		1
Heavy duty commercial grade diamond cut shredder with automatic start. The shredder shall be able to receive 8-1/2 inch wide paper and shred a minimum of 15 sheets simultaneously along with CDs and staples.	1	1	1	1	1	1
Projector – 1080p LCD with a min. of 2200 ANSI Lumens, 1920 x 1080, 16:9, 40,000:1 contrast ratio, HDMI, VGA, USB, and a 10 feet diagonal, 16:9 Projection Screen.	-	-	1	1	1	1

- ‡ Provide one (1) telephone line and two (2) telephone instruments for the exclusive use by private utilities personnel. The line shall interconnect the two telephone instruments by push button control.
- \* Provide four (4) each of Office Desks, Swivel Chairs and Waste Paper Baskets in private utilities room.
- \*\* Provide eight (8) Folding Chairs in private utilities room.
- \*\*\* Provide two (2) Fire Resistant 4- Drawer Legal Size Cabinets in private utilities room.
- \*\*\*\* Provide one (1) each of Fire Extinguisher, Drafting Table and Vertical File Rack in private utilities room.

**6.40.4. CONSTRUCTION METHODS.** The building shall be fully equipped and made available for use and occupancy by the Department's personnel and/or Supervision Consultant not less than thirty (30) days prior to the start of any contract work.

The building interior (including access foyers, stairwells, etc.) shall be maintained in good, clean, and sanitary working condition by the Contractor for the duration of the contract. The Contractor shall provide and pay all costs for electrical service, telephone service for calls within New York City limits, hot and cold water, heat and fuel, and daily janitor service. Staples, such as paper towels, hand soap, toilet paper, and similar supplies, shall always be available.

Where necessary, the site for a mobile trailer(s) shall be graded and shoulder stone placed and maintained as directed by the Engineer to provide a parking area for City personnel and, if necessary, an approach road shall be provided. Plumbing work shall include all water supply, drainage and piping required for the operation of a complete installation. Temporary water service shall be provided from an existing main and extended into the trailer and all fixtures requiring water supply shall be properly connected up. All necessary soil, waste, vent and drainage piping shall be provided and connected to the existing sewer or as otherwise directed.

The office, incorporated facilities, equipment, and personal property of the Department's employees shall be protected by the Contractor against loss or damage from fire, theft, or other causes, at all hours of the day and night. The Contractor shall provide fire insurance, extended coverage and vandalism, malicious mischief and burglary, and theft insurance coverage in the amount of forty thousand dollars (\$40,000.00) for office equipment of the City of New York in the Engineer's field office and for property of City personnel that is used in the contract work and stored in the office. All insurance coverage shall be written by a company approved by the Commissioner and payable in case of loss to the City of New York. The office shall be maintained by the Contractor in first class condition until final acceptance of the work. At the direction of the Engineer, any equipment on the above lists may be deleted. He may direct that other equipment of equivalent value be supplied by the Contractor or an appropriate credit be taken for the value of equipment not provided.

When directed by the Engineer, the Contractor shall disconnect all services and remove and dispose of all temporary installations from the site, including fencing, surfacing and utilities, the area shall then be cleaned, loamed and seeded if required and left in a neat and acceptable condition. On and after the date of the Engineer's Final Acceptance, the temporary structure and all installed equipment shall become the property of the Contractor, and shall be disposed of, by him, away from the site of the work. Engineer's Final Acceptance shall be when the Contractor has completed all punch list work and Official Completion Date has been set.

**6.40.5. NONCONFORMANCE.** No payment will be made under Engineer's Field Office for each calendar day during which there are deficiencies in compliance with the requirements of any subsection of this specification. The first calendar day shall commence twenty-four (24) hours after notice to the Contractor of such a deficiency. This non-payment shall be deducted from the Contractor's next estimate as a charge to the Contractor on the item. The amount of such calendar day non-payment will be determined by dividing the unit price bid per month by 30.

In addition, the Contractor may be subject to liquidated damages in accordance with Schedule A.

**6.40.6. MEASUREMENT.** The quantity to be measured for payment under this item shall be the number of months that the Field Office is available for occupancy by the Field Engineers during the period of the contract. Payment will begin the first month that the office is fully equipped, serviced as specified, and made available for occupancy. The Field Office is to be continuously made available and Monthly payments will continue for the duration of the contract through a period not to exceed 6 months past the substantial completion date. When directed in writing by the Commissioner, the Field Office will be provided and paid for a period of time beyond 6 months past the substantial completion date. Payment for each month's occupancy after the date of substantial completion acceptance will be made as part of the final estimate. Monthly payments may be terminated on a specified date prior to acceptance of the contract by written notification by the Engineer that such office will no longer be required on the contract.

**6.40.7. PRICE TO COVER.** The unit price bid per month for the item Engineer's Field Office shall include the cost of furnishing all labor, materials, equipment, ground rental, fire and theft insurance, and utility charges necessary to complete the work of providing or constructing the field office; making all necessary electrical, water, sewer, and other connections required to make the above facilities operative; payment of all rental costs; furnishing and paying for heating fuel, as required; all electrical energy;

private telephone services; staples, as specified; and all necessary incidentals to complete the work - all in accordance with the specifications and the directions of the Engineer.

*Payment will be made under:*

Item No.	Item	Pay Unit
6.40 A	ENGINEER'S FIELD OFFICE (Type A)	MONTH
6.40 B	ENGINEER'S FIELD OFFICE (Type B)	MONTH
6.40 C	ENGINEER'S FIELD OFFICE (Type C)	MONTH
6.40 CU	ENGINEER'S FIELD OFFICE (Joint Use) (Type CU)	MONTH
6.40 D	ENGINEER'S FIELD OFFICE (Type D)	MONTH
6.40 DU	ENGINEER'S FIELD OFFICE (Joint Use) (Type DU)	MONTH



**(NO TEXT THIS PAGE)**

	<b>Department of Design and Construction</b>	<b>SPECIFICATION BULLETIN</b>	<b>SB</b> 17-004
Prepared: 	1/12/2017	Approved: 	1/12/2017
Richard Jones, P.E. CWI Director, Specifications – Infrastructure Design	Date	Mohsen Zargarelahi, P.E. Assistant Commissioner – Infrastructure Design	Date

**APPLICABILITY:**

- This Specification Bulletin (SB) is effective for projects advertised on or after 2/20/17.

**SUPERSEDEENCE:**

- This SB supersedes the following SBs: NONE

**ATTACHMENTS:**

NONE

**REVISIONS TO THE NEW YORK CITY DEPARTMENT OF TRANSPORTATION  
STANDARD HIGHWAY SPECIFICATIONS VOLUME 1 OF 2, DATED 8/1/15:**

*No Changes.*

**REVISIONS TO THE NEW YORK CITY DEPARTMENT OF TRANSPORTATION  
STANDARD HIGHWAY SPECIFICATIONS VOLUME 2 OF 2, DATED 8/1/15:**

All references contained below are to the New York City Department of Transportation Standard Highway Specifications, Dated August 1, 2015. Said Standard Highway Specifications are hereby revised as follows:

- Refer** to Page 332, Section 6.23 – Fire Department Facilities, Subsection 6.23.4.(A), 3<sup>rd</sup> paragraph;  
**Delete** the words “Bureau of Fire Communications”;  
**Substitute** the words “Bureau of Facilities Management”.
- Refer** to Page 332, Section 6.23 – Fire Department Facilities, Subsection 6.23.4.(A), 9<sup>th</sup> paragraph;  
**Delete** the words “Bureau of Fire Communications”;  
**Substitute** the words “Bureau of Facilities Management”.



**Department of  
Design and  
Construction**



**SPECIFICATION  
BULLETIN**

**SB  
17-004**

**Title: FIRE DEPARTMENT FACILITIES**

- c) **Refer** to Page 332, Section 6.23 – Fire Department Facilities, Subsection 6.23.4.(A), 9<sup>th</sup> paragraph;  
**Delete** the words “(718) 624-4194”;  
**Substitute** the words “(718) 281-3846”.
- d) **Refer** to Page 333, Section 6.23 – Fire Department Facilities, Subsection 6.23.4.(E), 1<sup>st</sup> paragraph;  
**Delete** the words “Bureau of Fire Communications”;  
**Substitute** the words “Bureau of Facilities Management”.
- e) **Refer** to Page 339, Section 6.23 – Fire Department Facilities, Subsection 6.23.6, 1<sup>st</sup> paragraph;  
**Delete** the words “Bureau of Communications”;  
**Substitute** the words “Bureau of Facilities Management”.
- f) **Refer** to Page 343, Section 6.23 – Fire Department Facilities, Subsection 6.23.6.(I);  
**Delete** the words “steel bar reinforcement and”.
- g) **Refer** to Page 440, Section 6.70 – Maintenance and Protection of Traffic, Subsection 6.70.9.(D);  
**Delete** the words “Bureau of Fire Communications”;  
**Substitute** the words “Bureau of Facilities Management”.

**(NO FURTHER TEXT)**

	<b>Department of Design and Construction</b>	<b>SPECIFICATION BULLETIN</b>	<b>SB</b>  17-005
Prepared: 	1/12/2017	Approved: 	1/12/2017
Richard Jones, P.E. CWI Director, Specifications – Infrastructure Design	Date	Mohsen Zargarelahi, P.E. Assistant Commissioner – Infrastructure Design	Date

**APPLICABILITY:**

- This Specification Bulletin (SB) is effective for projects advertised on or after 2/20/17.

**SUPERSEDEANCE:**

- This SB supersedes the following SBs: **NONE**

**ATTACHMENTS:**

- **ATTACHMENT 1:** Revised Section 6.43 – PHOTOGRAPHS  
*Pages A1-1 through A1-4*

**REVISIONS TO THE NEW YORK CITY DEPARTMENT OF TRANSPORTATION  
STANDARD HIGHWAY SPECIFICATIONS VOLUME 1 OF 2, DATED 8/1/15:**

All references contained below are to the New York City Department of Transportation Standard Highway Specifications, Dated August 1, 2015. Said Standard Highway Specifications are hereby revised as follows:

- a) **Refer** to Page 37, Section 1.06.45 – Progress Photographs;  
**Delete** in its entirety the Section;  
**Substitute** the following: "NO TEXT."

**REVISIONS TO THE NEW YORK CITY DEPARTMENT OF TRANSPORTATION  
STANDARD HIGHWAY SPECIFICATIONS VOLUME 2 OF 2, DATED 8/1/15:**

All references contained below are to the New York City Department of Transportation Standard Highway Specifications, Dated August 1, 2015. Said Standard Highway Specifications are hereby revised as follows:

- b) **Refer** to Page 385, Section 6.43 - Photographs;  
**Delete** in its entirety the Section;  
**Substitute** the revised Section in Attachment 1 (4 pages).

	<b>Department of Design and Construction</b>	<b>SPECIFICATION BULLETIN</b>	<b>SB</b> 17-005
<b>Title: DIGITAL PHOTOGRAPHS</b>			

**REVISIONS TO THE NEW YORK CITY DEPARTMENT OF ENVIRONMENTAL PROTECTION STANDARD SEWER AND WATER MAIN SPECIFICATIONS, DATED 7/1/14:**

All references contained below are to the New York City Department of Environmental Protection Standard Sewer and Water Main Specifications, Dated July 1, 2014. Said Standard Sewer and Water Main Specifications are hereby revised as follows:

- a) **Refer** to Page I-16, Section 10.32 – PHOTOGRAPHS;  
**Delete** in its entirety the Section;  
**Substitute** the revised Section:

**“The Contractor shall be required to provide “PHOTOGRAPHS” in accordance with New York City Department of Transportation (NYCDOT) Standard Highway Specifications Section 6.43 – Photographs.”**

## SECTION 6.43 – Photographs

**6.43.1. INTENT.** This section describes the work of providing a photographic record of contract work.

**6.43.2. DESCRIPTION.** The work shall consist of the furnishing of all required photographic equipment and materials; the taking of digital photographs; making prints from digital files; and submitting prints and digital files to the Engineer.

**6.43.3. MATERIALS.**

### (A) PRINTS

Prints shall be 7-1/2" x 9-1/2" image area on 8" x 10" single-weight, gloss paper, and shall be in color. Prints shall be inserted in standard weight Archival Quality clear poly sheet protectors and submitted in a hard cover three (3) ring binder. The following information shall be imprinted, or indelibly printed, on a white border measuring no more than one and one half (1-1/2") inch at the bottom of the front of each photograph:

- (a) Contract Number and Job Location
- (b) Photograph Number
- (c) View and Description - (Indicating a general description of what the photograph represents)
- (d) Photograph Type: Preconstruction Photograph or Construction Progress Photograph
- (e) Date - (The date the photograph was taken.)
- (f) Address – street address where photograph was taken
- (g) Borough
- (h) Street Segment ID
- (i) Name of Photographer
- (j) Department Witness

The Contractor shall furnish to the Commissioner one (1) set for each view taken, each set consisting of two (2) 8" x 10" prints and one (1) digital file.

All prints and digital files shall become the property of the Commissioner. All completed prints and digital files shall be delivered to the Engineer within two (2) weeks after the photographs have been taken. Approved binders for the clear poly sheet protectors containing all materials shall be furnished by the Contractor and delivered to the designated construction office at the time of the initial submission of prints and DVDs at such other times as may be required thereafter.

### (B) DIGITAL FILES

Digital files shall be captured as 7.2 megapixel files or greater, with a minimum pixel array of 2,400 pixels by 3,000 pixels. The camera used to capture the digital files shall be a Digital SLR (Single Lens Reflex) camera or approved equal; "point and shoot" cameras or cameraphones are not acceptable. Digital cameras shall produce images using true optical resolution; "digital zoom" is not acceptable. Images shall not be resized or interpolated. The file format for digital files shall be Joint Photographic Experts Group format ("JPG"). The digital files shall not be modified or processed in any way to alter the JPG file's metadata, including the photograph's original capture date.

Digital files shall be submitted on Digital Versatile Disk ("DVD"). DVDs shall be inserted in standard weight Archival Quality clear poly sheet protectors, and submitted in a hard cover three (3) ring binder. The information imprinted on each print shall be provided on an Excel file included on the DVD. The DVD shall be labeled with the Project ID and the geographical area and streets depicted in the photographs. Labeling using adhesive labels is not acceptable.

Digital files shall have file names in the following format: a^b^c^d^e^f.JPG, where "a" through "f" are as follows:

- (a) Contract Number
- (b) Photograph Number
- (c) Date, in YYYY-MM-DD format (The date the photograph was taken.)
- (d) Address – street address where photograph was taken
- (e) Borough
- (f) Street Segment ID

A sample file name would be "HBX123^0021^2016-04-19^123 Main St^Queens^55555.JPG"

The files on the DVD shall be organized in folders by Photograph Type and Street Segment ID as follows:

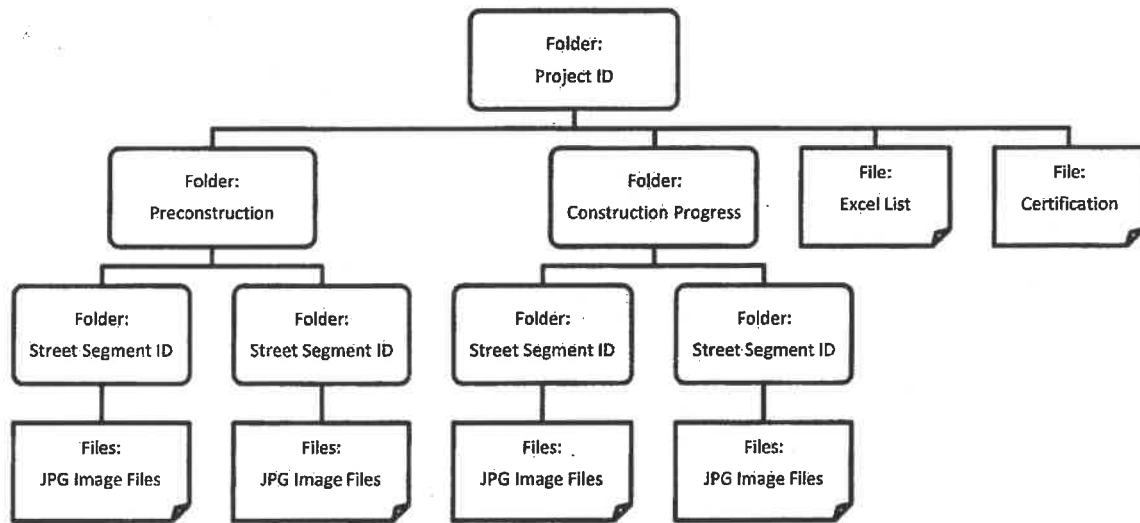

(C) CERTIFICATION

The Photographer shall provide a signed certification that the files on the DVD are unaltered and are an accurate representation of the subject photographed. The original certification, in a clear poly sheet protector, shall be submitted with the prints and digital files, and a scanned copy shall be included on the DVD.

**6.43.4. METHODS.** The Contractor shall employ and pay for the services of a competent Professional Photographer who, at the direction of the Commissioner or his authorized representative, shall take Preconstruction Photographs and Construction Progress Photographs and such other photographs which may be required during the period of the contract.

The Photographer shall be available for taking the required photographs within forty-eight (48) hours after receiving notification from the Commissioner or his authorized representative.

Photographs shall be taken under the supervision and direction of the Engineer. The Engineer reserves the right to reject any and all views that are not reasonably clear and definitive. No separate or additional payment will be made for any additional photographs that are required as a result of the rejection of views.

**6.43.5. PRECONSTRUCTION PHOTOGRAPHS.** Preconstruction Photographs shall show the conditions existing on the work site prior to the commencement of the contract work. The Preconstruction Photographs will generally represent views of:

- The original surface conditions of streets, curbs and walks, and buildings;
- Evidence of damage, disrepair, or emergency situations;
- All encumbrances and/or encroachments which may be affected by the construction of the proposed work.

When there is no pay item listed in the Bid Schedule, the number of Preconstruction Photographs shall be as follows:

- (A) Highway Street Reconstruction projects: 150 sets per million dollars of street reconstruction work;
- (B) Highway Resurfacing projects: 4 sets per 250 linear feet of roadway for resurfacing work;
- (C) Sewer and Water Main projects: 2 sets (1 set each side of street) per 25 linear foot of sewer and water main.

When there is an item listed in the Bid Schedule, the quantity to be measured for payment shall be the number of sets, each set consisting of a digital file and the two (2) prints made from the digital file, of Preconstruction Photographs including photographs showing the original condition of all encumbrances and/or encroachments which may be affected by construction of the proposed work, and which are delivered as directed by the Engineer.

**6.43.6. CONSTRUCTION PROGRESS PHOTOGRAPHS.** Construction Progress Photographs shall show the conditions existing during the progress of, and at the completion of the contract work. The photographs will generally represent views of the work under construction and completed work. Construction Progress Photographs shall be taken monthly and upon completion of the work.

The approximate number of Construction Progress Photographs is as follows:

- (A) Highway reconstruction and resurfacing projects: Minimum 2 sets per 250 linear feet of roadway under construction or completed in the last month.
- (B) Pedestrian ramps on all projects: Minimum of 1 set for every pedestrian ramp under construction or completed in the last month, in addition to other progress photographs.
- (C) Sewer and Water Main projects: Minimum of 4 sets for every 100 feet of sewer or water main under construction.

No separate payment will be made for Construction Progress Photographs. The cost of taking and providing sets of Construction Progress Photographs shall be included in the prices bid for all other items of work.

**6.43.8. PRICE TO COVER (PRECONSTRUCTION PHOTOGRAPHS ONLY).** When there is an item listed in the Bid Schedule, the contract price bid per set shall cover the cost of furnishing all labor, materials, plant, equipment, insurance, and necessary incidentals required, including the cost of the photographer, and the cost of furnishing the required prints, digital files, DVDs, and ring binders, and completing the work in accordance with the specifications and the directions of the Engineer.

When there is no item listed in the Bid Schedule, no separate payment will be made. The cost of furnishing all labor, materials, plant, equipment, insurance, and necessary incidentals required, including the cost of the photographer, and the cost of furnishing the required prints, digital files, DVDs, and ring



binders, and completing the work in accordance with the specifications and the directions of the Engineer shall be included in the prices bid for all other items of work.

*Payment will be made under:*

Item No.	Item	Pay Unit
6.43 D	DIGITAL PHOTOGRAPHS	SETS

	<b>Department of Design and Construction</b>	<b>SPECIFICATION BULLETIN</b>	<b>SB</b>  17-006
Prepared: 	1/12/2017	Approved: 	1/12/2017
Richard Jones, P.E. CWI Director, Specifications – Infrastructure Design	Date	Mohsen Zargarelahi, P.E. Assistant Commissioner – Infrastructure Design	Date

**APPLICABILITY:**

- This Specification Bulletin (SB) is effective for projects advertised on or after 2/20/17.

**SUPERSEDEANCE:**

- This SB supersedes the following SBs: **NONE**

**ATTACHMENTS:**

NONE

**REVISIONS TO THE NEW YORK CITY DEPARTMENT OF TRANSPORTATION  
STANDARD HIGHWAY SPECIFICATIONS VOLUME 1 OF 2, DATED 8/1/15:**

All references contained below are to the New York City Department of Transportation Standard Highway Specifications, Dated August 1, 2015. Said Standard Highway Specifications are hereby revised as follows:

- a) **Refer** to Page 9, Section 1.06.18 – Records of Subsurface Structures, Etc.;
- Delete** the first two paragraphs;
- Add** the following paragraph to the beginning of the Section:

“The Contractor stipulates that it has the obligation to examine and review any and all available documents and other sources of information concerning the condition of the sub-soil materials, subsurface conditions and existing subsurface structures of bridges, pipes, tunnels, conduits, sewers, foundations, bulkhead walls and other subsurface structures and stipulates that it has made such investigation and research as it deems necessary. To the extent the Contractor incurs delays or damages based on sub-soil materials, subsurface conditions and existing subsurface structures that were known or reasonably could have been known to the Contractor through such available documents or other sources of information, the Contractor will make no claim for such delays or damages.”

**(NO TEXT THIS PAGE)**

**I - PAGES**

**NEW SECTIONS**

---

**NOTICE**

UNLESS OTHERWISE NOTED, ALL SECTIONS, SUBSECTIONS, ARTICLES, OR SUBARTICLES AS REFERRED TO HEREIN WITHIN THESE NEW SECTION SPECIFICATIONS SHALL BE THOSE OF THE NEW YORK CITY DEPARTMENT OF TRANSPORTATION'S (NYCDOT'S) CURRENT STANDARD HIGHWAY SPECIFICATIONS WITH CURRENT ADDITIONS, MODIFICATIONS AND REVISIONS TO THE STANDARD HIGHWAY SPECIFICATIONS (R-PAGES).

THE STANDARD HIGHWAY SPECIFICATIONS ARE NOT INCLUDED IN THESE I-PAGES. SEE THE NYCDOT STANDARD HIGHWAY SPECIFICATIONS BOOKS FOR STANDARD SPECIFICATIONS TEXTS.

(NO TEXT ON THIS PAGE)

## TABLE OF CONTENTS

SECTION	DESCRIPTION	PAGE NO.
4.09 CG	STEEL FACED INTEGRAL CONCRETE CURB AND GUTTER.	I-1
6.34 A	TEMPORARY CHAIN LINK FENCE, 6'-0" HIGH	I-3
6.52 FED	UNIFORMED FLAGPERSON	I-4
8.32	BARK CHIP MULCH	I-6
637.95 20	FIELD INFORMATION MANAGEMENT SYSTEM	I-7
HW-900H	ALLOWANCE FOR CITY WORK ACCELERATION	I-11
HW-908	ALLOWANCE FOR EXTRA WORK DUE TO ARCHAEOLOGICAL DISCOVERIES	I-12

(NO TEXT ON THIS PAGE)

## SECTION 4.09 CG

## Steel Faced Integral Concrete Curb and Gutter

4.09CG.1. DESCRIPTION. Steel faced integral concrete curb and gutter shall consist of steel facing set in a concrete cradle integrally formed with the gutter to the size and shape shown on the Contract Drawings and where directed by the Engineer.

4.09CG.2. MATERIALS. All materials shall comply with the requirements of Subsections 4.09.3. of the Standard Highway Specifications, unless otherwise shown on the plans or specified herein.

Steel facing shall be Type D, bent plate as per Standard Drawings H-1010, H-1011 dated 09-15-06, and H-1015, and as modified on the plans. All steel facing at corners, transition and other modifications to bent plate sections shall be shop fabricated.

Concrete for machine formed curb and gutters shall be Class J Concrete as specified in the New York State Department of Transportation STANDARD SPECIFICATIONS of May 1, 2008, Section 501, Portland Cement Concrete - General.

4.09CG.3. METHODS. All methods of construction shall be in accordance with the requirements of Item 4.08 CG, modified with the addition of steel facing, as shown on the Contract Drawings.

All steel facing shall be painted as per Subsection 4.09.4. (K) PAINTING, of the Standard Highway Specifications.

Where the Contractor proposes to machine form integral curb and gutter, he shall also comply with the following additional requirements:

Slump range shall be 1/2 inch to 1-1/2 inches.  
Air content shall be  $\pm 2\%$  of design.

4.09CG.3. MEASUREMENT. The quantity to be measured for payment shall be the number of linear feet of each type of Integral Steel Faced Concrete Curb and Gutter constructed, complete, in place, as required, measured along the top of the exposed face of steel, and adjusted in accordance with Section 5.04.

Integral steel faced concrete curb and gutter constructed in accordance with the New York City Department of Transportation's Standard Details of Construction Standard Drawing H-1011, will be measured for payment under the appropriate Corner or Straight Integral Steel Faced Concrete Curb and Gutter item.

Integral steel faced concrete curb and gutter constructed in accordance with New York City Department of Transportation's Standard Details of Construction Standard Drawing No. H-1015, will be measured for payment under the appropriate Straight or Depressed Integral Steel Faced Curb and Gutter item.

Curved integral steel faced concrete curb and gutter will be measured as straight curb when the radius is greater than 100 feet and



as corner curb when the radius is 100 feet or less. Integral Corner Steel Faced Concrete Curb and Gutter will be measured only from PC to PT. All additional tangent lengths of steel faced integral concrete curb attached to the integral corner steel faced concrete curb will be measured for payment as integral straight steel faced concrete curb and gutter.

Transitional steel faced concrete curb and gutter at driveways shall be measured for payment as Depressed Steel Faced Concrete Curb and Gutter. All additional lengths of steel faced curb, outside of the depressed and transitional curb and gutter in driveways, will be measured for payment as straight steel faced concrete curb and gutter.

4.09CG.4. PRICES TO COVER. When the proposed adjacent sidewalk is designated to be pigmented, no additional payment will be made for the cost of pigmenting the steel faced concrete curb and gutter to match the proposed adjacent pigmented sidewalk in color.

The contract price per linear foot of Integral Steel Faced Concrete Curb and Gutter of each type shall cover the cost of all labor, materials, equipment, insurance, and incidentals required to construct the integral curb and gutter complete in place, including, but not limited to, excavation (other than rock excavation) and backfilling, in full compliance with the requirements of the specifications, to furnish such samples for testing and to provide such testing equipment, laboratory space and facilities as may be required, and maintaining the integral steel faced concrete curb and gutter in good condition as specified in Section 5.05.

*Payment will be made under:*

Item No.	Item	Pay Unit
4.09 CGA	INTEGRAL STRAIGHT STEEL FACED CONCRETE CURB AND GUTTER	L.F.
4.09 CGC	INTEGRAL CORNER STEEL FACED CONCRETE CURB AND GUTTER	L.F.
4.09 CGD	INTEGRAL DEPRESSED STEEL FACED CONCRETE CURB AND GUTTER	L.F.

SECTION 6.34 A  
Temporary Chain Link Fence, 6'-0" High

6.34A.1. DESCRIPTION. Under this section, the Contractor shall furnish, erect, maintain, and remove, when directed, each type of Temporary Chain Link Fence as shown on the Contract Drawings and directed by the Engineer.

6.34A.2. MATERIALS AND METHODS. All materials and methods shall be as specified in Section 6.34 of the Standard Highway Specifications, with the following modifications and additions:

Temporary Chain Link Fence to be furnished under Item 6.34 ACT, shall consist of chain link fence fabric, top and bottom tension wires, gates, posts to be embedded in the pavement, and all necessary incidental in accordance with the Contract Drawings and the directions of the Engineer.

Temporary Chain Link Fence to be furnished under Item 6.34 ACTP, shall consist of chain link fence fabric, top and bottom rails for mounting a decorative mesh (to be furnished under another item), gates, posts with steel plate footings, sand bags to hold fence in place, and all necessary incidental in accordance with the Contract Drawings and the directions of the Engineer.

When directed by the Engineer, the Contractor shall remove and dispose of the temporary chain link fence to the satisfaction of the Engineer. The Contractor shall then fill any holes left in the pavement with compacted clean sand to grade.

6.34A.3. MEASUREMENT. The quantities of Temporary Chain Link Fence to be measured for payment shall be the number of linear feet of each type satisfactorily installed, complete, measured in place, from center to center of end posts.

6.34A.4. PRICES TO COVER. The prices bid for each type of Temporary Chain Link Fence shall be a unit price per linear foot and shall cover the cost of all labor, materials, plant, equipment, insurance, and necessary incidentals required to furnish, install, maintain, and remove temporary chain link fence; all in accordance with the Contract Drawings, the specifications and the directions of the Engineer. Temporary chain link fence shall also include, but not limited to, any gates as may be required.

*Payment will be made under:*

<u>Item No.</u>	<u>Description</u>	<u>Pay Unit</u>
6.34 ACT	TEMPORARY CHAIN LINK FENCE, 6'-0" HIGH	L.F.
6.34 ACTP	TEMPORARY CHAIN LINK FENCE, 6'-0" HIGH, (WITH TOP AND BOTTOM RAILS AND POSTS MOUNTED ON STEEL PLATES)	L.F.

**SECTION 6.52 FED**  
**Uniformed Flagperson**

**6.52FED.1. INTENT.** This section describes the employment of uniformed flagpersons to direct and detour traffic.

**6.52FED.2. DESCRIPTION.** The Contractor shall furnish an adequate number of flagpersons to control vehicular and pedestrian traffic when it is necessary to maintain alternating one-way traffic in one lane of a two-way roadway, and at all other locations where construction operations, construction vehicles and equipment, and temporary traffic patterns related to the construction operations require positive temporary traffic control for safe, efficient traffic operations.

**6.52FED.3. METHODS.** All crossing guards, whether paid for under this item or not, shall be proficient in speaking, writing and reading English and adequately trained, as approved by the Engineer, in controlling vehicular and pedestrian traffic at construction sites.

All flagpersons, their apparel, hand-signaling devices, active two-way radios, and procedures to be used by them shall be in compliance with the requirements of Chapter 6E. FLAGGER CONTROL, in the Federal "Manual on Uniform Traffic Control Devices for Streets and Highways" 2009 Edition, or later edition.

Prior to the start of flagging operations, the Contractor shall provide to the Engineer a list of certified flagpersons to be used in the contract, identifying the source of flagger training for each individual. When requested by the Engineer, flagpersons shall demonstrate their competency in flagging procedures. Flagpersons not competent in flagging procedures to the satisfaction of the Engineer shall be retrained or replaced at once.

Flagpersons are to be paid not less than the most recent prevailing wages rates established for Laborers as determined by the NYC Comptroller or the US Department of Labor, whichever is higher at the time the work is being performed.

The Contractor will be given a minimum of 12 hours advanced notice by the Engineer as to when to furnish a flagperson.

**6.52FED.4. METHOD OF MEASUREMENT.** The fixed price lump sum shown in the bid proposal for this item shall be considered the price bid, although actual payment will be based on the authorized work performed by the Uniformed Flagpersons. The fixed sum is not to be altered in any manner by the bidder.

It is agreed that the quantity to be measured for payment shall be the number of person-hours of uniformed flagperson service actually performed, as authorized by the Engineer.

Laborers who are not uniformed flagperson will not be measured for payment as flagperson under this item.

**6.52FED.5. BASIS OF PAYMENT.** The Contract price for this item shall be a lump sum price for the work performed under this item and shall be equal to the total sum of the amount of wages paid for all authorized Uniformed Flagpersons performing vehicular and pedestrian traffic management, with a twelve (12%) percent markup for Overhead, except that no percentage for overhead will be allowed on Payroll Taxes or on the premium portion of overtime

pay or on sales and personal property taxes; plus ten (10%) as compensation for Profit, except that no percentage for profit will be allowed on Payroll Taxes or on the premium portion of overtime pay or on sales and personal property taxes; as described in Article 26 of the Standard Construction Contract.

Overhead shall include without limitation, all costs and expenses in connection with administration, management superintendence, and all material costs for their apparel, hand-signaling devices, active two-way radios, and any other equipment required, and insurance required by Schedule A of the General Conditions other than Workers' Compensation Insurance.

The hourly rate per person-hour shall be the prevailing wage rate for Laborers in effect at the time of the work to control and detour traffic, as shown on the Contract Drawings or as directed by the Engineer.

The Contactor shall be required to submit to the Engineer satisfactory evidence of payment on a New York State certified payroll report forms. No retainage will be withheld by the Department on such payments made under this section.

The total estimated cost of this item is the "fixed sum" amount shown for this item in the Bid Schedule. No guarantee is given that the actual total cost for this item will in fact be the "fixed sum" amount. The "fixed sum" amount is included in the total bid solely to insure that sufficient monies will be available to pay the Contractor for these services.

The "fixed sum" is for bidding purposes only and shall not be varied in the bid. The Contractor will be paid for the actual amount regardless of the fixed sum, which may be more or less than the fixed sum amount.

The Contractor shall maintain separate books of accounts and shall not charge any portion of the cost of wages for Uniformed Flagpersons to another part of the work. Payment and partial payments under this item shall be treated separately from the rest of the contract items.

The New York State certified payroll report forms shall be submitted to the Engineer on a monthly basis and shall include the signed copies of the daily report.

*Payment will be made under:*

Item No.	Item	Pay Unit
6.52 FED	UNIFORMED FLAGPERSON	FIXED SUM

**SECTION 8.32  
Bark Chip Mulch**

8.32.1. DESCRIPTION. Under this section, the Contractor shall furnish and place Bark Chip Mulch in accordance with the plans and specifications and as directed by the Engineer.

8.32.2. MATERIAL. Bark Chip Mulch shall be a natural forest product of 98% bark containing less than 2% wood or other debris. It shall be of white or Red Fir and/or Pine bark of a uniform grade with no additives or any other treatment. Size of bark shall be from 5/8" to 1-1/4". The ph factor should range from 5.8 to 6.2.

8.32.3. METHODS. Bark Chip Mulch shall be applied where required on the plans or directed by Engineer as a ground cover to the surface of beds and tree pits after the planting is completed. Mulch shall be applied to a uniform depth of three inches (3") and shall be so distributed as to create a smooth, level cover over the exposed soil. Plants shall not be covered.

8.32.4. MEASUREMENT. The quantity of Bark Chip Mulch to be paid for will be the number of square yards of ground surface area that has been satisfactorily covered with bark chip mulch within limits of enlarged tree pits surrounding existing trees as indicated on the plans and where directed by the Engineer.

8.32.5. PRICE TO COVER. The unit price bid per square yard for Bark Chip Mulch shall cover the cost of all labor, materials, plant, equipment, insurance, and incidentals necessary to complete the work under this section in accordance with the plans, the specifications and the directions of the Engineer.

No payment will be made under this item for furnishing and placing mulch in tree pits around newly planted or transplanted trees.

*Payment will be made under:*

Item No.	Item	Pay Unit
8.32	BARK CHIP MULCH	S.Y.

**ITEM 637.95 20 – FIELD INFORMATION MANAGEMENT SYSTEM****DESCRIPTION:**

This work shall consist of providing a fully operational field information collection and management system and support services.

**MATERIALS:**

The field information management system shall include all the components, and adhere to, the specifications in Attachment A attached to this specification.

The Contractor is required to have the vendor of the field information management system on call for support services for the duration of the contract.

**CONSTRUCTION DETAILS:**

The Contractor shall provide and maintain a field information management system with access made available to parties as designated by the Engineer. The Contractor shall make the system fully operational, including training, prior to the project first working day.

The system shall be maintained and remain in service until either: (a) the Engineer requests its removal in writing, (b) the NYCDOT relinquishes the Engineer's field office and the field information management system is relinquished as part of the Engineer's field office, or (c) the later of either thirty (30) days after the final contract acceptance date or thirty (30) days after the date the Contractor provided the last documentation necessary for processing the final contract acceptance.

Ownership of the software supplied by the Contractor shall remain the property of New York City Department of Transportation (NYCDOT). All data is the property of NYCDOT and shall be provided in a useable format at the completion of the contract.

The Contractor shall maintain the information management system vendor account in good standing to prevent service interruptions for the duration of the project.

**METHOD OF MEASUREMENT:**

The field information management system will be measured on a fixed price Dollar Cents pay unit basis.

**BASIS OF PAYMENT:**

The pay item is a 'draw down' item. As materials are supplied, the receipts for the materials shall be submitted to the Engineer (Note: 'materials' includes all software, software customizations, labor, services, and service contracts provided to furnish and maintain all of the components of the system). The Contractor will be reimbursed for receipted costs of materials plus five percent (5%) for profit and overhead.

The total cost shown in the itemized proposal for this pay item will be considered the price bid even though payment will be made only for actual materials supplied, with profit and overhead. The unit price amount is not to be altered in any manner by the bidder. Should the bidder alter the amount shown, the altered figure will be disregarded, and the original price will be used to determine the total amount bid for the contract.

*Payment will be made under:*

<b>Item No.</b>	<b>Item</b>	<b>Pay Unit</b>
637.95 20	FIELD INFORMATION MANAGEMENT SYSTEM	F.S.

**ITEM 637.95 20 – FIELD INFORMATION MANAGEMENT SYSTEM****ATTACHMENT A**

This pay item shall include supplying a cloud based field information management system with the following capabilities.

**ACCESS**

- Accessible from any internet connected desktop and laptop through a vendor supported browser
- Accessible from vendor supported mobile tablets (ex. Apple iPad)

**SYSTEM FUNCTIONALITY**

The system will provide the following functionality in real time to all authorized users:

- Field Recording
  - Work Report (Inspector Reports) progress tracking quantity, labor, equipment, field sketches, forms, etc.
  - Engineer Reports (EIC Journals) with automatically integrated Work Reports
  - Punch List Issue tracking with Ball In Court, Priority and Due Date assignment
- Cost Control
  - Generate Payment Estimate (Progress Payment) with thresholds to warn Engineer of the following payment scenarios: Quantity Over Authorized Quantity, Quantity Over Material Acceptance Restriction, Charge to Contractor Recorded, Force Account Estimate limit, Field Change Payment Recorded, Major Item Over Run, Minor Item Over Run and Material Partial Payment Recorded
  - Material Acceptance Tracking Module
  - Material Partial Payment (MOH/Stockpile) Module
  - Contract Change Order Module
  - Field Change Payment Tracking
  - DBE Tracking
  - Retainage Tracking
  - Provide electronic data input into NYSDOT CEES system
  - Project Close Out Milestone tracking and CEES based Close Out Reports
  - CEES based Reporting Module
- Document Control (all with Ball in Court, Priority, Due Date and electronic notifications for electronic communication between project participants)
  - Request For Information (RFI) Module
  - Submittal Module
  - Submittal Package Module
  - Transmittal Module
  - Meeting Minutes Module
  - Messages Module
  - File Cabinet for storage of (Photos, Videos, Forms, Contract Documents, Specifications and all project files)
- Ability to electronically load files into File Cabinet via upload and/or email into from web based email systems



**ITEM 637.95 20 – FIELD INFORMATION MANAGEMENT SYSTEM**

- Plan Module. (Ability to view, organize and submit/approve original & marked up plans)
- Scheduling
  - Display current approved CMP schedule
  - Ability to record activities against CPM schedule
  - Ability to export actual activities used information into Scheduling Software
- Archive. Provide automated conversion of Project records into text selectable PDF files organized into standard folder structure for storage and/or printing
- Provide continual (when and wherever wireless service is reasonably available) two-way synchronization between all components of the system
  - Provide offline option for vendor approved mobile device
- Integrated Search Module
- Support/Help Module

**DATA REQUIREMENTS**

The following information is required for Project Set Up

- Searchable Contract Plans and Proposal
- Searchable Standard Specifications
- Searchable common Data Resources (MURK Manuals, Standard Sheets, Engineering Instructions, etc.)
- Initial CPM Schedule
- Field User Forms

**DATA STORAGE /TRANSFER**

- Data shall be stored and maintained on a cloud based server with regular secondary location backups
- Continual access to system shall be available from the office and field office shall be provided (via internet)
- Raw data will be made available to NYCDOT through provided API
- All data shall be transferred to NYCDOT in a useable electronic format at the end of the contract

**MAINTENANCE /SERVICE**

- Any as-needed maintenance/service/upgrades shall be provided in a timely manner
- Software is able to be customized for NYCDOT direction

**TRAINING**

- In-person training on the use of the systems shall be provided
- Continuous help call support also shall be available for the duration of the contract
- Training and support services shall be performed by a qualified representative from the field information management system vendor.

**SECTION HW-900H**  
Allowance for City Work Acceleration

Under this Section, the Contractor will be paid for City work deemed necessary by DDC's Commissioner to accelerate the City work items in the project during critical periods but the use of this item will expire on the original contract substantial completion date. Such accelerated City work includes:

- A. 100% of the premium portions of overtime pay for working during non-scheduled work hours which shall be defined as those hours of work outside the permissible hours stated in the original contract OCMC Traffic Stipulations; or,
- B. The premium portion of overtime pay for overtime actually worked beyond the 40-hour work week but within the permissible hours of work stated in the original contract OCMC Traffic Stipulations; or,
- C. All other incidental expenditures caused by modifications of project site regulations or administrative requirements ordered by the Commissioner that result in additional costs to perform contract work as specified.

Such accelerated City work shall be paid for under this item in accordance with the requirements of **Articles 25 and 26** of the Standard Construction Contract.

Payment made under this Fixed Sum item shall cover the cost of all labor, materials, plant, equipment, insurance, and incidentals necessary to accelerate the City work as ordered by DDC's Commissioner.

No guarantee is given that this allowance item will in fact be required in this contract. The estimated "fixed sum" amount shown in the Bid Schedule is included in the total bid solely to insure a method of payment for any accelerated work performed by the Contractor, as directed by DDC's Commissioner.

*Payment will be made under:*

Item No.	Item	Pay Unit
HW-900H	ALLOWANCE FOR CITY WORK ACCELERATION	F.S.

SECTION HW-908

Allowance for Extra Work due to Archaeological Discoveries

In accordance with the Special Provisions article titled "ARCHAEOLOGICAL DISCOVERIES", should extra work be ordered by the Resident Engineer as a result of any archaeological discoveries being found under this project, it shall be paid for under this item as extra work in accordance with the requirements of Article 26 in the Standard Construction Contract dated December 2013.

Payment made under this Fixed Sum item shall cover the cost of all labor, materials, plant, equipment, insurance, and incidentals necessary to complete any extra work ordered by the Engineer due to archaeological discoveries found at the site.

No guarantee is given that this allowance item will in fact be required in this contract. The estimated "fixed sum" amount shown in the Bid Schedule is included in the total bid solely to insure a method of payment for any extra work performed by the Contractor, as directed by the Engineer in consultation with the City's Archaeologist due to archaeological discoveries found at the site.

*Payment will be made under:*

Item No.	Item	Pay Unit
HW-908	ALLOWANCE FOR EXTRA WORK DUE TO ARCHAEOLOGICAL DISCOVERIES	F.S.

**S - PAGES**

## **SPECIAL PROVISIONS**

---

### **NOTICE**

THE PAGES CONTAINED HEREIN (S-PAGES) ARE SPECIAL PROVISIONS THAT SHALL APPLY TO AND BECOME A PART OF THE CONTRACT.

(NO TEXT ON THIS PAGE)

**TABLE OF CONTENTS**

<b>ARTICLE</b>	<b>DESCRIPTION</b>	<b>PAGE NO.</b>
A.	LINES AND GRADES	S-1
B.	SPECIFIC TRAFFIC STIPULATIONS	S-1
C.	HOLIDAY CONSTRUCTION EMBARGO	S-1
D.	DISPOSAL OF EXCESS EXCAVATED MATERIAL	S-2
E.	CONTRACT ITEMS THAT INCLUDE BACKFILL AS A PART OF THEIR WORK	S-2
F.	NOISE CONTROL	S-2
G.	SCHEDULE OF WORK	S-10
H.	SCHEDULING PRESENTATION	S-10
I.	ACCELERATED PROJECT SCHEDULE AND COMBINATION OF STAGES	S-11
J.	NO EXTENSION OF TIME FOR WINTER SHUT-DOWN	S-11
K.	PRIVATE UTILITY HARDWARE ADJUSTMENTS	S-11
L.	SURVEY MONUMENTS	S-11
M.	RESTORATION OF ADJACENT AREAS	S-11
N.	RAILROAD FACILITIES REQUIREMENTS	S-12
O.	N.Y.C. TRANSIT INSURANCE	S-12
P.	USE OF CITY WATER	S-16
Q.	FUEL COST	S-16
R.	ITEM NO. 6.52 FED	S-16
S.	NIGHT TIME AND/OR WEEKEND DIFFERENTIAL	S-16
T.	ENGINEER'S FIELD OFFICE	S-16
U.	VIBRATORY ROLLERS	S-16

<b>ARTICLE</b>	<b>DESCRIPTION</b>	<b>PAGE NO.</b>
V.	ARCHAEOLOGICAL DISCOVERIES	S-16
W.	PRICES TO INCLUDE	S-17
	OCMC TRAFFIC STIPULATIONS	S-18
	OCMC TRAFFIC STIPULATIONS AMENDMENT #1	S-25
	THE CITY OF NEW YORK DEPARTMENT OF SANITATION INTERPRETIVE MEMORANDUM # 2	S-29

## SPECIAL PROVISIONS

A. LINES AND GRADES. The Contractor shall furnish lines and grades in accordance with Section 1.06.27 of the Standard Specifications, except that survey controls established for this project may no longer exist and the Contractor shall be required to re-establish the survey control information using official Borough Survey Control Monuments and Bench Marks, where they exist. The Contractor shall check with Topographic Section of the Borough President's Office as to the reliability and accuracy of the data to be used for lines and grades.

B. SPECIFIC TRAFFIC STIPULATIONS. Under this contract, the Contractor shall perform the work in strict accordance with the requirements of Section 6.70 in the Standard Highway Specifications, specific traffic stipulations as called for on the plans, OCMC Traffic Stipulations attached to the end of these Special Provisions, and the directions of the Engineer. In case of a conflict, the Engineer's decision shall be final.

In addition, the cost of compliance with requirements of the OCMC Traffic Stipulations, unless otherwise provided for, shall be deemed included in the prices bid for all scheduled items.

C. HOLIDAY CONSTRUCTION EMBARGO. A special Holiday Construction Embargo shall be in effect on the Friday of the week preceding Thanksgiving Day week from 6:00 AM to 11:59 PM and again from the Monday of Thanksgiving Day week from 6:00 AM through January 2, at 11:59 PM. Roadway and sidewalk construction activities will be restricted during the embargo period on the streets listed below\*.

Any permits issued prior to the date of this notice, for work during this embargo period on the streets listed below which do not already have the permit stipulation "410" are hereby suspended for the period noted above. All permittees must comply with this embargo unless a special waiver is granted by OCMC. Waiver requests must be filed at least thirteen days before Thanksgiving Day, in the Permit Office by filing a "Request for Roadway/Sidewalk Permits During Embargo Periods" and submitting supporting documentation. Waiver requests should only be submitted for critical reasons for a specific project. If a waiver is granted, the applicant will be notified so they can apply for the approved permits. Waivers **are not** required for ongoing Building Construction Activity Permits which already include the "410" permit stipulation. Waiver request forms may be obtained at any Permit Office or on the Department of Transportation's website at:

<http://www.nyc.gov/html/dot/downloads/pdf/holidayembapp.pdf>

Prior to this embargo period all necessary measures must be taken so that all roadways and sidewalks are in proper condition to allow for the expeditious and safe movement of vehicular, bicycle and pedestrian

---

\* Please note that this embargo only applies to NYCDOT construction permits.

\* List of street and maps of the affected locations are available by borough on the Department of Transportation's website at:  
<http://www.nyc.gov/html/dot/html/motorist/trafalrt.shtml>



traffic. Tool carts, cable reels, containers, and material stored on roadways must be removed during the embargo period.

The opening of utility access covers is prohibited on any of the streets noted below between the hours of 6:00 AM and midnight unless the utility or Contractor files for an Emergency Authorization Number as required by section 2-07 of the Department of Transportation's Highway Rules. The planned opening of utility access covers may occur during the hours of 12:01 AM and 5:59 AM where no authorization number is required.

Temporary restoration of the streets and sidewalks and removal thereof, if required for the Holiday Embargo period, will be paid for under the appropriate scheduled items.

No extension of time due to the shutdown period will be granted to the Contractor for completion of the work.

D. DISPOSAL OF EXCESS EXCAVATED MATERIAL. All excess excavated material, with the exception of contaminated material, shall become the property of the Contractor and shall be properly disposed of away from the site, at the Contractor's expense. Contaminated material shall be disposed of separately in accordance with contract requirements.

E. CONTRACT ITEMS THAT INCLUDE BACKFILL AS A PART OF THEIR WORK. The following shall pertain to all contract items that have backfill as a part of their work: Backfilling shall comply with Subsection 4.11.3 of the Standard Specifications and no additional payment will be made for any Highway or Street Lighting work item requiring Contractor to furnish additional fill material to meet these requirements when backfilling.

F. NOISE CONTROL. The Contractor is directed to Title 24, Chapter 2 of the Administration Code of the City of New York, known as the "New York City Noise Code" by the Department of Environmental Protection. The provisions of this code and its most recent additions and revisions shall apply to this contract. In the event of a conflict between the requirements of the New York City Noise Code and the requirements of Noise Control contained in these special notes, the more stringent of the two shall apply.

The Contractor shall plan and carry out work on this Project to ensure that the noise from construction equipment and activities does not exceed the limits specified herein. The noise abatement operations and conditions specified shall be carried out by the Contractor to limit noise in project and adjacent areas. The Contractor shall conduct a continuous educational effort for the workers on the site to ensure that they are aware of their roles in minimizing noise propagating from the site.

In order to monitor noise abatement operations the Contractor shall employ services of "Noise Control Specialist" for the duration of construction activity. The contractor shall submit qualifications and experience of the prospective specialist/firm to the Engineer for prior approval. The specialist/firm must satisfy the eligibility requirements of qualifications and work experience as required by the N.Y.C.D.E.P.

The monitoring protocol shall be as follows:

- (a) There shall be one outdoor and one indoor monitoring station for each work area or 1,000 ft. of street length whichever is less.
- (b) Monitoring of noise level shall be done prior to start of construction and during construction for each station at the same work hours specified in the contract.
- (c) Locations of monitoring stations shall be recommended by the noise control specialist for approval of the Engineer.
- (d) Engineer shall provide indoor station locations to the contractor after ascertaining availability of the said station from the Community Board.

Should the Contractor fail to carry out the noise abatement operations and conditions specified herein, the Engineer shall have the authority to suspend all work until such time as the Engineer deems that the Contractor has complied with the requirements.

The following additional requirements for noise control shall apply to this contract:

1. Noise Level Requirements for Construction Equipment

- (a) The Contractor shall ensure that all Contractor and Subcontractor equipment, of the types listed in Table A to be used on-site for a total duration greater than 5 days, shall be tested for compliance with the stated noise emission limits during the first day of use on the construction site or at an alternative site acceptable to the Engineer.
- (b) All equipment as described in (a) above shall be re-tested at 6 month intervals while in use on site.
- (c) All compliance tests shall be performed by the Contractor.
- (d) For each piece of equipment tested, the Contractor shall provide a noise report to the Engineer as shown in Figure A.
- (e) Equipment of the types listed in Table A, as described above, shall not be used on-site without valid certificates of noise compliance.
- (f) The Contractor shall provide to the Engineer two noise meters meeting the requirements of Section 2(d) herein. Two acoustic calibrators of the type recommended by the meter manufacturer shall also be provided.

TABLE A

CONSTRUCTION EQUIPMENT NOISE EMISSION LIMITS:  
MEASURED AT 50 FEET FROM CONSTRUCTION EQUIPMENT

<u>Equipment Category</u>	<u>Noise Level, dBA(SLOW)</u>
Auger	83
Backhoe	80
Bar Bender	80
Cherry Picker	80
Chain Saw	86
Compactor	80
Compressor	70
Concrete Mixer	86
Concrete Pump	82
Concrete or Diamond Saw	90
Crane	86
Crawler Miller	90
Dozer	86
Front End Loader	80
Generator	82
Gradall	86
Grader	86
Jackhammer	88
Man Lift	80
Mounted Impact Hammer	95
Paver	86
Pneumatic Tools	86
Roller	80
Scraper	86
Shotcrete Liner (tire-mounted)	79
Striper (walk-behind)	80
Tractor	84
Traffic Line Remover	80
Truck (including truck-mounted equipment)	84
Vibrator	80
Vibratory Pile Driver	95
All Other Equipment with Engines Larger than 3750W	86
Impact Pile Driver	105 dBC (FAST)

FIGURE A

CERTIFICATE OF EQUIPMENT NOISE COMPLIANCE

Contractor Name: \_\_\_\_\_  
Contract Name & Number: \_\_\_\_\_

Equipment Type: \_\_\_\_\_  
Manufacturer & Model Number: \_\_\_\_\_  
Identification Number: \_\_\_\_\_  
Rated Power & Capacity: \_\_\_\_\_  
Operating Condition During Test: \_\_\_\_\_

Measured Sound Levels at 6 to 15 meters:

Measured Values and Distance:

Engine-Powered or Concrete-Breaking Equipment:

Right Side: \_\_\_\_\_ dBA (SLOW), at \_\_\_\_\_ meters

Left Side: \_\_\_\_\_ dBA (SLOW), at \_\_\_\_\_ meters

Impact Pile Driving Equipment:

Right Side: \_\_\_\_\_ dBC (FAST), at \_\_\_\_\_ meters

Left Side: \_\_\_\_\_ dBC (FAST), at \_\_\_\_\_ meters

Equivalent Values at 50 Feet Distance:

Engine-Powered or Concrete-Breaking Equipment:

Right Side: \_\_\_\_\_ dBA (SLOW).

Left Side: \_\_\_\_\_ dBA (SLOW).

Impact Pile Driving Equipment:

Right Side: \_\_\_\_\_ dBC (FAST).

Left Side: \_\_\_\_\_ dBC (FAST).

Maximum Values Allowed for this Equipment: \_\_\_\_\_ dBA (SLOW) at 15 meters  
\_\_\_\_\_ dBC (FAST) at 15 meters

If equipment sound level exceeds maximum value allowed, indicate action taken to achieve compliance:

\_\_\_\_\_  
\_\_\_\_\_  
\_\_\_\_\_

Name, Work Address & Phone No. \_\_\_\_\_  
of NYSDOT Inspector \_\_\_\_\_  
\_\_\_\_\_  
\_\_\_\_\_

Authorized Signature: \_\_\_\_\_ Date: \_\_\_\_\_

CONTRACTOR'S ACCEPTANCE: \_\_\_\_\_ Date: \_\_\_\_\_

2. Noise Level Test Procedures of Construction Equipment

- (a) All engine-powered equipment shall be operated by the Contractor or Contractor's representative at high idle (maximum governed rpm) under full load conditions during the tests.
- (b) Portable and mounted impact hammers, such as hoe rams and jackhammers to be used to concrete breaking, shall be tested during the first day of actual operation at the construction site under maximum load conditions as rated by the equipment manufacturer.
- (c) Pile driving equipment shall be tested at the construction site under maximum load conditions as rated by the manufacturer.
- (d) All noise certification measurements shall be performed with an instrument that is in compliance with the criteria for a Type 1 (Precision) or Type 2 (General Purpose) Sound Level Meter as defined in the current revision of ANSI Standard S1.4. An acoustic calibrator of the type recommended by the sound level meter manufacturer shall be used prior to all measurements.
- (e) If possible, measurements shall be made at 50 feet ( $\pm 1.5$  feet) from the right and left sides of the equipment casing, at a height of 5 feet above ground level, with the equipment operating as indicated in items (a), (b) or (c) above for a minimum period of 1 minute. Measurements made at less than 50 feet, because of space limitations at the test site, shall be reduced by the values given in Table B to estimate the 50-foot sound level.

TABLE B

ADJUSTMENTS FOR CLOSE-IN EQUIPMENT NOISE MEASUREMENTS

Measurement Values to be Subtracted from Measured Sound Level  
Distance (Feet) to Estimate Sound Level at 50 Feet (dBA)

20 to under 21	8
21 to under 23	7
23 to under 26	6
26 to under 29	5
29 to under 33	4
33 to under 37	3
37 to under 41	2
41 to under 47	1
47 to under 50	0

3. Compliance with Equipment Noise Level Requirements

- (a) The Engineer shall retain a copy of the noise report from the Contractor with each piece of equipment used on the project of the types listed in Table A. The report shall be on the form shown in Figure A with certification by the noise control specialist hired by the contractor that equipment noise emissions do not exceed those prescribed.
- (b) If the noise levels obtained during the tests exceed those specified in Table A the Contractor shall promptly modify or alter such equipment and retest, or substitute other equipment to meet the noise level requirements.
- (c) Upon compliance, (including the certification date and equipment identification number) the Engineer will keep the noise reports readily available on file in the Construction field office for inspection upon request.
- (d) The Certification of Noise Compliance will remain valid for a period of 6 months only. Delays caused by certification refusal or by time lost in improving the rejected equipment or finding alternate acceptable equipment shall not be a basis for any monetary or time delay claims or for avoidance of late completion penalties.
- (e) All equipment shall be subject to spot noise level testing by the Engineer at his discretion as necessary to determine that the equipment in use meets the requirements specified in Table A. For this purpose, the Contractor shall furnish noise-measurement instrumentation that complies with the standards specified in paragraph 2. (d). If such tests are requested by the Engineer, the Contractor shall locate and operate the equipment as directed by the Engineer so as to facilitate the measurements. The Engineer shall provide the Contractor with a copy of the results of the measurements. If such tests demonstrate that any equipment does not comply with the requirements specified in Table A, its Certificate of Noise Compliance shall be revoke and equipment shall be taken out of use until compliance is achieved. A new Certificate of Noise Compliance will then be issued.

4. Construction Noise Level Exposure Limits

- (a) In no case shall the public be exposed to construction noise levels exceeding 100 dBA (SLOW) or to impulsive noise levels exceeding 125 dBC (FAST).
- (b) Construction activities shall be conducted in such a manner that the equivalent noise level (Leq) over any one-hour period does not exceed 85 dBA at any noise-sensitive locations (e.g. residence and hotels).

5. Construction Noise Level Exposure Test Procedures

- (a) All noise exposure measurements will be performed with an integrating sound level meter. An acoustic calibrator will be used prior to all measurements.
- (b) The measurement microphone of the sound level meter shall be fitted with an appropriate windscreen, and will be located 1.5 meters above the ground and at least 5 feet away from the nearest sound-reflective surface for the tests.
- (c) Noise exposure measurements will be taken at noise-sensitive locations closest to the construction activities at least once each week and as dictated by construction activities. Measurement periods at each location shall be a minimum of one hour.
- (d) Construction noise exposure measurements will coincide with periods of maximum noise-generating construction activity, and will be performed during the construction phase or activity that the greatest potential to create annoyance or to exceed the noise exposure limits.

6. Compliance with Construction Noise Level Exposure Limits

- (a) Construction noise exposure data will be collected by the Contractor on a weekly basis. The noise report will include (1) a sketch indicating the locations of the measurements and of all nearby construction equipment operating during the measurement period, (2) the measured maximum A-weighted noise level at each location, in terms of dBA (SLOW), (3) the measured maximum C-weighted noise level, in terms of dBC (FAST) and (4) the measured one-hour Leq (in dBA).
- (b) In the event that the measured noise levels exceed the limits specified in paragraph 4 above, the Engineer will immediately notify the Contractor and the Contractor shall implement corrective actions as directed by the Engineer.
- (c) All construction activities will be subject to spot noise level testing by the Engineer at his discretion as necessary to determine that the noise levels meet the exposure limits specified in paragraph 4 above. If such tests demonstrate that the noise levels exceed the specified limits, the Contractor shall implement corrective actions as directed by the Engineer.

7. General Requirements for Construction Equipment Noise Control

- (a) The Contractor shall minimize the use of impact devices, such as jackhammers, pavement breakers, and hoe rams. Where possible, concrete crushers or pavement saws shall be used rather than hoe rams for tasks such as grillage removal and pavement demolition.
- (b) All pneumatic impact tools and equipment used at the construction site shall have intake and exhaust mufflers

recommended by the manufacturers thereof, to meet relevant noise ordinance limitations.

- (c) All impact devices (i.e. jackhammers and pavement breakers) shall be equipped with acoustically attenuating shields or shrouds recommended by the manufacturers thereof, to meet relevant noise ordinance limitations.
  - (d) Hoppers, conveyors transfer points, storage bins, and chutes shall be lined or covered with sound-deadening material.
  - (e) The Contractor shall minimize the use of air or gasoline-driven hand tools.
  - (f) All other equipment, including internal combustion engines, shall have mufflers and shield paneling recommended by the manufacturers thereof.
8. General Operational Requirements for Construction Noise Control
- (a) The Contractor shall operate equipment so as to minimize banging, clattering, buzzing, and other annoying types of noises, especially near noise-sensitive locations.
  - (b) The Contractor, to the extent feasible, shall configure the construction site in a manner that keeps noisier equipment and activities as far as possible from noise-sensitive locations and nearby buildings.
  - (c) The Contractor shall minimize noise from the use of backup alarms near residential buildings by using self-adjusting, ambient noise-sensitive backup alarms that meet OSHA regulations.
  - (d) In no case shall the above restrictions limit the Contractor's responsibility for compliance with all applicable Federal, state and local safety ordinances and regulations and other sections of these construction specifications.

9. Acoustic Shed Requirements

- (a) All noise-generating mechanical equipment that is operated by the Contractor at any time other than weekdays between the hours of 7:00 a.m. and 6:00 p.m. shall be enclosed within an acoustic shed. Such equipment includes, but is not limited to, generators for traffic sign boards and lighting.
- (b) Acoustic sheds shall consist of three-sided, closed-top enclosures, oriented such that the open end of the shed faces away from residential or hotel buildings.
- (c) The shed shall be constructed of 0.5 inch plywood sheeting, or other acceptable material weighing at least 1.5 pounds per square foot, on timber framing with no gaps at joints or corners. Gaps between the bottom edge of the shed panels and



the ground shall not exceed 1 inch in width and shall be closed off with solid strips of rubber, neoprene or other suitably dense material.

- (d) The inside of the shed shall be lined with glass fiber or mineral wool type sound-absorbing material at least 2 inches thick, protected by wire mesh or perforated sheets that have at least 30 percent open area.

#### 10. Cost of Work

- (a) The cost of all labor, materials, equipment, insurance necessary for noise abatement measures as described in this section, any necessary modifications of construction methods or equipment and any delays to construction due to work suspension due to non-compliance with noise control requirements or due to necessary modifications to construction methods for compliance with the noise control requirements is deemed included in the prices bid for the items of work for which the equipment is used.

G. SCHEDULE OF WORK. The Contractor shall be required to prepare a progress schedule, in accordance with the requirements of Article 9 of the Standard Construction Contract, based on simultaneously working at multiple locations using multiple crews during the construction of the contract, as approved by the Engineer.

Each work force crew shall be defined as a sufficient number of workers with support staff and equipment necessary to perform the work efficiently as directed by the Engineer. Where the Contractor can demonstrate to the Engineer that he has substantially completed work, he may be permitted to start work at additional locations, on a one to one basis, at the sole discretion of the Engineer.

Where the Contractor's work operations are not able to meet its approved progress schedule, the Engineer may order the Contractor to provide additional work force as may be necessary. Failure to comply with such orders within seven (7) calendar days after the written notice from the Engineer may result in the Contractor being declared in default of the Contract in accordance with the procedure contained in Article 48 of the Standard Construction Contract.

H. SCHEDULING PRESENTATION. The Contractor shall submit construction schedule in the form of a bar chart using "Microsoft Project 2010", or in an approved equivalent program which shall be directly and fully translatable into Microsoft Project 2010 format, within seven days of the initial Pre-Construction Meeting. Each bar in the chart shall show dates the Contractor plans to start and complete each construction activity after the initial Pre-Construction Meeting. Bar chart shall show the order and interdependence of all activities necessary to complete the work and the sequence in which activity is to be accomplished as planned by the Contractor and in accordance with all subcontractors or suppliers whose work shall be shown on the bar chart. The Contractor shall submit the bar chart for the Engineer's review and revise it, if required, until approved by the Engineer.

The Contractor shall submit weekly progress status update reports or as otherwise directed by the Engineer. The Contractor shall submit updated bar chart every month. The revised bar chart shall be made in the same form and detail as the original submittal and shall be accompanied by an explanation of the reasons for the revisions all of which shall be subject to approval by the Engineer.

I. ACCELERATED PROJECT SCHEDULE AND COMBINATION OF STAGES.

Contractor shall plan and/or stage its work schedule using all hours/days available. Contractor is advised that all applicable unit prices shall include, for the purpose of this contract, all overtime costs, premium time costs, shift differentials required to complete construction within the specified "Time(s) of Completion" stipulated in this contract.

Contractor shall be permitted to accelerate this project, to combine stages and/or work sequences. Any such changes shall be shown in the construction schedule, to be furnished in accordance with the General Provisions of the Standard Specifications and the above "SCHEDULING PRESENTATION" Article, and shall be submitted for approval of the Engineer.

J. NO EXTENSION OF TIME FOR WINTER SHUT-DOWN. Where the Contractor's approved work schedule for installing sidewalk, curb, roadway base and/or pavement falls within the winter period of December 1st through April 1st, the Contractor will NOT be granted an extension of time for completion of this contract due to the winter shut-down period, unless otherwise provided in Schedule A.

K. PRIVATE UTILITY HARDWARE ADJUSTMENTS will be performed by the owning utility company or its agent, at its expense. The Contractor shall notify the utility company 72 hours prior to start of work at each location where its hardware requires adjustment.

L. SURVEY MONUMENTS. When working in the vicinity of survey monument the Contractor shall hand excavate per Item 8.02 A and 8.02 B at City Survey Monuments, for a distance of five (5) feet around each monument, as directed by the Engineer.

M. RESTORATION OF ADJACENT AREAS. The Contractor shall be required to remove all form work. In planting strip areas, the Contractor shall be required to restore areas damaged as a result of his operations, to the satisfaction of the Engineer, with sod. The Contractor shall also, as directed by the Engineer, make safe adjacent areas to his work, such as: restoring missing or damaged pavement markings that were removed or damaged as a result of the Contractor's operations (as per requirements of Section 6.44 in the Standard Specifications); resetting granite blocks in tree pits; and, applying asphaltic concrete mixture (Item 4.02 CB) where badly broken sidewalk or curb may create a dangerous condition just outside his area of operation, where and when directed by the Engineer.

All restoration work shall be done to the satisfaction of the Engineer.

N. RAILROAD FACILITIES REQUIREMENTS. The following provisions shall apply, as necessary, should any railroad facilities pass over or under this project:

- (1) If any manhole covers are raised or lowered, cables in the manholes shall be protected by wood sheeting of two-inch nominal thickness.
- (2) Tractors, cranes, excavators, etc., used in the vicinity of an elevated structure, shall be isolated from ground. Since the elevated structure is used as a negative return path with a consequent potential between it and ground, any contact between the structure and grounded equipment could result in burning of the steel.
- (3) There shall be no machine excavation in the vicinity of power duct lines until such duct lines have been carefully exposed by hand excavation.
- (4) Duct lines must be maintained and protected during construction.
- (5) All lumber and plywood used for the protection of transit facilities must be fire retardant.
- (6) Construction materials or equipment shall not be stored on subway ventilators or gratings. Subway emergency exits must be kept clear at all times.
- (7) In excavating over or near the subway roof, special care shall be exercised so that the thin concrete protection of the subway waterproofing is not damaged.
- (8) The following Standard NYCT "Insurance Clauses" are to be made part of the Contract Documents. Proof that the necessary insurance is in effect will be required before work can commence.

O. N.Y.C. TRANSIT INSURANCE. The Contractor (Permittee) shall indemnify and save harmless the City of New York and the New York City Transit (Permitter) in accordance with the following "Insurance Requirements" and proof that the necessary insurance is in effect will be required before work can commence:

NYCT "OUTSIDE CONTRACT" INSURANCE REQUIREMENTS

1. The Permittee at its sole cost and expense shall carry or cause to be carried and shall maintain at all times during the period of performance under this Agreement policies of insurance as herein below set forth below:
  - (A) Workers' Compensation Insurance (including Employer's Liability Insurance) with limits as specified in Schedule A, which limit may be met by a combination of primary and excess insurance meeting the statutory limits of New York State. The policy shall

be endorsed to include Longshoreman's and Harbor Workers' Compensation Act/Maritime Coverage Endorsement and/or Jones Act Endorsement when applicable.

- (B) Commercial General Liability Insurance (I.S.O. 2001 Form or equivalent) approved by Permittor in the Permittee's name with limits of liability as specified in Schedule A for each occurrence on a combined single limit basis for injuries to persons (including death) and damages to property. The limits may be provided in the form of a primary policy or combination of primary and umbrella/excess policy. When the minimum contract amounts can only be met when applying the umbrella/excess policy; the Umbrella/Excess Policy must follow form of the underlying policy and be extended to "drop down" to become primary in the event primary limits are reduced or aggregate limits are exhausted. Such insurance shall be primary and non-contributory to any other valid and collectable insurance and must be exhausted before implicating any Permittor/MTA policy available.

Such policy should be written on an occurrence form; and shall include:

- Contractual coverage for liability assumed by the Permittee under this agreement;
- Personal and Advertising Injury Coverage;
- Products-Completed. Operations;
- Independent Contractors Coverage;
- "XCU" coverage (Explosion, Collapse, and Underground Hazards) where necessary;
- Contractual Liability Exclusion, applicable to construction or demolition operations to be performed within 50 feet of railroad tracks, must be voided, where necessary; and,
- Additional Insured Endorsement (I.S.O. Form CG 20 26 07/04 version or equivalent) approved the Permittor naming:

New York City Transit Authority (NYCTA), the Manhattan and Bronx Surface Transit Operating Authority (MaBSTOA), the Staten Island Rapid Transit Operating Authority (SlRTOA), MTA Capital Construction Co., the Metropolitan Transportation Authority (MTA) including its subsidiaries and affiliates, and the City of New York (as Owner).

- (C) Business Automobile Liability Insurance Policy - (I.S.O. Form CA 00 01 10 01 or equivalent) approved by the Permittor is required if Permittee's vehicle enters Permittor property. The insurance must be in the name of the Permittee or its contractor entering the Permittor property with limits of liability in the amount specified in Scheule "A" for claims for bodily injuries (including death) to persons and for damage to property arising out of the ownership, maintenance or use of any owned, hired or non-owned motor vehicle.

(D) Railroad Protective Liability Insurance policy shall be required as specified in Schedule A.

(E) Environmental/Pollution Exposures

In the event environmental or pollution exposures exist, the Permittee shall require the environmental contractor or subcontractor to provide the applicable insurance covering such exposure. The limits and type of insurance provided shall be satisfactory to the Permitter and will be confirmed to the parties prior to the start of the work.

2. General Requirements Applicable to Insurance Policies

- a) All of the insurance required by this Article shall be with Companies licensed or authorized to do business in the State of New York with an A.M. Best Company rating of not less than A-/VII or better and reasonably approved by the Permitter/MTA and shall deliver evidence of such policies.
- b) Except for Workers Compensation, all references to forms and coverages referred to above shall be the most recent used by the Insurance Services Office, Inc. (ISO") or equivalent forms approved by the Insurance Department of the State of New York, provided, however, that excess coverages may be written on forms reasonably acceptable to Permitter containing provisions other than those contained in ISO forms but otherwise conforming in substance to the requirements of this Article.
- c) The Permittee or its Contractor performing the work shall furnish evidence of all policies before any work is started to the permitter:

For NYCT Contract Inspection  
C/O Mr. John Malvasio  
Director, MOW Engineering  
130 Livingston Street, Room 8044F  
Brooklyn, NY 11201  
Telephone: (718) 694-1358

These policies must: (i) be written in accordance with the requirements of the paragraphs above, as applicable; (ii) be endorsed in form acceptable to include a provision that the policy will not be canceled, materially changed, or not renewed, unless otherwise indicated herein, at least thirty (30) days prior written notice to the Permitter c/o MTA Risk and Insurance

Management (MTA RIM) Department - Standards, Enforcement & Claims Unit, 2 Broadway - 21st floor, New York, NY 10004; and (iii) state or be endorsed to provide that the coverage afforded under the contractor's policies shall apply on a primary and not on an excess or contributing basis with any policies which may be available to the Permitter/MTA, and also that the contractor's policies, primary and excess, must be exhausted before implicating any Permitter/MTA policy available. (iv) In addition, contractor's policies shall state or be endorsed to provide that, if a subcontractor's policy contains any provision

that may adversely affect whether contractor's policies are primary and must be exhausted before implicating any Permitter/MTA policy available, contractor's and subcontractor's policies shall nevertheless be primary and must be exhausted before implicating any Permitter/MTA policy available. Except for Professional Liability, policies written on claims made basis are not acceptable. At least two (2) weeks prior to the expiration of the policies, contractor shall endeavor to provide evidence of renewal or replacement policies of insurance, with terms and limits no less favorable than the expiring policies. Except as otherwise indicated in the detailed coverage paragraphs below, self insured retentions and policy deductibles shall not exceed \$100,000, unless such increased deductible or retention is approved by Permitter/MTA. The Permittee shall be responsible for all claim expense and loss payments within the deductible or self-insured retention. The insurance monetary limits required herein may be met through the combined use of the insured's primary and umbrella/excess policies.

- d) Certificates of Insurance may be supplied as evidence of policies of the above policies, except for Policy (D) Railroad Protective Liability Insurance Policy. However, if requested by the Permitter, the Permittee shall deliver to the Authority, within forty-five (45) days of be request, a copy of such policies, certified by the insurance carrier as being true and complete. The Railroad Protective Liability Insurance Policy must be provided in the form of the Original Policy. A detailed Insurance Binder may be provided, ACORD or Manuscript Form, pending issuance of the Original Policy. The Original Policy must be submitted to MTA RIM within 30 days of the Binder Approval.
- e) If a Certificate of Insurance is submitted, it must: (1) be provided on the Permitter Certificate of Insurance Form or MTA Certificate of Insurance Form for Joint Agency Agreements; (2) be signed by an authorized representative of the insurance carrier or producer and notarized; (3) disclose any deductible, self-insured retention, sub-limit, aggregate limit or any exclusions to the policy that materially change the coverage; (4) indicate the Additional Insureds and Named Insureds as required herein, along with a physical copy of the Additional Insured Endorsement (I.S.O. Form CG 20 26 07/04 version or equivalent), as applicable and the endorsement(s) must include policy number(s); (5) reference the Contract by number on the face of the certificate; and (6) expressly reference the inclusion of all required endorsements.
- f) The minimum amounts of insurance required in the detail description of policies (A), (B), (C), and (D) above shall not be construed to limit the extent of the Permittee's liability under this Agreement.
- g) If, at any time during the period of this Agreement, insurance as required is not in effect, or proof thereof is not provided to the Permitter, the Permitter shall have the options to: (1)

direct the Permittee to suspend work or operation with no additional cost or extension of time due on account thereof; or (ii) treat such failure as an Event of Default.

P. USE OF CITY WATER. The contractor is notified that for use of City water under this project the Contractor shall be required to obtain a water use permit from the Department of Environmental Protection at the Contractor's own cost.

Q. FUEL COST. The contractor is notified that the fuel cost per gallon used in the formula under Sub-Article 26.2.8 of the Standard Construction Contract for Extra Work will be derived from the fuel price index for the United States East Coast published weekly by the United States Energy Information Administration ("USEIA"), and available on its website at <http://www.eia.gov/petroleum/gasdiesel/>. The USEIA-published cost per gallon for the applicable fuel on the East Coast for the week in which the first day of each calendar quarter during the contract term occurs (i.e., January 1st, April 1st, July 1st and September 1st) will be used in the reimbursement formula for all Extra Work invoiced that was performed during that calendar quarter. Should the USEIA stop publishing this fuel price index, the fuel cost per gallon will be determined by reference to a substitute index to be agreed upon by the Contractor and the City.

R. ITEM NO. 6.52 FED. The contractor is notified that the Uniformed Flagpersons, under Item No. 6.52 FED, are to be paid not less than the most recent prevailing wages rates established for Laborers as determined by the NYC Comptroller or the US Department of Labor, whichever is higher at the time the work is being performed in accordance with the requirements of Section 6.52 FED in I - PAGES.

S. NIGHT TIME AND/OR WEEKEND DIFFERENTIAL. Any item of work ordered performed outside the normal permissible working hours of 7:00 A.M. and 6:00 P.M., Monday through Friday and/or between the hours of 6:00 P.M. Friday evening and 6:00 A.M. Monday morning, with the exception of Lump Sum items, will be paid at the unit price bid plus a ten (10%) percent night time and/or weekend differential. No differential will be applied to Lump Sum items.

T. ENGINEER'S FIELD OFFICE LOCATION. The Field Office shall be within 1/2 mile of the job site. Field offices located further than 1/2 mile from the job site shall require approval by the Assistant Commissioner for Construction.

U. VIBRATORY ROLLERS. The Contractor is notified that until further notice the use of vibratory rollers is prohibited within the project limits.

V. ARCHAEOLOGICAL DISCOVERIES. The Contractor is notified that the Resident Engineer will retain the services of an Archaeologist (the "City's Archaeologist") for this project.

The City's Archaeologist shall be notified in advance and shall be present on site during sub-surface excavations as he deems necessary. The City's Archaeologist shall be authorized to halt construction at any

time in order to record and/or recover any archaeological resources encountered during excavations, and to stabilize in place any human remains encountered. For the purpose of evaluating and recording archaeological resources, the City's Archaeologist shall be allowed to enter trenches provided all standard safety requirements are met. It is understood that some construction down time may be necessary.

In the event that human remains and/or other significant archaeological deposits are encountered during construction or archaeological investigations, Landmarks Preservation Commission (LPC) shall be notified as directed by the City's Archaeologist and the State Historic Preservation Office (SHPO) requires that the following protocol is implemented:

- At all times human remains must be treated with the utmost dignity and respect. Should human remains be encountered work in the general area of the discovery will stop immediately and the location will be immediately secured and protected from damage and disturbance.
- Human remains or associated artifacts will be left in place and not disturbed. No skeletal remains or materials associated with the remains will be collected or removed until appropriate consultation has taken place and a plan of action has been developed.
- The County coroner and local law enforcement as well as the SHPO and the involved agency will be notified immediately. The coroner and local law enforcement will make the official ruling on the nature of the remains, being either forensic or archeological. If the remains are archeological in nature, a bioarchaeologist will confirm the identification as human.
- If human remains are determined to be Native American, the remains will be left in place and protected from further disturbance until a plan for their protection or removal can be generated. The involved agency will consult SHPO and appropriate Native American groups to determine a plan of action that is consistent with the Native American Graves Protection and Repatriation Act (NAGPRA) guidance.
- If human remains are determined to be Euro-American, African-American, etc., the remains will be left in place and protected from further disturbance until a plan for their avoidance or removal can be generated. Consultation with the SHPO and other appropriate parties will be required to determine a plan of action.

Should extra work be ordered by the Resident Engineer as a result of any archaeological discoveries, it shall be paid for as extra work in accordance with the requirements of Article 26 in the Standard Construction Contract dated December 2013.

W. PRICES TO INCLUDE. No direct payment will be made for costs incurred in complying with the foregoing Special Provisions, unless otherwise provided. Said costs will be deemed to have been included in the prices bid for all the scheduled contract items.





## Department of Transportation

POLLY TROTTENBERG, Commissioner

### OCMC TRAFFIC STIPULATIONS

8-12-2016

**OCMC FILE NO:** QEC-16-300  
**CONTRACT NO:** SANDHW11  
**PROJECT:** RECONSTRUCTION OF BEACH CHANNEL DRIVE FROM BEACH 116 STREET TO BEACH 124 STREET  
**LOCATION(S):** ROCKAWAY (QUEENS)

PERMISSION IS HEREBY GRANTED TO THE **NYCDDC** AND ITS DULY AUTHORIZED AGENT, TO ENTER UPON AND RESTRICT THE FLOW OF TRAFFIC AT THE ABOVE LOCATION(S) FOR THE PURPOSE OF CARRYING OUT THE ABOVE NOTED PROJECT, SUBJECT TO THE STIPULATIONS, AS NOTED BELOW:

#### L. SPECIAL STIPULATIONS

- A. **EMBARGOES** – A CONSTRUCTION EMBARGO WILL APPLY TO THOSE LOCATIONS BELOW WHICH FALL WITHIN THE **HOLIDAY EMBARGO** OR ANY OTHER SPECIAL EVENT EMBARGOES PUBLISHED BY THE BUREAU OF PERMIT MANAGEMENT AND CONSTRUCTION CONTROL.
- B. **BIKE LANES** – IF WORK IS IN OR AFFECTING A BIKE LANE, THE PERMITEE MUST POST ADVANCE WARNING SIGNS 350 FEET AND 200 FEET PRIOR TO THE WORK ZONE STATING "CONSTRUCTION IN BIKE LANE AHEAD PROCEED WITH CAUTION", AND ALSO POST A SIGN AT THE WORK ZONE STATING "CONSTRUCTION IN BIKE LANE PROCEED WITH CAUTION". SUCH SIGNS SHALL BE ORANGE, 3' X 3', DIAMOND-SHAPED WITH 4" BLACK LETTERING. SIGNS SHALL BE POSTED IN ACCORDANCE WITH THE FEDERAL MANUAL ON UNIFORM TRAFFIC CONTROL DEVICES (MUTCD).
- C. **BIKE SHARE STATIONS:** THE PERMITEE SHALL NOT REMOVE, RELOCATE, DAMAGE OR DISRUPT THE OPERATION OF EXISTING BIKE SHARE STATIONS WITHOUT FIRST CONTACTING NYC BIKE SHARE AT 123 ST B55-245-3311 FOR THEIR REQUIREMENTS PRIOR TO COMMENCING WORK.
- D. **CITYBENCH:** THE PERMITEE SHALL NOT REMOVE, RELOCATE, DAMAGE OR DISRUPT AN EXISTING CITYBENCH WITHOUT FIRST CONTACTING NYC DOT AT 212-839-6569, OR VIA EMAIL AT [CITYBENCH@DOT.NYC.GOV](mailto:CITYBENCH@DOT.NYC.GOV) PRIOR TO COMMENCING WORK.
- E. **PROTECTION OF NYC DEP GREEN INFRASTRUCTURE:** THE PERMITEE SHALL TAKE PRECAUTION OF NYC DEP GREEN INFRASTRUCTURE IN THE RIGHT-OF-WAY. THE PERMITEE MUST PROTECT NYC DEP GREEN INFRASTRUCTURE DOWNSTREAM OF THE WORK OR WITHIN FIVE (5) FEET OF THE WORK AREA. THE PERMITEE MUST EMAIL NYC DEP AT [SUSTAINABILITY@DEP.NYC.GOV](mailto:SUSTAINABILITY@DEP.NYC.GOV) FOR PROTECTION REQUIREMENTS PRIOR TO COMMENCING WORK. THE PERMITEE IS RESPONSIBLE FOR RESTORATION OF DAMAGED NYC DEP INFRASTRUCTURE AS DIRECTED BY NYC DEP.
- F. **BUS STOPS** – THE PERMITEE SHALL PROVIDE WRITTEN NOTICE TO NYC DOT OCMC AND NEW YORK CITY TRANSIT (NYCT) A MINIMUM OF FIVE (5) WEEKS IN ADVANCE FOR LANE/STREET CLOSURES THAT AFFECT BUS ROUTES/BUS STOPS.
- G. **STREET LIGHTS / TRAFFIC SIGNALS:** THE PERMITEE SHALL NOT REMOVE OR RELOCATE EXISTING STREET LIGHTS OR TRAFFIC SIGNALS WITHOUT FIRST OBTAINING APPROVAL FROM NYCDOT STREET LIGHTING / TRAFFIC SIGNALS UNIT.
- H. **TRAFFIC CAMERAS, DETECTION/COMMUNICATION EQUIPMENT:** IF AT ANY TIME DURING THE APPROVED WORK, THE PERMITEE ENCOUNTERS TRAFFIC SURVEILLANCE CAMERAS, DETECTION EQUIPMENT OR ANY TYPE OF COMMUNICATION EQUIPMENT (WIRESS OR HARD-WIRED) ON ANY NYC DOT FACILITY, THAT IS NOT INCLUDED ON THE DESIGN/BUILD DRAWINGS, THE PERMITEE SHALL IMMEDIATELY NOTIFY NYC DOT TRAFFIC MANAGEMENT BY PHONE AT 718-433-3390 OR 718-433-3340 AND VIA EMAIL AT [IMC@DOT.NYC.GOV](mailto:IMC@DOT.NYC.GOV) AND AWAIT DIRECTION PRIOR TO CONTINUING WORK.
- I. **METERS** – THE PERMITEE SHALL NOT REMOVE OR RELOCATE PARKING METERS WITHOUT FIRST OBTAINING APPROVAL FROM NYCDOT PARKING METER DIVISION AT 718-894-8651.
- J. **TEST PITS** – THE BELOW TRAFFIC STIPULATIONS DO NOT APPLY TO TEST PIT WORK RELATED TO THIS CONTRACT. WORK HOURS AND OTHER REQUIREMENTS FOR TEST PIT OPERATIONS MAY DIFFER FROM THE STIPULATIONS IDENTIFIED BELOW. THE PERMITEE SHALL BE REQUIRED TO OBTAIN SEPARATE PERMITS RELATED TO TEST PITS.
- K. **TEMPORARY PARKING REGULATIONS/PAVEMENT MARKINGS** – THE PERMITEE IS REQUIRED TO INSTALL, MAINTAIN AND REMOVE ALL NECESSARY TEMPORARY PARKING AND REGULATORY SIGNS AND PAVEMENT MARKINGS, AND RESTORE THEIR ORIGINAL CONDITION PER NYC DOT STANDARDS, PRIOR TO EXPIRATION OF THEIR PERMITS. THE PERMITEE OR AGENCY PERFORMING PUBLIC OUTREACH SHALL POST AND MAINTAIN ADVISORY SIGNS A MINIMUM OF 48 HOURS PRIOR TO CHANGING EXISTING PARKING REGULATION SIGNS TO APPROVED TEMPORARY CONSTRUCTION PARKING REGULATION SIGNS. THE ADVISORY SIGNS SHOULD BE POSTED ON ALL POLES AND DRIVE RAILS ON THE SEGMENT AFFECTED, INDICATING THE DATE OF THE CHANGE, THE NEW REGULATIONS AND A TELEPHONE NUMBER TO OBTAIN MORE INFORMATION.

NYC Department of Transportation  
 Bureau of Permit Management and Construction Control  
 55 Water Street - 7<sup>th</sup> Floor, New York, NY 10041  
 T: 212.839.9621 F: 212.839.8970  
[www.nyc.gov/dot](http://www.nyc.gov/dot)

OCMC FILE NO: QEC-16-300  
 CONTRACT NO: SANDHW11  
 PROJECT: RECONSTRUCTION OF BEACH CHANNEL DRIVE

8-12-2016  
 Page 2 of 7

- L. **ACCESS TO ABUTTING PROPERTIES** – THE PERMITTEE SHALL COORDINATE ALL ACTIVITIES WITH ABUTTING PROPERTY OWNERS TO ENSURE ACCESS IS PROVIDED TO/FROM ENTRANCES/DRIVEWAYS AT ALL TIMES.
- M. **AUTHORIZED PARKING** – PRIOR TO PERFORMING WORK WHICH IMPACTS AUTHORIZED PARKING, THE PERMITTEE SHALL SUBMIT IN WRITING, AND COPY OCMC STREETS, A REQUEST TO OCCUPY SPACE CURRENTLY USED BY AUTHORIZED VEHICLES. APPROVAL MUST BE RECEIVED FROM AUTHORIZED PARKING PRIOR TO OCCUPYING THESE AREAS.
- N. **NOTIFICATION** – THE PERMITTEE MUST AT LEAST TWO (2) WORKING DAYS BEFORE THE START OF CONSTRUCTION NOTIFY THE NYC FIRE DEPARTMENT, NYC POLICE DEPARTMENT, NYCEMS, LOCAL COMMUNITY BOARD, BOROUGH PRESIDENT'S OFFICE-CHIEF ENGINEER, NYCDOT OCMC OFFICE, AND ALL ABUTTING PROPERTY OWNERS.
- O. **CONSTRUCTION INFORMATIONAL SIGNS** – THIS PROJECT REQUIRES A CONSTRUCTION PROJECT INFORMATIONAL SIGN (CPIS) IN ACCORDANCE WITH NYCDOT HIGHWAY RULE SECTION 2-02 (4) AND (5). CRITERIA AND A PROTOTYPE FOR THIS SIGN MAY BE FOUND ON THE NYCDOT WEBSITE AT:  
[HTTP://WWW.NYC.GOV/HTML/DOY/DOWNLOADS/PDF/DOY\\_CPIS\\_DIRECTIONSS.PDF](http://www.nyc.gov/html/dot/downloads/pdf/dot_cpis_directions.pdf)
- P. **ENHANCED MITIGATIONS**
- o **ENHANCED MITIGATIONS FOR PEDESTRIAN FLOW**, INCLUDING METAL FENCING, SHALL BE PROVIDED TO ENSURE PEDESTRIANS STAY WITHIN THEIR DESIGNATED PATH/ROUTE. PEDESTRIAN MANAGERS SHALL BE PROVIDED TO ASSIST WITH PEDESTRIANS AT THE DESIGNATED CROSSWALK AREAS.
  - o **"NO STANDING ANYTIME-TEMPORARY CONSTRUCTION" SIGNS** AND TEMPORARY PAVEMENT MARKINGS SHALL BE INSTALLED AND MAINTAINED AS WARRANTED BY THE MAINTENANCE AND PROTECTION OF TRAFFIC (MPT) REQUIRED TO FACILITATE TRAFFIC MOVEMENTS THROUGH THE WORK ZONE. ALL TEMPORARY SIGNS AND PAVEMENT MARKINGS SHALL BE REMOVED UPON COMPLETION OF THE PROJECT.
  - o **COMMUNITY OUTREACH** SHALL BE PROVIDED FOR THE DURATION OF THE PROJECT.

## II. MAINTENANCE AND PROTECTION OF TRAFFIC – STREET RECONSTRUCTION

### 1. BEACH CHANNEL DRIVE BETWEEN BEACH 108 STREET AND BEACH 116 STREET

1. Work hours for roadway reconstruction shall be as follows: 9am to 4pm Monday through Friday.
2. The permittee shall maintain a minimum of three 11 foot lanes for traffic at all times.
3. The permittee shall maintain a minimum of 5 feet wide sidewalk at all times.

### 2. BEACH CHANNEL DRIVE BETWEEN BEACH 116 STREET AND BEACH 125 STREET

1. Work hours for roadway reconstruction shall be as follows: 9am to 4pm Monday through Friday.
2. The permittee shall maintain a minimum of two 11 foot lanes for traffic at all times.
3. The permittee shall maintain a minimum of 5 feet wide sidewalk at all times.

### 3. BEACH 116 STREET BETWEEN NEWPORT AVENUE AND BEACH CHANNEL DRIVE

1. Work hours for roadway reconstruction shall be as follows: 9am to 4pm Monday through Friday.
2. The permittee shall maintain a minimum of two 11 foot lanes for traffic at all times.
3. The permittee shall maintain a minimum of 5 feet wide sidewalk at all times.

### 4. NEWPORT AVENUE BETWEEN BEACH 116 STREET AND BEACH 117 STREET

1. Work hours for roadway reconstruction shall be as follows: 9am to 4pm Monday through Friday.
2. The permittee shall maintain a minimum of two 11 foot lanes for traffic at all times.
3. When constructing bus pads, the permittee may occupy 12 feet of roadway and maintain two lanes for traffic with one lane in each direction during concrete curing.
4. The permittee shall not block buses from loading and unloading.
5. The permittee shall maintain a minimum of 5 feet wide sidewalk at all times.

### 5. CRONSTON AVENUE BETWEEN BEACH CHANNEL DRIVE AND BEACH 125 STREET

1. Work hours for roadway reconstruction shall be as follows: 9am to 4pm Monday through Friday.
2. The permittee shall maintain a minimum of one 11 foot lane for traffic at all times.
3. The permittee shall maintain a minimum of 5 feet wide sidewalk at all times.

### 6. BEACH 116 STREET (EASTBOUND) BETWEEN BEACH 116 STREET (NORTHBOUND) AND BEACH CHANNEL DRIVE

1. Work hours for roadway reconstruction shall be as follows: 9am to 4pm Monday through Friday.

OCMC FILE NO: QEC-16-300  
CONTRACT NO: SANDHW11  
PROJECT: RECONSTRUCTION OF BEACH CHANNEL DRIVE

8-12-2016  
Page 3 of 7

2. The permittee shall maintain one 12 foot lane for local and emergency access at all times.
3. The permittee shall maintain a minimum of 5 feet wide sidewalk at all times.

7. **BEACH 117 STREET BETWEEN BEACH CHANNEL DRIVE AND NEWPORT AVENUE**
8. **BEACH 118 STREET BETWEEN BEACH CHANNEL DRIVE AND NEWPORT AVENUE**
9. **BEACH 119 STREET BETWEEN BEACH CHANNEL DRIVE AND NEWPORT AVENUE**
10. **BEACH 120 STREET BETWEEN BEACH CHANNEL DRIVE AND NEWPORT AVENUE**
11. **BEACH 121 STREET BETWEEN BEACH CHANNEL DRIVE AND NEWPORT AVENUE**
12. **BEACH 122 STREET BETWEEN BEACH CHANNEL DRIVE AND NEWPORT AVENUE**
13. **BEACH 123 STREET BETWEEN BEACH CHANNEL DRIVE AND NEWPORT AVENUE**
14. **BEACH 124 STREET BETWEEN BEACH CHANNEL DRIVE AND NEWPORT AVENUE**

1. Work hours for roadway reconstruction shall be as follows: 7am to 6pm Monday through Friday.
2. The permittee shall maintain one 12 foot lane for local and emergency access at all times.
3. The permittee shall maintain a minimum of 5 feet wide sidewalk at all times.

**15. BEACH CHANNEL DRIVE AND BEACH 116 STREET**

1. Work hours shall be as follows: 9am to 4pm Monday through Friday.
2. During and after working hours the permittee shall maintain a minimum of three 11 foot lanes for traffic on Beach Channel Drive east of Beach 116 Street and two 11 foot lanes for traffic west of Beach 116 Street and two 11 foot lanes for traffic on Beach 108 Street.

**16. BEACH 116 STREET (NORTHBOUND) AND NEWPORT AVENUE AND BEACH 116 STREET (EASTBOUND)**

1. Work hours shall be as follows: 9am to 4pm Monday through Friday.
2. During and after working hours the permittee shall maintain a minimum of two 11 foot lanes for traffic on Beach 116 Street and on Newport Avenue and maintain one 11 foot lane for traffic on Beach 116 Street.

**17. BEACH CHANNEL DRIVE AND CRONSTON AVENUE**

1. Work hours shall be as follows: 9am to 4pm Monday through Friday.
2. During and after working hours the permittee shall maintain a minimum of two 11 foot lanes for traffic on Beach Channel Drive and one 11 foot lane for traffic on Cronston Avenue.

**18. CRONSTON AVENUE AND BEACH 123 STREET**

1. Work hours shall be as follows: 9am to 4pm Monday through Friday.
2. During and after working hours the permittee shall maintain one 11 foot lane for traffic on both roadways.

19. **BEACH CHANNEL DRIVE AND BEACH 116 Street**
20. **BEACH CHANNEL DRIVE AND BEACH 117 Street**
21. **BEACH CHANNEL DRIVE AND BEACH 118 Street**
22. **BEACH CHANNEL DRIVE AND BEACH 119 Street**
23. **BEACH CHANNEL DRIVE AND BEACH 120 Street**
24. **BEACH CHANNEL DRIVE AND BEACH 121 Street**
25. **BEACH CHANNEL DRIVE AND BEACH 122 Street**
26. **BEACH CHANNEL DRIVE AND BEACH 123 Street**
27. **BEACH CHANNEL DRIVE AND BEACH 124 Street**

1. Work hours shall be as follows: 9am to 4pm Monday through Friday.
2. During and after working hours the permittee shall maintain a minimum of two 11 foot lanes for traffic on Beach Channel Drive and one 11 foot lane for traffic on the cross street.

OCMC FILE NO: QEC-16-300  
 CONTRACT NO: SANDHW11  
 PROJECT: RECONSTRUCTION OF BEACH CHANNEL DRIVE

8-12-2016  
 Page 4 of 7

**III. MAINTENANCE AND PROTECTION OF TRAFFIC – NEW SANITARY SEWER AND WATER MAIN WORK PHASE**

**28. BEACH CHANNEL DRIVE BETWEEN BEACH 108 STREET AND BEACH 124 STREET**

**29. BEACH 116 STREET BETWEEN ROCKWAY BEACH BOULEVARD AND BEACH CHANNEL DRIVE**

**30. NEWPORT AVENUE BETWEEN BEACH 116 STREET AND BEACH 117 STREET**

1. Work hours shall be as follows: 9am to 4pm Monday through Friday.
2. During work hours for new sanitary sewer and water main work, the permittee shall maintain two 11 foot travel lanes for traffic with one lane in each direction.
3. After working hours the permittee shall restore all travel lanes to traffic. The permittee may contain 25 linear feet, 8 feet adjacent to the curb during non-work hours. Containment is only to restrict parking and for storage of excavated material/fill.
4. The permittee shall maintain a minimum of 5 feet wide sidewalk or 5 feet wide protected pedestrian walkway in the roadway at all times.

**31. CRONSTON AVENUE BETWEEN BEACH CHANNEL DRIVE AND BEACH 124 STREET**

1. Work hours shall be as follows: 9am to 4pm Monday through Friday.
2. During work hours for new sanitary sewer and water main work, the permittee shall maintain one 11 foot travel lane for traffic.
3. After working hours the permittee shall restore all travel lanes to traffic. The permittee may contain 25 linear feet, 8 feet adjacent to the curb during non-work hours. Containment is only to restrict parking and for storage of excavated material/fill.
4. The permittee shall maintain a minimum of 5 feet wide sidewalk or 5 feet wide protected pedestrian walkway in the roadway at all times.

**32. BEACH 116 STREET (EASTBOUND) BETWEEN BEACH CHANNEL DRIVE AND BEACH 116 STREET (NORTHBOUND)**

1. Work hours shall be as follows: 9am to 4pm Monday through Friday.
2. During work hours for new sanitary sewer and water main work, the permittee shall maintain one 12 foot lane for local and emergency access.
3. After working hours the permittee shall restore all travel lanes to traffic. The permittee may contain 25 linear feet, 8 feet adjacent to the curb during non-work hours. Containment is only to restrict parking and for storage of excavated material/fill.
4. After sewer work hours:
  - a. The Permittee shall maintain one (1) 12-foot lane for local and emergency traffic. In areas where the roadway is not wide enough to allow for local and emergency traffic, the Permittee's work shall not exceed one hundred (100) linear feet, so that the NYC Fire Department/EMS and the NYC Police Department can have access to the local residents on the affected street segment. The work area shall include the excavated trench, equipment and stored materials necessary for the work.
  - b. It will be the Permittee's responsibility to inform the NYC Fire Department/EMS, NYC Police Department and local Community Board daily, in writing, including the location of the work area and the layout of the emergency access from either side of the work area. This notification shall be specific by the house number where possible. Representatives of the local NY Fire Battalion, NYC Police Department and the local Community Board shall sign such notice daily.
5. The permittee shall maintain a minimum of 5 feet wide sidewalk or 5 feet wide protected pedestrian walkway in the roadway at all times.

**33. BEACH 117 STREET BETWEEN BEACH CHANNEL DRIVE AND NEWPORT AVENUE**

**34. BEACH 118 STREET BETWEEN BEACH CHANNEL DRIVE AND NEWPORT AVENUE**

**35. BEACH 119 STREET BETWEEN BEACH CHANNEL DRIVE AND NEWPORT AVENUE**

**36. BEACH 120 STREET BETWEEN BEACH CHANNEL DRIVE AND NEWPORT AVENUE**

**37. BEACH 121 STREET BETWEEN BEACH CHANNEL DRIVE AND NEWPORT AVENUE**

**38. BEACH 122 STREET BETWEEN BEACH CHANNEL DRIVE AND NEWPORT AVENUE**

**39. BEACH 123 STREET BETWEEN BEACH CHANNEL DRIVE AND NEWPORT AVENUE**

**40. BEACH 124 STREET BETWEEN BEACH CHANNEL DRIVE AND NEWPORT AVENUE**

1. Work hours shall be as follows: 7am to 6pm Monday through Friday.

OCMC FILE NO: QEC-16-300  
 CONTRACT NO: SANDHW11  
 PROJECT: RECONSTRUCTION OF BEACH CHANNEL DRIVE

8-12-2016  
 Page 5 of 7

2. During work hours for new sanitary sewer and water main work, the permittee shall maintain one 12 foot lane for local and emergency access.
3. After working hours the permittee shall restore all travel lanes to traffic. The permittee may contain 25 linear feet, 8 feet adjacent to the curb during non-work hours. Containment is only to restrict parking and for storage of excavated material/fill.
4. After sewer work hours:
  - a. The Permittee shall maintain one (1) 12-foot lane for local and emergency traffic. In areas where the roadway is not wide enough to allow for local and emergency traffic, the Permittee's work shall not exceed one hundred (100) linear feet, so that the NYC Fire Department/EMS and the NYC Police Department can have access to the local residents on the affected street segment. The work area shall include the excavated trench, equipment and stored materials necessary for the work.
  - b. It will be the Permittee's responsibility to inform the NYC Fire Department/EMS, NYC Police Department and local Community Board daily, in writing, including the location of the work area and the layout of the emergency access from either side of the work area. This notification shall be specific by the house number where possible. Representatives of the local NY Fire Battalion, NYC Police Department and the local Community Board shall sign such notice daily.
5. The permittee shall maintain a minimum of 5 feet wide sidewalk or 5 feet wide protected pedestrian walkway in the roadway at all times.

**41. BEACH CHANNEL DRIVE AND BEACH 116 STREET**

**42. BEACH 116 STREET AND NEWPORT AVENUE**

1. Work hours shall be as follows: 9am to 4pm Monday through Friday.
2. During work hours the permittee shall maintain two 11 foot lanes for traffic with one lane in each direction on both roadways.
3. Full width of roadway shall be opened to traffic when site is unattended.

**43. BEACH CHANNEL DRIVE AND BEACH 116 STREET**

1. Work hours shall be as follows: 9am to 4pm Monday through Friday.
2. During work hours the permittee shall maintain one 12 foot lane for local and emergency access on Beach 116 Street and maintain two 11 foot lanes for traffic on Beach Channel Drive.
3. Full width of roadway shall be opened to traffic when site is unattended.

**44. BEACH 116 STREET (EASTBOUND) AND BEACH 116 STREET (NORTHBOUND)**

1. Work hours shall be as follows: 9am to 4pm Monday through Friday.
2. During work hours the permittee shall maintain one 12 foot lane for local and emergency access on Beach 116 Street and maintain two 11 foot lanes for traffic on Beach 116 Street.
3. Full width of roadway shall be opened to traffic when site is unattended.

**45. BEACH CHANNEL DRIVE AND BEACH 116 Street**

1. Work hours shall be as follows: 9am to 4pm Monday through Friday.
2. During work hours the permittee shall maintain one two 11 foot travel lanes on Beach Channel Drive and maintain one 12 foot lane for local and emergency access on the cross-street.
3. Full width of roadway shall be opened to traffic when site is unattended.

**46. CRONSTON AVENUE AND BEACH 123 STREET**

**47. CRONSTON AVENUE AND BEACH 124 STREET**

1. Work hours shall be as follows: 9am to 4pm Monday through Friday.
2. During working hours the permittee shall maintain one 11 foot lane for traffic on Cronston Avenue and maintain one 12 foot lane for local and emergency access on the cross-street.
3. Full width of roadway shall be opened to traffic when site is unattended.

**IV. GENERAL NOTES**

OCMC FILE NO: QEC-16-300  
 CONTRACT NO: SANDHW11  
 PROJECT: RECONSTRUCTION OF BEACH CHANNEL DRIVE

8-12-2016  
 Page 6 of 7

- A. ~~THIS IS NOT A PERMIT.~~ THIS STIPULATION SHEET MUST BE SUBMITTED WITH ALL REQUESTS FOR PERMITS PERTAINING TO THE ABOVE CONTRACT AND PRESENT AT THE WORK SITE ALONG WITH ALL ACTIVE CONSTRUCTION PERMITS WHEN THE APPROVED WORK IS BEING PERFORMED.
- B. THE PERMITEE MUST COMPLY WITH ALL CONSTRUCTION EMBARGOS ISSUED BY THE NYCDOT INCLUDING THE HOLIDAY EMBARGO.
- C. THE PERMITEE SHALL COMPLY WITH ALL REQUIREMENTS OF THE NYCDOT SPECIAL EVENTS UNIT AS IDENTIFIED BELOW:
1. STREET FAIRS / FESTIVALS
    - ALL EXCAVATIONS MUST BE PLATED WITH SKID RESISTANT PLATES.
    - PLATES MUST BE RECESSED AND FLUSH WITH PAVEMENT.
    - ALL PAVEMENT DEFECTS MUST BE CORRECTED WITHIN OR ADJACENT TO THE WORK ZONE.
    - THE CONTRACTOR IS RESPONSIBLE FOR ANY DEFECTS WITHIN THE IMMEDIATE VICINITY IF NYCDOT STREET & ARTERIAL MAINTENANCE CANNOT MAKE REPAIRS DUE TO PROJECT INTERFERENCE (AS DETERMINED BY NYCDOT).
    - ALL EQUIPMENT, TRAILERS AND MATERIAL STORAGE MUST BE REMOVED.
  2. RUNNING / WALKING / BIKING EVENTS
    - ALL EXCAVATIONS MUST BE BACKFILLED AND PAVED OR PLATES MUST BE RECESSED AND PAVED OVER FLUSH WITH PAVEMENT.
    - ALL PAVEMENT DEFECTS MUST BE CORRECTED WITHIN OR ADJACENT TO THE WORK ZONE.
    - THE CONTRACTOR IS RESPONSIBLE FOR ANY DEFECTS WITHIN THE IMMEDIATE VICINITY IF NYCDOT STREET & ARTERIAL MAINTENANCE CANNOT MAKE REPAIRS DUE TO PROJECT INTERFERENCE (AS DETERMINED BY NYCDOT).
    - ALL EQUIPMENT, TRAILERS AND MATERIAL STORAGE MUST BE REMOVED.
  3. PARADES
    - ALL EXCAVATIONS MUST BE BACKFILLED AND PAVED OR PLATES MUST BE RECESSED AND PAVED OVER FLUSH WITH PAVEMENT.
    - FORMATION AND DISPERSAL AREA PLATES MUST BE RECESSED AND FLUSH WITH PAVEMENT (PLATES MUST BE SKID RESISTANT).
    - ALL PAVEMENT DEFECTS MUST BE CORRECTED WITHIN OR ADJACENT TO THE WORK ZONE.
    - THE CONTRACTOR IS RESPONSIBLE FOR ANY DEFECTS WITHIN THE IMMEDIATE VICINITY IF NYCDOT STREET & ARTERIAL MAINTENANCE CANNOT MAKE REPAIRS DUE TO PROJECT INTERFERENCE (AS DETERMINED BY NYCDOT).
    - ALL EQUIPMENT, TRAILERS AND MATERIAL STORAGE MUST BE REMOVED.
  4. MAYORAL EVENTS
    - ALL EXCAVATIONS MUST BE BACKFILLED AND PAVED OR PLATES MUST BE RECESSED AND PAVED OVER FLUSH WITH PAVEMENT.
    - ALL PAVEMENT DEFECTS MUST BE CORRECTED WITHIN OR ADJACENT TO THE WORK ZONE.
    - THE CONTRACTOR IS RESPONSIBLE FOR ANY DEFECTS WITHIN THE IMMEDIATE VICINITY IF NYCDOT STREET & ARTERIAL MAINTENANCE CANNOT MAKE REPAIRS DUE TO PROJECT INTERFERENCE (AS DETERMINED BY NYCDOT).
    - ALL EQUIPMENT, TRAILERS AND MATERIAL STORAGE MUST BE REMOVED.
- D. ALL RELOCATION WORK BY THE UTILITIES SUCH AS; CON EDISON, TELEPHONE, GAS AND CABLE COMPANIES SHALL PRECEDE THE CONTRACTORS' START OF WORK ON ALL AFFECTED ROADWAYS IN THE IMPACTED CONTRACT AREA.
- E. THE CONTRACTOR IS ADVISED THAT OTHER CONTRACTORS MAY BE WORKING IN THE GENERAL AREA DURING THE TERM OF THIS STIPULATION. IN WHICH EVENT, THE CONTRACTOR MAY REQUIRE MODIFICATIONS BY THE OCMC-STREETS.
- F. THE PERMITEE IS NOT AUTHORIZED TO ENTER, OCCUPY OR USE ANY PUBLICLY-OWNED OR PRIVATELY OWNED, NON-PAVED, LANDSCAPE OR NON-LANDSCAPED LOCATION WITHOUT SPECIFIC WRITTEN PERMISSION. WHEN THE LOCATION IS WITHIN THE RIGHT-OF-WAY OF A LIMITED-ACCESS ARTERIAL HIGHWAY, WRITTEN APPROVAL FROM THE NYCDOT OCMC-HIGHWAYS IS REQUIRED. WHEN THE LOCATION IS WITHIN THE RIGHT-OF-WAY OF A PUBLIC STREET OR PUBLIC PARK, WRITTEN APPROVAL FROM THE NEW YORK CITY DEPARTMENT OF TRANSPORTATION OR NEW YORK CITY DEPARTMENT OF PARKS AND RECREATION IS REQUIRED. WHEN THE LOCATION IS WITHIN THE RIGHT-OF-WAY OF ANY OTHER JURISDICTION SUCH AS PRIVATE PROPERTY, STATE, FEDERAL ETC., IT IS THE PERMITEE'S RESPONSIBILITY TO DETERMINE THE PROPERTY OWNER AND OBTAIN THE WRITTEN APPROVAL.
- G. THE PERMITEE SHALL ADHERE TO THE NYCDOT BUREAU OF BRIDGES' SPECIAL PROVISIONS FOR LANDSCAPE PROTECTION, MAINTENANCE AND RESTORATION, ITEMS 1.18.15 THROUGH 1.18.19, WHENEVER AND WHEREVER ANY OF THE PERMITEE'S ACTIVITIES OCCUR WITHIN A LIMITED ACCESS ARTERIAL HIGHWAY RIGHT - OF - WAY.
- H. NO DEVIATION OR DEPARTURE FROM THESE STIPULATIONS WILL BE PERMITTED WITHOUT THE PRIOR WRITTEN APPROVAL FROM THE OCMC-STREETS. REQUEST FOR SUCH MODIFICATIONS SHALL BE SUBMITTED TO THE OFFICE OF THE OCMC-STREETS, NEW YORK CITY DEPARTMENT OF TRANSPORTATION, A MINIMUM OF TWENTY (20) DAYS IN ADVANCE FOR CONSIDERATION.
- I. FOR ANY CONSTRUCTION ACTIVITY RESULTING IN THE FULL CLOSURE OF A ROADWAY FOR MORE THAN 180 CONSECUTIVE CALENDAR DAYS, THE CONTRACTOR MUST PRODUCE AND SUBMIT A COMMUNITY REASSESSMENT, IMPACT AND AMELIORATION (CRIA) STATEMENT TO NYCDOT PLANNING AND OBTAIN THEIR APPROVAL BEFORE APPLYING FOR PERMITS, IN COMPLIANCE WITH THE PROVISIONS OF LOCAL LAW 24 STREET CLOSURE LAW.
- J. FOR THIS PROJECT THE CONTRACTOR SHALL FURNISH, INSTALL AND MAINTAIN ALL NECESSARY ADVANCE WARNING AND DETOUR SIGNS, TEMPORARY CONTROL DEVICES, BARRICADES, LIGHTS AND FLASHING ARROW BOARDS IN ACCORDANCE WITH THE "MANUAL ON

OCMC FILE NO: QEC-T6-300  
CONTRACT NO: SANDHW11  
PROJECT: RECONSTRUCTION OF BEACH CHANNEL DRIVE

8-12-2016  
Page 7 of 7

---

UNIFORM TRAFFIC CONTROL DEVICES," THE TYPICAL SCHEMES INCLUDED IN THIS SPECIFICATION; AND AS ORDERED BY THE ENGINEER-IN-CHARGE AND THE OCMC-STREETS.

- K. THE CONTRACTOR SHALL BE RESPONSIBLE FOR IDENTIFYING HIS CONSTRUCTION SIGNAGE. THE IDENTIFICATION SHALL INCLUDE THE CONTRACTOR'S NAME, SPONSORING AGENCY NAME AND THE CONTRACT NUMBER. THE IDENTIFICATION SHALL BE PLACED ON THE BACK OF THE SIGN. THE LETTERING SHALL BE THREE (3) INCHES HIGH.
- L. THE OCMC-STREETS RESERVES THE RIGHT TO VOID OR MODIFY THESE STIPULATIONS SHOULD CONSTRUCTION FAIL TO COMMENCE WITHIN TWO (2) YEARS OF THE SIGNED DATE OF THESE STIPULATIONS.

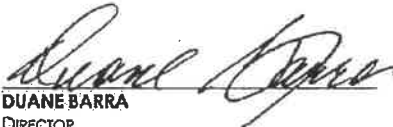
  
DUANE BARRA  
DIRECTOR  
OCMC-STREETS

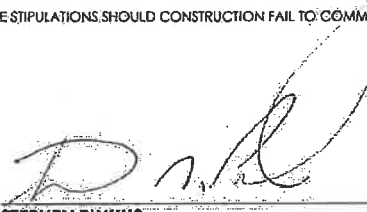
  
STEPHEN PINKUS  
PROJECT MANAGER  
OCMC-STREETS



## Department of Transportation

POLLY TROTTENBERG, Commissioner

**OCMC TRAFFIC STIPULATIONS**

8-16-2016

**OCMC FILE NO:** QEC-16-300 AMENDMENT #1  
**CONTRACT NO:** SANDHW11  
**PROJECT:** RECONSTRUCTION OF BEACH CHANNEL DRIVE FROM BEACH 116 STREET TO BEACH 124 STREET  
**LOCATION(S):** ROCKAWAY (QUEENS)

PERMISSION IS HEREBY GRANTED TO THE NYCDDC AND ITS DULY AUTHORIZED AGENT, TO ENTER UPON AND RESTRICT THE FLOW OF TRAFFIC AT THE ABOVE LOCATION(S) FOR THE PURPOSE OF CARRYING OUT THE ABOVE NOTED PROJECT, SUBJECT TO THE STIPULATIONS, AS NOTED BELOW:

**I. SPECIAL STIPULATIONS**

- A. **EMBARGOES** – A CONSTRUCTION EMBARGO WILL APPLY TO THOSE LOCATIONS BELOW WHICH FALL WITHIN THE **HOLIDAY EMBARGO** OR ANY OTHER SPECIAL EVENT EMBARGOES PUBLISHED BY THE BUREAU OF PERMIT MANAGEMENT AND CONSTRUCTION CONTROL.
- B. **BIKE LANES** – IF WORK IS IN OR AFFECTING A BIKE LANE, THE PERMITTEE MUST POST ADVANCE WARNING SIGNS 350 FEET AND 200 FEET PRIOR TO THE WORK ZONE STATING "CONSTRUCTION IN BIKE LANE AHEAD PROCEED WITH CAUTION", AND ALSO POST A SIGN AT THE WORK ZONE STATING "CONSTRUCTION IN BIKE LANE PROCEED WITH CAUTION". SUCH SIGNS SHALL BE ORANGE, 3' X 3', DIAMOND-SHAPED WITH 4" BLACK LETTERING. SIGNS SHALL BE POSTED IN ACCORDANCE WITH THE FEDERAL MANUAL ON UNIFORM TRAFFIC CONTROL DEVICES (MUTCD).
- C. **BIKE SHARE STATIONS**: THE PERMITTEE SHALL NOT REMOVE, RELOCATE, DAMAGE OR DISRUPT THE OPERATION OF EXISTING BIKE SHARE STATIONS WITHOUT FIRST CONTACTING NYC BIKE SHARE AT 123 ST 855-245-3311 FOR THEIR REQUIREMENTS PRIOR TO COMMENCING WORK.
- D. **CITYBENCH**: THE PERMITTEE SHALL NOT REMOVE, RELOCATE, DAMAGE OR DISRUPT AN EXISTING CITYBENCH WITHOUT FIRST CONTACTING NYC DOT AT 212-839-6569, OR VIA EMAIL AT [CITYBENCH@DOT.NYC.GOV](mailto:CITYBENCH@DOT.NYC.GOV) PRIOR TO COMMENCING WORK.
- E. **PROTECTION OF NYC DEP GREEN INFRASTRUCTURE**: THE PERMITTEE SHALL TAKE PRECAUTION OF NYC DEP GREEN INFRASTRUCTURE IN THE RIGHT-OF-WAY. THE PERMITTEE MUST PROTECT NYC DEP GREEN INFRASTRUCTURE DOWNSTREAM OF THE WORK OR WITHIN FIVE (5) FEET OF THE WORK AREA. THE PERMITTEE MUST EMAIL NYC DEP AT [SUSTAINABILITY@DEP.NYC.GOV](mailto:SUSTAINABILITY@DEP.NYC.GOV) FOR PROTECTION REQUIREMENTS PRIOR TO COMMENCING WORK; THE PERMITTEE IS RESPONSIBLE FOR RESTORATION OF DAMAGED NYC DEP INFRASTRUCTURE AS DIRECTED BY NYC DEP.
- F. **BUS STOPS** – THE PERMITTEE SHALL PROVIDE WRITTEN NOTICE TO NYC DOT OCMC AND NEW YORK CITY TRANSIT (NYCT) A MINIMUM OF FIVE (5) WEEKS IN ADVANCE FOR LANE/STREET CLOSURES THAT AFFECT BUS ROUTES/BUS STOPS.
- G. **STREET LIGHTS / TRAFFIC SIGNALS**: THE PERMITTEE SHALL NOT REMOVE OR RELOCATE EXISTING STREET LIGHTS OR TRAFFIC SIGNALS WITHOUT FIRST OBTAINING APPROVAL FROM NYCDOT STREET LIGHTING / TRAFFIC SIGNALS UNIT.
- H. **TRAFFIC CAMERAS, DETECTION/COMMUNICATION EQUIPMENT**: IF AT ANY TIME DURING THE APPROVED WORK, THE PERMITTEE ENCOUNTERS TRAFFIC SURVEILLANCE CAMERAS, DETECTION EQUIPMENT OR ANY TYPE OF COMMUNICATION EQUIPMENT (WIRELESS OR HARD-WIRED) ON ANY NYC DOT FACILITY, THAT IS NOT INCLUDED ON THE DESIGN/BUILD DRAWINGS, THE PERMITTEE SHALL IMMEDIATELY NOTIFY NYC DOT TRAFFIC MANAGEMENT BY PHONE AT 718-433-3390 OR 718-433-3340 AND VIA EMAIL AT [TMC@DOT.NYC.GOV](mailto:TMC@DOT.NYC.GOV) AND AWAIT DIRECTION PRIOR TO CONTINUING WORK.
- I. **METERS** – THE PERMITTEE SHALL NOT REMOVE OR RELOCATE PARKING METERS WITHOUT FIRST OBTAINING APPROVAL FROM NYCDOT PARKING METER DIVISION AT 718-894-8651.
- J. **TEST PITS** – THE BELOW TRAFFIC STIPULATIONS DO NOT APPLY TO TEST PIT WORK RELATED TO THIS CONTRACT. WORK HOURS AND OTHER REQUIREMENTS FOR TEST PIT OPERATIONS MAY DIFFER FROM THE STIPULATIONS IDENTIFIED BELOW. THE PERMITTEE SHALL BE REQUIRED TO OBTAIN SEPARATE PERMITS RELATED TO TEST PITS.
- K. **TEMPORARY PARKING REGULATIONS/PAVEMENT MARKINGS** – THE PERMITTEE IS REQUIRED TO INSTALL, MAINTAIN AND REMOVE ALL NECESSARY TEMPORARY PARKING AND REGULATORY SIGNS AND PAVEMENT MARKINGS, AND RESTORE THEIR ORIGINAL CONDITION PER NYC DOT STANDARDS PRIOR TO EXPIRATION OF THEIR PERMITS. THE PERMITTEE OR AGENCY PERFORMING PUBLIC OUTREACH SHALL POST AND MAINTAIN ADVISORY SIGNS A MINIMUM OF 48 HOURS PRIOR TO CHANGING EXISTING PARKING REGULATION SIGNS TO APPROVED TEMPORARY CONSTRUCTION PARKING REGULATION SIGNS. THE ADVISORY SIGNS SHOULD BE POSTED ON ALL POLES AND DRIVE RAILS ON THE SEGMENT AFFECTED, INDICATING THE DATE OF THE CHANGE, THE NEW REGULATIONS AND A TELEPHONE NUMBER TO OBTAIN MORE INFORMATION.

NYC Department of Transportation  
 Bureau of Permit Management and Construction Control  
 55 Water Street - 7<sup>th</sup> Floor, New York, NY 10041  
 T: 212.839.9621 F: 212.839.8970  
[www.nyc.gov/dot](http://www.nyc.gov/dot)



OCMC FILE NO: QEC-16-300 AMENDMENT #1  
 CONTRACT NO: SANDHW11  
 PROJECT: RECONSTRUCTION OF BEACH CHANNEL DRIVE

8-16-2016  
 Page 2 of 4

- L. ACCESS TO ADJUTING PROPERTIES - THE PERMITTEE SHALL COORDINATE ALL ACTIVITIES WITH ADJUTING PROPERTY OWNERS TO ENSURE ACCESS IS PROVIDED TO/FROM ENTRANCES/DRIVEWAYS AT ALL TIMES.
- M. AUTHORIZED PARKING - PRIOR TO PERFORMING WORK WHICH IMPACTS AUTHORIZED PARKING, THE PERMITTEE SHALL SUBMIT IN WRITING, AND COPY OCMC-STREETS, A REQUEST TO OCCUPY SPACE CURRENTLY USED BY AUTHORIZED VEHICLES. APPROVAL MUST BE RECEIVED FROM AUTHORIZED PARKING PRIOR TO OCCUPYING THESE AREAS.
- N. NOTIFICATION - THE PERMITTEE MUST AT LEAST TWO (2) WORKING DAYS BEFORE THE START OF CONSTRUCTION NOTIFY THE NYC FIRE DEPARTMENT, NYC POLICE DEPARTMENT, NYCEMS, LOCAL COMMUNITY BOARD, BOROUGH PRESIDENT'S OFFICE-CHIEF ENGINEER, NYCDOT OCMC OFFICE, AND ALL ADJUTING PROPERTY OWNERS.
- O. CONSTRUCTION INFORMATIONAL SIGNS - THIS PROJECT REQUIRES A CONSTRUCTION PROJECT INFORMATIONAL SIGN (CPIS) IN ACCORDANCE WITH NYCDOT HIGHWAY RULE SECTION 2-02 (4) AND (5). CRITERIA AND A PROTOTYPE FOR THIS SIGN MAY BE FOUND ON THE NYCDOT WEBSITE AT:  
[http://www.nyc.gov/html/dot/downloads/pdf/01\\_cpis\\_directions.pdf](http://www.nyc.gov/html/dot/downloads/pdf/01_cpis_directions.pdf)
- P. ENHANCED MITIGATIONS
- o ENHANCED MITIGATIONS FOR PEDESTRIAN FLOW, INCLUDING METAL FENCING, SHALL BE PROVIDED TO ENSURE PEDESTRIANS STAY WITHIN THEIR DESIGNATED PATH/ROUTE. PEDESTRIAN MANAGERS SHALL BE PROVIDED TO ASSIST WITH PEDESTRIANS AT THE DESIGNATED CROSSWALK AREAS.
  - o "NO STANDING ANYTIME-TEMPORARY CONSTRUCTION" SIGNS AND TEMPORARY PAVEMENT MARKINGS SHALL BE INSTALLED AND MAINTAINED AS WARRANTED BY THE MAINTENANCE AND PROTECTION OF TRAFFIC (MPT) REQUIRED TO FACILITATE TRAFFIC MOVEMENTS THROUGH THE WORK ZONE. ALL TEMPORARY SIGNS AND PAVEMENT MARKINGS SHALL BE REMOVED UPON COMPLETION OF THE PROJECT.
  - o COMMUNITY OUTREACH SHALL BE PROVIDED FOR THE DURATION OF THE PROJECT.

## II. MAINTENANCE AND PROTECTION OF TRAFFIC - NEW WATER MAIN WORK PHASE

### 1. BEACH 116 STREET BETWEEN NEWPORT AVENUE/BEACH 116 STREET (EASTBOUND) AND END

1. Work hours shall be as follows: 9am to 4pm Monday through Friday.
2. During work hours for new water main work, the permittee shall maintain two 11 foot travel lanes for traffic with one lane in each direction.
3. After working hours the permittee shall restore all travel lanes to traffic. The permittee may contain 25 linear feet, 8 feet adjacent to the curb during non-work hours. Containment is only to restrict parking and for storage of excavated material/fill.
4. The permittee shall maintain a minimum of 5 feet wide sidewalk or 5 feet wide protected pedestrian walkway in the roadway at all times.
5. Must coordinate with NYCT prior to mobilizing.

### 2. ROCKAWAY BEACH BOULEVARD BETWEEN BEACH 113 STREET AND BEACH 117 STREET

1. Work hours shall be as follows: 9am to 4pm Monday through Friday.
2. During work hours for new water main work, the permittee shall maintain two 11 foot travel lanes for traffic with one lane in each direction.
3. After working hours the permittee shall restore all travel lanes to traffic. The permittee may contain 25 linear feet, 8 feet adjacent to the curb during non-work hours. Containment is only to restrict parking and for storage of excavated material/fill.
4. The permittee shall maintain a minimum of 5 feet wide sidewalk or 5 feet wide protected pedestrian walkway in the roadway at all times.
5. If work is affecting a bike route/lane, contractor must post advance warning signs 350' & 200' prior to work zone "construction in bike lane ahead proceed with caution" and also post sign at work zone "construction in bike lane, proceed with caution". Such signs shall be orange, 3'x3', diamond shape, with 4" black lettering. Signs shall be posted in accordance with federal M.U.T.C.D. Manual.
6. Must coordinate with NYCT and the ongoing construction prior to mobilizing.

### 3. BEACH 115 STREET BETWEEN ROCKAWAY BEACH BOULEVARD AND END

1. Work hours shall be as follows: 9am to 4pm Monday through Friday.
2. During work hours for new sanitary sewer and water main work, the permittee shall maintain two 11 foot travel lanes for traffic with one lane in each direction.
3. After working hours the permittee shall restore all travel lanes to traffic. The permittee may contain 25 linear feet, 8 feet adjacent to the curb during non-work hours. Containment is only to restrict parking and for storage of excavated material/fill.

OCMC FILE NO: QEC-16-300 AMENDMENT #1  
 CONTRACT NO: SANDHW11  
 PROJECT: RECONSTRUCTION OF BEACH CHANNEL DRIVE

8-16-2016  
 Page 3 of 4

4. The permittee shall maintain a minimum of 5 feet wide sidewalk or 5 feet wide protected pedestrian walkway in the roadway at all times.
  5. Coordinate with nursing home prior to mobilizing.
- 4. BEACH 114 STREET BETWEEN ROCKAWAY BEACH BOULEVARD AND END**
1. Work hours shall be as follows: 7am to 6pm Monday through Friday.
  2. During work hours for new sanitary sewer and water main work, the permittee shall maintain two 11 foot travel lanes for traffic with one lane in each direction.
  3. After working hours the permittee shall restore all travel lanes to traffic. The permittee may contain 25 linear feet, 8 feet adjacent to the curb during non-work hours. Containment is only to restrict parking and for storage of excavated material/fill.
  4. The permittee shall maintain a minimum of 5 feet wide sidewalk or 5 feet wide protected pedestrian walkway in the roadway at all times.
  5. Coordinate with nursing home prior to mobilizing.
- 5. ROCKAWAY BEACH BOULEVARD AND BEACH 116 STREET**
- 6. ROCKAWAY BEACH BOULEVARD AND BEACH 115 STREET**
- 7. ROCKAWAY BEACH BOULEVARD AND BEACH 114 STREET**
1. Work hours shall be as follows: 9am to 4pm Monday through Friday.
  2. During work hours the permittee shall maintain two 11 foot lanes for traffic with one lane in each direction on both roadways.
  3. Full width of roadway shall be opened to traffic when site is unattended.

### III. GENERAL NOTES

- A. **THIS IS NOT A PERMIT.** THIS STIPULATION SHEET MUST BE SUBMITTED WITH ALL REQUESTS FOR PERMITS PERTAINING TO THE ABOVE CONTRACT AND PRESENT AT THE WORK SITE ALONG WITH ALL ACTIVE CONSTRUCTION PERMITS WHEN THE APPROVED WORK IS BEING PERFORMED.
- B. THE PERMITTEE MUST COMPLY WITH ALL CONSTRUCTION EMBARGOS ISSUED BY THE NYCDOT INCLUDING THE HOLIDAY EMBARGO.
- C. THE PERMITTEE SHALL COMPLY WITH ALL REQUIREMENTS OF THE NYCDOT SPECIAL EVENTS UNIT AS IDENTIFIED BELOW:
  - 1. STREET FAIRS / FESTIVALS**
    - ALL EXCAVATIONS MUST BE PLATED WITH SKID RESISTANT PLATES.
    - PLATES MUST BE RECESSED AND FLUSH WITH PAVEMENT.
    - ALL PAVEMENT DEFECTS MUST BE CORRECTED WITHIN OR ADJACENT TO THE WORK ZONE.
    - THE CONTRACTOR IS RESPONSIBLE FOR ANY DEFECTS WITHIN THE IMMEDIATE VICINITY IF NYCDOT STREET & ARTERIAL MAINTENANCE CANNOT MAKE REPAIRS DUE TO PROJECT INTERFERENCE (AS DETERMINED BY NYCDOT).
    - ALL EQUIPMENT, TRAILERS AND MATERIAL STORAGE MUST BE REMOVED.
  - 2. RUNNING / WALKING / BIKING EVENTS**
    - ALL EXCAVATIONS MUST BE BACKFILLED AND PAVED OR PLATES MUST BE RECESSED AND PAVED OVER FLUSH WITH PAVEMENT.
    - ALL PAVEMENT DEFECTS MUST BE CORRECTED WITHIN OR ADJACENT TO THE WORK ZONE.
    - THE CONTRACTOR IS RESPONSIBLE FOR ANY DEFECTS WITHIN THE IMMEDIATE VICINITY IF NYCDOT STREET & ARTERIAL MAINTENANCE CANNOT MAKE REPAIRS DUE TO PROJECT INTERFERENCE (AS DETERMINED BY NYCDOT).
    - ALL EQUIPMENT, TRAILERS AND MATERIAL STORAGE MUST BE REMOVED.
  - 3. PARADES**
    - ALL EXCAVATIONS MUST BE BACKFILLED AND PAVED OR PLATES MUST BE RECESSED AND PAVED OVER FLUSH WITH PAVEMENT.
    - FORMATION AND DISPERSAL AREA PLATES MUST BE RECESSED AND FLUSH WITH PAVEMENT (PLATES MUST BE SKID RESISTANT).
    - ALL PAVEMENT DEFECTS MUST BE CORRECTED WITHIN OR ADJACENT TO THE WORK ZONE.
    - THE CONTRACTOR IS RESPONSIBLE FOR ANY DEFECTS WITHIN THE IMMEDIATE VICINITY IF NYCDOT STREET & ARTERIAL MAINTENANCE CANNOT MAKE REPAIRS DUE TO PROJECT INTERFERENCE (AS DETERMINED BY NYCDOT).
    - ALL EQUIPMENT, TRAILERS AND MATERIAL STORAGE MUST BE REMOVED.
  - 4. MAYORAL EVENTS**
    - ALL EXCAVATIONS MUST BE BACKFILLED AND PAVED OR PLATES MUST BE RECESSED AND PAVED OVER FLUSH WITH PAVEMENT.
    - ALL PAVEMENT DEFECTS MUST BE CORRECTED WITHIN OR ADJACENT TO THE WORK ZONE.
    - THE CONTRACTOR IS RESPONSIBLE FOR ANY DEFECTS WITHIN THE IMMEDIATE VICINITY IF NYCDOT STREET & ARTERIAL MAINTENANCE CANNOT MAKE REPAIRS DUE TO PROJECT INTERFERENCE (AS DETERMINED BY NYCDOT).

OCMC FILE NO: QEC-16-300 AMENDMENT #1  
CONTRACT NO: SANDHW11  
PROJECT: RECONSTRUCTION OF BEACH CHANNEL DRIVE

8-16-2016  
Page 4 of 4

- ALL EQUIPMENT, TRAILERS AND MATERIAL STORAGE MUST BE REMOVED.
- D. ALL RELOCATION WORK BY THE UTILITIES SUCH AS: CON EDISON, TELEPHONE, GAS AND CABLE COMPANIES SHALL PRECEDE THE CONTRACTORS' START OF WORK ON ALL AFFECTED ROADWAYS IN THE IMPACTED CONTRACT AREA.
- E. THE CONTRACTOR IS ADVISED THAT OTHER CONTRACTORS MAY BE WORKING IN THE GENERAL AREA DURING THE TERM OF THIS STIPULATION. IN WHICH EVENT, THE CONTRACTOR MAY REQUIRE MODIFICATIONS BY THE OCMC-STREETS.
- F. THE PERMITTEE IS NOT AUTHORIZED TO ENTER, OCCUPY OR USE ANY PUBLICLY-OWNED OR PRIVATELY OWNED, NON-PAVED, LANDSCAPE OR NON-LANDSCAPED LOCATION WITHOUT SPECIFIC WRITTEN PERMISSION. WHEN THE LOCATION IS WITHIN THE RIGHT-OF-WAY OF A LIMITED-ACCESS ARTERIAL HIGHWAY, WRITTEN APPROVAL FROM THE NYCDOT OCMC-HIGHWAYS IS REQUIRED. WHEN THE LOCATION IS WITHIN THE RIGHT-OF-WAY OF A PUBLIC STREET OR PUBLIC PARK, WRITTEN APPROVAL FROM THE NEW YORK CITY DEPARTMENT OF TRANSPORTATION OR NEW YORK CITY DEPARTMENT OF PARKS AND RECREATION IS REQUIRED. WHEN THE LOCATION IS WITHIN THE RIGHT-OF-WAY OF ANY OTHER JURISDICTION SUCH AS PRIVATE PROPERTY, STATE, FEDERAL ETC., IT IS THE PERMITTEE'S RESPONSIBILITY TO DETERMINE THE PROPERTY OWNER AND OBTAIN THE WRITTEN APPROVAL.
- G. THE PERMITTEE SHALL ADHERE TO THE NYCDOT BUREAU OF BRIDGES' SPECIAL PROVISIONS FOR LANDSCAPE PROTECTION, MAINTENANCE AND RESTORATION, ITEMS 1.18.15 THROUGH 1.18.19, WHENEVER AND WHEREVER ANY OF THE PERMITTEE'S ACTIVITIES OCCUR WITHIN A LIMITED ACCESS ARTERIAL HIGHWAY RIGHT - OF - WAY.
- H. NO DEVIATION OR DEPARTURE FROM THESE STIPULATIONS WILL BE PERMITTED WITHOUT THE PRIOR WRITTEN APPROVAL FROM THE OCMC-STREETS. REQUEST FOR SUCH MODIFICATIONS SHALL BE SUBMITTED TO THE OFFICE OF THE OCMC-STREETS, NEW YORK CITY DEPARTMENT OF TRANSPORTATION, A MINIMUM OF TWENTY (20) DAYS IN ADVANCE FOR CONSIDERATION.
- I. FOR ANY CONSTRUCTION ACTIVITY RESULTING IN THE FULL CLOSURE OF A ROADWAY FOR MORE THAN 180 CONSECUTIVE CALENDAR DAYS, THE CONTRACTOR MUST PRODUCE AND SUBMIT A COMMUNITY REASSESSMENT, IMPACT AND AMELIORATION (CRIA) STATEMENT TO NYCDOT PLANNING AND OBTAIN THEIR APPROVAL BEFORE APPLYING FOR PERMITS, IN COMPLIANCE WITH THE PROVISIONS OF LOCAL LAW 24 STREET CLOSURE LAW.
- J. FOR THIS PROJECT THE CONTRACTOR SHALL FURNISH, INSTALL AND MAINTAIN ALL NECESSARY ADVANCE WARNING AND DETOUR SIGNS; TEMPORARY CONTROL DEVICES, BARRICADES, LIGHTS AND FLASHING ARROW BOARDS IN ACCORDANCE WITH THE "MANUAL ON UNIFORM TRAFFIC CONTROL DEVICES," THE TYPICAL SCHEMES INCLUDED IN THIS SPECIFICATION; AND AS ORDERED BY THE ENGINEER-IN-CHARGE AND THE OCMC-STREETS.
- K. THE CONTRACTOR SHALL BE RESPONSIBLE FOR IDENTIFYING HIS CONSTRUCTION SIGNAGE. THE IDENTIFICATION SHALL INCLUDE THE CONTRACTOR'S NAME, SPONSORING AGENCY NAME AND THE CONTRACT NUMBER. THE IDENTIFICATION SHALL BE PLACED ON THE BACK OF THE SIGN. THE LETTERING SHALL BE THREE (3) INCHES HIGH.
- L. THE OCMC-STREETS RESERVES THE RIGHT TO VOID OR MODIFY THESE STIPULATIONS SHOULD CONSTRUCTION FAIL TO COMMENCE WITHIN TWO (2) YEARS OF THE SIGNED DATE OF THESE STIPULATIONS.



DUANE BARRA  
DIRECTOR  
OCMC-STREETS

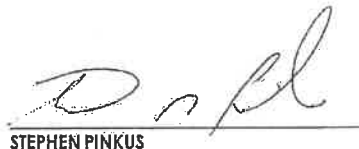

STEPHEN PINKUS  
PROJECT MANAGER  
OCMC-STREETS

THE CITY OF NEW YORK DEPARTMENT OF SANITATION

---

Interpretive Memorandum # 2

The Contractor is notified that the following Department of Sanitation (DOS) Interpretive Memorandum # 2 does not guarantee that a temporary stockpile location will be approved for this project. In addition, the Department of Design and Construction (DDC) reserves the right to rescind approval for any temporary stockpile location at any time. No payment will be made to the Contractor if either a temporary stockpile location is not approved for this project, or DDC rescinds an approval for any reason.



# THE CITY OF NEW YORK Department of Sanitation

S. ELIZABETH SEARLE  
Assistant Commissioner  
for Legal Affairs

Bureau of Legal Affairs  
44 Beaver Street  
New York, NY 10004  
Telephone (212) 837-8110  
FAX (212) 837-8243

## Department of Sanitation Rules and Regulations Governing Non-Putrescible Solid Waste Transfer Stations

### INTERPRETIVE MEMORANDUM # 2 February 14, 1995

**Subject: *Temporary Storage and Processing of Construction and Demolition Debris  
by New York City Agency Contractors***

Contractors performing construction work for New York City agencies may be required to excavate dirt, concrete, rock, gravel and similar materials ("construction materials") from a contract site or to remove from a contract site construction materials resulting from construction, demolition, alteration, repair or renovation of structures, streets or buildings. On street construction projects, construction materials required to be excavated or removed may also include asphalt. The purpose of this Interpretive Memorandum is to (a) define the circumstances under which the Department of Sanitation (the "Department") will not deem its Rules and Regulations Governing Non-Putrescible Solid Waste Transfer Stations (the "Rules") to apply to the temporary storage, processing and/or stockpiling (collectively, "stockpiling") of such construction materials and (b) the procedure for ensuring such exemption. It is the responsibility of the contracting agency to oversee its contractors' compliance with the Rules and with this Interpretive Memorandum.

#### 1. When No Transfer Station Permit is Required

Where a City contractor has:

- (a) set aside an area of a contract site for stockpiling construction materials excavated from and/or intended for that site; or
- (b) received written approval from the contracting agency for an off-site stockpiling location,

the Department will not deem such stockpiling location a transfer station and will not require the contractor to obtain a transfer station permit so long as:

- (c) no construction materials or debris from off the contract site are received at the designated location for subsequent transfer to another location (other than the contract site); and
- (d) the temporary stockpiling location is clearly described as such in the contract or clearly approved by the construction agency and designated as such in writing to the Department by the agency; and
- (e) the construction agency represents in writing to the Department that such agency will monitor the temporary stockpiling location and ensure its clean-up and restoration pursuant to the procedures set out in this memorandum.



Help Reduce  
New York's Waste.

*Example: Street Construction Projects*

As part of a contract for street construction, the contractor may be working at one end of a street and using an area at the other end of the street for the temporary stockpiling of construction materials. Both ends of the street are part of the construction contract site. In addition, the contractor may have leased an off-site location for temporary stockpiling of materials, which, following processing, will be reincorporated into the contract site, with some portion of the remainder designated for delivery to a Department disposal facility. Neither location will be regulated by the Department as a transfer station so long as the procedures set out in this memorandum are followed.

2. Procedure for Exception.

Upon a City construction agency's approval of any location to be designated as a temporary processing, storage or stockpiling area, that agency must determine that (a) its contract with the contractor provides for clean-up and restoration of such area by, for example, the contractor's posting of a restoration bond and/or by contractual set-off and (b) the agency has adequate procedures for monitoring the designated area to ensure that it does not violate the provisions set forth in this memorandum and that such location is cleaned up and restored at the completion of the contract work.

The City construction agency must submit an official letter to the Department acknowledging compliance with both (a) and (b) immediately above and representing that the agency will ensure the contractor's compliance. The letter to be submitted must be in substantially the following form, addressed to the Director, Bureau of Waste Disposal, Department of Sanitation, 125 Worth Street, Room 726, New York, NY 10013:

"The New York City Department of \_\_\_\_\_ (the "Agency")  
has awarded a construction contract to \_\_\_\_\_ (Contractor)  
\_\_\_\_\_ (the "Contractor") for work to be performed at \_\_\_\_\_ (Contract  
Site).

a. This Agency has approved the following locations to be used by the Contractor for the temporary storage, processing and/or stockpiling of construction materials (the "Stockpiling Locations") excavated from the construction site or intended for the construction site:

\_\_\_\_\_  
\_\_\_\_\_  
\_\_\_\_\_

b. The terms of the contract require the Contractor to clean up and restore the Stockpiling Locations, whether on or off the contract site, at or before the completion of the contract work.

c. This Agency assumes responsibility for the monitoring of Stockpiling Locations to ensure that only materials received from and/or intended for the construction site are stockpiled at such locations and we will enforce clean-up and restoration of such Locations at the end of their use for temporary stockpiling or at the termination of the contract, whichever occurs earlier, through restoration

bonding requirements and/or contractual set-off provisions such that the costs of clean-up and restoration will not become a charge to the Department or the City. "

3. When a Transfer Station Permit is Required

A transfer station permit will be required under any circumstances other than those outlined above. Except in the specifically defined circumstances set forth in this memorandum, any operator of a location or facility which receives, processes, stores or stockpiles construction and demolition debris or fill material for purposes of transfer to another location, including to a New York City Department of Sanitation facility, and whether or not under contract to the Department for the delivery of such materials, will be fully subject to the Department's transfer station rules and liable for enforcement for violations.

**TF-PAGES**

**TIGER/FHWA FUNDED PROJECTS  
TIGER/FHWA FUNDING ATTACHMENTS**

---



**(NO TEXT ON THIS PAGE)**

# Transportation Investment Generating Economic Recovery (“TIGER”) and Federal Highway Administration (“FHWA”) Funding Attachments

THE CITY OF NEW YORK  
DEPARTMENT OF DESIGN AND CONSTRUCTION  
INFRASTRUCTURE DIVISION  
BUREAU OF DESIGN

## THIS ATTACHMENT IS HEREBY MADE A PART OF THE CONTRACT DOCUMENTS

1. Any substantial modification of the Contract shall be subject to approval by the State Commissioner of Transportation and the Federal Highway Administration, in addition to the New York City (“City”) agencies involved.
2. The Contractor shall be responsible for compliance with all the provisions of the following Schedules of Federal and State requirements which are hereby made a part of the original contract documents and are annexed hereto:

Attachment “A” – Required Contract Provisions for Federal-Aid Construction Contracts – FHWA 1273

Attachment “B” – Standard Clauses for New York State Contracts, Labor and Employment Provisions, and Public Notices

Attachment “C” – Notice to All Prospective Bidders, Federal-Aid Contracts - Assurance of Non-Discrimination, Subcontracts, Appendix A-1 Supplemental Title VI Provisions (Civil Rights Act)

Attachment “D” – Disadvantaged Business Enterprise Requirements

Attachment “E” – “Buy America” Requirements & Waivers

Attachment “F” - Equal Employment Opportunity Requirements

Attachment “G” – Standardized Changed Conditions Clauses

Attachment “H” – Civil Rights Monitoring and Reporting

Attachment “I” – False Claims Certification, United States Department of Transportation Hotline, New York State Inspector General Hotline

Attachment “J” – Debarment History Certification, Lobbying Activity Certification

Attachment “K” – Provisions Relating to the New York State Labor Law, Prevailing Wages, and the Use of Convict Labor and Materials on Federal & State Contracts

In addition to compliance with the above Federal and State requirements, the Contractor shall also be required to comply with all City requirements as depicted in the Information for Bidders and Standard Construction Contract herein. Wherever a conflict may exist, the Federal Regulations shall take precedence.

3. The Contractor shall not pay less than the highest minimum hourly rates as set forth by Federal, State or City laws.
4. The Contractor shall maintain his records in conformity with the current NYSDOT "Manual for Uniform Record Keeping", referred to as MURK, copies of which are available on line at the NYSDOT website [www.dot.ny.gov/publications](http://www.dot.ny.gov/publications).
5. In accordance with 23 US C315 and Order 1321.1C, FHWA Directives Management, issued January 6, 2010, the construction work performed under this Contract shall be available to be subject to inspection at all times by the New York State Department of Transportation and the Federal Highway Administration.
6. Amendments to Information for Bidders:
  - a) Refer to Pages 6 and 7, Subsection 21.(C), Rejection of All Bids and Negotiation With All Responsible Bidders;  
Delete Sub-Article 21.(C) and Sub-Article 21.(D) in their entirety and substitute the words "(C) (NO TEXT)." And "(D) (NO TEXT)." respectively.
  - b) Refer to Page 9, SECTION 27. Failure to Execute Contract, 6th, 7th and 8th lines;  
Delete the sentence beginning with the words: "No plea of mistake in such . . ." in its entirety.
  - c) Refer to Page 10, SECTION 30. Labor Law Requirements, Sub-Article (A) General;  
Add the following at the end of the Sub-Article (A): "This provision shall apply to subcontractors also."
  - d) Refer to Page 11, Subsection 33.(B), Variations from Engineer's Estimate;  
Delete Subsection 33.(B) in its entirety. See Attachment "G", Standardized Change Condition Clauses, Sub-Article (3).(iv).(B).
  - e) Refer to Pages 12 and 13, SECTION 37. Locally Based Enterprise Requirements (LBE);  
Delete the SECTION, in its entirety. See Attachment "D" Disadvantaged Business Enterprise Utilization Requirements.
7. Amendments to Standard Construction Contract:
  - a) Refer to Page 5, Sub-Article 5.2;  
Delete the last sentence starting with the words: "In the event of . . ." and ending with the words ". . . shall take precedence."
  - b) Refer to Pages 11 and 12, ARTICLE 7. PROTECTION OF WORK AND OF PERSONS AND PROPERTY; NOTICES AND INDEMNIFICATION;  
Add the following:

"7.6 In addition to the requirements stipulated herein, all work performed under this Contract shall comply with the safety and health standards of the Occupational Safety and Health Administration (OSHA) of the U.S. Department of Labor."
  - c) Refer to Page 13, Sub-Article 9.3;  
Delete the first sentence starting with the words: "If the Contractor . . ." and ending with the words ". . . progress schedule."

- d) Refer to Pages 22 and 23, ARTICLE 16. OCCUPATION OR USE PRIOR TO COMPLETION;  
Delete Sub-Article 16.1.4, in its entirety.
- e) Refer to Pages 23 and 24, ARTICLE 17. SUBCONTRACTS;  
Delete Sub-Article 17.11.1, in its entirety;  
Substitute the following revised Article 17.11.1:  
 "17.11.1 Payment to **Subcontractors**: The agreement between the **Contractor** and its **Subcontractors** shall contain the same terms and conditions as to method of payment for **Work**, labor, and materials, as are contained in this **Contract**."
- f) Refer to Page 26, ARTICLE 19. SECURITY DEPOSIT;  
Delete Sub-Article 19.2, in its entirety;  
Substitute the following Sub-Article 19.2:
- "19.2 If performance and payment bonds are not required, the bid security shall be retained by the **City** as security for the **Contractor's** faithful performance of the Contract. If partial payments are provided, the bid security will be returned to the **Contractor** subject to the other provisions of this **Contract**. If partial payments are not provided, the bid security will be released when final payment is certified by the **City** for payment."
- g) Refer to Page 29, ARTICLE 21. RETAINED PERCENTAGE;  
Delete Article 21, in its entirety;  
Substitute the following:
- "ARTICLE 21. (NO TEXT)"**
- h) Refer to Page 36, ARTICLE 24. MAINTENANCE AND GUARANTY;  
Delete Sub-Article 24.1 in its entirety;  
Substitute the words "24.1 (NO TEXT)".
- i) Refer to Page 36, ARTICLE 24. MAINTENANCE AND GUARANTY;  
 Add the following to Sub-Article 24.9:
- "On any contract which requires the furnishing and/or installing of electrical or mechanical equipment, the Contractor shall provide the following:
- (1) Manufacturers' warranties or guarantees on all electrical and mechanical equipment, consistent with those provided as customary trade practice.
  - (2) Contractor's guarantees providing for satisfactory in-service operation of the mechanical and electrical equipment and related components for a period of not less than one (1) year following project acceptance.
  - (3) On any contract which requires maintenance and guarantee for landscape items including trees, the maintenance and guarantee period shall be twenty-four (24) months."

j) Refer to Page 37, ARTICLE 25. CHANGES;  
Add the following paragraph:

"25.5 Extra Work: It is anticipated that the preliminary engineering and the preparation of plans, specifications and contract documents have been performed with sufficient thoroughness, accuracy and care, and that changes and extra work during the construction can be held to a minimum and limited almost exclusively to revisions and additions necessitated by conditions that could not reasonably be anticipated before the project was advertised for bids or force account operations commenced."

- k) Refer to Pages 50, 51 and 52, ARTICLE 36. NO DISCRIMINATION;  
Change in Paragraph 36.1.1, 4th line, "citizen of the State of New York" to "person";  
Delete Paragraphs 36.1.3, 36.1.4, 36.2.2 and 36.2.4 in their entirety;  
Add "or sex or age" to the expression "race, creed, color or national origin", and "or sex or age" to the expression "race, color or creed", wherever these expressions appear in Article 36.

- l) Refer to Page 59, ARTICLE 43. PROMPT PAYMENT;  
Add the following sentence to the end of Sub-Article 43.5:

"The Contractor shall not hold any retainage, but may deduct an amount necessary to satisfy any claims, liens or judgments against a Subcontractor or materialman which have not been fully discharged."

- m) Refer to Pages 59 and 60, ARTICLE 44. SUBSTANTIAL COMPLETION PAYMENT;  
Delete Sub-Articles 44.2 and 44.3, in their entirety;  
Substitute the following:

"44.2 The **Commissioner** shall issue a voucher calling for payment of any part or all of the balance due for **Work** performed under the **Contract**, less any and all deductions authorized to be made by the **Commissioner**, under this **Contract** or by **Law**, and less twice the amount the **Commissioner** considers necessary to ensure the completion of the balance of the **Work** by the **Contractor**. Such a payment shall be considered a Partial and not a Final Payment. No **Substantial Completion** payment shall be made under this Article 44 where the **Contractor** shall fail to complete the **Work** within the time fixed for such completion in the Schedule A of the General Conditions, or within the time to which completion may have been extended, until an extension or extensions of time for the completion of **Work** have been acted upon pursuant to Article 13.

44.3 No further partial payments shall be made to the **Contractor** after **Substantial Completion**, except the **Substantial Completion** payment and **Contractor's** requisition that were properly filed with the **Commissioner** prior to the date of **Substantial Completion**; however, the **Commissioner** may grant a waiver for further partial payments after the date of **Substantial Completion** to permit payments for change order **Work**. Such waiver shall be in writing."

- n) Refer to Pages 60 and 61, ARTICLE 45. FINAL PAYMENT;  
Delete Sub-Article 45.1, in its entirety;  
Substitute the following:

"45.1 After completion and **Final Acceptance** of the **Work**, the **Contractor** shall submit all required certificates and documents, together with a requisition for the balance claimed to be due under the **Contract**. Such submission shall be within 90 days of the date of the **Commissioner's** written determination of **Final Acceptance**,

or within such additional time as may be granted by the **Commissioner** in writing. If the **Contractor** fails to submit all required certificates and documents within the time allowed, no payment of the balance claimed shall be made to the **Contractor** and the **Contractor** shall be deemed to have forfeited its right to payment of any balance claimed. A verified statement similar to that required in connection with applications for partial payments shall also be submitted to the **Commissioner**."

- o) Refer to Page 67, ARTICLE 59. SERVICE OF NOTICES;  
Delete the words "deposited in a post office box regularly maintained by the United States Postal Service in a properly addressed, postage prepaid envelope".
  
- p) Refer to Pages 71, 72 and 73, ARTICLE 64. TERMINATION BY THE CITY;  
Delete the text of the 1st paragraph;  
Substitute the following:  
  
"64.1 In addition to termination pursuant to any other article of this Contract, the Commissioner may, by written notice, terminate the Contract or any portion thereof after determining that for reasons beyond either Department or Contractor control it is not feasible to proceed with or complete the work as originally contracted for, and that termination would therefore be in the public interest. Such reasons for termination may include, but need not be necessarily limited to, executive orders of the President relating to prosecution of war or national defense, national emergency which creates a serious shortage of materials, orders from duly constituted authorities relating to energy conservation, and restraining orders or injunctions obtained by third-party citizen action resulting from national or local laws or regulations, or where the issuance of such order or injunction is primarily caused by acts or omissions of persons or agencies other than the Contractor, or where the orderly progression of a project is interfered with or delayed by acts or omissions of persons or agencies other than the Contractor. The Contractor specifically understands that the issuance of such notice by the Commissioner shall be conclusive as to its necessity. In such event the Contractor shall upon receipt of such notice:"
  
- q) Refer to Pages 74 and 75, ARTICLE 67. LOCALLY BASED ENTERPRISE PROGRAM;  
Delete Article 67, in its entirety, and Substitute the following "ARTICLE 67. (NO TEXT)". See Attachment "D" Disadvantaged Business Enterprise Requirements.
  
- r) Refer to Pages 75, 76 and 77, ARTICLE 69. MacBRIDE PRINCIPLES PROVISIONS;  
Delete Article 69, in its entirety, and Substitute the following "ARTICLE 69. (NO TEXT)"
  
- s) Refer to Page 78, ARTICLE 75. COMPENSATION TO BE PAID TO CONTRACTOR;  
Delete Article 75, in its entirety and Substitute the following "ARTICLE 75. (NO TEXT)".
  
- t) Add the following to Pages 92, 93, 94, 95, 96, 97, 98, and 99, PERFORMANCE BOND:

"Prior to or at the time of execution of the contract, successful bidder must deliver to the City of New York an executed bond equal to one hundred percent (100%) of the

contract price, to secure the faithful performance of the contract, and an executed bond in an amount equal to one hundred percent (100%) of the contract price, as security for the payment of all persons performing labor or furnishing materials in connection with this contract, prepared on the forms of bonds authorized by The City of New York, and made a part of the contract documents, copies of which are annexed hereto, and having as surety thereunder such surety company or companies as are approved by The City of New York and are authorized to do business in the State of New York. Premium of such bonds shall be included in the base bid.

In lieu of a performance and completion bond and labor and material bond, a contractor may deposit with the Comptroller, money or obligations of The City of New York which the Comptroller shall approve as of equal value with the amount of the performance and completion bond required.

Whenever a contractor deposits obligations of The City of New York, in lieu of a performance and completion bond and a labor and material bond, it shall be with the understanding that the Comptroller of the City of New York, or his successors, may sell and use the proceeds thereof, for any purpose for which the principal or surety on such bond would be liable under the terms of the contract. If money is deposited with the Comptroller, the Contractor shall not be entitled to receive interest on such money from The City of New York.

If the bidder to whom the contract is awarded refuses to execute it, or fails to furnish the required security and insurance within ten (10) days after receipt of notice to him of the award, the amount of his deposit, or as much thereof as may be applicable to the amount of the award made to him, shall be forfeited and shall be retained by the City as liquidated damages.”

- u) Refer to Pages 79, 80, 81, 82, 83, 84, 85, and 86, ARTICLE 78. PARTICIPATION BY MINORITY - OWNED AND WOMEN – OWNED BUSINESS ENTERPRISES IN CITY PROCUREMENT;  
Delete Article 78, in its entirety, and Substitute the following “ARTICLE 78. (NO TEXT)”

8. Amendments to General Conditions of the Standard Highway Specifications:

- a) Refer to Pages 38 and 39, of the Standard Highway Specifications, Article 1.06.46. Project Sign;  
Delete the Article 1.06.46, in its entirety;  
Substitute the following:

“1.06.46. Project Sign. No project signs will be required on this project.”

9. Amendments to the Standard Highway Specifications:

- a) Refer to Pages 290 through 292, **SECTION 5.05 – Maintenance**;  
Delete Section 5.05, in its entirety, and any references thereto;  
Substitute the following:

**“SECTION 5.05 – Maintenance”**

- (A) CONTRACTOR TO KEEP HIMSELF INFORMED OF CONDITIONS

The Contractor must keep himself informed of the condition of the trees which are under maintenance, and will be required to make replacements without notice from the Commissioner. In case of failure or neglect on his part to do so, then the Commissioner shall have the right to purchase such plant material as he shall deem necessary, and to employ such person or persons as he shall deem proper, and to undertake and complete said replacements by contract or otherwise and to charge the expense thereof against the Performance Bond or any sum of money retained by The City, as herein provided, and the excess cost to the Contractor, and the Contractor shall pay all such expense to which The City may have been put by reason of the neglect of the Contractor to make such replacements as aforesaid.

(B) CONTRACTOR TO MAKE REPAIRS OR REPLACEMENTS

The Contractor shall remove and replace all trees under maintenance which die or, in the opinion of the Engineer, seem unhealthy, stunted or unable to flourish, within the period of maintenance, except as otherwise provided, and replace said trees with new trees of the same size and species as originally planted, except when such death, unhealthiness, stunting or inability to flourish is due to vandalism or damage resulting from causes over which the Contractor has no control, as certified by the Engineer. However, the Engineer may, at his discretion, direct a substitution of species.

(C) PERIOD OF MAINTENANCE

The period of maintenance for each individual tree planted or transplanted shall begin upon planting or transplanting and shall end twenty-four (24) months thereafter. The Contractor shall obtain the said certificate from the Department of Parks and Recreation, in writing, and file such certificate with the Engineer.

(D) MAINTENANCE NOT TO TERMINATE IN WINTER MONTHS

When the termination date of the period of maintenance for planted or transplanted trees shall fall outside the planting periods specified in **Section 4.16**, hereof, the interval between the said termination date and next planting period thereafter, or such part as the Commissioner may determine, shall not be included in the computation of the period of maintenance during which the replacement of defective trees is to be made by the Contractor, and also, in that case, the payment to be made under the provisions of this contract shall not be made until after the date appearing on the Certificate of Acceptance which the Contractor shall obtain from the Department of Parks and Recreation, and file with the Engineer, for trees planted as replacements for defective trees within the said next planting period thereafter, unless otherwise specifically permitted by the Commissioner.

(E) EXPIRATION OF MAINTENANCE

Unless otherwise permitted or directed, defective trees, as determined by the Commissioner, shall be replaced with new trees by the Contractor.

The furnishing and planting of trees as replacements for defective trees shall comply, in all respects, with the contract requirements.

In the event that The City incurs any expense in pursuance of this section of the contract, the certificate of the Commissioner as to the condition of the trees, the nature and extent of the replacements made, and expense incurred for such replacements shall be binding and conclusive on the Contractor.

(F) CONTRACTOR TO NOTIFY COMMISSIONER BEFORE MAKING REPAIRS

The Contractor shall notify the Commissioner, at least two (2) days before making any replacements of the time and place of beginning such work and shall at all times keep the



Commissioner or his representatives informed of the proposed prosecution of the work from day to day.”

10. The Contractor is hereby notified that this is a City contract funded through apportionment available under Title 23, U.S. Code, as amended, and that the contract will be awarded by the City of New York, subject to the approval of the Commissioner of the New York State Department of Transportation and the Federal Highway Administration. Furthermore, no extensions in time for completion or other changes affecting the contract work can be granted by the City of New York without concurrence of the State of New York and approval of the Federal Highway Administration.
11. All reference to the delivery of salvageable materials to a designated City-owned yard do not apply to this Contract. All salvageable materials designated by the Engineer shall be stored on site for pick-up by City forces.
12. Wherever references are made within these specifications to “race, creed, color, national origin or sex,” they shall be construed to include “sexual orientation and marital status”.

**REQUIRED CONTRACT PROVISIONS  
FEDERAL-AID CONSTRUCTION CONTRACTS**

- I. General
- II. Nondiscrimination
- III. Nonsegregated Facilities
- IV. Davis-Bacon and Related Act Provisions
- V. Contract Work Hours and Safety Standards Act Provisions
- VI. Subletting or Assigning the Contract
- VII. Safety: Accident Prevention
- VIII. False Statements Concerning Highway Projects
- IX. Implementation of Clean Air Act and Federal Water Pollution Control Act
- X. Compliance with Governmentwide Suspension and Debarment Requirements
- XI. Certification Regarding Use of Contract Funds for Lobbying

3. A breach of any of the stipulations contained in these Required Contract Provisions may be sufficient grounds for withholding of progress payments, withholding of final payment, termination of the contract, suspension / debarment or any other action determined to be appropriate by the contracting agency and FHWA.

4. Selection of Labor: During the performance of this contract, the contractor shall not use convict labor for any purpose within the limits of a construction project on a Federal-aid highway unless it is labor performed by convicts who are on parole, supervised release, or probation. The term Federal-aid highway does not include roadways functionally classified as local roads or rural minor collectors.

**ATTACHMENTS**

A. Employment and Materials Preference for Appalachian Development Highway System or Appalachian Local Access Road Contracts (included in Appalachian contracts only)

**II. NONDISCRIMINATION**

The provisions of this section related to 23 CFR Part 230 are applicable to all Federal-aid construction contracts and to all related construction subcontracts of \$10,000 or more. The provisions of 23 CFR Part 230 are not applicable to material supply, engineering, or architectural service contracts.

**I. GENERAL**

1. Form FHWA-1273 must be physically incorporated in each construction contract funded under Title 23 (excluding emergency contracts solely intended for debris removal). The contractor (or subcontractor) must insert this form in each subcontract and further require its inclusion in all lower tier subcontracts (excluding purchase orders, rental agreements and other agreements for supplies or services).

In addition, the contractor and all subcontractors must comply with the following policies: Executive Order 11246, 41 CFR 60, 29 CFR 1625-1627, Title 23 USC Section 140, the Rehabilitation Act of 1973, as amended (29 USC 794), Title VI of the Civil Rights Act of 1964, as amended, and related regulations including 49 CFR Parts 21, 26 and 27; and 23 CFR Parts 200, 230, and 633.

The applicable requirements of Form FHWA-1273 are incorporated by reference for work done under any purchase order, rental agreement or agreement for other services. The prime contractor shall be responsible for compliance by any subcontractor, lower-tier subcontractor or service provider.

The contractor and all subcontractors must comply with: the requirements of the Equal Opportunity Clause in 41 CFR 60-1.4(b) and, for all construction contracts exceeding \$10,000, the Standard Federal Equal Employment Opportunity Construction Contract Specifications in 41 CFR 60-4.3.

Form FHWA-1273 must be included in all Federal-aid design-build contracts, in all subcontracts and in lower tier subcontracts (excluding subcontracts for design services, purchase orders, rental agreements and other agreements for supplies or services). The design-builder shall be responsible for compliance by any subcontractor, lower-tier subcontractor or service provider.

Note: The U.S. Department of Labor has exclusive authority to determine compliance with Executive Order 11246 and the policies of the Secretary of Labor including 41 CFR 60, and 29 CFR 1625-1627. The contracting agency and the FHWA have the authority and the responsibility to ensure compliance with Title 23 USC Section 140, the Rehabilitation Act of 1973, as amended (29 USC 794), and Title VI of the Civil Rights Act of 1964, as amended, and related regulations including 49 CFR Parts 21, 26 and 27; and 23 CFR Parts 200, 230, and 633.

Contracting agencies may reference Form FHWA-1273 in bid proposal or request for proposal documents, however, the Form FHWA-1273 must be physically incorporated (not referenced) in all contracts, subcontracts and lower-tier subcontracts (excluding purchase orders, rental agreements and other agreements for supplies or services related to a construction contract).

The following provision is adopted from 23 CFR 230, Appendix A, with appropriate revisions to conform to the U.S. Department of Labor (US DOL) and FHWA requirements.

2. Subject to the applicability criteria noted in the following sections, these contract provisions shall apply to all work performed on the contract by the contractor's own organization and with the assistance of workers under the contractor's immediate superintendence and to all work performed on the contract by piecework, station work, or by subcontract.

**1. Equal Employment Opportunity:** Equal employment opportunity (EEO) requirements not to discriminate and to take affirmative action to assure equal opportunity as set forth under laws, executive orders, rules, regulations (28 CFR 35, 29 CFR 1630, 29 CFR 1625-1627, 41 CFR 60 and 49 CFR 27) and orders of the Secretary of Labor as modified by the provisions prescribed herein, and imposed pursuant to 23 U.S.C. 140 shall constitute the EEO and specific affirmative action standards for the contractor's project activities under

## ATTACHMENT "A"

this contract. The provisions of the Americans with Disabilities Act of 1990 (42 U.S.C. 12101 et seq.) set forth under 28 CFR 35 and 29 CFR 1630 are incorporated by reference in this contract. In the execution of this contract, the contractor agrees to comply with the following minimum specific requirement activities of EEO:

a. The contractor will work with the contracting agency and the Federal Government to ensure that it has made every good faith effort to provide equal opportunity with respect to all of its terms and conditions of employment and in their review of activities under the contract.

b. The contractor will accept as its operating policy the following statement:

"It is the policy of this Company to assure that applicants are employed, and that employees are treated during employment, without regard to their race, religion, sex, color, national origin, age or disability. Such action shall include: employment, upgrading, demotion, or transfer; recruitment or recruitment advertising; layoff or termination; rates of pay or other forms of compensation; and selection for training, including apprenticeship, pre-apprenticeship, and/or on-the-job training."

**2. EEO Officer:** The contractor will designate and make known to the contracting officers an EEO Officer who will have the responsibility for and must be capable of effectively administering and promoting an active EEO program and who must be assigned adequate authority and responsibility to do so.

**3. Dissemination of Policy:** All members of the contractor's staff who are authorized to hire, supervise, promote, and discharge employees, or who recommend such action, or who are substantially involved in such action, will be made fully cognizant of, and will implement, the contractor's EEO policy and contractual responsibilities to provide EEO in each grade and classification of employment. To ensure that the above agreement will be met, the following actions will be taken as a minimum:

a. Periodic meetings of supervisory and personnel office employees will be conducted before the start of work and then not less often than once every six months, at which time the contractor's EEO policy and its implementation will be reviewed and explained. The meetings will be conducted by the EEO Officer.

b. All new supervisory or personnel office employees will be given a thorough indoctrination by the EEO Officer, covering all major aspects of the contractor's EEO obligations within thirty days following their reporting for duty with the contractor.

c. All personnel who are engaged in direct recruitment for the project will be instructed by the EEO Officer in the contractor's procedures for locating and hiring minorities and women.

d. Notices and posters setting forth the contractor's EEO policy will be placed in areas readily accessible to employees, applicants for employment and potential employees.

e. The contractor's EEO policy and the procedures to implement such policy will be brought to the attention of employees by means of meetings, employee handbooks, or other appropriate means.

**4. Recruitment:** When advertising for employees, the contractor will include in all advertisements for employees the notation: "An Equal Opportunity Employer." All such advertisements will be placed in publications having a large circulation among minorities and women in the area from which the project work force would normally be derived.

a. The contractor will, unless precluded by a valid bargaining agreement, conduct systematic and direct recruitment through public and private employee referral sources likely to yield qualified minorities and women. To meet this requirement, the contractor will identify sources of potential minority group employees, and establish with such identified sources procedures whereby minority and women applicants may be referred to the contractor for employment consideration.

b. In the event the contractor has a valid bargaining agreement providing for exclusive hiring hall referrals, the contractor is expected to observe the provisions of that agreement to the extent that the system meets the contractor's compliance with EEO contract provisions. Where implementation of such an agreement has the effect of discriminating against minorities or women, or obligates the contractor to do the same, such implementation violates Federal nondiscrimination provisions.

c. The contractor will encourage its present employees to refer minorities and women as applicants for employment. Information and procedures with regard to referring such applicants will be discussed with employees.

**5. Personnel Actions:** Wages, working conditions, and employee benefits shall be established and administered, and personnel actions of every type, including hiring, upgrading, promotion, transfer, demotion, layoff, and termination, shall be taken without regard to race, color, religion, sex, national origin, age or disability. The following procedures shall be followed:

a. The contractor will conduct periodic inspections of project sites to insure that working conditions and employee facilities do not indicate discriminatory treatment of project site personnel.

b. The contractor will periodically evaluate the spread of wages paid within each classification to determine any evidence of discriminatory wage practices.

c. The contractor will periodically review selected personnel actions in depth to determine whether there is evidence of discrimination. Where evidence is found, the contractor will promptly take corrective action. If the review indicates that the discrimination may extend beyond the actions reviewed, such corrective action shall include all affected persons.

d. The contractor will promptly investigate all complaints of alleged discrimination made to the contractor in connection with its obligations under this contract, will attempt to resolve such complaints, and will take appropriate corrective action within a reasonable time. If the investigation indicates that the discrimination may affect persons other than the complainant, such corrective action shall include such other persons. Upon completion of each investigation, the contractor will inform every complainant of all of their avenues of appeal.

**6. Training and Promotion:**

a. The contractor will assist in locating, qualifying, and increasing the skills of minorities and women who are

## ATTACHMENT "A"

applicants for employment or current employees. Such efforts should be aimed at developing full journey level status employees in the type of trade or job classification involved.

b. Consistent with the contractor's work force requirements and as permissible under Federal and State regulations, the contractor shall make full use of training programs, i.e., apprenticeship, and on-the-job training programs for the geographical area of contract performance. In the event a special provision for training is provided under this contract, this subparagraph will be superseded as indicated in the special provision. The contracting agency may reserve training positions for persons who receive welfare assistance in accordance with 23 U.S.C. 140(a).

c. The contractor will advise employees and applicants for employment of available training programs and entrance requirements for each.

d. The contractor will periodically review the training and promotion potential of employees who are minorities and women and will encourage eligible employees to apply for such training and promotion.

**7. Unions:** If the contractor relies in whole or in part upon unions as a source of employees, the contractor will use good faith efforts to obtain the cooperation of such unions to increase opportunities for minorities and women. Actions by the contractor, either directly or through a contractor's association acting as agent, will include the procedures set forth below:

a. The contractor will use good faith efforts to develop, in cooperation with the unions, joint training programs aimed toward qualifying more minorities and women for membership in the unions and increasing the skills of minorities and women so that they may qualify for higher paying employment.

b. The contractor will use good faith efforts to incorporate an EEO clause into each union agreement to the end that such union will be contractually bound to refer applicants without regard to their race, color, religion, sex, national origin, age or disability.

c. The contractor is to obtain information as to the referral practices and policies of the labor union except that to the extent such information is within the exclusive possession of the labor union and such labor union refuses to furnish such information to the contractor, the contractor shall so certify to the contracting agency and shall set forth what efforts have been made to obtain such information.

d. In the event the union is unable to provide the contractor with a reasonable flow of referrals within the time limit set forth in the collective bargaining agreement, the contractor will, through independent recruitment efforts, fill the employment vacancies without regard to race, color, religion, sex, national origin, age or disability; making full efforts to obtain qualified and/or qualifiable minorities and women. The failure of a union to provide sufficient referrals (even though it is obligated to provide exclusive referrals under the terms of a collective bargaining agreement) does not relieve the contractor from the requirements of this paragraph. In the event the union referral practice prevents the contractor from meeting the obligations pursuant to Executive Order 11246, as amended, and these special provisions, such contractor shall immediately notify the contracting agency.

**8. Reasonable Accommodation for Applicants / Employees with Disabilities:** The contractor must be familiar

with the requirements for and comply with the Americans with Disabilities Act and all rules and regulations established there under. Employers must provide reasonable accommodation in all employment activities unless to do so would cause an undue hardship.

**9. Selection of Subcontractors, Procurement of Materials and Leasing of Equipment:** The contractor shall not discriminate on the grounds of race, color, religion, sex, national origin, age or disability in the selection and retention of subcontractors, including procurement of materials and leases of equipment. The contractor shall take all necessary and reasonable steps to ensure nondiscrimination in the administration of this contract.

a. The contractor shall notify all potential subcontractors and suppliers and lessors of their EEO obligations under this contract.

b. The contractor will use good faith efforts to ensure subcontractor compliance with their EEO obligations.

### 10. Assurance Required by 49 CFR 26.13(b):

a. The requirements of 49 CFR Part 26 and the State DOT's U.S. DOT-approved DBE program are incorporated by reference.

b. The contractor or subcontractor shall not discriminate on the basis of race, color, national origin, or sex in the performance of this contract. The contractor shall carry out applicable requirements of 49 CFR Part 26 in the award and administration of DOT-assisted contracts. Failure by the contractor to carry out these requirements is a material breach of this contract, which may result in the termination of this contract or such other remedy as the contracting agency deems appropriate.

**11. Records and Reports:** The contractor shall keep such records as necessary to document compliance with the EEO requirements. Such records shall be retained for a period of three years following the date of the final payment to the contractor for all contract work and shall be available at reasonable times and places for inspection by authorized representatives of the contracting agency and the FHWA.

a. The records kept by the contractor shall document the following:

(1) The number and work hours of minority and non-minority group members and women employed in each work classification on the project;

(2) The progress and efforts being made in cooperation with unions, when applicable, to increase employment opportunities for minorities and women; and

(3) The progress and efforts being made in locating, hiring, training, qualifying, and upgrading minorities and women;

b. The contractors and subcontractors will submit an annual report to the contracting agency each July for the duration of the project, indicating the number of minority, women, and non-minority group employees currently engaged in each work classification required by the contract work. This information is to be reported on Form FHWA-1391. The staffing data should represent the project work force on board in all or any part of the last payroll period preceding the end of July. If on-the-job training is being required by special provision, the contractor

## ATTACHMENT "A"

will be required to collect and report training data. The employment data should reflect the work force on board during all or any part of the last payroll period preceding the end of July.

### III. NONSEGREGATED FACILITIES

This provision is applicable to all Federal-aid construction contracts and to all related construction subcontracts of \$10,000 or more.

The contractor must ensure that facilities provided for employees are provided in such a manner that segregation on the basis of race, color, religion, sex, or national origin cannot result. The contractor may neither require such segregated use by written or oral policies nor tolerate such use by employee custom. The contractor's obligation extends further to ensure that its employees are not assigned to perform their services at any location, under the contractor's control, where the facilities are segregated. The term "facilities" includes waiting rooms, work areas, restaurants and other eating areas, time clocks, restrooms, washrooms, locker rooms, and other storage or dressing areas, parking lots, drinking fountains, recreation or entertainment areas, transportation, and housing provided for employees. The contractor shall provide separate or single-user restrooms and necessary dressing or sleeping areas to assure privacy between sexes.

### IV. DAVIS-BACON AND RELATED ACT PROVISIONS

This section is applicable to all Federal-aid construction projects exceeding \$2,000 and to all related subcontracts and lower-tier subcontracts (regardless of subcontract size). The requirements apply to all projects located within the right-of-way of a roadway that is functionally classified as Federal-aid highway. This excludes roadways functionally classified as local roads or rural minor collectors, which are exempt. Contracting agencies may elect to apply these requirements to other projects.

The following provisions are from the U.S. Department of Labor regulations in 29 CFR 5.5 "Contract provisions and related matters" with minor revisions to conform to the FHWA-1273 format and FHWA program requirements.

#### 1. Minimum wages

a. All laborers and mechanics employed or working upon the site of the work, will be paid unconditionally and not less often than once a week, and without subsequent deduction or rebate on any account (except such payroll deductions as are permitted by regulations issued by the Secretary of Labor under the Copeland Act (29 CFR part 3)), the full amount of wages and bona fide fringe benefits (or cash equivalents thereof) due at time of payment computed at rates not less than those contained in the wage determination of the Secretary of Labor which is attached hereto and made a part hereof, regardless of any contractual relationship which may be alleged to exist between the contractor and such laborers and mechanics.

Contributions made or costs reasonably anticipated for bona fide fringe benefits under section 1(b)(2) of the Davis-Bacon Act on behalf of laborers or mechanics are considered wages paid to such laborers or mechanics, subject to the provisions

of paragraph 1.d. of this section; also, regular contributions made or costs incurred for more than a weekly period (but not less often than quarterly) under plans, funds, or programs which cover the particular weekly period, are deemed to be constructively made or incurred during such weekly period. Such laborers and mechanics shall be paid the appropriate wage rate and fringe benefits on the wage determination for the classification of work actually performed, without regard to skill, except as provided in 29 CFR 5.5(a)(4). Laborers or mechanics performing work in more than one classification may be compensated at the rate specified for each classification for the time actually worked therein: Provided, That the employer's payroll records accurately set forth the time spent in each classification in which work is performed. The wage determination (including any additional classification and wage rates conformed under paragraph 1.b. of this section) and the Davis-Bacon poster (WH-1321) shall be posted at all times by the contractor and its subcontractors at the site of the work in a prominent and accessible place where it can be easily seen by the workers.

b.(1) The contracting officer shall require that any class of laborers or mechanics, including helpers, which is not listed in the wage determination and which is to be employed under the contract shall be classified in conformance with the wage determination. The contracting officer shall approve an additional classification and wage rate and fringe benefits therefore only when the following criteria have been met:

(i) The work to be performed by the classification requested is not performed by a classification in the wage determination; and

(ii) The classification is utilized in the area by the construction industry; and

(iii) The proposed wage rate, including any bona fide fringe benefits, bears a reasonable relationship to the wage rates contained in the wage determination.

(2) If the contractor and the laborers and mechanics to be employed in the classification (if known), or their representatives, and the contracting officer agree on the classification and wage rate (including the amount designated for fringe benefits where appropriate), a report of the action taken shall be sent by the contracting officer to the Administrator of the Wage and Hour Division, Employment Standards Administration, U.S. Department of Labor, Washington, DC 20210: The Administrator, or an authorized representative, will approve, modify, or disapprove every additional classification action within 30 days of receipt and so advise the contracting officer or will notify the contracting officer within the 30-day period that additional time is necessary.

(3) In the event the contractor, the laborers or mechanics to be employed in the classification or their representatives, and the contracting officer do not agree on the proposed classification and wage rate (including the amount designated for fringe benefits, where appropriate), the contracting officer shall refer the questions, including the views of all interested parties and the recommendation of the contracting officer, to the Wage and Hour Administrator for determination. The Wage and Hour Administrator, or an authorized representative, will issue a determination within 30 days of receipt and so advise the contracting officer or

## ATTACHMENT "A"

will notify the contracting officer within the 30-day period that additional time is necessary.

(4) The wage rate (including fringe benefits where appropriate) determined pursuant to paragraphs 1.b.(2) or 1.b.(3) of this section, shall be paid to all workers performing work in the classification under this contract from the first day on which work is performed in the classification.

c. Whenever the minimum wage rate prescribed in the contract for a class of laborers or mechanics includes a fringe benefit which is not expressed as an hourly rate, the contractor shall either pay the benefit as stated in the wage determination or shall pay another bona fide fringe benefit or an hourly cash equivalent thereof.

d. If the contractor does not make payments to a trustee or other third person, the contractor may consider as part of the wages of any laborer or mechanic the amount of any costs reasonably anticipated in providing bona fide fringe benefits under a plan or program. Provided, That the Secretary of Labor has found, upon the written request of the contractor, that the applicable standards of the Davis-Bacon Act have been met. The Secretary of Labor may require the contractor to set aside in a separate account assets for the meeting of obligations under the plan or program.

### 2. Withholding

The contracting agency shall upon its own action or upon written request of an authorized representative of the Department of Labor, withhold or cause to be withheld from the contractor under this contract, or any other Federal contract with the same prime contractor, or any other federally-assisted contract subject to Davis-Bacon prevailing wage requirements, which is held by the same prime contractor, so much of the accrued payments or advances as may be considered necessary to pay laborers and mechanics, including apprentices, trainees, and helpers, employed by the contractor or any subcontractor the full amount of wages required by the contract. In the event of failure to pay any laborer or mechanic, including any apprentice, trainee, or helper, employed or working on the site of the work, all or part of the wages required by the contract, the contracting agency may, after written notice to the contractor, take such action as may be necessary to cause the suspension of any further payment, advance, or guarantee of funds until such violations have ceased.

### 3. Payrolls and basic records

a. Payrolls and basic records relating thereto shall be maintained by the contractor during the course of the work and preserved for a period of three years thereafter for all laborers and mechanics working at the site of the work. Such records shall contain the name, address, and social security number of each such worker, his or her correct classification, hourly rates of wages paid (including rates of contributions or costs anticipated for bona fide fringe benefits or cash equivalents thereof of the types described in section 1(b)(2)(B) of the Davis-Bacon Act), daily and weekly number of hours worked, deductions made and actual wages paid. Whenever the Secretary of Labor has found under 29 CFR 5.5(a)(1)(iv) that the wages of any laborer or mechanic include the amount of any costs reasonably anticipated in providing benefits under a plan or program described in section 1(b)(2)(B) of the Davis-

Bacon Act, the contractor shall maintain records which show that the commitment to provide such benefits is enforceable, that the plan or program is financially responsible, and that the plan or program has been communicated in writing to the laborers or mechanics affected, and records which show the costs anticipated or the actual cost incurred in providing such benefits. Contractors employing apprentices or trainees under approved programs shall maintain written evidence of the registration of apprenticeship programs and certification of trainee programs, the registration of the apprentices and trainees, and the ratios and wage rates prescribed in the applicable programs.

b.(1) The contractor shall submit weekly for each week in which any contract work is performed a copy of all payrolls to the contracting agency. The payrolls submitted shall set out accurately and completely all of the information required to be maintained under 29 CFR 5.5(a)(3)(i), except that full social security numbers and home addresses shall not be included on weekly transmittals. Instead the payrolls shall only need to include an individually identifying number for each employee (e.g. the last four digits of the employee's social security number). The required weekly payroll information may be submitted in any form desired. Optional Form WH-347 is available for this purpose from the Wage and Hour Division Web site at <http://www.dol.gov/esa/whd/forms/wh347instr.htm> or its successor site. The prime contractor is responsible for the submission of copies of payrolls by all subcontractors. Contractors and subcontractors shall maintain the full social security number and current address of each covered worker, and shall provide them upon request to the contracting agency for transmission to the State DOT, the FHWA or the Wage and Hour Division of the Department of Labor for purposes of an investigation or audit of compliance with prevailing wage requirements. It is not a violation of this section for a prime contractor to require a subcontractor to provide addresses and social security numbers to the prime contractor for its own records, without weekly submission to the contracting agency..

(2) Each payroll submitted shall be accompanied by a "Statement of Compliance," signed by the contractor or subcontractor or his or her agent who pays or supervises the payment of the persons employed under the contract and shall certify the following:

(i) That the payroll for the payroll period contains the information required to be provided under §5.5 (a)(3)(ii) of Regulations, 29 CFR part 5, the appropriate information is being maintained under §5.5 (a)(3)(i) of Regulations, 29 CFR part 5, and that such information is correct and complete;

(ii) That each laborer or mechanic (including each helper, apprentice, and trainee) employed on the contract during the payroll period has been paid the full weekly wages earned, without rebate, either directly or indirectly, and that no deductions have been made either directly or indirectly from the full wages earned, other than permissible deductions as set forth in Regulations, 29 CFR part 3;

(iii) That each laborer or mechanic has been paid not less than the applicable wage rates and fringe benefits or cash equivalents for the classification of work performed, as specified in the applicable wage determination incorporated into the contract.

## ATTACHMENT "A"

(3) The weekly submission of a properly executed certification set forth on the reverse side of Optional Form WH-347 shall satisfy the requirement for submission of the "Statement of Compliance" required by paragraph 3.b.(2) of this section.

(4) The falsification of any of the above certifications may subject the contractor or subcontractor to civil or criminal prosecution under section 1001 of title 18 and section 231 of title 31 of the United States Code.

c. The contractor or subcontractor shall make the records required under paragraph 3.a. of this section available for inspection, copying, or transcription by authorized representatives of the contracting agency, the State DOT, the FHWA, or the Department of Labor, and shall permit such representatives to interview employees during working hours on the job. If the contractor or subcontractor fails to submit the required records or to make them available, the FHWA may, after written notice to the contractor, the contracting agency or the State DOT, take such action as may be necessary to cause the suspension of any further payment, advance, or guarantee of funds. Furthermore, failure to submit the required records upon request or to make such records available may be grounds for debarment action pursuant to 29 CFR 5.12.

#### 4. Apprentices and trainees

##### a. Apprentices (programs of the USDOL).

Apprentices will be permitted to work at less than the predetermined rate for the work they performed when they are employed pursuant to and individually registered in a bona fide apprenticeship program registered with the U.S. Department of Labor, Employment and Training Administration, Office of Apprenticeship Training, Employer and Labor Services, or with a State Apprenticeship Agency recognized by the Office, or if a person is employed in his or her first 90 days of probationary employment as an apprentice in such an apprenticeship program, who is not individually registered in the program, but who has been certified by the Office of Apprenticeship Training, Employer and Labor Services or a State Apprenticeship Agency (where appropriate) to be eligible for probationary employment as an apprentice.

The allowable ratio of apprentices to journeymen on the job site in any craft classification shall not be greater than the ratio permitted to the contractor as to the entire work force under the registered program. Any worker listed on a payroll at an apprentice wage rate, who is not registered or otherwise employed as stated above, shall be paid not less than the applicable wage rate on the wage determination for the classification of work actually performed. In addition, any apprentice performing work on the job site in excess of the ratio permitted under the registered program shall be paid not less than the applicable wage rate on the wage determination for the work actually performed. Where a contractor is performing construction on a project in a locality other than that in which its program is registered, the ratios and wage rates (expressed in percentages of the journeyman's hourly rate) specified in the contractor's or subcontractor's registered program shall be observed.

Every apprentice must be paid at not less than the rate specified in the registered program for the apprentice's level of progress, expressed as a percentage of the journeymen hourly

rate specified in the applicable wage determination. Apprentices shall be paid fringe benefits in accordance with the provisions of the apprenticeship program. If the apprenticeship program does not specify fringe benefits, apprentices must be paid the full amount of fringe benefits listed on the wage determination for the applicable classification. If the Administrator determines that a different practice prevails for the applicable apprentice classification, fringes shall be paid in accordance with that determination.

In the event the Office of Apprenticeship Training, Employer and Labor Services, or a State Apprenticeship Agency recognized by the Office, withdraws approval of an apprenticeship program, the contractor will no longer be permitted to utilize apprentices at less than the applicable predetermined rate for the work performed until an acceptable program is approved.

##### b. Trainees (programs of the USDOL).

Except as provided in 29 CFR 5.16, trainees will not be permitted to work at less than the predetermined rate for the work performed unless they are employed pursuant to and individually registered in a program which has received prior approval, evidenced by formal certification by the U.S. Department of Labor, Employment and Training Administration.

The ratio of trainees to journeymen on the job site shall not be greater than permitted under the plan approved by the Employment and Training Administration.

Every trainee must be paid at not less than the rate specified in the approved program for the trainee's level of progress, expressed as a percentage of the journeyman hourly rate specified in the applicable wage determination. Trainees shall be paid fringe benefits in accordance with the provisions of the trainee program. If the trainee program does not mention fringe benefits, trainees shall be paid the full amount of fringe benefits listed on the wage determination unless the Administrator of the Wage and Hour Division determines that there is an apprenticeship program associated with the corresponding journeyman wage rate on the wage determination which provides for less than full fringe benefits for apprentices. Any employee listed on the payroll at a trainee rate who is not registered and participating in a training plan approved by the Employment and Training Administration shall be paid not less than the applicable wage rate on the wage determination for the classification of work actually performed. In addition, any trainee performing work on the job site in excess of the ratio permitted under the registered program shall be paid not less than the applicable wage rate on the wage determination for the work actually performed.

In the event the Employment and Training Administration withdraws approval of a training program, the contractor will no longer be permitted to utilize trainees at less than the applicable predetermined rate for the work performed until an acceptable program is approved.

c. Equal employment opportunity. The utilization of apprentices, trainees and journeymen under this part shall be in conformity with the equal employment opportunity requirements of Executive Order 11246, as amended, and 29 CFR part 30.

## ATTACHMENT "A"

### d. Apprentices and Trainees (programs of the U.S. DOT).

Apprentices and trainees working under apprenticeship and skill training programs which have been certified by the Secretary of Transportation as promoting EEO in connection with Federal-aid highway construction programs are not subject to the requirements of paragraph 4 of this Section IV. The straight time hourly wage rates for apprentices and trainees under such programs will be established by the particular programs. The ratio of apprentices and trainees to journeymen shall not be greater than permitted by the terms of the particular program.

**5. Compliance with Copeland Act requirements.** The contractor shall comply with the requirements of 29 CFR part 3, which are incorporated by reference in this contract.

**6. Subcontracts.** The contractor or subcontractor shall insert Form FHWA-1273 in any subcontracts and also require the subcontractors to include Form FHWA-1273 in any lower tier subcontracts. The prime contractor shall be responsible for the compliance by any subcontractor or lower tier subcontractor with all the contract clauses in 29 CFR 5.5.

**7. Contract termination: debarment.** A breach of the contract clauses in 29 CFR 5.5 may be grounds for termination of the contract, and for debarment as a contractor and a subcontractor as provided in 29 CFR 5.12.

**8. Compliance with Davis-Bacon and Related Act requirements.** All rulings and interpretations of the Davis-Bacon and Related Acts contained in 29 CFR parts 1, 3, and 5 are herein incorporated by reference in this contract.

**9. Disputes concerning labor standards.** Disputes arising out of the labor standards provisions of this contract shall not be subject to the general disputes clause of this contract. Such disputes shall be resolved in accordance with the procedures of the Department of Labor set forth in 29 CFR parts 5, 6, and 7. Disputes within the meaning of this clause include disputes between the contractor (or any of its subcontractors) and the contracting agency, the U.S. Department of Labor, or the employees or their representatives.

### 10. Certification of eligibility.

a. By entering into this contract, the contractor certifies that neither it (nor he or she) nor any person or firm who has an interest in the contractor's firm is a person or firm ineligible to be awarded Government contracts by virtue of section 3(a) of the Davis-Bacon Act or 29 CFR 5.12(a)(1).

b. No part of this contract shall be subcontracted to any person or firm ineligible for award of a Government contract by virtue of section 3(a) of the Davis-Bacon Act or 29 CFR 5.12(a)(1).

c. The penalty for making false statements is prescribed in the U.S. Criminal Code, 18 U.S.C. 1001.

## V. CONTRACT WORK HOURS AND SAFETY STANDARDS ACT

The following clauses apply to any Federal-aid construction contract in an amount in excess of \$100,000 and subject to the overtime provisions of the Contract Work Hours and Safety Standards Act. These clauses shall be inserted in addition to the clauses required by 29 CFR 5.5(a) or 29 CFR 4.6. As used in this paragraph, the terms laborers and mechanics include watchmen and guards.

**1. Overtime requirements.** No contractor or subcontractor contracting for any part of the contract work which may require or involve the employment of laborers or mechanics shall require or permit any such laborer or mechanic in any workweek in which he or she is employed on such work to work in excess of forty hours in such workweek unless such laborer or mechanic receives compensation at a rate not less than one and one-half times the basic rate of pay for all hours worked in excess of forty hours in such workweek.

**2. Violation; liability for unpaid wages; liquidated damages.** In the event of any violation of the clause set forth in paragraph (1.) of this section, the contractor and any subcontractor responsible therefor shall be liable for the unpaid wages. In addition, such contractor and subcontractor shall be liable to the United States (in the case of work done under contract for the District of Columbia or a territory, to such District or to such territory), for liquidated damages. Such liquidated damages shall be computed with respect to each individual laborer or mechanic, including watchmen and guards, employed in violation of the clause set forth in paragraph (1.) of this section, in the sum of \$10 for each calendar day on which such individual was required or permitted to work in excess of the standard workweek of forty hours without payment of the overtime wages required by the clause set forth in paragraph (1.) of this section.

**3. Withholding for unpaid wages and liquidated damages.** The FHWA or the contracting agency shall upon its own action or upon written request of an authorized representative of the Department of Labor withhold or cause to be withheld, from any moneys payable on account of work performed by the contractor or subcontractor under any such contract or any other Federal contract with the same prime contractor, or any other federally-assisted contract subject to the Contract Work Hours and Safety Standards Act, which is held by the same prime contractor, such sums as may be determined to be necessary to satisfy any liabilities of such contractor or subcontractor for unpaid wages and liquidated damages as provided in the clause set forth in paragraph (2.) of this section.

**4. Subcontracts.** The contractor or subcontractor shall insert in any subcontracts the clauses set forth in paragraph (1.) through (4.) of this section and also a clause requiring the subcontractors to include these clauses in any lower tier subcontracts. The prime contractor shall be responsible for compliance by any subcontractor or lower tier subcontractor with the clauses set forth in paragraphs (1.) through (4.) of this section.



## ATTACHMENT "A"

### VI. SUBLETTING OR ASSIGNING THE CONTRACT

This provision is applicable to all Federal-aid construction contracts on the National Highway System.

1. The contractor shall perform with its own organization contract work amounting to not less than 30 percent (or a greater percentage if specified elsewhere in the contract) of the total original contract price, excluding any specialty items designated by the contracting agency. Specialty items may be performed by subcontract and the amount of any such specialty items performed may be deducted from the total original contract price before computing the amount of work required to be performed by the contractor's own organization (23 CFR 635.116).

a. The term "perform work with its own organization" refers to workers employed or leased by the prime contractor, and equipment owned or rented by the prime contractor, with or without operators. Such term does not include employees or equipment of a subcontractor or lower tier subcontractor, agents of the prime contractor, or any other assignees. The term may include payments for the costs of hiring leased employees from an employee leasing firm meeting all relevant Federal and State regulatory requirements. Leased employees may only be included in this term if the prime contractor meets all of the following conditions:

(1) the prime contractor maintains control over the supervision of the day-to-day activities of the leased employees;

(2) the prime contractor remains responsible for the quality of the work of the leased employees;

(3) the prime contractor retains all power to accept or exclude individual employees from work on the project; and

(4) the prime contractor remains ultimately responsible for the payment of predetermined minimum wages, the submission of payrolls, statements of compliance and all other Federal regulatory requirements.

b. "Specialty Items" shall be construed to be limited to work that requires highly specialized knowledge, abilities, or equipment not ordinarily available in the type of contracting organizations qualified and expected to bid or propose on the contract as a whole and in general are to be limited to minor components of the overall contract.

2. The contract amount upon which the requirements set forth in paragraph (1) of Section VI is computed includes the cost of material and manufactured products which are to be purchased or produced by the contractor under the contract provisions.

3. The contractor shall furnish (a) a competent superintendent or supervisor who is employed by the firm, has full authority to direct performance of the work in accordance with the contract requirements, and is in charge of all construction operations (regardless of who performs the work) and (b) such other of its own organizational resources (supervision, management, and engineering services) as the contracting officer determines is necessary to assure the performance of the contract.

4. No portion of the contract shall be sublet, assigned or otherwise disposed of except with the written consent of the contracting officer, or authorized representative, and such consent when given shall not be construed to relieve the contractor of any responsibility for the fulfillment of the contract. Written consent will be given only after the contracting agency has assured that each subcontract is

evidenced in writing and that it contains all pertinent provisions and requirements of the prime contract.

5. The 30% self-performance requirement of paragraph (1) is not applicable to design-build contracts; however, contracting agencies may establish their own self-performance requirements.

### VII. SAFETY: ACCIDENT PREVENTION

This provision is applicable to all Federal-aid construction contracts and to all related subcontracts.

1. In the performance of this contract the contractor shall comply with all applicable Federal, State, and local laws governing safety, health, and sanitation (23 CFR 635). The contractor shall provide all safeguards, safety devices and protective equipment and take any other needed actions as it determines, or as the contracting officer may determine, to be reasonably necessary to protect the life and health of employees on the job and the safety of the public and to protect property in connection with the performance of the work covered by the contract.

2. It is a condition of this contract, and shall be made a condition of each subcontract, which the contractor enters into pursuant to this contract, that the contractor and any subcontractor shall not permit any employee, in performance of the contract, to work in surroundings or under conditions which are unsanitary, hazardous or dangerous to his/her health or safety, as determined under construction safety and health standards (29 CFR 1926) promulgated by the Secretary of Labor, in accordance with Section 107 of the Contract Work Hours and Safety Standards Act (40 U.S.C. 3704).

3. Pursuant to 29 CFR 1926.3, it is a condition of this contract that the Secretary of Labor or authorized representative thereof, shall have right of entry to any site of contract performance to inspect or investigate the matter of compliance with the construction safety and health standards and to carry out the duties of the Secretary under Section 107 of the Contract Work Hours and Safety Standards Act (40 U.S.C.3704).

### VIII. FALSE STATEMENTS CONCERNING HIGHWAY PROJECTS

This provision is applicable to all Federal-aid construction contracts and to all related subcontracts.

In order to assure high quality and durable construction in conformity with approved plans and specifications and a high degree of reliability on statements and representations made by engineers, contractors, suppliers, and workers on Federal-aid highway projects, it is essential that all persons concerned with the project perform their functions as carefully, thoroughly, and honestly as possible. Willful falsification, distortion, or misrepresentation with respect to any facts related to the project is a violation of Federal law. To prevent any misunderstanding regarding the seriousness of these and similar acts, Form FHWA-1022 shall be posted on each Federal-aid highway project (23 CFR 635) in one or more places where it is readily available to all persons concerned with the project:

18 U.S.C. 1020 reads as follows:

## ATTACHMENT "A"

"Whoever, being an officer, agent, or employee of the United States, or of any State or Territory, or whoever, whether a person, association, firm, or corporation, knowingly makes any false statement, false representation, or false report as to the character, quality, quantity, or cost of the material used or to be used, or the quantity or quality of the work performed or to be performed, or the cost thereof in connection with the submission of plans, maps, specifications, contracts, or costs of construction on any highway or related project submitted for approval to the Secretary of Transportation; or

Whoever knowingly makes any false statement, false representation, false report or false claim with respect to the character, quality, quantity, or cost of any work performed or to be performed, or materials furnished or to be furnished, in connection with the construction of any highway or related project approved by the Secretary of Transportation; or

Whoever knowingly makes any false statement or false representation as to material fact in any statement, certificate, or report submitted pursuant to provisions of the Federal-aid Roads Act approved July 1, 1916, (39 Stat. 355), as amended and supplemented;

Shall be fined under this title or imprisoned not more than 5 years or both."

### IX. IMPLEMENTATION OF CLEAN AIR ACT AND FEDERAL WATER POLLUTION CONTROL ACT

This provision is applicable to all Federal-aid construction contracts and to all related subcontracts.

By submission of this bid/proposal or the execution of this contract, or subcontract, as appropriate, the bidder, proposer, Federal-aid construction contractor, or subcontractor, as appropriate, will be deemed to have stipulated as follows:

1. That any person who is or will be utilized in the performance of this contract is not prohibited from receiving an award due to a violation of Section 508 of the Clean Water Act or Section 306 of the Clean Air Act.
2. That the contractor agrees to include or cause to be included the requirements of paragraph (1) of this Section X in every subcontract, and further agrees to take such action as the contracting agency may direct as a means of enforcing such requirements.

### X. CERTIFICATION REGARDING DEBARMENT, SUSPENSION, INELIGIBILITY AND VOLUNTARY EXCLUSION

This provision is applicable to all Federal-aid construction contracts, design-build contracts, subcontracts, lower-tier subcontracts, purchase orders, lease agreements, consultant contracts or any other covered transaction requiring FHWA approval or that is estimated to cost \$25,000 or more – as defined in 2 CFR Parts 180 and 1200.

#### 1. Instructions for Certification – First Tier Participants:

- a. By signing and submitting this proposal, the prospective first tier participant is providing the certification set out below.
- b. The inability of a person to provide the certification set out below will not necessarily result in denial of participation in this

covered transaction. The prospective first tier participant shall submit an explanation of why it cannot provide the certification set out below. The certification or explanation will be considered in connection with the department or agency's determination whether to enter into this transaction. However, failure of the prospective first tier participant to furnish a certification or an explanation shall disqualify such a person from participation in this transaction.

c. The certification in this clause is a material representation of fact upon which reliance was placed when the contracting agency determined to enter into this transaction. If it is later determined that the prospective participant knowingly rendered an erroneous certification, in addition to other remedies available to the Federal Government, the contracting agency may terminate this transaction for cause of default.

d. The prospective first tier participant shall provide immediate written notice to the contracting agency to whom this proposal is submitted if any time the prospective first tier participant learns that its certification was erroneous when submitted or has become erroneous by reason of changed circumstances.

e. The terms "covered transaction," "debarred," "suspended," "ineligible," "participant," "person," "principal," and "voluntarily excluded," as used in this clause, are defined in 2 CFR Parts 180 and 1200. "First Tier Covered Transactions" refers to any covered transaction between a grantee or subgrantee of Federal funds and a participant (such as the prime or general contract). "Lower Tier Covered Transactions" refers to any covered transaction under a First Tier Covered Transaction (such as subcontracts). "First Tier Participant" refers to the participant who has entered into a covered transaction with a grantee or subgrantee of Federal funds (such as the prime or general contractor). "Lower Tier Participant" refers any participant who has entered into a covered transaction with a First Tier Participant or other Lower Tier Participants (such as subcontractors and suppliers).

f. The prospective first tier participant agrees by submitting this proposal that, should the proposed covered transaction be entered into, it shall not knowingly enter into any lower tier covered transaction with a person who is debarred, suspended, declared ineligible, or voluntarily excluded from participation in this covered transaction, unless authorized by the department or agency entering into this transaction.

g. The prospective first tier participant further agrees by submitting this proposal that it will include the clause titled "Certification Regarding Debarment, Suspension, Ineligibility and Voluntary Exclusion-Lower Tier Covered Transactions," provided by the department or contracting agency, entering into this covered transaction, without modification, in all lower tier covered transactions and in all solicitations for lower tier covered transactions exceeding the \$25,000 threshold.

h. A participant in a covered transaction may rely upon a certification of a prospective participant in a lower tier covered transaction that is not debarred, suspended, ineligible, or voluntarily excluded from the covered transaction, unless it knows that the certification is erroneous. A participant is responsible for ensuring that its principals are not suspended, debarred, or otherwise ineligible to participate in covered transactions. To verify the eligibility of its principals, as well as the eligibility of any lower tier prospective participants, each participant may, but is not required to, check the Excluded Parties List System website (<https://www.epls.gov/>), which is compiled by the General Services Administration.

## ATTACHMENT "A"

i. Nothing contained in the foregoing shall be construed to require the establishment of a system of records in order to render in good faith the certification required by this clause. The knowledge and information of the prospective participant is not required to exceed that which is normally possessed by a prudent person in the ordinary course of business dealings.

j. Except for transactions authorized under paragraph (f) of these instructions, if a participant in a covered transaction knowingly enters into a lower tier covered transaction with a person who is suspended, debarred, ineligible, or voluntarily excluded from participation in this transaction, in addition to other remedies available to the Federal Government, the department or agency may terminate this transaction for cause or default.

\*\*\*\*\*

### 2. Certification Regarding Debarment, Suspension, Ineligibility and Voluntary Exclusion – First Tier Participants:

a. The prospective first tier participant certifies to the best of its knowledge and belief, that it and its principals:

(1) Are not presently debarred, suspended, proposed for debarment, declared ineligible, or voluntarily excluded from participating in covered transactions by any Federal department or agency;

(2) Have not within a three-year period preceding this proposal been convicted of or had a civil judgment rendered against them for commission of fraud or a criminal offense in connection with obtaining, attempting to obtain, or performing a public (Federal, State or local) transaction or contract under a public transaction; violation of Federal or State antitrust statutes or commission of embezzlement, theft, forgery, bribery, falsification or destruction of records, making false statements, or receiving stolen property;

(3) Are not presently indicted for or otherwise criminally or civilly charged by a governmental entity (Federal, State or local) with commission of any of the offenses enumerated in paragraph (a)(2) of this certification; and

(4) Have not within a three-year period preceding this application/proposal had one or more public transactions (Federal, State or local) terminated for cause or default.

b. Where the prospective participant is unable to certify to any of the statements in this certification, such prospective participant shall attach an explanation to this proposal.

### 2. Instructions for Certification - Lower Tier Participants:

(Applicable to all subcontracts, purchase orders and other lower tier transactions requiring prior FHWA approval or estimated to cost \$25,000 or more - 2 CFR Parts 180 and 1200)

a. By signing and submitting this proposal, the prospective lower tier is providing the certification set out below.

b. The certification in this clause is a material representation of fact upon which reliance was placed when this transaction was entered into. If it is later determined that the prospective lower tier participant knowingly rendered an erroneous certification, in addition to other remedies available to the Federal Government, the department, or agency with which

this transaction originated may pursue available remedies, including suspension and/or debarment.

c. The prospective lower tier participant shall provide immediate written notice to the person to which this proposal is submitted if at any time the prospective lower tier participant learns that its certification was erroneous by reason of changed circumstances.

d. The terms "covered transaction," "debarred," "suspended," "ineligible," "participant," "person," "principal," and "voluntarily excluded," as used in this clause, are defined in 2 CFR Parts 180 and 1200. You may contact the person to which this proposal is submitted for assistance in obtaining a copy of those regulations. "First Tier Covered Transactions" refers to any covered transaction between a grantee or subgrantee of Federal funds and a participant (such as the prime or general contract). "Lower Tier Covered Transactions" refers to any covered transaction under a First Tier Covered Transaction (such as subcontracts). "First Tier Participant" refers to the participant who has entered into a covered transaction with a grantee or subgrantee of Federal funds (such as the prime or general contractor). "Lower Tier Participant" refers any participant who has entered into a covered transaction with a First Tier Participant or other Lower Tier Participants (such as subcontractors and suppliers).

e. The prospective lower tier participant agrees by submitting this proposal that, should the proposed covered transaction be entered into, it shall not knowingly enter into any lower tier covered transaction with a person who is debarred, suspended, or declared ineligible, or voluntarily excluded from participation in this covered transaction, unless authorized by the department or agency with which this transaction originated.

f. The prospective lower tier participant further agrees by submitting this proposal that it will include this clause titled "Certification Regarding Debarment, Suspension, Ineligibility and Voluntary Exclusion-Lower Tier Covered Transaction," without modification, in all lower tier covered transactions and in all solicitations for lower tier covered transactions exceeding the \$25,000 threshold.

g. A participant in a covered transaction may rely upon a certification of a prospective participant in a lower tier covered transaction that is not debarred, suspended, ineligible, or voluntarily excluded from the covered transaction, unless it knows that the certification is erroneous. A participant is responsible for ensuring that its principals are not suspended, debarred, or otherwise ineligible to participate in covered transactions. To verify the eligibility of its principals, as well as the eligibility of any lower tier prospective participants, each participant may, but is not required to, check the Excluded Parties List System website (<https://www.epls.gov/>), which is compiled by the General Services Administration.

h. Nothing contained in the foregoing shall be construed to require establishment of a system of records in order to render in good faith the certification required by this clause. The knowledge and information of participant is not required to exceed that which is normally possessed by a prudent person in the ordinary course of business dealings.

i. Except for transactions authorized under paragraph e of these instructions, if a participant in a covered transaction knowingly enters into a lower tier covered transaction with a person who is suspended, debarred, ineligible, or voluntarily excluded from participation in this transaction, in addition to other remedies available to the Federal Government, the

## ATTACHMENT "A"

department or agency with which this transaction originated may pursue available remedies, including suspension and/or debarment.

\*\*\*\*\*

### **Certification Regarding Debarment, Suspension, Ineligibility and Voluntary Exclusion--Lower Tier Participants:**

1. The prospective lower tier participant certifies, by submission of this proposal, that neither it nor its principals is presently debarred, suspended, proposed for debarment, declared ineligible, or voluntarily excluded from participating in covered transactions by any Federal department or agency.

2. Where the prospective lower tier participant is unable to certify to any of the statements in this certification, such prospective participant shall attach an explanation to this proposal.

\*\*\*\*\*

### **XI. CERTIFICATION REGARDING USE OF CONTRACT FUNDS FOR LOBBYING**

This provision is applicable to all Federal-aid construction contracts and to all related subcontracts which exceed \$100,000 (49 CFR 20).

1. The prospective participant certifies, by signing and submitting this bid or proposal, to the best of his or her knowledge and belief, that:

a. No Federal appropriated funds have been paid or will be paid, by or on behalf of the undersigned, to any person for influencing or attempting to influence an officer or employee of any Federal agency, a Member of Congress, an officer or employee of Congress, or an employee of a Member of Congress in connection with the awarding of any Federal contract, the making of any Federal grant, the making of any Federal loan, the entering into of any cooperative agreement, and the extension, continuation, renewal, amendment, or modification of any Federal contract, grant, loan, or cooperative agreement.

b. If any funds other than Federal appropriated funds have been paid or will be paid to any person for influencing or attempting to influence an officer or employee of any Federal agency, a Member of Congress, an officer or employee of Congress, or an employee of a Member of Congress in connection with this Federal contract, grant, loan, or cooperative agreement, the undersigned shall complete and submit Standard Form-LLL, "Disclosure Form to Report Lobbying," in accordance with its instructions.

2. This certification is a material representation of fact upon which reliance was placed when this transaction was made or entered into. Submission of this certification is a prerequisite for making or entering into this transaction imposed by 31 U.S.C. 1352. Any person who fails to file the required certification shall be subject to a civil penalty of not less than \$10,000 and not more than \$100,000 for each such failure.

3. The prospective participant also agrees by submitting its bid or proposal that the participant shall require that the language of this certification be included in all lower tier subcontracts, which exceed \$100,000 and that all such recipients shall certify and disclose accordingly.

## ATTACHMENT "A"

### ATTACHMENT A - EMPLOYMENT AND MATERIALS PREFERENCE FOR APPALACHIAN DEVELOPMENT HIGHWAY SYSTEM OR APPALACHIAN LOCAL ACCESS ROAD CONTRACTS

This provision is applicable to all Federal-aid projects funded under the Appalachian Regional Development Act of 1965.

1. During the performance of this contract, the contractor undertaking to do work which is, or reasonably may be, done as on-site work, shall give preference to qualified persons who regularly reside in the labor area as designated by the DOL wherein the contract work is situated, or the subregion, or the Appalachian counties of the State wherein the contract work is situated, except:

a. To the extent that qualified persons regularly residing in the area are not available.

b. For the reasonable needs of the contractor to employ supervisory or specially experienced personnel necessary to assure an efficient execution of the contract work.

c. For the obligation of the contractor to offer employment to present or former employees as the result of a lawful collective bargaining contract, provided that the number of nonresident persons employed under this subparagraph (1c) shall not exceed 20 percent of the total number of employees employed by the contractor on the contract work, except as provided in subparagraph (4) below.

2. The contractor shall place a job order with the State Employment Service indicating (a) the classifications of the laborers, mechanics and other employees required to perform the contract work, (b) the number of employees required in each classification, (c) the date on which the participant estimates such employees will be required, and (d) any other pertinent information required by the State Employment Service to complete the job order form. The job order may be placed with the State Employment Service in writing or by telephone. If during the course of the contract work, the information submitted by the contractor in the original job order is substantially modified, the participant shall promptly notify the State Employment Service.

3. The contractor shall give full consideration to all qualified job applicants referred to him by the State Employment Service. The contractor is not required to grant employment to any job applicants who, in his opinion, are not qualified to perform the classification of work required.

4. If, within one week following the placing of a job order by the contractor with the State Employment Service, the State Employment Service is unable to refer any qualified job applicants to the contractor, or less than the number requested, the State Employment Service will forward a certificate to the contractor indicating the unavailability of applicants. Such certificate shall be made a part of the contractor's permanent project records. Upon receipt of this certificate, the contractor may employ persons who do not normally reside in the labor area to fill positions covered by the certificate, notwithstanding the provisions of subparagraph (1c) above.

5. The provisions of 23 CFR 633.207(e) allow the contracting agency to provide a contractual preference for the use of mineral resource materials native to the Appalachian region.

6. The contractor shall include the provisions of Sections 1 through 4 of this Attachment A in every subcontract for work which is, or reasonably may be, done as on-site work.

**ATTACHMENT "B" – STANDARD CLAUSES FOR NEW YORK  
STATE CONTRACTS, LABOR AND EMPLOYMENT  
PROVISIONS, AND PUBLIC NOTICES**

"Standard Clauses for New York State Contracts" is Appendix A from the NYS Office of General Services (OGS), as modified by NYS Department of Transportation (NYSDOT).

"Public Notices" text is from NYSDOT Standard Specifications, Section 107-04.

# STANDARD CLAUSES FOR NEW YORK STATE CONTRACTS

## TABLE OF CONTENTS

	Page
1. Executory Clause	TF-B2
2. Non-Assignment Clause	TF-B2
3. Comptroller's Approval	TF-B2
4. Workers' Compensation Benefits	TF-B2
5. Non-Discrimination Requirements	TF-B2
6. Wage and Hours Provisions	TF-B2
7. Non-Collusive Bidding Certification	TF-B3
8. International Boycott Prohibition	TF-B3
9. Set-Off Rights	TF-B3
10. Records	TF-B3
11. Identifying Information and Privacy Notification	TF-B3
12. Equal Employment Opportunities For Minorities and Women	TF-B3 - TF-B4
13. Conflicting Terms	TF-B4
14. Governing Law	TF-B4
15. Late Payment	TF-B4
16. No Arbitration	TF-B4
17. Service of Process	TF-B4
18. Prohibition on Purchase of Tropical Hardwoods	TF-B4 - TF-B5
19. MacBride Fair Employment Principles	TF-B5
20. Omnibus Procurement Act of 1992	TF-B5
21. Reciprocity and Sanctions Provisions	TF-B5
22. Compliance with New York State Information Security Breach and Notification Act	TF-B5
23. Compliance with Consultant Disclosure Law	TF-B5 – TF-B6
24. Procurement Lobbying	TF-B6
25. Certification of Registration to Collect Sales and Compensating Use Tax by Certain State Contractors, Affiliates and Subcontractors	TF-B5
26. Iran Divestment Act	TF-B5

**STANDARD CLAUSES FOR NYS CONTRACTS**

The parties to the attached contract, license, lease, amendment or other agreement of any kind (hereinafter, "the contract" or "this contract") agree to be bound by the following clauses which are hereby made a part of the contract (the word "Contractor" herein refers to any party other than the State, whether a contractor, licensor, licensee, lessor, lessee or any other party):

1. **EXECUTORY CLAUSE.** In accordance with Section 41 of the State Finance Law, the State shall have no liability under this contract to the Contractor or to anyone else beyond funds appropriated and available for this contract.

2. **NON-ASSIGNMENT CLAUSE.** In accordance with Section 138 of the State Finance Law, this contract may not be assigned by the Contractor or its right, title or interest therein assigned, transferred, conveyed, sublet or otherwise disposed of without the State's previous written consent, and attempts to do so are null and void. Notwithstanding the foregoing, such prior written consent of an assignment of a contract let pursuant to Article XI of the State Finance Law may be waived at the discretion of the contracting agency and with the concurrence of the State Comptroller where the original contract was subject to the State Comptroller's approval, where the assignment is due to a reorganization, merger or consolidation of the Contractor's business entity or enterprise. The State retains its right to approve an assignment and to require that any Contractor demonstrate its responsibility to do business with the State. The Contractor may, however, assign its right to receive payments without the State's prior written consent unless this contract concerns Certificates of Participation pursuant to Article 5-A of the State Finance Law.

3. **COMPTROLLER'S APPROVAL.** In accordance with Section 112 of the State Finance Law (or, if this contract is with the State University or City University of New York, Section 355 or Section 6218 of the Education Law), if this contract exceeds \$50,000 (or the minimum thresholds agreed to by the Office of the State Comptroller for certain S.U.N.Y. and C.U.N.Y. contracts), or if this is an amendment for any amount to a contract which, as so amended, exceeds said statutory amount, or if, by this contract, the State agrees to give something other than money when the value or reasonably estimated value of such consideration exceeds \$10,000, it shall not be valid, effective or binding upon the State until it has been approved by the State Comptroller and filed in his office. Comptroller's approval of contracts let by the Office of General Services is required when such contracts exceed \$85,000 (State Finance Law Section 163.6-a). However, such pre-approval shall not be required for any contract established as a centralized contract through the Office of General Services or for a purchase order or other transaction issued under such centralized contract.

4. **WORKERS' COMPENSATION BENEFITS.** In accordance with Section 142 of the State Finance Law, this

contract shall be void and of no force and effect unless the Contractor shall provide and maintain coverage during the life of this contract for the benefit of such employees as are required to be covered by the provisions of the Workers' Compensation Law.

5. **NON-DISCRIMINATION REQUIREMENTS.** To the extent required by Article 15 of the Executive Law (also known as the Human Rights Law) and all other State and Federal statutory and constitutional non-discrimination provisions, the Contractor will not discriminate against any employee or applicant for employment because of race, creed, color, sex (including gender identity or expression), national origin, sexual orientation, military status, age, disability, predisposing genetic characteristics, marital status or domestic violence victim status. Furthermore, in accordance with Section 220-e of the Labor Law, if this is a contract for the construction, alteration or repair of any public building or public work or for the manufacture, sale or distribution of materials, equipment or supplies, and to the extent that this contract shall be performed within the State of New York, Contractor agrees that neither it nor its subcontractors shall, by reason of race, creed, color, disability, sex, or national origin: (a) discriminate in hiring against any New York State citizen who is qualified and available to perform the work; or (b) discriminate against or intimidate any employee hired for the performance of work under this contract. If this is a building service contract as defined in Section 230 of the Labor Law, then, in accordance with Section 239 thereof, Contractor agrees that neither it nor its subcontractors shall by reason of race, creed, color, national origin, age, sex or disability: (a) discriminate in hiring against any New York State citizen who is qualified and available to perform the work; or (b) discriminate against or intimidate any employee hired for the performance of work under this contract. Contractor is subject to fines of \$50.00 per person per day for any violation of Section 220-e or Section 239 as well as possible termination of this contract and forfeiture of all moneys due hereunder for a second or subsequent violation.

6. **WAGE AND HOURS PROVISIONS.** If this is a public work contract covered by Article 8 of the Labor Law or a building service contract covered by Article 9 thereof, neither Contractor's employees nor the employees of its subcontractors may be required or permitted to work more than the number of hours or days stated in said statutes, except as otherwise provided in the Labor Law and as set forth in prevailing wage and supplement schedules issued by the State Labor Department. Furthermore, Contractor and its subcontractors must pay at least the prevailing wage rate and pay or provide the prevailing supplements, including the premium rates for overtime pay, as determined by the State Labor Department in accordance with the Labor Law. Additionally, effective April 28, 2008, if this is a public work contract covered by Article 8 of the Labor Law, the Contractor understands and agrees that the filing of payrolls in a manner consistent with Subdivision 3-a of Section 220 of the Labor Law shall be a condition precedent to payment by the State of



any State approved sums due and owing for work done upon the project.

**7. NON-COLLUSIVE BIDDING CERTIFICATION.** In accordance with Section 139-d of the State Finance Law, if this contract was awarded based upon the submission of bids, Contractor affirms, under penalty of perjury, that its bid was arrived at independently and without collusion aimed at restricting competition. Contractor further affirms that, at the time Contractor submitted its bid, an authorized and responsible person executed and delivered to the State a non-collusive bidding certification on Contractor's behalf.

**8. INTERNATIONAL BOYCOTT PROHIBITION.** In accordance with Section 220-f of the Labor Law and Section 139-h of the State Finance Law, if this contract exceeds \$5,000, the Contractor agrees, as a material condition of the contract, that neither the Contractor nor any substantially owned or affiliated person, firm, partnership or corporation has participated, is participating, or shall participate in an international boycott in violation of the federal Export Administration Act of 1979 (50 USC App. Sections 2401 et seq.) or regulations thereunder. If such Contractor, or any of the aforesaid affiliates of Contractor, is convicted or is otherwise found to have violated said laws or regulations upon the final determination of the United States Commerce Department or any other appropriate agency of the United States subsequent to the contract's execution, such contract, amendment or modification thereto shall be rendered forfeit and void. The Contractor shall so notify the State Comptroller within five (5) business days of such conviction, determination or disposition of appeal (2NYCRR 105.4).

**9. SET-OFF RIGHTS.** The State shall have all of its common law, equitable and statutory rights of set-off. These rights shall include, but not be limited to, the State's option to withhold for the purposes of set-off any moneys due to the Contractor under this contract up to any amounts due and owing to the State with regard to this contract, any other contract with any State department or agency, including any contract for a term commencing prior to the term of this contract, plus any amounts due and owing to the State for any other reason including, without limitation, tax delinquencies, fee delinquencies or monetary penalties relative thereto. The State shall exercise its set-off rights in accordance with normal State practices including, in cases of set-off pursuant to an audit, the finalization of such audit by the State agency, its representatives, or the State Comptroller.

**10. RECORDS.** The Contractor shall establish and maintain complete and accurate books, records, documents, accounts and other evidence directly pertinent to performance under this contract (hereinafter, collectively, "the Records"). The Records must be kept for the balance of the calendar year in which they were made and for six (6) additional years thereafter. The State Comptroller, the Attorney General and any other person or entity authorized to conduct an examination, as well as the agency or agencies involved in this

contract, shall have access to the Records during normal business hours at an office of the Contractor within the State of New York or, if no such office is available, at a mutually agreeable and reasonable venue within the State, for the term specified above for the purposes of inspection, auditing and copying. The State shall take reasonable steps to protect from public disclosure any of the Records which are exempt from disclosure under Section 87 of the Public Officers Law (the "Statute") provided that: (i) the Contractor shall timely inform an appropriate State official, in writing, that said records should not be disclosed; and (ii) said records shall be sufficiently identified; and (iii) designation of said records as exempt under the Statute is reasonable. Nothing contained herein shall diminish, or in any way adversely affect, the State's right to discovery in any pending or future litigation.

**11. IDENTIFYING INFORMATION AND PRIVACY NOTIFICATION.** (a) Identification Number(s). Every invoice or New York State Claim for Payment submitted to a New York State agency by a payee, for payment for the sale of goods or services or for transactions (e.g., leases, easements, licenses, etc.) related to real or personal property must include the payee's identification number. The number is any or all of the following: (i) the payee's Federal employer identification number, (ii) the payee's Federal social security number, and/or (iii) the payee's Vendor Identification Number assigned by the Statewide Financial System. Failure to include such number or numbers may delay payment. Where the payee does not have such number or numbers, the payee, on its invoice or Claim for Payment, must give the reason or reasons why the payee does not have such number or numbers.

(b) Privacy Notification. (1) The authority to request the above personal information from a seller of goods or services or a lessor of real or personal property, and the authority to maintain such information, is found in Section 5 of the State Tax Law. Disclosure of this information by the seller or lessor to the State is mandatory. The principal purpose for which the information is collected is to enable the State to identify individuals, businesses and others who have been delinquent in filing tax returns or may have understated their tax liabilities and to generally identify persons affected by the taxes administered by the Commissioner of Taxation and Finance. The information will be used for tax administration purposes and for any other purpose authorized by law. (2) The personal information is requested by the purchasing unit of the agency contracting to purchase the goods or services or lease the real or personal property covered by this contract or lease. The information is maintained in the Statewide Financial System by the Vendor Management Unit within the Bureau of State Expenditures, Office of the State Comptroller, 110 State Street, Albany, New York 12236.

**12. EQUAL EMPLOYMENT OPPORTUNITIES FOR MINORITIES AND WOMEN.** In accordance with Section 312 of the Executive Law and 5 NYCRR 143, if this contract is: (i) a written agreement or purchase order instrument, providing for a total expenditure in excess of \$25,000.00,

whereby a contracting agency is committed to expend or does expend funds in return for labor, services, supplies, equipment, materials or any combination of the foregoing, to be performed for, or rendered or furnished to the contracting agency; or (ii) a written agreement in excess of \$100,000.00 whereby a contracting agency is committed to expend or does expend funds for the acquisition, construction, demolition, replacement, major repair or renovation of real property and improvements thereon; or (iii) a written agreement in excess of \$100,000.00 whereby the owner of a State assisted housing project is committed to expend or does expend funds for the acquisition, construction, demolition, replacement, major repair or renovation of real property and improvements thereon for such project, then the following shall apply and by signing this agreement the Contractor certifies and affirms that it is Contractor's equal employment opportunity policy that:

(a) The Contractor will not discriminate against employees or applicants for employment because of race, creed, color, national origin, sex, age, disability or marital status, shall make and document its conscientious and active efforts to employ and utilize minority group members and women in its work force on State contracts and will undertake or continue existing programs of affirmative action to ensure that minority group members and women are afforded equal employment opportunities without discrimination. Affirmative action shall mean recruitment, employment, job assignment, promotion, upgradings, demotion, transfer, layoff, or termination and rates of pay or other forms of compensation;

(b) at the request of the contracting agency, the Contractor shall request each employment agency, labor union, or authorized representative of workers with which it has a collective bargaining or other agreement or understanding, to furnish a written statement that such employment agency, labor union or representative will not discriminate on the basis of race, creed, color, national origin, sex, age, disability or marital status and that such union or representative will affirmatively cooperate in the implementation of the Contractor's obligations herein; and

(c) the Contractor shall state, in all solicitations or advertisements for employees, that, in the performance of the State contract, all qualified applicants will be afforded equal employment opportunities without discrimination because of race, creed, color, national origin, sex, age, disability or marital status.

Contractor will include the provisions of "a", "b", and "c" above, in every subcontract over \$25,000.00 for the construction, demolition, replacement, major repair, renovation, planning or design of real property and improvements thereon (the "Work") except where the Work is for the beneficial use of the Contractor. Section 312 does not apply to: (i) work, goods or services unrelated to this contract; or (ii) employment outside New York State. The State shall consider compliance by a contractor or subcontractor with the requirements of any federal law concerning equal employment

opportunity which effectuates the purpose of this section. The contracting agency shall determine whether the imposition of the requirements of the provisions hereof duplicate or conflict with any such federal law and if such duplication or conflict exists, the contracting agency shall waive the applicability of Section 312 to the extent of such duplication or conflict. Contractor will comply with all duly promulgated and lawful rules and regulations of the Department of Economic Development's Division of Minority and Women's Business Development pertaining hereto.

**13. CONFLICTING TERMS.** In the event of a conflict between the terms of the contract (including any and all attachments thereto and amendments thereof) and the terms of this Appendix A, the terms of this Appendix A shall control.

**14. GOVERNING LAW.** This contract shall be governed by the laws of the State of New York except where the Federal supremacy clause requires otherwise.

**15. LATE PAYMENT.** Timeliness of payment and any interest to be paid to Contractor for late payment shall be governed by Article 11-A of the State Finance Law to the extent required by law.

**16. NO ARBITRATION.** Disputes involving this contract, including the breach or alleged breach thereof, may not be submitted to binding arbitration (except where statutorily authorized), but must, instead, be heard in a court of competent jurisdiction of the State of New York.

**17. SERVICE OF PROCESS.** In addition to the methods of service allowed by the State Civil Practice Law & Rules ("CPLR"), Contractor hereby consents to service of process upon it by registered or certified mail, return receipt requested. Service hereunder shall be complete upon Contractor's actual receipt of process or upon the State's receipt of the return thereof by the United States Postal Service as refused or undeliverable. Contractor must promptly notify the State, in writing, of each and every change of address to which service of process can be made. Service by the State to the last known address shall be sufficient. Contractor will have thirty (30) calendar days after service hereunder is complete in which to respond.

**18. PROHIBITION ON PURCHASE OF TROPICAL HARDWOODS.** The Contractor certifies and warrants that all wood products to be used under this contract award will be in accordance with, but not limited to, the specifications and provisions of Section 165 of the State Finance Law, (Use of Tropical Hardwoods) which prohibits purchase and use of tropical hardwoods, unless specifically exempted, by the State or any governmental agency or political subdivision or public benefit corporation. Qualification for an exemption under this law will be the responsibility of the contractor to establish to meet with the approval of the State.

In addition, when any portion of this contract involving the use of woods, whether supply or installation, is to be performed by any subcontractor, the prime Contractor will indicate and certify in the submitted bid proposal that the subcontractor has been informed and is in compliance with specifications and provisions regarding use of tropical hardwoods as detailed in §165 State Finance Law. Any such use must meet with the approval of the State; otherwise, the bid may not be considered responsive. Under bidder certifications, proof of qualification for exemption will be the responsibility of the Contractor to meet with the approval of the State.

**19. MACBRIDE FAIR EMPLOYMENT PRINCIPLES. (APPLICABLE ONLY IN NON-FEDERAL AID NEW YORK STATE CONTRACTS).** In accordance with the MacBride Fair Employment Principles (Chapter 807 of the Laws of 1992), the Contractor hereby stipulates that the Contractor either (a) has no business operations in Northern Ireland, or (b) shall take lawful steps in good faith to conduct any business operations in Northern Ireland in accordance with the MacBride Fair Employment Principles (as described in Section 165 of the New York State Finance Law), and shall permit independent monitoring of compliance with such principles.

**20. OMNIBUS PROCUREMENT ACT OF 1992. (APPLICABLE ONLY IN NON-FEDERAL AID NEW YORK STATE CONTRACTS).** It is the policy of New York State to maximize opportunities for the participation of New York State business enterprises, including minority and women-owned business enterprises as bidders, subcontractors and suppliers on its procurement contracts.

Information on the availability of New York State subcontractors and suppliers is available from:

NYS Department of Economic Development  
Division for Small Business  
Albany, New York 12245  
Telephone: 518-292-5100  
Fax: 518-292-5884  
email: [opa@esd.ny.gov](mailto:opa@esd.ny.gov)

A directory of certified minority and women-owned business enterprises is available from:

NYS Department of Economic Development  
Division of Minority and Women's Business Development  
633 Third Avenue  
New York, NY 10017  
212-803-2414  
email: [mwbecertification@esd.ny.gov](mailto:mwbecertification@esd.ny.gov)  
<https://ny.newnyccontracts.com/FrontEnd/VendorSearchPublic.asp>

The Omnibus Procurement Act of 1992 requires that by signing this bid proposal or contract, as applicable,

Contractors certify that whenever the total bid amount is greater than \$1 million:

(a) The Contractor has made reasonable efforts to encourage the participation of New York State Business Enterprises as suppliers and subcontractors, including certified minority and women-owned business enterprises, on this project, and has retained the documentation of these efforts to be provided upon request to the State;

(b) The Contractor has complied with the Federal Equal Opportunity Act of 1972 (P.L. 92-261), as amended;

(c) The Contractor agrees to make reasonable efforts to provide notification to New York State residents of employment opportunities on this project through listing any such positions with the Job Service Division of the New York State Department of Labor, or providing such notification in such manner as is consistent with existing collective bargaining contracts or agreements. The Contractor agrees to document these efforts and to provide said documentation to the State upon request; and

(d) The Contractor acknowledges notice that the State may seek to obtain offset credits from foreign countries as a result of this contract and agrees to cooperate with the State in these efforts.

**21. RECIPROCITY AND SANCTIONS PROVISIONS.** Bidders are hereby notified that if their principal place of business is located in a country, nation, province, state or political subdivision that penalizes New York State vendors, and if the goods or services they offer will be substantially produced or performed outside New York State, the Omnibus Procurement Act 1994 and 2000 amendments (Chapter 684 and Chapter 383, respectively) require that they be denied contracts which they would otherwise obtain. NOTE: As of May 15, 2002, the list of discriminatory jurisdictions subject to this provision includes the states of South Carolina, Alaska, West Virginia, Wyoming, Louisiana and Hawaii. Contact NYS Department of Economic Development for a current list of jurisdictions subject to this provision.

**22. COMPLIANCE WITH NEW YORK STATE INFORMATION SECURITY BREACH AND NOTIFICATION ACT.** Contractor shall comply with the provisions of the New York State Information Security Breach and Notification Act (General Business Law Section 899-aa; State Technology Law Section 208).

**23. COMPLIANCE WITH CONSULTANT DISCLOSURE LAW.** If this is a contract for consulting services, defined for purposes of this requirement to include analysis, evaluation, research, training, data processing, computer programming, engineering, environmental, health, and mental health services, accounting, auditing, paralegal, legal or similar services, then, in accordance with Section 163 (4-g) of the State Finance Law (as amended by Chapter 10 of

the Laws of 2006), the Contractor shall timely, accurately and properly comply with the requirement to submit an annual employment report for the contract to the agency that awarded the contract, the Department of Civil Service and the State Comptroller.

**24. PROCUREMENT LOBBYING.** To the extent this agreement is a "procurement contract" as defined by State Finance Law Sections 139-j and 139-k, by signing this agreement the contractor certifies and affirms that all disclosures made in accordance with State Finance Law Sections 139-j and 139-k are complete, true and accurate. In the event such certification is found to be intentionally false or intentionally incomplete, the State may terminate the agreement by providing written notification to the Contractor in accordance with the terms of the agreement.

**25. CERTIFICATION OF REGISTRATION TO COLLECT SALES AND COMPENSATING USE TAX BY CERTAIN STATE CONTRACTORS, AFFILIATES AND SUBCONTRACTORS.**

To the extent this agreement is a contract as defined by Tax Law Section 5-a, if the contractor fails to make the certification required by Tax Law Section 5-a or if during the term of the contract, the Department of Taxation and Finance or the covered agency, as defined by Tax Law 5-a, discovers that the certification, made under penalty of perjury, is false, then such failure to file or false certification shall be a material breach of this contract and this contract may be terminated, by providing written notification to the Contractor in accordance with the terms of the agreement, if the covered agency determines that such action is in the best interest of the State.

**26. IRAN DIVESTMENT ACT.** By entering into this Agreement, Contractor certifies in accordance with State Finance Law §165-a that it is not on the "Entities Determined to be Non-Responsive Bidders/Offerers pursuant to the New York State Iran Divestment Act of 2012" ("Prohibited Entities List") posted at:  
<http://www.ogs.ny.gov/about/regs/docs/ListofEntities.pdf>

Contractor further certifies that it will not utilize on this Contract any subcontractor that is identified on the Prohibited Entities List. Contractor agrees that should it seek to renew or extend this Contract, it must provide the same certification at the time the Contract is renewed or extended. Contractor also agrees that any proposed Assignee of this Contract will be required to certify that it is not on the Prohibited Entities List before the contract assignment will be approved by the State.

During the term of the Contract, should the state agency receive information that a person (as defined in State Finance Law §165-a) is in violation of the above-referenced certifications, the state agency will review such information and offer the person an opportunity to respond. If the person fails to demonstrate that it has ceased its engagement in the investment activity which is in violation of the Act within 90 days after the determination of such violation, then the state

agency shall take such action as may be appropriate and provided for by law, rule, or contract, including, but not limited to, imposing sanctions, seeking compliance, recovering damages, or declaring the Contractor in default.

The state agency reserves the right to reject any bid, request for assignment, renewal or extension for an entity that appears on the Prohibited Entities List prior to the award, assignment, renewal or extension of a contract, and to pursue a responsibility review with respect to any entity that is awarded a contract and appears on the Prohibited Entities list after contract award.

**LABOR AND EMPLOYMENT PROVISIONS**

The provisions of NYS Labor Law, as amended, and referred to in *Standard Clauses for All New York State Contracts*, shall be applicable. On contracts financed with Federal-Aid, any provisions of NYS Labor Law that are in conflict with mandatory Federal-Aid construction contract compliance requirements, as contained in 23 CFR 635.117 are superseded. Any provisions of NYS Labor Law that are not in conflict with mandatory Federal-Aid construction contract compliance requirements, or the Davis-Bacon Act, but are more restrictive, shall apply.

The Contractor shall directly employ those members of its own organization. Employee leasing and other similar arrangements under which workers are employed by another organization are not permitted. No procedures or requirement shall be imposed by any state which will operate to discriminate against the employment of labor from any other state, possession or territory of the United States, in the construction of a Federal-Aid project. The selection of labor to be employed by the Contractor on any Federal-Aid project shall be of its choosing.

The Contractor shall not use convict labor unless performed by convicts who are on parole, supervised release, or probation for construction, maintenance or any other purpose at the site or within the contract limits from the time of contract award until contract final acceptance by the Department.

**A. Wages.** The Department will identify in the contract proposal whether the NYS Department of Labor (NYSDOL) has determined the work under the contract to be prevailing wage eligible, and if so, provide the Prevailing Rate Case (PRC) number. The PRC number is found on NYSDOL Form PW-200. The Contractor shall ensure that workers are paid the appropriate wages and supplemental (fringe) benefits. If the contract is prevailing wage eligible, all on-site work shall be paid prevailing wages. When both State and Federal prevailing wages apply, the Contractor shall pay the higher of the wages, and the higher of the combination of the wages and supplemental (fringe) benefits. The Contractor shall obtain periodic wage rate schedule updates from the NYSDOL. Wage rate amendments and supplements are available on the NYSDOL web site at [www.labor.ny.gov](http://www.labor.ny.gov). All changes or clarification of labor classification(s) and applicability of prevailing wage rates shall be obtained in writing from the Office of the Director, NYSDOL Bureau of Public Work. The Contractor shall include the cost of changes in wage rate schedules and supplements (fringes) over the contract duration in the contract bid prices.

**B. Overtime Dispensation.** All bidders, in submitting their bids, should base their bids and work progression on the assumption that Overtime Dispensation pursuant to Article 8 of the New York State Labor Law, for any workers, laborers, and mechanics to work more than 8 hours in any one calendar day or more than 5 days in any one week will not be granted for any operation for the contract duration. Regardless of approval or disapproval of overtime by the NYSDOL, no adjustment will be made in any bid prices.

Subsequent to award, where the contract proposal has imposed specific scheduling and/or phasing requirements or where it is determined by the Department to be in the best interest of the public, the Department may process, for approval by the NYSDOL, requests for overtime dispensation on certain specific operations.

The Contractor shall submit requests for overtime dispensation to the Department on Form PW- 30, Application for Dispensation for Hours, which will be provided by the Engineer upon request. The Department will review applications for overtime dispensation submitted by the Contractor associated with contracts subject to (A+B) Bidding, Incentive/Disincentive (I/D) or Lane Rental work favorably, but the application should not request more than 60 hours per week. The 60 hours per week may be either 6 - 10 hour days or 5 - 12 hour days. Overtime dispensations will be supported by the Department to advance Department goals and priorities, subject to specific circumstances and conditions associated with each contract.

The Department cannot guarantee that the NYSDOL will grant dispensation from restrictions pursuant to the provisions of Article 8 of the State Labor Law, however with the Department's certification, it is anticipated that they will act favorably, provided that the Contractor is in compliance with Labor Law requirements at the time of application.

**C. Payrolls.** The Contractor shall provide the Engineer, each week, a certified payroll and statement of compliance with respect to the wages paid each of its employees subject to prevailing wage requirements and a certified payroll from each Subcontractor engaged on work during the preceding weekly payroll period. If the Contractor or Subcontractor does not

maintain a place of business in New York State and the amount of the contract exceeds \$25,000., payroll records and certifications shall be kept on the worksite.

Certified payrolls shall contain for each employee, name, race, gender, home address, an individually identifying number (e.g. the last 4 digits of the employee's social security number), work class, hours worked, wage rate, supplemental (fringe) benefits paid or provided, payroll taxes, withholdings and actual wages paid. Certified payrolls shall not include full social security numbers of employees. Certified payrolls shall be submitted on Form WH-347 or Form HC-231-1 for Federal- Aid contracts and on HC-231-1 for non Federal-Aid contracts. At the Contractor's option, other payroll formats, which supply the required data and certifications, may be used. Each payroll submitted shall be accompanied by a Statement of Compliance signed by the Contractor.

Contractors and subcontractors shall maintain the full social security number and current address of each covered worker, and shall provide them upon request to NYSDOL or USDOL for purposes of an investigation or audit of compliance with prevailing wage requirements. Contractors may require subcontractors to provide addresses and social security numbers to the Contractor for its own records, without weekly submission to the Department.

**D. Apprenticeship.**

(1) Apprenticeship Program Requirements

Notice to Bidders: Please be advised that, pursuant to the authority granted to the City under Labor Law Section 816-b, the Department of Design and Construction hereby requires that the contractor awarded a contract as a result of this Invitation for Bids, and any of its subcontractors with subcontracts worth two million dollars or over, have, prior to entering into such contract or subcontract, apprenticeship agreements appropriate for the type and scope of work to be performed that have been registered with, and approved by, the New York State Commissioner of Labor. In addition, the contractor and its subcontractors will be required to show that such apprenticeship program/s have successfully passed the two year Probation period following the initial registration date of such program/s with the New York State Department of Labor.

The failure to prove, upon request, that these requirements have been met shall result in the contract not being awarded to the contractor or the subcontract not being approved.

Please be further advised that, pursuant to Labor Law Section 220, the allowable ratio of apprentices to journeypersons in any craft classification shall not be greater than the ratio permitted to the contractor as to its workforce on any job under the registered apprenticeship program.

(2) Apprenticeship Program Questionnaire

The bidder must submit a completed and signed Apprenticeship Program Questionnaire. The Questionnaire is located in the Bid Booklet, in Volume 1 of 3 of this contract.

**PUBLIC NOTICES**

Before commencing any work on the site, the Contractor shall provide a satisfactory weather resistant surface, and post, in a location accessible to all workers, a copy of the NYSDOL schedules of prevailing wages and supplements for this contract, a copy of all redeterminations of such schedules for the contract, the Workers' Compensation Law notice, required safety notices, and all other notices required by law to be posted at the site. The Contractor shall maintain such notices in a legible manner and shall replace any notice or schedule which is damaged, defaced, illegible or removed for any reason. The notices shall be maintained until all work on the site is complete.

**NOTICE TO ALL PROSPECTIVE BIDDERS  
FEDERAL-AID CONTRACTS**

**ASSURANCE OF NON-DISCRIMINATION**

The New York State Department of Transportation, in accordance with Title VI of the Civil Rights Act of 1964, 78 Stat. 252, 42 U.S.C. 2000d to 2000d-4 and Title 49, Code of Federal Regulations, Department of Transportation, Subtitle A, Office of the Secretary, Part 21, Nondiscrimination in Federally-assisted programs of the Department of Transportation and Title 23 Code of Federal Regulations, Part 200, Title VI Program and Related Statutes, as amended, issued pursuant to such Acts, hereby notifies all bidders that it will affirmatively ensure that in any contract entered into pursuant to this advertisement, disadvantaged business enterprises will be afforded full opportunity to submit bids in response to this invitation and will not be discriminated against on the grounds of race, color, national origin, sex, age, disability/handicap and income status in consideration for an award.

**SUBCONTRACTS**

The attention of the Contractor is directed to the requirement that the standard contract clauses, as set forth in the Proposal and in the NYS Department of Transportation Labor Compliance Manual (Federal-aid Construction, Appendix D-2, 3) must be physically incorporated in all subcontracts.

Copies of the Labor Compliance Manual referred to above may be examined in the office of the NYS Department of Transportation Regional Director.

**SUPPLEMENTAL TITLE VI PROVISIONS (CIVIL RIGHTS ACT)**

(To be included in all contracts)

During the performance of this contract, the contractor, for itself, its assignees and successors in interest (hereinafter referred to as the "contractor") agrees as follows:

- (1) **Compliance with Regulations:** The contractor shall comply with the Regulation relative to nondiscrimination in Federally assisted programs of the Department of Transportation of the United States, Title 49, Code of Federal Regulations, Part 21, and the Federal Highway Administration (hereinafter "FHWA") Title 23, Code of Federal Regulations, Part 200 as they may be amended from time to time, (hereinafter referred to as the Regulations), which are herein incorporated by reference and made a part of this contract.
- (2) **Nondiscrimination:** The Contractor, with regard to the work performed by it during the contract, shall not discriminate on the grounds of race, religion, age, color, sex or national origin, sex, age, and disability/handicap in the selection and retention of subcontractors, including procurements of materials and leases of equipment. The contractor shall not participate either directly or indirectly in the discrimination prohibited by 49 CFR, section 21.5 of the Regulations, including employment practices when the contract covers a program set forth in Appendix B of the Regulations.



## ATTACHMENT "C"

- (3) Solicitations for Subcontractors, Including Procurements of Materials and Equipment: In all solicitations either by competitive bidding or negotiation made by the contractor for work to be performed under a subcontract, including procurements of materials or leases of equipment, each potential subcontractor or supplier shall be notified by the contractor of the contractor's obligations under this contract and the Regulations relative to nondiscrimination on the grounds of race, color, or national origin, sex, age, and disability/handicap.
- (4) Information and Reports: The contractor shall provide all information and reports required by the Regulations or directives issued pursuant thereto, and shall permit access to its books, records, accounts, other sources of information, and its facilities as may be determined by NYSDOT or the FHWA to be pertinent to ascertain compliance with such Regulations, orders and instructions. Where any information required of a contractor is in the exclusive possession of another who fails or refuses to furnish this information the contractor shall so certify to NYSDOT's Office of Civil Rights or FHWA, as appropriate, and shall set forth what efforts it has made to obtain the information.
- (5) Sanctions for Noncompliance: In the event of the contractor's noncompliance with the nondiscrimination provisions of this contract, NYSDOT shall impose such contract sanctions as it or the FHWA may determine to be appropriate, including, but not limited to:
- a) Withholding of payments to the contractor under the contract until the contractor complies; and/or
  - b) Cancellation, termination or suspension of the contract, in whole or in part.
- (6) Incorporation of Provisions: The contractor shall include the provisions of paragraphs (1) through (6) in every subcontract, including procurements of materials and leases of equipment, unless exempt by the Regulations, or directives issued pursuant thereto.

The contractor shall take such action with respect to any subcontractor procurement as NYSDOT or the FHWA may direct as a means of enforcing such provisions including sanctions for non-compliance: Provided, however, that in the event a contractor becomes involved in, or is threatened with, litigation with a subcontractor or supplier as a result of such direction, the contractor may request NYSDOT to enter into such litigation to protect the interests of NYSDOT, and, in addition, the contractor may request the United States to enter into such litigation to protect the interests of the United States.

## ATTACHMENT "D"

### DISADVANTAGED BUSINESS ENTERPRISE REQUIREMENTS

**DBE UTILIZATION.** DBE refers to a Disadvantaged Business Enterprise (DBE). The DBE program applies to Federal-Aid contracts. The program seeks to:

- Ensure nondiscrimination in the award and administration of Federal-Aid contracts;
- Create a level playing field on which DBEs can fairly compete for Federal-Aid contracts;
- Ensure that the DBE program is narrowly tailored in accordance with applicable law;
- Ensure that only firms that fully meet DBE eligibility standards are permitted to participate as DBEs;
- Help remove barriers to the participation of DBEs in Federal-Aid contracts;
- Promote the use of DBEs in all types of federally-assisted contracts and procurement activities conducted by recipients of Federal financial assistance;
- Assist in the development of firms that can compete successfully in the marketplace outside the DBE program; and
- Provide appropriate flexibility to recipients of Federal financial assistance in establishing and providing opportunities for DBEs.

The parties to this contract shall take all necessary and reasonable steps in accordance with the laws, rules and regulations cited in this subsection to promote the objectives outlined above. The Contractor shall comply with the applicable laws, rules and regulations and the DBE Program Assurance stated below.

**DBE Program Assurance.** The Contractor or Subcontractor shall not discriminate on the basis of race, color, national origin, or sex in the award and performance of this contract. The Contractor shall carry out applicable requirements of 49 CFR 26 in the award and administration of Federal-Aid contracts. Failure by the Contractor to carry out these requirements is a material breach of this contract, which may result in the termination of this contract or such other remedy as the Department deems appropriate, which may include, but is not limited to: (1) withholding contract payments; (2) assessing sanctions; (3) liquidated damages; and/or (4) disqualifying the Contractor from future bidding as non-responsible.

**A. Statutory Authority.** The statutory authority for the DBE Program is contained in the Surface Transportation Assistance Act ("STAA") of 1982 (Public Law 97-424, §105(f)), the Surface Transportation and Uniform Relocation Assistance Act of 1987 (Public Law 100-17, §106(c)), the Intermodal Surface Transportation Efficiency Act of 1991, the Transportation Equity Act for the 21st Century ("TEA-1") of 1998 (Public Law 105-178, §1101(b)), the Safe, Accountable, Flexible, Efficient Transportation Equity Act: A Legacy for Users ("SAFETEA-LU") of 2005 (Public Law 109-59 §1101(b)), the Moving Ahead for Progress in the 21st Century Act ("MAP-21") of 2012 (Public Law 112-141, §1101(b)), and the Fixing America's Surface Transportation Act ("FAST-ACT") of 2015 (Public Law 114-94, §1101(b)). New York State has enacted Section 85 of the Highway Law and Section 428 of the Transportation Law. Regulations have been promulgated under 49 CFR 21, 49 CFR 26 and 17 NYCRR 35.

**B. DBE Goal(s).** Federal-aid construction contracts have a single DBE goal. The Department will monitor the Contractor's attainments towards DBE goals in accordance with Attachment H, *Civil Rights Monitoring and Reporting*.

**1. Established Goal(s).** The Department may have established contract utilization goal(s) for DBEs, which are expressed as a percentage of the total contract price. The goal(s) are stated in the proposal and remain in effect throughout the life of the contract. In executing the contract or bid documents the Bidder declares that it subscribes to the utilization goal(s) and shall meet the goal(s) or demonstrate that it could not meet them

## ATTACHMENT "D"

despite its best efforts. Failure to provide commitments to meet the established goal(s) for the contract or failure to meet the good faith efforts shall be grounds for rejection of the bid as non-responsive. Good faith efforts shall meet the requirements of 49 CFR 26 Appendix A.

**2. Zero Percent Goal(s).** When a zero goal(s) for participation by DBEs has been established, and the Bidder proposes the use of a Subcontractor, the purchase of materials, the use of a Service or the use of Trucking at any time during the life of the contract, the Contractor shall promote the objectives outlined in this subsection by providing opportunities for DBEs to participate in these areas, with such participation to be credited towards the race-neutral component of the DBE Program.

**C. DBE Eligibility.** Only those DBE firms that are certified under the New York State Unified Certification Program are eligible to be used for goal attainment. DBE certification is not an endorsement of the quality or performance of the business but simply an acknowledgment of the firm's status as a DBE. Furthermore, DBEs must be certified for the type of work to be performed. A business directory is available on the NYS Unified Certification Program website at <https://nysucp.newnycontracts.com>.

**D. Counting DBE Participation Towards the DBE Goal(s).** The value of the work performed by a DBE, including that of a DBE prime contractor, with its own equipment, with its own forces, and under its own supervision will be counted toward the goal(s), provided the utilization is a commercially useful function. A DBE prime contractor shall still provide opportunities for participation by other DBEs. Work performed by DBEs on the contract will be counted as set forth below. If the Department determines that some or all of a DBE's work does not constitute a commercially useful function, only the portion of the work considered to be a commercially useful function will be credited toward the goal(s).

**1. Joint Ventures.** When a DBE performs as a participant in a joint venture, a portion of the total dollar value of the contract equal to the distinct, clearly defined portion of the work of the contract that the DBE performs with its own forces will be counted toward DBE goals.

**2. Subcontractors.** 100% of the value of the work performed by a DBE Subcontractor will be counted toward the DBE goal(s), including the cost of materials and supplies purchased by the DBE. The DBE may not rent or lease equipment from the Contractor or its affiliates. When a DBE subcontracts part of the work of its contract to another firm, the value of the subcontracted work may be counted toward DBE goals only if the DBE's subcontractor is itself a DBE. Work that a DBE subcontracts to a non-DBE firm does not count toward DBE goals.

**3. Manufacturers/Fabricators.** 100% of the expenditure to a DBE Manufacturer or Fabricator will be counted toward the DBE goal(s). Manufacturers or Fabricators may provide materials to the Contractor, a Subcontractor, or other firm working on the contract for installation.

**4. Material Suppliers.** 60% of the expenditure to a DBE Material Supplier will be counted toward the DBE goal. A Material Supplier, also known as a regular dealer, is a firm that owns, operates, or maintains a store, warehouse, or other establishment in which the materials, supplies, articles or equipment of the general character described by the specifications and required under the contract are bought, kept in stock, and regularly sold or leased to the public in the usual course of business. Packagers, brokers, manufacturer's representatives, or other persons who arrange or expedite

## ATTACHMENT "D"

transactions are not Material Suppliers. Material Suppliers may provide materials to the Contractor, a Subcontractor, or other firm working on the contract for installation.

**5. Brokers/Manufacturer's Representatives.** 100% of the expenditures for fees or commissions charged for assistance in the procurement of, or fees for transportation charges for the delivery of, materials or supplies provided by a DBE Broker/Manufacturer's Representative will be counted toward the DBE goal(s), provided they are determined to be reasonable and not excessive as compared with fees customarily allowed for similar services. The cost of the materials and supplies themselves will not be counted. Brokers may supply materials to the Contractor, Subcontractor, or other firm working on the contract.

**6. Services.** 100% of the expenditure for fees charged by a DBE for providing a bona fide service, such as professional, technical, consultant, or managerial services, or for providing bonds or insurance specifically required for the performance of the contract will be counted toward the DBE goal(s), provided the fee is reasonable and not excessive as compared with fees customarily allowed for similar services.

**7. Trucking Operations.** A DBE trucking firm shall own and operate at least one registered, insured, and fully operational truck used on the contract and shall be responsible for the management and supervision of the trucking operation for which it is responsible. The DBE trucking firm shall control the day-to-day DBE trucking operations, and shall be responsible for: (1) Negotiating and executing rental/leasing agreements; (2) Controlling the work force; (3) Coordinating the daily trucking needs with the Contractor or Subcontractor; and (4) Scheduling and dispatching trucks.

*a. DBE Owned/Leased Trucks.* 100% of the value of the trucking operations the DBE provides on the contract using trucks it owns or leases on a long-term basis that are registered, insured, and operated by the DBE using drivers it employs, will be counted toward the DBE goal. A lease shall indicate that the DBE has exclusive use of and control over the truck. This does not preclude the leased truck from working for others during the term of the lease with the consent of the DBE, so long as the lease gives the DBE absolute priority for use of the leased truck. Leased trucks shall display the name and identification number of the DBE.

*b. Other DBE Trucks.* The DBE may obtain trucks from another DBE, including an owner/operator. 100% of the value of the trucking operations that the other DBE provides will also be counted toward the DBE goal.

*c. Non-DBE Trucks.* The DBE may obtain trucks from a non-DBE, including an owner-operator. Only the value of the fee or commission that the DBE receives as a result of the arrangement with the non-DBE will be counted toward the DBE goal.

**E. Conditions of Participation.** DBE participation will be counted toward meeting the DBE contract goal(s), subject to the following conditions:

**1. Commercially Useful Function.** A DBE is considered to perform a commercially useful function when it is responsible for the execution of a distinct element of work on a contract and carries out its responsibilities by actually performing, managing, and supervising the work involved in accordance with normal industry practice. The arrangement cannot be contrived solely for the purpose of meeting the DBE goal. Regardless of whether an arrangement between the Contractor and the DBE represent standard industry practice, if the arrangement erodes the ownership, control or independence of the DBE or in any other way does not meet the commercially useful function requirement, the Contractor will receive no credit toward the goal(s) and shall

## ATTACHMENT "D"

take all necessary and reasonable steps to backfill the participation. Additionally, a DBE not performing a commercially useful function may, in some instances, warrant further investigation of the DBE's certification status or review of the DBE for fraud. A DBE does not perform a commercially useful function if its role is limited to that of an extra participant in a transaction or contract through which funds are passed in order to obtain the appearance of DBE participation.

A DBE may present evidence to rebut a determination by the Department that the DBE is not performing a commercially useful function. Commercially useful function determinations by the Department are subject to review by the Federal Highway Administration (FHWA) but the determination may not be administratively appealed to USDOT.

**2. Work Force.** The DBE shall employ a work force, (including administrative and clerical) separate and apart from that employed by the Contractor, other Subcontractors on the contract, or their affiliates. The DBE shall perform or exercise responsibility for at least 30 percent of the total cost of its contract with its own work force. This does not preclude the employment by the DBE of an individual that has been previously employed by another firm involved in the contract, provided that the individual was independently recruited by the DBE in accordance with customary industry practice. The routine transfer of work crews from another employer to the DBE shall not be allowed.

**3. Supervision.** All work performed by the DBE must be controlled and supervised by the DBE without duplication of supervisory personnel from the Contractor, other Subcontractors on the contract, or their affiliates. This does not preclude routine communication between the supervisory personnel of the DBE and other supervisors necessary to coordinate the contract work.

**4. Materials.** DBE Subcontractors shall negotiate price, determine quality and quantity, order and pay for the material(s) required to perform the work.

**5. Equipment.** DBE Subcontractors may supplement their equipment by renting or leasing additional equipment in accordance with customary industry practice. The DBE shall obtain approval of the Department prior to renting equipment from the Contractor or its affiliates, and shall provide documentation demonstrating that similar equipment and terms could not be obtained at a lower cost from other customary sources of equipment. The required documentation shall include, but not be limited to, copies of the rental or leasing agreements, and the names, addresses, and terms quoted by other sources of equipment.

### **F. Not Used.**

**G. Good Faith Efforts.** To determine whether a bidder that has failed to meet the DBE contract goal(s) may receive the contract, the Department, in consultation with NYSDOT, will decide whether the efforts the Bidder made to obtain DBE participation were "good faith efforts" to meet the goal(s). Efforts to obtain DBE participation that are merely pro forma are not good faith efforts, nor are efforts that, even if they are sincerely motivated, given all relevant circumstances, they could not reasonably be expected to produce a level of DBE participation sufficient to meet the goal(s).

In order to award a contract to a bidder that has failed to meet the DBE contract goal(s), the Department, in consultation with NYSDOT, will determine that the Bidder's good faith efforts were those that, given all relevant circumstances, a bidder actively and aggressively seeking to meet the goal(s) would make.

## ATTACHMENT "D"

When a contract is awarded with DBE commitment(s) that is less than the contract goal(s), the Contractor shall continue good faith efforts. The Contractor shall continuously review items that are available for DBE participation, especially before the beginning of a new construction season and when significant new items of work are added to the contract, and conduct additional DBE solicitation.

In order to evaluate the Bidder's good faith efforts, the Department will consider the quality, quantity, and intensity of the different kinds of efforts that the Bidder has made. Below is a list of the types of actions which the Department will consider as part of the Bidder's good faith efforts to obtain DBE participation. It is not a mandatory checklist, nor is it intended to be exhaustive or exclusive. Other factors or types of efforts may be relevant in appropriate cases.

1. a. Conducting market research to identify small business contractors and suppliers and soliciting through all reasonable and available means the interest of all certified DBEs that have the capability to perform the work of the contract. This may include attendance at pre-bid and business matchmaking meetings and events, advertising and/or written notices, posting of Notices of Sources Sought and/or Requests for Proposals, written notices or emails to all DBEs listed in the State's directory of transportation firms that specialize in the areas of work desired (as noted in the DBE directory) and which are located in the area or surrounding areas of the project.
- b. The bidder should solicit this interest as early in the acquisition process as practicable to allow the DBEs to respond to the solicitation and submit a timely offer for the subcontract. The bidder should determine with certainty if the DBEs are interested by taking appropriate steps to follow up initial solicitations.
2. Selecting portions of the work to be performed by DBEs in order to increase the likelihood that the DBE goals will be achieved. This includes, where appropriate, breaking out contract work items into economically feasible units (for example, smaller tasks or quantities) to facilitate DBE participation, even when the prime contractor might otherwise prefer to perform these work items with its own forces. This may include, where possible, establishing flexible timeframes for performance and delivery schedules in a manner that encourages and facilitates DBE participation.
3. Providing interested DBEs with adequate information about the plans, specifications, and requirements of the contract in a timely manner to assist them in responding to a solicitation with their offer for the subcontract.
4. a. Negotiating in good faith with interested DBEs. It is the bidder's responsibility to make a portion of the work available to DBE subcontractors and suppliers and to select those portions of the work or material needs consistent with the available DBE subcontractors and suppliers, so as to facilitate DBE participation. Evidence of such negotiation includes the names, addresses, and telephone numbers of DBEs that were considered; a description of the information provided regarding the plans and specifications for the work selected for subcontracting; and evidence as to why additional Agreements could not be reached for DBEs to perform the work.
- b. A bidder using good business judgment would consider a number of factors in negotiating with subcontractors, including DBE subcontractors, and would take a firm's price and capabilities as well as contract goals into consideration. However, the fact that there may be some additional costs involved in finding and using DBEs is not in itself sufficient reason for a bidder's failure to meet the contract DBE goal, as long as such costs are reasonable. Also, the ability or desire of a prime contractor to

## ATTACHMENT "D"

perform the work of a contract with its own organization does not relieve the bidder of the responsibility to make good faith efforts. Prime contractors are not, however, required to accept higher quotes from DBEs if the price difference is excessive or unreasonable.

5. a. Not rejecting DBEs as being unqualified without sound reasons based on a thorough investigation of their capabilities: The contractor's standing within its industry, membership in specific groups, organizations, or associations and political or social affiliations (for example union vs. non-union status) are not legitimate causes for the rejection or non-solicitation of bids in the contractor's efforts to meet the project goal. Another practice considered an insufficient good faith effort is the rejection of the DBE because its quotation for the work was not the lowest received. However, nothing in this paragraph shall be construed to require the bidder or prime contractor to accept unreasonable quotes in order to satisfy contract goals.
- b. A prime contractor's inability to find a replacement DBE at the original price is not alone sufficient to support a finding that good faith efforts have been made to replace the original DBE. The fact that the contractor has the ability and/or desire to perform the contract work with its own forces does not relieve the contractor of the obligation to make good faith efforts to find a replacement DBE, and it is not a sound basis for rejecting a prospective replacement DBE's reasonable quote.
6. Making efforts to assist interested DBEs in obtaining bonding, lines of credit, or insurance as required by the recipient or contractor.
7. Making efforts to assist interested DBEs in obtaining necessary equipment, supplies, materials, or related assistance or services.
8. Effectively using the services of available minority/women community organizations; minority/women contractors' groups; local, State, and Federal minority/women business assistance offices; and other organizations as allowed on a case-by-case basis to provide assistance in the recruitment and placement of DBEs.

**H. DBE Pre-Award Utilization Package.** Together with its bid, each bidder shall submit a completed DBE Schedule of Utilization, as outlined below.

Low Bidders that do not have access to the approved civil rights reporting software shall contact the Department for guidance on submission of the Utilization Package. As soon as practicable, but not later than prior to the first contract payment, the Contractor shall enter all current utilization data into the approved civil rights reporting software.

For each DBE Subcontractor, the Low Bidder shall indicate the contract pay item number(s) of the work to be performed. The Low Bidder shall explain, in writing, the scope of work to be performed by the DBE for any item which is not completely performed by the DBE Subcontractor. This does not include items for which the Contractor is performing less than the total contract quantity for that item.

For each DBE Manufacturer, Fabricator, Material Supplier, or Broker, the Low Bidder shall indicate the contract pay item number(s) of the material to be manufactured, fabricated, supplied, or otherwise provided. If the material, equipment or service does not correspond to a specific contract pay item, the Low Bidder shall use a contract pay item(s) to which the activity relates.

For each DBE Service, the Low Bidder shall indicate the contract pay item number(s) of the service to be provided. If the equipment or service does not correspond to a specific

## ATTACHMENT "D"

contract pay item, the Low Bidder shall use a contract pay item(s) to which the activity relates.

For each DBE Trucking Operation, the Low Bidder shall indicate the contract pay item number(s) for which the trucking operations are to be performed. If the trucking operation does not correspond to a specific contract pay item, the Low Bidder shall use a contract pay item(s) to which the activity relates. The Low Bidder shall indicate the type of trucking operation to be performed, the number of trucks owned/leased, the number of trucks working on-site or off-site, rate per hour/ton/load/etc., duration or amount, and total dollar value of the proposed DBE commitment. The Low Bidder shall provide copies of all lease agreements utilized by the DBE.

If the Low Bidder has met or exceeded the established DBE goal(s) for the contract utilizing certified DBEs it is not necessary to submit documentation of good faith efforts.

If the Low Bidder has not met the DBE goal(s), it shall submit the *Solicitation Log*, together with other documentation that substantiates good faith efforts. Such documentation shall include, at a minimum, all envelopes of solicitation inquiries that were returned as undeliverable, quotations submitted by DBEs that are not included in the *DBE Schedule of Utilization*, and relevant non-DBE quotations with an explanation for the Bidder's action in each case.

After contract award, the Contractor shall promptly execute subcontracts, agreements, or purchase orders, as appropriate, with each DBE for the type and amount of work identified in the approved *DBE Utilization Worksheet*.

***I. Bidder's Failure to Comply With DBE Program Requirements.*** The Department's acceptance of the Low Bidder's bid is conditioned upon the Low Bidder's fulfillment of the DBE utilization requirements. If the Low Bidder fails to submit a complete DBE utilization package with its bid and/or fails to attain the DBE utilization goal(s) and to satisfactorily document its good faith efforts, the bid shall be declared non-responsive and the deposit may be subject to forfeiture pursuant to Section 27 of the Information for Bidders. The Low Bidder, upon receipt of written notification of its failure to comply with the DBE utilization requirements shall have 5 work days to carry out the corrective action(s) described in the notification.

If the Department determines that the Low Bidder has failed to meet the good faith effort requirements, the Department will, before awarding the contract, provide the Low Bidder an opportunity for administrative reconsideration by an official who did not take part in the original determination that the Low Bidder failed to meet the goal(s) or make adequate good faith efforts to do so. As part of this reconsideration, the Low Bidder shall have the opportunity to provide written documentation or argument and to meet in person with the Department's reconsideration official concerning the issue of whether it met the goal(s) or made adequate good faith efforts to do so. The Department will send the Low Bidder a written decision on reconsideration, explaining the basis for finding that the Low Bidder did or did not meet the goal(s) or make adequate good faith efforts to do so.



**ATTACHMENT "D"**

**(NO TEXT THIS PAGE)**

**"BUY AMERICA" REQUIREMENTS & WAIVERS**

**BUY AMERICA** In accordance 41 U.S.C. §10a et. seq., 23 CFR 635.410 and Section 146 of the State Finance Law permanently incorporated predominantly steel and/or iron products materials shall be domestically produced, regardless of the percentage they comprise in a manufactured product, or form they take.

The Contractor may permanently incorporate in the construction of this contract a minimal amount of foreign steel and/or iron materials that are subject to Buy America requirements, if the combined cost of such materials does not exceed one-tenth of one percent (0.1 %) of the total contract cost or \$2,500, whichever is greater. The combined cost of foreign steel and/or iron materials will be the value of the materials as they are delivered to the contract, documented by invoice or bill of sale to the Contractor.

To qualify as domestic, all manufacturing processes, including manufacture, fabrication, grinding, drilling, welding, finishing, and coating of any product containing steel and/or iron materials, must have been performed in the United States. To further define the coverage, a domestic product is a manufactured steel and/or iron materials construction material that was produced in one of the 50 States, the District of Columbia, Puerto Rico, or in the territories and possessions of the United States. Raw materials used in the steel and/or iron materials may be imported. Raw materials are materials such as iron ore, limestone, waste products, etc., which are used in the manufacturing process to produce the steel and/or iron materials products. Waste products include scrap; i.e., steel no longer useful in its present form from old automobiles, machinery, pipe, railroad rail, steel trimmings from mills or product manufacturing, and the like. Extracting, crushing, and handling the raw materials which are customary to prepare them for transporting are exempt from Buy America. The use of foreign source steel or iron billets is not acceptable under Buy America.

**A. Control of Materials.** All items, regardless of origin, shall comply with their individual specification requirements and with the requirements stated elsewhere in this subsection. In the event the contract is awarded based on using only domestic steel and/or iron materials, the Contractor shall supply only domestic steel and/or iron materials and will be paid the domestic bid prices. The Contractor shall ensure the domestic steel and/or iron materials are supplied in conformance with the above referenced laws. The Contractor shall inform all affected Subcontractors and material suppliers of these specific requirements and ascertain that steel and/or iron materials being supplied is in conformance with these requirements.

**B. Waivers.** Waivers to the Buy America requirement may be requested by the Contractor if it can be demonstrated that the use of domestic steel and/or iron materials would be inconsistent with the public interest, such materials and products are not produced in the United States in sufficient and reasonably available quantities and of satisfactory quality.

Provided one or more of the above requirements are met, the Contractor may submit a request for a waiver to the Engineer. The request shall include copies of all documentation verifying the unavailability of the material or product, and/or justification of the application for a waiver.

The Department will submit approved waiver requests to the FHWA for review. The Contractor shall investigate and respond to any public comments made to the FHWA Office of Program Administration, indicating that a domestic supplier can provide the material for which a waiver has been requested. Final approval of the Buy America Waiver request will be made by the Administrator, Federal Highway Administration. The waiver will be effective when it is posted in the Federal Register.

## ATTACHMENT "E"

**CERTIFICATIONS AND TRACKING OF FOREIGN STEEL AND/OR IRON.** In order to ensure compliance with this contract requirement, all manufacturer's certifications for steel and/or iron and items including steel and/or iron must contain a statement of domestic origin, and material suppliers must certify that what they provide is the same material certified by the manufacturer. If the material or product certification does not properly identify conformance to the specification the product will be rejected and must be removed from the project site. If however the manufacturer and/or material supplier requests to leave the product in place and provide a revised certification only, the revised certification must be accompanied with a letter of explanation to the satisfaction of the Resident Engineer. The explanation shall indicate the basis for using the revised certification rather than the original supplied. The letter shall also include corrective action to assure that future certifications will be representative of the material or product supplied. The letter must be signed by a company representative that can legally bind the firm.

If the Contractor proposes to use foreign steel/iron in small amounts under the threshold, the amount allowed will be based on the material price to the Contractor, as verified by invoice and approved by the Resident Engineer. The amount is cumulative for the entire contract, so subsequent requests will have to be added to any previous requests before comparison to the allowable threshold.

The "Buy America" contract specification does not apply to iron or steel that is to be used for temporary means which will be removed during or at the end of the project.

### DEFINITIONS:

**Steel** - Steel material of any type, including welding rod.

**Iron** - Iron material of any type, including cast and ductile iron, but not pig iron.

**Domestic** - The 50 States, the District of Columbia, Puerto Rico and territories/possessions of the US.

**Foreign** - Any location other than those defined as Domestic.

**Manufacturing Processes** - Steel and/or iron manufacturing processes must be domestic; e.g. manufacture, fabrication, grinding, drilling, welding, finishing and coating of steel. Ore, scrap, and pig iron may be foreign or domestic; however, transformation into steel and/or iron and all subsequent processes and fabrication must be domestic. The fabrication of composite items using domestic steel (e.g. casting reinforced concrete box culvert using reinforcing cut and bent to final shapes) is not considered a manufacturing process, and the composite item is acceptable.

**Fabricated Product Containing Steel and/or Iron** - Items, products or materials containing any amount of steel and/or iron materials; e.g., a metal pipe may be steel or iron, a reinforced concrete pipe contains steel, a prestressed beam contains steel, iron castings are iron, a steel beam is steel and steel laminated bridge bearings contain steel.

**EQUAL EMPLOYMENT OPPORTUNITY REQUIREMENTS**

The Department seeks to ensure nondiscrimination in employment under all Department contracts. The Contractor shall comply with the following Equal Employment Opportunity (EEO) requirements. *Goals for Equal Opportunity Employment Participation* are listed in the required contract provisions section of the contract proposal. The covered area is the county or counties in which the work is located.

For Federal-Aid contracts, Equal Employment Opportunity provisions are also found in Attachment "A" - *Required Contract Provisions Federal-Aid Construction Contracts – FHWA 1273*.

Nothing herein provided shall be construed as a limitation upon the application of other laws which establish different standards of compliance or upon the application of requirements for the hiring of local or other area residents (e.g., those under the Public Works Employment Act of 1977 and the Community Development Block Grant Program).

**A. Statutory Authority.** The Federal statutory authority for Equal Employment Opportunity provisions is contained in 23 U.S.C. 140(a), and Executive Order 11246. State statutory authority is contained in Section 85 of the Highway Law, Section 428 of the Transportation Law, and NYS Executive Law Articles 15 and 15-A. Regulations have been promulgated under 23 CFR 230, 41 CFR 60, 49 CFR 21, and 5 NYCRR 140-145.

**B. Definitions.**

For Federal-Aid contracts, a minority group member is defined under this subsection as someone who is, and can demonstrate membership in, one of the following groups:

- a. Black (all persons having origins in any of the Black African racial groups not of Hispanic origin);
- b. Hispanic (all persons of Mexican, Puerto Rican, Cuban, Central or South American or other Spanish Culture or origin, regardless of race);
- c. Asian and Pacific Islander (all persons having origins in any of the original peoples of the Far East, Southeast Asia, the Indian Subcontinent, or the Pacific Islands); and
- d. American Indian or Alaskan Native (all persons having origins in any of the original peoples of North America and maintaining identifiable tribal affiliations through membership and participation or community identification).

**C. Employment Goals.** An employment goal(s) for minorities and a separate goal for women are presented in the contract documents. The Contractor shall provide equal employment opportunity and shall take affirmative action for all minority groups, both male and female; and women, both minority and non-minority. If the Contractor performs work outside of the covered area, it shall apply the goals established for the county where the work is actually performed. The Department will monitor the Contractor's attainments towards EEO goals in accordance with Attachment H - *Civil Rights Monitoring and Reporting*.

The goals set for the contract are expressed as percentages of the total hours of employment and training of minority and female utilization the Contractor should reasonably be able to achieve in each construction trade in which it has employees in the covered area. The Contractor is expected to make substantially uniform progress in meeting its goals in each trade. The hours of minority and female employment and training shall be substantially uniform

## ATTACHMENT "F"

throughout the length of the contract, and in each trade, and the Contractor shall make a good faith effort to employ minorities and women evenly on each of its contracts. The transfer of minority or female employees, apprentices, or trainees from contractor to contractor or from contract to contract for the sole purpose of meeting the Contractor's goals is a violation of the contract.

**D. Contractor Obligations.** The Contractor shall comply with all provisions of Federal Executive Order 11246 and the provisions of State and Federal laws and regulations. The Contractor shall furnish all information and reports required by Executive Order 11246 and by rules, regulations, and orders of the Secretary of Labor, or pursuant thereto, and will permit access to its books, records, and accounts by the Department and the U.S. Secretary of Labor for purposes of investigation to ascertain compliance with such rules, regulations, and orders. The Contractor shall develop and implement an EEO policy in accordance with Attachment A, *Required Contract Provisions Federal-Aid Construction Contracts – FHWA 1273* and in accordance with Attachment B, *Standard Clauses for All New York State Contracts*.

**1. Non-Discrimination.** The Contractor shall not discriminate against any employee or applicant for employment because of race, color, religion, sex, national origin, age, disability or marital status. The Contractor shall take affirmative action to ensure that applicants are employed, and that employees are treated during employment, without regard to their age, race, creed, color, national origin, sexual orientation, military status, sex, disability, predisposing genetic characteristics, marital status, or domestic violence victim status and shall also follow the requirements of the Human Rights Law with regard to non-discrimination on the basis of prior criminal conviction and prior arrest. Such actions shall include, but not be limited to the following: employment, upgrading, demotion, or transfer; recruitment or recruitment advertising; layoff or termination; rates of pay or other forms of compensation; and selection for training, including apprenticeship. The Contractor shall post in conspicuous places, available to employees and applicants for employment, notices to be provided by the Department setting forth the provisions of this non-discrimination clause.

The Contractor shall state in all solicitations or advertisements for employees that, in the performance of the contract, all qualified applicants will be afforded equal employment opportunities without discrimination because of age, race, creed, color, national origin, sexual orientation, military status, sex, disability, predisposing genetic characteristics, marital status, or domestic violence victim status.

The Contractor shall not use the goals or affirmative action requirements to discriminate against any person because of age, race, creed, color, national origin, sexual orientation, military status, sex, disability, predisposing genetic characteristics, marital status, or domestic violence victim status.

**2. Solicitations.** The Contractor shall state in all solicitations or advertisements for employees placed by or on behalf of the Contractor, that all qualified applicants will receive consideration for employment without regard to race, color, religion, sex, national origin, age, disability or marital status.

**3. Collective Bargaining Agreements.** The contractor shall send to each labor union or representative of workers with which it has a collective bargaining agreement or other contract or understanding, a notice to be provided advising the said labor union or workers' representatives of the contractor's commitments to equal employment opportunities, and shall post copies of the notice in conspicuous places available to employees and applicants for employment.

## ATTACHMENT "F"

The Contractor shall request each employment agency, labor union, or authorized representative of workers with which it has a collective bargaining or other agreement or understanding, to furnish a written statement that such employment agency, labor union, or representative will not discriminate on the basis of race, creed, color, national origin, sex, age, disability or marital status and that such union or representative will affirmatively cooperate in the implementation of the Contractor's obligations herein.

Neither the provisions of any collective bargaining agreement, nor the failure by a union with whom the Contractor has a collective bargaining agreement, to refer either minorities or women shall excuse the Contractor's obligations.

**4. Complaints of Alleged Discrimination.** The Contractor shall promptly investigate all complaints of alleged discrimination made to the Contractor in connection with its obligations under this contract, shall attempt to resolve such complaints, and shall take appropriate corrective action within a reasonable time. If the investigation indicates that the discrimination may affect persons other than the complainant, corrective action shall include such other persons. Upon completion of each investigation, the Contractor shall inform every complainant of all available avenues of appeal.

**5. Non-Compliance.** In the event of the contractor's non-compliance with the nondiscrimination clauses of this contract or with any of such rules, regulations, or orders, this contract may be canceled, terminated or suspended in whole or in part and the contractor may be declared ineligible for further contracts in accordance with procedures authorized in Executive Order 11246, and such other sanctions may be imposed and remedies invoked as provided in Executive Order 11246, or by rule, regulation, or order of the U.S. Secretary of Labor, or as otherwise provided by law.

**6. Subcontracts/Purchase Orders.** The Contractor shall include the provisions of Subsection D, *Contractor Obligations*, of this Attachment F, in every subcontract or purchase order, so that such provisions will be binding upon each subcontractor or vendor. In the event a Contractor becomes involved in, or is threatened with, litigation with a subcontractor or vendor as a result of such direction by the Department, the Contractor may request the United States to enter into such litigation to protect the interests of the United States.

**E. Affirmative Action Steps.** The Contractor shall take specific affirmative actions to promote equal employment opportunity. The evaluation of the Contractor's compliance with these specifications shall be based upon its effort to achieve maximum results from its actions. The Contractor shall document these efforts fully, and shall implement affirmative action steps at least as extensive as the following:

1. Ensure and maintain a working environment free of harassment, intimidation, and coercion at all sites, and in all facilities at which the Contractor's employees are assigned to work. The Contractor, where possible, shall assign two or more women to each construction contract. The Contractor shall specifically ensure that all forepersons, superintendents, and other onsite supervisory personnel are aware of and carry out the Contractor's obligation to maintain such a working environment, with specific attention to minority or female individuals working at such sites or in such facilities.

2. Establish and maintain a current list of minority and female recruitment sources, provide written notification to minority and female recruitment sources and to community organizations when the Contractor or its unions have employment opportunities available, and maintain a record of the organizations' responses.

## **ATTACHMENT "F"**

- 3.** Maintain a current file of the names, addresses and telephone numbers of each minority and female off-the-street applicant and minority or female referral from a union, a recruitment source or community organization and of what action was taken with respect to each such individual. If such individual was sent to the union hiring hall for referral and was not referred back to the Contractor by the union or, if referred, not employed by the Contractor, this shall be documented in the file with the reason therefore, along with whatever additional actions the Contractor may have taken.
- 4.** Provide immediate written notification to the Department when the union or unions with which the Contractor has a collective bargaining agreement has not referred to the Contractor a minority person or woman sent by the Contractor, or when the Contractor has other information that the union referral process has impeded the Contractor's efforts to meet its obligations.
- 5.** Develop on-the-job training opportunities and/or participate in training programs for the area which expressly include minorities and women, including upgrading programs and apprenticeship and trainee programs relevant to the Contractor's employment needs, especially those programs funded or approved by either the NYS Department of Labor or the US Department of Labor. The Contractor shall provide notice of these programs to the sources compiled under E.2. above.
- 6.** Disseminate the Contractor's EEO policy by providing notice of the policy to unions and training programs and requesting their cooperation in assisting the Contractor in meeting its EEO obligations; by including it in any policy manual and collective bargaining agreement; by publicizing it in the company newspaper, annual report, etc.; by specific review of the policy with all management personnel and with all employees at least once a year; and by posting the company EEO policy on bulletin boards accessible to all employees at each location where construction work is performed.
- 7.** Review, at least annually, the company's EEO policy and affirmative action obligations under these specifications with all employees having any responsibility for hiring, assignment, layoff, termination or other employment decisions including specific review of these items with onsite supervisory personnel such as superintendents, forepersons, etc., prior to the initiation of construction work at any contract site. A written record shall be made and maintained identifying the time and place of these meetings, persons attending, subject matter discussed, and disposition of the subject matter.
- 8.** Disseminate the Contractor's EEO policy externally by including it in any advertising in the news media, specifically including minority and female news media, and providing written notification to and discussing the Contractor's EEO policy with other contractors and Subcontractors with whom the Contractor does or anticipates doing business.
- 9.** Direct its recruitment efforts, both oral and written, to minority, female and community organizations, to schools with minority and female students and to minority and female recruitment and training organizations serving the Contractor's recruitment area and employment needs. Not later than one month prior to the date for the acceptance of applications for apprenticeship or other training by any recruitment source, the Contractor shall send written notification to organizations such as the above, describing the openings, screening procedures, and tests to be used in the selection process.
- 10.** Encourage present minority and female employees to recruit other minority persons and women and, where reasonable, provide after school, summer and vacation employment to minority and female youth both on the site and in other areas of the Contractor's work force.

## ATTACHMENT "F"

11. Validate all tests and other selection requirements in accordance with state and Federal laws, rules and regulations.
12. Conduct, at least annually, an inventory and evaluation of all minority and female personnel for promotional opportunities. Encourage these employees to seek or to prepare for promotional opportunities through appropriate training, etc.
13. Ensure that seniority practices, labor classifications, work assignments and other personnel practices, do not have a discriminatory effect by continually monitoring all personnel and employment related activities to ensure that the EEO policy and the Contractor's obligations under these specifications are being carried out.
14. Ensure that all facilities and company activities are non-segregated except that separate or single-user toilet and necessary changing facilities shall be provided to assure privacy between the sexes.
15. Document and maintain a record of all solicitations of offers for Subcontracts from minority and female construction contractors and suppliers, including circulation of solicitations to minority and female contractor associations and other business associations.
16. Conduct a review, at least annually, of all supervisors' adherence to and performance under the Contractor's EEO policies and affirmative action obligations.

**F. Associations.** Contractors are encouraged to participate in voluntary associations which assist in fulfilling one or more of their affirmative action obligations. The efforts of a contractor association, joint contractor-union, contractor-community, or other similar group of which the Contractor is a member and participant, may be asserted as fulfilling one or more of its obligations, provided that the Contractor actively participates in the group, makes every effort to ensure that the group has a positive impact on the employment of minorities and women in the industry, ensures that the benefits of the program are reflected in the Contractor's minority and female workforce participation, makes a good faith effort to meet its individual goals and timetables, and can provide access to documentation which demonstrates the effectiveness of actions taken on behalf of the Contractor. The obligation to comply, however, is the Contractor's and failure of such a group to fulfill an obligation shall not be a defense for the Contractor's noncompliance.

**G. Hometown Plans (Federal-Aid Contracts Only).** If a Contractor is participating (pursuant to 41 CFR 60-4.5) in a Hometown Plan approved by the USDOL in the covered area either individually or through an association, its affirmative action obligations on all work in the Plan area (including goals and timetables) shall be in accordance with that Plan for those trades which have unions participating in the Plan. Contractors participating in Hometown Plans shall be able to demonstrate their participation and document their compliance with the provision of the Hometown Plan. Each Contractor participating in an approved plan is individually required to comply with its obligation under the EEO clause and to make a good faith effort to achieve each goal under the plan in each trade in which it has employees. The overall good faith performance by other Contractors toward a goal in an approved plan does not excuse any covered Contractor's failure to take good faith efforts to achieve the Plan goals and timetables.



**ATTACHMENT "F"**

**Notice of Requirement for Affirmative Action To Ensure Equal Employment Opportunity (Executive Order 11246)**

1. The Offeror's or Bidder's attention is called to the "Equal Opportunity Clause" and the "Standard Federal Equal Employment Specifications" set forth herein.
2. The goals and timetables for minority and female participation, expressed in percentage terms for the Contractor's aggregate workforce in each trade on all construction work in the covered area, are as follows:

Goals for minority participation and female participation are in the "Goals for Equal Employment Opportunity (EEO) Participation" section at the end of this Attachment "F".

These goals are applicable to all the Contractor's construction work (whether or not it is Federal or federally assisted) performed in the covered area. If the contractor performs construction work in a geographical area located outside of the covered area, it shall apply the goals established for such geographical area where the work is actually performed. With regard to this second area, the contractor also is subject to the goals for both its federally involved and nonfederally involved construction.

The Contractor's compliance with the Executive Order and the regulations in 41 CFR Part 60-4 shall be based on its implementation of the Equal Opportunity Clause, specific affirmative action obligations required by the specifications set forth in 41 CFR 60-4.3(a), and its efforts to meet the goals. The hours of minority and female employment and training must be substantially uniform throughout the length of the contract, and in each trade, and the contractor shall make a good faith effort to employ minorities and women evenly on each of its projects. The transfer of minority or female employees or trainees from Contractor to Contractor or from project to project for the sole purpose of meeting the Contractor's goals shall be a violation of the contract, the Executive Order and the regulations in 41 CFR Part 60-4. Compliance with the goals will be measured against the total work hours performed.

3. The Contractor shall provide written notification to the Director of the Office of Federal Contract Compliance Programs within 10 working days of award of any construction subcontract in excess of \$10,000 at any tier for construction work under the contract resulting from this solicitation. The notification shall list the name, address and telephone number of the subcontractor; employer identification number of the subcontractor; estimated dollar amount of the subcontract; estimated starting and completion dates of the subcontract; and the geographical area in which the subcontract is to be performed.

4. As used in this Notice, and in the contract resulting from this solicitation, the "covered area" is the five Boroughs of New York City.

**Standard Federal Equal Employment Opportunity Construction Contract  
Specifications (Executive Order 11246)**

**1. As used in these specifications:**

- a. "Covered area" means the geographical area described in the solicitation from which this contract resulted;
- b. "Director" means Director, Office of Federal Contract Compliance Programs, United States Department of Labor, or any person to whom the Director delegates authority;
- c. "Employer identification number" means the Federal Social Security number used on the Employer's Quarterly Federal Tax Return, U.S. Treasury Department Form 941.
- d. "Minority" includes:
  - (i) Black (all persons having origins in any of the Black African racial groups not of Hispanic origin);
  - (ii) Hispanic (all persons of Mexican, Puerto Rican, Cuban, Central or South American or other Spanish Culture or origin, regardless of race);
  - (iii) Asian and Pacific Islander (all persons having origins in any of the original peoples of the Far East, Southeast Asia, the Indian Subcontinent, or the Pacific Islands); and
  - (iv) American Indian or Alaskan Native (all persons having origins in any of the original peoples of North America and maintaining identifiable tribal affiliations through membership and participation or community identification).

**2.** Whenever the Contractor, or any Subcontractor at any tier, subcontracts a portion of the work involving any construction trade, it shall physically include in each subcontract in excess of \$10,000 the provisions of these specifications and the Notice which contains the applicable goals for minority and female participation and which is set forth in the solicitations from which this contract resulted.

**3.** If the Contractor is participating (pursuant to 41 CFR 60-4.5) in a Hometown Plan approved by the U.S. Department of Labor in the covered area either individually or through an association, its affirmative action obligations on all work in the Plan area (including goals and timetables) shall be in accordance with that Plan for those trades which have unions participating in the Plan. Contractors must be able to demonstrate their participation in and compliance with the provisions of any such Hometown Plan. Each Contractor or Subcontractor participating in an approved Plan is individually required to comply with its obligations under the EEO clause, and to make a good faith effort to achieve each goal under the Plan in each trade in which it has employees. The overall good faith performance by other Contractors or Subcontractors toward a goal in an approved Plan does not excuse any covered Contractor's or Subcontractor's failure to take good faith efforts to achieve the Plan goals and timetables.

**4.** The Contractor shall implement the specific affirmative action standards provided in paragraphs 7 a through p of these specifications. The goals set forth in the solicitation from which this contract resulted are expressed as percentages of the total hours of employment and training of minority and

## **ATTACHMENT "F"**

female utilization the Contractor should reasonably be able to achieve in each construction trade in which it has employees in the covered area. Covered Construction contractors performing construction work in geographical areas where they do not have a Federal or federally assisted construction contract shall apply the minority and female goals established for the geographical area where the work is being performed. Goals are published periodically in the Federal Register in notice form, and such notices may be obtained from any Office of Federal Contract Compliance Programs office or from Federal procurement contracting officers. The Contractor is expected to make substantially uniform progress in meeting its goals in each craft during the period specified.

5. Neither the provisions of any collective bargaining agreement, nor the failure by a union with whom the Contractor has a collective bargaining agreement, to refer either minorities or women shall excuse the Contractor's obligations under these specifications, Executive Order 11246, or the regulations promulgated pursuant thereto.

6. In order for the nonworking training hours of apprentices and trainees to be counted in meeting the goals, such apprentices and trainees must be employed by the Contractor during the training period, and the Contractor must have made a commitment to employ the apprentices and trainees at the completion of their training, subject to the availability of employment opportunities. Trainees must be trained pursuant to training programs approved by the U.S. Department of Labor.

7. The Contractor shall take specific affirmative actions to ensure equal employment opportunity. The evaluation of the Contractor's compliance with these specifications shall be based upon its effort to achieve maximum results from its actions. The Contractor shall document these efforts fully, and shall implement affirmative action steps at least as extensive as the following:

a. Ensure and maintain a working environment free of harassment, intimidation, and coercion at all sites, and in all facilities at which the Contractor's employees are assigned to work. The Contractor, where possible, will assign two or more women to each construction project. The Contractor shall specifically ensure that all foremen, superintendents, and other on-site supervisory personnel are aware of and carry out the Contractor's obligation to maintain such a working environment, with specific attention to minority or female individuals working at such sites or in such facilities.

b. Establish and maintain a current list of minority and female recruitment sources, provide written notification to minority and female recruitment sources and to community organizations when the Contractor or its unions have employment opportunities available, and maintain a record of the organizations' responses.

c. Maintain a current file of the names, addresses and telephone numbers of each minority and female off-the-street applicant and minority or female referral from a union, a recruitment source or community organization and of what action was taken with respect to each such individual. If such individual was sent to the union hiring hall for referral and was not referred back to the Contractor by the union or, if referred, not employed by the Contractor, this shall be documented in the file with the reason therefor, along with whatever additional actions the Contractor may have taken.

d. Provide immediate written notification to the Director when the union or unions with which the Contractor has a collective bargaining agreement has not referred to the Contractor a

## **ATTACHMENT "F"**

minority person or woman sent by the Contractor, or when the Contractor has other information that the union referral process has impeded the Contractor's efforts to meet its obligations.

e. Develop on-the-job training opportunities and/or participate in training programs for the area which expressly include minorities and women, including upgrading programs and apprenticeship and trainee programs relevant to the Contractor's employment needs, especially those programs funded or approved by the Department of Labor. The Contractor shall provide notice of these programs to the sources compiled under 7b above.

f. Disseminate the Contractor's EEO policy by providing notice of the policy to unions and training programs and requesting their cooperation in assisting the Contractor in meeting its EEO obligations; by including it in any policy manual and collective bargaining agreement; by publicizing it in the company newspaper, annual report, etc.; by specific review of the policy with all management personnel and with all minority and female employees at least once a year; and by posting the company EEO policy on bulletin boards accessible to all employees at each location where construction work is performed.

g. Review, at least annually, the company's EEO policy and affirmative action obligations under these specifications with all employees having any responsibility for hiring, assignment, layoff, termination or other employment decisions including specific review of these items with onsite supervisory personnel such as Superintendents, General Foremen, etc., prior to the initiation of construction work at any job site. A written record shall be made and maintained identifying the time and place of these meetings, persons attending, subject matter discussed, and disposition of the subject matter.

h. Disseminate the Contractor's EEO policy externally by including it in any advertising in the news media, specifically including minority and female news media, and providing written notification to and discussing the Contractor's EEO policy with other Contractors and Subcontractors with whom the Contractor does or anticipates doing business.

i. Direct its recruitment efforts, both oral and written, to minority, female and community organizations, to schools with minority and female students and to minority and female recruitment and training organizations serving the Contractor's recruitment area and employment needs. Not later than one month prior to the date for the acceptance of applications for apprenticeship or other training by any recruitment source, the Contractor shall send written notification to organizations such as the above, describing the openings, screening procedures, and tests to be used in the selection process.

j. Encourage present minority and female employees to recruit other minority persons and women and, where reasonable, provide after school, summer and vacation employment to minority and female youth both on the site and in other areas of a Contractor's work force.

k. Validate all tests and other selection requirements where there is an obligation to do so under 41 CFR Part 60-3.

l. Conduct, at least annually, an inventory and evaluation at least of all minority and female personnel for promotional opportunities and encourage these employees to seek or to prepare for, through appropriate training, etc., such opportunities.

## **ATTACHMENT "F"**

m. Ensure that seniority practices, job classifications, work assignments and other personnel practices, do not have a discriminatory effect by continually monitoring all personnel and employment related activities to ensure that the EEO policy and the Contractor's obligations under these specifications are being carried out.

n. Ensure that all facilities and company activities are nonsegregated except that separate or single-user toilet and necessary changing facilities shall be provided to assure privacy between the sexes.

o. Document and maintain a record of all solicitations of offers for subcontracts from minority and female construction contractors and suppliers, including circulation of solicitations to minority and female contractor associations and other business associations.

p. Conduct a review, at least annually, of all supervisors' adherence to and performance under the Contractor's EEO policies and affirmative action obligations.

**8.** Contractors are encouraged to participate in voluntary associations which assist in fulfilling one or more of their affirmative action obligations (7a through p). The efforts of a contractor association, joint contractor-union, contractor-community, or other similar group of which the contractor is a member and participant, may be asserted as fulfilling any one or more of its obligations under 7a through p of these Specifications provided that the contractor actively participates in the group, makes every effort to assure that the group has a positive impact on the employment of minorities and women in the industry, ensures that the concrete benefits of the program are reflected in the Contractor's minority and female workforce participation, makes a good faith effort to meet its individual goals and timetables, and can provide access to documentation which demonstrates the effectiveness of actions taken on behalf of the Contractor. The obligation to comply, however, is the Contractor's and failure of such a group to fulfill an obligation shall not be a defense for the Contractor's noncompliance.

**9.** A single goal for minorities and a separate single goal for women have been established. The Contractor, however, is required to provide equal employment opportunity and to take affirmative action for all minority groups, both male and female, and all women, both minority and non-minority. Consequently, the Contractor may be in violation of the Executive Order if a particular group is employed in a substantially disparate manner (for example, even though the Contractor has achieved its goals for women generally, the Contractor may be in violation of the Executive Order if a specific minority group of women is underutilized).

**10.** The Contractor shall not use the goals and timetables or affirmative action standards to discriminate against any person because of race, color, religion, sex, sexual orientation, gender identity, or national origin.

**11.** The Contractor shall not enter into any Subcontract with any person or firm debarred from Government contracts pursuant to Executive Order 11246.

**12.** The Contractor shall carry out such sanctions and penalties for violation of these specifications and of the Equal Opportunity Clause, including suspension, termination and cancellation of existing subcontracts as may be imposed or ordered pursuant to Executive Order 11246, as amended, and its implementing regulations, by the Office of Federal Contract Compliance Programs. Any

## **ATTACHMENT "F"**

Contractor who fails to carry out such sanctions and penalties shall be in violation of these specifications and Executive Order 11246, as amended.

**13.** The Contractor, in fulfilling its obligations under these specifications, shall implement specific affirmative action steps, at least as extensive as those standards prescribed in paragraph 7 of these specifications, so as to achieve maximum results from its efforts to ensure equal employment opportunity. If the Contractor fails to comply with the requirements of the Executive Order, the implementing regulations, or these specifications, the Director shall proceed in accordance with 41 CFR 60-4.8.

**14.** The Contractor shall designate a responsible official to monitor all employment related activity to ensure that the company EEO policy is being carried out, to submit reports relating to the provisions hereof as may be required by the Government and to keep records. Records shall at least include for each employee the name, address, telephone numbers, construction trade, union affiliation if any, employee identification number when assigned, social security number, race, sex, status (e.g., mechanic, apprentice trainee, helper, or laborer), dates of changes in status, hours worked per week in the indicated trade, rate of pay, and locations at which the work was performed. Records shall be maintained in an easily understandable and retrievable form; however, to the degree that existing records satisfy this requirement, contractors shall not be required to maintain separate records.

**15.** Nothing herein provided shall be construed as a limitation upon the application of other laws which establish different standards of compliance or upon the application of requirements for the hiring of local or other area residents (e.g., those under the Public Works Employment Act of 1977 and the Community Development Block Grant Program).

**GOALS FOR EQUAL EMPLOYMENT OPPORTUNITY (EEO) PARTICIPATION**

**GOALS FOR MINORITY PARTICIPATION**

<b>COUNTY</b>	<b>%</b>	<b>COUNTY</b>	<b>%</b>	<b>COUNTY</b>	<b>%</b>
Albany .....	3.2	Herkimer .....	2.1	* Richmond	
Allegany .....	6.3	Jefferson .....	2.5	Rockland .....	22.6
Broome .....	1.1	* Kings		St. Lawrence .....	2.5
* Bronx		Lewis .....	2.5	Saratoga .....	3.2
Cattaraugus.....	6.3	Livingston .....	5.3	Schenectady .....	3.2
Cayuga .....	2.5	Madison .....	3.8	Schoharie.....	2.6
Chautauqua .....	6.3	Monroe .....	5.3	Schuyler.....	1.2
Chemung .....	2.2	Montgomery .....	3.2	Seneca.....	5.9
Chenango .....	1.2	Nassau .....	5.8	Steuben .....	1.2
Clinton.....	2.6	* New York		Suffolk.....	5.8
Columbia .....	2.6	Niagara .....	7.7	Sullivan .....	17.0
Cortland .....	2.5	Oneida .....	2.1	Tioga.....	1.1
Delaware .....	1.2	Onondaga .....	3.8	Tompkins .....	1.2
Dutchess .....	6.4	Ontario .....	5.3	Ulster .....	17.0
Erie .....	7.7	Orange .....	17.0	Warren.....	2.6
Essex .....	2.6	Orleans .....	5.3	Washington.....	2.6
Franklin .....	2.5	Oswego .....	3.8	Wayne.....	5.3
Fulton .....	2.6	Otsego .....	1.2	Westchester.....	22.6
Genesee .....	5.9	Putnam .....	22.6	Wyoming.....	6.3
Greene .....	2.6	* Queens		Yates.....	5.9
Hamilton .....	2.6	Rensselaer .....	3.2		

\* The following goal ranges are applicable to the indicated trades in the Counties of Bronx, Kings, New York, Queens and Richmond:

Electricians.....	9.0 to 10.2	Asbestos workers .....	22.8 to 28.0
Carpenters .....	27.6 to 32.0	Roofers.....	6.3 to 7.5
Steam fitters .....	12.2 to 13.5	Iron Workers (ornamental).....	22.4 to 23.0
Metal lathers.....	24.6 to 25.6	Cement masons .....	23.0 to 27.0
Painters.....	26.0 to 28.6	Glaziers .....	16.0 to 20.0
Operating engineers.....	25.6 to 26.0	Plasterers .....	15.8 to 18.0
Plumbers .....	12.0 to 14.5	Teamsters .....	22.0 to 22.5
Iron Workers (structural).....	25.9 to 32.0	Boilermakers .....	13.0 to 15.5
Elevator constructors .....	5.5 to 6.5	All others .....	16.4 to 17.5
Bricklayers.....	13.4 to 15.5		

**GOAL FOR PARTICIPATION OF WOMEN**

The last publication of a goal for the participation of women was April 7, 1978 (43 FR 14888, 14900). Pursuant to 41CFR 60-4.6, the 6.9% goal published on that date is hereby made the goal for all contracts and grant agreements, until further notice.

**(No Further Text This Page)**

**STANDARDIZED CHANGED CONDITIONS CLAUSES**

**FHWA CHANGED CONDITION CLAUSES (23CFR635.109)**

*(1) Differing site conditions.*

(i) During the progress of the work, if subsurface or latent physical conditions are encountered at the site differing materially from those indicated in the contract or if unknown physical conditions of an unusual nature, differing materially from those ordinarily encountered and generally recognized as inherent in the work provided for in the contract, are encountered at the site, the party discovering such conditions shall promptly notify the other party in writing of the specific differing conditions before the site is disturbed and before the affected work is performed.

(ii) Upon written notification, the engineer will investigate the conditions, and if it is determined that the conditions materially differ and cause an increase or decrease in the cost or time required for the performance of any work under the contract, an adjustment, excluding anticipated profits, will be made and the contract modified in writing accordingly. The engineer will notify the contractor of the determination whether or not an adjustment of the contract is warranted.

(iii) No contract adjustment which results in a benefit to the contractor will be allowed unless the contractor has provided the required written notice.

(iv) No contract adjustment will be allowed under this clause for any effects caused on unchanged work.

*(2) Suspensions of work ordered by the engineer.*

(i) If the performance of all or any portion of the work is suspended or delayed by the engineer in writing for an unreasonable period of time (not originally anticipated, customary, or inherent to the construction industry) and the contractor believes that additional compensation and/or contract time is due as a result of such suspension or delay, the contractor shall submit to the engineer in writing a request for adjustment within 7 calendar days of receipt of the notice to resume work. The request shall set forth the reasons and support for such adjustment.

(ii) Upon receipt, the engineer will evaluate the contractor's request. If the engineer agrees that the cost and/or time required for the performance of the contract has increased as a result of such suspension and the suspension was caused by conditions beyond the control of and not the fault of the contractor, its suppliers, or subcontractors at any approved tier, and not caused by weather, the engineer will make an adjustment (excluding profit) and modify the contract in writing accordingly. The contractor will be notified of the engineer's determination whether or not an adjustment of the contract is warranted.

(iii) No contract adjustment will be allowed unless the contractor has submitted the request for adjustment within the time prescribed.

(iv) No contract adjustment will be allowed under this clause to the extent that performance would have been suspended or delayed by any other cause, or for which an adjustment is provided or excluded under any other term or condition of this contract.

*(3) Significant changes in the character of work.*

(i) The engineer reserves the right to make, in writing, at any time during the work, such changes in quantities and such alterations in the work as are necessary to satisfactorily complete



## **ATTACHMENT "G"**

the project. Such changes in quantities and alterations shall not invalidate the contract nor release the surety, and the contractor agrees to perform the work as altered.

(ii) If the alterations or changes in quantities significantly change the character of the work under the contract, whether such alterations or changes are in themselves significant changes to the character of the work or by affecting other work cause such other work to become significantly different in character, an adjustment, excluding anticipated profit, will be made to the contract. The basis for the adjustment shall be agreed upon prior to the performance of the work. If a basis cannot be agreed upon, then an adjustment will be made either for or against the contractor in such amount as the engineer may determine to be fair and equitable.

(iii) If the alterations or changes in quantities do not significantly change the character of the work to be performed under the contract, the altered work will be paid for as provided elsewhere in the contract.

(iv) The term "significant change" shall be construed to apply only to the following circumstances:

(A) When the character of the work as altered differs materially in kind or nature from that involved or included in the original proposed construction; or

(B) When a major item of work, as defined elsewhere in the contract, is increased in excess of 125 percent or decreased below 75 percent of the original contract quantity. Any allowance for an increase in quantity shall apply only to that portion in excess of 125 percent of original contract item quantity, or in case of a decrease below 75 percent, to the actual amount of work performed.

### **MAJOR ITEM OF WORKS**

The term "major item" of work shall mean any item for which the original bid price multiplied by the original contract quantity exceeds \$50,000 or 2% of the total contract bid price, whichever is less.

**CIVIL RIGHTS MONITORING AND REPORTING**

The approved civil rights reporting software is *Equitable Business Opportunity Solution* (EBO). The EBO software is a web-based system owned and maintained by the New York State Department of Transportation, and provided to the Contractor at no cost. The Contractor shall use the approved civil rights reporting software on all contracts. The Contractor shall submit complete, accurate, electronic data to the Department for each month, not later than the 15th of the following month, using the approved civil rights reporting software. Data shall be current through the end of the last full payroll week for that month, or as otherwise approved by the Engineer to coordinate with contract payment submittals.

**A. Civil Rights Officer(s).** The Contractor shall designate a Corporate Civil Rights Officer, a Corporate DBE Representative, and a contract site Equal Employment Opportunity (EEO) Representative; and each Subcontractor shall designate a Corporate Civil Rights Officer, and a contract site Equal Employment Opportunity (EEO) Representative in the approved civil rights reporting software. The designated individuals shall have the responsibility to and shall be capable of effectively administering and promoting an active program of equal employment opportunity and who shall be assigned adequate authority and responsibility to do so. A single individual may fulfill multiple roles. The Contractor shall update the approved civil rights reporting software within 10 calendar days of any changes in these roles.

**B. Workforce Participation Plan.** At the pre-construction meeting, the Contractor shall submit a *Workforce Participation Plan* covering the Contractor's workforce and the workforce of its Subcontractors with subcontracts over \$10,000, together and coordinated with the contract progress schedule that addresses the Equal Employment Opportunity goals.

The Contractor shall not start work until the Department and the Contractor have agreed upon has accepted the *Workforce Participation Plan*. The Contractor shall submit a revised plan when a significant work force build-up or reduction will substantially affect goal attainment, or when a revised schedule is requested by the Department. Such revised *Workforce Participation Plan* must be agreed upon by the Department or the original will remain in effect.

**C. Equal Employment Opportunity (EEO) Monitoring and Reporting.** The Contractor's compliance with the EEO Requirements will be based on its Employment Utilization, affirmative action steps and its good faith efforts to meet the goals.

The Department, in evaluating the Contractor's good faith efforts to meet the EEO goal(s), will first analyze the Contractor's goal attainment on an individual contract. If the Contractor is not meeting the goal(s) for a single trade or contract, the Department will analyze, progressively, the Contractor's goal attainment on all contracts held by the Contractor. This method of analysis shall be applied primarily but not solely to contracts with small population numbers. Other factors to be considered include, but are not limited to; the location of the contracts, the relative proximity of the contracts to each other, and the nature of the work.

**1. Employee Utilization Data.** The Contractor shall submit employee utilization data for its workforce and for each Subcontractor with a subcontract exceeding \$10,000 on a monthly basis showing hours worked for each payroll week, for each trade and classification, by gender and ethnicity. Employee utilization data shall include data from

## ATTACHMENT "H"

the start of the contract up to and including the month being reported. For the purpose of determining utilization percentages, the hours of female and minority employment shall be tabulated separately and attainment percentages calculated separately.

**2. Federal-Aid Highway Construction Contractors Annual EEO Report.** The Contractor shall submit all required employee utilization data to produce a Form FHWA 1391 *Federal-Aid Highway Construction Contractors Annual EEO Report* to the Department annually not later than August 15<sup>th</sup>, covering the last payroll period worked in July, for all ongoing Federal-Aid contracts. The data shall indicate the number of minority men, minority women, non-minority men, and non-minority women employees currently engaged in each trade.

**3. Subcontractor Sanctions.** *The Contractor shall carry out such sanctions and penalties for violation of Attachment F - Equal Employment Opportunity Requirements, including suspension, termination and cancellation of existing subcontracts as may be imposed or ordered pursuant to Executive Order 11246, and its implementing regulations, by the Office of Federal Contract Compliance Programs. Any Contractor who fails to carry out such sanctions and penalties shall be in violation of these specifications and Executive Order 11246.*

**4. Contractor Compliance.** If the Contractor fails to meet the EEO goal(s) for minorities or women, the Department may require training of minorities and women to satisfy the employment goals. If the Contractor fails to meet the EEO goal(s) or is in noncompliance with the nondiscrimination clauses, the Department may determine that one of the following actions should be taken:

- a. *entering into an agreement with the Contractor allowing the Contractor to cure the violation;*
- b. *revoking the Contractor's pre-qualification to bid or make proposals for future contracts;*
- c. *making a finding that the Contractor is in default of the Contract;*
- d. *terminating the Contract;*
- e. *declaring the Contractor to be in breach of Contract;*
- f. *withholding payment or reimbursement;*
- g. *determining not to renew the Contract;*
- h. *assessing actual and consequential damages;*
- i. *assessing liquidated damages or reducing fees, provided that liquidated damages may be based on amounts representing costs of delays in carrying out the purposes of the EEO Requirements, or in meeting the purposes of the Contract, the costs of meeting utilization goals through additional procurements, the administrative costs of investigation and enforcement, or other factors set forth in the Contract;*
- j. *exercising rights under the Contract to procure goods, services or construction from another contractor and charge the cost of such contract to the Contractor that has been found to be in noncompliance;*  
*or*
- k. *taking any other appropriate remedy.*

The Contractor may also be referred to the U.S. Department of Labor, Office of Federal Contract Compliance Programs (OFCCP), which has the sole authority to determine compliance with Executive Order 11246 and its implementing regulations.

## ATTACHMENT "H"

OFCCP may declare the Contractor ineligible for further Federal-Aid contracts in accordance with procedures authorized in Executive Order 11246, and such other sanctions may be imposed and remedies invoked as provided in Executive Order 11246, or by rule, regulation, or order of the U.S. Secretary of Labor, or as otherwise provided by law.

**D. DBE Monitoring and Reporting.** The Engineer will monitor the work to ensure that the identified DBEs perform the work as identified in the Contractor's commitments. Attainments will be measured based on payments made to DBEs. Attainments based on work completed by DBEs that are no longer certified will be counted towards the original contract goal, but will not be counted towards the overall corporate goal.

**1. Monitoring Commercially Useful Function (CUF) by DBEs.** Each DBE Subcontractor shall provide confirmation to the Engineer that the workforce provided meets the requirements of Attachment D, Subsection E.2, *Work Force*. Each DBE Subcontractor shall provide a copy of invoices for all material incorporated into the work to the Engineer, in order to confirm that the DBE has met the requirements of Attachment D, Subsection E.4, *Materials*. Each DBE Subcontractor shall provide a copy of a rental agreement for all non-owned equipment used to perform the work to the Engineer, in order to confirm that the DBE has met the requirements of Attachment D, Subsection E.5, *Equipment*.

The Contractor shall provide a copy of an invoice for all material provided by a DBE Manufacturer, Fabricator or Material Supplier to the Engineer. The Contractor shall provide a copy of a rental agreement with each DBE Equipment Rental firm to the Engineer. The Contractor shall provide a copy of an invoice that details the work product(s) provided from each DBE Professional Service to the Engineer.

**2. Report of Payments to Subcontractors and DBEs.** The Contractor shall report payments made to all Subcontractors and all DBEs, in order to measure goal attainment and to gauge the effect of DBE goal(s) on the industry. The Contractor shall submit payment data for all Subcontractors and for all DBEs approved by the Department that are due a payment or have received a payment within the last month. The Subcontractor or DBE shall acknowledge payment not later than 7 calendar days after receipt. The date of receipt is: (1) the date the payment was made by electronic funds transfer to an account identified and agreed to by both parties; (2) the date the envelope containing the payment was date stamped by the US Postal Service; or (3) the date the payment was physically provided to a previously authorized representative of the Subcontractor or DBE, either by the Contractor, or by a delivery service.

The Contractor shall enter the final payment to each Subcontractor or DBE and designate it as such when the final payment is made, or as a separate \$0.00 entry indicating final payment has been made, prior to contract final acceptance, excepting those payments due from work contained in a change order that have not been approved. The Subcontractor or DBE shall acknowledge payment not later than 7 calendar days after receipt.

**3. Revisions to DBE Utilization.** The Contractor shall utilize the DBEs committed to to perform the work or supply materials for which each is listed. The Contractor shall obtain Department approval for substantial revisions in DBE utilization prior to implementing any proposed change through submission of a revised *DBE Utilization Worksheet* using

## ATTACHMENT "H"

the approved civil rights reporting software. Unless approval for revision is granted, the Contractor will not be entitled to any payment for work or material committed to a DBE unless it is performed or supplied by the approved DBE.

If the reduction of the DBE's work or the removal of the DBE, including for reasons of commercially useful function violations, causes the DBE utilization to fall below the goal(s), the Contractor shall make good faith efforts to find another DBE to substitute for the original DBE to perform at least the same amount of work as the DBE that was terminated, to the extent needed to meet the contract goal(s).

A DBE may be substituted if the work committed to the DBE is deleted or reduced by the Department and enough work remains to substitute an equal commitment amount to the affected DBE. If not enough work remains, the Department may relieve the Contractor from attaining that portion of the commitments.

The following modifications will be considered a substantial revision in DBE utilization:

1. Adding, removing or substituting a DBE;
2. Adding new item(s) of work to a DBE within a NAICS Code for which the DBE is not currently approved;
3. Significantly reducing the dollar value of or eliminating the DBE's item(s) of work. Significant reduction will be determined by comparison to the total DBE contract goal.

The following modifications will not be considered a substantial revision in DBE utilization:

1. Increasing the dollar value of an item(s) of work or adding new item(s) of work within the same NAICS Code to a DBE;
2. Substituting similar dollar values of work within NAICS Codes that the DBE is currently approved for;
3. Changes in utilization due to differences between estimated quantities and actual work performed.

*a. DBE Program.* In accordance with 49 CFR 26.53(f)(1), the Contractor shall not terminate a DBE listed on the approved DBE Utilization plan without the prior written consent of the Department. This includes, but is not limited to, instances in which a contractor seeks to perform work originally designated for a DBE subcontractor with its own forces or those of an affiliate, a non-DBE firm, or with another DBE firm.

The Department will consent only if the Contractor has good cause to terminate the DBE firm. Good cause includes, at a minimum, one the following circumstances:

- The listed DBE fails or refuses to execute a written contract;
- The listed DBE fails or refuses to perform the work of its subcontract in a way consistent with normal industry standards. Provided, however, that good cause does not exist if the failure or refusal of the DBE subcontractor to perform its work on the subcontract results from the bad faith or discriminatory action of the Contractor;
- The listed DBE fails or refuses to meet the Contractor's reasonable, nondiscriminatory bond requirements.
- The listed DBE becomes bankrupt, insolvent, or exhibits credit unworthiness;

## ATTACHMENT "H"

- The listed DBE is ineligible to work on public works projects because of suspension and debarment proceedings pursuant 2 CFR Parts 180, 215 and 1,200 or applicable state law;
- The Department has determined that the listed DBE is not a responsible contractor;
- The listed DBE voluntarily withdraws from the project and provides to the Department written notice of its withdrawal;
- The listed DBE is ineligible to receive DBE credit for the type of work required;
- A DBE owner dies or becomes disabled with the result that the listed DBE is unable to complete its work on the contract;
- Other documented good cause that you determine compels the termination of the DBE. Provided, that good cause does not exist if the Contractor seeks to terminate a DBE it relied upon to obtain the contract so that the Contractor can self-perform the work for which the DBE was engaged or so that the Contractor can substitute another DBE or non-DBE contractor after contract award.

Before submitting its request to terminate and/or substitute a DBE to the Department, the Contractor shall give notice in writing to the DBE subcontractor, with a copy to the Engineer, of its intent to request to terminate and/or substitute, and the reason for the request.

The Contractor shall give the DBE five days to respond to the notice and advise the Department and the Contractor of the reasons, if any, why the DBE objects to the proposed termination of its subcontract and why the Department should not approve the Contractor's action. If required in a particular case as a matter of public necessity (e.g., safety), the Department may approve a response period shorter than five days.

**3. Contractor DBE Program Compliance.** If the Contractor fails to meet the DBE utilization goal(s), to exert a good faith effort, or otherwise fails to comply with the DBE requirements, the Department may take further actions, as follows. The Department may determine that one of the following actions should be taken:

- a. entering into an agreement with the Contractor allowing the Contractor to cure the violation;
- b. revoking the Contractor's pre-qualification to bid or make proposals for future contracts;
- c. making a finding that the Contractor is in default of the Contract;
- d. terminating the Contract;
- e. declaring the Contractor to be in breach of Contract;
- f. withholding payment or reimbursement;
- g. determining not to renew the Contract;
- h. assessing actual and consequential damages;
- i. assessing liquidated damages or reducing fees, provided that liquidated damages may be based on amounts representing costs of delays in carrying out the purposes of the DBE program, or in meeting the purposes of the Contract, the costs of meeting utilization goals through additional procurements, the administrative costs of investigation and enforcement, or other factors set forth in the Contract;

## ATTACHMENT "H"

- j. exercising rights under the Contract to procure goods, services or construction from another contractor and charge the cost of such contract to the Contractor that has been found to be in noncompliance; or
- k. taking any other appropriate remedy.

The Contractor may also be referred to the USDOT for possible suspension or debarment as provided in 49 CFR 29 and such other sanctions as may be imposed and remedies invoked as provided under the authority of 49 CFR 26, or by rule, regulation, or order of the Commissioner or as otherwise provided by law.

**E. Apprenticeship Monitoring and Reporting.** The Contractor shall report all apprenticeship participation as part of its Employee Utilization Data submitted monthly per Subsection C.1 of this Attachment "H". The Contractor shall provide, with the final request for payment, a Certification of Compliance that:

- a. lists all New York State Department of Labor approved apprenticeship programs utilized in the execution of the Contract;
- b. certifies that all apprenticeship participation has been submitted as part of the monthly Employee Utilization Data;
- c. certifies that the requirements of the above listed apprenticeship programs have been met.

**F. Compliance Reviews.** The New York State Department of Transportation and the Department conduct annual civil rights contract compliance reviews of selected Federal-aid contracts in accordance with 23 CFR 230.409. A compliance review consists of a thorough review of all civil rights contract requirements, including Nondiscrimination in Labor/Employment, EEO, Training, and DBE requirements. A Contractor will typically not be selected for more than one compliance review per year statewide. Based on contract monitoring and/or the results of compliance review(s), the New York State Department of Transportation and the Department may conduct a review of some or all ongoing contracts with a single Contractor, regardless of funding source.

**False Claims Certification  
(31 USC §3729, NYS Finance Law Article 13)**

Under the Federal False Claims Act, 31 US Code §3729, any person or entity who knowingly presents, or causes to be presented to the Federal Government, a false or fraudulent claim for payment or approval is liable to the United State Government for a civil penalty of not less than \$5,000 and not more than \$10,000, plus three times the amount of damages the Government sustains.

Under the New York State False Claims Act, NYS Finance Law Article 13, any person or entity who knowingly presents or causes to be presented to the State of New York or Local Governments within the State of New York, a false or fraudulent claim for payment or approval is liable to the Government for a civil penalty of not less than \$6,000 and not more than \$12,000, plus three times the amount of damages the Government sustains.

"Knowingly" is defined as: (1) actual knowledge; (2) acting in deliberate ignorance of the truth or falsity of information; or (3) acting in reckless disregard of the truth or falsity of information; no proof of specific intent to defraud is required.

The Contractor to whom the above-identified contract is to be awarded does hereby certify to New York State Department of Transportation that it understands the prohibitions under the Federal and New York State False Claims Acts, and that it has not and will not submit or caused to be submitted any fraudulent claims in the submission of this bid or in connection with the above-identified contract. The Contractor further certifies that it understands retaliatory actions, against employees and officers who initiate a *Qui Tam* (public) action on behalf of the government or cooperate in the investigation of a false claim, are prohibited and are subject to an assessment of damages and penalties, under the provisions of the Federal and New York State False Claims Acts.

**UNITED STATES DEPARTMENT OF TRANSPORTATION HOTLINE**

Persons with knowledge of bid collusion (i.e., contractors, suppliers, work persons, etc.), or other questionable contract related practices (inadequate materials, poor workmanship, theft of materials, etc.), are encouraged to report such activities by calling the U.S. DOT HOTLINE. The HOTLINE number is 1-800-424-9071 and calls will be answered from 8:00 A.M. to 5:00 P.M. EST, Monday through Friday.

This HOTLINE is under the direction of the U.S. DOT's Inspector General. All information will be treated confidentially and the caller's anonymity will be respected.

**NEW YORK STATE INSPECTOR GENERAL HOTLINE**

Reports of New York State Governmental Misconduct may be made in strict confidence to the New York State Inspector General on the Toll Free Statewide HOTLINE or by writing to the Office of the State Inspector General. The Toll-Free Statewide HOTLINE telephone number is 1-800-367-4448 and calls will be answered between 9:00 A.M. and 5:00 P.M., Monday through Friday. The address of the Office of the Inspector General is P.O. Box 9, One Commerce Plaza, Albany, New York 12260.



**ATTACHMENT "1"**

**(NO TEXT THIS PAGE)**

**ATTACHMENT "J"**

MA 2A (03-09-33)  
NYCDOT

**NEW YORK CITY DEPARTMENT OF DESIGN AND CONSTRUCTION  
DEBARMENT HISTORY CERTIFICATION  
CONTRACT NO. \_\_\_\_\_**

I, \_\_\_\_\_, being duly sworn, certifies that,  
**(PRESIDENT OF AUTHORIZED OFFICIAL)**

except as noted herein, \_\_\_\_\_ or any person  
**(THE COMPANY)**

associated therewith in the capacity of owner, partner, director, officer, principal investigator, project director, manager, auditor, or any position involving the administration of Federally Aided Projects:

is not currently under suspension, debarment, voluntary exclusion, or determination of ineligibility by any governmental entity;

has not been suspended, debarred, voluntarily excluded or determined ineligible by any governmental entity within the past three (3) years;

does not have a proposed debarment pending; and

has not been indicted, convicted, or had a civil judgement rendered against it by a court of competent jurisdiction in any matter involving fraud or official misconduct within the past three (3) years.

**(INSERT EXCEPTIONS HERE. ATTACH SUPPLEMENTAL SHEETS AS NECESSARY)**

Exceptions will not necessarily result in denial of approval, but will be considered in determining responsibility. For any exception noted herein, indicate to whom it applies, initiating governmental entity and dates of action. A material false statement willfully or fraudulently made in connection with this certification may result in rendering the company not responsible for the project and any future projects, and in addition may subject the person making the false statement to criminal charges.

\_\_\_\_\_  
(PRINT NAME)

\_\_\_\_\_  
(SIGNATURE)

\_\_\_\_\_  
(TITLE)

\_\_\_\_\_  
(DATE)

Subscribed and sworn to before me this \_\_\_\_\_ day of \_\_\_\_\_, 20\_\_\_\_\_.

MA 2A (03-09-33)  
NYCDOT

**NEW YORK CITY DEPARTMENT OF DESIGN AND CONSTRUCTION  
DEBARMENT HISTORY CERTIFICATION  
CONTRACT NO. \_\_\_\_\_**

**GOVERNMENTAL ENTITY:**

Governmental Entities shall include any/all city, state and federal public agencies, quasi-public agencies, authorities and corporations, public development corporations, and local development corporations.

**COMPANY:**

Companies shall include the persons or affiliates for which a suspension or debarment decision has been rendered, and shall include all subsidiaries, divisions and other organizational elements thereof unless said decision is limited by its terms to one or more specifically identified individuals or organizational elements or to specific types of transactions.

**PERSON:**

Persons shall include any individual, corporation, partnership, association or legal entity however organized, including any subsidiary of the foregoing.

**SUBSIDIARY:**

Subsidiaries shall include any corporation, partnership, association or legal entity however organized, which is owned or controlled by another person.

**AFFILIATE:**

Persons are affiliates of one another if, directly or indirectly, one owns, controls, or has the power to control the other, or a third person owns, controls, or has the power to control both.

**CONTROL:**

Control shall be taken to mean the power to exercise, either directly or indirectly, a controlling influence over management, policies or activities of a person, whether through ownership of voting securities, through one or more intermediary persons, or otherwise. Indications of control shall include, but not be limited to: a person who owns or has the power to vote more than 25 percent of the voting securities of another person, or 25 percent of the total equity if the other person has no voting securities; interlocking management or ownership; identity of interests among family members; shared facilities and equipment; common use of employees; and establishment, following debarment, suspension or other exclusion decision, of any organization or entity which is to operate in the same business or activity and is to have substantially the same management, ownership or principal employees as the debarred, suspended or excluded person.

**LOBBYING ACTIVITY CERTIFICATION**

The prospective participant certifies, by signing and submitting this bid or proposal, to the best of his or her knowledge and belief, that:

(1) No Federal appropriated funds have been paid or will be paid, by or on behalf of the undersigned, to any person for influencing or attempting to influence an officer or employee of any Federal agency, a Member of Congress, an officer or employee of Congress, or an employee of a Member of Congress in connection with the awarding of any federal contract, the making of any Federal grant, the making of any Federal loan, the entering into of any cooperative agreement, and the extension, continuation, renewal, amendment, or modification of any Federal contract, grant, loan, or cooperative agreement.

(2) If any funds other than Federal appropriated funds have been paid or will be paid to any person for influencing or attempting to influence an officer or employee of any Federal agency, a Member of Congress, an officer or employee of Congress, or an employee of a Member of Congress in connection with this Federal contract, grant, loan, or cooperative agreement, the undersigned shall complete and submit Standard Form LLL, "Disclosure Form to Report Lobbying", in accordance with its instructions. (See Exhibit 1 annexed hereto)

This certification is a material representation of fact upon which reliance was placed when this transaction was made or entered into. Submission of this certification is a prerequisite for making or entering into this transaction imposed by Section 1352, Title 31, U.S. Code. Any person who fails to file the required certification shall be subject to a civil penalty of not less than \$10,000 and not more than \$100,000 for each such failure.

The prospective participant also agrees by submitting his or her bid or proposal that he or she shall require that the language of this certification be included in all lower tier subcontracts, which exceed \$100,000 and that all such subrecipients shall certify and disclose accordingly.

**DISCLOSURE OF LOBBYING ACTIVITIES**

Approved by OMB

Complete this form to disclose lobbying activities pursuant to 31 U.S.C. 1352

0348-0046

(See reverse for public burden disclosure.)

<b>1. Type of Federal Action:</b> <input type="checkbox"/> a. contract <input type="checkbox"/> b. grant <input type="checkbox"/> c. cooperative agreement <input type="checkbox"/> d. loan <input type="checkbox"/> e. loan guarantee <input type="checkbox"/> f. loan insurance	<b>2. Status of Federal Action:</b> <input type="checkbox"/> a. bid/offer/application <input type="checkbox"/> b. initial award <input type="checkbox"/> c. post-award	<b>3. Report Type:</b> <input type="checkbox"/> a. initial filing <input type="checkbox"/> b. material change <b>For Material Change Only:</b> year _____ quarter _____ date of last report _____
<b>4. Name and Address of Reporting Entity:</b> <input type="checkbox"/> Prime <input type="checkbox"/> Subawardee Tier _____, if known:  Congressional District, if known:	<b>5. If Reporting Entity in No. 4 is a Subawardee, Enter Name and Address of Prime:</b>  Congressional District, if known:	
<b>6. Federal Department/Agency:</b>	<b>7. Federal Program Name/Description:</b>  CFDA Number, if applicable: _____	
<b>8. Federal Action Number, if known:</b>	<b>9. Award Amount, if known:</b> \$ _____	
<b>10. a. Name and Address of Lobbying Registrant</b> <i>(if individual, last name, first name, MI):</i>	<b>b. Individuals Performing Services</b> <i>(including address if different from No. 10a)</i> <i>(last name, first name, MI):</i>	
<b>11.</b> Information requested through this form is authorized by title 31 U.S.C. section 1352. This disclosure of lobbying activities is a material representation of fact upon which reliance was placed by the tier above when this transaction was made or entered into. This disclosure is required pursuant to 31 U.S.C. 1352. This information will be reported to the Congress semi-annually and will be available for public inspection. Any person who fails to file the required disclosure shall be subject to a civil penalty of not less than \$10,000 and not more than \$100,000 for each such failure.	Signature: _____ Print Name: _____ Title: _____ Telephone No.: _____ Date: _____	
<b>Federal Use Only:</b>		Authorized for Local Reproduction Standard Form LLL (Rev. 7-97)

## ATTACHMENT "J"

### INSTRUCTIONS FOR COMPLETION OF SF-LLL, DISCLOSURE OF LOBBYING ACTIVITIES

This disclosure form shall be completed by the reporting entity, whether subawardee or prime Federal recipient, at the initiation or receipt of a covered Federal action, or a material change to a previous filing, pursuant to title 31 U.S.C. section 1352. The filing of a form is required for each payment or agreement to make payment to any lobbying entity for influencing or attempting to influence an officer or employee of any agency, a Member of Congress, an officer or employee of Congress, or an employee of a Member of Congress in connection with a covered Federal action. Complete all items that apply for both the initial filing and material change report. Refer to the implementing guidance published by the Office of Management and Budget for additional information.

1. Identify the type of covered Federal action for which lobbying activity is and/or has been secured to influence the outcome of a covered Federal action.
2. Identify the status of the covered Federal action.
3. Identify the appropriate classification of this report. If this is a followup report caused by a material change to the information previously reported, enter the year and quarter in which the change occurred. Enter the date of the last previously submitted report by this reporting entity for this covered Federal action.
4. Enter the full name, address, city, State and zip code of the reporting entity. Include Congressional District, if known. Check the appropriate classification of the reporting entity that designates if it is, or expects to be, a prime or subaward recipient. Identify the tier of the subawardee, e.g., the first subawardee of the prime is the 1st tier. Subawards include but are not limited to subcontracts, subgrants and contract awards under grants.
5. If the organization filing the report in item 4 checks "Subawardee," then enter the full name, address, city, State and zip code of the prime Federal recipient. Include Congressional District, if known.
6. Enter the name of the Federal agency making the award or loan commitment. Include at least one organizational level below agency name, if known. For example, Department of Transportation, United States Coast Guard.
7. Enter the Federal program name or description for the covered Federal action (item 1). If known, enter the full Catalog of Federal Domestic Assistance (CFDA) number for grants, cooperative agreements, loans, and loan commitments.
8. Enter the most appropriate Federal identifying number available for the Federal action identified in item 1 (e.g., Request for Proposal (RFP) number; Invitation for Bid (IFB) number; grant announcement number; the contract, grant, or loan award number; the application/proposal control number assigned by the Federal agency). Include prefixes, e.g., "RFP-DE-90-001."
9. For a covered Federal action where there has been an award or loan commitment by the Federal agency, enter the Federal amount of the award/loan commitment for the prime entity identified in item 4 or 5.
10. (a) Enter the full name, address, city, State and zip code of the lobbying registrant under the Lobbying Disclosure Act of 1995 engaged by the reporting entity identified in item 4 to influence the covered Federal action.  
  
(b) Enter the full names of the individual(s) performing services, and include full address if different from 10 (a). Enter Last Name, First Name, and Middle Initial (MI).
11. The certifying official shall sign and date the form, print his/her name, title, and telephone number.

According to the Paperwork Reduction Act, as amended, no persons are required to respond to a collection of information unless it displays a valid OMB Control Number. The valid OMB control number for this information collection is OMB No. 0348-0046. Public reporting burden for this collection of information is estimated to average 10 minutes per response, including time for reviewing instructions, searching existing data sources, gathering and maintaining the data needed, and completing and reviewing the collection of information. Send comments regarding the burden estimate or any other aspect of this collection of information, including suggestions for reducing this burden, to the Office of Management and Budget, Paperwork Reduction Project (0348-0046), Washington, DC 20503.

**ATTACHMENT "J"**

**DISCLOSURE OF LOBBYING ACTIVITIES  
CONTINUATION SHEET**

APPROVED BY OMB  
0346-0046

REPORTING ENTITY: \_\_\_\_\_ PAGE \_\_\_\_\_ OF \_\_\_\_\_

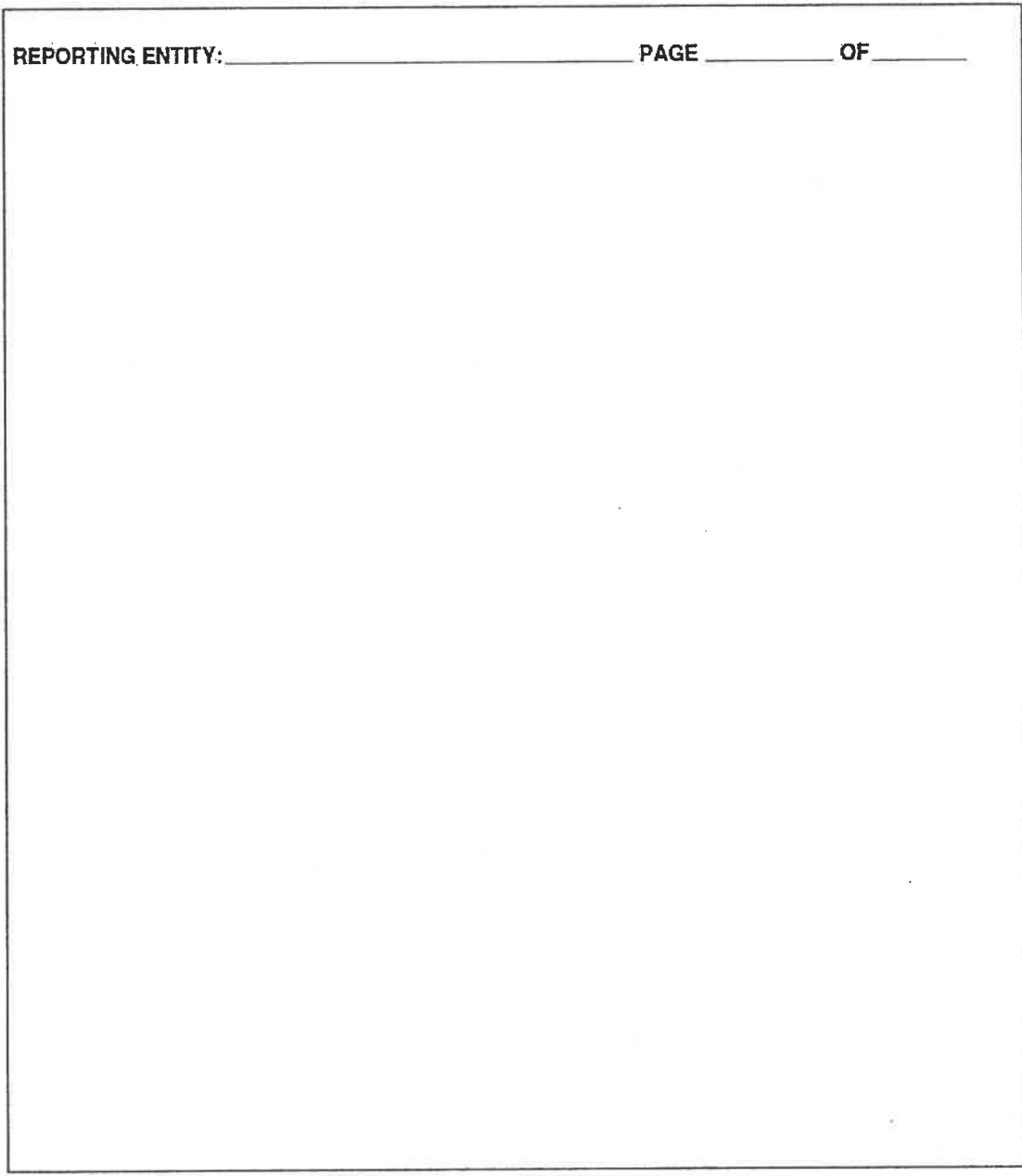

Authorized for Local Reproduction - Standard form LLL

**PROVISIONS RELATING TO THE NEW YORK STATE LABOR LAW,  
PREVAILING WAGES, AND THE USE OF CONVICT LABOR AND  
MATERIALS ON FEDERAL & STATE CONTRACTS**

**GENERAL PROVISIONS.** All projects funded with Federal aid and let to contract in New York State shall conform to the provisions of the New York State Labor Law, except that in accordance with the authorization in Article 4, Section 85 of the New York State Highway Law, any provisions of the above referenced Labor Law which are in conflict with the following enumerated mandatory Federal Aid highway construction compliance requirements, as contained in Section 635 of the Code of Federal Regulations, Title 23-Highways, and other Federal legislation, rules, and regulations, as referenced below, are superseded:

**CONVICT LABOR.** No convict labor, unless performed by convicts who are on parole, supervised release, or probation, shall be employed in construction or used for maintenance or any other purposes at the site or within the limits of any Federal Aid highway construction project from the time of award of the contract or the start of work on force account until final acceptance of the work by the Owner.

**SELECTION OF LABOR.** No procedures or requirements shall be imposed by any state or municipal subdivision thereof which will operate to discriminate against the employment of labor from any other state, possession, or territory of the United States, in the construction of a Federal Aid project. The selection of labor to be employed by the Contractor on any Federal Aid project shall be of his/her own choosing.

**WAGE RATES ON FEDERAL AID PROJECTS.** Attention is directed to the statutory provisions governing the prevailing rates of wages for workmen, mechanics, and laborers who are employed on this project. Section 220 of the New York State Labor Law, as amended, requires that the wages paid for a legal day's work shall be not less than the rate of wages plus the supplements prevailing at the time the work is performed, the current schedules of which shall be included in the contract documents. Such schedules may be amended or supplemented from time to time, and such amendments or supplements shall be forwarded to the Contractor.

The Federal Aid Highway Act of 1968 provides for the payment of wages at rates not less than those determined in accordance with the Davis-Bacon Act (40 USC, Section 276-a), the schedule of which shall also be included in the contract documents.

On-site materials suppliers, in addition to all subcontractors, are subject to the provisions of the Davis-Bacon Act. This will not necessarily be construed as causing the on-site material suppliers to be classified as subcontractors as part of the 50% limitation on the subcontracting of this project.

In case of a variance between (1) the schedules of prevailing rates of wages and supplements as determined under Section 220 of the New York State Labor Law, and (2) the schedule of rates of wages as determined pursuant to the Davis-Bacon Act, the Contractor shall accept and use the schedule or schedules that establish the higher rate of wages as the minimum for the workmen who are employed on the project.



## **ATTACHMENT "K"**

**CONSTRUCTION BY FEDERAL AGENCIES.** When construction on Federal Aid highways is being performed by any Federal agency under its procedures and by Federal contract, the labor standards relating to direct federal contracts shall be applicable.

**NON-DISCRIMINATION.** Employment shall be provided without regard to race, color, religion, sex, or national origin.

**CONVICT-PRODUCED MATERIALS.** The use of convict-produced materials on any Federal or Federally-assisted contract must comply with the following requirements:

a. Materials produced by convict labor may only be incorporated in a Federal Aid highway construction project if such materials have been:

1. Produced by convicts who are on parole, supervised release, or probation from a prison; or
2. Produced in a qualified prison facility and the cumulative annual production amount of such materials for use in Federal Aid highway construction does not exceed the amount of such materials produced in such facility for use in Federal Aid highway construction during the 12-month period ending July 1, 1987.

b. "Qualified prison facility" means any prison facility in which convicts, during the 12-month period ending July 1, 1997, produced materials for use in Federal Aid highway construction projects.

c. Standard State and Federal Aid contract procedures may be used to assure compliance with the requirements of this paragraph.

### **FEDERAL WAGE RATES**

The following pages contain the Federal Wage Rates in effect at the time of bidding. Current rates can be found at: [www.wdol.gov/wdol/scafiles/davisbacon/ny3.dvb](http://www.wdol.gov/wdol/scafiles/davisbacon/ny3.dvb)

General Decision Number: NY170003 03/03/2017 NY3

Superseded General Decision Number: NY20160003

State: New York

Construction Types: Building, Heavy, Highway and Residential

Counties: Bronx, Kings, New York, Queens and Richmond  
Counties in New York.

BUILDING & RESIDENTIAL CONSTRUCTION PROJECTS (includes single family homes and apartments up to and including 4 stories),  
HEAVY AND HIGHWAY CONSTRUCTION PROJECTS

Note: Under Executive Order (EO) 13658, an hourly minimum wage of \$10.20 for calendar year 2017 applies to all contracts subject to the Davis-Bacon Act for which the contract is awarded (and any solicitation was issued) on or after January 1, 2015. If this contract is covered by the EO, the contractor must pay all workers in any classification listed on this wage determination at least \$10.20 (or the applicable wage rate listed on this wage determination, if it is higher) for all hours spent performing on the contract in calendar year 2017. The EO minimum wage rate will be adjusted annually. Additional information on contractor requirements and worker protections under the EO is available at [www.dol.gov/whd/govcontracts](http://www.dol.gov/whd/govcontracts).

Modification Number	Publication Date
0	01/06/2017
1	01/13/2017
2	02/03/2017
3	02/10/2017
4	02/17/2017
5	03/03/2017

ASBE0012-001 06/27/2016

	Rates	Fringes
Asbestos Workers/Insulator		
Includes application of all insulating materials, protective coverings, coatings and finishes to all types of mechanical systems.....	\$ 64.91	33.06
HAZARDOUS MATERIAL HANDLER.....	\$ 39.00	12.75

BOIL0005-001 01/01/2013

	Rates	Fringes
BOILERMAKER.....	\$ 49.47	33%+22.87+a

FOOTNOTE:

a. PAID HOLIDAYS: New Year's Day, Thanksgiving Day, Memorial Day, Independence Day, Labor Day and Good Friday, Friday after Thanksgiving, Christmas Eve Day and New Year's Eve

-----  
BRNY0001-001 07/01/2016

	Rates	Fringes
BRICKLAYER.....	\$ 56.77	24.75
MASON - STONE.....	\$ 62.67	30.59

-----  
BRNY0001-002 07/01/2016

	Rates	Fringes
Pointer, cleaner and caulker.....	\$ 50.43	25.26

-----  
BRNY0004-001 01/01/2017

	Rates	Fringes
MARBLE MASON.....	\$ 57.74	34.11

-----  
BRNY0007-001 01/01/2017

	Rates	Fringes
TERRAZZO FINISHER.....	\$ 50.86	34.04
TERRAZZO WORKER/SETTER.....	\$ 52.46	34.06

-----  
BRNY0020-001 01/01/2017

	Rates	Fringes
MARBLE FINISHER.....	\$ 46.01	32.53

-----  
BRNY0024-001 01/01/2017

	Rates	Fringes
BRICKLAYER MARBLE POLISHERS.....	\$ 40.89	25.20

-----  
BRNY0052-001 06/06/2016

	Rates	Fringes
Tile Layer.....	\$ 48.51	26.37

-----  
BRNY0088-001 12/07/2015

	Rates	Fringes
TILE FINISHER.....	\$ 42.42	29.13

-----  
CARP0001-009 07/01/2016

	Rates	Fringes
--	-------	---------

CARPENTER

Carpenters.....	\$ 52.50	45.58
Soft Floor Layers.....	\$ 52.50	45.58

-----  
 CARP0740-001 07/01/2016

	Rates	Fringes
--	-------	---------

MILLWRIGHT.....	\$ 51.50	51.71
-----------------	----------	-------

-----  
 CARP1556-006 07/01/2016

	Rates	Fringes
--	-------	---------

Dock Builder & Piledrivermen DOCKBUILDERS.....	\$ 51.63	47.95
---	----------	-------

-----  
 CARP1556-007 07/01/2016

	Rates	Fringes
--	-------	---------

Diver Tender.....	\$ 46.44	47.95
Diver.....	\$ 65.38	47.95

-----  
 CARP1556-011 07/01/2016

	Rates	Fringes
--	-------	---------

Carpenters: TIMBERMEN.....	\$ 46.99	47.56
-------------------------------	----------	-------

-----  
 \* ELEC0003-001 05/11/2016

	Rates	Fringes
--	-------	---------

ELECTRICIAN

Electricians.....	\$ 54.00	96.033%+a
Jobbing, and maintenance and repair work.....	\$ 25.30	15.13+a

PAID HOLIDAYS:

a. New Years Day, Martin Luther King, Jr.'s Birthday,  
 Washington's Birthday, Memorial Day, Independence Day,  
 Labor Day, Columbus Day, Election Day, Thanksgiving Day,  
 the day after Thanksgiving Day, and Christmas Day

-----  
 ELEC1049-001 04/03/2016

QUEENS COUNTY

	Rates	Fringes
--	-------	---------

Line Construction (Substation  
 and Switching structures pipe  
 type cable installation and  
 maintenance jobs or projects;  
 Railroad electrical

distribution/transmission systems maintenance (when work is not performed by railroad employees) Overhead and Underground transmission/distribution line work. Fiber optic, telephone cable and equipment)

Groundman.....	\$ 31.37	21.72
Heavy Equipment Operator....	\$ 41.82	25.06
Lineman and Cable Splicer...	\$ 52.28	28.39
Tree Trimmer.....	\$ 30.09	14.12

-----  
 ELEV0001-002 03/17/2013

	Rates	Fringes
ELEVATOR MECHANIC		
Elevator Constructor.....	\$ 57.01	27.605+a+b
Modernization and Repair....	\$ 45.14	27.455+a+b

FOOTNOTE:

a. PAID HOLIDAYS: New Year's Day, Good Friday, President's Day, Memorial Day, Independence Day, Labor Day, Columbus Day, Veteran's Day, Thanksgiving Day, Friday after Thanksgiving, and Christmas Day.

b. PAID VACATION: An employee who has worked less than 5 years shall receive vacation pay credit on the basis of 4% of his hourly rate for all hours worked; an employee who has worked 5 to 15 years shall receive vacation pay credit on the basis of 6% of his hourly rate for all hours worked; an employee who has worked 15 or more years shall receive vacation pay credit on the basis of 8% of his hourly rate for all hours worked.

-----  
 ENGI0014-001 07/01/2016

	Rates	Fringes
POWER EQUIPMENT OPERATOR (HEAVY & HIGHWAY)		
GROUP 1.....	\$ 92.76	31.15
GROUP 2.....	\$ 76.51	31.15
GROUP 3.....	\$ 78.96	31.15
GROUP 4.....	\$ 77.07	31.15
GROUP 5.....	\$ 75.55	31.15
GROUP 6.....	\$ 72.53	31.15
GROUP 7.....	\$ 73.90	31.15
GROUP 8.....	\$ 71.78	31.15
GROUP 9.....	\$ 70.24	31.15
GROUP 10.....	\$ 67.16	31.15
GROUP 11.....	\$ 62.73	31.15
GROUP 12.....	\$ 64.13	31.15
GROUP 13.....	\$ 64.63	31.15
GROUP 14.....	\$ 48.73	31.15
GROUP 15.....	\$ 45.27	31.15
POWER EQUIPMENT OPERATOR		

(PAVEMENT-HEAVY & HIGHWAY)		
Asphalt Plants.....	\$ 59.14	31.15+a
Asphalt roller.....	\$ 69.91	31.15+a
Asphalt spreader.....	\$ 71.78	31.15+a
POWER EQUIPMENT OPERATOR		
(STEEL ERECTION)		
Compressors, Welding		
Machines.....	\$ 45.34	31.15
Cranes, Hydraulic Cranes,		
2 drum derricks,		
Forklifts, Boom Trucks.....	\$ 76.43	31.15
Three drum derricks.....	\$ 79.54	31.15
POWER EQUIPMENT OPERATOR		
(UTILITY)		
Horizontal Boring Rig.....	\$ 68.25	31.15
Off shift compressors.....	\$ 56.70	31.15
Utility Compressors.....	\$ 44.98	31.15

POWER EQUIPMENT OPERATOR CLASSIFICATIONS

GROUP 1: Tower crane

GROUP 2: Backhoes, power shovel, Hydraulic clam shells, moles and machines of a similar type

GROUP 3: Mine hoists and crane, etc. used as mine hoists

GROUP 4: Gradalls, keystones, cranes (with digging buckets), bridge cranes, trenching machines, vermeer cutter and machines of a similar nature

GROUP 5: Piledrivers, derrick boats, tunnel shovels

GROUP 6: All drills, and machines of a similar nature

GROUP 7: Back filling machines, cranes, mucking machines, dual drum pavers

GROUP 8: Mixers (concrete w/loading attachments), concrete pavers, cableways, land derricks, power house (low pressure units), concrete pumps

GROUP 9: Concrete plants, well drilling machines, stone crushers double drum hoist, power house (other than above)

GROUP 10: Concrete mixers

GROUP 11: Elevators

GROUP 12: Concrete breaking machine, Hoists (single drum), load masters, locomotive and dinkies over 10 tons

GROUP 13: Vibratory console

GROUP 14: Compressors (portable 3 or more in battery), tugger machine (caissons), well point pumps, chum drill

GROUP 15: Boilers, (high pressure, compressors (portable, single, or 2 in battery, not over 100' apart), pumps (river cofferdam and welding machines (except where arc is

operated by members of local 15) push button machines, all engines irrespective of power (power pac) used to drive auxilliary equipment, air, hydraulic etc.

PREMIUMS ON CRANES (Crawler or Truck):

100' to 149' boom - add .50  
 150' to 249' boom - add .75  
 250' to 349' boom - add 1.00  
 350' to 450' boom - add 1.50

Premiums for Cranes on Steel Erection:

100' to 149' boom - add 1.75  
 150' to 249' boom - add 2.00  
 250' to 349' boom - add 2.25  
 350' to 450' boom - add 2.75  
 Tower crane - add 2.00

FOOTNOTE:

a. Paid Holidays: New Year's Day; Lincoln's Birthday; Washington's Birthday; Memorial Day; Independence Day; Labor Day; Veterans Day; Columbus Day; Election Day; Thanksgiving Day; and Christmas Day; provided the employee works one day the payroll week in which the holiday occurs.

-----  
 ENGI0014-002 07/01/2016

	Rates	Fringes
Power Equipment Operator		
BUILDING & RESIDENTIAL		
GROUP 1.....	\$ 71.85	31.15+a
GROUP 2.....	\$ 76.12	31.15+a
GROUP 3.....	\$ 69.39	31.15+a
GROUP 4.....	\$ 63.12	31.15+a
GROUP 5.....	\$ 47.26	31.15+a

POWER EQUIPMENT OPERATORS CLASSIFICATIONS

GROUP 1: Double drum

GROUP 2: Stone derrick, cranes, hydraulic cranes, boom trucks

GROUP 3: 4 pole Hoist, Single Drum Hoists

GROUP 4: Fork lift, house cars, plaster (platform machine), plaster bucket, concrete pump and all other equipment used for hoisting material

GROUP 5: Compressors, welding machines (cutting concrete work), paint spraying, sand blasting, pumps (with the exclusion of concrete pumps), house car (settlement basis only), all engines irrespective of power (power pac) used to drive auxiliary equipment, air, hydraulic, etc., boilers

Premiums for Cranes:

100'-149' boom - add 1.75  
 150'-249' boom - add 2.00  
 250'-349' boom - add 2.25

350'-450' boom - add 2.75  
 Tower cranes add 2.00

FOOTNOTE:

a. PAID HOLIDAYS: New Year's Day, Lincoln's Birthday, Memorial Day, Independence Day, Labor Day, Veteran's Day, Columbus Day, Election Day, Thanksgiving Day, and Christmas Day, provided the employee works one day in the payroll week in which the holiday occurs

-----  
 ENGI0015-001 07/01/2016

	Rates	Fringes
POWER EQUIPMENT OPERATOR		
HEAVY AND HIGHWAY		
GROUP 1.....	\$ 65.94	32.95
GROUP 2.....	\$ 63.98	32.95
GROUP 3.....	\$ 60.69	32.95
GROUP 4.....	\$ 57.42	32.95
GROUP 5.....	\$ 39.70	32.95

POWER EQUIPMENT OPERATORS CLASSIFICATIONS

GROUP 1: Cherrypickers 20 tons and over and loaders (rubber-tired and/or tractor type with a manufacturer's rated capacity of six cubic yards and over

GROUP 2: Backhoes, Basin Machines, Groover, Mechanical Sweepers, Bobcat, Boom Truck, Barrier Transport (Barrier Mover) and machines of a similar nature, Boat Captains, Boat Operators, operation of Churn Drills and machines of a similar nature, Stetco Silent Hoist and machines of a similar nature, Vac-alls, Meyers Machines, John Beam and machines of a similar nature, Ross Carriers and Travel Lifts and machines of a similar nature, Bulldozers, Scrapers, and Turn-a Pulls, Tugger Hoist (used exclusively for handling excavated material), Tractors with attachments, Hyster and Roustabout Cranes, Cherrypickers, Austin Western, Grove and machines of a similar nature, Scoopmobiles, Monorails, Conveyors, Trenchers, Loaders-Rubber-tired and Tractor, Barber Greene, Eimco Loaders and Eimco Backhoes, Mighty Midget and similar breakers and tampers, Curb and Gutter Pavers and Motor Patrol, Motor Graders and all machines of a similar nature, Locomotives ten (10) tons or under, Mini-Max, Break-Tech and machines of a similar nature, Milling Machines, robotic and demolition machines and machines of a similar nature including Bobcat, Pile Rig Rubber-tired Excavator (37,000 lbs. and under), 2 man auger

GROUP 3: Minor Equipment such as Tractors, Post Hole Diggers and Drivers, Ditch Witch (Walk Behind), Road Finishing Machines, Rollers (five (5) tons and under), Tugger Hoists, Dual Purpose Trucks, Fork Lifts and Dempsey Dumpsters

GROUP 4: Oilers for the following equipment: (all gasoline, electric, diesel, or air operated) gradalls and concrete pumps or similarly equipment manned by two-men



GROUP 5: Oilers for the following equipment: (all gasoline, electric, diesel, or air operated) shovels, cranes (draglines), backhoes, pavers, trenching machines, gunite machines, compressors (3 or more in battery)

Premiums for Cranes:  
 100'-149' boom - add 1.75  
 150'-249' boom - add 2.00  
 250'-349' boom - add 2.25  
 350'-450' boom - add 2.75  
 Tower cranes add 2.00

FOOTNOTE:

a. PAID HOLIDAYS: New Year's Day, Lincoln's Birthday, Memorial Day, Independence Day, Labor Day, Veteran's Day, Columbus Day, Election Day, Thanksgiving Day, and Christmas Day, provided the employee works one day in the payroll week in which the holiday occurs

-----  
 ENGI0015-002 07/01/2016

	Rates	Fringes
POWER EQUIPMENT OPERATOR		
BUILDING		
GROUP 1.....	\$ 65.94	32.95
GROUP 2.....	\$ 63.98	32.95
GROUP 3.....	\$ 57.42	32.95

POWER EQUIPMENT OPERATORS CLASSIFICATIONS

GROUP 1: Oiler

GROUP 2: Oilers on Crawler Cranes, Backhoes, Trenching machines, Gunite machines, Compressors (3 or more in Battery)

GROUP 3: Gradalls: Concrete Pumps, Power Houses - All equipment in same is manned by two (2) men only, Driving Truck Cranes

FOOTNOTE:

a. PAID HOLIDAYS: New Year's Day, Lincoln's Birthday, Memorial Day, Independence Day, Labor Day, Veteran's Day, Columbus Day, Election Day, Thanksgiving Day, and Christmas Day, provided the employee works one day in the payroll week in which the holiday occurs

-----  
 IRON0040-002 07/01/2016

BRONX, NEW YORK, RICHMOND

	Rates	Fringes
IRONWORKER, STRUCTURAL.....	\$ 49.50	69.74

-----  
 IRON0046-003 07/01/2014

	Rates	Fringes
IRONWORKER		
METALLIC LATHERS AND		

REINFORCING IRONWORKERS.....	\$ 40.60	30.56
-----		
IRON0197-001 07/01/2016		
	Rates	Fringes
IRONWORKER		
STONE DERRICKMAN.....	\$ 46.34	38.50
-----		
IRON0361-002 07/01/2016		
KINGS, QUEENS		
	Rates	Fringes
Ironworkers:		
(STRUCTURAL).....	\$ 49.50	69.74
-----		
IRON0580-001 07/01/2015		
	Rates	Fringes
IRONWORKER, ORNAMENTAL.....	\$ 43.20	47.42
-----		
LABO0006-001 07/01/2016		
	Rates	Fringes
LABORER (Cement and Concrete		
Workers).....	\$ 42.48	17.35
-----		
LABO0029-001 07/01/2016		
	Rates	Fringes
Laborers:		
Heavy		
Blasters (hydraulic trac		
drill).....	\$ 45.78	33.94
Blasters.....	\$ 44.93	33.94
Hydraulic Trac Drill.....	\$ 40.12	33.94
Jackhammers, Chippers,		
Spaders, Concrete		
Breakers, All Other		
Pneumatic Tools, Walk		
Behind Self-Propelled		
Hydraulic Asphalt and		
Concrete Breaker.....	\$ 38.23	33.94
Powder Carriers.....	\$ 34.20	33.94
-----		
LABO0078-001 02/01/2013		
	Rates	Fringes
LABORERS		
BUILDING CONSTRUCTION		
ASBESTOS (Removal,		
Abatement, Encapsulation		
or Decontamination of		
asbestos); LEAD; &		

HAZARDOUS WASTE LABORERS  
 (Hazardous Waste,  
 Hazardous Materials,  
 Biochemical and Mold  
 Remediation, HVAC, Duct  
 Cleaning, Re-spray  
 Fireproofing, etc).....\$ 35.90 14.75

-----  
 LABO0079-001 01/01/2017

	Rates	Fringes
Laborers Building Construction		
Demolition Laborers		
Tier A.....	\$ 38.48	26.17
Tier B.....	\$ 27.06	19.38
Mason Tenders.....	\$ 39.80	27.30

CLASSIFICATIONS

TIER A: Responsible for the removal of all interior partitions and structural partitions that can consist of sheet rock, block or masonry. Also, all structural slab openings for ducts, mechanical, shafts, elevators, slab openings and exterior walls where the building is not being completely demolished.

TIER B: Responsible for shoveling of debris into containers, pushing containers from the inside to the outside of the building.

-----  
 LABO0147-001 07/01/2016

	Rates	Fringes
LABORERS (FREE AIR & TUNNEL).....	\$ 72.67	47.72

Maintenance Men, Inside Muck Lock Tenders, Pump Men, Electricians, Cement Finishers, Caulkers, Hydraulic Men, Shield Men, Monorail Operators, Motor Men, Conveyor Men, Powder Carriers, Pan Men, Riggers, Chuck Tenders, Track Men Painters, Nippers, Brakemen, Cable Men, Hose Men, Grout Men, Gravel Men, Form Workers, Concrete Workers, Tunnel Laborers, Mole Nipper (one (1) Mole Sipper per Working Shaft per Shift for up to and including Two (2) Moles

-----  
 LABO0731-001 07/01/2016

	Rates	Fringes
LABORER		
Building, Heavy and Residential Construction		
LABORER: (Asbestos, Lead, Hazardous Waste Removal (including soil)/CEMENT/CONCRETE.....		
	\$ 41.00	38.53
UTILITY LABORER.....	\$ 40.85	38.53

Paid Holidays: Labor Day and Thanksgiving Day

-----  
LABO1010-001 07/01/2016

	Rates	Fringes
Laborers:		
HIGHWAY CONSTRUCTION		
Fence Installer & Repairer.	\$ 41.48	38.30
FORMSETTERS.....	\$ 45.35	38.30
LABORERS.....	\$ 41.48	38.30
Landscape Planting & Maintenance.....	\$ 41.48	38.30
Maintenance Safety Surface.	\$ 41.48	38.30
Slurry/Sealcoater/Play Equipment Installer.....	\$ 41.48	38.30
Small Equipment Operator (Not Operating Engineer)...	\$ 41.48	38.30
Small Power Tools Operator.	\$ 41.48	38.30

FOOTNOTES:

a. PAID HOLIDAYS: Memorial Day, Fourth of July, Labor Day, Columbus Day, Election Day and Thanksgiving Day, provided the employee has worked one (1) day in the calendar week in which the said holiday occurs.

-----  
LABO1010-002 07/01/2016

	Rates	Fringes
Laborers-Asphalt Construction:		
Micro Paver.....	\$ 45.95	38.30
Raker.....	\$ 45.35	38.30
Screedperson.....	\$ 45.95	38.30
Shoveler (Production Paving Only).....	\$ 42.06	38.30
Small Equipment Operator (Asphalt).....	\$ 42.06	38.30

-----  
PAIN0009-001 11/01/2016

	Rates	Fringes
GLAZIER.....	\$ 44.70	38.42
PAINTER		
Painters, Drywall Finishers, Lead Abatement Worker.....	\$ 42.50	26.62
Spray, Scaffold and Sandblasting.....	\$ 45.50	26.62

-----  
PAIN0806-001 10/01/2016

	Rates	Fringes
Painters:		
Structural Steel and Bridge.	\$ 49.50	30.35

-----  
 PAIN1974-001 12/28/2016

	Rates	Fringes
Painters:		
Drywall Tapers/Pointers.....	\$ 47.82	22.66

-----  
 PLAS0262-001 02/01/2017

	Rates	Fringes
PLASTERER.....	\$ 45.28	25.30

-----  
 PLAS0262-002 02/01/2017

KINGS AND QUEENS COUNTIES

	Rates	Fringes
PLASTERER.....	\$ 45.28	25.30

-----  
 PLAS0780-001 07/01/2016

	Rates	Fringes
CEMENT MASON/CONCRETE FINISHER...	\$ 49.72	31.81

-----  
 PLUM0001-001 07/01/2016

	Rates	Fringes
PLUMBER		
MECHANICAL EQUIPMENT AND SERVICE		
Any repair and/or replacement of the present plumbing system that does not change the existing roughing.....	\$ 39.92	14.41
PLUMBERS:.....	\$ 67.25	29.30

-----  
 PLUM0638-001 12/28/2016

	Rates	Fringes
PLUMBER		
SERVICE FITTERS.....	\$ 26.30	2.55
SPRINKLER FITTERS,		
STEAMFITTEES.....	\$ 61.81	48.30

Service Fitter work shall consist of all repair, service and maintenance work on domestic, commercial and industrial refrigeration, air conditioning and air cooling, stoker and oil burner apparatus and heating apparatus etc., including but not exclusively the charging, evacuation, leak testing and assembling for all machines for domestic, commercial and industrial refrigeration, air conditioning and heating apparatus. Also, work shall include adjusting, including capacity adjustments, checking and repairing or replacement

of all controls and start up of all machines and repairing all defects that may develop on any system for domestic, commercial and industrial refrigeration and all air conditioning, air cooling, stoker and oil burner apparatus and heating apparatus regardless of size or type.

-----  
 ROOF0008-003 07/01/2016

	Rates	Fringes
ROOFER.....	\$ 41.50	30.87

-----  
 SHEE0028-002 07/31/2014

	Rates	Fringes
SHEET METAL WORKER		
BUILDING CONSTRUCTION.....	\$ 50.91	36.70
RESIDENTIAL CONSTRUCTION....	\$ 27.22	16.48

-----  
 TEAM0282-001 07/01/2015

	Rates	Fringes
TRUCK DRIVER		
Asphalt.....	\$ 39.96	44.7525+a
Euclids & Turnpulls.....	\$ 40.06	44.7525+a
High Rise.....	\$ 48.36	42.9525+a

FOOTNOTES:

PAID HOLIDAYS: New Year's Day, Presidents' Day, Memorial Day, Independence Day, Labor Day, Columbus Day, Election Day, Veterans' Day (Armistice Day), Thanksgiving Day, Day after Thanksgiving and Christmas Day. Employees working two (2) days in the calendar week in which a holiday falls are to be paid for such holiday, provided that they shape each remaining workday during such calendar week.

-----  
 WELDERS - Receive rate prescribed for craft performing operation to which welding is incidental.

=====  
 Note: Executive Order (EO) 13706, Establishing Paid Sick Leave for Federal Contractors applies to all contracts subject to the Davis-Bacon Act for which the contract is awarded (and any solicitation was issued) on or after January 1, 2017. If this contract is covered by the EO, the contractor must provide employees with 1 hour of paid sick leave for every 30 hours they work, up to 56 hours of paid sick leave each year. Employees must be permitted to use paid sick leave for their own illness, injury or other health-related needs, including preventive care; to assist a family member (or person who is like family to the employee) who is ill, injured, or has other health-related needs, including preventive care; or for reasons resulting from, or to assist a family member (or person who is

like family to the employee) who is a victim of, domestic violence, sexual assault, or stalking. Additional information on contractor requirements and worker protections under the EO is available at [www.dol.gov/whd/govcontracts](http://www.dol.gov/whd/govcontracts).

Unlisted classifications needed for work not included within the scope of the classifications listed may be added after award only as provided in the labor standards contract clauses (29CFR 5.5 (a) (1) (ii)).

---

The body of each wage determination lists the classification and wage rates that have been found to be prevailing for the cited type(s) of construction in the area covered by the wage determination. The classifications are listed in alphabetical order of "identifiers" that indicate whether the particular rate is a union rate (current union negotiated rate for local), a survey rate (weighted average rate) or a union average rate (weighted union average rate).

#### Union Rate Identifiers

A four letter classification abbreviation identifier enclosed in dotted lines beginning with characters other than "SU" or "UAVG" denotes that the union classification and rate were prevailing for that classification in the survey. Example: PLUM0198-005 07/01/2014. PLUM is an abbreviation identifier of the union which prevailed in the survey for this classification, which in this example would be Plumbers. 0198 indicates the local union number or district council number where applicable, i.e., Plumbers Local 0198. The next number, 005 in the example, is an internal number used in processing the wage determination. 07/01/2014 is the effective date of the most current negotiated rate, which in this example is July 1, 2014.

Union prevailing wage rates are updated to reflect all rate changes in the collective bargaining agreement (CBA) governing this classification and rate.

#### Survey Rate Identifiers

Classifications listed under the "SU" identifier indicate that no one rate prevailed for this classification in the survey and the published rate is derived by computing a weighted average rate based on all the rates reported in the survey for that classification. As this weighted average rate includes all rates reported in the survey, it may include both union and non-union rates. Example: SULA2012-007 5/13/2014. SU indicates the rates are survey rates based on a weighted average calculation of rates and are not majority rates. LA indicates the State of Louisiana. 2012 is the year of survey on which these classifications and rates are based. The next number, 007 in the example, is an internal number used in producing the wage determination. 5/13/2014 indicates the survey completion date for the classifications and rates under that identifier.

Survey wage rates are not updated and remain in effect until a new survey is conducted.

#### Union Average Rate Identifiers

Classification(s) listed under the UAVG identifier indicate that no single majority rate prevailed for those classifications; however, 100% of the data reported for the classifications was union data. EXAMPLE: UAVG-OH-0010 08/29/2014. UAVG indicates that the rate is a weighted union average rate. OH indicates the state. The next number, 0010 in the example, is an internal number used in producing the wage determination. 08/29/2014 indicates the survey completion date for the classifications and rates under that identifier.

A UAVG rate will be updated once a year, usually in January of each year, to reflect a weighted average of the current negotiated/CBA rate of the union locals from which the rate is based.

---

#### WAGE DETERMINATION APPEALS PROCESS

1.) Has there been an initial decision in the matter? This can be:

- \* an existing published wage determination
- \* a survey underlying a wage determination
- \* a Wage and Hour Division letter setting forth a position on a wage determination matter
- \* a conformance (additional classification and rate) ruling

On survey related matters, initial contact, including requests for summaries of surveys, should be with the Wage and Hour Regional Office for the area in which the survey was conducted because those Regional Offices have responsibility for the Davis-Bacon survey program. If the response from this initial contact is not satisfactory, then the process described in 2.) and 3.) should be followed.

With regard to any other matter not yet ripe for the formal process described here, initial contact should be with the Branch of Construction Wage Determinations. Write to:

Branch of Construction Wage Determinations  
Wage and Hour Division  
U.S. Department of Labor  
200 Constitution Avenue, N.W.  
Washington, DC 20210

2.) If the answer to the question in 1.) is yes, then an interested party (those affected by the action) can request review and reconsideration from the Wage and Hour Administrator (See 29 CFR Part 1.8 and 29 CFR Part 7). Write to:

Wage and Hour Administrator  
U.S. Department of Labor



200 Constitution Avenue, N.W.  
Washington, DC 20210

The request should be accompanied by a full statement of the interested party's position and by any information (wage payment data, project description, area practice material, etc.) that the requestor considers relevant to the issue.

3.) If the decision of the Administrator is not favorable, an interested party may appeal directly to the Administrative Review Board (formerly the Wage Appeals Board). Write to:

Administrative Review Board  
U.S. Department of Labor  
200 Constitution Avenue, N.W.  
Washington, DC 20210

4.) All decisions by the Administrative Review Board are final.

=====

END OF GENERAL DECISION

**NOTICE**

The Standard Sewer And Water Main Specifications of the Department of Environmental Protection (dated July 1, 2014), Sewer Design Standards of the Department of Environmental Protection (dated (September 2007) Revised January 5, 2009), Water Main Standard Drawings of the Department of Environmental Protection (latest revisions), and Specifications For Trunk Main Work of the Department of Environmental Protection (dated July 2014) shall be included as part of the contract documents. These said specifications and standard drawings are hereby revised under the following section headings:

- A. NOTICE TO BIDDERS
- B. REVISIONS TO THE STANDARD SEWER AND WATER MAIN SPECIFICATIONS
- C. REVISIONS TO THE SPECIFICATIONS FOR TRUNK MAIN WORK

(NO TEXT ON THIS PAGE)

**A. NOTICE TO BIDDERS**

- (1) The Contractor is notified that a Notice To Proceed (NTP) date will be issued for work to commence within twenty-one (21) to thirty (30) days of Contract Registration.
- (2) The Contractor shall furnish, install, maintain and subsequently remove temporary Protective Tree Barriers. Protective Tree Barriers shall be Type B, unless otherwise directed by the Engineer, and shall be constructed and installed as shown on the Protective Tree Barrier sketch in Department Of Transportation, Standard Highway Details Of Construction, Drawing No. H-1046A, as directed by the Engineer, and in accordance with Department of Parks and Recreation requirements.
- (3) All utility locations and invert elevations are not guaranteed, nor is there any guarantee that all existing utilities, whether functional or abandoned within the project area are shown.
- (4) All existing house connections shall be maintained and supported during construction. The Contractor shall replace any existing house connection damaged as a result of the Contractor's construction operations as ordered by the Engineer at no cost to the City.
- (5) The Contractor is advised that any City owned light poles, traffic signals, street name signs, traffic signs and encumbrances including, but not limited to, underground conduit displaced as the result of the installation of the new sewers; water mains, catch basins, catch basin connections and appurtenances shall be replaced in kind and as directed by the Engineer. The cost of such work shall be deemed included in the prices bid for all items of work under this contract.
- (6) The Contractor is notified that Victaulic Style 77 Coupling is no longer acceptable for use in any steel water main work. All reference to Victaulic Style 77 Coupling within the Standard Sewer And Water Main Specifications of the Department of Environmental Protection (dated July 1, 2014), the Water Main Standard Drawings of the Department of Environmental Protection (latest revisions), the Specifications For Trunk Main Work (dated July 2014), and the contract drawings, shall be replaced with Bolted Split-Sleeve Restrained Coupling.
- (7) The Contractor is notified that wherever the Item No. "6.52" and words "flagger", "flagperson" and "flagman" are used in the contract documents and drawings it shall mean the Item No. "6.52 FED" and the words "Uniformed flagperson".
- (8) The Contractor is notified that the fuel cost per gallon used in the formula under **Sub-Article 26.2.8** of the Standard Construction Contract for **Extra Work** will be derived from the fuel price index for the United States East Coast published weekly by the United States Energy Information Administration ("USEIA"), and available on its website at <http://www.eia.gov/petroleum/gasdiesel/> . The USEIA published cost per gallon for the applicable fuel on the East Coast for the week in which the first day of each calendar quarter during the contract term occurs (i.e., January 1<sup>st</sup>, April 1<sup>st</sup>, July 1<sup>st</sup> and September 1<sup>st</sup>) will be used in the reimbursement formula for all **Extra Work** invoiced that was performed during that calendar quarter. Should the USEIA stop publishing this fuel price index, the fuel cost per gallon will be determined by reference to a substitute index to be agreed upon by the Contractor and the City.
- (9) The Contractor is responsible for any damage to the existing street and traffic signal equipment, including underground conduits and the safety of both pedestrian and vehicular traffic for the duration of the contract.

Should any conduits, cables or foundations need repair due to the Contractor's negligent operations during construction, all work shall be performed according to NYCDOT Bureau of Traffic's Standard Drawings and Specifications at the sole expense of the Contractor.

It is the Contractor's responsibility to secure an approved electrical contractor to perform all traffic signal work (if any). For list of approved electrical contractors, contact Mr. Michael R. LeFosse of New York City Department of Transportation at (212) 839-3799.

**DATED: November 18, 2016**

**PROJECT ID.: SANDHW11**

- (10)The Contractor is advised that where the existing roadway pavement is designated to be replaced from curb to curb, then no full depth saw cutting of pavement for sewer and water main trenches will be required, except at the limits of full width pavement restoration. No separate or additional payment will be made for any saw cutting.
- (11)The Contractor shall exercise extreme caution and take all necessary precautions in placing sheeting and excavating to prevent any damage to the existing NYC TRANSIT'S subway structures and its appurtenances during construction work throughout the project area. The Contractor shall take full responsibility to protect the said NYC TRANSIT'S subway structures and its appurtenances and any damage caused by the Contractor's operations shall be made good by the Contractor to the satisfaction of the Engineer at no additional cost to the City.
- (12)The Contractor shall submit shop drawings to NYC Transit Authority showing all the details and methods of construction, such as, sheeting and bracing, including the Contractor's procedure and sequence of construction, supporting and/or protection of the existing TA's structures and its appurtenances, with necessary design calculations for approval prior to starting of the construction. The design shall be made by a New York State Licensed Professional Engineer skilled in this type of construction and as further evidenced by the imprint of Professional Engineer's seal and signature on all drawings. The cost of this work shall be deemed included in the price bid for all items of work under this contract.

**B. REVISIONS TO THE STANDARD SEWER AND WATER MAIN SPECIFICATIONS**

- (1) **Refer** to **Subsection 10.21 - Contractor To Notify City Departments**, Page I-13:  
**Add** the following to **Subsection 10.21**:

(1) N.Y.C. D.E.P., BUREAU OF WATER AND SEWERS OPERATIONS

The Contractor shall notify Mr. Peter Gordon, P.E., Chief, Linear Capital Program Management Division at the Department of Environmental Protection, 59-17 Junction Blvd., 3rd floor low rise, Corona N.Y. 11368, at least thirty (30) days prior to the start of construction.

(2) NEW YORK CITY FIRE DEPARTMENT

The Contractor shall notify the Bureau of Fire Communications at least thirty (30) days prior to the start of construction by contacting Mr. Ed Durkin at (718) 624-4194 or (718) 624-3752.

(3) N.Y.C. DEPARTMENT OF TRANSPORTATION

The Contractor shall notify Mr. Steve Galgano, P.E. Chief of Signal/Street Lighting Operations, 34-02 Queens Blvd., Long Island City, N.Y. 11101 at (212) 839-3350, at least seventy-two (72) hours prior to the start of construction.

(4) N.Y.C. DEPARTMENT OF PARKS AND RECREATION

The Contractor shall notify the Parks Department at least seventy-two (72) hours prior to the start of construction by contacting Mr. James Cruickshank at (718) 965-7739.

(5) N.Y.C. TRANSIT AUTHORITY

- (a) The Contractor shall notify Outside Projects at least seven (7) days prior to the start of construction.

The Contractor shall contact:

Mr. Mohamed Adam, P.E.  
Project Engineer-Outside Projects  
New York City Transit  
2 Broadway, 7th Floor  
New York, N.Y. 10004  
Attention Ms. Alina Avadanei  
Telephone No. (646) 252-3641

- (b) The Contractor is advised that bus routes as well as bus stops, within the scope of this project may be affected during construction operations. The Contractor shall notify the Transit Authority at least two (2) weeks prior to the start of construction, in order to make the necessary arrangements as required under the NYC TRANSIT GENERAL NOTES included in The Contract Drawings

Arrangements shall be made through:

Ms. Sarah Wyss  
Director Of Short Range, Bus Service Planning (SRB)  
New York City Transit  
2 Broadway, 17<sup>th</sup> Floor  
New York, N.Y. 10004  
Telephone No. (646) 252-5517  
sarah.wyss@nyct.com

- (c) In addition, the Contractor is advised that construction operations might affect subway lines and stations; and NYCT facilities (i.e. manholes, ducts, etc.). The Contractor shall notify the Transit Authority as required and specified in **Section 10.25 paragraph (A)**, **Section 10.25 paragraph (B)**, and **Section 10.25 paragraph (C)** of this section.

- (2) **Refer** to **Subsection 10.25 - Contractor To Carry Out Agreement Between City And Railroad Company Or Property Owner(s)**, Page I-14:  
**Add** the following to **Subsection 10.25**:

**(A) NYC TRANSIT GENERAL NOTES**

For NYC TRANSIT notes see the contract drawings.

**(B) NYC TRANSIT INSURANCE REQUIREMENTS**

N.Y.C. TRANSIT INSURANCE: The Contractor (Permittee) shall indemnify and save harmless the City of New York and the New York City Transit (Permitter) in accordance with the following "Insurance Requirements" and proof that the necessary insurance is in effect will be required before work can commence:

NYCT "OUTSIDE CONTRACT" INSURANCE REQUIREMENTS

- (1) The Permittee at its sole cost and expense shall carry or cause to be carried and shall maintain at all times during the period of performance under this Agreement policies of insurance as herein below set forth below:

- (A) Workers' Compensation Insurance - (including Employer's Liability Insurance) with limits as specified in Schedule "A", which limit may be met by a combination of primary and excess insurance meeting the statutory limits of New York State. The policy shall be endorsed to include Longshoreman's and Harbor Workers' Compensation Act/Maritime Coverage Endorsement and/or Jones Act Endorsement when applicable.
- (B) Commercial General Liability Insurance - (I.S.O. 2001 Form or equivalent) approved by Permitter in the Permittee's name with limits of liability as specified in Schedule "A" for each occurrence on a combined single limit basis for injuries to persons (including death) and damages to property. The limits may be provided in the form of a primary policy or combination of primary and umbrella/excess policy. When the minimum contract amounts can only be met when applying the umbrella/excess policy; the Umbrella/Excess Policy must follow form of the underlying policy and be extended to "drop down" to become primary in the event primary limits are reduced or aggregate limits are exhausted. Such insurance shall be primary and non-contributory to any other valid and collectable insurance and must be exhausted before implicating any Permitter/MTA policy available.

Such policy should be written on an occurrence form; and shall include:

- Contractual coverage for liability assumed by the Permittee under this agreement;
- Personal and Advertising Injury Coverage;
- Products-Completed. Operations;
- Independent Contractors Coverage;
- "XCU" coverage (Explosion, Collapse, and Underground Hazards) where necessary;

DATED: November 18, 2016

PROJECT ID.: SANDHW11

- Contractual Liability Exclusion, applicable to construction or demolition operations to be performed within 50 feet of railroad tracks, must be voided, where necessary; and,
- Additional Insured Endorsement (I.S.O. Form CG 20 26 07/04 version or equivalent) approved the Permitter naming:

New York City Transit Authority (NYCTA), the Manhattan and Bronx Surface Transit Operating Authority (MaBSTOA), the Staten Island Rapid Transit Operating Authority (SIRTOA), MTA Capital Construction Co., the Metropolitan Transportation Authority (MTA) including its subsidiaries and affiliates, and the City of New York (as Owner).

(C) Business Automobile Liability Insurance Policy - (I.S.O. Form CA 00 01 10 01 or equivalent) approved by the Permitter is required if Permittee's vehicle enters Permitter property. The insurance must be in the name of the Permittee or its contractor entering the Permitter property with limits of liability in the amount specified in Schedule "A" for claims for bodily injuries (including death) to persons and for damage to property arising out of the ownership, maintenance or use of any owned, hired or non-owned motor vehicle.

(D) Railroad Protective Liability Insurance policy shall be required as specified in Schedule "A".

(E) Environmental/Pollution Exposures:

In the event environmental or pollution exposures exist, the Permittee shall require the environmental contractor or sub-contractor to provide the applicable insurance covering such exposure. The limits and type of insurance provided shall be satisfactory to the Permitter and will be confirmed to the parties prior to the start of the work.

(2) General Requirements Applicable To Insurance Policies:

- (a) All of the insurance required by this Article shall be with Companies licensed or authorized to do business in the State of New York with an A.M. Best Company rating of not less than A-/VII or better and reasonably approved by the Permitter/MTA and shall deliver evidence of such policies.
- (b) Except for Workers Compensation, all references to forms and coverages referred to above shall be the most recent used by the Insurance Services Office, Inc. (ISO") or equivalent forms approved by the Insurance Department of the State of New York, provided, however, that excess coverages may be written on forms reasonably acceptable to Permitter containing provisions other than those contained in ISO forms but otherwise conforming in substance to the requirements of this Article.
- (c) The Permittee or its Contractor performing the work shall furnish evidence of all policies before any work is started to the permitter:

For NYCT Contract Inspection  
C/O Mr. John Malvasio  
Director, MOW Engineering  
130 Livingston Street, Room 8044F  
Brooklyn, NY 11201  
Telephone: (718) 694-1358

These policies must: (i) be written in accordance with the requirements of the paragraphs above, as applicable; (ii) be endorsed in form acceptable to include a provision that the policy will not be canceled, materially changed, or not renewed, unless otherwise indicated herein, at least thirty (30) days prior written notice to the Permitter c/o MTA Risk and Insurance Management (MTA RIM) Department - Standards, Enforcement & Claims Unit, 2 Broadway - 21st floor, New York, NY 10004; and (iii) state or be endorsed to provide that the coverage afforded under the contractor's policies shall apply on a primary and not on an excess or contributing basis with any policies which may be available to the Permitter/MTA, and also



that the contractor's policies, primary and excess, must be exhausted before implicating any Permitter/MTA policy available. (iv) In addition, contractor's policies shall state or be endorsed to provide that, if a subcontractor's policy contains any provision that may adversely affect whether contractor's policies are primary and must be exhausted before implicating any Permitter/MTA policy available, contractor's and subcontractor's policies shall nevertheless be primary and must be exhausted before implicating any Permitter/MTA policy available. Except for Professional Liability, policies written on claims made basis are not acceptable. At least two (2) weeks prior to the expiration of the policies, contractor shall endeavor to provide evidence of renewal or replacement policies of insurance, with terms and limits no less favorable than the expiring policies. Except as otherwise indicated in the detailed coverage paragraphs below, self insured retentions and policy deductibles shall not exceed \$100,000, unless such increased deductible or retention is approved by Permitter/MTA. The Permittee shall be responsible for all claim expense and loss payments within the deductible or self-insured retention. The insurance monetary limits required herein may be met through the combined use of the insured's primary and umbrella/excess policies.

- (d) Certificates of Insurance may be supplied as evidence of policies of the above policies, except for Policy (D) Railroad Protective Liability Insurance Policy. However, if requested by the Permitter, the Permittee shall deliver to the Authority, within forty-five (45) days of request, a copy of such policies, certified by the insurance carrier as being true and complete. The Railroad Protective Liability Insurance Policy must be provided in the form of the Original Policy. A detailed Insurance Binder may be provided, ACORD or Manuscript Form, pending issuance of the Original Policy. The Original Policy must be submitted to MTA RIM within thirty (30) days of the Binder Approval.
- (e) If a Certificate of Insurance is submitted, it must: (1) be provided on the Permitter Certificate of Insurance Form or MTA Certificate of Insurance Form for Joint Agency Agreements; (2) be signed by an authorized representative of the insurance carrier or producer and notarized; (3) disclose any deductible, self-insured retention, sub-limit, aggregate limit or any exclusions to the policy that materially change the coverage; (4) indicate the Additional Insureds and Named Insureds as required herein, along with a physical copy of the Additional Insured Endorsement (I.S.O. Form CG 20 26 07/04 version or equivalent), as applicable and the endorsement(s) must include policy number(s); (5) reference the Contract by number on the face of the certificate; and (6) expressly reference the inclusion of all required endorsements.
- (f) The minimum amounts of insurance required in the detail description of policies (A), (B), (C), and (D) above shall not be construed to limit the extent of the Permittee's liability under this Agreement.
- (g) If, at any time during the period of this Agreement, insurance as required is not in effect, or proof thereof is not provided to the Permitter, the Permitter shall have the options to: (i) direct the Permittee to suspend work or operation with no additional cost or extension of time due on account thereof; or (ii) treat such failure as an Event of Default.

### (C) NYC TRANSIT CURRENT AND FUTURE PROJECTS

The Contractor is notified of the following:

- (1) The following subway lines are within the area of this project:
  - (a) The **IND A Train** is running along Rockway Freeway within the area of the above project
- (2) The Contractor can obtain NYC Transit Structural Drawings by contacting Mr. Vasanth K. Battu at (646) 252-3614.

The Contractor shall also obtain the following Drawing showing Power Engineering Activities for the area of this project:

- Drawing No. P-634 - Duct Assignment - Vicinity of Rockaway Park Station – rockaway

- (3) **Refer** to **Subsection 10.30 - Contractor To Provide For Traffic**, Page I-15:  
**Add** the following to **Subsection 10.30**:

- (1) Traffic Stipulations:

The Contractor shall refer to Traffic Stipulations identified in the maintenance of traffic requirements under Highway Contract No. SANDHW11.

- (4) **Refer** to **Subsection 40.02.15 - Disposal Of Water From Trenches**, Page IV-9:  
**Add** the following to **Subsection 40.02.15**:

(A) The Department of Design and Construction has **not** filed application for Dewatering Permit with the New York State Department of Conservation (NYSDEC), under the Environmental Conservation Law (ECL), Title 15 of Article 15, for a Temporary Well Point System Permit. However, it is anticipated that the criteria for rate of pumping specified herebefore in this section will be exceeded in areas of construction; the Contractor shall be responsible for applying and obtaining the necessary dewatering permit prior to the dewatering of trenches within the scope of this project.

As part of the permit application the Contractor will be required to comply with all the requirements of **Section 40.14** of this section.

Copies of all materials submitted to NYSDEC shall be sent to the New York City Department of Design and Construction (NYCDDC), Infrastructure/Design.

The following minimum requirements set forth by the New York Department of Environmental Conservation shall be complied with prior to the start of work in areas of construction requiring dewatering permit:

- (1) An analysis must be made of water samples taken. The results are to be submitted to the Regional Permit Administrator. An analysis shall be made for BOD, salinity, oil, and grease. The samples shall be analyzed by a laboratory certified by the New York State Health Department and the results are to be submitted directed to the New York State Department of Environmental Conservation by the laboratory.
- (2) Prior to setting any wells, wellpoints or header pipes, the Contractor shall submit to the NYSDEC a layout of the complete dewatering system including the location of the discharge point. When permitted by the NYSDEC, discharge of groundwater on the beach areas shall be done in such a manner as to eliminate any erosion or siltation and will require the installation of splash blocks and/or settling basins.

The Contractor is advised that all work required in obtaining a permit, must be submitted to, and approved by the NYSDEC prior to the commencement of any work in areas of construction requiring dewatering permit. No payment for any item of work will be made, and no shop drawing shall be approved for the areas of construction until such time that a written approval is obtained from the NYSDEC.

(B) The Contractor is advised that all work shall be governed by the provisions and requirements of the obtained permit, and their said provisions and requirements shall be made a part of the contract and the Contractor shall be responsible for strict adherence thereto.

The cost of all work required for applying, complying and obtaining required dewatering permits including the cost for any required updating of permits shall be deemed included in the prices bid for all item of this contract. No additional or separate payment will be made for any work required in order to comply with these requirements.

- (6) Refer to Page IV-34:  
Add the following new **Section 40.14**:

**SECTION 40.14  
DEWATERING PERMITS**

**40.14.1 DESCRIPTION**

Under this contract, and at locations where groundwater will be present in the trenches and excavations, the Contractor is required to install, maintain and operate a temporary dewatering system of sufficient size and capacity to control ground and surface water flow into the excavation and to allow all work to be accomplished in the "dry condition".

The Contractor shall be required to obtain the following permits in order to operate a temporary dewatering system.

- (A) A Dewatering/Discharge Permit from the New York City Department of Environmental Protection (NYCDEP);
- (B) A Long Island Well Permit from the New York State Department of Environmental Conservation (NYSDEC), under the Environmental Conservation Law (ECL), Title 15 of Article 15, implemented by 6NYCRR Part 601 - Water Supply and Part 602 - Long Island Well. This permit is required only in the Boroughs of Brooklyn and Queens to withdraw water using a well point or deep well system where the total capacity of such well or wells is in excess of 45-gallons per minute (or 64,800-gallons per day); and,
- (C) An Industrial State Pollutant Discharge Elimination System (SPDES) or a Non-Jurisdictional Determination Letter in compliance with Title 8 and 7 of Article 17 of the Environmental Conservation Law of New York State, respectively.

The Contractor is advised that the provisions and requirements of the aforementioned permits shall govern all work, and the said provisions and requirements are hereby made a part of the sewer contract and the Contractor shall be responsible for strict adherence thereto.

No dewatering work shall commence until the above-mentioned Permits have been obtained for this project.

The Contractor is advised that in order to comply with all the permits requirements, the Contractor will be required to submit maps, test data, etc. prior to the start of work. In order to expedite the processing of the permit and its requirements, the Contractor shall be required to obtain the services of an independent Environmental Scientist as herein described below in **Subsection 40.14.2** to perform this work and act as liaison with NYSDEC and NYCDEP.

**40.14.2 QUALIFICATIONS**

The Environmental Scientist utilized to perform the work required under this section must have adequate experience in work of this nature (obtaining Long Island Well Permit/Dewatering Permit) and must have previous experience in working with the NYSDEC and the NYCDEP, designing equivalent dewatering systems, and have successfully obtained the type of permits required under this contract. Prior to the start of work, the Contractor will be required to submit the name and resume of the Environmental Scientist for approval.

**40.14.3 NYSDEC DEWATERING PERMITS**

The dewatering system shall be designed by the Environmental Scientist using accepted and professional methods of design and engineering consistent with the best modern practices.

The material to be submitted shall include, but not be limited to the following:

- (1) Site Plan - Scaled, showing construction activity (e.g. excavation, pathway of the pipe, new outfalls, etc.) locations of well points, header pipes and pumps, and all staging and storage areas.

Also included herein shall be a layout of the complete dewatering system including the location of the discharge point. When permitted by the NYSDEC, discharge of groundwater on beach areas shall be done in such a manner as to prevent any erosion or siltation and will require the design and installation of splash blocks and/or settling basins.

- (2) Dewatering System Specifications:

- |                               |                             |
|-------------------------------|-----------------------------|
| (a) Number of Well Points     | (h) Total Volume Pumped     |
| (b) Diameter of Well Points   | (i) Number of Pumps         |
| (c) Spacing of Well Points    | (j) Capacity of Pumps       |
| (d) Length to Screen          | (k) Duration of Pumping     |
| (e) Depth to Bottom of Screen | (l) Initial and Average GPM |
| (f) Static Water Level        | (m) Estimated Daily Pumpage |
| (g) Drawdown Required         | (n) Flow Meter              |

- (3) Cross Section - Scaled, showing well points, riser, header, annular material (if used) and other equipment associated with each point. A typical construction style drawing may be utilized. Should the Contractor be permitted to use a deep well system, all information regarding it must be submitted.

- (4) Drawdown Contour Map - Based upon a review of the surrounding area affected by the dewatering and upon boring within the project area and characteristics of the soils, the depth and pumping rate of dewatering system and the duration of the pumping, the Environmental Scientist shall submit both a narrative and diagram showing the anticipated maximum cone of depression which shall be shown from both above and in cross section on scaled diagrams. Contour lines on diagrams shall be labeled to show depth from land surface.

- (5) Description of Site and Adjacent Areas - A short narrative shall be prepared describing the land use in the area paying attention to any potential sources of groundwater contamination that may migrate into the well's cone of depression, such as gas stations, chemical plants, wrecking yards, sanitary landfills, etc. Latest map of the area shall be included in the narrative.

- (6) Groundwater Analysis - The Environmental Scientist shall develop and submit a sampling and analysis program subject to NYSDEC Approval (a minimum of one groundwater sample from a site well shall be collected and analyzed). A laboratory certified by the New York State Health Department shall analyze the samples. The sampling and analysis program must include but is not limited to the following:

**NYSDEC REGION 2 - DEWATERING PROJECTS SAMPLING INFORMATION**

NO.	PARAMETERS	TYPE	EPA METHOD	DETECTION
1	pH	Grab	150.1	EPA min
2	Temperature	°F	After Pumping	EPA min
3	Fecal Coliform	Grab	5-Tubes/3-Dilutions	2-MPN/100-ml
4	Oil & Grease	Grab	413.1	EPA min
5	BOD5	Grab	405.1	EPA min
6	Total Suspended Solids	Grab	160.2	EPA min
7	Settleable Solids	Grab	160.5	EPA min
8	Chlorides	Grab	325.1-325.3	EPA min
9	Benzene	Grab	602	EPA min
10	Toluene	Grab	602	EPA min
11	Xylenes	Grab	602	EPA min
12	Ethylbenzene	Grab	602	EPA min

13	PCB's	Grab	608	(See Note 1)
14	Pesticides	Grab	608	EPA min
15	13 Priority Metals	Grab	200 series	EPA min
16	Acids Base/Neutrals	Grab	625-GC/MS	EPA min
17	Halogenated Volatiles	Grab	601-GC	EPA min
18	Nitrate/Nitrite	Grab	300 or 353.3	EPA min
19	Aromatic Volatiles	Grab	602-GC	EPA min
20	Cyanide (total or amenable)	Grab	335.1/335.2	EPA min

**NOTE:**

- (1) List each individual aroclor found and report the concentration of each aroclor tested. Use the N.Y.S. detection limit, which is 0.065-µg/l.

Small dewatering projects with a total estimated pumped volume up to 15-Million Gallons (MG) require sampling analysis for parameters No.'s 1 through 12.

Medium dewatering projects with a total estimated pumped volume between 15-MG and 60-MG require sampling analysis for parameters No.'s 1 through 14.

Large dewatering projects with a total estimated pumped volume greater than 60-MG require sampling analysis for parameters No.'s 1 through 20.

Samples are to be collected after development of the well by a licensed well driller.

A laboratory certified by the NYS Department of Health must conduct all testing.

Irrespective of the aforementioned sampling requirements based on total estimated pumped volumes, the Department may require sampling of additional parameters if the proposed dewatering site is suspected of being contaminated.

**40.14.4 SUBMISSION OF DEWATERING PLAN**

The Environmental Scientist will be required to submit two (2) copies of the Dewatering Plan (together with all reports, materials, designs, drawings, maps and plans) to the Infrastructure Engineering Support Unit for review and approval. Once approved the Environmental Scientist shall submit in triplicate the Final Dewatering Plan to both the NYSDEC and the NYCDEP. The Dewatering Plan should be bound and bear the name of the Contractor, NYSDEC Application Number and the Signature of the preparer. All drawings and maps shall be on sheets 27-inches by 40-inches and to scale not less than 1"=30'.

**40.14.5 DAMAGES**

The Contractor shall be responsible for and shall repair at no cost to the City any damage caused by inadequate or improper design and operation of the dewatering system, and any mechanical or electrical failure of the dewatering system.

**40.14.6 SYSTEM REMOVAL**

The Contractor shall remove all dewatering equipment and temporary electrical service from the site. All wells shall be removed or cut off a minimum of three (3) feet below the final ground surface and capped. Holes left from pulling wells or wells that are capped shall be grouted in a manner approved by the Engineer.

**40.14.7 PAYMENTS**

No additional or separate payment will be made for any work described herein. The costs for all labor, materials, equipment, permit fees, samples, tests, reports, services and insurance required or necessary to perform all the work described herein shall be deemed included in the price bid for all items of work.

- (7) Refer to **Subsection 71.41.4 - Specific Pavement Restoration Provisions**, Page VII-67:  
Add the following to **Subsection 71.41.4**:

(E) Specific Pavement Restoration Provisions:

- (1) Within the limits of the highway reconstruction the restoration shall be accomplished and paid for in accordance with Highway Construction Plans, Details and Specifications for Highway Project ID. SANDHW11.
- (2) in Beach Channel Drive between Beach 116th Street and Beach 124th Street and adjacent streets including Cronston Avenue, Beach 116th Street, and Rockaway Beach Boulevard, the restoration shall be as follows:
  - (a) The permanent restoration over the **trench width and cutbacks only** shall consist of a top course of one and one-half (1-1/2) inches of asphaltic concrete wearing course on a base course of a minimum of four and one-half (4-1/2) inches of binder mixture, or a top course of one and one-half (1-1/2) inches of asphaltic concrete wearing course on a minimum of one and one-half (1-1/2) inches of binder mixture on a base course of a minimum of six (6) inches of concrete, to match the existing pavement as directed by the Engineer.
- (3) The following requirements apply:
  - (a) Before the top course is installed, an additional width of asphalt beyond the edge of new base course shall be saw-cut and removed from all edges of trenches to a depth to accommodate the specified top course and the entire area restored. This additional removal shall be in accordance with paragraph (b) below.
  - (b) Pavement excavation along with saw cutting of pavements for sewer and water main trenches shall be in accordance with **Section 71.21 - Pavement Excavation** of the Standard Sewer And Water Main Specifications.
  - (c) At locations requiring the installation of a concrete base course, a reflective cracking membrane shall be installed over joints prior to restoration, the cost of which shall be deemed included in the prices bid for all pavement restoration items. Additionally, appropriate pavement keys as described below shall be used.
  - (d) Pavement keys **Type B-1** shall be used to insure a desired four (4) inch curb reveal (two and one-half (2-1/2) inch absolute minimum). Pavement key **Type A** shall be used in all intersections. Both keys are to be per Department Of Transportation Specifications and Standard Details of Construction.
  - (e) Unless otherwise specified, the cost for Proctor analyses, in-place soil density tests, tack coating, eradication of temporary roadway markings, stripping or milling of pavement keys and adjustment of city-owned castings for all roadway work shall be deemed included in the prices bid for all pavement restoration items.
  - (f) Payment for placement of temporary pavement marking shall be made under Item No. 6.49 - TEMPORARY PAVEMENT MARKINGS (4" WIDE).

- (g) Payment for removal of existing pavement markings shall be made under Item No. 6.53 - REMOVE EXISTING LANE MARKINGS (4"WIDE).
- (h) Payment for placement of permanent pavement marking with thermoplastic reflectorized pavement markings (crosswalk and lane dividers) shall be made under Item No. 6.44 - THERMOPLASTIC REFLECTORIZED PAVEMENT MARKINGS (4" WIDE).
- (i) Payment for pavement restoration shall be made under the following items:

<u>Item No.</u>	<u>Item</u>	<u>Payment Description</u>
4.02 AB-R	Asphaltic Concrete Wearing Course, 1-1/2" Thick	(For asphaltic concrete wearing course top course when <u>no</u> overlay is required.)
4.02 CB	Asphaltic Concrete Mixture	(For binder mixture base course over trenches and cutbacks; binder mixture top filler course under asphaltic concrete wearing course when <u>no</u> overlay is required; binder mixture top course when overlay is required; binder mixture in Type A and B Keys; and binder mixture to fill in roadway depressions and to provide a leveling course prior to overlay where ordered.)
4.04 H	Concrete Base For Pavement, Variable Thickness For Trench Restoration, (High-Early Strength)	(For concrete base course over trenches and cutbacks.)

**C. REVISIONS TO THE SPECIFICATIONS FOR TRUNK MAIN WORK**

- 1) **Refer** to Part 1 – Furnishing And Delivering Steel Pipes And Appurtenances 30 Inches In Diameter And Larger, Section 11. Fabrication:, Page 4;  
**Add** the following to Section 11:

All steel water mains shall be spiral welded pipes, and all steel water main fittings shall be fabricated from qualified spiral welded pipe. Can type pipe is not acceptable.

- 2) **Refer** to Part 1 – Furnishing And Delivering Steel Pipes And Appurtenances 30 Inches In Diameter And Larger, Section 13. Special Fittings:, Page 5;  
**Add** the following to Section 13:

The steel reducer shall have a length of seven (7) feet for every twelve (12) inches reduction in diameter.

**END OF SECTION**

**This Section consists of thirteen (13) pages.**



**NO TEXT ON THIS PAGE**

**EP7 - PAGES**

**GAS COST SHARING (EP-7)  
STANDARD SPECIFICATIONS**

---

**NOTICE**

THE PAGES CONTAINED IN THIS SECTION (EP7-PAGES) REPRESENT THE GAS COST SHARING WORK THAT SHALL APPLY TO AND BECOME A PART OF THE CONTRACT.

(NO TEXT ON THIS PAGE)

TABLE OF CONTENT**I - NOTICE TO ALL BIDDERS; GAS COST SHARING WORK****II - GENERAL PROVISIONS; GAS COST SHARING WORK**

1. General
2. Gas Interferences And Accommodations
  - 2a. Water Main Accommodations
  - 2b. Sewer Accommodations
3. Quantity Overruns, EP-7 Funded Bid Items
4. Changes And Extra Work
5. Excavation
6. Backfilling And Street Restoration
7. Non-Responsive Bids
8. Minimum Clearances
9. Work By Facility Operator
10. Materials Furnished By Facility Operator
11. Liability And Insurance
12. Width And Depth Of Excavation
13. Depth And Crossing Angles Of Gas Facilities
14. Maintenance Of Traffic For Gas Work
15. Relocated Gas And Temporary Systems Installation
16. Role Of Company Inspector
17. Coordination With Gas Company

**III - TECHNICAL SECTION**

- SECTION 6.01 - Trench Crossings; Support And Protection Of Gas Facilities And Services.
- SECTION 6.02 - Extra Excavation For The Installation Of Catch Basin Sewer Drain Pipes With Gas Interferences.
- SECTION 6.02.1 - Extra Excavation For The Installation Of Catch Basin Sewer Drain Pipes With Upstream Inverts Greater Than Six (6) Feet.
- SECTION 6.03 - Removal Of Abandoned Gas Facilities. All Sizes.
- SECTION 6.03.1 - Removal Of Abandoned Gas Facilities With Possible Coal Tar Wrap. All Sizes. (For National Grid Work Only)
- SECTION 6.03.1a - Removal Of Abandoned Gas Facilities With Possible Coal Tar Wrap. All Sizes. (For Con Edison Work Only)
- SECTION 6.04 - Adjust Hardware To Grade Using Spacer Rings/Adaptors. (Street Repaving.)
- SECTION 6.05 - Adjust Hardware To Grade By Resetting. (Road Reconstruction.)
- SECTION 6.06 - Special Care Excavation And Backfilling.
- SECTION 6.07 - Test Pits For Gas Facilities.
- SECTION 6.09 - Trench Excavation and Backfill for New Gas Mains and Services (For National Grid Work Only)
- SECTION 6.09a - Trench Excavation and Backfill for New Gas Mains and Services (For Con Edison Work Only)

**IV - STANDARD SKETCHES; GAS COST SHARING WORK**

- NO. 1 - Support Requirements For Gas Mains And Services Crossing Excavation Greater Than 4'-0" Wide At Any Angle
- NO. 1A - Support Requirements For Gas Mains Over 16" Diameter Up To And Including 48" Diameter Crossing Excavation At Any Angle
- NO. 2 - Typical Methods Of Measurement For Gas Crossings
- NO. 3 - Utility Crossings During Catch Basin Chute Connection Pipe Installation
- NO. 4 - Utility Crossings During Catch Basin Chute Connection Pipe Installation (Extra Depth)
- NO. 5 - Gas Main Encroachment On And/Or Parallel To Excavation Of Unsheeted Trench

**V - PRELIMINARY GAS WORK TO BE PERFORMED BY FACILITY OPERATOR**

**VI - LISTING OF APPROXIMATE LOCATIONS OF EP-7 BID ITEMS QUANTITIES**

## I - NOTICE TO ALL BIDDERS; GAS COST SHARING WORK

All prospective bidders are hereby advised that, pursuant to the "Gas Facility Cost Allocation Act", ("the Act"), the City of New York has entered into an agreement ("the Agreement") with the gas companies (Con Edison or National Grid (formerly KeySpan Energy Delivery)) operating in their respective areas of the City to "share" the cost of facility relocation and/or support and protection of facilities disturbed by proposed water and/or sewer and related City work specified in this contract. Therefore, bid items, specifications and estimated quantities for the incremental costs of support and protection of certain gas facilities have been included in this contract. The low bid for this contract shall be determined by examining each bid for all work to be performed under this contract including any work of support and protection of gas facilities to be performed. The Contractor shall not seek additional compensation from gas companies except as specifically set forth in its contract.

## II - GENERAL PROVISIONS; GAS COST SHARING WORK

### 1. General:

The Contractor shall perform City work with interferences from existing live and abandoned gas facilities. This shall be defined as utility work. Therefore, this contract includes bid items, specifications and estimated quantities designed to fully compensate him/her for the incremental costs of supporting, protecting, providing accommodations and, avoiding disturbing gas facilities located in the streets shown on the contract drawings. In the event that any other provisions of this contract related to gas facilities (or private utilities) conflict with these provisions, these provisions shall supersede and govern all work related to gas facilities owned by the companies operating in the project area. All utility work, as defined in these specifications, including changes and additions thereto shall be paid solely by the City except when specified otherwise in this contract. Contractor hereby agrees that the facility operator shall not be liable to pay him/her for any work performed including extra utility work. Contractor agrees that its bid prices include all compensation for loss of productivity and efficiency, idle time, delays (including any delays occasioned by negotiation of a contract change), change in operations, mobilization, demobilization, remobilization, added cost or expense, lost of profit, other damages or impact costs that may be suffered by or because of utility work, or the presence of gas facilities in the proximity of City work and that it will not seek additional compensation for these items. All disputes shall be resolved as specified in the contract.

Pursuant to the Act, Agreement, and the New York City Administrative Code, the gas company(ies) has been directed by the Commissioner and is required to perform all maintenance, repairs, replacement, shifting, alteration, relocation, and/or removal work that are not part of this contract. By having bid on this contract, the Contractor understands and agrees that the Commissioner has preasserted any right the City has to require, including the issuance of any directives or so called "order outs" under the New York City Administrative Code, any or all gas companies to maintain, repair, replace, protect, support, shift, alter, relocate, and/or remove all gas facilities that are about to be disturbed by the City contract work. The issuance of additional such directives during the performance of the contract work, where necessary in the sole judgment of the Commissioner, shall be initiated by such Commissioner as set forth in the relevant sections of the Act and Agreement. Contractor further agrees to insert such requirements as set forth herein above into any contracts with its approved subcontractors so that its subcontractors also understand and agree to such contract requirements.

### 2. Gas Interferences And Accommodations:

During the performance of sewer and water main work funded by the New York City Department of Environmental Protection (NYCDEP), as instructed by the Engineer, the use of any applicable contract bid item is allowed in order to resolve and accommodate all gas facilities interferences with such City work, including the removal of contaminated soil in associated trench excavation. This is in addition to the specified EP-7 bid items in the contract. Payment for such accommodation shall be funded by EP-7 bid item "UTL-GCS-2WS - GAS INTERFERENCES AND ACCOMMODATIONS" (F.S. Fixed Sum). The value of such accommodation shall be computed by multiplying the appropriate unit prices bid to the quantity of work performed, as determined by the Engineer, and applying the total amount thus to be paid

to EP-7 bid item "UTL-GCS-2WS - GAS INTERFERENCES AND ACCOMMODATIONS". When EP-7 bid item "UTL-GCS-2WS - GAS INTERFERENCES AND ACCOMMODATIONS" does not exist, such additional accommodation work shall be at no cost to the City but shall be a matter of adjustment between gas facility operator and Contractor. Private facilities, other than gas, that become in interference due to gas interferences accommodations shall also be accommodated, if so directed by the Resident Engineer, at no additional cost to the City and, provided that its owner agrees to be responsible for all additional costs to Contractor, otherwise, such facility shall be ordered by the City to be maintained, shifted, relocated or replaced by its owner at his/her expenses.

#### **2a. Water Main Accommodations:**

When water main construction is to be performed in this contract, Contractor shall be required, if warranted by field conditions, and at locations designated by the Resident or Borough Engineer, to change the vertical or horizontal alignment of water mains including but not limited to all additional labor, material, work method accommodations, furnishing, delivering and laying offset fittings and pipes, etc., necessary in order to complete water main installation and, avoid gas interferences in the project area, including street intersections. Typical work method accommodations shall include, but not be limited to, pier and plate, installation of filter fabric and select fill, etc. Such work shall be performed as directed by the Engineer and in accordance with contract specifications and latest edition of water mains standards and specifications.

#### **2b. Sewer Accommodations:**

When sewer construction is to be performed in this contract, Contractor shall be required, if warranted by field conditions, and at locations designated by the Resident or Borough Engineer, to change the horizontal alignment of sewer facilities (if possible) including but not limited to all additional labor, material, work method accommodations, furnishing, delivering and construction of additional manholes or modification of manholes/catch basins, extending chute connections, house connections, using alternate materials and methods, poured-in-place structures, etc., necessary in order to complete sewer installation and, avoid gas interferences in the project area, including street intersections. The term sewer facility shall include, but not be limited to, all sewer pipe and appurtenances, manholes, catch basins, catch basin chutes, etc. Such work shall be performed as directed by the Engineer and in accordance with contract specifications and latest edition of sewer standards and specifications.

#### **3. Quantity Overruns, EP-7 Funded Bid Items:**

No quantity overrun, in excess of one hundred twenty five (125) percent, shall be permitted for EP-7 funded bid items (gas) included in this contract, except when Resident Engineer determines that such overruns are caused by field modifications to planned City work, or approved construction methods, or contract scope changes. Overruns not paid by City shall be negotiated and paid to Contractor by gas facility operator who then shall be entitled to reimbursement by NYCDEP under established cost sharing procedures.

#### **4. Changes And Extra Work:**

This section is not applicable to work defined under "Emergency Reconstruction Contracts" or so-called "Where and When Contracts" since these projects, by definition, inherently encounter unanticipated gas facilities and cannot be pre-engineered. In all other cases, any contract changes proposed for City work shall also cover and include all associated changes to support and protection of gas facilities affected by such changes to City work. In all other cases where the Contractor finds that City work cannot be performed as planned and specified and/or, as approved because of a need to support, protect and/or alleviate interferences from gas facilities that were not listed and/or shown, or incorrectly shown in contract plans and specifications, he shall immediately notify the Resident Engineer and the facility operators' representative of his findings. Resident Engineer shall promptly examine such claims and determine whether or not such work is covered by contract bid items and /or specifications (contract bid items and specifications shall include city contract items as well as EP-7 items). The Resident Engineer shall also

examine the claim to determine if the application of EP-7 bid item "UTL-GCS-2WS - GAS INTERFERENCES AND ACCOMMODATIONS" is appropriate to resolve the claim. If upon examination, the Engineer determines that such field conditions were unanticipated (not shown and/or listed, or incorrectly shown in contract documents) and are not covered by bid items and contract specifications, he shall then direct the Contractor and the affected facility operator to negotiate the cost of supporting and protecting, and/or alleviating the impact on City work caused by such unanticipated gas facilities with each other with the understanding that the performance of City work shall continue during negotiations. If a cost agreement is reached, the Contractor and facility operator shall adjust such costs between themselves at no additional costs to the City contract. If the Contractor and affected facility operator do not reach an agreement concerning the price to be paid for the extra work within five (5) business days of the Engineer's directive to engage into such negotiations and, after considering: public safety and inconvenience, requirements of laws and regulations applicable to private utilities, integrity of all utility systems, including but not limited to sewer and water, gas, electric, telephone and, cable TV facilities, sound engineering practices, cost (long and short term) to all affected parties, and potential City work delays, then the Resident Engineer, depending on nature and severity of interferences with City work, shall either, direct the facility operator to relocate or replace its facilities at its own discretion and cost, reimbursable by NYCDEP under established gas cost sharing procedures or, direct the Contractor to perform the utility work on actual time, material and equipment costs basis pursuant to relevant contract requirements and amendments. Contract bid prices for any applicable items of work involved shall be applied, or converted to an allowance for time and material charges. Changes shall be for affected portions of utility work and, shall be processed with EP-7 funds.

#### **5. Excavation:**

All excavators shall notify the NYC/LI One Call Center at 1-800-272-4480 at least two (2) working days, not including the day of the call, but not more than ten (10) working days in advance of the start of any excavation work. The gas company(ies) will mark out its facilities within the project limits and provide Construction Inspector(s) during all excavation work in close proximity (within twelve (12) inches) to gas facilities. The Contractor shall exercise extreme caution when excavating in the vicinity of any gas facilities. Hand excavation shall be performed within twelve (12) inches of gas facilities. The Contractor prior to excavating underneath these facilities shall adequately support all gas facilities. Standard support details for gas facilities have been included in the specifications. Any damage to gas facilities shall be reported immediately to the gas company(ies). The Contractor shall be responsible for all cost associated with repairs made necessary by damages caused by his operations.

#### **6. Backfilling And Street Restoration:**

Backfilling operations and street restorations shall be in accordance with contract requirements.

#### **7. Non-Responsive Bids:**

Every gas (EP-7) bid item has a suggested "Not less than" value per unit indicated on contract bid sheet. Bids resulting in cost of less than suggested for EP-7 items are hereby prohibited and if submitted shall be considered NON-RESPONSIVE.

#### **8. Minimum Clearances:**

Clearance requirements for City work shall govern and supersede any clearance requirement of gas facility operator. Therefore, a minimum of twelve (12) inches clearance between private utilities and City water mains, sewers or related structures to be installed in this contract shall be maintained. When this clearance is not attainable, the Resident Engineer may allow a minimum of four (4) inches clearance. With less than twelve (12) inches clearance a neoprene/polyethylene shield (to be provided by facility operator) shall be installed as part of all work item specifications. However, if Resident Engineer determines that City work cannot be performed within allowable clearance and no reasonable City accommodation (no-cost change to City work) is possible, the City shall direct the facility operator to remove, relocate, shift, or alter their facility(ies) pursuant to the New York City Administrative Code.



**9. Work By Facility Operator:**

The facility operator may find it necessary to perform the following types of work during performance of City work: accommodating a contractor's request for gas facilities modifications (in order to facilitate City contractor's proposed construction method) or, remedial and emergency work on gas facilities proper with their own resources and materials if an approved method of construction for City work causes unanticipated disturbances to gas facilities or, replacing defective gas facilities when they are exposed by the Contractor and their actual conditions are observable by the facility operator. Also included in the above category of defective gas facilities are: the presence of environmental contaminants attributable to the gas facility in or around gas facilities. If such work is deemed required by the facility operator or if facility operator is directed by the City to address such deficiencies at any time during the course of construction, the Contractor shall modify the construction schedule at no cost to the City and allow the facility operator five (5) business days to perform such work without interferences. Additional costs to the facility operator (in cases of accommodations) or, Contractor (in cases of defective gas facilities) due to such gas work, if any, shall be the responsibility of the parties involved and not of the City. Such costs shall be a matter of adjustment between the Contractor and the facility operator.

**10. Materials Furnished By Facility Operator:**

It shall be the Contractor's responsibility to inspect material to be installed by him immediately upon delivery and advise the facility operator through its authorized representative, of all damaged materials. The Contractor at no additional costs to the City or the facility operator shall replace any material that is damaged or lost after the Contractor's inspection.

**11. Liability And Insurance:**

Notwithstanding the provisions of this contract, the existing division of liabilities to third parties shall remain the same as between the City and the company. Therefore, it is specifically agreed by the City, company and Contractor (by bidding on this contract) that for the purpose of any liabilities to third parties, that the City contractor performing work directly and physically relating to gas company facilities in this project, shall be deemed an agent of the company and not an agent of the City, the New York City Municipal Water Finance Authority, or the New York City Water Board. Contractor shall include the company as an additional insured on all insurance policies maintained to comply with the City's insurance requirements.

**12. Width And Depth Of Excavation:**

Contractor shall not be authorized to deliberately change trench or excavation widths and/or depth specified without Engineer's approval. Enlargement of any side of excavation up to eighteen (18) inches beyond pay limits (or inside face of sheeting) requested by the Contractor for the installation of certain types of sheeting may be granted. However, such enlargements or those greater than allowable shall not be approved when, in the sole judgment of the City, field conditions allow the water mains and sewer work to be performed within the limits specified and, the sole purpose of such enlargement request is to impact adjacent utilities (public or private) whose support and protection are part of this contract. Any approval shall be given at no additional cost to the City contract, including EP-7 funding, and all costs associated with unauthorized enlargements shall be the sole responsibility of the Contractor.

**13. Depth And Crossing Angles Of Gas Facilities:**

Where gas facilities are shown (or specified as) crossing proposed alignment of sewers, water mains, catch basins and chute connections or any other proposed excavations at specific angles (as measured off plans or sketches or specified in contract), it shall be understood that actual field measurements may deviate (plus or minus) forty-five (45) degrees from those shown or specified. The cover, or depth from street surface to top of facilities, shall be as shown or specified in contract documents, no deviation is to be assumed. Where gas facilities are not shown on contract documents, but their support and protection are otherwise included in this contract then, all references to facilities crossing at "various angles and depth" in the gas sections shall mean that such facilities are crossing sewer, water, catch basin and, catch basin chute, and other excavations at a ninety (90) degree angle to the proposed sheeting line or side of

excavation (for unsheeted trenches) with an allowable deviation of forty-five (45) degrees in any direction, except for catch basin chute excavation where the allowable deviation shall be sixty (60) degrees. Where the cover is not noted or specified, the bottom face of such facilities shall be assumed to be crossing catch basin chutes at a depth of three (3) foot eight (8) inches or less from the street surface. Paragraph No. 2 above shall apply in cases of distribution water main construction. Appropriate bid items and specifications are provided for cases where angle and depth are greater than stated above. This section also applies to work defined in "Emergency Reconstruction Contracts" or so-called "Where and When Contracts". These contracts are not pre-engineered and consequently have no drawings, sketches or determined locations and so, gas facilities encountered will be crossing existing and proposed sewer, water, catch basin/catch basin chutes and all appurtenances at various angles and depths.

**14. Maintenance Of Traffic For Gas Work:**

All work pertaining to gas bid items and specifications shall be performed within the contract maintenance of traffic plan as specified in the contract document. The bid price for the Maintenance and Protection of Traffic shall cover all work pertaining to gas items. The City shall make compensation for additional maintenance and protection of traffic items in connection with gas item of work only when such additional work is deemed reasonable and necessary by the Resident Engineer and is approved by him prior to its performance.

**15. Relocated Gas And Temporary Systems Installation:**

In cases where the Contractor is allowed to select the location for temporary construction such as, installation of dewatering headers, wells, well points, etc., he shall not disturb any gas facilities shown on sketches provided in this section. The only exception shall be, if the affected gas company agrees to such relocation and provided that the cost of such relocation is a matter of adjustment between the company and Contractor, and at no cost to the City.

**16. Role Of Company Inspector:**

In any case in which the City elects to perform some or all support and protection work with its own employees, personnel or contractors, the facility operator shall provide onsite inspectors to approve and certify such support and protection work (exclusive of City accommodations) performed by the City's own employees, personnel, and contractors. Facility operator's inspectors are not authorized to direct City contractor during the performance of contract work. They shall act through the City Resident Engineer and provide him/her required approvals and certifications, prior to preparing partial payments of EP-7 items, in a format and frequency to be prescribed by the appropriate City Head of Construction.

**17. Coordination With Gas Company:**

The Contractor shall be required to notify the gas company(ies), in writing, at least two (2) weeks prior to the start of final paving in order to allow companies to complete any unfinished gas work located within the area to be paved. Every effort shall be made to maintain gas service with minimum inconvenience to the public.

**III - TECHNICAL SECTION**

**SECTION 6.01 - Trench Crossings; Support And Protection Of Gas Facilities And Services.**

1. Description:

Under this section, the Contractor shall provide all labor, materials, equipment, and incidentals required to

support and/or protect the integrity of gas mains, services and appurtenances of any sizes, configurations, and operating pressures crossing trench excavations above subgrade for planned construction of sewers and water mains facilities. A gas service shall be defined as a gas pipe of three (3) inches in diameter or less branching from the main to a customer pick up point or property valve box. A gas main may be any size pipe that is part of a distribution or transmission network other than services described above. Crossings shall be defined as gas facilities spanning the width of excavation (one side to the other side). These crossings may be at various angles and depth as shown on "Gas Cost Sharing Work Standard Sketches Nos. 1 and 1A", and as specified in "General Provisions; Gas Cost Sharing Work Paragraph No. 13" and, at the locations shown or listed in contract documents. The gas company operating in the area, (facility operator), owns these facilities. The work shall be performed in accordance with contract specifications, plans, and at the directions of the Resident Engineer in consultation with the authorized representatives of the facility operator.

## 2. Method Of Construction:

- A. Protection: In general, the gas facilities shall be protected as required by New York State Industrial Code 753. In particular, the Contractor shall use hand excavation methods (pick and shovel or hand held power tools) directly below the pavement base to expose the gas facilities (marked out by facility operators) and to ascertain the clearances and cover of the facilities with respect to the proposed excavation. Upon exposing the affected facilities sufficiently, at the discretion of the Resident Engineer, to ascertain the foregoing, Contractor shall be permitted to proceed with a combination of hand and machine excavation, as appropriate, outside a zone of protection whose limit shall be defined as a perimeter located twelve (12) inches from the outside face of each gas facility crossings (See "Gas Cost Sharing Work Standard Sketch No. 2"). If the facilities are in direct interference with City work, meaning that "Minimum Clearances" described in "General Provisions; Gas Cost Sharing Work Paragraph No. 8" cannot be maintained, and excavation has to be temporarily or permanently abandoned then this particular location shall become a test pit and dealt with as specified in Section 6.07, and "General Provisions; Gas Cost Sharing Work Paragraphs Nos. 2 and 8".
- B. Support: Gas mains or services crossing excavations equal or less than four (4) feet wide are generally self supporting, unless field conditions as determined by the Resident Engineer require otherwise. The support requirements for gas mains and services crossing excavations greater than four (4) feet wide shall be as shown on the attached "Gas Cost Sharing Work Standard Sketch No. 1" and Contractor shall use sheeting methods that permit the maintenance of gas facilities in their existing locations and configurations. Alternate methods equivalent to those shown on the sketch or accommodations by the facility operator proposed by the Contractor in order to facilitate the execution of the specified work shall be allowable, provided that prior approval is obtained by the Contractor from the Engineer and the facility operator. The support and protection of gas facilities crossings shown on plans, drawings, listings or otherwise identified in this contract shall not be circumvented with the issuance of so called "order outs".

## 3. Method Of Measurement:

The Contractor shall be paid for supporting and/or protecting gas facilities crossing trench excavations under the appropriate bid items covered by this section. The Contractor shall be directly responsible to the facility operator for the total cost of using any alternate method requiring the use of resources owned by the facility operator. Regardless of the method used, the City shall pay the bid price for the appropriate support and/or protect item of work. The average rate charged by the facility operator for alternate support and protection work such as, disconnecting and reconnecting gas services is listed in attached "Schedule GCS-A".

## 4. Payment Restrictions:

These items shall not be paid for: gas services crossing unsheeted water main trench excavation; abandoned gas main/services identified by facility operator; gas mains/services crossing trench excavations for fire hydrant branch connections pipes, catch basins and/or chutes (sewer drain pipe), house sewer and/or water services; gas facilities encroaching any face of excavation for sewer and/or

water construction, all of which are covered under other contract sections. Also this item shall not be paid for new gas mains and services crossing water trenches when trenching for such new facilities has been performed by the Contractor in common with trench excavation for City work (overlapping trench limits). The cost of supporting and protecting such gas facilities crossings shall be deemed included in the cost of trench excavation for the new gas facilities. This payment restriction shall apply even if such common trench gas excavation is not part of the contract. The prices bid for items covered by this section represent full compensation to Contractor to completely perform the work described. No other bid items shall be combined with these items in order to pay for gas main and/or services crossing excavations specified herein.

5. Method Of Payment:

Each (Ea.) gas facility crossing trench excavation as described in these specifications shall be counted for payment.

6. Price To Cover:

The cost of timber/steel supports installed for gas facilities shall be included in the bid price. The bid price for each crossing shall also cover all additional supervision, labor, material (except those provided by the facility operator), equipment and insurance necessary to completely maintain the gas facilities without disruption of service to the customers and in accordance with contract plans, specifications and facility operator standards. The price shall also include: changes of method of operations; sheeting modifications where necessary to accommodate the gas facilities crossings; installation and removal of water pipe under gas facilities (so called "snaking"); extra care during excavation (including hand excavation under existing single and multiple gas facilities); extra backfilling and compaction around, over and under gas facilities; installation and removal of sheeting around gas facilities; associated maintenance and protection of traffic; barricades; and traffic plates that may be required to temporarily close and/or complete the work.

**SECTION 6.02 - Extra Excavation For The Installation Of Catch Basin Sewer Drain Pipes With Gas Interferences.**

1. Description:

Under this item, the Contractor shall provide all labor, materials, equipment, insurance, and incidentals for the extra excavation associated with the installation of catch basin sewer drain pipes (chute) under gas facilities of various sizes crossing the trench excavation at various angles and depth at the locations shown in the contract documents and also; for the support and protection of these facilities during associated excavation and backfill operations. The gas company operating in the area, (facility operator), owns these facilities.

2. Method Of Measurement:

The bid price shall be per location (Each) where extra excavation is required when catch basin sewer drain pipes are installed at an upstream invert depth lower than four (4) feet (up to a maximum of six (6) feet) from the proposed pavement grade because the bottom faces of interfering gas mains and appurtenances are located at a depth greater than three (3) foot eight (8) inches from proposed pavement surface (See "Gas Cost Sharing Work Standard Sketch No. 4").

3. Method Of Construction:

Incremental cost responsibility for chute excavation is determined by the first private facility encountered starting from catch basin structure proper and that prevents the installation of the chute connection at an upstream cover less than or equal to three (3) feet or any other minimum cover required to avoid City facilities (e.g. water, sewer, etc.) as directed by the Resident Engineer.

4. Payment Restrictions:

This item shall not apply and related bid item shall not be paid in cases where:

- A. Upstream invert chute is more than six (6) feet deep because of gas facilities.
- B. Chute cannot be installed above existing gas facilities because of interferences with other private facilities that are not otherwise covered under this contract, regardless of upstream invert depth.

The above cases shall be at no cost to the City, but shall be a matter of adjustment between the Contractor and the facility operator(s).

5. Price To Cover:

The bid price shall cover the additional cost of all additional supervision, labor, materials, equipment and insurance, to complete the installation of catch basins and associated sewer connections in accordance with the contract plans and specifications. The price shall include: excavation by hand around and under single and multiple gas facilities; locating, supporting and protecting gas facilities; backfilling and all other items necessary to perform all work incidental thereto including: installation and removal of drain pipe under gas facilities ("snaking"); widening of trenches to facilitate the above work; subsequent additional backfill and pavement restoration; modifying precast catch basin window to accommodate connection; changing sheeting method and configuration to accommodate gas facility crossings; maintenance and protection of traffic; barricades; and installation of traffic plates that may be required to temporarily close and/or complete the work. The price shall not include removal of ledge rock and/or excavation of boulders in open cut.

**SECTION 6.02.1 - Extra Excavation For The Installation Of Catch Basin Sewer Drain Pipes With Upstream Inverts Greater Than Six (6) Feet.**

1. Description:

Under this item, the Contractor shall provide all labor, materials, equipment, insurance and incidentals for the extra excavation of catch basin chutes where the upstream invert is greater than six (6) feet under gas facilities of various sizes crossing the trench excavation at various angles and depth at the locations shown in the contract documents or as determined by field conditions and also, for the support and protection of these facilities during the associated excavation, sheeting and backfilling operations.

2. Method Of Measurement:

The bid price shall be per location (Each) where extra excavation and sheeting is required when the catch basin chute installed at an upstream invert depth lower than six (6) feet from the proposed pavement grade because the bottom faces of the interfering gas mains and appurtenances are located at a greater depth than three foot eight inches from the proposed pavement surface only.

3. Method Of Construction:

Incremental cost responsibility for chute excavation is determined by the first private facility encountered during such excavation when initiated from catch basin structure and that prevents the installation of the chute at an upstream cover less than or equal to three (3) feet or any other cover required to avoid City facilities as directed by the Resident Engineer.

4. Payment Restriction:

This item shall not apply and related bid item shall not be paid in cases where:  
Upstream invert chute is less than or equal to six (6) feet deep because of gas facilities. Section 6.02 shall be paid.

5. Price To Cover:

The bid price shall cover the additional cost of all supervision, labor, materials, equipment and insurance to complete the installation of catch basin and associated sewer connections in accordance with the contract plans and specifications. The price shall include: excavation by hand around and under single and multiple gas facilities; locating, supporting and protecting gas facilities incidental thereto; widening of trenches to facilitate the above work; subsequent additional backfilling and pavement restoration; modifying pre-cast basin window to accommodate connection; the installation of catch basin with deeper sumps as specified; additional sheeting and changes in sheeting method and configuration to accommodate gas facility crossings; maintenance and protection of traffic; barricades; and installation of traffic plates that may be required to temporarily close and/or complete the work.

**SECTION 6.03 - Removal Of Abandoned Gas Facilities. All Sizes.**

1. Description:

Under this section the Contractor shall provide all labor, materials, equipment, insurance and, incidentals required for the removal of abandoned gas mains, services, or appurtenances thereof, located within the street shown on the contract plans, owned by gas company operating in the project area (facility operator), used or to be used for or in connection with or to facilitate the conveying, transportation, distribution or furnishing of gas (natural or manufactured or mixture of both) for light, heat, or power, but does not include property used solely for or in connection with business of selling, distributing or furnishing of gas in enclosed containers. Such removal shall include only abandoned gas facilities that interfere with (i.e. cause additional work) City work.

2. Determination Of Operating Status Of Gas Facilities:

The Contractor shall notify facility operator, as required by New York State Industrial Code 753. Gas facilities shall not be removed without the approval of the facility operator whose authorized representative shall certify in writing (specific facility or area wide facilities certification) and in a timely manner acceptable to the Resident Engineer that abandoned facilities are free of combustible gas and any other environmental contaminants prior to removal. The Resident Engineer shall rely on facility operator's certification. The facility operator may request the excavation of test pits (See Section 6.07) for this determination ahead of City work and, Contractor shall provide safe access, facilitate and permit facility operator to enter test pit excavations for the purpose of testing gas facilities to be removed by the Contractor. However, facility operator may prefer to make this test during performance of City work, in order to issue the above certification. This shall be permitted provided that it is agreed that additional costs, if any resulting from this choice shall be a matter of adjustment between the Contractor and facility operator only, and at no cost to the City.

3. Restrictions:

The facility operator shall be solely responsible for its contaminated gas facilities, surrounding contaminated soil and their disposal and abatement procedures, unless contract bid items are applicable and provided for such work. In such cases, the quantity removed shall be charged to EP-7 bid item "UTL-GCS-2WS - GAS INTERFERENCES AND ACCOMMODATIONS" at the City bid prices.

4. Method Of Measurement:

Abandoned gas pipeline removal shall be measured for payment per linear foot of pipe and appurtenances removed.

5. Price To Cover:

The price shall cover all additional cost of supervision, labor, materials, equipment, and insurance necessary to complete this work in accordance with the contract plans and specifications, including excavation by hand around and under other City and facility operator owned properties and, where necessary, support and protection of such properties. The price shall also cover breaking, cutting, and/or burning of abandoned gas pipes and their disposal from the site; sealing open ends remaining in the excavation with concrete or caps (caps to be provided by the facility operator) and backfilling of the area where the pipeline has been removed with clean backfill. The price shall also include any required dump charges. This item does not include any type of extra excavation, backfilling, compaction, pavement removal and restoration associated with abandoned gas facilities removal, all of which are covered under Section 6.06.

### **SECTION 6.03.1 - Removal Of Abandoned Gas Facilities With Possible Coal Tar Wrap. All Sizes. (For National Grid Work Only)**

#### **1. Description:**

Under this section the Contractor shall provide all labor, materials, equipment, insurance and, incidentals required for the removal of abandoned gas mains, services or appurtenances thereof, located within the street shown on the contract plans, owned by the gas company operating in the project area (facility operator), used or to be used for or in connection with or to facilitate the conveying, transportation, distribution or furnishing of gas (natural or manufactured or mixture of both) for light, heat, or power, but does not include property used solely for or in connection with business of selling, distributing or furnishing of gas in enclosed containers. Such removal shall include only abandoned gas facilities that interfere with (i.e. cause additional work) City work. These gas facilities may be coated with Coal Tar Wrap and so, may require special handling and disposal methods as specified in National Grid Standard Operating Procedure 12-2, Coal Tar Wrap Handling and 12NYCRR56.

#### **2. Determination Of Operating Status Of Gas Facilities:**

The Contractor shall notify facility operator, as required by New York State Industrial Code 753. Gas facilities shall not be removed without the approval of the facility operator whose authorized representative shall certify in writing (specific facility or area wide facilities certification) and in a timely manner acceptable to the Resident Engineer that abandoned facilities are free of combustible gas and any other environmental contaminants prior to removal. The Resident Engineer shall rely on the facility operator's certification. The facility operator may request the excavation of test pits (See Section 6.07) for this determination ahead of City work and, the Contractor shall provide safe access, facilitate and permit facility operator to enter test pit excavations for the purpose of testing gas facilities to be removed by the Contractor. However, the facility operator may prefer to make this test during performance of City work, in order to issue the above certification. This shall be permitted provided that it is agreed that additional costs, if any, resulting from this choice shall be a matter of adjustment between the Contractor and the facility operator only, and at no cost to the City contract. Should such investigation result in the determination that the abandoned gas facilities do not contain Coal Tar Wrap then the removal of said facilities shall be covered under separate item (See Section 6.03).

#### **3. Requirements:**

The City Contractor shall excavate abandoned gas facility sufficiently, either in its entirety, or at locations determined by Contractor to allow the removal of Coal Tar Wrap (if present on the abandoned gas facility) and to facilitate the safe extraction of manageable lengths of abandoned pipe without damage to adjacent facilities, utilities or City structures either parallel to or crossing above or below abandoned gas facility. The Contractor is to allow access to the designated cutting points within the Contractor's trench by authorized National Grid personnel who will remove the Coal Tar Wrap as per National Grid procedures. This work by National Grid personnel shall be performed in a timely fashion and shall not unduly impede the Contractor's progress and/or productivity. Upon completion of the coating removal, the Contractor shall be allowed to cut, burn or grind the gas facility and remove the section of abandoned pipe. The

Contractor at a site designated by the Contractor shall stockpile the removed pipe. The facility operator will be responsible to provide trucking and disposal services with its own personnel and shall remove the stockpiled pipes during off hours or during such time as agreed to by the Contractor. Since the pipe removed will remain the property of the facility operator and is to be disposed of by the facility operator, the facility operator shall be responsible for any required notifications, filings, dump charges and incidentals associated with the disposal of abandoned gas facilities found to contain Coal Tar Wrap.

4. Method Of Measurement:

Abandoned gas pipeline removal shall be measured for payment per linear foot of pipe and appurtenances removed.

5. Price To Cover:

The price shall cover all additional cost of supervision, labor, materials, equipment and insurance necessary to complete this work in accordance with the contract plans and specifications, including excavation by hand around and under other City and facility operator owned properties and, where necessary, the support and protection of such properties. The cost shall also include hand excavation in the area(s) of proposed abandoned pipe cut(s), cutting and/or burning of abandoned gas pipes and stockpile of removed sections of abandoned pipe and associated maintenance and protection of traffic, blocking and temporary fencing if required. The unit price shall also cover sealing open ends remaining in the excavation with concrete or end caps (end caps to be provided by the facility operator) and backfilling of the area where the abandoned pipeline has been removed with clean backfill material. This item does not include any type of extra excavation, backfilling, compaction, pavement removal and/or restoration (temporary and permanent) associated with abandoned pipe removal ("lost trench"), all of which are covered under separate Section 6.06. The price shall also include allowance for any loss of productivity by the Contractor due to required facility operator work to remove pipe coating and prepare pipe for cutting as well as any change in Contractor's excavation method, additional trucking and/or stockpiling costs.

**SECTION 6.03.1a - Removal Of Abandoned Gas Facilities With Possible Coal Tar Wrap.  
All Sizes. (For Con Edison Work Only)**

1. Description:

Under this section the Contractor shall provide all labor, material, equipment, insurance and, incidentals required to prepare abandoned gas mains, services and appurtenances thereof located within the street shown on contract plans, owned by the gas company operating in the project area (facility operator), for removal due to interference with proposed City work. These abandoned gas facilities were, at one time, used for or in connection with or to facilitate the conveying, transportation, distribution or furnishing of gas (natural, manufactured or a combination of both) for light, heat, or power, but does not include property used solely for or in connection with business of selling, distribution or furnishing of gas in enclosed containers. Such preparation for removal shall include only abandoned gas facilities that interfere with (i.e. cause additional work) City work. These gas facilities may be coated with Coal Tar Wrap which may contain asbestos or PCB's and so, may require special handling and disposal methods as specified in Con Edison - ASBESTOS MANAGEMENT MANUAL, CHAPTER 6 - ASBESTOS WORK PROCEDURES, SECTION 06.04 - COAL TAR WRAP REMOVAL. For under 25' (feet) in length and an approved NYC-DEP variance for over 25' (feet).

2. Determination Of Operating Status Of Gas Facilities:

The Contractor shall notify facility operator, as required by New York State Industrial Code 753. Gas Facilities shall not be removed without the approval of the facility operator whose authorized representative shall certify in writing (specific facility or area wide facilities certification) and in a timely manner acceptable to the Resident Engineer that abandoned facilities are free of combustible gas and any other environmental contaminants prior to removal. The Resident Engineer shall rely on the facility



operator's certification. The facility operator may request the excavation of test pits (See Section 6.07) for this determination ahead of City work and Contractor shall provide safe access, facilitate and permit facility operator to enter test pit excavations for the purpose of testing gas facilities. However, the facility operator may prefer to make this test during performance of City work in order to issue the above certification. This shall be permitted provided that it is agreed that additional costs, if any, resulting from this choice shall be a matter of adjustment between the Contractor and the facility operator only, and at no cost the City contract. Should such investigation result in the determination that the abandoned gas facilities do not contain Coal Tar Warp then the removal of said facilities shall be covered under separate item (See Section 6.03).

### 3. Requirements:

The Contractor shall excavate abandoned gas facility sufficiently, either in it's entirety, or at locations determined by Contractor to allow the removal of Coal Tar Wrap (if present on the abandoned gas facility) and to facilitate the safe extraction of manageable lengths of abandoned pipe without damage to adjacent facilities, utilities or city structures either parallel to or crossing above or below abandoned gas facility. The Contractor is to allow access to the designated cutting points within the Contractors trench by authorized Con Edison personnel who will remove the Coal Tar Wrap as per Con Edison and/or NYC-DEP approved procedures. This access shall conform to all applicable codes, rules & regulations. This work by Con Edison personnel shall be performed in a timely fashion and shall not unduly impede the Contractors progress and/or productivity. Upon completion of the coating removal, the Contractor shall be allowed to cut, burn or grind the gas facility and remove the section of abandoned pipe. Contractor shall designate a specific site to stockpile those removed pipes. The facility operator will be responsible to provide trucking and disposal services with its own personnel and shall remove the stockpiled pipes during off hours or during such time as agreed to by the Contractor. Since the pipe removed will remain the property of the facility operator and is to be disposed of by the facility operator, the facility operator shall be responsible for any required notifications, filings, dump charges and incidentals associated with the disposal of abandoned gas facilities found to contain Coal Tar Wrap.

### 4. Method Of Measurement:

Abandoned gas facility removal shall be measured for payment per linear foot of pipe and appurtenances removed.

### 5. Price To Cover:

The price shall cover all additional cost of supervision, labor, materials, equipment and insurance necessary to complete this work in accordance with the plans and specifications, including, but not limited to, excavation by hand around and under other City and facility operator owned properties and, where necessary, the support and protection of such properties. The cost shall also include hand excavation in the area(s) of proposed abandoned pipe cut(s), cutting and/or burning of abandoned gas pipes and stockpile of removed sections of abandoned pipe and associated maintenance of traffic, blocking and temporary fencing if required. The unit price shall also cover sealing open ends remaining in the excavation with concrete or end caps (end caps to be supplied by facility operator) and backfilling of the area where the abandoned pipeline has been removed with clean backfill material. This item does not include any type of extra excavation, backfilling, compaction, pavement removal and/or restoration (temporary and permanent) associated with abandoned pipe removal ("lost trench"), all of which are covered under separate Section 6.06. The price shall also include allowance for any loss of productivity by the Contractor due to required facility operator work to remove pipe coating and prepare pipe for cutting as well as any change in Contractor excavation method, additional trucking and/or stockpiling costs.

## **SECTION 6.04 - Adjust Hardware To Grade Using Spacer Rings/Adaptors. (Street Repaving.)**

### 1. Description:

Under this section, the Contractor shall provide all labor, supervision, materials, equipment, insurance and incidentals required to adjust to final grade gas street surface hardware located within the contract area boundaries shown on the plans. The gas company operating in the area, (facility operator), owns these facilities. The work shall be performed in accordance with the contract plans, specifications and at the directions of the Resident Engineer in concurrence with authorized representative of the facility operator.

2. Materials:

The facility operator shall furnish and deliver all prefabricated hardware parts required. These include adaptors for the grade adjustment proper and new street hardware if existing ones are found to be defective, all in accordance with the facility operator standards and City rules and regulations. The Contractor shall notify the facility operator of the installation schedule at least three (3) business days before materials are required on the site. Should the facility operator fail to deliver the necessary material according to any schedule mutually agreed upon by the Contractor and facility operator, the City shall not be responsible for any delays attributable thereto, nor for the failure of delivery of such materials. On project where material storage is not permitted on site, the facility operator shall deliver the required material to the Contractor's yard and it shall be the Contractor's responsibility to transport the material to the work site when needed for installation. It shall also be the Contractor's responsibility to inspect the materials to be installed by him immediately upon delivery and advise the facility operator through its authorized representative, of all damaged materials. The Contractor at no additional expense to the City or the facility operator shall replace any material that is damaged or lost after the Contractor's inspection.

3. Method Of Measurement:

The Contractor shall be paid for each six (6) inch round box and/or nine (9) inch square box adjusted to grade regardless of adjustment height requirements.

4. Price To Cover:

The unit price bid for this item shall include all additional labor, supervision, insurance, equipment and material (except those to be provided by the facility operator), required to adjust each box to grade as required in the contract plans and specifications. The bid price shall also include the removal of existing frames and covers from existing facilities to be salvaged and returned to the facility operator and, all material transportation from the Contractor's material storage yard to the work site. In addition the bid price shall include "chipping" around existing box using appropriate means and methods where grinding is required.

**SECTION 6.05 - Adjust Hardware To Grade By Resetting. (Road Reconstruction.)**

1. Description:

Under this item, the Contractor shall provide all labor, supervision, materials, equipment, insurance and incidentals required to adjust to the proposed grade gas street surface hardware located within the contract area boundaries shown on the plans. The gas company operating in the area, (facility operator), owns these facilities. The work shall consist of either building up or lowering or resetting the casting by removing the existing frame and cover building up or decreasing the existing installation, replacing the frame and/or cover if damaged or worn out, as determined by the Resident Engineer, with a new frame and/or cover furnished by the owner, and setting the frame and cover to new elevation. The work shall be performed in accordance with the contract plans, specifications and at the directions of the Resident Engineer.

2. Materials:

The facility operator shall furnish and deliver all new hardware parts required. The Contractor shall furnish materials such as mortar, bricks and concrete in compliance with contract requirements. At locations

where high-early strength concrete is required under this contract to be placed adjacent to gas facilities, then the requirement for concrete shall be high-early strength complying with the current New York State Department of Transportation, Standard Specifications for Class F concrete. Existing castings may be replaced as required and deemed necessary by the Engineer and by City rules and regulations. The Contractor shall install the new castings of various sizes furnished by the facility operator. The Contractor shall notify the facility operator of the installation schedule at least three (3) business days before materials are required on the site and, shall provide off-loading services to the facility operator. Should the facility operator fail to deliver the necessary material according to any schedule mutually agreed upon by the Contractor and facility operator, the City shall not be responsible for any delays attributable thereto, nor for the failure of delivery of such materials. Such delays shall be a matter of adjustment between the Contractor and the facility operator. On project where material storage is not permitted on site, the facility operator shall deliver the required material to the Contractor's yard and it shall be the Contractor's responsibility to transport the material to the work site when needed for installation. It shall also be the Contractor's responsibility to inspect the materials to be installed by him, immediately upon delivery and advise the facility operator through its authorized representative, of all damaged materials. The Contractor at no additional expense to the City or the facility operator shall replace any material that is damaged or lost after the Contractor's inspection.

### 3. Methods Of Construction:

The Contractor shall remove and reinstall existing castings or install new castings to the proposed grade. Setting and resetting the castings shall be done with mortar and brick according to the standards of the facility operator. Work shall be performed in a workmanlike manner. Castings that are deemed unacceptable for resetting shall remain the property of the facility operator and he shall be responsible for their removal and proper disposal from site. No traffic shall be allowed on adjusted street hardware until permitted by the Engineer.

### 4. Method Of Measurement:

The Contractor shall be paid for each gas hardware adjusted to grade regardless of size or adjustment height requirements (up or down).

### 5. Price To Cover:

The unit price bid for this item shall include all additional labor, supervision, insurance, equipment and material (except those to be provided by the facility operator), required to adjust each gas hardware to grade as required in the contract plans and specifications. The bid price shall also include the removal of existing frames and covers from existing facilities; building up the existing installations with bricks and mortar, or lowering the existing installation by removing bricks and mortar; replacing damaged frames and/or covers with new frames and/or covers furnished by the facility operator; setting the frames and covers to the new elevations; protect existing installations; repair minor structural damages to existing installations prior to resetting frames; unloading of furnished castings at the Contractor's yard and transporting castings from the Contractor's yard to the job site as required; completing the work in accordance with the contract plans, specifications and, at the directions of the Engineer. In addition the bid price shall include "chipping" around existing gas facilities using appropriate means and methods where grinding is required.

## **SECTION 6.06 - Special Care Excavation And Backfilling.**

### 1. Description:

Under this section, the Contractor shall provide all labor, materials, equipment, insurance and incidentals required to support and protect the integrity of live gas facilities including mains, services, related structures and appurtenances during excavations. The gas company operating in the area, (facility operator), owns these facilities. The work shall be performed in accordance with the contract plans, specifications and at the directions of the Resident Engineer in consultation with authorized

representatives of the facility operator.

## 2. Applicability Of Section:

This section shall apply to live gas facilities of various sizes located within two (2) feet of any face of unsheeted excavation, (unsheeted excavation refers to any excavation performed for city work and includes excavations performed that are to be subsequently sheeted using approved methods) and paralleling or, encroaching any face of excavation. Also, for crossings greater than forty-five (45) degrees and/or located at a cover depth greater than five (5) feet from existing street surface. Parallel facilities are not exposed at any time during excavation (See "Gas Cost Sharing Work Standard Sketch No. 5"). Encroaching facilities are partially exposed inside the limit of excavation (See "Gas Cost Sharing Work Standard Sketch No. 5"). This section shall also apply to gas facilities crossing catch basins excavation, and catch basins sewer connections (chutes) trench excavation only when extra depth (covered in other section), is not required for chutes installations because of such utilities interferences (See "Gas Cost Sharing Work Standard Sketch No. 3"). This section shall also apply to gas services (if shown or otherwise listed in contract documents) crossing unsheeted excavations for water mains, gas facilities crossing fire hydrant branch connections, house sewer and/or water service connections excavations. This section shall also apply for so called "loss trench", as described further, and for additional excavation (pavement and/or soil), backfilling, compaction, roadway base and pavement restoration due to abandoned gas facilities, only if removed by Contractor. If operating status of gas facilities cannot be determined prior to excavation then such facilities shall be considered live and this section shall fully apply. The excavation around fully exposed live gas facilities along and within limits of excavation (not crossings) shall be covered by this section also (not shown on "Gas Cost Sharing Work Standard Sketch No. 5"), however the support requirement, if any is required, of such facilities is beyond the scope of these specifications and therefore shall be the responsibility of facility operator to determine and prescribe, at no cost to the City contract, but shall be a matter of adjustment between the Contractor and facility operator.

## 3. Payment Restriction:

No special care excavation shall be paid for abandoned gas facilities paralleling and/or encroaching excavation and therefore are not in direct interference with City work. Except as allowed in this section, the bid item specified under this section shall not be used in combination with items covered under other sections for work done due to a particular gas facility. This item shall not be paid for new gas facilities when trenching for such new facilities has been performed by the Contractor of record in common with trench excavation for City Work (overlapping trench limits). The cost of excavating with care as defined in this section shall be deemed included in the cost of trench excavation for the new gas facilities. This restriction shall apply even if such gas common trench excavation is not part of the contract. If facilities are in direct interference with City work, meaning that "Minimum Clearances" described in "General Provisions; Gas Cost Sharing Work Paragraph No. 8" cannot be maintained and excavation has to be temporarily or permanently abandoned then this particular location shall become a test pit and dealt with as specified in Section 6.07 and "General Provisions; Gas Cost Sharing Work Paragraphs Nos. 2 and 8".

## 4. Method Of Construction:

All excavation in the vicinity of gas facilities shall be as required by NYS Industrial Code 753. Where these facilities are paralleling and located two (2) feet or less from the limits of the proposed excavation, the Contractor shall use hand excavation methods (pick and shovel or hand held power tools) to ascertain the clearances of these facilities with respect to the proposed excavation. Once the location of these facilities with respect to the proposed excavation is verified to the satisfaction of the Resident Engineer, the Contractor shall then proceed with a combination of hand and machine excavation as required preserving the integrity of the facilities. The installation of timber supports or underpinning, when soil foundation cannot fully support partially exposed pipes, may be required to prevent pipe movement as directed by the Resident Engineer.

## 5. Method Of Payment:

The unit price for this work item shall be based on cubic yard (CY) of average excavation with care and, is

to be considered as an incremental cost for performing City work with gas facilities interferences.

#### 6. Method Of Measurement:

- A. For Paralleling Facilities: Volume calculated as: Depth as measured from existing street surface to the bottom of unsheeted trench excavation allowable by OSHA regulations, multiplied by, the width measured as one (1) foot from the face of excavation toward the center of excavation, multiplied by the length of parallel facility, divided by twenty-seven (27) cubic feet per cubic yard (See "Gas Cost Sharing Work Standard Sketch No. 5"). The gas facility is no longer considered to be in interference once sheeting has been installed, therefore no further compensation for paralleling facilities as described above will be made.
- B. For Encroaching Facilities: Volume calculated as: Depth of trench as allowable by OSHA, maximum up to five (5) feet multiplied by, the width of partially exposed pipe plus one (1) foot, multiplied by the length of facility encroachment, divided by twenty-seven (27) cubic feet per cubic yard (See "Gas Cost Sharing Work Standard Sketch No. 5").
- C. Fully Exposed Gas Facilities: (Not shown on "Gas Cost Sharing Work Standard Sketch No. 5") along and inside trench and/or crossing trench at an angle greater than forty-five (45) degrees and/or a cover depth greater than five (5) feet from the existing street surface. The volume shall be measured as the depth of trench excavation multiplied by the distance measured along the sheeting line between two (2) points of intersections of the gas facilities and the sides of trench excavation, multiplied by the width of trench excavation.
- D. For Additional Excavation And Restoration Due To So Called "Loss Trench", When The Integrity Of Pavement And Soil Above And Around Existing Live Gas Facilities Cannot Be Maintained Due To Its Lack Of Cohesiveness: Volume shall be calculated as: Depth of unsheeted trench excavation multiplied by width measured as distance of facility from closest edge of unsheeted excavation plus, width of facility proper plus, one (1) foot or a maximum width of three (3) feet multiplied by length of facility fully exposed divided by, twenty-seven (27) cubic feet per cubic yard (not shown on "Gas Cost Sharing Work Standard Sketch No. 5").
- E. For Facilities Crossing Excavation For Catch Basins, Or Chutes Installations (When NYCDEP Funded) Or Fire Hydrant Branch Connections, Or Unsheeted Water Main Trench, Or House Sewer And/Or Water Services: Volume calculated as: Depth as measured from existing street surface to the bottom of the trench excavation multiplied by, the width taken as the outside diameter of pipe or the width of structure plus one (1) foot on either side (two (2) feet), multiplied by, the length of exposed facility crossing the trench, divided by twenty-seven (27) cubic feet per cubic yard (not shown on "Gas Cost Sharing Work Standard Sketch No. 5").

Overlapping volume dimensions measured as described above may occur when multiple facilities are paralleling excavations, encroaching excavations or crossing catch basins and catch basin chute installations. In such cases, all such facilities shall be counted as one limited by the extreme pipes, faces (See "Gas Cost Sharing Work Standard Sketch No. 2"). The volume shall then be calculated as described above.

#### 7. Price To Cover:

The bid price shall also cover all additional supervision, labor, material, equipment and insurance necessary to excavate while protecting and maintaining (excluding supports for fully exposed live gas) gas facilities without disruption of service to the public and in accordance with contract specifications. The price shall also include, changes of sheeting method and excavation width configuration where necessary to accommodate gas facilities in their existing locations; difficulties during the installation of catch basins, chute connections, hydrant branch, and house sewer and water connections under or over gas facilities; loss of productivity due to slower rate of excavation (special care) during excavation, including the use of such methods as: hand excavation around existing single and multiple facilities, extra excavation and backfilling due to lost trench because of existing and adjacent gas facilities, compaction, removal of

sheeting from the facilities, extra roadway base restoration and temporary pavement, associated maintenance and protection of traffic, barricades, and traffic plates that may be required to temporarily close and/or complete the work.

## **SECTION 6.07 - Test Pits For Gas Facilities.**

### 1. Description:

Under this section, the Contractor shall furnish all labor, materials, insurance, equipment and appliances necessary to excavate, sheet and, maintain test pits at locations approved by the Resident Engineer in consultation with the facility operator. Test pits shall be dug in order to ascertain exact locations, cover and invert elevations, clearances, alignment and operating status (live or dead) of existing gas facilities. The Contractor shall inspect jointly with the Resident Engineer and facility operator, gas facilities and other structures uncovered, take all relevant measurements and elevations as directed by the Resident Engineer. Tests to determine operating status of gas facilities shall be performed by facility operator. The pits shall be covered with steel plates during daytime nonworking hours, and uncovered, as required, until the inspection work is completed. Testing of gas facilities may require a maximum of four (4) hours. Then, the pits shall be backfilled with clean fill, and resurfaced with temporary pavement. All traffic shall be maintained and all safety measures as stipulated shall be complied with.

### 2. Methods Of Construction:

- A. Excavation: Existing pavement to be removed shall be neatly cut along lines of removal with a saw or other approved equipment which leaves a neat straight joint line along the juncture with subsequently replaced pavement. Excavation in the vicinity of utilities and other structures shall be performed using hand tools. Use of hand operated pneumatic and electric jackhammers will be permitted only for breaking pavement and removal of masonry, concrete and boulders, or as otherwise directed by the Resident Engineer. The Contractor shall properly dispose of all materials excavated from test pits away from site. Test pits shall be excavated at locations shown on the contract drawings or as directed by the Resident Engineer. Additional test pits may be required and shall be excavated where required, as ordered by the Resident Engineer. All test pits shall be excavated to a depth and size necessary to locate the existing facilities. Sheeting shall be used when depth of excavation exceeds five (5) feet. The sheeting required shall be furnished and installed in full compliance with the State of New York and Federal Safety Codes requirements and as specified in contract, whichever is more stringent. Care shall be taken that no existing gas facilities or other structures are broken or damaged. All broken or damaged facilities shall be reported immediately to facility operator who shall decide whether such facilities shall be repaired or replaced by company forces or by City contractor and in conformance with "General Provisions; Gas Cost Sharing Work Paragraph No. 9". Contractor shall excavate all material encountered, including large masses of concrete, cemented masonry and boulders, as directed by the Resident Engineer. Any type of excavation protection used, shall satisfy the following:

- (a) Industrial Code Rule 753.
- (b) Prevent injury to workers and the public, and avoid damage to existing water, sewer, and gas pipes or other structures, and to pavements and their foundations, through caving or sliding of the banks of the excavation.

Should it become necessary, as determined by the Resident Engineer, to enlarge any test pit in any dimension after sheeting has been placed, the Contractor shall remove portions of the sheeting, as necessary, enlarge the test pits as directed, and replace the sheeting without additional compensation for this work other than for the additional volume of material excavated.

- B. Maintenance Of Test Pits: Excavated test pits shall be maintained free of debris and kept dry by the Contractor in order to permit the inspection and measurements and to determine the locations of facilities. In order to accomplish this, Contractor shall, upon completion of excavation and placement of sheeting (if depth greater than five (5) feet), furnish and install adequate steel plates and posting

over the excavated pits and shall temporarily remove all equipment debris and workers, and relocate barricades in order to open the full width of street to traffic during nonworking hours. The Contractor shall then, at no additional cost, relocate such barricades, barrels, cones and other warning devices and remove steel plates, as and when directed by the Resident Engineer to facilitate the inspection of exposed facilities. When work is being performed and the pits are not covered with steel plates, the Contractor shall provide complete and safe access to the test pits as may be required, and he shall provide construction barricades and maintain traffic at all times as shown or as directed by the Resident Engineer. Upon completion of test pit inspection by the Resident Engineer, the pit shall be backfilled by the Contractor as specified in contract, except that backfill material shall conform to contract specifications for such purpose.

- C. Pavement And Sidewalk Restoration: After backfilling is completed, the Contractor shall construct a temporary pavement consisting of a minimum of four (4) inches thick asphaltic concrete mixture in roadway areas or a two (2) inches thick asphaltic concrete mixture in sidewalk areas in order to maintain existing pedestrian and vehicular traffic. This temporary pavement shall be maintained until permanent pavement and sidewalk replacement is constructed as specified in contract.

3. Measurements:

The quantity to be measured for payment shall be the number of cubic yards of material removed from within the limits of the pit dimensions as directed by the Resident Engineer. The volume occupied by existing pipes or other structures remaining within the maximum payment lines will not be deducted from the total volume measured except, where the cross sectional area of these facilities exceeds four (4) square feet. As determined by the Resident Engineer, the quantity measured for payment may be proportionate to a fair and reasonable estimate of gas responsibility in the total volume excavated.

4. Price To Cover:

The contract price bid per cubic yard for test pits shall cover all additional costs of labor, material, insurance, equipment, appliances and incidentals required to excavate test pits, including removal and disposal of excavated materials, sheeting, steel plating, backfill, compaction and temporary pavement and sidewalk restoration all in accordance with the specifications and as directed by the Resident Engineer. The price shall also include the cost of providing safe access to the excavation by facility operator for the performance of certain test to determine operating status of gas facilities prior to City work. The price shall also include support and protection of all gas facilities crossing excavation, paralleling and/or encroaching any face of excavation.

**SECTION 6.09 - Trench Excavation and Backfill for New Gas Mains and Services  
(For National Grid Work Only)**

1. Description:

Under this section, the contractor shall furnish all labor, materials, equipment, insurance, permits and incidentals required to break/remove roadway and sidewalk pavement, excavate, backfill and restore gas trenches. The trench to be excavated shall be determined by the size of the gas facility to be installed. The work shall be performed in accordance with applicable specifications, and/or at the direction of the Resident Engineer in consultation with the facility operator.

2. Materials:

All materials used to excavate and prepare trenches shall be supplied by the Contractor and be approved by the facility operator in consultation with the Resident Engineer.

3. Method of Construction:

Excavation – The Contractor shall saw cut and/or break and remove existing roadway which may include

but is not limited to, asphalt, concrete and cobblestone, utilizing approved equipment that leaves a neat straight joint line along the juncture with subsequently replaced pavement. Prior to starting the trenching operation, the contractor shall excavate the appropriate gas main tie-in pits at the extremities of the gas main sections to be replaced. Test pits shall be excavated to determine exact location of all tie-in pits and at appropriate intervals along proposed trench excavation to verify lane and clearances as shown on the contract plans. The tie-in pits shall be adequately protected by the contractor using wood fencing or steel traffic plates until such time when the facility operator has completed the tie-in work. The Contractor shall be permitted to excavate utilizing a combination of machine and hand excavation, as field conditions warrant, and as directed by the facility operator. The trench shall be adjusted so as to provide for a nominal cover on the new gas facilities or as required based on field conditions, applicable specifications, or as directed by the facility operator in consultation with the Resident Engineer. The width of the trench shall be as directed by the facility operator in consultation of the Resident Engineer. The bottom of the trench shall be graded smooth with a minimum cushion of 3 inches of clean sand and in conformance with applicable specification and be compacted, to minimize initial settlement and to avoid "point" support of new gas facilities. All stones projecting into the trench bottom shall be removed, and the voids backfilled before the new gas facilities are installed. Where streets are not to final grade, the cover shall be measured from the final grade, or the existing grade, whichever provides the deeper trench. Excavation in the vicinity of utilities and other structures shall be performed using hand tools. The contractor shall properly dispose of all materials excavated away from site. Size and location of excavation shall be as directed by the facility operator in consultation with the Resident Engineer. Trenches shall be excavated to a depth and size necessary to facilitate the installation of the new gas facility and in conformance with the applicable specification. All existing facilities that are encountered during trench excavating shall be protected in a manner suitable to the facility operator in consultation with the Resident Engineer. Tight sheeting shall be used, as required, based on field conditions and/or when the depth of excavation is equal to or greater than five feet. Skeleton type sheeting will not be permitted. The sheeting required shall be furnished and installed in full compliance with the State of New York and Federal Safety Code requirements and in compliance with applicable specifications and/or as directed by the facility operator in consultation with the Resident Engineer. Care shall be taken that no existing gas facilities or other structures are broken or damaged. Contractor shall excavate all material encountered necessary to facilitate the installation of the new gas facilities, and as directed by the facility operator. Care should be taken to avoid damage to existing utility facilities and structures, and to pavements and their foundations, and to avoid caving or sliding banks within the excavation.

**Maintenance of Trench Excavation** - Excavated trenches shall be maintained free of debris and kept dry by the contractor. In order to accomplish this, contractor shall, upon completion of excavation and placement of sheeting (as required and/or if depth is equal to or greater than five feet), furnish and install adequate steel plates, as directed by the facility operator in consultation with the Resident Engineer, and posting over the excavated trenches and shall temporarily remove all equipment debris and workers, and relocate barricades in order to open the full width of street to traffic during non-working hours, as required based on DOT requirements. National Grid forces will perform all live gas main connections, dead gas main cut-outs, and/or service work associated with disconnecting and reconnecting from old to new gas main. The Contractor shall then, at no additional cost, relocate such barricades barrels, cones and other warning devices and remove steel plates, as and when directed by the facility operator in consultation with the Resident Engineer to facilitate the installation of the new gas facilities. When work is being performed and the excavations are not covered with steel plates, the Contractor shall provide complete and safe access to the trench as may be required, and shall provide construction barricades and maintain traffic at all times as shown or as directed by the facility operator in consultation with the Resident Engineer. The contractor has the responsibility to maintain and set to grade all National Grid hardware during backfill and pavement restoration. Upon completion of installation of the new gas facility, the trench excavation shall be backfilled by the contractor in accordance with Contract requirements and all backfill material shall conform to contract specifications for such purpose.

**Pavement and Sidewalk Restoration** - After backfilling is completed, the contractor shall install temporary pavement consisting of six inches (6") thick asphaltic concrete mixture in roadway areas or a two inches (2") thick asphaltic concrete mixture in sidewalk areas in order to maintain existing pedestrian and vehicular traffic. This temporary pavement shall be maintained until permanent replacement as specified in contract. Permanent pavement restoration shall be as required by the appropriate contract



specifications and as directed by the Resident Engineer.

4. Method of Measurement:

The quantity to be measured for payment shall be the number of cubic yards (C.Y.) of trench actually excavated, including roadway pavement, base and/or sidewalk concrete removed within the limits of the trench as directed by the Resident Engineer in consultation with the facility operator. The volume occupied by existing pipes or other structures will be deducted from the total volume measured as shown on contract drawing(s) Title: EP-7 SECT. 6.09 GAS SPECIALTY CONTRACTOR WORK, or as encountered based on existing field conditions.

5. Price to Cover:

The unit price bid per cubic yard for excavation shall include the cost of all supervision, labor, material, equipment, insurance and incidentals necessary to complete excavation trenches, including backfill, compaction testing and restoration of trenches and tie-ins pits as specified or shown on the contract, plans. The bid price shall also include the cost of coordinating the sewer and water main work to be performed by the contractor with the gas installation work to be performed by others. The price shall also include, associated maintenance of traffic, and traffic plates and openings and closings of plates as may be required in order to provide access to the facility operator during the new gas facility installation, and installing, removing and maintaining tight sheeting that may be required, cut, break and remove various thickness of surface and base pavement, excavate by hand, furnish, place and compact, in compliance with DOT requirements, clean sand backfill following installation of the gas facility. Any required removing, trucking, storing, and disposing of material shall be deemed included in the unit price. The price shall also include the cost of providing temporary pavement restoration. Permanent pavement restoration shall be deemed included in this item, as required and as directed by the Resident Engineer.

**SECTION 6.09a Trench Excavation and Backfill for New Gas Mains and Services  
(For Con Edison Work Only)**

1. Description:

Under this section, the contractor shall furnish all labor, materials, equipment, insurance, permits and incidentals required to break/remove roadway and sidewalk pavement, excavate, backfill and restore gas trenches. The trench to be excavated shall be determined by the size of the gas facility to be installed. The work shall be performed in accordance with applicable specifications, and/or at the direction of the Resident Engineer in consultation with the facility operator.

2. Materials:

All materials used to excavate and prepare trenches shall be supplied by the Contractor and be approved by the facility operator in consultation with the Resident Engineer. Clean sand backfill material shall be used and shall conform to Con Edison specification EO-1181-rev.6, General Specification for Backfilling of Trench and Small Openings.

3. Method of Construction:

Excavation – The Contractor shall saw cut and/or break and remove existing roadway which may include but is not limited to, asphalt, concrete and cobblestone, utilizing approved equipment that leaves a neat straight joint line along the juncture with subsequently replaced pavement. Prior to starting the trenching operation, the contractor shall excavate the appropriate gas main tie-in pits at the extremities of the gas main sections to be replaced. Test pits shall be excavated to determine exact location of all tie-in pits and at appropriate intervals along proposed trench excavation to verify lane and clearances as shown on the contract plans. The tie-in pits shall be adequately protected by the contractor using wood fencing or steel traffic plates until such time when the facility operator has completed the tie-in work. The Contractor shall be permitted to excavate utilizing a combination of machine and hand excavation, as field conditions warrant, and as directed by the facility operator. The trench shall be adjusted so as to provide for a

nominal cover on the new gas facilities or as required based on field conditions, applicable specifications, or as directed by the facility operator in consultation with the Resident Engineer. The width of the trench shall be as directed by the facility operator in consultation of the Resident Engineer. The width and depth of the trench shall conform to Con Edison Gas Operations drawing 309495 rev. 4, Trench Excavation for Gas Mains Up to 350 PSIG, or as directed by the facility operator in consultation of the Resident Engineer. The bottom of the trench shall be graded smooth with a minimum cushion of 3 inches of clean sand and in conformance with applicable specification and be compacted, to minimize initial settlement and to avoid "point" support of new gas facilities. All stones projecting into the trench bottom shall be removed, and the voids backfilled before the new gas facilities are installed. Where streets are not to final grade, the cover shall be measured from the final grade, or the existing grade, whichever provides the deeper trench. Excavation in the vicinity of utilities and other structures shall be performed using hand tools. The contractor shall properly dispose of all materials excavated away from site. Size and location of excavation shall be as directed by the facility operator in consultation with the Resident Engineer. Trenches shall be excavated to a depth and size necessary to facilitate the installation of the new gas facility and in conformance with the applicable specification. All existing facilities that are encountered during trench excavating shall be protected in a manner suitable to the facility operator in consultation with the Resident Engineer. Tight sheeting shall be used, as required, based on field conditions and/or when the depth of excavation is equal to or greater than five feet. Skeleton type sheeting will not be permitted. The sheeting required shall be furnished and installed in full compliance with the State of New York and Federal Safety Code requirements and in compliance with applicable specifications and/or as directed by the facility operator in consultation with the Resident Engineer. Care shall be taken that no existing gas facilities or other structures are broken or damaged. Contractor shall excavate all material encountered necessary to facilitate the installation of the new gas facilities, and as directed by the facility operator. Care should be taken to avoid damage to existing utility facilities and structures, and to pavements and their foundations, and to avoid caving or sliding banks within the excavation.

Maintenance of Trench Excavation - Excavated trenches shall be maintained free of debris and kept dry by the contractor. In order to accomplish this, contractor shall, upon completion of excavation and placement of sheeting (as required and/or if depth is equal to or greater than five feet), furnish and install adequate steel plates, as directed by the facility operator in consultation with the Resident Engineer, and posting over the excavated trenches and shall temporarily remove all equipment debris and workers, and relocate barricades in order to open the full width of street to traffic during non-working hours, as required based on DOT requirements. Con Edison forces will perform all live gas main connections, dead gas main cut-outs, and/or service work associated with disconnecting and reconnecting from old to new gas main. The Contractor shall then, at no additional cost, relocate such barricades barrels, cones and other warning devices and remove steel plates, as and when directed by the facility operator in consultation with the Resident Engineer to facilitate the installation of the new gas facilities. When work is being performed and the excavations are not covered with steel plates, the Contractor shall provide complete and safe access to the trench as may be required, and shall provide construction barricades and maintain traffic at all times as shown or as directed by the facility operator in consultation with the Resident Engineer. The contractor has the responsibility to maintain and set to grade all Con Edison hardware during backfill and pavement restoration. Upon completion of installation of the new gas facility, the trench excavation shall be backfilled by the contractor in accordance with Contract requirements and all backfill material shall conform to contract specifications for such purpose.

Pavement and Sidewalk Restoration - After backfilling is completed, the contractor shall install temporary pavement consisting of six inches (6") thick asphaltic concrete mixture in roadway areas or a two inches (2") thick asphaltic concrete mixture in sidewalk areas in order to maintain existing pedestrian and vehicular traffic. This temporary pavement shall be maintained until permanent replacement as specified in contract. Permanent pavement restoration shall be as required by the appropriate contract specifications and as directed by the Resident Engineer.

#### 4. Method of Measurement:

The quantity to be measured for payment shall be the number of cubic yards (C.Y.) of trench actually excavated, including roadway pavement, base and/or sidewalk concrete removed within the limits of the trench as directed by the Resident Engineer in consultation with the facility operator. The volume occupied

by existing pipes or other structures will be deducted from the total volume measured as shown on contract drawing(s) Title: EP-7 SECT. 6.09 GAS SPECIALTY CONTRACTOR WORK, or as encountered based on existing field conditions.

5. Price to Cover:

The unit price bid per cubic yard for excavation shall include the cost of all supervision, labor, material, equipment, insurance and incidentals necessary to complete excavation trenches, including backfill, compaction testing and restoration of trenches and tie-ins pits as specified or shown on the contract plans. The bid price shall also include the cost of coordinating the sewer and water main work to be performed by the contractor with the gas installation work to be performed by others. The price shall also include, associated maintenance of traffic, and traffic plates and openings and closings of plates as may be required in order to provide access to the facility operator during the new gas facility installation, and installing, removing and maintaining tight sheeting that may be required, cut, break and remove various thickness of surface and base pavement, excavate by hand, furnish, place and compact, in compliance with DOT requirements, clean sand backfill following installation of the gas facility. Any required removing, trucking, storing, and disposing of material shall be deemed included in the unit price. The price shall also include the cost of providing temporary pavement restoration. Permanent pavement restoration shall be deemed included in this item, as required and as directed by the Resident Engineer.

**GAS COST SHARING STANDARD SPECIFICATIONS**  
**SCHEDULE GCS-A**

**Average rate charged by utility companies to Disconnect and Reconnect Gas Services:**

1. National Grid - \$586.90 per Service/and Visit
2. Con Edison - \$524.00 per Service/and Visit

#### **IV - STANDARD SKETCHES; GAS COST SHARING WORK**

Hereinafter attached are the following Standard Sketches for Gas Cost Sharing Work:

- Sketch No. 1 - Support Requirements For Gas Mains And Services Crossing Excavation Greater Than 4' - 0" Wide At Any Angle
- Sketch No. 1A - Support Requirements For Gas Mains Over 16" Diameter Up To And Including 48" Diameter Crossing Excavation At Any Angle
- Sketch No. 2 - Typical Methods Of Measurement For Gas Crossings
- Sketch No. 3 - Utility Crossings During Catch Basin Chute Connection Pipe Installation
- Sketch No. 4 - Utility Crossings During Catch Basin Chute Connection Pipe Installation (Extra Depth)
- Sketch No. 5 - Gas Main Encroachment On And/Or Parallel To Excavation Of Unsheeted Trench

**GAS COST SHARING WORK (SKETCH NO. 1)**  
**SUPPORT REQUIREMENTS FOR GAS MAINS AND SERVICES CROSSING**  
**EXCAVATION GREATER THAN 4'-0" WIDE AT ANY ANGLE**

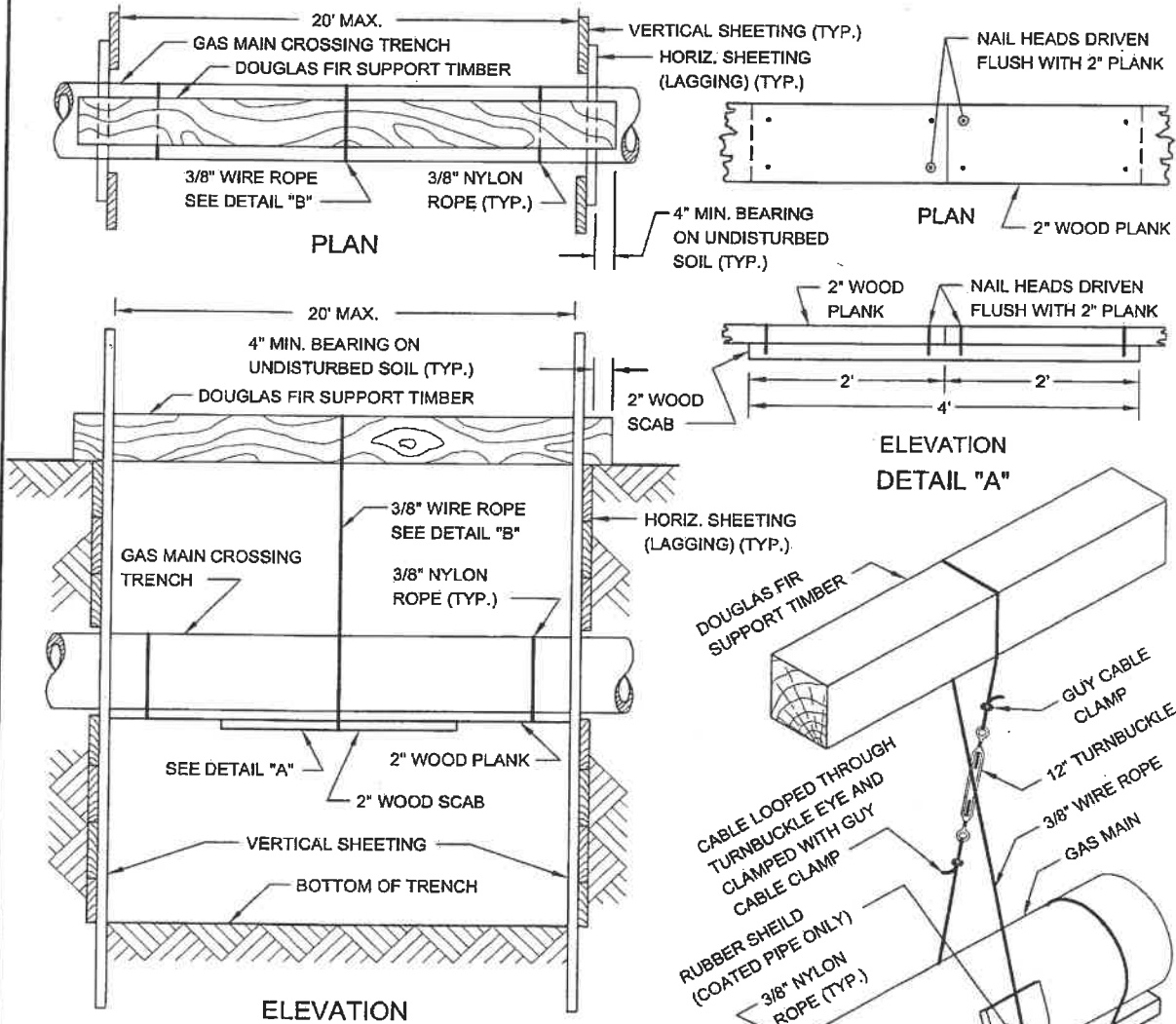

CABLE SUPPORT		TIMBER SUPPORT	
MAIN TYPE	SPACING	MAIN SIZE	TIMBER SIZE
CAST IRON	4' O.C. MAX.	UP TO 6"	6" X 6"
STEEL	10' O.C. MAX.	8" TO 10"	8" X 8"
PLASTIC	10' O.C. MAX.	12" TO 16"	10" X 10"

REVISED OCT. 2004 - L. ADRIEN  
 PREVIOUS EDITIONS: J. WONG / W. PATAKANDOP / MAY

# GAS COST SHARING WORK (SKETCH NO. 1A)

SUPPORT REQUIREMENTS FOR GAS MAINS OVER 16" DIAMETER UP TO AND INCLUDING 48" DIAMETER CROSSING EXCAVATION AT ANY ANGLE

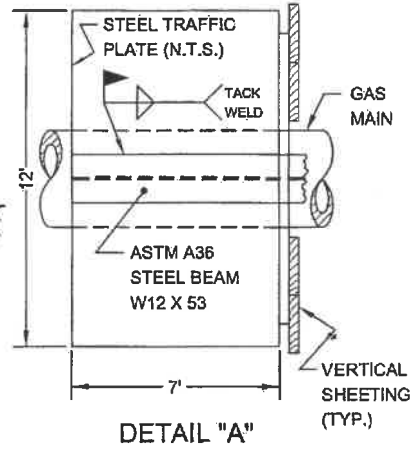
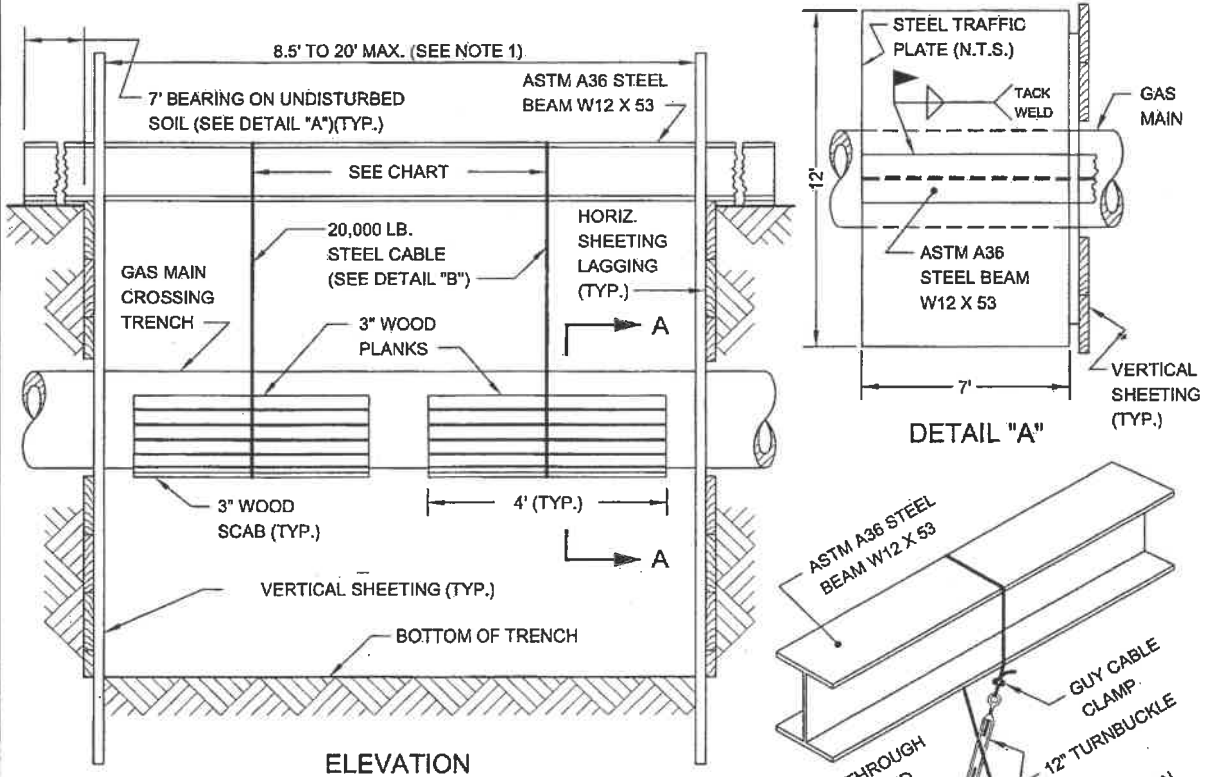

CABLE SUPPORT	
MAIN TYPE	SPACING
CAST IRON	4' O.C. MAX.
STEEL	10' O.C. MAX.

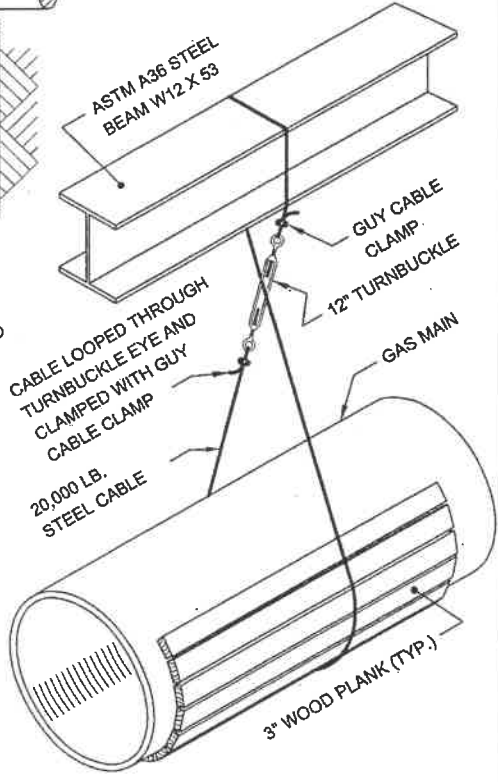
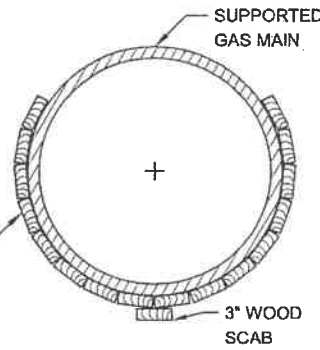

- NOTES:**
- (1) NO SUPPORT IS REQUIRED FOR GAS MAINS OVER 16" DIA. UP TO AND INCLUDING 48" DIA. CROSSING TRENCHES LESS THAN 8.5' WIDE.
  - (2) UNDERMINE A MAXIMUM OF 8.5 L.F. OF CAST IRON GAS MAIN AT A TIME.
  - (3) SET STEEL CABLE OVER 3" WOOD PROTECTIVE PLANKS AND PLACE AN ADDITIONAL 3" SCAB ON THE BOTTOM OF THE GAS MAIN.
  - (4) ADJUST STEEL CABLE UNTIL DEAD WEIGHT OF THE UNDERMINED GAS MAIN HAS BEEN TAKEN UP BY THE OVERHEAD STEEL BEAM SUPPORT.
  - (5) ALL SUPPORTS AND STEEL CABLES CAN BE REMOVED ONLY AFTER THE REQUIRED BACKFILL (AROUND AND BELOW GAS MAIN) HAS BEEN COMPACTED IN ACCORDANCE WITH NEW YORK CITY STANDARDS AND AT THE DIRECTIONS OF THE ENGINEER.

REVISION OCT 2004 - L. ADRIEN  
 REVISED JUNE 1998 - J. WONG / W. PATALAN / P. MOY

## GAS COST SHARING WORK (SKETCH NO. 2)

### TYPICAL METHODS OF MEASUREMENT FOR GAS CROSSINGS

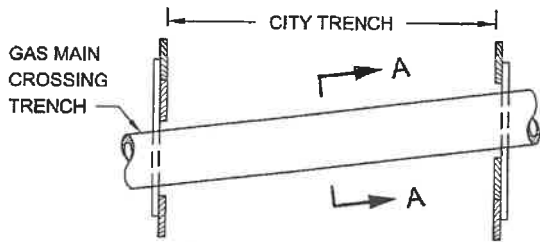

**SINGLE FACILITY CROSSING**

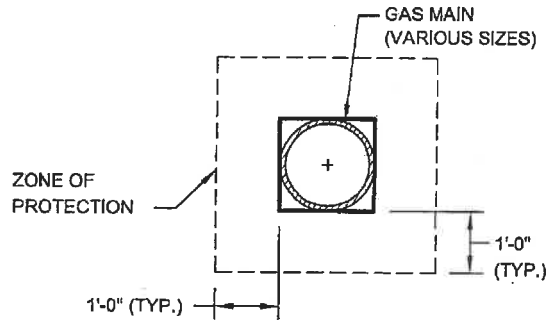

**SECTION A-A**

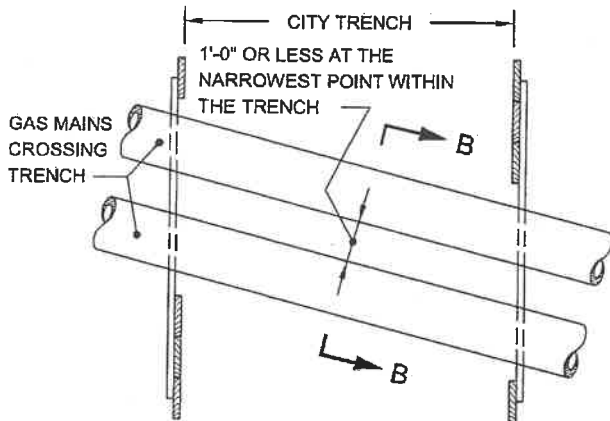

**MULTIPLE FACILITIES  
(GAS MAINS AT SAME ELEVATION)**

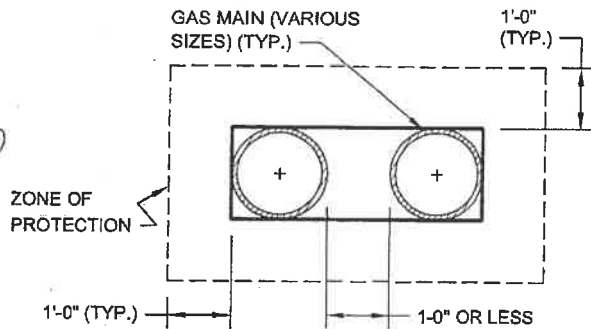

**SECTION B-B**

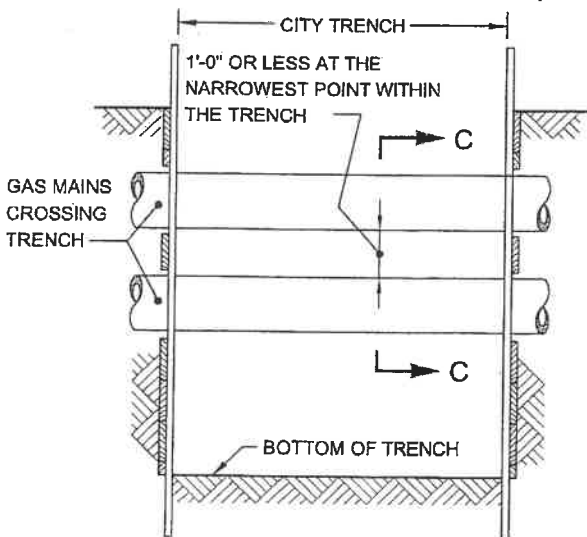

**MULTIPLE FACILITIES  
(ONE CROSSING AT DIFFERENT ELEVATIONS)**

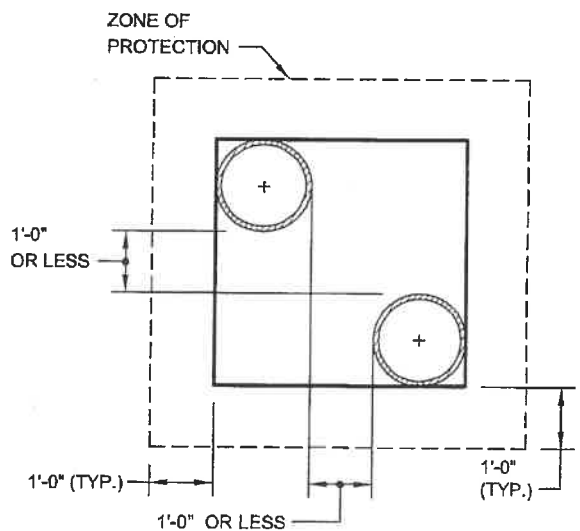

**SECTION C-C**

**NOTE:**

GAS MAINS MAY OR MAY NOT BE PARALLEL TO EACH OTHER.



GAS COST SHARING WORK (SKETCH NO. 3)  
UTILITY CROSSINGS DURING CATCH BASIN CHUTE  
CONNECTION PIPE INSTALLATION

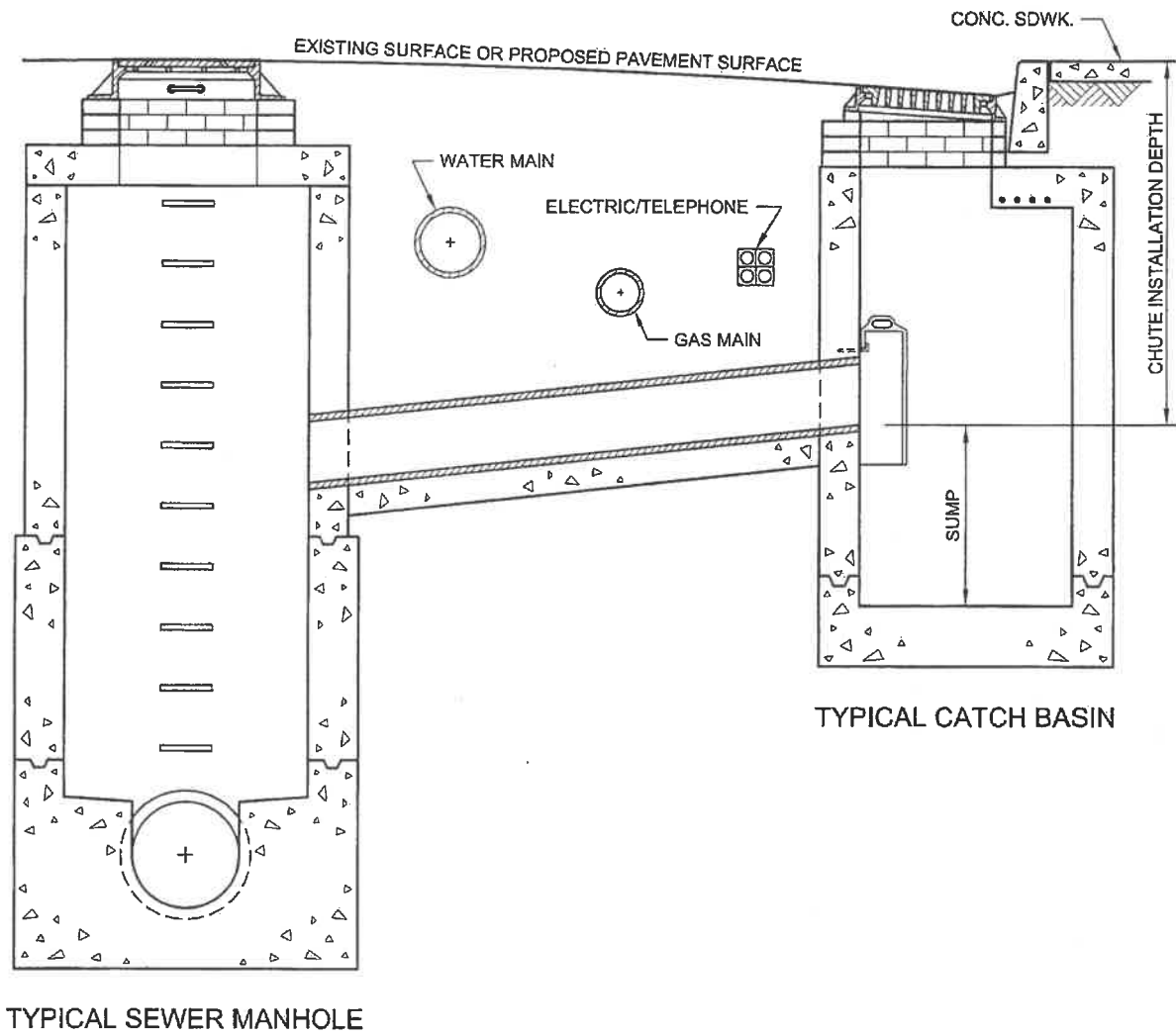

REVISED OCT. 2004 - L. ABBEEN  
REVISED OCT. 1998 - J. WONGAW, PATALANOP, MOY

**GAS COST SHARING WORK (SKETCH NO. 4)**  
**UTILITY CROSSINGS DURING CATCH BASIN CHUTE**  
**CONNECTION PIPE INSTALLATION (EXTRA DEPTH)**

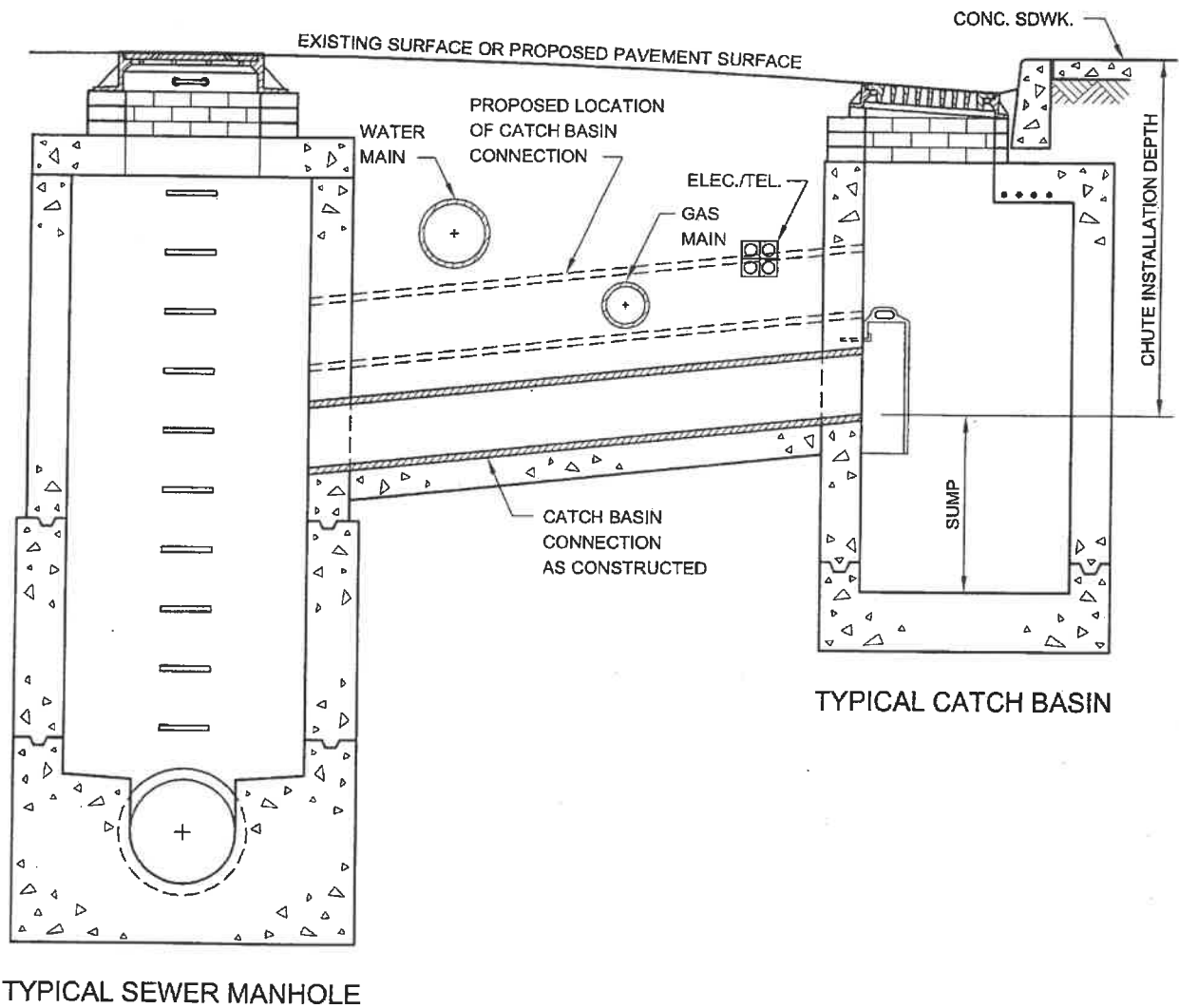

REVISED OCT. 2004 - J. ADRIEN  
 REVISED OCT. 1998 - J. WONGW. PATALANOP, MOY

**GAS COST SHARING WORK (SKETCH NO. 5)**  
**GAS MAIN ENCROACHMENT ON AND/OR PARALLEL**  
**TO EXCAVATION OF UNSHEETED TRENCH**

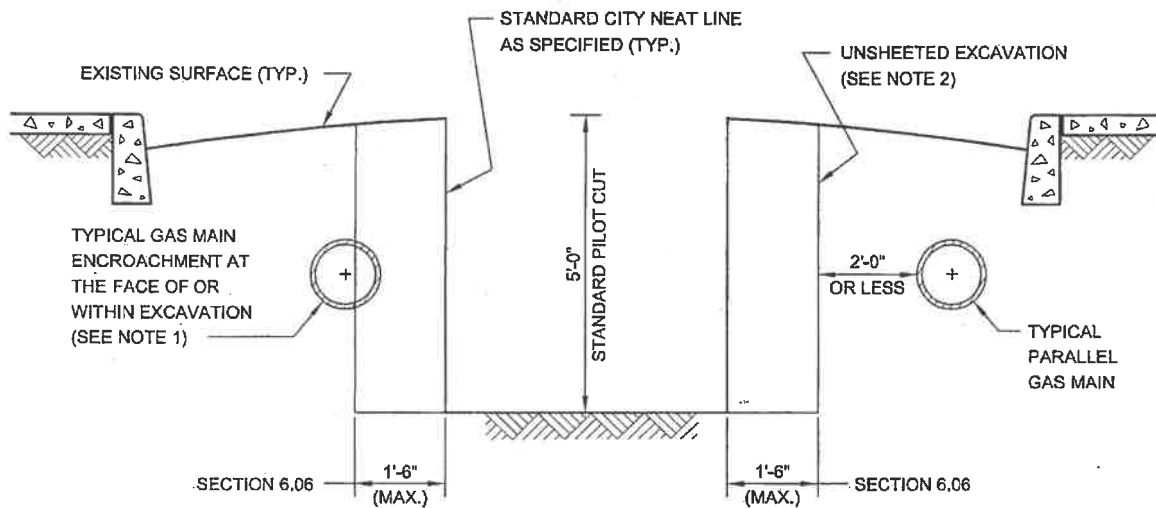

**NOTES:**

- (1) GAS MAIN LOCATED AS SHOWN MAY HAVE TO BE REMOVED BY THE FACILITY OPERATOR PRIOR TO THE START OF CITY EXCAVATION, OTHERWISE, THE CONTRACTOR WILL BE PAID UNDER SECTION 6.06 FOR THE SAID WORK. IF GAS MAIN IS ABANDONED THEN SECTION 6.03 SHALL APPLY.
- (2) EIGHTEEN (18) INCHES FROM STANDARD NEAT LINE IS THE MAXIMUM ALLOWABLE WIDTH OF AREA THAT MAY BE DISTURBED OR EXCAVATED DURING INSTALLATION OF CERTAIN TYPES OF SHEETING SYSTEMS THAT MEET THE REQUIREMENTS OF THE STANDARD SPECIFICATIONS OF THE DEPARTMENT OF DESIGN AND CONSTRUCTION OF THE CITY OF NEW YORK.

**V - PRELIMINARY GAS WORK TO BE PERFORMED BY  
FACILITY OPERATOR.**

APPLICABLE TO ALL GAS DRAWINGS:

- ALL RELOCATION WORK SHOWN IN THIS SECTION IS TO BE PERFORMED BY FACILITY OPERATOR.
- ALL SUPPORT AND PROTECTION WORK TO BE PERFORMED BY CITY CONTRACTOR
- IF ADDITIONAL INFORMATION IS NEEDED REGARDING THE FACILITY OPERATOR'S RELOCATION WORK, THE CONTRACTOR IS ADVISED TO CONTACT THE GAS COMPANY REPRESENTATIVE:

Neville Jacobs Jr.  
NationalGrid Energy Delivery  
287 Maspeth Avenue  
Brooklyn, NY 11211  
718-963-5612

(NO TEXT IN THIS AREA, TURN PAGE)

nationalgrid

CONTRACT#: SANDHW11

**GAS MAIN INSTALLATION**

ITEM#	ON STREET	1ST X-STREET	2ND X-STREET	SIZE/MAT'L	FOOTAGE	PRESSURE	REMB
1	Beach Channel Dr	B.123 St		2" PI	80	H	Y
3	B.123 ST	BEACH CHANNEL DR		2" PL	80	H	Y
5	Beach Channel Dr	B.122 ST		2" PL	80	H	Y
7	B.122	BEACH CHANNEL DR		2" PL	60	H	Y
9	Beach Channel Dr	B.121 ST		2" PL	80	H	Y
11	Beach Channel Dr	B.120 ST		2" PL	60	H	Y
13	Beach Channel Dr	B.119 ST		2" PL	40	H	Y
15	Beach Channel Dr	B.118 ST		2" PL	40	H	Y
17	Beach Channel Dr	B.117 ST	B.116 ST	8" PL	840'	H	Y
19	B.116 ST	Cronston Ave		6" PL	120'	H	Y
21	B.116 ST	Rockaway Bch Blvd		6" PL	100'	H	Y
23	Rockaway Bch Blvd	B.116 ST	B.114 St	4" PI	450'	H	Y

**GAS MAIN RETIREMENT**

ITEM#	ON STREET	1ST X-STREET	2ND X-STREET	SIZE/MAT'L	FOOTAGE	PRESSURE	REMB
2	Beach Channel Dr	B.123 St		2" PI	80	H	Y
4	B.123 St	BEACH CHANNEL DR		2" PL	80	H	Y
6	Beach Channel Dr	B.122 ST		2" PL	80	H	Y
8	B.122 ST	BEACH CHANNEL DR		2" PL	60	H	Y
10	Beach Channel Dr	B.121 ST		2" PL	80	H	Y
12	Beach Channel Dr	B.120 ST		2" PL	60	H	Y
14	Beach Channel Dr	B.119 ST		2" PL	40	H	Y
16	Beach Channel Dr	B.118 ST		2" PL	40	H	Y
18	Beach Channel Dr	B.117 ST	B.116 ST	8" STL	840	H	Y
20	B.116 ST	Cronston Ave		6" STL	100	H	Y
22	Rockaway Bch Blvd	B.116 ST	B.114 St	4" PL	450	H	Y

Sheet 1/4  
1/25th Project: SANDHILL

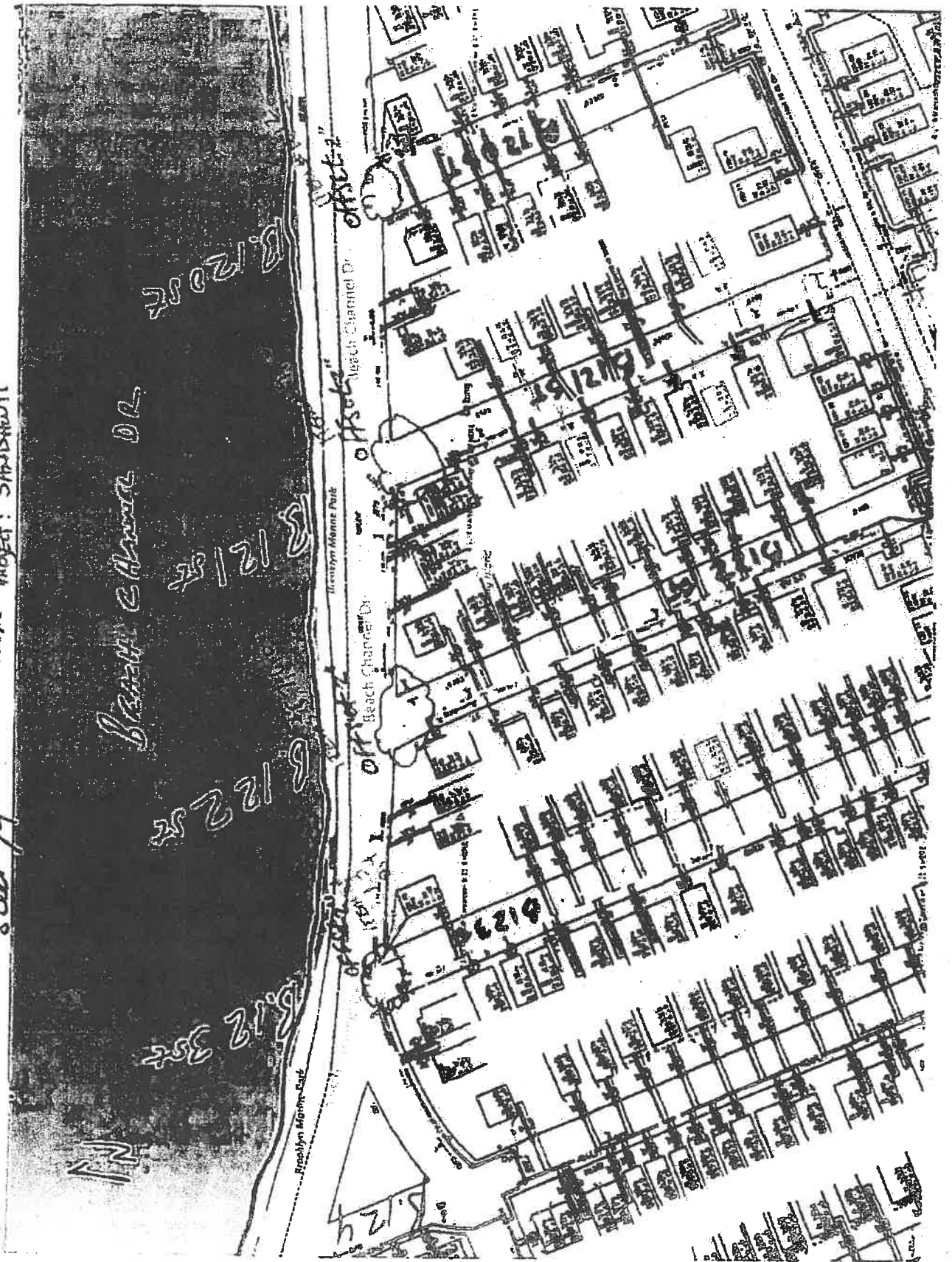

Sheet 4/4

Project: Smith Hill

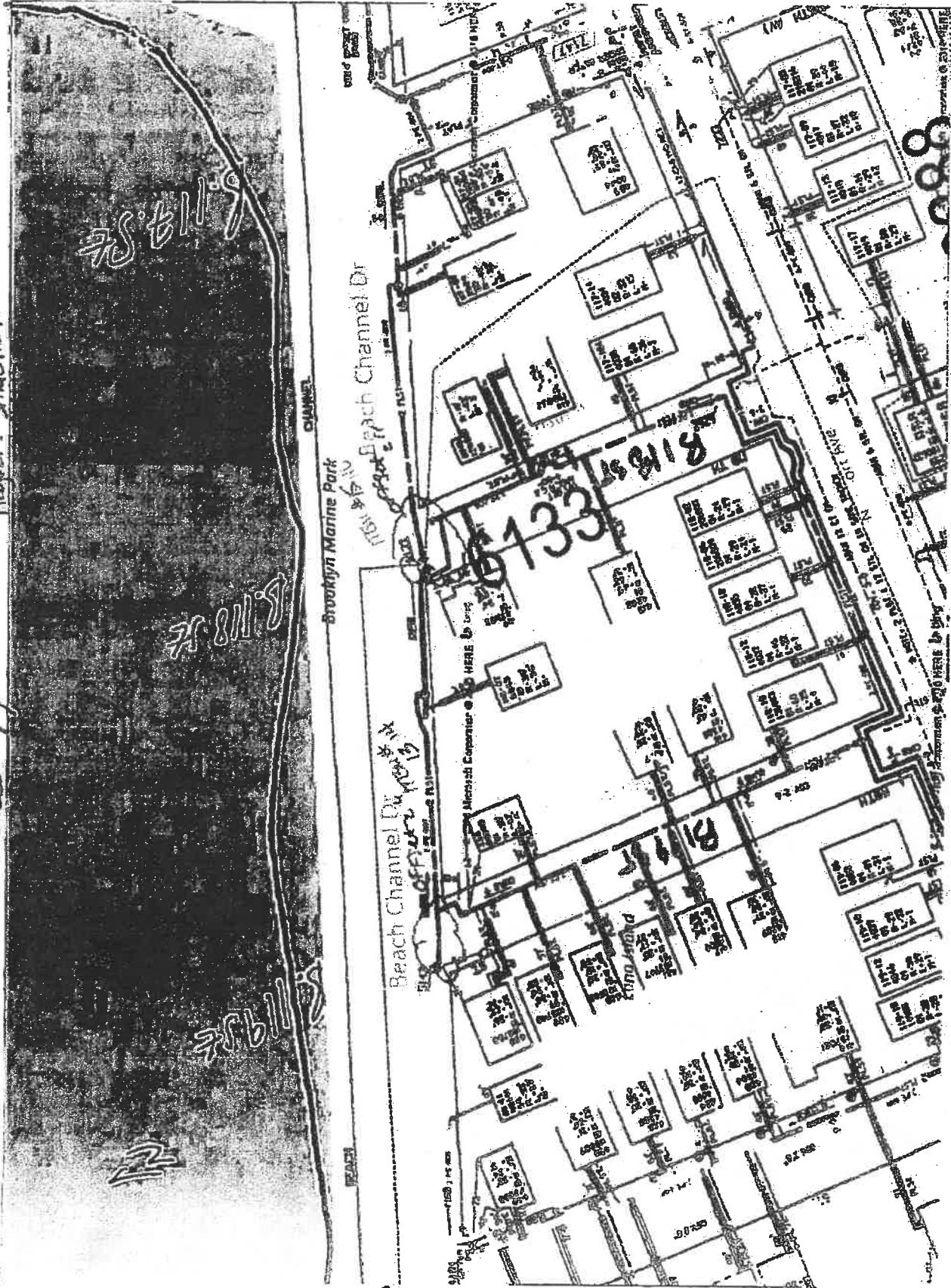

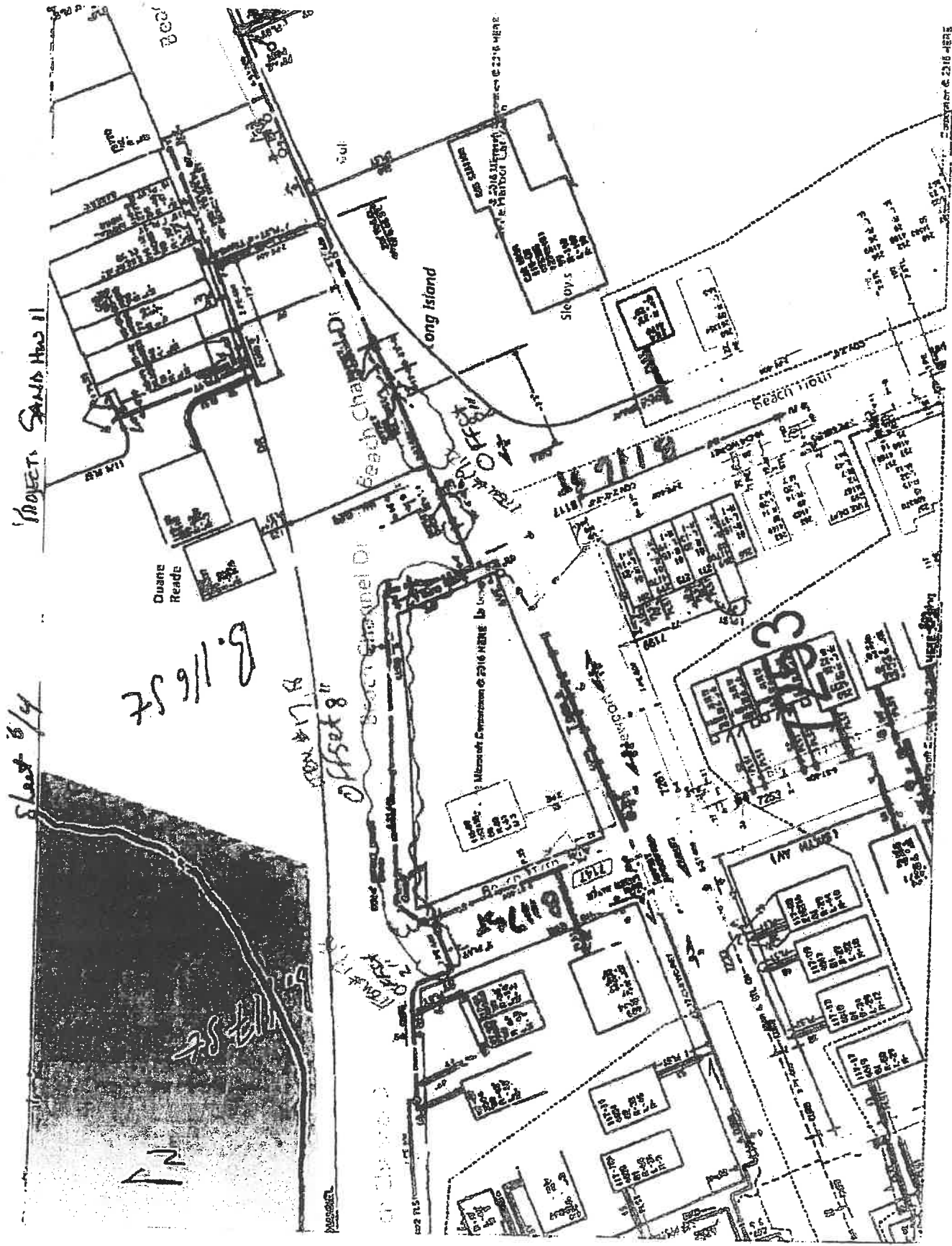

PROJECT SANDS Phase II

Sheet 6/4

B. 1/6 St

Offset 8'



Project: SANDHILLS II

Sheet 7/4

N



**VI - LISTING OF APPROXIMATE LOCATIONS OF EP-7 BID  
ITEMS QUANTITIES.**

(NO TEXT IN THIS AREA, TURN PAGE)

**SCOPE OF WORK  
SUPPORT AND PROTECTION  
FOR CONTRACT NUMBER SANDHW11**

The City of New York Department of Design and Construction is planning to install sewers and/or water mains and all appurtenances in various locations in The City of New York along with all work incidental thereto.

- 6.01.1 - Support & Protect Gas Main Crossing Sewer Up To 24" In Diameter (Ea.)**
  - 1 in Beach Channel Drive @ Beach 116<sup>th</sup> St
  
- 6.01.9 - Support & Protect Gas Main Crossing Water Main Up To 20" In Diameter (Ea.)**
  - 1 in Beach 116<sup>th</sup> St btw Newport Ave & Rockaway Beach Blvd
  - 1 in Newport Ave @ Beach Channel Drive
  - 1 in Beach Channel Drive @ Beach 119<sup>th</sup> St
  - 1 in Beach Channel Drive @ Beach 118<sup>th</sup> St
  - 1 in Beach Channel Drive @ Beach 120<sup>th</sup> St
  - 1 in Beach Channel Drive @ Beach 121<sup>th</sup> St
  - 1 in Beach Channel Drive @ Beach 122<sup>nd</sup> St
  - 1 in Cronston Ave @ Beach 123<sup>rd</sup> St
  - 1 in Rockaway Beach Blvd @ Beach 114<sup>th</sup> St
  - 1 in Rockaway Beach Blvd @ Beach 115<sup>th</sup> St
  - 2 in Rockaway Beach Blvd @ Beach 116<sup>th</sup> St
  
- 6.02 - Extra Excavation For the Installation of Catch Basin Sewer Drain Pipes with gas interferences (Ea.)**
  - 3 in Various Locations As Required
  
- 6.03 - Removal Of Abandoned Gas Facilities. All Sizes (L.F.)**
  - 1500 in Various Locations As Required
  
- 6.03.1 - Removal Of Abandoned Gas facilities with Possible Coal Tar Wrap. All sizes. (L.F.) (For National Grid work Only)**
  - 700 in Various Locations As Required
  
- 6.04 - Adjust Hardware to Grade Using Spacer Rings/Adaptors (Street repaving) (Ea.)**
  - 12 in Various Locations As Required
  
- 6.05 - Adjust Hardware to Grade by Resetting (Road Reconstruction) (Ea.)**
  - 13 in Various Locations As Required

**SCOPE OF WORK  
SUPPORT AND PROTECTION  
FOR CONTRACT NUMBER SANDHW11**

The City of New York Department of Design and Construction is planning to install sewers and/or water mains and all appurtenances in various locations in The City of New York along with all work incidental thereto.

**6.06 - Special Care Excavation & Backfilling (C.Y.)**

400 in various locations, as required, including but not limited to all gas services crossing unsheeted water main trenches.

**6.07 - Test Pits For Gas Facilities (C.Y.)**

50 in Various Locations As Required

(NO TEXT ON THIS PAGE)

**HAZ - PAGES**

**SPECIFICATIONS FOR HANDLING,  
TRANSPORTATION AND DISPOSAL  
OF NONHAZARDOUS AND POTENTIALLY  
HAZARDOUS CONTAMINATED MATERIALS**

---

**NOTICE**

THE PAGES CONTAINED IN THIS SECTION ARE ISSUED FOR THE PURPOSE OF SPECIFYING THE REQUIREMENTS OF THE CONTRACT DOCUMENTS AND HEREBY MADE PART OF SAID CONTRACT DOCUMENTS.

(NO TEXT ON THIS PAGE)

**SPECIFICATIONS FOR  
HANDLING, TRANSPORTATION AND DISPOSAL  
OF NON-HAZARDOUS AND POTENTIALLY HAZARDOUS  
CONTAMINATED MATERIALS**

**RECONSTRUCTION OF BEACH CHANNEL DRIVE  
BETWEEN BEACH 116<sup>TH</sup> STREET AND BEACH 124<sup>TH</sup> STREET**

**BOROUGH OF QUEENS  
CITY OF NEW YORK**

**Capital Project ID: SANDHW11**

**Prepared By:**



30-30 Thomson Avenue, 3<sup>rd</sup> Floor  
Long Island City, New York 11101

September 30, 2016



**NO TEXT ON THIS PAGE**

## Table of Contents

ITEM 8.01 C1 HANDLING, TRANSPORTING, & DISPOSAL OF NON-HAZARDOUS CONTAMINATED SOILS .....	HAZ. - 1
ITEM 8.01 C2 SAMPLING AND TESTING OF CONTAMINATED/ POTENTIALLY HAZARDOUS SOIL FOR DISPOSAL PARAMETERS .....	HAZ. - 7
ITEM 8.01 H HANDLING, TRANSPORTING, AND DISPOSAL OF HAZARDOUS SOILS.....	HAZ. - 9
ITEM 8.01 S HEALTH AND SAFETY.....	HAZ. - 14
ITEM 8.01 W1 REMOVAL, TREATMENT, AND DISCHARGE/DISPOSAL OF CONTAMINATED WATER.....	HAZ. - 19
ITEM 8.01 W2 SAMPLING AND TESTING OF CONTAMINATED WATER.....	HAZ. - 25
ATTACHMENT 1: NYCDEP LIMITATIONS FOR DISCHARGE TO STORM, SANITARY/COMBINED SEWER .....	HAZ. - 28
ATTACHMENT 2: APPLICABLE REGULATIONS.....	HAZ. - 31
ATTACHMENT 3: DEFINITIONS.....	HAZ. - 34
ATTACHMENT 4: PHASE II SUBSURFACE CORRIDOR INVESTIGATION REPORT .....	HAZ. - 36

## ITEM 8.01 C1 HANDLING, TRANSPORTING, & DISPOSAL OF NON-HAZARDOUS CONTAMINATED SOILS

### 8.01 C1.1 WORK TO INCLUDE

General: This work shall consist of the handling, transportation and disposal of non-hazardous contaminated soils. The materials covered by this specification are soils that are contaminated with petroleum or chemical products but cannot be classified as hazardous waste. For the purpose of this specification, soil shall be defined as any material excavated below the pavement and base for pavement.

Non-hazardous contaminated soils are defined as soils exhibiting one or more of the following characteristics:

- ◆ Elevated Photo-Ionization Detector (PID) readings, subsequently confirmed by lab analysis
- ◆ Visual evidence of contamination
- ◆ Petroleum and/or chemical odors
- ◆ Soils that have been documented as contaminated in previous environmental reports

Non-hazardous contaminated soils must be stockpiled at an off-site approved location or secured on-site by the Contractor, meeting all required Federal, State and Local stipulations. Sampling and laboratory analysis must be conducted to determine if the soils are hazardous, unless the alternative procedure as defined under subsection 8.01 C1.1 A.5 has been agreed upon by treatment facilities. Contaminated soils determined to be non-hazardous shall be handled in accordance with the specifications herein for Item 8.01 C1. Contaminated soils determined to be hazardous shall be handled in accordance with the specifications for Item 8.01 H – Handling, Transporting and Disposal of Hazardous Soils.

The Contractor shall retain the services of an independent Environmental Consultant, as specified under Item 8.01 S – Health and Safety, to oversee the work required under this Item.

Non-hazardous soils shall be delivered to the disposal or treatment facility within thirty (30) calendar days after excavation.

The Contractor shall conduct sampling and analysis of the impacted soils as specified under Item 8.01 C2 – Sampling and Testing of Contaminated/Potentially Hazardous Soils for Disposal Parameters. The laboratory results shall be forwarded to DDC Program Management, Office of Environmental and Geotechnical Services (OEGS) for review to determine if the soils will be handled and disposed of as contaminated regulated soils or hazardous waste. No other soils shall be sampled or tested without the DDC's approval or direction.

The Contractor shall ensure that all operations associated with the handling, sampling, loading, transportation, and disposal of non-hazardous contaminated soils are in compliance with all applicable Federal, State, and City statutes and regulations.

The Contractor shall document the excavation, handling, transportation and disposal of non-hazardous contaminated soils. The Contractor shall supply all equipment, material and labor required to conduct the specified work of this Item.

- A. Material Handling Plan: Within forty-five (45) calendar days after award of Contract, the Contractor shall submit to the Program Management, OEGS for review, a Material Handling Plan (MHP). The MHP must be approved by the Program Management, OEGS, prior to the Contractor's commencement of work. The MHP shall, at a minimum, consist of:

1. The Contractor's procedures for identifying non-hazardous contaminated soils during excavation, including the specific model and manufacturer of intended organic vapor monitoring equipment and calibration procedures to be used. It should also include the training and experience of the personnel who will operate the equipment.
2. The Contractor's procedures for safely handling non-hazardous contaminated soils. The procedures must include personnel safety and health as well as environmental protection considerations.
3. Name, address, New York State Department of Health's (DOH) Environmental Laboratories Accreditation Program (ELAP) status and telephone number of the proposed laboratory for analysis of representative soil samples. The ELAP for the intended analysis must approve the laboratory.
4. Identification of the Contractor's proposed waste transporter(s). This information shall include:
  - a. Name and Waste Transporter Permit Number
  - b. Address
  - c. Name of responsible contact for the hauler
  - d. Telephone number for the contact
  - e. Any and all necessary permit authorizations for each type of waste transported
  - f. Previous experience in performing the type of work specified herein
5. All staging/stockpiling areas (if stockpiling areas are intended and available), or alternate procedures that will be used. Alternate procedures may include, but are not limited to, agreements from the intended disposal or treatment facilities to accept boring data and/or analytical data previously obtained during the site characterization so that materials may be directly loaded into vehicles for shipment to the disposal facility.
6. A backup facility should the staging/stockpile areas become unavailable, insufficient in area or not be present by some other unforeseen difficulty.
7. Identification of the Contractor's two proposed Treatment Storage or Disposal (TSD) facilities for non-hazardous contaminated soils (primary and back-up) for final disposal of the soils. The primary TSD shall be an approved soil recycling/treatment facility. The backup facility may be a recycling/treatment facility or a New York State Department of Environmental Conservation (DEC) approved lined landfill or other facility approved by DEC to accept this material. The information required for each facility shall include:
  - a. Facility name and the State identification number
    - (1) Facility location
    - (2) Name of responsible contact for the facility
    - (3) Telephone number for contact
    - (4) Signed letter of agreement to accept waste as specified in this contract
    - (5) Unit of measure utilized at facility for costing purposes

- b. A listing of all permits, licenses, letters of approval, and other authorizations to operate, which are currently held and valid for the proposed facility.
  - c. A listing of all permits, licenses, letters of approval, and other authorizations to operate which have been applied for by the proposed facility but not yet granted or issued.
  - d. The Contractor shall specify and describe the disposal/containment unit(s) that the proposed facility will use to manage the waste. The Contractor shall identify the capacity available in the units and the capacity reserved for the subject waste.
  - e. The Contractor shall provide the date of the proposed facility's last compliance inspection.
  - f. A list of all active (unresolved) compliance orders (or agreements), enforcement notices, or notices of violations issued to the proposed facility shall be provided. The source and nature of the cause of violation shall be stated, if known.
8. Description of all sampling and field/laboratory analyses that will be needed to obtain disposal facility approval.

#### **8.01 C1.2 MATERIALS**

- A. Containers shall be as required in the United State Department of Transportation (DOT) regulations.
- B. Polyethylene to be placed under (20 mil. thickness minimum) and over (10 mil. thickness minimum) soil piles.
- C. The Contractor shall assure that the waste hauler's appropriate choice of vehicles and operating practices shall prevent spillage or leakage of contaminated material from occurring en route.
- D. The Contractor shall provide, install and maintain any temporary loading facilities on site as required until completion of material handling activities. The location and design of any facilities shall be included in the MHP and be approved by the Program Management, OEGS.

#### **8.01 C1.3 CONSTRUCTION DETAILS**

##### **A. Material Handling**

- 1. Immediately after excavation of non-hazardous contaminated soil the Contractor shall:
  - a. Load material directly onto trucks/tankers/roll offs for disposal off site; or
  - b. If interim stockpiling is required, place on a minimum of 20 mil. or equivalent plastic ground cloth and cover by minimum of 10 mil. polyethylene sheeting or equivalent to protect against leaching or runoff of contaminants into groundwater or stormwater. Weight or secure the sheeting by appropriate means and seal seams as approved by the DDC to prevent tearing or removal by weather. Grade surrounding surface to provide for positive drainage away from pile. Stockpile shall not exceed 100 cubic yards.

2. Institute appropriate procedures and security measures to ensure the protection of site personnel and the public from contaminated materials as described in the approved MHP and Item 8.01 S - Health and Safety.
3. Any soil encountered that appears to contain unknown contaminants (based on visual, odor, or other observation), or that vary substantially from the material originally identified must be segregated in stockpiles and the independent Environmental Consultant promptly notified. Construct stockpiles to the same requirements as stated in subsection A.1.b above.
4. Provide any dewatering that is necessary to complete the work. Contaminated water shall be disposed of in accordance with Item 8.01 W1 – Removal, Treatment and Discharge/Disposal of Contaminated Water.
5. Provide and operate field organic vapor test equipment, a PID or a flame ionization detector (FID), to detect general organic vapor levels at intervals of approximately fifty (50) cubic yards of soil excavated, when visual or odor observations indicate the material may substantially differ from the soil previously excavated and/or as directed by the independent Environmental Consultant.

B. Off-Site Transportation to Disposal or Treatment Facility

1. General

- a. The Contractor shall furnish all labor, equipment, supplies and incidental costs required to transport contaminated material from the work area to the off-site disposal or treatment facility, and any other items and services required for transporting contaminated material for disposal at an off-site facility.
- b. The Contractor shall submit the name and location of the facility where an off-site scale is located. The Contractor shall also submit a plan to the DDC for review outlining procedures on controlling trucks leaving the work site and en-route to the off-site scale. The Contractor shall be responsible for tracking all material/vehicles from the site to the off-site scale.
- c. The Contractor shall provide to the DDC certified tare and gross weight slips for each load received at the accepted facility which shall be attached to each returned manifest.
- d. The Contractor shall coordinate the schedule for truck arrival and material deliveries at the job site to meet the approved project schedule.
- e. The Contractor shall inspect all vehicles leaving the project site to ensure that contaminated soils adhering to the wheels or undercarriage are removed prior to the vehicle leaving the site.
- f. The Contractor shall obtain letters of commitment from the waste haulers and the treatment, disposal or recovery facility to haul and accept shipments. The letter shall indicate agreement to handle and accept the specified estimated quantities and types of material during the time period specified in the project schedule and any time extension as deemed necessary.
- g. **The Program Management, OEGS shall review and approve waste profiles before transportation to the TSD facility.**

2. Hauling

- a. The Contractor shall coordinate manifesting, placarding of shipments, and vehicle decontamination. All quantities shall also be measured and recorded upon arrival at the disposal or treatment facility. If any deviation between the two records occurs, the matter is to be reported immediately to the DDC and to be resolved by the Contractor to the satisfaction of the DDC.
  - b. The Contractor shall be held responsible, at its own cost for any and all actions necessary to remedy situations involving material spilled in transit or mud and dust tracked off-site.
  - c. The Contractor shall ensure that trucks are protected against contamination by properly covering and lining them with compatible material (such as polyethylene) or by decontaminating them prior to and between acceptances of loads.
  - d. The Contractor shall be responsible for inspecting the access routes for road conditions, overhead clearance, and weight restrictions.
  - e. The Contractor shall only use the transporter(s) identified in the MHP for the performance of work. Any use of substitute or additional transporters must have previous written approval from the Program Management, OEGS at no additional cost to the City.
  - f. The Contractor shall develop, document, and implement a policy for accident prevention.
  - g. The Contractor shall not combine contaminated materials from other projects with material from this project.
  - h. No material shall be transported until approved by the DDC.
3. Off-Site Disposal
- a. The Contractor shall use only the facility(ies) identified in the MPH for the performance of the work. Substitutions or additions shall not be permitted without prior written approval from the Program Management, OEGS, and if approved shall be at no extra cost to the City.
  - b. The Contractor shall be responsible for acceptance of the materials at an approved facility, for ensuring that the facility is properly permitted to accept the stated materials, and that the facility provides the stated treatment and/or disposal services.
  - c. The DDC reserves the right to contact and visit the disposal or treatment facility and regulatory agencies to verify the agreement to accept the stated materials and to verify any other information provided.
  - d. In the event that the identified and approved facility ceases to accept the stated materials or the facility ceases operations, it is the Contractor's responsibility to locate an alternate approved and permitted facility(ies) for accepting materials. The alternate facility(ies) must be approved in writing by the DDC in the same manner and with the same requirements as for the original facility(ies). This shall be done at no extra cost or delay to the City.
  - e. The Contractor shall obtain manifest forms, and complete the shipment manifest records required by the appropriate regulatory agencies for verifying the material and quantity of each load in unit of volume and weight. Copies of each manifest

shall be submitted to the DDC within four (4) business days following shipment, and within three (3) business days after notification of receipt of the facility. Any manifest discrepancies shall be reported immediately to the DDC and be resolved by the Contractor to the satisfaction of the DDC.

4. Equipment and Vehicle Decontamination
  - a. The Contractor shall design and construct a portable decontamination station to be used to decontaminate equipment and vehicles exiting from the exclusion zone. The cost for this work will be paid under Item 8.01 S - Health and Safety.
  - b. Water generated during the decontamination process shall be disposed of in accordance with Item 8.01 W1 – Removal, Treatment and Discharge/Disposal of Contaminated Water.

**8.01 C1.4 METHOD OF MEASUREMENT**

Quantities for non-hazardous contaminated soils shall be measured in tons. The tonnage will be determined by off-site truck scales, as per Subsection 8.01 C1.3.B1, that are capable of generating load tickets.

**8.01 C1.5 PRICE TO COVER**

- A. The unit bid price bid per ton for Item 8.01 C1 shall include the cost of furnishing all labor, materials, equipment, plan, and insurance for excavation, handling, transportation, disposal, documentation, fees, permits, loading, stockpiling, hauling, and any other incidentals necessary to complete all the work as specified herein for handling, transporting, and disposal of non-hazardous contaminated soil.
- B. Final disposal of hazardous soil shall be paid for under Item 8.01 H – Handling, Transporting and Disposal of Hazardous Soils. Disposal of decontamination water shall be paid for under Item 8.01 W1 – Removal, Treatment and Discharge/Disposal of Contaminated Water.
- C. Backfill will be paid for under its respective item as specified in the contract document.
- D. The independent Environmental Consultant shall be paid under Item 8.01 S – Health and Safety.

*Payment will be made under:*

<u>ITEM NUMBER</u>	<u>ITEM</u>	<u>PAYMENT UNIT</u>
8.01 C1	Handling, Transporting, and Disposal of Non-Hazardous Contaminated Soil	Tons



**ITEM 8.01 C2 SAMPLING AND TESTING OF CONTAMINATED/ POTENTIALLY  
HAZARDOUS SOIL FOR DISPOSAL PARAMETERS**

**8.01 C2.1 WORK TO INCLUDE**

**A. Description**

The work shall consist of collecting and analyzing representative soil samples for parameters typically requested by the disposal facilities.

**B. Sampling and Laboratory Analysis**

1. At least thirty (30) days prior to the commencement of work, the Contractor's independent Environmental Consultant must submit a Soil Sampling Plan/Field Sampling Plan (SSP/FSP) to the Program Management, Office of Environmental and Geotechnical Services (OEGS) for review and approval. The plan shall include the name, address, DOH's ELAP status, and telephone numbers of the proposed laboratory. The plan shall also include training and experience of the personnel who will collect the samples.
2. The Contractor shall sample and analyze representative samples of the contaminated/potentially hazardous soils. For stockpiled soils, the Contractor shall collect and analyze one (1) composite sample per 500 cubic yards or fraction thereof. Each composite sample shall consist of a minimum of five (5) grab samples collected from greater than two (2) feet below the soil surface. For drummed soil, the Contractor shall collect one (1) composite sample per (ten) 10 drums or fraction thereof. Each composite sample shall consist of a grab sample from each of the ten (10) drums or fraction thereof. Each composite sample shall be analyzed for Resource Conservation and Recovery Act (RCRA) hazardous waste characteristics (Ignitability, Reactivity, Corrosivity), Full Toxicity Characteristic Leaching Procedure (TCLP) (including RCRA metals, volatile Organic Compounds (VOCs), Semi-Volatile Organic Compounds (SVOCs), pesticides, herbicides), Total Petroleum Hydrocarbons (TPH) and Polychlorinated Biphenyls (PCBs). All samples collected should be analyzed on a five (5) calendar days turn around time and analytical results must be submitted to Program Management, OEGS upon receipt of the analytical results.
3. All sampling shall be conducted by a person trained in sampling protocols using standard accepted practices for obtaining representative samples.
4. The Contractor must also contact the disposal facility where the waste will be sent for permanent disposal, and arrange to collect any additional samples required by the facility. The cost associated with additional sampling and testing shall be included in the bid price of this Item.
5. The quality of the data from the sampling program is the Contractor's responsibility. The Contractor must furnish all qualified personnel, equipment and instruments necessary to carry out the sampling. Unless directed otherwise, all sampling procedures must follow the DEC sampling guidelines and protocols.
6. All sample containers shall be marked and identified with legible sample labels which shall indicate the project name, sample location and/or container, the sample number, the date and time of sampling, preservatives utilized and other information that may be useful in determining the character of the sample. Chain-of-custody shall be tracked from laboratory issuance of sample containers through laboratory receipt of the samples.

7. The Contractor shall maintain a bound sample logbook. The Contractor shall provide DDC access to it at all times and shall turn it over to the DDC in good condition at the completion of the work. The following information, as a minimum shall be recorded to the log:
  1. Sample identification number
  2. Sample location
  3. Field observation
  4. Sample type
  5. Analyses
  6. Date/time of collection
  7. Collector's name
  8. Sample procedures and equipment utilized
  9. Date sent to laboratory and name of laboratory
8. The City reserves the right to direct the Contractor to conduct alternative sampling in lieu of the parameters described in subsection B2, if the situation warrants. The substitute sampling parameters shall be of equal or lesser monetary value than those described in subsection B2, as determined by industry laboratory pricing standards.
9. Only dedicated sampling equipment may be used to collect these samples. All equipment involved in field sampling must be decontaminated before being brought to the sampling location, and must be properly disposed after use.
10. Soils exceeding any of the hazardous characteristic criteria meet the legal definition of hazardous soils (rather than non-hazardous contaminated soils) and shall be transported or disposed of under Item 8.01 H – Handling, Transporting and Disposal of Hazardous Soils. All analyses must be done by a laboratory that has received approval from the ELAP for the methods to be used. The Contractor must specify the laboratory in the MHP.

**8.01 C2.2 METHOD OF MEASUREMENT**

Quantities for samples shall be measured as the number of sets of samples that are tested. A set shall be defined as one (1) composite sample analyzed for the full range of parameters as specified in subsection B2.

**8.01 C2.3 PRICE TO COVER**

The unit price bid per set for Item 8.01 C2 shall include the cost of furnishing all labor, materials, equipment, plan, and insurance necessary for sampling, handling, transporting, testing, documentation, fees, permits and any other incidentals necessary to complete the work as specified herein for sampling and testing of contaminated/potentially hazardous soil.

*Payment will be made under:*

ITEM NUMBER	ITEM	PAYMENT UNIT
8.01 C2	Sampling and Testing of Contaminated/ Potentially Hazardous Soil for Disposal Parameters	Set

## ITEM 8.01 H HANDLING, TRANSPORTING, AND DISPOSAL OF HAZARDOUS SOILS

### 8.01 H.1 WORK TO INCLUDE

General: This work shall consist of the handling, transportation and disposal of soils or materials that are listed as hazardous wastes or exhibit any of the characteristics of a hazardous waste, namely ignitability, corrosivity, reactivity, and toxicity, as defined in 6 NYCRR Part 371, Section 371.3 and 40 CFR Section 261. For the purpose of this specification, soils shall be defined as any materials excavated below the pavement and base for pavement.

Contaminated soils determined to be hazardous under Item 8.01 C2 shall be handled, transported, and disposed of under Item 8.01 H in accordance with the specifications herein.

The independent Environmental Consultant retained by the Contractor, as specified under Item 8.01 S – Health and Safety, shall conduct sampling and analysis of above soils to determine which soils are hazardous.

All work under Item 8.01 H shall be performed under the direct supervision of the Contractor's Environmental Consultant, as approved by the Program Management, Office of Environmental and Geotechnical Services (OEGS).

The Contractor shall ensure that all operations associated with the handling, sampling, loading, transportation, and disposal of hazardous materials are in compliance with the applicable Federal, State, and Local statutes and regulations.

The Contractor shall document the excavation, handling, sampling, and testing, transportation and disposal of hazardous soils. The City shall be listed in the disposal documents as the waste generator.

The Contractor shall supply all equipment, material and labor required to conduct the specified work of this section.

The Contractor shall ensure that all operations associated with the handling, sampling, loading, transportation and disposal of hazardous soils are conducted in a manner to protect site personnel, the public and the environment, in accordance with all applicable Federal, State, and Local laws and regulations.

The Contractor shall decontaminate all equipment prior to its removal from the exclusion zone and/or following contact with hazardous materials, as detailed in Item 8.01 S - Health and Safety. Water generated during the decontamination process shall be disposed of under Item 8.01 W1 – Removal, Treatment and Discharge/Disposal of Contaminated Water.

- A. Material Handling Plan: Within forty-five (45) calendar days after award of Contract, the Contractor shall submit to the Program Management, OEGS for review, a Material Handling Plan (MHP). The MHP must be approved by the Program Management, OEGS, prior to the Contractor's commencement of work. The MHP shall, at a minimum, consist of:
1. The Contractor's procedures for identifying contaminated/potentially hazardous soils during excavation, including instrumentation and calibration procedures to be used.
  2. The Contractor's procedures for safely handling hazardous soils or soils which have not yet been tested but are believed to be potentially hazardous.
  3. Identification of the Contractor's proposed waste transporter(s). This information shall include:
    - a. Name and waste transporter permit number

- b. Address
  - c. Name of responsible contact for the hauler
  - d. Telephone number for the contact
  - e. Any and all necessary permit authorizations for each type of waste transported
  - f. Previous experience in performing the type of work specified herein
4. All staging/stockpiling areas (if stockpiling areas are intended and available), or alternate procedures that will be used. Alternate procedures could include, but are not limited to, agreements from the intended disposal or treatment facilities to accept boring data and/or analytical data previously obtained during the site characterization so that materials may be directly loaded into vehicles for shipment to the disposal facility or the use of off-site stockpiling locations approved by the DEC.
  5. A backup facility, should the staging/stockpile areas become unavailable, insufficient in area or not be present by some other unforeseen difficulty.
  6. Identification of the Contractor's two proposed United State Environmental Protection Agency (EPA) or DEC approved RCRA TSD facilities for hazardous soils.
  7. The Contractor shall submit the following information prior to any transportation of soils regarding the temporary and final off-site TSD or facilities where it is proposing to take hazardous soils. The expense of furnishing all information will be included in the Contractor's bid price:
    - a. General Information
      - (1) Facility name and the EPA identification number
      - (2) Facility location
      - (3) Name of responsible contact for the facility
      - (4) Telephone number for contact
      - (5) Signed letter of agreement to accept waste as specified in this contract
      - (6) Signed letter of agreement with a TSD for disposal of waste that may not be land-disposed
      - (7) Unit of measure utilized at each facility for costing purposes
    - b. A listing of all permits, licenses, letters of approval, and other authorizations to operate, which are currently held and valid for the proposed facility as they pertain to receipt and management of wastes derived from this Contract.
    - c. A listing of all permits, licenses, letters of approval, and other authorizations to operate which have been applied for by the proposed facility.
    - d. The Contractor shall specify and describe the disposal/containment unit(s) that the proposed facility will use to manage the waste. The Contractor shall identify the capacity available in the units and the capacity reserved for the subject waste.
    - e. The Contractor shall provide the date of the proposed facility(ies) last compliance inspection under RCRA.

- f. A list of all active (unresolved) compliance orders, agreements, enforcement notices or notices of violations issued to the proposed facility shall be approved. The source and nature of the cause of violation shall be stated, if known.
8. Description of all sampling and analyses that will be needed to obtain disposal facility approval.

#### **8.01 H.2 MATERIALS**

- A. Containers shall be watertight as required in the DOT regulations and must meet all applicable regulations including but not limited to those in Attachment 2.
- B. Polyethylene (20 mil. thickness minimum) to be placed under and (10 mil. thickness minimum) over soil piles. If soils are placed in drums, polyethylene must be placed over the drums.

#### **8.01 H1.3 CONSTRUCTION DETAILS**

##### **A. Material Handling**

1. The Contractor shall institute procedures to protect site personnel and the public from the non-hazardous and hazardous materials as described in Section 8.01 S - Health and Safety.
2. The Contractor shall handle hazardous soil as approved in the MHP.
3. Stockpiled materials at the temporary TSD facility shall be handled according to the facility requirements but at a minimum: shall be drummed or placed on and covered with polyethylene to protect against erosion and leaching into surrounding soils, the stockpile area shall be graded for positive drainage away from the pile, and shall be labeled while being held for sampling prior to permanent disposal.
4. Provide any dewatering that is necessary to complete the work. Water shall be disposed of in accordance with Item 8.01 W1 – Removal, Treatment and Discharge/Disposal of Contaminated Water.

##### **B. Off-Site Transportation and Disposal**

1. The Contractor shall furnish all labor, equipment and supplies required to transport hazardous materials from the work area to the off-site TSD facility(ies) and to acquire any other items and services required for transporting hazardous materials for storage and/or disposal at an approved off-site facility.
2. Weight Measurement
  - a. The Contractor shall submit the name and location of the facility where an off-site scale is located. The Contractor shall also submit a plan to the DDC for review outlining procedures on controlling trucks leaving the work site and on-route to the off-site scale. The Contractor shall be responsible for tracking all materials/vehicles from the site to the off-site scale.
  - b. The Contractor shall provide to the DDC certified tare and gross weight slips for each load received at the accepted facility which shall be attached to each returned manifest.

##### **3. General**

- a. Manifests: The Contractor shall organize and maintain the material shipment records/manifests required by law.
- b. The Contractor shall coordinate the schedule for truck arrival and material deliveries at the job site to meet the approved project schedule. The schedule shall be compatible with the availability of equipment and personnel for material handling at the job site.
- c. The Contractor shall inspect all vehicles leaving the project site to ensure that hazardous soils adhering to the wheels or under carriage are removed prior to the vehicle leaving the site.
- d. The Contractor shall obtain letters of commitment from the waste haulers and the TSD facility to haul and accept shipments. The letter shall indicate agreement to handle and accept the specified estimated quantities and types of material during the time period specified in the project schedule and any time extension as deemed as necessary.

4. Hauling

- a. The Contractor shall not deliver waste to any facility other than the TSD facility(ies) listed on the shipping manifest.
- b. The Contractor shall coordinate manifesting, placarding, of shipments, and vehicle decontamination. All quantities shall also be measured and recorded upon arrival at the TSD facility. If any deviation between the two records occurs, the matter is to be reported immediately to the DDC and to be resolved by the Contractor to the satisfaction of the DDC.
- c. The Contractor shall be held responsible, at its own expense, for any and all actions necessary to remedy situations involving material spilled in transit or mud and dust tracked off-site.
- d. The Contractor shall ensure that trucks are protected against contamination by properly covering and lining them with compatible material (such as polyethylene) or by decontaminating them prior to any use other than hauling hazardous materials.
- e. The Contractor shall be responsible for inspecting the access routes for road conditions, overhead clearance, and weight restrictions.
- f. The Contractor shall only use the transporter(s) identified in the MHP for the performance of work. Only a transporter with a current Part 364 Waste Transporter Permit from the DEC may transport this material. Any use of substitute or additional transporters must have previous written approval from the DDC at no additional cost to the City.
- g. The Contractor shall develop, document, and implement a policy for accident prevention.
- h. The Contractor shall not combine hazardous materials from other projects with material from this project.

- i. **The Contractor shall obtain for the City an EPA hazardous waste generator identification number and a representative of Program Management, OECS will review and sign the manifest as the generator.**
  - j. No materials shall be transported until approved by the DDC.
5. Off-Site Disposal
- a. The Contractor shall be responsible for acceptance of the materials at an approved TSD facility, for ensuring that the facility is properly permitted to accept the stated materials, and that the facility provides the stated storage and/or disposal services.
  - b. In the event that the identified and approved facility ceases to accept the stated materials or the facility ceases operations, it is the Contractor's responsibility to locate an alternate approved and permitted facility(ies) for accepting materials. The Contractor is responsible for making the necessary arrangements to utilize the facility(ies), and the alternate facility(ies) must be approved in writing by the DDC in the same manner and with the same requirements as for the original facility(ies). This shall be done with no extra cost or delay to the City.
  - c. The Contractor shall submit all results and weights to the DDC.
  - d. **The Contractor is responsible to pay all fees associated with the generation and disposal of all excavated hazardous waste. These fees include, but are not limited to, the New York State Department of Finance and Taxation (DFT) quarterly fees for hazardous waste and the New York State DEC annual hazardous waste regulatory fee program. The Contractor shall submit a copy of proof of payment to the DDC and Program Management, OECS.**
6. Equipment and Vehicle Decontamination
- The Contractor shall design and construct a portable decontamination station to be used to decontaminate equipment and vehicles exiting from the exclusion zone. The cost for this work shall be paid under Item 8.01 S - Health and Safety. Disposal of decontamination liquids is described under Item 8.01 W1 - Removal, Treatment and Discharge/Disposal of Contaminated Water.
7. Record Keeping
- The Contractor shall obtain manifest forms, and complete the shipment manifest records required by the appropriate regulatory agencies for verifying the material and quantity of each load in unit of volume and weight. Copies of each manifest shall be submitted to the DDC within four (4) business days following shipment, and within three (3) business days after notification of receipt of the facility. Any manifest discrepancies shall be reported immediately to the DDC and be resolved by the Contractor to the satisfaction of the DDC.

#### **8.01 H.4 METHOD MEASUREMENT**

Quantities for hazardous soil shall be measured in tons satisfactorily delivered to the treatment, storage or disposal facility. The tonnage will be determined by off-site truck scales, as per subsection 8.01 H1.3.B.2, that are capable of generating load tickets.

#### **8.01 H.5 PRICE TO COVER**

- A. The unit price bid per ton for Item 8.01 H shall include the cost of furnishing all labor, materials, equipment, plan, and insurance for excavation, handling, transportation, disposal, documentation, permits, fees, taxes, stockpiling, hauling, and any other incidentals necessary to complete the work as specified herein for handling, transporting and disposal of hazardous soils.
- B. Final disposal of non-hazardous materials shall be paid for under Item 8.01 C1 – Handling, Transporting and Disposal of Non-Hazardous Soils. Disposal of decontamination water shall be paid under Item 8.01 W1 – Removal, Treatment and Discharge/Disposal of Contaminated Water.
- C. The independent Environmental Consultant shall be paid under Item 8.01 S – Health and Safety.
- D. Backfill will be paid for under its respective item.

*Payment will be made under:*

ITEM NUMBER	ITEM	PAYMENT UNIT
8.01 H	Handling, Transporting, and Disposal of Hazardous Soils	Tons

#### **ITEM 8.01 S HEALTH AND SAFETY**

##### **8.01 S.1 WORK TO INCLUDE**

###### Health and Safety Requirements

###### A. Scope of Work

It is the Contractor's responsibility to stage and conduct his work in a safe manner. The Contractor shall implement a Health and Safety Plan (HASP) for contaminated/hazardous soil intrusive activities as set forth in Occupational Safety and Health Administration (OSHA) Standards 1910.120 and 1926.650-652. The Contractor shall ensure that all workers have at a minimum hazard awareness training. The Contractor shall segregate contaminated work area in secured exclusion zones. These zones shall limit access to Contractor personnel specifically trained to enter the work area. The exclusion zone shall be set up to secure the area from the public and untrained personnel. The project health and safety program shall apply to all construction personnel including persons entering the work area. In addition, the Contractor shall protect the public from on-site hazards, including subsurface contaminants associated with on-site activities. The HASP shall be signed off by a Certified Industrial Hygienist and reviewed by Program Management, Office of Environmental and Geotechnical Services (OEGS).

Work shall include, but not be limited to:

1. Implementation of a baseline medical program.
2. Providing safety equipment and protective clothing for site personnel, including maintenance of equipment on a daily basis; replacement of disposable equipment as required; decontamination of clothing, equipment and personnel; and providing all other health and safety measures.



3. Providing, installing, operating and maintaining on-site emergency medical first aid equipment as specified in this section for which payment is not provided under other pay items in this Contract.
4. Providing, installing, operating, maintaining and decommissioning all equipment and personnel decontamination facilities specified within this section, including, but not limited to, the decontamination pad, decontamination water supply, decontamination water collection equipment and all other items and services required for the implementation of the health and safety requirements for which pay items are not provided elsewhere in this Contract.
5. Provide the minimum health and safety requirements for excavation activities within the limits of this Contract.
6. Implement and enforce a HASP: The HASP as presented in these specifications is dynamic with provisions for change to reflect new information, new practices or procedures, changing site environmental conditions or other situations which may affect site workers and the public. The HASP will also address measures for community protection, accident prevention, personnel protection, emergency response/contingency planning, air monitoring, odor control and hazardous chemicals expected on site. Providing a Confined Space Entry Program as defined in the Occupational Safety and Health Act, Confined Space Entry Standard, 29 CFR 1910.146.

B. Environmental Consulting Services

The Contractor shall retain an independent Environmental Consultant to obtain all permits and perform all field screening, air monitoring, community air monitoring, soil sampling, and health and safety services. The independent Environmental Consultant shall at a minimum provide documentation to the Program Management, OEGS demonstrating the minimum requirements as set forth below:

1. The independent Environmental Consultant project supervisor on site and other designated key personnel shall have a minimum of three (3) years experience in the environmental field dealing with issues associated with contaminated soils. Such experience shall include oversight on environmental, specifically volatile organic compound and dust monitoring services as a routine part of its daily operations.
2. The independent Environmental Consultant must be experienced in work of this nature, size, and complexity and must have previous experience in working with the DEC.
3. The independent Environmental Consultant shall furnish a project listing identifying the location, nature of services provided, owner, owner's contact, contact's telephone number, project duration and value for at least five (5) projects within the last three (3) years.
4. If conditions within the exclusion zone are deemed hazardous, then the Contractor and its independent Environmental Consultant shall ensure that all personnel working within identified exclusion zones and/or involved (direct contact) with the handling, storage or transport of hazardous and contaminated materials shall have completed a minimum of forty (40) hours of Health and Safety Training on Hazardous Waste Sites in accordance with 29 CFR 1910.120(e). The training program shall be conducted by a qualified safety instructor. If conditions in the exclusion zone are deemed to be non-hazardous, the independent Environmental Consultant shall provide site specific training.
5. The Contractor shall ensure that on-site management and supervisors directly responsible for or who supervise employees engaged in hazardous waste operations shall receive the

training specified in above and at least eight (8) additional hours of specialized training on managing such operations at the time of job assignment.

C. Submittals

1. The Contractor shall submit, within forty-five (45) calendar days after the contract award, a written HASP as specified herein, to Program Management, OECS for review and comment. The Contractor shall make all necessary revisions required by Program Management, OECS and resubmit the HASP to the Program Management, OECS for acceptance. Start-up work for the project will not be permitted until written acceptance has been issued by the Program Management, OECS.
2. Daily safety logs shall be maintained by the Contractor and shall be submitted to the DDC either on request or on completion of the work. Training logs shall be maintained by the Contractor and submitted to the DDC either on request or on completion of the work. Daily logs on air monitoring during excavation activities shall be prepared and maintained by the Contractor and submitted to the DDC either on request or upon completion of the work.
3. A closeout report shall be submitted by the Contractor to the DDC upon completion of the work within the defined exclusion zones. This report shall summarize the daily safety and monitoring logs and provides an overview of the Contractor's performance regarding environmental and safety issues. The report shall carefully document all areas where contamination has been found including pictures, addresses of locations, and potential sources.
4. Medical Surveillance Examinations: The Contractor shall submit to the DDC the name, office address and telephone number of the medical consultant utilized. Evidence of baseline medical examinations together with the evidence of the ability to wear National Institute for Occupational Safety and Health (NIOSH) approved respirators (as specified in American National Standards Institute (ANSI) Z88.6) shall be provided to the DDC for all construction personnel who are to enter the exclusion zones.
5. Accident Reports: All accidents, spills, or other health and safety incidents shall be reported to the DDC.

D. Health and Safety Plan

The HASP shall comply with OSHA regulations 29 CFR 1910.120/1926.65. This document shall at a minimum contain the following:

1. Description of work to be performed
2. Site description
3. Key personnel
4. Worker training procedures
5. Work practices and segregation of work area
6. Hazardous substance evaluation
7. Hazard assessment
8. Personal and community air monitoring procedures and action levels
9. Personal protective equipment
10. Decontamination procedures
11. Safety rules
12. Emergency procedures
13. Spill control, dust control, vapor/odor suppression procedures
14. Identification of the nearest hospital and route
15. Confined space procedures

16. Excavation safety procedures

**8.01 S.2 MEASUREMENT**

Health and Safety Requirements

- A. 25% of the lump sum price will be paid when the following items are implemented or mobilized:
- Medical surveillance program
  - Health and safety training
  - Health and safety plan
  - Environmental and personnel monitoring
  - Instrumentation
  - Spill control
  - Dust control
  - Personnel and equipment decontamination facilities
  - Personnel protective clothing
  - Communications
  - Mobilization
- B. 50% will be paid in proportional monthly amounts over the period of work.
- C. 25% will be paid when the operation is demobilized and removed from the project site.

**8.01 S.3 PRICE TO COVER**

Health and Safety Requirements

The lump sum price bid for the health and safety requirements shall include all labor, materials, equipment, and insurance necessary to complete the work in accordance with these specifications. The price bid shall include, but not be limited to, the following:

- A. Providing training, safety personnel, air monitoring and medical examinations as specified.
- B. Providing safety equipment and protective clothing for site personnel, including maintenance of equipment on a daily basis; replacement of disposable equipment as required; decontamination of clothing, equipment and personnel; and all other health and safety activities or costs not paid for under other pay items in this Contract.
- C. Providing, installing, operating and maintaining on-site emergency medical and first aid equipment. This includes all furnishings, equipment, supplies and maintenance of all medical equipment, and all other health and safety items and services for which payment is not provided under other pay items in this Contract.
- D. Providing, installing, operating, maintaining, and decommissioning all personnel and equipment decontamination facilities, including decontamination pad, decontamination water supply, and all other items and services required for the implementation of the health and safety requirements for which pay items are not provided elsewhere in this Contract. Vehicle decontamination pads shall be included in the price of this item. Disposal of decontamination fluid shall be paid for under Item 8.01 W1 – Removal, Treatment and Discharge/Disposal of Contaminated Water.
- E. Spill Control
1. Payment shall account for furnishing, installing, and maintaining all spill control equipment and facilities. Payment will include equipment and personnel to perform

emergency measures required to contain any spillage and to remove spilled materials and soils or liquids that become contaminated due to spillage during work within the exclusion zones and handling of excavated soils and liquids from these areas. This collected spill material will be properly disposed of.

2. Payment under this item shall not include testing, handling, transportation or disposal of petroleum-contaminated/potentially hazardous soils excavated during construction. The price for this work will be paid for under Items 8.01 C1 – Handling, Transporting and Disposal of Non-Hazardous Contaminated Soils, 8.01 C2 – Sampling and Testing of Contaminated/Potentially Hazardous Soil for Disposal Parameters or 8.01 H – Handling, Transporting and Disposal of Hazardous Soils, as appropriate.

F. Dust Control

Payment shall account for furnishing, installing, and maintaining dust control equipment and facilities to be used whenever applicable dust levels are exceeded. Payment will include all necessary labor, equipment, clean water, foam, and all other materials required by the Dust Control Plan. The DOH Community Air Monitoring Plan (CAMP) may be used as guidance.

G. Vapor/Odor Suppression

Payment shall account for furnishing, installing and maintaining vapor/odor control equipment and facilities to be used whenever organic vapor monitoring or the presence of odors indicates that vapor suppression is required to protect workers or the public. Payment will include all necessary labor, equipment, clean water, foam and all other materials required by the Vapor/Odor Suppression Plan.

H. Mobilization/Demobilization

1. Mobilization

Payment shall include but not be limited to:

- a. All work required to furnish, install and maintain all signs, fencing, support zone facilities, parking areas and all temporary utilities;
- b. All work required to furnish, install, and maintain an office space with phone and utilities for health and safety personnel;
- c. All work required for complete preparation of lay down area for roll-off containers, including sampling, and any required fencing;
- d. All direct invoiced cost from bonding companies and government agencies for permits and costs of insurance; and
- e. All other items and services required for mobilization and site preparation.

2. Demobilization

Payment shall include but not be limited to: All work required to sample the area; remove from the site all equipment, temporary utilities and supporting facilities; performance of necessary decontamination and repairs; disposal of disposable equipment and protective gear and other items and services required for complete demobilization.

*Payment will be made under:*

ITEM NUMBER	ITEM	PAYMENT UNIT
8.01 S	Health and Safety	Lump Sum

## **ITEM 8.01 W1 REMOVAL, TREATMENT, AND DISCHARGE/DISPOSAL OF CONTAMINATED WATER**

### **8.01 W1.1 WORK TO INCLUDE**

General: This work shall consist of the proper removal and disposal of all contaminated groundwater and decontamination water generated during construction operations. The Contractor shall be solely responsible for the proper disposal or discharge of all contaminated water generated at the job site. The Contractor will have the option of treating water on-site for discharge to the combined sanitary/storm sewer system or removing contaminated water for off-site disposal. The Contractor shall be responsible to choose a method compatible to the construction work and shall be compensated on a per day basis regardless of method employed. The Contractor will be compensated for only those days where the system is in full operation.

The Contractor shall retain a dewatering/water treatment Specialist (hereinafter the "Specialist") and laboratory as specified under Item 8.01 W2 – Sampling and Testing of Contaminated Water, to conduct any testing that may be required for disposal of impacted water.

The dewatering/water treatment Specialist is responsible to obtain all permits; perform all water sampling, testing; and provide ancillary services related to dewatering and water treatment. The Specialist shall at a minimum provide documentation to the Program Management, Office of Environmental and Geotechnical Services (OEGS) demonstrating the minimum requirements as set forth below:

1. The Specialist shall demonstrate that it has, at a minimum, three (3) years experience in the design of dewatering plans. The Specialist should demonstrate expertise dealing with issues associated with contaminated water. During that three (3) year period, the Specialist shall demonstrate that it provided dewatering and water treatment systems as a routine part of its daily operations.
2. The Specialist must be experienced in work of this nature, size, and complexity and must have previous experience in working with the DEC.
3. The Specialist shall furnish a project listing identifying the location, nature of services provided, owner, owner's contact, contact's telephone number, project duration and value for at least five (5) projects within the last three (3) years of a similar nature, size, and complexity to this one.
4. If conditions within the exclusion zone are deemed hazardous, then the Contractor and its independent Environmental Consultant shall ensure that all personnel working within identified exclusion zones and/or involved (direct contact) with the handling, storage or transport of hazardous and contaminated material shall have completed a minimum of forty (40) hours of Health and Safety Training on Hazardous Waste Sites in accordance with 29 CFR 1910.120(e). The training program shall be conducted by a qualified safety instructor. If conditions in the exclusion zone are deemed to be non-hazardous, the Specialist shall be responsible to provide site-specific training to its employees and other affected personnel.
5. The Contractor shall ensure that on-site management and supervisors directly responsible for or who supervise employees engaged in hazardous waste operations shall receive the training specified in above and at least eight (8) additional hours of specialized training on managing such operations at the time of job assignment.

The Contractor shall document all operations associated with the handling, sampling and disposal of contaminated water, and ensure that they are in compliance with applicable Federal, State and Local statutes and regulations.

The Contractor shall supply all labor, equipment, transport, plant, material, treatment, and other incidentals required to conduct the specified work of this section.

If water will be disposed of into the combined sanitary/storm sewer system, the Contractor shall ensure the Specialist treats the water to comply with the New York City Department of Environmental Protection (DEP) Sanitary/Combined and Storm Sewer Effluent Limit concentrations prior to discharge. The Contractor is responsible for providing settling or filtering tanks and any other apparatus required by DEP. Alternatively, the Contractor can provide a plan for transport and disposal at an off-site waste disposal facility.

Within forty-five (45) calendar days after award of Contract, the Contractor shall submit to the Program Management, OEGS for review, a Water Handling Plan (WHP). The WHP must be approved by the Program Management, OEGS, prior to the Contractor's commencement of work. The minimum requirements for the WHP are specified herein Item 8.01W 1.2, for each type of disposal (disposal into the combined sanitary/storm sewer or off-site disposal). The Contractor shall maintain a complete, up to date copy of the WHP on the job site at all times.

#### **8.01 W1.2 CONSTRUCTION DETAILS**

For each disposal method the Contractor proposes to utilize (disposal to combined sanitary/storm sewer or off-site disposal), the WHP shall include the information required in paragraphs A and B below, as appropriate.

##### **A. On-site treatment and discharge into New York City combined sanitary/storm sewers.**

1. Regulations: The Contractor shall comply with all applicable regulations. This includes but may not be limited to:  
Title 15-New DEP Sewer Use Regulations.
2. Permits: The Contractor is solely responsible to obtain all necessary and appropriate Federal, State and Local permits and approvals. The Contractor will be responsible for performing all and any system pilot tests required for permit approval. This includes but may not be limited to:
  - a. Industrial waste approval for the New York City sewer system.
  - b. Groundwater discharge permit for the New York City sewer system (DEP Division of Sewer Regulation and Control), if discharge to sewer exceeds 10,000 gallons per day.
  - c. The Contractor shall comply with DEC State Pollutant Discharge Elimination System (SPDES) Permit Number GP-0-10-001, General Permit for Stormwater Discharges.
  - d. Long Island well point permit for Brooklyn and Queens sites, if well points are used for dewatering.
  - e. Wastewater quality control application, DEP.
3. The WHP for this portion of the work shall include at a minimum:

- a. Identification and design of Contractor's proposed treatment to assure that the water meets the DEP sewer use guidelines prior to discharge to the sewer, including identification of all materials, procedures, settling or filtering tanks, filters and other appurtenances proposed for treatment and disposal of contaminated water.
  - b. The name, address and telephone number of the contact for the Contractor's proposed chemical laboratory, as well as the laboratory's certifications under Federal, State or non-governmental bodies.
  - c. The name, address and telephone number of the contact for the Contractor's proposed independent Environmental Consultant.
  - d. Copies of all submitted permit applications and approved permits the Contractor have received.
4. Materials
- The Contractor shall supply all settling or filtering tanks, pumps, filters, treatment devices and other appurtenances for treatment, temporary storage and disposal of contaminated water. All equipment shall be suitable for the work described herein.
5. Execution
- a. The Contractor is solely responsible for disposal of all water, in accordance with all Federal, State and Local regulations.
  - b. The Contractor is solely responsible for any treatment required to assure that water discharged into the sewer is in compliance with all permits and Federal, State and Local statutes and regulations.
  - c. The Contractor is solely responsible for the quality of the water disposed of into the sewers.
  - d. The Contractor is responsible for sampling and testing of water for the DEP Sanitary/Combined and Storm sewer Effluent Limit concentrations. The quality of the data is the Contractor's responsibility. Any sampling and testing shall be conducted and paid in accordance with Item 8.01 W2 – Sampling and Testing of Contaminated Water.
  - e. The Contractor shall be responsible to maintain the discharge rate to the sewer such that all permit requirements are met, the capacity of the sewer is not exceeded and no surcharging occurs downstream due to the Contractor's actions. Dewatering by means of well points or deep wells will not be allowed in the Boroughs of Brooklyn or Queens where the rate of pumping exceeds forty-five (45) gallons per minute unless the appropriate permit has been secured from the DEC.
  - f. Disposal of Treatment Media
    - (1) The Contractor shall be responsible for disposal or recycling of treatment media in accordance with all Federal, State and Local regulations.

- (2) The Contractor shall provide the DDC with all relevant documentation concerning the disposal of treatment media, including manifests, bills of lading, certificates of recycling or destruction and other applicable documentation.
- (3) **Disposal of treatment media shall not be considered as a separate pay item; instead it shall be considered as incidental work thereto and included in the unit price bid.**

B. Off-Site Disposal

1. Regulations: The Contractor shall conform to all applicable Federal, State and Local regulations pertaining to the transportation, storage and disposal of any hazardous and/or non-hazardous materials as listed in Attachment 2.
2. The following shall be submitted to the DDC prior to initiating any off-site disposal:
  - a.
    - (1) Name and waste transporter permit number
    - (2) Address
    - (3) Name of responsible contact for the hauler
    - (4) Any and all necessary permit authorizations for each type of waste transported
    - (5) Previous experience in performing the type of work specified herein
  - b. General information for each proposed treatment/disposal facility and at least one backup treatment/disposal facility
    - (1) Facility name and EPA identification number
    - (2) Facility location
    - (3) Name of responsible contact for the facility
    - (4) Telephone number for contact
    - (5) Unit of measure utilized at facility for costing purposes
  - c. A listing of all permits, licenses, letters of approval and other authorizations to operate, which are currently held and valid for the proposed facility as they pertain to receipt and management of the wastes derived from this Contract.
  - d. A listing of all permits, licenses, letters of approval and other authorizations to operate which have been applied for by the proposed facility but not yet granted or issued. Provide dates of application(s) submitted. Planned submittals shall also be noted.
  - e. The Contractor shall specify and describe the disposal/containment unit(s) that the proposed facility will use to manage the waste and provide dates of construction and beginning of use, if applicable. Drawings may be provided. The Contractor shall identify the capacity available in the units and the capacity reserved for the subject waste.



- f. The Contractor shall provide the date of the proposed facility's last compliance inspection.
- g. A list of all active (unresolved) compliance orders, agreements, enforcement notices or notices of violations issued to the proposed facility shall be submitted. The source and nature of the cause of violation shall be stated, if known. If groundwater contamination is noted, details of the facility's groundwater monitoring program shall be provided.
- h. Description of all sampling and field/laboratory analyses that will be needed to obtain disposal facility approval.

3. Materials

All vessels for temporary storage and transport to an off-site disposal facility shall be as required in DOT regulations.

4. Execution

a. General

- (1) The Contractor shall organize and maintain the material shipment records/manifests required by Federal, State and Local law. The Contractor shall include all bills of lading, certificates of destruction, recycling or treatment and other applicable documents.
- (2) The Contractor shall coordinate the schedule for truck arrival and material deliveries at the job site to meet the approved project schedule. The schedule shall be compatible with the availability of equipment and personnel for material handling at the job site.
- (3) The Contractor shall inspect all vehicles leaving the project site to ensure that contaminated liquids are not spilling and are contained for transport.
- (4) The Contractor shall obtain letters of commitment from the waste haulers and the treatment, disposal or recovery facility to haul and accept shipment. The letter shall indicate agreement to handle and accept the specified estimated quantities and types of material during the time period specified in the project schedule and any time extension as deemed as necessary.
- (5) The Contractor shall verify the volume of each shipment of water from the site.
- (6) The Contractor is responsible for sampling and testing of water for off-site disposal. The quality of the data is the Contractor's responsibility. Any sampling and testing shall be conducted and paid in accordance with Item 8.01 W2 – Sampling and Testing of Contaminated Water.
- (7) The Contractor shall be responsible for any additional analyses required by the TSD facility, and for the acceptance of the water at an approved TSD facility.

b. Hauling

- (1) The Contractor shall not deliver waste to any facility other than the TSD facility(ies) listed on the shipping manifest.
- (2) The Contractor shall coordinate manifesting, placarding of shipments, and vehicle decontamination. All quantities shall also be measured and recorded upon arrival at the TSD facility(ies). If any deviation between the two records occurs, the matter is to be reported immediately to the DDC and shall be resolved by the Contractor to the satisfaction of the DDC.
- (3) The Contractor shall be held responsible for any and all actions necessary to remedy situations involving material spilled in transit or mud and dust tracked off-site. This cleanup shall be accomplished at the Contractor's expense.
- (4) The Contractor shall be responsible for inspecting the access routes for road conditions, overhead clearance and weight restrictions.
- (5) The Contractor shall only use the transporter(s) identified in the WHP for the performance of work. Only a transporter with a current Part 364 Waste Transporter Permit from DEC may transport this material. Any use of substitute or additional transporters must have previous written approval from the DDC at no additional cost to the City.
- (6) The Contractor shall develop, document, and implement a policy for accident prevention.
- (7) The Contractor shall not combine waste materials from other projects with material from this project.
- (8) The Contractor shall obtain for the City a hazardous waste generator identification number and will sign the manifest as the generator, if necessary.
- (9) No material shall be transported until approved by the DDC.

c. Disposal Facilities

- (1) The Contractor shall use only the TSD facility(ies) identified in the WHP for the performance of the work. Substitutions or additions shall not be permitted without prior written approval from the Program Management, OEGS, and, if approved, shall be at no extra cost to the City.
- (2) The Contractor shall be responsible for acceptance of the material at an approved TSD facility, for ensuring that the facility is properly permitted to accept the stated material, and that the facility provides the stated storage and/or disposal services.
- (3) The DDC reserves the right to contact and visit the disposal facility and regulatory agencies to verify the agreement to accept the stated material and to verify any other information provided. This does not in any way relieve the Contractor of his responsibilities under this Contract.
- (4) In the event that the identified and approved facility ceases to accept the stated materials or the facility ceases operations, it is the Contractor's

responsibility to locate an alternate approved and permitted facility(ies) for accepting materials. The Contractor is responsible for making the necessary arrangements to utilize the facility(ies), and the alternate facility(ies) must be approved in writing by the DDC in the same manner and with the same requirements as for the original facility(ies). This shall be done with no extra cost or delay to the City.

d. Equipment and Vehicle Decontamination

- (1) The Contractor shall design and construct a portable decontamination station to be used to decontaminate equipment and vehicles exiting the exclusion zone. The cost for this work shall be paid under Item 8.01 S – Health and Safety.

**8.01 W1.3 METHOD OF MEASUREMENT**

The quantity for on-site treatment and discharge or off-site disposal shall be on a per day basis.

**8.01 W1.4 PRICE TO COVER**

- A. The per day price bid for Item 8.01 W1 shall include the cost of furnishing all labor, materials, equipment, plan, and insurance for handling, transportation, disposal, documentation, permits, hauling, mobilization and demobilization, and any other incidentals thereto to complete the work.
- B. The Contractor will not be paid for water that is within the DEP Sewer Discharge Limits.

*Payment will be made under:*

ITEM NUMBER	ITEM	PAYMENT UNIT
8.01 W1	Removal, Treatment and Disposal/Discharge of Contaminated Water	Day

**ITEM 8.01 W2 SAMPLING AND TESTING OF CONTAMINATED WATER**

**8.01 W2.1 WORK TO INCLUDE**

A. Description

The work shall consist of sampling and testing of potentially contaminated groundwater, surface runoff within the excavated area and all contaminated water generated during the decontamination process.

B. Sampling and Testing

- 1. The Contractor is responsible, at a minimum, for sampling and testing of contaminated water for the DEP Sanitary/Combined and Storm Sewer Effluent Limit concentrations as listed in Attachment 1. The quality of the data is the Contractor's responsibility. Any additional testing required by the Federal, State and/or disposal facilities shall be included in the bid price of this Item.

2. All sampling and testing shall be conducted by a person trained in sampling protocols using accepted standard practices and/or the DEC sampling guidelines and protocols.
3. All sample containers shall be marked with legible sample labels which shall indicate the project name, sample location and/or container, the sample number, the date and time of sampling, preservatives utilized, how the sample was chilled to 4 degrees Celsius, and other information that may be useful in determining the character of the sample.
4. Chain-of-custody shall be tracked from laboratory issuance of sample containers through receipt of the samples.
5. The Contractor shall maintain a bound sample log book. The Contractor shall provide the DDC access to it at all times and shall turn it over to the DDC in good condition at the completion of the work. The following information, as a minimum, shall be recorded to the log:
  - a. Sample identification number
  - b. Sample location
  - c. Field observation
  - d. Sample type
  - e. Analyses
  - f. Date/time of collection
  - g. Collector's name
  - h. Sample procedures and equipment used
  - i. Date sent to laboratory/name of laboratory
6. Only dedicated sampling equipment may be used to collect these samples. All equipment involved in field sampling must be decontaminated before being brought to the site, and must be properly disposed of after use.
7. Samples shall be submitted to the Contractor's laboratory within the holding times for the parameters analyzed.
8. All analyses must be done by a laboratory that has received approval from the DOH's ELAP for the methods to be done. The Contractor must specify the laboratory in the WHP.
9. Analytical results for water discharged to the sewer and for off-site disposal must be submitted to the DDC no later than five (5) days after sample collection.
10. The City reserves the right to direct the Contractor to conduct alternative sampling in lieu of the parameters described above, if the situation warrants. The substitute sampling parameters shall be of equal or lesser monetary value than those described above, as determined by industry laboratory pricing standards.

**8.01 W2.2 METHOD OF MEASUREMENT**

Quantities for samples shall be measured as the number of sets of samples that are tested for the DEP Sanitary/Combined and Storm Sewer Effluent Limit concentrations. A set shall be defined as one (1) representative sample analyzed for the full range of DEP parameters as specified in attachment 1.

**8.01 W2.3 PRICE TO COVER**

The unit price bid per set for Item 8.01 W2 shall include the cost of furnishing all labor, materials, equipment, plan, and insurance for handling, transport, sampling, testing, documentation, permits, other incidentals necessary to complete the work of sampling and testing of contaminated water. Any additional costs incurred by the Contractor for sampling and testing of contaminated water shall be included in the bid price of this Item.

*Payment will be made under:*

<u>ITEM NUMBER</u>	<u>ITEM</u>	<u>PAYMENT UNIT</u>
8.01 W2	Sampling and Testing of Contaminated Water	Set

**ATTACHMENT 1: NYCDEP LIMITATIONS FOR DISCHARGE TO STORM,  
SANITARY/COMBINED SEWER**

**NEW YORK CITY DEPARTMENT OF ENVIRONMENTAL PROTECTION  
BUREAU OF WASTEWATER TREATMENT**

**Limitations for Effluent to Sanitary or Combined Sewers**

Parameter <sup>1</sup>	Daily Limit	Units	Sample Type	Monthly Limit
Non-polar material <sup>2</sup>	50	mg/l	Instantaneous	---
pH	5-11	SU's	Instantaneous	---
Temperature	< 150	Degree F	Instantaneous	---
Flash Point	> 140	Degree F	Instantaneous	---
Cadmium	2 0.69	mg/l mg/l	Instantaneous Composite	--- --
Chromium (VI)	5	mg/l	Instantaneous	---
Copper	5	mg/l	Instantaneous	---
Lead	2	mg/l	Instantaneous	---
Mercury	0.05	mg/l	Instantaneous	---
Nickel	3	mg/l	Instantaneous	---
Zinc	5	mg/l	Instantaneous	---
Benzene	134	ppb	Instantaneous	57
Carbontetrachloride	---	---	Composite	---
Chloroform	---	---	Composite	---
1,4 Dichlorobenzene	---	---	Composite	---
Ethylbenzene	380	ppb	Instantaneous	142
MTBE (Methyl-Tert-Butyl-Ether)	50	ppb	Instantaneous	---
Naphthalene	47	ppb	Composite	19
Phenol	---	---	Composite	---
Tetrachloroethylene (Perc)	20	ppb	Instantaneous	---
Toluene	74	ppb	Instantaneous	28
1,2,4 Trichlorobenzene	---	---	Composite	---
1,1,1 Trichloroethane	---	---	Composite	---
Xylenes (Total)	74	ppb	Instantaneous	28
PCB's (Total) <sup>3</sup>	1	ppb	Composite	---
Total Suspended Solids (TSS)	350 <sup>4</sup>	mg/l	Instantaneous	---
CBOD <sup>5</sup>	---	---	Composite	---
Chloride <sup>5</sup>	---	---	Instantaneous	---
Total Nitrogen <sup>5</sup>	---	---	Composite	---
Total Solids <sup>5</sup>	---	---	Instantaneous	---

- 1 All handling and preservation of collected samples and laboratory analyses of samples shall be performed in accordance with 40 C.F.R. pt. 136. If 40 C.F.R. pt. 136 does not cover the pollutant in question, the handling, preservation, and analysis must be performed in accordance with the latest edition of "Standard Methods for the Examination of Water and Wastewater." All analyses shall be performed using a detection level less than the lowest applicable regulatory discharge limit. If a parameter does not have a limit, then the detection level is defined as the least of the Practical Quantitation Limits identified in NYSDEC's Analytical Detectability and Quantitation Guidelines for Selected Environmental Parameters, December 1988
- 2 Analysis for *non-polar materials* must be done by EPA method 1664 Rev. A. Non-Polar Material shall mean that portion of the oil and grease that is not eliminated from a solution containing N-Hexane, or any other extraction solvent the EPA shall prescribe, by silica gel absorption.
- 3 Analysis for PCB=s is required if *both* conditions listed below are met:
  - 1) if proposed discharge  $\geq$  10,000 gpd;
  - 2) if duration of a discharge > 10 days.Analysis for PCB=s must be done by EPA method 608 with MDL= $\leq$ 65 ppt. PCB's (total) is the sum of PCB-1242 (Arochlor 1242), PCB-1254 (Arochlor 1254), PCB-1221 (Arochlor 1221), PCB-1232 (Arochlor 1232), PCB-1248 (Arochlor 1248), PCB-1260 (Arochlor 1260) and PCB-1016 (Arochlor 1016).
- 4 For discharge  $\geq$  10,000 gpd, the TSS limit is 350 mg/l. For discharge < 10,000gpd, the limit is determined on a case by case basis.
- 5 Analysis for Carbonaceous Biochemical Oxygen Demand (CBOD), Chloride, Total Solids and Total Nitrogen are required if proposed discharge  $\geq$  10,000 gpd.



**ATTACHMENT 2: APPLICABLE REGULATIONS**

Applicable regulations include, but are not limited to:

1. 49 CFR 100 to 179 - DOT Hazardous Materials Transport and Manifest System Requirements
2. New York State Department of Environmental Conservation (DEC), Spills Technology and Remediation Series (STARS) Memo #1
3. 6 NYCRR 360-1 DEC Solid Waste Management Facilities
4. 6 NYCRR 364- Waste Transporter permits
5. Local restrictions on transportation of waste/debris
6. 40 CFR 260 to 272 - Hazardous Waste Management (RCRA)
7. 6 NYCRR 371 - Identification and Listing of Hazardous Wastes
8. 6 NYCRR 372 - Hazardous Waste Manifest System and Related Standards for Generators, Transporters and Facilities
9. 6 NYCRR 373-1 - Hazardous Waste Treatment, Storage and Disposal Facility Permitting Requirements
10. 6 NYCRR 376 - Land Disposal Restrictions
11. Posted weight limitations on roads or bridges
12. Transportation Skills Programs, Inc. 1985 - Hazardous Materials and Waste Shipping Papers and Manifests
13. Other local restrictions on transportation of waste/debris
14. Occupational Safety and Health Administration (OSHA), Standards and Regulations, 29 CFR 1910 (General Industry)
15. OSHA 29 CFR 1910.120 Hazardous Waste Operations and Emergency Response
16. OSHA Safety and Health Standards 29 CFR 1926 (Construction Industry)
17. OSHA 29 CFR 1910.146 Confined Space Entry Standard
18. Standard Operating Safety Guidelines, EPA Office of Emergency and Remedial Response Publication, 9285.1-03
19. NIOSH / OSHA / USCG / EPA Occupational Safety and Health Guidance Manual for Hazardous Waste Site Activities (1986)
20. U.S. Department of Health and Human Services (DHHS) "NIOSH Sampling and Analytical Methods," DHHS (NIOSH) Publication 84-100
21. ANSI, Practice for Respiratory Protection, Z88.2 (1980)
22. ANSI, Emergency Eyewash and Shower Equipment, Z41.1 (1983)
23. ANSI, Protective Footwear, Z358.1 (1981)
24. ANSI, Physical Qualifications for Respirator Use, Z88.6 (1984)
25. ANSI, Practice for Occupational and Educational Eye and Face Protection, Z87.1 (1968)
26. Water Pollution Control Federation "Manual of Practice No. 1, Safety in Wastewater Works"

27. NFPA No. 327 "Standard Procedures for Cleaning and Safeguarding Small Tanks and Containers"
28. Occupational Safety and Health Act Confined Space Entry Standard 29 CFR 1910.146.87
29. Department of Transportation 49 CFR 100 through 179
30. Department of Transportation 49 CFR 387 (46 FR 30974, 47073)
31. Environmental Protection Agency 40 CFR 136 (41 FR 52779)
32. Environmental Protection Agency 40 CFR 262 and 761
33. Resource Conservation and Recovery Act (RCRA)
34. Any transporter of hazardous or non-hazardous materials shall be licensed in the State of New York and all other states traversed in accordance with all applicable regulations.

**ATTACHMENT 3: DEFINITIONS**

- Contaminated Groundwater and Decontamination Fluids:** Groundwater within the excavation trench or decontamination water that contains regulated compounds above the NYCDEP Discharge to Sanitary/Combined Sewer Effluent limits.
- Disposal or Treatment Facility:** A facility licensed to accept either non-hazardous regulated waste or hazardous waste for either treatment or disposal.
- Exclusion Zone:** Work area that will be limited to access by Contractor personnel specifically trained to enter the work area only. The exclusion zone will be set up to secure the area from the public and untrained personnel. The project health and safety program will apply to all construction personnel including persons entering the work area.
- Hazard Assessment:** An assessment of any physical hazards that may be encountered on a work site.
- Hazardous Soils:** Soils that exhibit any of the characteristics of a hazardous waste, namely ignitability, corrosivity, reactivity, and toxicity, as defined in 6 NYCRR Part 371, Section 371.3 and 40 CFR Section 261.
- Hazardous Substance Evaluation:** An evaluation of the possible or known presence of any hazardous substances that may be encountered on a job site. This evaluation is included in the Health and Safety Plan and will include the identification and description of any hazardous substances expected to be encountered. Material Safety Data Sheets (MSDS) will be included for each substance.
- Health and Safety Plan:** A plan employed at a work site that describes all the measures that will be taken to assure that all work is conducted in a safe manner, and that the health of the workers and the public will be insured.
- Material Handling Plan:** A plan outlining the methods that will be employed to handle, transport and dispose of contaminated materials.
- Non-Hazardous Contaminated Soils:** Soils which exhibit a distinct chemical or petroleum odor, or exhibit elevated photoionization detector readings but are not classified as hazardous waste under 6 NYCRR Part 371, Section 371.3 and 40 CFR Section 261.
- New York State Health Department's Environmental Laboratory Approval Program:** A program by which the state of New York approves and accredits environmental testing laboratories.
- PCBs:** Polychlorinated biphenyls are a group of toxic compounds commonly used as a coolant in transformers and other electrical components.
- Photoionization Detector:** A hand held instrument used to measure volatile organic compounds in air. The instrument ionizes the organic molecules through the use of an ultraviolet lamp.
- RCRA Hazardous Waste Characteristics:** Characteristics of a material which may indicate the material is hazardous. These include: ignitability, corrosivity, reactivity, and toxicity.
- Total Petroleum Hydrocarbons:** An analytical procedure used to determine the total amount of petroleum compounds in a material.

**ATTACHMENT 4: PHASE II SUBSURFACE CORRIDOR INVESTIGATION REPORT**

- Final -

**Phase II Subsurface Corridor Investigation Report**

**For**

**Beach Channel Drive**

**Beach Channel Drive between Beach 108<sup>th</sup> Street and Beach 145<sup>th</sup> Street**

**Queens, New York**

DDC PROJECT NO. SANDHW11

WOL No. 11364-LBA-4-10691

CONTRACT REGISTRATION NO. 20151405733

Prepared for:



Office of Environmental and Geotechnical Services

30-30 Thomson Avenue, 3<sup>rd</sup> Floor

Long Island City, New York 11101

Prepared by:



**Louis Berger**

Louis Berger & Assoc., P.C.

48 Wall Street, 16<sup>th</sup> Floor

New York, NY 10005

Tel. (212) 612-7900 Fax (212) 363-4341

PROJECT NO. 2011040.093

September 6, 2016

**TABLE OF CONTENTS**

**EXECUTIVE SUMMARY ..... 1**

**1.0 INTRODUCTION ..... 1**

    1.1 SUMMARY OF PREVIOUS ENVIRONMENTAL INVESTIGATIONS .....2

    1.2 SCOPE OF WORK .....4

**2.0 CORRIDOR INFORMATION ..... 6**

    2.1 CORRIDOR LOCATION, DESCRIPTION AND USE .....6

    2.2 DESCRIPTION OF SURROUNDING PROPERTIES .....6

    2.3 CORRIDOR AND REGIONAL TOPOGRAPHIC SETTING .....7

    2.4 CORRIDOR AND REGIONAL GEOLOGY .....7

    2.5 CORRIDOR AND REGIONAL HYDROGEOLOGY .....8

**3.0 CORRIDOR EVALUATION..... 9**

    3.1 SOIL QUALITY INVESTIGATION .....9

    3.2 GROUNDWATER QUALITY INVESTIGATION .....13

    3.3 LABORATORY ANALYSES .....13

    3.4 DATA EVALUATION .....14

**4.0 FINDINGS ..... 15**

    4.1 FIELD SCREENING .....15

    4.2 LABORATORY ANALYTICAL RESULTS .....15

        4.2.1 Target Compound List (TCL) Volatile Organic Compounds (VOCs) in Soil..... 15

        4.2.2 Polycyclic Aromatic Hydrocarbons (PAHs) in Soil..... 15

        4.2.3 Polychlorinated Biphenyls (PCBs) in Soil..... 16

        4.2.4 Waste Classification of Soil ..... 16

        4.2.5 Analysis of NYCDEO Discharge Parameters in Groundwater ..... 16

**5.0 CONCLUSIONS AND RECOMMENDATIONS ..... 18**

**6.0 STATEMENT OF LIMITATIONS..... 22**

**Tables**

**1** Summary of Environmental Boring Data

**2** Summary of TCL VOCs Detected in Soil

**3** Summary of PAHs Detected in Soil

**4** Summary of PCBs Detected in Soil

**5** Summary of Waste Classification Results in Soil

**6** Summary of NYCDEP Sewer Discharge Criteria Parameters in Groundwater



<b><u>Figures</u></b>	<b>1</b>	Topographic Corridor Location Map
	<b>2A</b>	Soil Boring Location Plan – Western Section
	<b>2B</b>	Soil Boring Location Plan – Eastern Section
<b><u>Appendices</u></b>	<b>A</b>	Boring Location Plan
	<b>B</b>	Geologic Boring Logs
	<b>C</b>	Laboratory Analytical Results

## EXECUTIVE SUMMARY

On behalf of the New York City Department of Design and Construction (NYCDDC), Louis Berger & Assoc., P.C. (Louis Berger) conducted a Phase II Subsurface Corridor Investigation (SCI) of the SANDHW11 Corridor in preparation for reconstruction of damaged roadway, resurfacing of roadway, spot repair of the sanitary sewer, and replacement of the water main in various locations along the Corridor. This 2.53-mile long Corridor is located in the Rockaway Park, Belle Harbor, and Neponsit sections of the Borough of Queens, New York, as identified on Figure 1, and is comprised of the following street segments:

Street Segment	Length (miles)
Beach Channel Drive from approximately 100 feet east of Beach 108 <sup>th</sup> Street to approximately 50 feet west of Beach 145 <sup>th</sup> Street	1.92
Cronston Avenue from Beach 145 <sup>th</sup> Street to approximately 50 feet east of Beach 144 <sup>th</sup> Street	0.06
Beach 144 <sup>th</sup> Street from Beach Channel Drive to Cronston Avenue	0.02
Beach 145 <sup>th</sup> Street from Cronston Avenue to approximately 50 feet south on Beach 145 <sup>th</sup> Street	0.01
Beach 124 <sup>th</sup> Street from Beach Channel Drive to 50 feet south of Cronston Avenue	0.04
Cronston Avenue from approximately 50 feet west of Beach 124 <sup>th</sup> Street to Beach Channel Drive	0.06
Beach 123 <sup>rd</sup> Street from Beach Channel Drive to approximately 50 feet south on Beach 123 <sup>rd</sup> Street	0.01
Beach 122 <sup>nd</sup> Street from Beach Channel Drive to approximately 50 feet southeast on Beach 122 <sup>nd</sup> Street	0.01
Beach 121 <sup>st</sup> Street from Beach Channel Drive to approximately 50 feet south on Beach 121 <sup>st</sup> Street	0.01
Beach 120 <sup>th</sup> Street from Beach Channel Drive to approximately 50 feet south on Beach 120 <sup>th</sup> Street	0.01
Beach 119 <sup>th</sup> Street from Beach Channel Drive to approximately 50 feet south on Beach 119 <sup>th</sup> Street	0.01
Beach 118 <sup>th</sup> Street from Beach Channel Drive to approximately 50 feet south on Beach 118 <sup>th</sup> Street	0.01
Beach 117 <sup>th</sup> Street from Beach Channel Drive to approximately 50 feet south on Beach 117 <sup>th</sup> Street	0.01
Beach 116 <sup>th</sup> Street from Beach Channel Drive to approximately 50 feet south of Rockaway Beach Boulevard on Beach 116 <sup>th</sup> Street	0.16
Newport Avenue from approximately 50 feet east of Beach 116 <sup>th</sup> Street to Beach Channel Drive	0.04

Street Segment (Continued)	Length (miles)
Beach 108 <sup>th</sup> Street from Beach Channel Drive to approximately 100 feet south on Beach 108 <sup>th</sup> Street	0.02
Rockaway Beach Boulevard from Beach 116 <sup>th</sup> Street to Beach 114 <sup>th</sup> Street	0.11
Beach 115 <sup>th</sup> Street from Rockaway Beach Boulevard to approximately 50 feet south on Beach 115 <sup>th</sup> Street	0.01
Beach 114 <sup>th</sup> Street from Rockaway Beach Boulevard to approximately 50 feet south on Beach 114 <sup>th</sup> Street	0.01

The Phase II SCI was conducted to determine if the Corridor’s environmental condition may potentially impact proposed construction activities. The proposed depth of excavation for the NYCDDC infrastructure project SANDHW11 ranges between 6 and 13 feet below grade (ftbg). Based on the review of available information provided by the NYCDDC, and discussions with the NYCDDC Project Manager, Louis Berger had proposed the advancement of 23 soil borings along the Corridor to characterize soils and groundwater that may be encountered during construction.

Louis Berger prepared a Phase I Corridor Assessment Report (CAR) dated February 25, 2016, which identified 16 final “High” risk sites with respect to potential impact on the Corridor, and recommended the completion of a Phase II SCI.

The Phase II SCI was conducted between July 18 and 28, 2016 and consisted of the following components:

**Scope of Work**

- The advancement of 23 soil borings (SB01 through SB23) utilizing a Vactron® and Geoprobe® direct push drill rig. Each soil boring was advanced to a terminal depth ranging between 6 and 13 ftbg. To ensure the clearance of sensitive subsurface utility lines and features, the soil boring locations were pre-cleared to an approximate depth of 6 ftbg using evasive methods, such as a Vactron® and/or air-knife and a hand auger;
- Field screening, classification and identification of soils from surface grade to the terminal depth of each boring. Soil samples were visually classified in the field using the Burmister Classification, Unified Soil Classification System (USCS), and Munsell Rock Color charts. Field screening of soils consisted of visual and olfactory indicators of impacts, as well as screening with a photoionization detector (PID);

- The collection of one (1) grab soil sample from each boring. The grab soil sample was collected from either the 6-inch interval above the water table (when encountered), 6-inch interval above the bottom of the boring (where recovery allowed), or from the 6-inch interval showing the highest potential for contamination based on field observation. The soil samples were analyzed for Target Compound List (TCL) Volatile Organic Compounds (VOCs) using US Environmental Protection Agency (USEPA) Method 8260C;
- The collection of one (1) composite waste characterization soil sample from each boring. The composite soil sample was collected from the ground surface to the terminal depth of the boring or the depth to groundwater (if groundwater was encountered). The waste characterization sample was analyzed for Polycyclic Aromatic Hydrocarbons (PAHs) by USEPA Method 8270C, Total Petroleum Hydrocarbons Diesel and Gasoline Range Organics (TPH-DRO/GRO) by USEPA 8015B, Polychlorinated Biphenyls (PCBs) by USEPA Method 8082A/608, Toxicity Characteristic Leaching Procedure (TCLP) Resource Conservation Recovery Act (RCRA) Metals by USEPA Method 1311/6010B, and RCRA Characteristics, including ignitability, reactivity and corrosivity, by USEPA Methods 9012B/9034, 1030/1010A, and 9045C, as well as Paint Filter Test by USEPA Method 9095B for waste classification purposes;
- The collection of two (2) groundwater samples from completed soil borings that were converted into temporary well points (TWPs), TWP03 and TWP04, which were installed after the advancement of the borings. Temporary well points TWP01, TWP02 and TWP05 were not installed because groundwater was not encountered in their respective boring locations. Consequently, no groundwater samples were collected at these locations. The groundwater samples were analyzed for NYCDEP Sanitary and Combined Sewer Discharge Parameters; and,
- The preparation of this report, which includes tables summarizing the laboratory analytical results and figures depicting boring locations, significant Corridor features and, if applicable, contamination occurrence and distribution.

In order to evaluate subsurface soil quality for waste characterization purposes, laboratory analytical results of grab and composite soil samples were compared with regulatory standards identified in: (1) New York State Department of Environmental Conservation (NYSDEC) Subpart 375-6: Remedial Program Unrestricted, Restricted-Residential, and Commercial Use (Track 1 and Track 2) Soil Cleanup Objectives (SCOs); (2) NYSDEC CP-51 Soil Cleanup Guidance Residential Supplemental Soil Cleanup Objectives (SSCOs) to NYSDEC Subpart 375-6; and/or (3) Toxicity Characteristic Regulatory Levels for Hazardous Waste published in RCRA

and 6 New York Codes, Rules and Regulations (NYCRR) Part 371. The analytical results of the groundwater samples were compared to the NYCDEP Sewer Discharge Criteria.

Based on the evaluation of the field screening data and the laboratory analytical results, and a comparison to applicable regulatory standards, the following findings are presented:

### Findings

- Visual and olfactory contamination which included stained soil and petroleum odor was observed at SB18 from 6.5 to 10 ftbg. The highest PID reading detected in the soil column of SB18 was 671 ppm at a depth interval of 6 to 6.5 ftbg. A petroleum odor was also observed within the fill layer and above the water table at SB16 at a depth interval of 0.7 to 1.2 ftbg. The highest PID reading detected in the soil column of SB16 was 1.2 ppm at a depth interval of 0.7 to 1.2 ftbg;
- Obvious fill material was found in three (3) soil boring locations (SB06, SB09, and SB18) and consisted mostly of sand, concrete, brick, and asphalt to depths ranging from grade to 6 ftbg. The native soils are comprised mostly of pale yellowish brown coarse to fine sand with trace gravel and silt. Bedrock was not encountered during this Phase II SCI;
- Methylene chloride was detected in five (5) soil borings (SB08, SB09, SB14, SB15, and SB16), which is a common lab contaminant. All methylene chloride concentrations were well below regulatory standards. Isopropylbenzene was present in SB18, at a concentration below the NYSDEC Track 1 and 2 SCOs;
- Several PAHs were detected above the laboratory's reporting limits in all soil samples; however, all concentrations were below the regulatory standards except in soil sample SB06, where indeno[1,2,3-cd]pyrene and benzo[b]fluoranthene exhibited concentrations above Restricted-Residential SCOs;
- No PCBs were detected above the laboratory's reporting limits in any of the soil samples except in one (1) soil sample (SB06); however, the concentration was below the regulatory standards;
- Waste characterization laboratory results indicate that TCLP barium was detected in soil samples SB01 and SB17, while TCLP lead was detected in soil samples SB01, SB03, SB04,

SB05, SB07, SB10, SB12, SB13, SB15, SB16, SB18, and SB20. These concentrations were below RCRA Hazardous Waste Levels;

- TPH-GRO was found in waste classification soil sample SB18, while TPH-DRO was found in waste characterization soil samples SB01, SB03, SB06, SB09, SB16, SB17, and SB22; however, there are no regulatory standards for TPH;
- The analytical laboratory results of the soil samples show that none of the RCRA parameters (reactivity, ignitability, or corrosivity) were detected or exceeded; and,
- The analytical laboratory results of groundwater samples TWP03 and TWP04 showed no exceedances of NYCDEP Sewer Discharge Criteria.

Based on the results of the field investigation and laboratory analytical results, the following conclusions and recommendations are provided:

### Conclusions

- Soil sample SB18 was collected from a boring located adjacent to a filling station and auto repair shop at a depth interval of 6 – 6.5 ftbg. SB18 exhibited visual and olfactory evidence of petroleum impact and had a PID reading of 671 ppm at a depth of 6 to 6.5 ftbg. Laboratory results of soil sample SB18 showed an isopropylbenzene concentration of 0.067 ppm. No regulatory standards exist for isopropylbenzene. TPH-GRO was also found in soil sample SB18 (150 ppm). Based on the type and concentrations of analytes found at SB18, as well as the visual and qualitative observations that were made, it is possible that the soil in the surrounding area may have been impacted by an adjacent current and/or historical filling station and historical auto repair operations (as determined during the Phase I Corridor Assessment). There are no open spill cases in the vicinity of SB18;
- Soil sample SB16 was collected from within the fill layer and above the water table at a depth interval of 0.7 to 1.2 ftbg. SB16 exhibited olfactory evidence of petroleum impact and had a PID reading of 1.2 ppm at a depth of 0.7 to 1.2 ftbg. Laboratory results of soil sample SB16 showed a TPH-DRO concentration of 320 ppm. No regulatory standards exist for TPH-DRO. Based on the type and concentration of the analyte found at SB16, as well as visual and qualitative observations that were made, it is possible that the TPH concentration observed in SB16 is the result of petroleum releases within or adjacent to this boring location. There are no open spill cases in the vicinity of SB16;

- TPH-GRO was found in waste classification soil sample SB18, while TPH-DRO concentrations were found in soil samples SB01, SB03, SB06, SB09, SB16, SB17, and SB22. It is possible that the TPH concentrations observed during the Phase II SCI are the result of petroleum releases within or adjacent to the Corridor;
- Portions of the Corridor were found to be underlain by fill material to a maximum depth of 6 ftbg. The concentrations and types of PAHs detected in soil samples collected during this Phase II SCI are commonly found in fill, the product of incomplete fuel combustion, and/or a result of diffuse anthropogenic pollution (DAP). PAHs were found above regulatory criteria at one (1) boring location (SB06), where fill material was observed throughout the boring; and,
- Laboratory results indicate that the soil samples collected beneath the Corridor do not exhibit evidence of hazardous waste characteristics.

### Recommendations

- The Contract documents should identify provisions for managing, handling, transporting and disposing of contaminated non-hazardous soil. The Contractor should be required to submit a Material Handling Plan, to identify the specific protocol and procedures that will be employed to manage the waste in accordance with applicable regulations;
- Based on the TPH concentrations observed in several soil samples, as well as visual and olfactory observations which included stained soil and petroleum odors at SB16 and SB18, dust control procedures are recommended and implemented during excavation activities to minimize the creation and dispersion of fugitive airborne dust released into the ambient environment as a direct result of construction activities. A Community Air Monitoring Plan (CAMP) should be developed in accordance with NYSDEC Department of Environmental Remediation (DER)-10 Regulations. The CAMP requires real-time monitoring for particulates (i.e., dust) at the downwind perimeter of each designated work area when certain activities are in progress at the site. The CAMP is intended to provide a measure of protection for the area of the surrounding community located downwind from the potential release of airborne contaminants;
- Based on the observed depth to groundwater (between 4.9 ftbg in SB23 and 6.5 ftbg in SB18), dewatering may be necessary for the proposed excavation activities. If dewatering is necessary, the contractor will be required to obtain a NYCDEP sewer discharge permit and

perform sampling and laboratory analysis prior to discharge into sanitary and combined sewers;

- In addition, if discharge into storm sewers, which ultimately discharge into a surface water body, is required during dewatering, it may be performed under the appropriate NYSDEC State Pollutant Discharge Elimination System (SPDES) permit. Additional sampling and laboratory analysis may be required to satisfy NYSDEC requirements prior to discharge into storm sewers or surface waters; and,
- Before beginning any excavation activity, the contractor should submit a site-specific health and safety plan (HASP) that will meet the requirements set forth by the Occupational, Safety and Health Administration (OSHA), the NYSDOH and any other applicable regulations. The HASP should identify the possible locations and risks associated with the potential contaminants that may be encountered, and the administrative and engineering controls that will be utilized to mitigate concerns (i.e., dust control procedures for soils containing TPH, PAHs and metals).



## 1.0 INTRODUCTION

On behalf of the New York City Department of Design and Construction (NYCDDC), Louis Berger & Assoc., P.C. (Louis Berger) conducted a Phase II Subsurface Corridor Investigation (SCI) of the SANDHW11 Corridor in preparation for reconstruction of damaged roadway, resurfacing of roadway, spot repair of the sanitary sewer, and replacement of the water main in various locations along the Corridor. This 2.53-mile long Corridor is located in the Rockaway Park, Belle Harbor, and Neponsit sections of the Borough of Queens, New York, as identified on Figure 1, and is comprised of the following street segments:

Street Segment	Length (miles)
Beach Channel Drive from approximately 100 feet east of Beach 108 <sup>th</sup> Street to approximately 50 feet west of Beach 145 <sup>th</sup> Street	1.92
Cronston Avenue from Beach 145 <sup>th</sup> Street to approximately 50 feet east of Beach 144 <sup>th</sup> Street	0.06
Beach 144 <sup>th</sup> Street from Beach Channel Drive to Cronston Avenue	0.02
Beach 145 <sup>th</sup> Street from Cronston Avenue to approximately 50 feet south on Beach 145 <sup>th</sup> Street	0.01
Beach 124 <sup>th</sup> Street from Beach Channel Drive to 50 feet south of Cronston Avenue	0.04
Cronston Avenue from approximately 50 feet west of Beach 124 <sup>th</sup> Street to Beach Channel Drive	0.06
Beach 123 <sup>rd</sup> Street from Beach Channel Drive to approximately 50 feet south on Beach 123 <sup>rd</sup> Street	0.01
Beach 122 <sup>nd</sup> Street from Beach Channel Drive to approximately 50 feet southeast on Beach 122 <sup>nd</sup> Street	0.01
Beach 121 <sup>st</sup> Street from Beach Channel Drive to approximately 50 feet south on Beach 121 <sup>st</sup> Street	0.01
Beach 120 <sup>th</sup> Street from Beach Channel Drive to approximately 50 feet south on Beach 120 <sup>th</sup> Street	0.01
Beach 119 <sup>th</sup> Street from Beach Channel Drive to approximately 50 feet south on Beach 119 <sup>th</sup> Street	0.01
Beach 118 <sup>th</sup> Street from Beach Channel Drive to approximately 50 feet south on Beach 118 <sup>th</sup> Street	0.01
Beach 117 <sup>th</sup> Street from Beach Channel Drive to approximately 50 feet south on Beach 117 <sup>th</sup> Street	0.01
Beach 116 <sup>th</sup> Street from Beach Channel Drive to approximately 170 feet south on Beach 116 <sup>th</sup> Street	0.03
Newport Avenue from approximately 50 feet east of Beach 116 <sup>th</sup> Street to Beach Channel Drive	0.04

Street Segment (Continued)	Length (miles)
Beach 108 <sup>th</sup> Street from Beach Channel Drive to approximately 100 feet south on Beach 108 <sup>th</sup> Street	0.02
Rockaway Beach Boulevard from Beach 116 <sup>th</sup> Street to Beach 114 <sup>th</sup> Street	0.11
Beach 115 <sup>th</sup> Street from Rockaway Beach Boulevard to approximately 50 feet south on Beach 115 <sup>th</sup> Street	0.01
Beach 114 <sup>th</sup> Street from Rockaway Beach Boulevard to approximately 50 feet south on Beach 114 <sup>th</sup> Street	0.01

The Phase II SCI was conducted to determine if the Corridor’s environmental condition may potentially impact proposed construction activities. The proposed depth of excavation for the NYCDDC infrastructure project SANDHW11 ranges between 6 and 13 feet below grade (ftbg). Based on the review of available information provided by the NYCDDC, and discussions with the NYCDDC Project Manager, Louis Berger had proposed the advancement of 23 soil borings along the Corridor to characterize soils and groundwater (if observed) that may be encountered during construction.

A total of 23 grab soil samples (SB01 through SB23) were collected from corresponding boring locations (Figures 2A and 2B). In addition, 23 composite waste characterization samples were collected, one (1) from each boring. A total of two (2) groundwater samples were collected from temporary well points TWP03 and TWP04 installed during soil boring advancement. Groundwater samples from TWP01, TWP02, and TWP05 were not collected because groundwater was not encountered in their respective boring locations. Field-derived Quality Assurance and Quality Control samples were not collected for this Phase II SCI.

### 1.1 Summary of Previous Environmental Investigations

Louis Berger prepared a Phase I Corridor Assessment Report (CAR) for the Corridor in February 2016. The Phase I CAR presented the results of an investigation to document the current use, a review of Sanborn fire insurance maps to document historical use, and a review of the state and federal government databases to identify sites on or adjoining the Corridor that constitute a potential environmental concern. Based on Risk Criteria protocol established by the NYCDDC, findings presented in the Phase I CAR defined these sites as posing either “High”, “Moderate”, or “Low” risk for possible contamination to the subsurface environment along the Corridor. Louis Berger identified 173 sites categorized as initially having a “High” risk with respect to potential impact on the project, and three (3) sites as initially having a “Moderate” risk with respect to potential impact on the project, within a 1/8-mile radius of the Corridor. Based on modifying information, Louis Berger recommended that 157 of the initial 173 “High” risk sites

and all three (3) initial “Moderate” risk sites be reclassified as “Low” risk sites. Therefore, the final evaluation identified 16 final “High” risk sites and no final “Moderate” risk sites with respect to potential impact on the project corridor. Maps depicting the locations of the “High” risk sites are included in the Phase I CAR. The final “High” risk sites are listed below:

**“High” Risk Sites – Western Section:**

No.	Facility Name	Address	Map ID
1	Residential Complex (Former auto repair)	514 Beach 139 <sup>th</sup> Street / 138-11 Beach Channel Drive	1
2	VP Racing Fuels Gas Station	439 Beach 129 <sup>th</sup> Street	2
3	Blue Beach Nails and Hair (Former dry cleaner)	424 Beach 129 <sup>th</sup> Street	3
4	Residential Buildings (Former Lumber Warehouse)	143-16 to 142-20 Cronston Avenue	4
5	Mae's Laundromat	448 Beach 129 <sup>th</sup> Street	5
6	Harbor Cleaners	412 Beach 129 <sup>th</sup> Street	6

**“High” Risk Sites – Eastern Section:**

No.	Facility Name	Address	Map ID
7	NYCDEP - Rockaway WPCP	106-21 Beach Channel Drive	7
8	Rockaway Park Former MGP Site / Bell Boy Cleaners / Beach 108 <sup>th</sup> St & / K - Rockaway Park Mg / NYC DCAS - Beach Channel / 108 <sup>th</sup> St & Beach Channel / LILCO, Rockaway Gas / NYCTA-Rockaway Park / Rockaway Park Former / D'Oscar Enterprises / 416 Beach 116 <sup>th</sup> Street / Shell Station / Land / Be Rockaway Enterprise / Exxonmobil / 110 <sup>th</sup> & 112 <sup>th</sup> Beach Channel / Mobil Oil Corp SS HK / 112-15 B. Channel Drive / Belle Harbor Shopping / Beach Cleaners / New York City Transit Power Distribution / MTA above ground Subway (A and S lines)	106-21 Beach Channel Drive Beach 116 <sup>th</sup> Street / 238 Beach 116 <sup>th</sup> Street / 108-03 Beach Channel Drive / Beach Channel Drive / 109-11 Beach Channel Drive / Beach Channel Drive & Beach 108 <sup>th</sup> Street / 11216 Beach Channel / 11405 Beach Channel / 113-13 Beach Channel / Beach Channel Road / 108 <sup>th</sup> Street & Beach Channel / Beach 108 <sup>th</sup> Street / 109-11 Beach Channel / 11505 Beach Channel / 11411 Beach Channel / 11413 Beach Channel / 416 Beach 116 <sup>th</sup> Street / Beach 116 <sup>th</sup> & Channel / 110 <sup>th</sup> & 112 <sup>th</sup> Beach Channel / 112-01 Beach Channel Drive / 112-15 Beach Channel / 238 Beach 116 <sup>th</sup> Street / 222 Beach 116 <sup>th</sup> Street	8
9	Shell Gas Station / Hornet Service Station Inc. / AMOCO Gas Station	115-20 Beach Channel Drive / 116 <sup>th</sup> St/Beach Channel Drive	9

**“High” Risk Sites – Eastern Section (Continued):**

No.	Facility Name	Address	Map ID
10	W Gorman Property / Boat Fueling Station	115-14 Beach Channel Drive / 114-04-115-14 Beach Channel Drive / 114-04 Beach Channel Drive / 114-08 Beach Channel Drive / 115-06 Beach Channel Drive / 115-08 Beach Channel Drive	10
11	Cincotta Property / Gaseteria	112-20 Beach Channel Drive / Beach Channel Drive / 112-30 Beach Channel Drive / 113-10 Beach Channel Drive	11
12	Thomas McNicholas / Waterview Car Care / C & L Tires New and Used	112-10 Beach Channel Drive / 112-16 Beach Channel Drive	12
13	Slices N Ices	208 Beach Rockaway Park / 206 Beach 116 <sup>th</sup> Street	13
14	ANG Carpet & Flooring	11508 Rockaway Beach Boulevard	14
15	Metro PCS	225 Beach 116 <sup>th</sup> Street	15
16	Rocapulco Car Service and Curran's Superior Meat Inc.	239 Beach 116th Street / 241-39 Beach 116th Street / 209-230 Beach 116th Street	16

**1.2 Scope of Work**

The Phase II SCI consisted of a field investigation, laboratory analyses, and the preparation of this report, which includes tables summarizing the laboratory analytical results and figures depicting boring locations, significant Corridor features and, if applicable, contamination occurrence and distribution. Soil borings and sample collection were performed by Mr. Jonathan Ganz, Project Scientist of Louis Berger. Laboratory analyses were provided by Hampton-Clarke/Veritech (HC-V) of Fairfield, New Jersey, which is a New York State Department of Health (NYSDOH) Environmental Laboratory Approval Program (ELAP)-certified analytical laboratory (No. 11408). The field investigation was conducted between July 18 and 28, 2016 and consisted of the following components:

- The advancement of 23 soil borings (SB01 through SB23) utilizing a Vactron® and Geoprobe® direct push drill rig. Each soil boring was advanced to a terminal depth ranging between 6 and 13 ftbg. To ensure the clearance of sensitive subsurface utility lines and features, the soil boring locations were pre-cleared to an approximate depth of 6 ftbg using evasive methods such as a Vactron® and/or air-knife and a hand auger;

- Field screening, classification and identification of soils from surface grade to the terminal depth of each boring. Soil samples were visually classified in the field using the Burmister Classification, Unified Soil Classification System (USCS), and Munsell Rock Color charts. Field screening of soils consisted of visual and olfactory indicators of impacts, as well as screening with a photoionization detector (PID);
- The collection of one (1) grab soil sample from each boring. The grab soil sample was collected from either the 6-inch interval above the water table (when encountered), 6-inch interval above the bottom of the boring (where recovery allowed), or from the 6-inch interval showing the highest potential for contamination based on field observation. The soil samples were analyzed for Target Compound List (TCL) Volatile Organic Compounds (VOCs) using US Environmental Protection Agency (USEPA) Method 8260C;
- The collection of one (1) composite waste characterization soil sample from each boring. The composite soil sample was collected from the ground surface to the terminal depth of the boring or the depth to groundwater (if groundwater was encountered). The waste characterization sample was analyzed for Polycyclic Aromatic Hydrocarbons (PAHs) by USEPA Method 8270C, Total Petroleum Hydrocarbons Diesel and Gasoline Range Organics (TPH-DRO/GRO) by USEPA 8015B, Polychlorinated Biphenyls (PCBs) by USEPA Method 8082A/608, TCL RCRA Metals by USEPA Method 1311/6010B, and RCRA Characteristics, including ignitability reactivity and corrosivity, by USEPA Methods 9012B/9034, 1030/1010A, and 9045C, as well as Paint Filter Test by USEPA Method 9095B for waste classification purposes;
- The collection of two (2) groundwater samples from completed soil borings that were converted into TWPs (TWP03 and TWP04), which were installed after the advancement of the borings. Temporary well points TWP01, TWP02 and TWP05 were not installed because groundwater was not encountered in their respective boring locations. Consequently, no groundwater samples were collected at these locations. The groundwater samples were analyzed for NYCDEP Sanitary and Combined Sewer Discharge Parameters; and,
- The preparation of this report, which includes tables summarizing the laboratory analytical results and figures depicting boring locations, significant Corridor features and, if applicable, contamination occurrence and distribution.

## 2.0 CORRIDOR INFORMATION

### 2.1 Corridor Location, Description and Use

The 2.53-mile long Corridor is located in the Rockaway Park, Belle Harbor, and Neponsit sections of the Borough of Queens, New York. Currently, the Corridor is developed with paved roadways and existing infrastructure systems, and exhibits evidence of utilities, such as manholes, pavement scars, utility mark-outs, storm sewer, natural gas, drinking water, electrical/communication utilities, and valve covers throughout the roadway and sidewalk areas. This indicates the presence of buried utilities, including gas, sewer, water, electric and communication. Additionally, overhead electrical lines are present along the Corridor.

Adjoining property usage along the Western Section of the Corridor is residential, along with two (2) small parks. Many of these residences were flooded during Superstorm Sandy in 2012. As a consequence of the flooding, some fuel oil tanks in the basements of these buildings were damaged, resulting in releases. Review of government regulatory agency databases for properties along the Corridor and adjoining sites indicates that the reported spill cases within a 1/8-mile radius have been closed.

The eastern section of the Corridor consists of industrial, historic industrial, and commercial properties, including auto repair shops, gas stations, dry cleaners, an auto wash, ground-level MTA Subway Lines (A and S line), the former Rockaway Park Manufactured Gas Plant (MGP) site (High Risk Site #8) and the NYCDEP Wastewater Treatment Plant (High Risk Site #7). The Wastewater Treatment Plant is located immediately adjacent to the easternmost extent of the Corridor at Beach 108<sup>th</sup> Street. The MTA railroad tracks run at ground level, parallel to and along the Corridor from Beach 116<sup>th</sup> Street to the east (included in the block-wide High Risk Site #8). Maps of the western and eastern sections of the Corridor area are presented as Figure 2A and Figure 2B, respectively.

### 2.2 Description of Surrounding Properties

The Corridor is primarily surrounded by residential and commercial properties and Jamaica Bay to the north. On the western section of the Corridor, VP Racing Fuels Gas Station ("High" Risk Site #2) and Blue Beach Nails and Hair (former dry cleaner) ("High" Risk Site #3) are located approximately one (1) block south of the Corridor. Mae's Laundromat ("High" Risk Site #5) and Harbor Cleaners ("High" Risk Site #6) were identified during the site reconnaissance and are located approximately one (1) block south of the Corridor. On the Eastern Section of the Corridor, former dry cleaners, such as Slices N Ices ("High" Risk Site #13), ANG Carpet &

Flooring (“High” Risk Site #14), Metro PCS (“High” Risk Site #15) and a former auto station, Rocapulco Car Service and Curran's Superior Meat Inc. (“High” Risk Site #16), are located approximately 0.08 miles south of the Corridor.

### 2.3 Corridor and Regional Topographic Setting

Louis Berger reviewed the United States Geologic Survey (USGS) 7.5-minute Topographic Quadrangle Map for Far Rockaway, NY (1995) to determine topography at the Corridor. The Corridor is situated adjacent to the north shore of the Rockaway Peninsula. The Corridor exhibits an elevation change of approximately 5 feet along the length of the Corridor. The approximate elevation of the Corridor ranges from 6 feet above mean sea level (msl) in the eastern section to 11 feet above msl in the eastern section. Under natural conditions, surface runoff would be expected to follow the overall topography of the area towards the west and towards the north to the water in Rockaway Inlet. However, storm runoff within the Corridor is managed by storm drains.

### 2.4 Corridor and Regional Geology

Based on the *NYC Reconnaissance Soil Survey* (2005), surficial soil is expected to consist of the Pavement & Buildings, Wet Substratum-Bigapple-Verrazano complex. Generally, this complex is found in nearly level to gently sloping urbanized areas located along coastal waterways in Staten Island, Brooklyn, and Queens, where sandy dredged materials and loamy fill have been placed over swamp, tidal marsh, or water. Impervious surfaces such as asphalt, concrete, and buildings account for approximately 50 to 80 percent of this complex.

Based on *The Geology of Staten Island and Western Long Island, Kings and Queens Counties, New York* (Roberts-Dolgin, 1951) and the *Ground-Water Resources of Kings and Queens Counties, Long Island, New York* (Buxton, 1999), surficial soils are underlain by Holocene beach deposits consisting of chiefly quartz sand, locally containing some plant debris, shell fragments, and scattered shells to a depth of approximately 80 ftbg. Underlying the beach deposits are Upper Pleistocene deposits consisting of till and outwash sand and gravel to a depth of approximately 150 ftbg. These deposits are, in turn, underlain by approximately 50 feet of the Gardiners Clay, which consists mostly of clay with some thin beds of sand and/or gravel. The Gardiners Clay is underlain by approximately 150 feet of the Jameco Gravel, which may extend to depths of approximately 350 ftbg locally. Jameco deposits mainly consist of coarse sand and gravel. Underlying the Jameco Gravel is the Magothy Formation and Matawan Group which extends to approximately 490 ftbg and consists mostly of deltaic quartzose, very fine to coarse sand, and silty sand with interbedded clay and silt. The Magothy Formation and Matawan Group are underlain by the Upper Cretaceous-aged Raritan Formation. The Raritan Formation consists

of two members, the Clay member and the Lloyd Sand Member. The Clay member of the Raritan Formation consists of clay beds with inclusions of silty clay and clayey silts and is anticipated to be encountered at a depth of approximately 490 ftbg and extend to approximately 750 ftbg. The Lloyd Sand Member of the Raritan Formation, which consists of fine to coarse quartz sand, extends from approximately 750 ftbg to 950 ftbg. The Raritan Formation is underlain by gneiss and schist bedrock which is anticipated to occur at a depth of approximately 950 ftbg.

During this Phase II SCI, obvious fill material was found in three (3) soil boring locations (SB06, SB09, and SB18) and consisted mostly of sand, concrete, brick, and asphalt to depths ranging from 0 to 6 ftbg. The native soils are comprised mostly of pale yellowish brown coarse to fine sand with trace gravel and silt. Bedrock was not encountered during this Phase II SCI.

## 2.5 Corridor and Regional Hydrogeology

As part of this Phase II SCI, groundwater was encountered between 4.9 (SB23) and 6.5 (SB18) ftbg, and mostly at 6 ftbg in the majority of soil borings along the Corridor. Groundwater was not encountered in seven (7) soil borings, all of which terminated at 6 ftbg. Groundwater is anticipated to flow northwest towards the Rockaway Inlet; however, groundwater flow direction may vary due to seasonal fluctuations in precipitation, tidal fluctuations, local variations in geology, underground anthropogenic structures, and/or local dewatering operations.

Based on information supplied by the U.S. Fish and Wildlife Service (USFWS) National Wetlands Inventory, there are no wetlands within the Corridor. According to the environmental database reports provided by Environmental Data Resources, Inc. (EDR) of Shelton, CT (Appendix C), there are no State or Federal wetlands within proximity to the Corridor. The nearest wetlands are Jamaica Bay, which is classified as estuarine and marine deepwater (classification code E1UBL), and Rockaway Beach, which is classified as estuarine and marine wetland (classification code M2US2P), and are located approximately 35 feet north of the center of the Corridor and 1,530 feet south of the eastern side of the Corridor, respectively.

According to the Federal Emergency Management Agency (FEMA) Flood Insurance Rate Map (FIRM) Panels 3604970378F and 3604970379F (FEMA, 2007), the Corridor falls within the 100-year flood zone, describes as Flood Zone AE, which are areas with 1% chance of flooding. The base flood elevation in Flood Zone AE is determined to be 8 feet water-surface elevation in this area.



### 3.0 CORRIDOR EVALUATION

Proposed construction activities within the Corridor include soil excavation, which requires that soils be characterized to identify material handling requirements (i.e., use of protective equipment) and waste disposal requirements. Louis Berger advanced 23 soil borings and installed two (2) TWP's during the field investigation conducted between July 18 and 28, 2016. The field investigation was performed at designated areas in the vicinity of the planned excavation area. All drilling and hand-clearing activities were performed by Zebra Technical Services, LLC. under the oversight of Louis Berger. A summary of the field observations and details of the soil borings are provided in Table 1.

#### 3.1 Soil Quality Investigation

Soil borings SB07 through SB10, SB12, SB13, SB15, and SB18 were advanced utilizing a Geoprobe® direct push drill rig to a terminal depth of 10 ftbg, and soil borings SB11, SB14, SB16, and SB17 were also advanced utilizing a Geoprobe® direct push drill rig to 13 ftbg. Soil borings SB01 through SB06, and SB19 through SB23 were advanced using a Vactron® to a terminal depth of 6 ftbg. To ensure the clearance of sensitive subsurface utility lines and features, all soil boring locations were pre-cleared to a depth of 6 ftbg using evasive methods such as a Vactron® and/or air-knife and a hand auger. Soil boring locations are depicted on Figures 2A and 2B. The designations and sampling intervals for the samples that were submitted to the laboratory are included in Table 1. Maps depicting each boring location are included in Appendix A. Boring logs are provided in Appendix B. The location of each boring is described below:

- **SB01** – Located in the grass area on the sidewalk along the south side of Beach Channel Drive, 41 feet northeast of southeastern corner of the intersection of Beach Channel Drive and Beach 144<sup>th</sup> Street, and 68 feet southeast of the curb along the north side of Beach Channel Drive.
- **SB02** – Located in the sidewalk area along the south side of Beach Channel Drive, 43 feet southwest of the southwestern corner of the intersection of Beach Channel Drive and Beach 140<sup>th</sup> Street, and 57 feet southeast of the curb along the north side of Beach Channel Drive.
- **SB03** – Located in the sidewalk area along the south side of Beach Channel Drive, 40 feet southwest of the southwestern corner of the intersection of Beach Channel Drive and Beach 137<sup>th</sup> Street, and 57 feet southeast of the curb along the north side of Beach Channel Drive.

- **SB04** – Located in the sidewalk area along the south side of Beach Channel Drive, 19 feet northeast of the southeastern corner of the intersection of Beach Channel Drive and Beach 134<sup>th</sup> Street, and 57 feet southeast of the curb along the north side of Beach Channel Drive.
- **SB05** – Located in the sidewalk area along the south side of Beach Channel Drive, 30 feet southwest of the southwestern corner of the intersection of Beach Channel Drive and Beach 130<sup>th</sup> Street, and 57 feet southeast of the curb along the north side of Beach Channel Drive.
- **SB06** – Located in the grass area along the north side of Beach Channel Drive, 1 foot southwest and 60 feet northwest of the southwestern corner of the intersection of Beach Channel Drive and Beach 126<sup>th</sup> Street.
- **SB07** – Located in the grass area on the sidewalk along the south side of Beach Channel Drive, 104 feet northwest of the southwestern corner of the intersection of Beach Channel Drive and Beach 124<sup>th</sup> Street, and 58 feet southwest of the curb along the north side of Beach Channel Drive.
- **SB08** – Located in the sidewalk area along the east side of Beach 124<sup>th</sup> Street, 67 feet northwest of the northeast corner of the intersection of Beach 124<sup>th</sup> Street and Cronston Avenue, and 34 feet northeast of the curb along the west side of Beach 124<sup>th</sup> Street.
- **SB09** – Located in the sidewalk area along the south side of Beach Channel Drive, 122 feet and 6 inches southeast of the southeastern corner of the intersection of Beach Channel Drive and Beach 124<sup>th</sup> Street, and 57 feet southwest of the curb along the north side of Beach Channel Drive.
- **SB10** – Located in the sidewalk area along the south side of Cronston Avenue, 60 feet northeast of the southeast corner of the intersection of Cronston Avenue and Beach 124<sup>th</sup> Street, and 38 feet southeast of the curb along the north side of Cronston Avenue.
- **SB11/TWP03** – Located in the sidewalk area along the south side of Beach Channel Drive, 116 feet east of the southeastern corner of the intersection of Beach Channel Drive and Beach 123<sup>rd</sup> Street, and 53 feet south of the curb along the north side of Beach Channel Drive. TWP03 was installed in soil boring SB11 and a groundwater sample was collected from this location.

- **SB12** – Located in the sidewalk area along the south side of Beach Channel Drive, 40 feet east of the southeastern corner of the intersection of Beach Channel Drive and Beach 122<sup>nd</sup> Street, and 54 feet south of the curb along the north side of Beach Channel Drive.
- **SB13** – Located in the sidewalk area along the south side of Beach Channel Drive, 70 feet and 6 inches west of the southwestern corner of the intersection of Beach Channel Drive and Beach 120<sup>th</sup> Street, and 60 feet south of the curb along the north side of Beach Channel Drive.
- **SB14** – Located in the sidewalk area along the south side of Beach Channel Drive, 98 feet east of the southeastern corner of the intersection of Beach Channel Drive and Beach 120<sup>th</sup> Street, and 52 feet south of the curb along the north side of Beach Channel Drive.
- **SB15** – Located in the sidewalk area along the south side of Beach Channel Drive, 93 feet east of the southeastern corner of the intersection of Beach Channel Drive and Beach 119<sup>th</sup> Street, and 53 feet south of the curb along the north side of Beach Channel Drive.
- **SB16** – Located in the grass area on the sidewalk along the south side of Beach Channel Drive, 140 feet west of the southwestern corner of the intersection of Beach Channel Drive and Beach 117<sup>th</sup> Street, and 59 feet south of the curb along the north side of Beach Channel Drive.
- **SB17/TWP04** – Located in the sidewalk area along the west side of Beach 116<sup>th</sup> Street, 12 feet southwest of the southwestern corner of the intersection of Beach Channel Drive and Beach 116<sup>th</sup> Street, and 76 feet and 6 inches west of the curb along the east side of Beach 116<sup>th</sup> Street. TWP04 was installed in soil boring SB17 and a groundwater sample was collected from this location.
- **SB18** – Located in the sidewalk area along the south side of Newport Avenue, 91 feet northeast of the southeast corner of the intersection of Newport Avenue and Beach 116<sup>th</sup> Street, and 106 feet southeast of the curb along the north side of Beach Channel Drive.
- **SB19** – Located in the sidewalk area along the south side of Beach Channel Drive, 320 feet northeast of the southeast corner of the intersection of Newport Avenue and Beach 116<sup>th</sup> Street, and 80 feet southeast of the curb along the north side of Beach Channel Drive.

- **SB20** – Located in the grass area on the sidewalk along the south side of Beach Channel Drive, 101 feet northeast of the southeastern corner of the intersection of Beach Channel Drive and Rockaway Freeway, and 75 feet southeast of the curb along the north side of Beach Channel Drive.
- **SB21** – Located in the sidewalk area along the south side of Beach Channel Drive, 38 feet southwest of the southwestern corner of the intersection of Beach Channel Drive and Beach 108<sup>th</sup> Street, and 72 feet southeast of the curb along the north side of Beach Channel Drive.
- **SB22** – Located in a planter box in the island area in the middle of Beach 116<sup>th</sup> Street, 224 feet northwest of the southern end of the island, and 40 feet southwest of the curb along the east side of Beach 116<sup>th</sup> Street.
- **SB23** – Located in the sidewalk area along the south side of Rockaway Beach Boulevard, 22 feet southwest of the southwestern corner of the intersection of Rockaway Beach Boulevard and Beach 115<sup>th</sup> Street, and 36 feet and 6 inches southeast of the curb along the north side of Rockaway Beach Boulevard.

Soil from each boring was classified and examined for visual evidence (i.e., staining, discoloration) and any olfactory indications (i.e., odors) of contamination. In addition, a PID was used to screen the soil for VOC vapors.

In order to identify representative conditions relative to the presence of PAHs, TCLP metals, PCBs, total petroleum hydrocarbons, RCRA characteristics, and conditions relative to waste disposal in each boring, composite soil samples were collected at each boring location. Based on the NYCDDC protocol regarding soil sample collection for waste classification analysis, composite soil samples for SB01 through SB23 were collected from the ground surface to the terminal depth of the boring or the depth to groundwater (if groundwater was encountered). Composite soil samples were collected by mixing the soil from the column in a decontaminated stainless steel bowl.

In order to identify representative conditions relative to the presence of VOCs, grab samples were collected from either the 6-inch interval above the water table (when encountered), 6-inch interval above the bottom of the boring (where recovery allowed), or from the 6-inch interval showing the highest potential for contamination based on field observation.

Soil classification information, including stratigraphy, is documented on the boring logs provided in Appendix B. All boring equipment was cleaned by rinsing with deionized water, scrubbed with Alconox®, and then rinsed with deionized water a second time between each sample location. Following the completion of each boring, the boreholes were backfilled with removed material and then sealed with ready mixed concrete or cold patch asphalt, where appropriate.

### 3.2 Groundwater Quality Investigation

As the depth of excavation for the proposed project ranges from approximately 6 to 13 ftbg within the Corridor, groundwater may be encountered during construction. During this Phase II SCI, groundwater was encountered at depths ranging between 4.9 (SB23) and 6.5 (SB18) ftbg.

Two (2) groundwater samples were collected from TWP03 (SB11) and TWP04 (SB17). Groundwater samples TWP01 (SB02), TWP02 (SB05) and TWP05 (SB20), which were proposed to be collected but were not collected because no groundwater was encountered in their respective soil boring locations.

Groundwater samples were collected from the 1-inch diameter TWP for screening and laboratory analysis via dedicated Teflon® tubing and a peristaltic pump. The sampling tubing was new, clean, and unused, then properly disposed of after use. Upon extraction, the sample was examined for visual evidence (i.e., discoloration, sheen) and any olfactory indications (i.e., odors) of contamination and observations were noted in the field book.

### 3.3 Laboratory Analyses

Soil samples were submitted to HC-V of Fairfield, New Jersey which is a NYSDOH ELAP-certified analytical laboratory (No. 11408). Field-derived Quality Assurance/Quality Control samples were not collected for this project. Laboratory analytical reports are included in Appendix C.

The grab soil samples SB01 through SB23 were analyzed for TCL VOCs using USEPA Method 8260C. The composite soil samples SB01 through SB23 were analyzed for PAHs by USEPA Method 8270C, TPH-DRO/GRO by USEPA 8015B, PCBs by USEPA Method 8082A/608, TCLP Metals (RCRA 8) by USEPA Method 1311/6010B, and RCRA Characteristics, including ignitability, reactivity and corrosivity, by USEPA Methods 9012B/9034, 1030/1010A, and 9045C, as well as Paint Filter Test by USEPA Method 9095B for waste characterization purposes.

The groundwater samples were analyzed for the NYCDEP Sewer Discharge Criteria for effluent to sanitary or combined sewers in New York City.

### **3.4 Data Evaluation**

In order to evaluate subsurface soil quality for waste characterization purposes, laboratory analytical results of grab and composite soil samples were compared with regulatory standards identified in: (1) New York State Department of Environmental Conservation (NYSDEC) Subpart 375-6: Remedial Program Unrestricted, Restricted-Residential, and Commercial Use (Track 1 and Track 2) Soil Cleanup Objectives (SCOs); (2) NYSDEC CP-51 Soil Cleanup Guidance Residential Supplemental Soil Cleanup Objectives (SSCOs) to NYSDEC Subpart 375-6; and/or (3) Toxicity Characteristic Regulatory Levels for Hazardous Waste published in RCRA and 6 NYCRR Part 371. The analytical results of the groundwater samples were compared to the NYCDEP Sewer Discharge Criteria.

## 4.0 FINDINGS

This section discusses the analytical data and findings for activities discussed in Section 3.0. Boring logs can be found in Appendix B. A complete analytical data report is included in Appendix C.

### 4.1 Field Screening

Field screening consisted of identifying visual and olfactory indicators of potential impact, as well as screening soil for VOC vapors with a PID. Visual and olfactory contamination which included stained soil and petroleum odor was observed at SB18 from 6.5 to 10 feet below grade (ftbg). The highest PID reading detected in the soil column of SB18 was 671 ppm at a depth interval of 6 to 6.5 ftbg. A petroleum odor was also observed within the fill layer and above the water table at SB16 at a depth interval of 0.7 to 1.2 ftbg. The highest PID reading detected in the soil column of SB16 was 1.2 ppm at a depth interval of 0.7 to 1.2 ftbg. A summary of the environmental boring data is presented in Table 1.

### 4.2 Laboratory Analytical Results

#### 4.2.1 Target Compound List (TCL) Volatile Organic Compounds (VOCs) in Soil

Methylene chloride was detected in five (5) soil borings (SB08, SB09, SB14, SB15, and SB16), which is a common lab contaminant. All methylene chloride concentrations were well below regulatory standards. Isopropylbenzene was present in SB18, at a concentration below the NYSDEC Track 1 and 2 SCOs. A summary of the VOC results is provided as Table 2.

#### 4.2.2 Polycyclic Aromatic Hydrocarbons (PAHs) in Soil

Several PAHs were detected above the laboratory's reporting limits in all soil samples collected as part of this Phase II SCI; however, only SB06 exhibited PAH concentrations above the regulatory standards. A summary of the PAH results is provided as Table 3.

The following exceedances of regulatory criteria were found during the Phase II SCI:

#### Soil Sample SB06

- Benzo(b)fluoranthene (1.2 ppm) and indeno[1,2,3-cd]pyrene (0.61 ppm) were detected above the Unrestricted Use (Track 1) and Restricted-Residential Use (Track 2) SCOs.

#### 4.2.3 *Polychlorinated Biphenyls (PCBs) in Soil*

Aroclor-1260 (PCB compound) was detected above the laboratory's reporting limits in one (1) soil sample (SB06); however, the concentration was below the regulatory standards. A summary of the PCB results is provided as Table 4.

#### 4.2.4 *Waste Classification of Soil*

##### TCLP Metals

Waste characterization laboratory results indicate that TCLP barium was detected in soil samples SB01 and SB17 while TCLP lead was detected in soil samples SB01, SB03, SB04, SB05, SB07, SB10, SB12, SB13, SB15, SB16, SB18, and SB20. These concentrations were observed to be below RCRA Hazardous Waste Levels. A summary of the waste characterization parameters is provided as Table 5.

##### Total Petroleum Hydrocarbons (TPH)

TPH-GRO concentrations were detected in soil sample SB18 (150 ppm), which was collected at a boring location adjacent to a current filling station and auto repair shop and from a depth interval which displayed visual and olfactory evidence of petroleum impact.

TPH-DRO concentrations were detected in soil samples SB01 (99 ppm), SB03 (140 ppm), SB06 (320 ppm), SB09 (560 ppm), SB16 (250 ppm), SB17 (1,100 ppm), and SB22 (100 ppm).

No regulatory standards exist for TPH. A summary of the waste characterization parameters is provided as Table 5.

##### RCRA Parameters (Reactivity, Corrosivity, Ignitability)

The analytical laboratory results of the soil samples show that none of the RCRA parameters (reactivity, ignitability, or corrosivity) were detected or exceeded. The pH of the samples was found to be within the RCRA limits of 5 and 12.5. The flash point was greater than 140 degrees Fahrenheit in the soil beneath the Corridor; therefore, the RCRA characteristics for ignitability were negative. Reactive cyanide and reactive sulfide were not detected in any of the soil samples.

Therefore, results of these analyses indicate that the soil samples collected from the Corridor do not exhibit evidence of hazardous waste characteristics. A summary of the waste characterization parameters is provided as Table 5.



#### *4.2.5 Analysis of NYCDEP Parameters in Groundwater*

The analytical laboratory results of groundwater samples TWP03 and TWP04 showed that no exceedances of NYCDEP Sewer Discharge Criteria were detected in both samples. Refer to Table 6 for a summary of groundwater quality results compared to NYCDEP Sewer Discharge Criteria.

## 5.0 CONCLUSIONS AND RECOMMENDATIONS

Based on the evaluation of the field screening data and the laboratory analytical results, and a comparison to applicable regulatory standards, the following conclusions and recommendations are presented:

### Findings

- Visual and olfactory contamination which included stained soil and petroleum odor was observed at SB18 from 6.5 to 10 feet below grade surface (ftbg). The highest PID reading detected in the soil column of SB18 was 671 ppm at a depth interval of 6.0 to 6.5 ftbg. A petroleum odor was also observed within the fill layer and above the water table at SB16 at a depth interval of 0.7 to 1.2 ftbg. The highest PID reading detected in the soil column of SB16 was 1.2 ppm at a depth interval of 0.7 to 1.2 ftbgs;
- Obvious fill material was found in three (3) soil boring locations (SB06, SB09, and SB18) and consisted mostly of sand, concrete, brick, and asphalt to depths ranging from 0 to 6.0 ftbg. The native soils are comprised mostly of pale yellowish brown coarse to fine sand with trace gravel and silt. Bedrock was not encountered during this Phase II SCI;
- Methylene chloride was detected in five (5) soil borings (SB08, SB09, SB14, SB15, and SB16), which is a common lab contaminant. All methylene chloride concentrations were well below regulatory standards. Isopropylbenzene was present in SB18, at a concentration below the NYSDEC Track 1 and 2 SCOs;
- Several PAHs were detected above the laboratory's reporting limits in all soil samples; however, all concentrations were below the regulatory standards except in soil sample SB06, where indeno[1,2,3-cd]pyrene and benzo[b]fluoranthene exhibited concentrations above NYSDEC Restricted-Residential Track 2 SCOs;
- Aroclor-1260 (PCB compound) was detected above the laboratory's reporting limits in one (1) soil sample (SB06); however, the concentration was below the regulatory standards;
- Waste characterization laboratory results indicate that TCLP barium was detected in soil samples SB01 and SB17 while TCLP lead was detected in soil samples SB01, SB03, SB04, SB05, SB07, SB10, SB12, SB13, SB15, SB16, SB18, and SB20. These concentrations were observed to be below RCRA Hazardous Waste Levels;

- TPH-GRO was found in waste classification soil sample SB18, while TPH-DRO was found in waste characterization soil samples SB01, SB03, SB06, SB09, SB16, SB17, and SB22; however, there are no regulatory standards for TPH;
- The analytical laboratory results of the soil samples show that none of the RCRA parameters (reactivity, ignitability, or corrosivity) were detected or exceeded. Therefore, results of these analyses indicate that the soil samples collected from the Corridor do not exhibit evidence of hazardous waste characteristics;
- The analytical laboratory results of groundwater samples TWP03 and TWP04 showed no exceedances of the NYCDEP Sewer Discharge Criteria.

Based on the results of the field investigation and laboratory analytical results, the following conclusions and recommendations are provided:

### Conclusions

- Soil sample SB18 was collected from a boring located adjacent to a filling station and auto repair shop at a depth interval of 6.0 – 6.5 ftbg. SB18 exhibited visual and olfactory evidence of petroleum impact and had a PID reading of 671 ppm at a depth of 6.5 to 10.0 ftbg. Laboratory results of soil sample SB18 showed isopropylbenzene concentrations of 0.067 ppm. No regulatory standards exist for isopropylbenzene. TPH-GRO was also found in soil sample SB18 (150 ppm). Based on the type and concentrations of analytes found at SB18, as well as the visual and olfactory observations that were made, it is possible that the soil in the surrounding area may have been impacted by an adjacent current and/or historic filling station, and historical auto repair operations (as determined during the Phase I Corridor Assessment). There are no open spill cases in the vicinity of SB18;
- Soil sample SB16 was collected from within the fill layer and above the water table at a depth interval of 0.7 to 1.2 ftbg. SB16 exhibited olfactory evidence of petroleum impact and had a PID reading of 1.2 ppm at a depth of 0.7 to 1.2 ftbg. Laboratory results of soil sample SB16 showed a TPH-DRO concentration of 250 ppm. No regulatory standards exist for TPH-DRO. Based on the type and concentration of the analyte found at SB16, as well as visual and qualitative observations that were made, it is possible that the TPH concentration observed in SB16 is the result of petroleum releases within or adjacent to this boring location. There are no open spill cases in the vicinity of SB16;

- Methylene chloride was detected in five (5) soil borings (SB08, SB09, SB14, SB15, and SB16), at concentrations well below regulatory standards. Methylene chloride is a common laboratory contaminant and is not believed to be indicative of the conditions of the Corridor subsurface;
- TPH-GRO was found in waste classification soil sample SB18, while TPH-DRO concentrations were found in soil samples SB01, SB03, SB06, SB09, SB16, SB17, and SB22. It is possible that the TPH concentrations observed during the Phase II SCI are the result of petroleum releases within or adjacent to the Corridor;
- Portions of the Corridor were found to be underlain by fill material to a maximum depth of 6 ftbg. The concentrations and types of PAHs detected in soil samples collected during this Phase II SCI are commonly found in fill, the product of incomplete fuel combustion, and/or a result of diffuse anthropogenic pollution (DAP). PAHs were found above regulatory criteria at one (1) boring location (SB06), where fill material was observed throughout the boring; and
- Laboratory results indicate that the soil samples collected beneath the Corridor do not exhibit evidence of hazardous waste characteristics.

### **Recommendations**

- The Contract documents should identify provisions for managing, handling, transporting and disposing of contaminated non-hazardous soil. The Contractor should be required to submit a Material Handling Plan, to identify the specific protocol and procedures that will be employed to manage the waste in accordance with applicable regulations;
- Based on the TPH concentrations observed in several soil samples, as well as visual and olfactory observations which included stained soil and petroleum odors at SB16 and SB18, dust control procedures are recommended and implemented during excavation activities to minimize the creation and dispersion of fugitive airborne dust released into the ambient environment as a direct result of construction activities. A Community Air Monitoring Plan (CAMP) should be developed in accordance with NYSDEC Department of Environmental Remediation (DER)-10 Regulations. The CAMP requires real-time monitoring for particulates (i.e., dust) at the downwind perimeter of each designated work area when certain activities are in progress at the site. The CAMP is intended to provide a measure of

---

protection for the area of the surrounding community located downwind from the potential release of airborne contaminants;

- Based on the observed depth to groundwater (between 4.9 ftbg in SB23 and 6.5 ftbg in SB18), dewatering may be necessary for the proposed excavation activities. If dewatering is necessary, the contractor will be required to obtain a NYCDEP sewer discharge permit and perform sampling and laboratory analysis prior to discharge into sanitary and combined sewers;
- In addition, if discharge into storm sewers, which ultimately discharge into a surface water body, is required during dewatering, it may be performed under the appropriate NYSDEC State Pollutant Discharge Elimination System (SPDES) permit. Additional sampling and laboratory analysis may be required to satisfy NYSDEC requirements prior to discharge into storm sewers or surface waters; and
- Before beginning any excavation activity, the contractor should submit a site-specific health and safety plan (HASP) that will meet the requirements set forth by the Occupational, Safety and Health Administration (OSHA), the NYSDOH and any other applicable regulations. The HASP should identify the possible locations and risks associated with the potential contaminants that may be encountered, and the administrative and engineering controls that will be utilized to mitigate concerns (i.e., dust control procedures for soils containing PAHs and metals).

---

## 6.0 STATEMENT OF LIMITATIONS

The data presented and the opinions expressed in this report are qualified as stated in the attachment to this section of the report.

Report Prepared By:



---

Fameeda Ali, CHMM, ENV SP  
Project Manager

Report Reviewed By:



---

Michael J. McCloskey, PG  
QA/QC Manager

---

## STATEMENT OF LIMITATIONS

The data presented and the opinions expressed in this report are qualified as follows:

The sole purpose of the investigation and of this report is to assess the physical characteristics of the Corridor with respect to the presence or absence in the environment of oil or hazardous materials and substances as defined in the applicable state and federal environmental laws and regulations and to gather information regarding current and past environmental conditions at the Corridor.

Louis Berger derived the data in this report primarily from visual inspections, examination of records in the public domain, interviews with individuals with information about the Corridor, and a limited number of subsurface explorations made on the dates indicated. The passage of time, manifestation of latent conditions or occurrence of future events may require further exploration at the Corridor, analysis of the data, and reevaluation of the findings, observations, and conclusions expressed in the report.

In preparing this report, Louis Berger has relied upon and presumed accurate certain information (or the absence thereof) about the Corridor and adjacent properties provided by governmental officials and agencies, the Client, and others identified herein. Except as otherwise stated in the report, Louis Berger has not attempted to verify the accuracy or completeness of any such information.

The data reported and the findings, observations, and conclusions expressed in the report are limited by the Scope of Services, including the extent of subsurface exploration and other tests. The Scope of Services was defined by the requests of the Client, the time and budgetary constraints imposed by the Client, and the availability of access to the Corridor.

Because of the limitations stated above, the findings, observations, and conclusions expressed by Louis Berger in this report are not, and should not be considered, an opinion concerning the compliance of any past or present owner or operator of the Corridor with any federal, state or local law or regulation. No warranty or guarantee, whether express or implied, is made with respect to the data reported or findings, observations, and conclusions expressed in this report. Further, such data, findings, observations, and conclusions are based solely upon Corridor conditions in existence at the time of investigation.

This report has been prepared on behalf of and for the exclusive use of the Client, and is subject to and issued in connection with the Agreement and the provisions thereof.

**TABLES**

- TABLE 1 – SUMMARY OF ENVIRONMENTAL BORING DATA**  
**TABLE 2 – SUMMARY OF TCL VOCs DETECTED IN SOIL**  
**TABLE 3 – SUMMARY OF PAHs DETECTED IN SOIL**  
**TABLE 4 – SUMMARY OF PCBs DETECTED IN SOIL**  
**TABLE 5 – SUMMARY OF WASTE CLASSIFICATION RESULTS DETECTED IN SOIL**  
**TABLE 6 – SUMMARY OF NYCDEP DISCHARGE PARAMETERS IN GROUNDWATER**



Table 1. Summary of Environmental Boring Data  
Phase II Subsurface Corridor Investigation for Beach Channel Drive  
Queens, New York

Boring No.	Sample ID	High PID (ppm)	Sample Interval (ft bg)	Total VOCs (mg/kg)	Total PAHs (mg/kg)	TCLP Metals Exceed (Yes/No) <sup>1</sup>	Depth to Water (ft bg)	Total Depth (ft bg)	Other Comments
SB01	SB01	<1	5.5 - 6.0	ND	--	No	6.0	6.0	No visual/olfactory signs of contamination observed.
			0 - 6.0	--	2.28				
SB02	SB02	<1	5.5 - 6.0	ND	--	No	NE	6.0	No visual/olfactory signs of contamination observed.
			0 - 6.0	--	0.34				
SB03	SB03	<1	5.5 - 6.0	ND	--	No	6.0	6.0	No visual/olfactory signs of contamination observed.
			0 - 6.0	--	0.62				
SB04	SB04	<1	5.5 - 6.0	ND	--	No	6.0	6.0	No visual/olfactory signs of contamination observed.
			0 - 6.0	--	0.76				
SB05	SB05	<1	5.5 - 6.0	ND	--	No	NE	6.0	No visual/olfactory signs of contamination observed.
			0 - 6.0	--	0.04				
SB06	SB06	<1	5.5 - 6.0	ND	--	No	NE	6.0	No visual/olfactory signs of contamination observed.
			0 - 6.0	--	9.06				
SB07	SB07	<1	5.8 - 6.3	ND	--	No	6.3	10.0	No visual/olfactory signs of contamination observed.
			0 - 6.3	--	0.57				
SB08	SB08	<1	5.5 - 6.0	0.0041	--	No	6.0	10.0	No visual/olfactory signs of contamination observed.
			0.6 - 6.0	--	0.17				
SB09	SB09	<1	5.5 - 6.0	0.0045	--	No	6.0	10.0	No visual/olfactory signs of contamination observed.
			0.3 - 6.0	--	1.01				
SB10	SB10	<1	5.5 - 6.0	ND	--	No	6.0	10.0	No visual/olfactory signs of contamination observed.
			0.4 - 6.0	--	0.97				
SB11	SB11	<1	5.3 - 5.8	ND	--	No	5.8	13.0	No visual/olfactory signs of contamination observed. Groundwater sample TWP03 was collected.
			0 - 5.8	--	0.87				
SB12	SB12	<1	5.5 - 6.0	ND	--	No	6.0	10.0	No visual/olfactory signs of contamination observed.
			0.5 - 6.0	--	0.23				
SB13	SB13	<1	5.5 - 6.0	ND	--	No	6.0	10.0	No visual/olfactory signs of contamination observed.
			0.5 - 6.0	--	0.60				
SB14	SB14	<1	5.5 - 6.0	0.0082	--	No	6.0	13.0	No visual/olfactory signs of contamination observed.
			0.4 - 6.0	--	0.22				
SB15	SB15	<1	5.5 - 6.0	0.003	--	No	6.0	10.0	No visual/olfactory signs of contamination observed.
			0.5 - 6.0	--	ND				
SB16	SB16	1.2	0.7 - 1.2	0.0087	--	No	6.0	13.0	Petroleum odor exhibited from the 0.7 - 1.2' bgs soil interval. PID reading of 1.2 ppm at 0.7' - 1.2' bgs.
			0.5 - 6.0	--	2.01				
SB17	SB17	<1	5.5 - 6.0	ND	--	No	6.0	13.0	No visual/olfactory signs of contamination observed. Groundwater sample TWP04 was collected.
			0 - 6.0	--	1.56				
SB18	SB18	671	6.0 - 6.5	0.067	--	No	6.5	10.0	Petroleum odor exhibited from the 6.5 - 10.0' bgs soil interval. Visibly stained soil encountered at 6.5 - 10.0'. PID reading of 671 ppm at 6.0' - 6.5' bgs.
			0 - 6.5	--	0.41				
SB19	SB19	<1	5.5 - 6.0	ND	--	No	NE	6.0	No visual/olfactory signs of contamination observed.
			0.5 - 6.0	--	0.33				
SB20	SB20	<1	5.5 - 6.0	ND	--	No	NE	6.0	No visual/olfactory signs of contamination observed.
			0 - 6.0	--	0.57				
SB21	SB21	<1	5.5 - 6.0	ND	--	No	NE	6.0	No visual/olfactory signs of contamination observed.
			0 - 6.0	--	0.39				
SB22	SB22	<1	5.5 - 6.0	ND	--	No	NE	6.0	No visual/olfactory signs of contamination observed.
			0 - 6.0	--	0.96				
SB23	SB23	<1	4.4 - 4.9	ND	--	No	4.9	6.0	No visual/olfactory signs of contamination observed.
			0 - 4.9	--	0.19				

Notes:

- TCLP metal(s) exceeds Resource Conservation and Recovery Act (RCRA) Hazardous Waste Levels.
- All soil samples were analyzed for Target Compound List (TCL) Volatile Organic Compounds, Polycyclic Aromatic Hydrocarbons (PAHs), Polychlorinated Biphenyls (PCBs), Toxicity Characteristic Leaching Procedure (TCLP) for Metals (RCRA 8), Total Petroleum Hydrocarbons, and RCRA Characteristics.
- PID = Photoionization detector  
 ND = Not Detected  
 NE = Not Encountered  
 ft bg = feet below ground surface

Table 2. Summary of Target Compound List (TCL) Volatile Organic Compounds (VOCs) Detected in Soil  
Phase II Subsurface Corridor Investigation for Beach Channel Drive  
Queens, New York

TCL VOCs	Unrestricted Use (Track 1) Soil Cleanup Objectives (SCOs)	Commercial Use (Track 2) Soil Cleanup Objectives (SCOs)	Restricted-Residential Use (Track 2) Soil Cleanup Objectives (SCOs)	Sample ID, Date Collected, and Depth															
				CP-51/Soil Cleanup Guidance		Residential Supplemental Soil Cleanup Objectives		Residential Supplemental Soil Cleanup Objectives		Residential Supplemental Soil Cleanup Objectives									
Isopropylbenzene	NS	NS	NS	SB01	7/18/2016	SB02	7/19/2016	SB03	7/19/2016	SB04	7/18/2016	SB05	7/19/2016	SB06	7/19/2016	SB07	7/25/2016	SB08	7/25/2016
Methylene Chloride	0.05	500	100	NS	5.5 - 6.0	5.5 - 6.0	5.5 - 6.0	5.5 - 6.0	5.5 - 6.0	5.5 - 6.0	5.5 - 6.0	5.5 - 6.0	5.5 - 6.0	5.5 - 6.0	5.5 - 6.0	5.8 - 6.3	5.5 - 6.0	5.5 - 6.0	5.5 - 6.0
				NS	ND	ND	ND	ND	ND	ND	ND	ND	ND	ND	ND	ND	ND	ND	ND
				NS	ND	ND	ND	ND	ND	ND	ND	ND	ND	ND	ND	ND	ND	ND	0.0041

TCL VOCs	Unrestricted Use (Track 1) Soil Cleanup Objectives (SCOs)	Commercial Use (Track 2) Soil Cleanup Objectives (SCOs)	Restricted-Residential Use (Track 2) Soil Cleanup Objectives (SCOs)	Sample ID, Date Collected, and Depth															
				CP-51/Soil Cleanup Guidance		Residential Supplemental Soil Cleanup Objectives		Residential Supplemental Soil Cleanup Objectives		Residential Supplemental Soil Cleanup Objectives									
Isopropylbenzene	NS	NS	NS	SB09	7/25/2016	SB10	7/25/2016	SB11	7/28/2016	SB12	7/26/2017	SB13	7/26/2017	SB14	7/27/2017	SB15	7/27/2017	SB16	7/27/2017
Methylene Chloride	0.05	500	100	NS	5.5 - 6.0	5.5 - 6.0	5.5 - 6.0	5.3 - 5.8	5.5 - 6.0	5.5 - 6.0	5.5 - 6.0	5.5 - 6.0	5.5 - 6.0	5.5 - 6.0	5.5 - 6.0	5.5 - 6.0	5.5 - 6.0	0.7 - 1.2	0.0087
				NS	ND	ND	ND	ND	ND	ND	ND	ND	ND	ND	ND	ND	ND	ND	ND
				NS	0.0045	ND	ND	ND	ND	ND	ND	ND	ND	ND	0.0062	0.003	0.003	0.003	0.0087

TCL VOCs	Unrestricted Use (Track 1) Soil Cleanup Objectives (SCOs)	Commercial Use (Track 2) Soil Cleanup Objectives (SCOs)	Restricted-Residential Use (Track 2) Soil Cleanup Objectives (SCOs)	Sample ID, Date Collected, and Depth															
				CP-51/Soil Cleanup Guidance		Residential Supplemental Soil Cleanup Objectives		Residential Supplemental Soil Cleanup Objectives		Residential Supplemental Soil Cleanup Objectives									
Isopropylbenzene	NS	NS	NS	SB17	7/28/2016	SB18	7/25/2016	SB19	7/20/2016	SB20	7/19/2016	SB21	7/19/2016	SB22	07/20/2016	SB23	07/20/2016		
Methylene Chloride	0.05	500	100	NS	5.5 - 6.0	6.0 - 6.5	6.0 - 6.5	5.5 - 6.0	5.5 - 6.0	5.5 - 6.0	5.5 - 6.0	5.5 - 6.0	5.5 - 6.0	5.5 - 6.0	5.5 - 6.0	4.4 - 4.9	4.4 - 4.9	ND	ND
				NS	ND	0.067	0.067	ND	ND	ND	ND	ND	ND	ND	ND	ND	ND	ND	ND
				NS	ND	ND	ND	ND	ND	ND	ND	ND	ND	ND	ND	ND	ND	ND	ND

Notes:  
All concentrations are in parts per million or milligrams per kilogram (ppm or mg/kg)  
ND = Compound not detected above method detection limit (see attached lab report for MDL's)  
SCOs = Soil Cleanup Objectives as per the NYSDEC Regulations 6 NYCRR Subpart 375-6 Remedial Program Soil Cleanup Objectives (December 14, 2006)  
CP-51/Soil Cleanup Guidance = Supplemental Soil Cleanup Objectives, NYSDEC, October, 2010  
NS = No Standard

Table 3. Summary of Polycyclic Aromatic Hydrocarbons (PAHs) Detected in Soil  
Phase II Subsurface Corridor Investigation for Beach Channel Drive  
Queens, New York

PAHs	Unrestricted Use (Track 1) Soil Cleanup Objectives (SCOs)	Commercial Use (Track 2) Soil Cleanup Objectives (SCOs)	Restricted-Residential Use (Track 2) Soil Cleanup Objectives (SCOs)	CP-51/Soil Cleanup Guidance	Sample ID, Date Collected, and Depth												
					Residential Supplemental Soil Cleanup Objectives												
					SB01 7/18/2016 0 - 6.0	SB02 7/19/2016 0 - 6.0	SB03 7/19/2016 0 - 6.0	SB04 7/19/2016 0 - 6.0	SB05 7/19/2016 0 - 6.0	SB06 7/19/2016 0 - 6.0	SB07 7/25/2016 0 - 6.3	SB08 7/25/2016 0.6 - 6.0					
2-Methylnaphthalene	NS	NS	NS	0.41	ND	ND	ND	ND	ND	ND	ND	ND	ND	ND	ND	ND	ND
Acenaphthene	20	500	100	NS	ND	ND	ND	ND	ND	ND	ND	ND	ND	ND	ND	ND	ND
Acenaphthylene	100	500	100	NS	0.047	ND	ND	ND	ND	ND	0.19	ND	ND	ND	ND	ND	ND
Anthracene	100	500	100	NS	0.042	ND	ND	ND	ND	ND	0.14	ND	ND	ND	ND	ND	ND
Benzo[a]anthracene	1	5.6	1	NS	0.22	0.043	0.071	0.079	ND	ND	0.85	0.066	ND	ND	ND	ND	ND
Benzo[a]pyrene	1	5.6	1	NS	0.2	0.041	0.064	0.078	ND	ND	0.94	0.057	ND	ND	ND	ND	ND
Benzo[b]fluoranthene	1	5.6	1	NS	0.28	0.059	0.087	0.11	ND	ND	1.2	0.078	ND	ND	ND	ND	0.053
Benzo[g,h,i]perylene	100	500	100	NS	0.16	0.041	0.05	0.061	ND	ND	0.74	ND	ND	ND	ND	ND	ND
Benzo[k]fluoranthene	0.8	56	3.9	NS	0.065	ND	ND	ND	ND	ND	0.38	ND	ND	ND	ND	ND	ND
Chrysene	1	56	3.9	NS	0.22	0.038	0.058	0.069	ND	ND	0.79	0.052	ND	ND	ND	ND	ND
Dibenz[a,h]anthracene	0.33	0.56	0.33	NS	0.044	ND	ND	ND	ND	ND	0.2	ND	ND	ND	ND	ND	ND
Fluoranthene	100	500	100	NS	0.26	0.054	0.095	0.12	ND	ND	0.93	0.11	ND	ND	ND	ND	0.055
Fluorene	30	500	100	NS	ND	ND	ND	ND	ND	ND	ND	ND	ND	ND	ND	ND	ND
Indeno[1,2,3-cd]pyrene	0.5	5.6	0.5	NS	0.13	ND	0.04	0.051	ND	ND	0.61	ND	ND	ND	ND	ND	ND
Naphthalene	12	500	100	NS	0.021	ND	ND	ND	ND	ND	0.047	ND	ND	ND	ND	ND	ND
Phenanthrene	100	500	100	NS	0.14	ND	0.042	0.045	ND	ND	0.44	0.069	ND	ND	ND	ND	ND
Pyrene	100	500	100	NS	0.43	0.068	0.11	0.15	0.044	1.6	0.14	0.14	0.066	0.066	0.066	0.066	0.066

Notes:  
 All concentrations are in parts per million or milligrams per kilogram (ppm or mg/kg)  
 ND = Compound not detected above method detection limit (see attached lab report for MDLs)  
 SCOs = Soil Cleanup Objectives as per the NYSDEC Regulations 6 NYCRR Subpart 375-6 Remedial Program Soil Cleanup Objectives (December 14, 2006)  
 CP51/Soil Cleanup Guidance = Supplemental Soil Cleanup Objectives, NYSDEC, October, 2010  
 NS = No Standard  
**Bold = Concentration exceeds Restricted Residential Use (Track 2) Soil Cleanup Objectives**  
**Underline = Concentration exceeds Unrestricted Use (Track 1) Soil Cleanup Objectives**

**Table 3. Summary of Polycyclic Aromatic Hydrocarbons (PAHs) Detected in Soil**  
Phase II Subsurface Corridor Investigation for Beach Channel Drive  
Queens, New York

PAHs	Unrestricted Use (Track 1) Soil Cleanup Objectives (SCOs)	Commercial Use (Track 2) Soil Cleanup Objectives (SCOs)	Restricted-Residential Use (Track 2) Soil Cleanup Objectives (SCOs)	CP-31/Soil Cleanup Guidance	Sample ID, Date Collected, and Depth												
					Residential Supplemental Soil Cleanup Objectives		SB09	SB10	SB11	SB12	SB13	SB14	SB15	SB16			
					0.3 - 6.0	0.4 - 6.0	0 - 5.8	0.5 - 6.0	0.5 - 6.0	0.4 - 6.0	0.5 - 6.0	0.5 - 6.0	0.5 - 6.0	0.5 - 6.0			
2-Methylnaphthalene	NS	NS	NS	0.41	ND	ND	ND	ND	ND	ND	ND	ND	ND	ND	ND	ND	ND
Acenaphthene	20	500	100	NS	ND	ND	ND	ND	ND	ND	ND	ND	ND	ND	ND	ND	ND
Acenaphthylene	100	500	100	NS	ND	ND	ND	ND	ND	ND	ND	ND	ND	ND	ND	ND	ND
Anthracene	100	500	100	NS	ND	ND	ND	ND	ND	ND	ND	ND	ND	ND	ND	ND	ND
Benzo[a]anthracene	1	5.6	1	NS	0.1	0.11	0.1	0.1	0.1	0.064	0.12	0.12	0.12	0.12	0.12	0.12	0.12
Benzo[a]pyrene	1	1	1	NS	0.095	0.074	0.095	0.095	0.038	0.051	0.061	0.061	0.17	0.17	0.17	0.17	0.17
Benzo[b]fluoranthene	1	5.6	1	NS	0.15	0.096	0.13	0.13	0.049	0.079	0.053	0.053	0.24	0.24	0.24	0.24	0.24
Benzo[ghi]perylene	100	500	100	NS	0.066	0.054	0.058	0.058	0.042	0.037	0.037	0.037	0.36	0.36	0.36	0.36	0.36
Benzo[k]fluoranthene	0.8	56	3.9	NS	0.049	ND	0.049	0.049	ND	ND	ND	ND	ND	ND	ND	ND	ND
Chrysene	1	56	3.9	NS	0.096	0.096	0.092	0.092	ND	0.056	0.047	0.047	0.14	0.14	0.14	0.14	0.14
Dibenzo[a,h]anthracene	0.33	0.56	0.33	NS	ND	ND	ND	ND	ND	ND	ND	ND	ND	ND	ND	ND	ND
Fluoranthene	100	500	100	NS	0.15	0.17	0.11	0.11	0.039	0.11	0.053	0.053	0.16	0.16	0.16	0.16	0.16
Fluorene	30	500	100	NS	ND	ND	ND	ND	ND	ND	ND	ND	ND	ND	ND	ND	ND
Indeno[1,2,3-cd]pyrene	0.5	5.6	0.5	NS	0.054	ND	0.052	0.052	ND	ND	ND	ND	ND	ND	ND	ND	ND
Naphthalene	12	500	100	NS	ND	ND	ND	ND	ND	ND	ND	ND	ND	ND	ND	ND	ND
Phenanthrene	100	500	100	NS	0.07	0.13	0.056	0.056	ND	0.086	0.074	0.074	0.21	0.21	0.21	0.21	0.21
Pyrene	100	500	100	NS	0.18	0.24	0.13	0.13	0.061	0.12	0.065	0.065	0.31	0.31	0.31	0.31	0.31

**Notes:**

All concentrations are in parts per million or milligrams per kilogram (ppm or mg/kg)  
 ND = Compound not detected above method detection limit (see attached lab report for MDL's)  
 SCOs = Soil Cleanup Objectives as per the NYSDEC Regulations 6 NYCRR Subpart 375-6 Remedial Program Soil Cleanup Objectives (December 14, 2006)  
 CP51/Soil Cleanup Guidance = Supplemental Soil Cleanup Objectives, NYSDEC, October, 2010  
 NS = No Standard  
**Bold = Concentration exceeds Restricted Residential Use (Track 2) Soil Cleanup Objectives**  
Underline = Concentration exceeds Unrestricted Use (Track 1) Soil Cleanup Objectives

DDC Project Number: SANDHW11

Work Order Letter No. 11364-LBA-4-10691

Table 3. Summary of Polycyclic Aromatic Hydrocarbons (PAHs) Detected in Soil  
Phase II Subsurface Corridor Investigation for Beach Channel Drive  
Queens, New York

PAHs	Unrestricted Use (Track 1) Soil Cleanup Objectives (SCOs)	Commercial Use (Track 2) Soil Cleanup Objectives (SCOs)	Restricted- Residential Use (Track 2) Soil Cleanup Objectives (SCOs)	CP-51/Soil Cleanup Guidance	Sample ID, Date Collected, and Depth									
					SB17	SB18	SB19	SB20	SB21	SB22	SB23			
					7/28/2016 0 - 6.0	7/25/2016 0 - 6.5	7/20/2016 0.5 - 6.0	7/19/2016 0 - 6.0	7/19/2016 0 - 6.0	07/20/2016 0 - 6.0	07/20/2016 0 - 4.9			
2-Methylnaphthalene	NS	NS	NS	0.41	ND	ND	ND	ND	ND	ND	ND	ND		
Acenaphthene	20	500	100	NS	ND	ND	ND	ND	ND	ND	ND	ND		
Acenaphthylene	100	500	100	NS	ND	ND	ND	ND	ND	ND	ND	ND		
Anthracene	100	500	100	NS	ND	ND	ND	ND	ND	ND	ND	ND		
Benzo[a]anthracene	1	5.6	1	NS	ND	0.046	0.04	0.062	0.043	0.097	ND	ND		
Benzo[a]pyrene	1	1	1	NS	0.26	0.046	0.039	0.048	ND	0.098	0.037	0.037		
Benzo[b]fluoranthene	1	5.6	1	NS	0.41	0.089	0.059	0.09	0.041	0.14	0.056	0.056		
Benzo[g,h,i]perylene	100	500	100	NS	ND	0.051	0.039	0.045	ND	0.091	ND	ND		
Benzo[k]fluoranthene	0.8	56	3.9	NS	ND	ND	ND	ND	ND	0.048	ND	ND		
Chrysene	1	56	3.9	NS	0.28	0.053	0.045	0.059	0.062	0.084	ND	ND		
Dibenz[a,h]anthracene	0.33	0.56	0.33	NS	ND	ND	ND	ND	ND	ND	ND	ND		
Fluoranthene	100	500	100	NS	0.27	0.061	0.037	0.086	0.064	0.13	0.046	0.046		
Fluorene	30	500	100	NS	ND	ND	ND	ND	ND	ND	ND	ND		
Indeno[1,2,3-cd]pyrene	0.5	5.6	0.5	NS	ND	ND	ND	0.038	ND	0.071	ND	ND		
Naphthalene	12	500	100	NS	ND	ND	ND	ND	ND	ND	ND	ND		
Phenanthrene	100	500	100	NS	ND	ND	ND	0.04	0.061	0.053	ND	ND		
Pyrene	100	500	100	NS	0.34	0.068	0.069	0.1	0.13	0.17	0.054	0.054		

Notes:

- All concentrations are in parts per million or milligrams per kilogram (ppm or mg/kg)
- ND = Compound not detected above method detection limit (see attached lab report for MDL's)
- SCOs = Soil Cleanup Objectives as per the NYSDEC Regulations 6 NYCRR Subpart 375-6 Remedial Program Soil Cleanup Objectives (December 14, 2006)
- CP51/Soil Cleanup Guidance = Supplemental Soil Cleanup Objectives, NYSDEC, October, 2010
- NS = No Standard
- Bold = Concentration exceeds Restricted Residential Use (Track 2) Soil Cleanup Objectives**
- Underline = Concentration exceeds Unrestricted Use (Track 1) Soil Cleanup Objectives

DDC Project Number: SANDHW11

Work Order Letter No. 11364-LBA-4-10691

Table 4. Summary of Polychlorinated Biphenyls (PCBs) Detected in Soil  
Phase II Subsurface Corridor Investigation for Beach Channel Drive  
Queens, New York

PCBs*	Unrestricted Use (Track 1) Soil Cleanup Objectives (SCOs)	Commercial Use (Track 2) Soil Cleanup Objectives (SCOs)	Restricted-Residential Use (Track 2) Soil Cleanup Objectives (SCOs)	CP-51/Soil Cleanup Guidance		Sample ID, Date Collected, and Depth										
				Residential Use Supplemental Soil Cleanup Objectives	NS	SB01	SB02	SB03	SB04	SB05	SB06	SB07	SB08			
						7/18/2016	7/19/2016	7/19/2016	7/19/2016	7/19/2016	7/19/2016	7/19/2016	7/25/2016	7/25/2016		
Aroclor-1260	NS	NS	NS	Residential Use Supplemental Soil Cleanup Objectives	NS	0 - 6.0	0 - 6.0	0 - 6.0	0 - 6.0	0 - 6.0	0 - 6.0	0 - 6.0	0 - 6.0	0 - 6.0	0 - 6.0	0 - 6.0
Aroclor (Total)	0.1*	1*	1*	NS	NS	ND	ND	ND	ND	ND	ND	0.032	ND	ND	ND	ND

PCBs*	Unrestricted Use (Track 1) Soil Cleanup Objectives (SCOs)	Commercial Use (Track 2) Soil Cleanup Objectives (SCOs)	Restricted-Residential Use (Track 2) Soil Cleanup Objectives (SCOs)	CP-51/Soil Cleanup Guidance		Sample ID, Date Collected, and Depth										
				Residential Use Supplemental Soil Cleanup Objectives	NS	SB09	SB10	SB11	SB12	SB13	SB14	SB15	SB16			
						7/25/2016	7/25/2016	7/28/2016	7/26/2017	7/27/2017	7/27/2017	7/27/2017	7/27/2017	7/27/2017		
Aroclor-1260	NS	NS	NS	Residential Use Supplemental Soil Cleanup Objectives	NS	0.3 - 6.0	0.4 - 6.0	0 - 5.8	0.5 - 6.0	0.5 - 6.0	0.4 - 6.0	ND	ND	ND	ND	ND
Aroclor (Total)	0.1*	1*	1*	NS	NS	ND	ND	ND	ND	ND	ND	ND	ND	ND	ND	ND

PCBs*	Unrestricted Use (Track 1) Soil Cleanup Objectives (SCOs)	Commercial Use (Track 2) Soil Cleanup Objectives (SCOs)	Restricted-Residential Use (Track 2) Soil Cleanup Objectives (SCOs)	CP-51/Soil Cleanup Guidance		Sample ID, Date Collected, and Depth									
				Residential Use Supplemental Soil Cleanup Objectives	NS	SB17	SB18	SB19	SB20	SB21	SB22	SB23			
						7/28/2016	7/25/2016	7/20/2016	7/19/2016	7/19/2016	07/20/2016	07/20/2016			
Aroclor-1260	NS	NS	NS	Residential Use Supplemental Soil Cleanup Objectives	NS	0 - 6.0	0 - 6.5	0.5 - 6.0	0 - 6.0	0 - 6.0	0 - 6.0	0 - 6.0	0 - 4.9	ND	ND
Aroclor (Total)	0.1*	1*	1*	NS	NS	ND	ND	ND	ND	ND	ND	ND	ND	ND	ND

Notes:  
 All concentrations are in parts per million or milligrams per kilogram (ppm or mg/kg)  
 ND = Compound not detected above method detection limit (see attached lab report for MDL's)  
 \* Refers to the total concentration of PCBs in the sample  
 SCOs = Soil Cleanup Objectives as per the NYSDEC Regulations 6 NYCRR Subpart 375-6 Remedial Program Soil Cleanup Objectives (December 14, 2006)  
 CP51/Soil Cleanup Guidance = Supplemental Soil Cleanup Objectives, NYSDEC, October, 2010  
 NS = No Standard

Table 5. Summary of Waste Classification Results in Soil  
Phase II Subsurface Corridor Investigation for Beach Channel Drive  
Queens, New York

Analyte	Resource Conservation and Recovery Act (RCRA) Hazardous Waste Levels (mg/L)	Sample ID, Date Collected, and Depth											
		SB01 7/18/2016 0 - 6.0	SB02 7/19/2016 0 - 6.0	SB03 7/19/2016 0 - 6.0	SB04 7/19/2016 0 - 6.0	SB05 7/19/2016 0 - 6.0	SB06 7/19/2016 0 - 6.0	SB07 7/25/2016 0 - 6.3	SB08 7/25/2016 0.6 - 6.0	SB09 7/25/2016 0.3 - 6.0	SB10 7/25/2016 0.4 - 6.0	SB11 7/26/2016 0 - 5.8	SB12 7/26/2017 0.5 - 6.0
RCRA (including TCLP Metals)													
pH	5 - 12.5*	8.4	8.4	8.2	8.9	8.5	8.7	8.8	9	11	8.6	8.9	9.8
Ignitability	>140 °F**	NEG	NEG	NEG	NEG	NEG	NEG	NEG	NEG	NEG	NEG	NEG	NEG
Paint Filter Test	NS	NEG	NEG	NEG	NEG	NEG	NEG	NEG	NEG	NEG	NEG	NEG	NEG
Reactive Cyanide	NS	ND	ND	ND	ND	ND	ND	ND	ND	ND	ND	ND	ND
Reactive Sulfide	NS	ND	ND	ND	ND	ND	ND	ND	ND	ND	ND	ND	ND
Asenic	5	ND	ND	ND	ND	ND	ND	ND	ND	ND	ND	ND	ND
Barium	100	0.52	ND	ND	ND	ND	ND	ND	ND	ND	ND	ND	ND
Cadmium	1	ND	ND	ND	ND	ND	ND	ND	ND	ND	ND	ND	ND
Chromium	5	ND	ND	0.057	0.15	0.11	ND	0.067	ND	ND	0.1	ND	0.16
Lead	0.2	ND	ND	ND	ND	ND	ND	ND	ND	ND	ND	ND	ND
Mercury	NS	ND	ND	ND	ND	ND	ND	ND	ND	ND	ND	ND	ND
Nickel	NS	ND	ND	ND	ND	ND	ND	ND	ND	ND	ND	ND	ND
Selenium	1	ND	ND	ND	ND	ND	ND	ND	ND	ND	ND	ND	ND
Silver	5	ND	ND	ND	ND	ND	ND	ND	ND	ND	ND	ND	ND
TPH DRO/GRO													
TPH - Gasoline Range Organics	NS	ND	ND	140	ND	ND	320	ND	ND	560	ND	ND	ND
TPH - Diesel Range Organics	NS	99	ND	140	ND	ND	320	ND	ND	560	ND	ND	ND

Notes:  
 All concentrations are in parts per million, milligrams per kilogram, or milligrams per liter (ppm, mg/kg, or mg/L), otherwise noted  
 TCLP = Toxicity Characteristic Leaching Procedure  
 NS = No Standard  
 ND = Compound not detected above method detection limit (see attached lab report for MDLs)  
 \*A solid waste exhibits the characteristic of corrosivity if it has a pH less than or equal to 5 or greater than or equal to 12.5.  
 \*\*A solid waste exhibits the characteristic of ignitability if it has flash point less than 140 °F  
 °F = Degrees Fahrenheit  
 NEG = Negative (flash point was not detected below 140 °F) or Negative (Paint was not detected from Paint Filter Test)

Table 5. Summary of Waste Classification Results in Soil  
Phase II Subsurface Corridor Investigation for Beach Channel Drive  
Queens, New York

Analyte	Resource Conservation and Recovery Act (RCRA) Hazardous Waste Levels (mg/L)	Sample ID, Date Collected, and Depth										
		SB13	SB14	SB15	SB16	SB17	SB18	SB19	SB20	SB21	SB22	SB23
		7/26/2017 0.5 - 6.0	7/27/2017 0.4 - 6.0	7/27/2017 0.5 - 6.0	7/27/2017 0.5 - 6.0	7/28/2016 0 - 6.0	7/25/2016 0 - 6.5	7/20/2016 0.5 - 6.0	7/19/2016 0 - 6.0	7/19/2016 0 - 6.0	07/20/2016 0 - 6.0	07/20/2016 0 - 4.9
RCRA (Including TCLP Metals)												
pH	5 - 12.5*	8.8	8.5	9.4	11	8.7	8.6	11	9.1	8.7	8.8	8.6
Ignitability	>140 °F**	NEG	NEG	NEG	NEG	NEG	NEG	NEG	NEG	NEG	NEG	NEG
Paint Filter Test	NS	NEG	NEG	NEG	NEG	NEG	NEG	NEG	NEG	NEG	NEG	NEG
Reactive Cyanide	NS	ND	ND	ND	ND	ND	ND	ND	ND	ND	ND	ND
Reactive Sulfide	NS	ND	ND	ND	ND	ND	ND	ND	ND	ND	ND	ND
Arsenic	5	ND	ND	ND	ND	ND	ND	ND	ND	ND	ND	ND
Barium	100	ND	ND	ND	ND	0.32	ND	ND	ND	ND	ND	ND
Cadmium	1	ND	ND	ND	ND	ND	ND	ND	ND	ND	ND	ND
Chromium	5	ND	ND	ND	ND	ND	ND	ND	ND	ND	ND	ND
Lead	5	0.057	ND	0.051	0.18	ND	0.34	ND	0.17	ND	ND	ND
Mercury	0.2	ND	ND	ND	ND	ND	ND	ND	ND	ND	ND	ND
Nickel	NS	ND	ND	ND	ND	ND	ND	ND	ND	ND	ND	ND
Selenium	1	ND	ND	ND	ND	ND	ND	ND	ND	ND	ND	ND
Silver	5	ND	ND	ND	ND	ND	ND	ND	ND	ND	ND	ND
TPH DRO/GRO												
TPH - Gasoline Range Organics	NS	ND	ND	ND	ND	ND	150	ND	ND	ND	ND	ND
TPH - Diesel Range Organics	NS	ND	ND	ND	250	1,100	ND	ND	ND	ND	100	ND

Notes:  
All concentrations are in parts per million, milligrams per kilogram, or milligrams per liter (ppm, mg/kg, or mg/L), otherwise noted  
TCLP = Toxicity Characteristic Leaching Procedure  
NS = No Standard  
ND = Compound not detected above method detection limit (see attached lab report for MDL's)  
\*A solid waste exhibits the characteristic of corrosivity if it has a pH less than or equal to 5 or greater than or equal to 12.5.  
\*\*A solid waste exhibits the characteristic of ignitability if it has flash point less than 140 °F  
°F = Degrees Fahrenheit  
NEG = Negative flash point was not detected below 140 °F or Negative (Paint was not detected from Paint Filter Test)



Table 6. Groundwater Quality Compared to New York City Department of Environmental Protection  
Limitations for Effluent to Sanitary or Combined Sewers  
Phase II Subsurface Corridor Investigation for Beach Channel Drive  
Queens, New York

Parameter <sup>1</sup>	NYC DEP Limitations to Sanitary or Combined Sewers		Sample ID, Date Collected and Depth	
			TWP03 7/28/2016 0 - 5.8	TWP04 7/28/2016 0 - 6.0
Non-Polar Material <sup>2</sup>	50	mg/L	ND	ND
Flash Point - Liquid/Solid	> 140	*F	> 141	*F
pH <sup>1</sup>	>2 and <10		7.7	7.3
Cadmium (Instantaneous or Composite)	2 or 0.69	mg/L	ND	ND
Chromium Hexavalent (VI)	5	mg/L	ND	ND
Copper	5	mg/L	ND	ND
Lead	2	mg/L	0.0083	ND
Mercury	0.05	mg/L	ND	ND
Nickel	3	mg/L	ND	ND
Zinc	5	mg/L	ND	0.005
Benzene	134	ug/L	ND	ND
Carbon tetrachloride	NS	ug/L	ND	ND
Chloroform	NS	ug/L	38	ND
1,4-Dichlorobenzene	NS	ug/L	ND	ND
Ethylbenzene	380	ug/L	ND	ND
MTBE (Methyl-Tert-Butyl-Ether)	50	ug/L	ND	ND
Naphthalene	47	ug/L	ND	ND
Phenol	NS	ug/L	ND	ND
Tetrachloroethene	20	ug/L	ND	ND
Toluene	74	ug/L	ND	ND
1,2,4-Trichlorobenzene	NS	ug/L	ND	ND
1,1,1-Trichloroethane	NS	ug/L	ND	ND
Xylenes (Total)	74	ug/L	ND	ND
PCBs (Total) <sup>3</sup>	1	ug/L	ND	ND
Total Suspended Solids <sup>4</sup>	350	mg/L	7.2	11
CBOD <sup>5</sup>	NS	mg/L	ND	3.9
Chloride <sup>6</sup>	NS	mg/L	71	4,700
Total Nitrogen <sup>6</sup>	NS	mg/L	1.7	0.49
Total Solids <sup>6</sup>	NS	mg/L	240	10,000

Notes:

NS = No Standard

ND = Compound not detected above method detection limit (see attached lab report for MDLs)

~~MDL and shaded concentration exceeds NYC DEP Limitations for Effluent to Sanitary or Combined Sewers (d.d. 11/10/2005)~~

<sup>1</sup> All handling and preservation of collected samples and laboratory analyses of samples was performed in accordance with 40 CFR Part 136.

<sup>2</sup> Analysis for non-polar materials was performed by EPA method 1664.

<sup>3</sup> Analysis for polychlorinated biphenyls (PCBs) was performed according to EPA method 608 with method detection limits 65 parts per trillion. Analysis for PCBs is required if discharge ≥ 10,000 gallons per day (gpd) and duration of discharge > 10 days.

<sup>4</sup> For discharge ≥ 10,000 gpd, the total suspended solids (TSS) limit is 350 mg/l. For discharge < 10,000 gpd, the limit is determined on a case by case basis.

<sup>5</sup> Analysis for Carbonaceous Biochemical Oxygen Demand (CBOD), Chloride, Total Solids, and Total Nitrogen are required if proposed discharge ≥ 10,000 gpd.

**FIGURE 1 – TOPOGRAPHIC CORRIDOR LOCATION MAP**

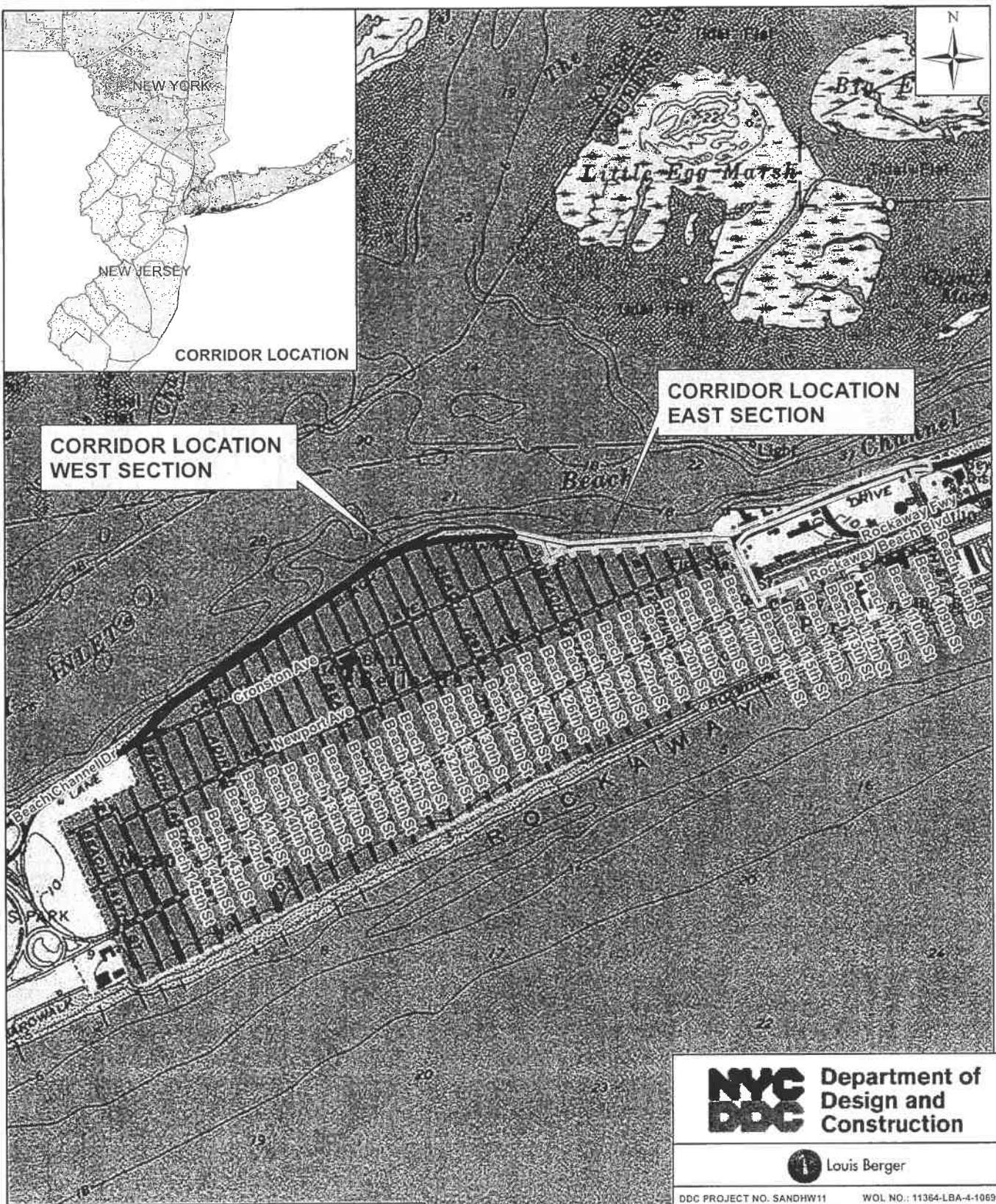

**CORRIDOR LOCATION  
WEST SECTION**

**CORRIDOR LOCATION  
EAST SECTION**

**Legend**

- Approximate Corridor Location West Section
- Approximate Corridor Location East Section

**NYC DDC** Department of Design and Construction

**Louis Berger**

DDC PROJECT NO. SANDHW11 WOL NO.: 11364-LBA-4-10691

**TOPOGRAPHIC CORRIDOR LOCATION MAP**  
 PHASE II SUBSURFACE CORRIDOR INVESTIGATION  
 FOR BEACH CHANNEL DRIVE  
 BEACH CHANNEL DRIVE BETWEEN  
 108TH STREET AND 145TH STREET  
 QUEENS, NEW YORK

Source: USGS Quadrangle Far Rockaway, New York, 1995

SCALE: 1" = 1,500' DATE: 8/8/2016 FIGURE: 1

**FIGURE 2A – SOIL BORING LOCATION PLAN – WESTERN SECTION**

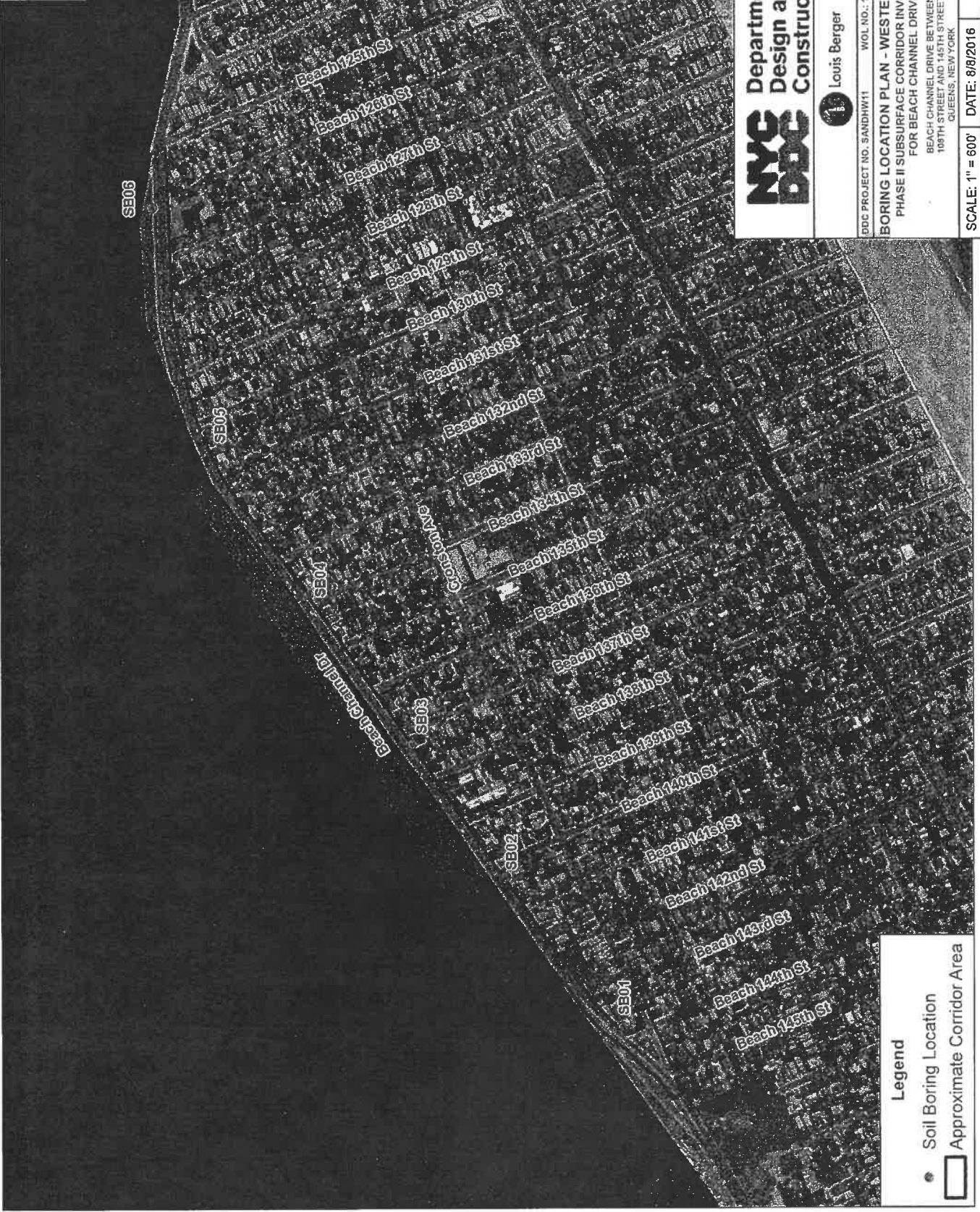

**NYC DDC**  
 Department of Design and Construction

Louis Berger

DDC PROJECT NO. SANDHW11 WOL NO.: T1364-LBA-4-10651

**BORING LOCATION PLAN - WESTERN SECTION**  
 PHASE II SUBSURFACE CORRIDOR INVESTIGATION  
 FOR BEACH CHANNEL DRIVE

BEACH CHANNEL DRIVE BETWEEN  
 109TH STREET AND 145TH STREET  
 QUEENS, NEW YORK

SCALE: 1" = 600' DATE: 8/8/2016 FIGURE: 2A

**Legend**  
 • Soil Boring Location  
 □ Approximate Corridor Area

**FIGURE 2B – SOIL BORING LOCATION PLAN – EASTERN SECTION**



**NYC**  
**DDC**  
Department of  
Design and  
Construction

**1** Louis Berger

DDC PROJECT NO. SANDHW11 WOL NO.: 11364-LBA-4-10691

**BORING LOCATION PLAN - EASTERN SECTION**  
**PHASE II SUBSURFACE CORRIDOR INVESTIGATION**  
FOR BEACH CHANNEL DRIVE  
BEACH CHANNEL DRIVE BETWEEN  
108TH STREET AND 145TH STREET  
QUEENS, NEW YORK

SCALE: 1" = 600' DATE: 8/8/2016 FIGURE: 2B

**Legend**

- Soil Boring Location
- Soil Boring and Temporary Well Location
- Approximate Corridor Area

**APPENDIX A**  
**BORING LOCATION PLAN**





1 Louis Berger

DDC PROJECT NO. SANDHW11 WOL NO.: 1364-LEA-4-10691  
**BORING LOCATION PLAN - WESTERN SECTION**  
**PHASE II SUBSURFACE CORRIDOR INVESTIGATION**  
 FOR BEACH CHANNEL DRIVE  
 BEACH CHANNEL DRIVE BETWEEN  
 106TH STREET AND 145TH STREET  
 QUEENS, NEW YORK

SCALE: 1" = 200' DATE: 8/8/2016 APPENDIX: A-1

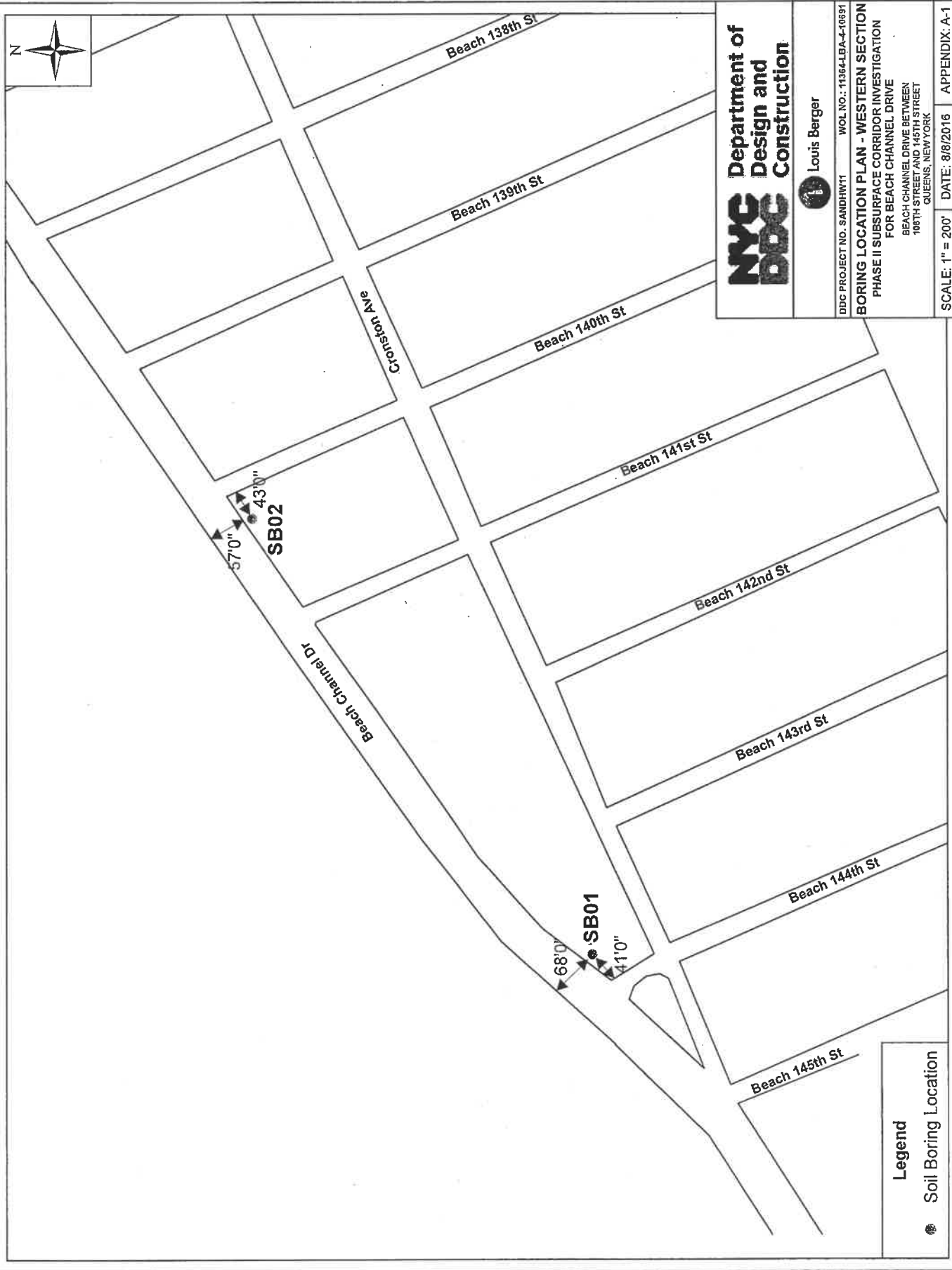

**Legend**

- Soil Boring Location



**NYC**  
**DDC**  
**Construction**

Department of  
Design and  
Construction

Louis Berger

DDC PROJECT NO.: SANDHW11 WOL NO.: 11364-LBA-4-10691

**BORING LOCATION PLAN - WESTERN SECTION**  
PHASE II SUBSURFACE CORRIDOR INVESTIGATION  
FOR BEACH CHANNEL DRIVE

BEACH CHANNEL DRIVE BETWEEN  
108TH STREET AND 145TH STREET  
QUEENS, NEW YORK

SCALE: 1" = 200' DATE: 8/8/2016 APPENDIX: A-2



**Legend**

- Soil Boring Location



SB06

1'0"09

1'0"

Beach 125th St

Beach 126th St

Beach 127th St

Beach 128th St

Beach 129th St

Beach 130th St

Beach 131st St

Beach 132nd St

Beach Channel Dr

Conston Ave

SB05

3'0"0"

5'7"0"

Legend  
● Soil Boring Location

**NYC**  
**DDC**  
**Construction**

Louis Berger

DDC PROJECT NO. SANDHW11 WOL NO.: 11364-LBA-4-10691  
**BORING LOCATION PLAN - WESTERN SECTION**  
**PHASE II SUBSURFACE CORRIDOR INVESTIGATION**  
FOR BEACH CHANNEL DRIVE  
BEACH CHANNEL DRIVE BETWEEN  
108TH STREET AND 145TH STREET  
QUEENS, NEW YORK

SCALE: 1" = 200' DATE: 8/8/2016 APPENDIX: A-3



**NYC**  
**DDC**  
**Construction**

Department of  
Design and  
Construction

Louis Berger

DDC PROJECT NO. SANDHW11 WOL NO.: 11364-LBA-4-10691  
BORING LOCATION PLAN - EASTERN SECTION  
PHASE II SUBSURFACE CORRIDOR INVESTIGATION  
FOR BEACH CHANNEL DRIVE  
BEACH CHANNEL DRIVE BETWEEN  
100TH STREET AND 145TH STREET  
QUEENS, NEW YORK

SCALE: 1" = 100' DATE: 8/8/2016 APPENDIX: A-4

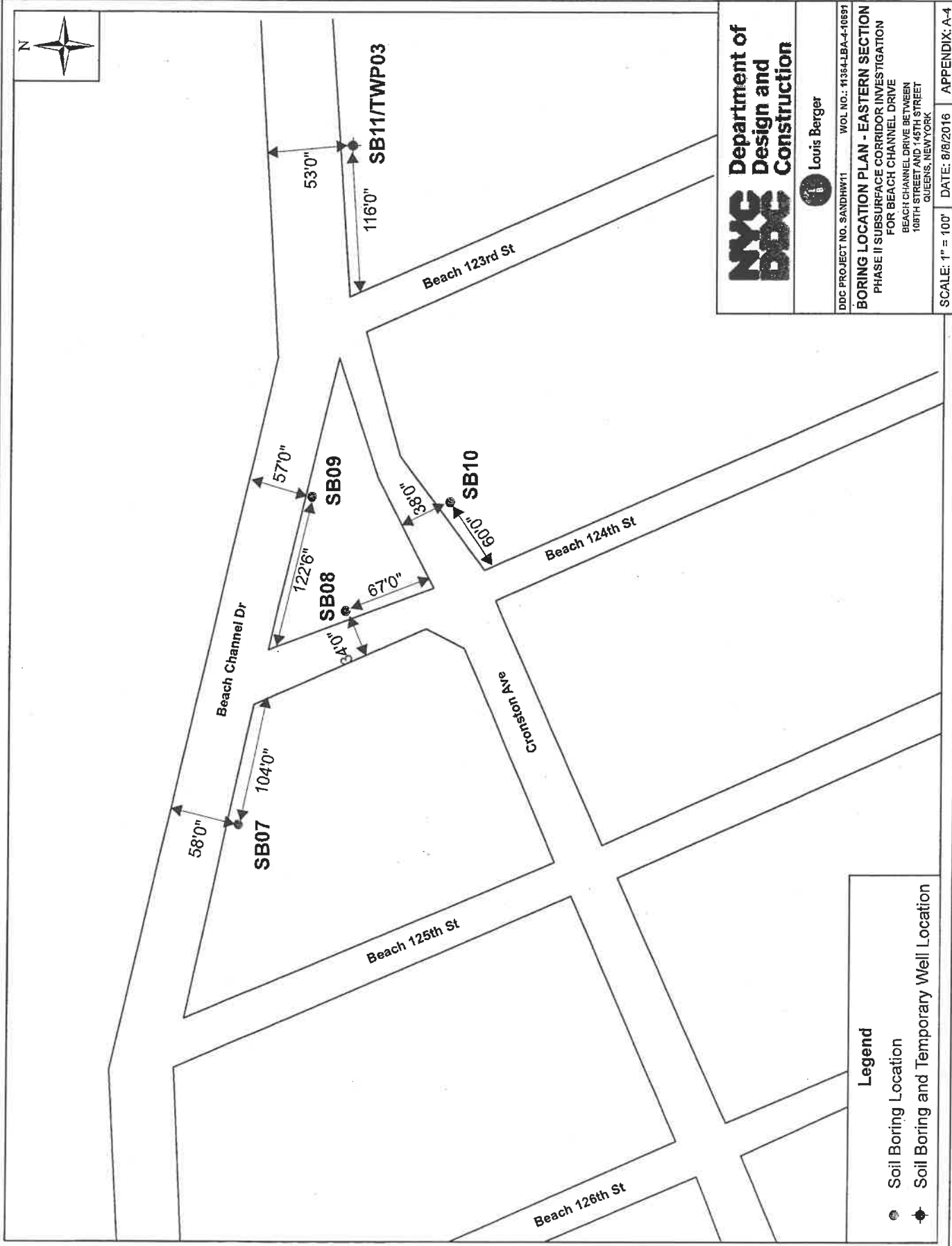

- Legend**
- Soil Boring Location
  - ⊕ Soil Boring and Temporary Well Location



53'0"  
93'0"  
SB15

52'0"  
98'0"  
SB14

60'0"  
70'6"  
SB13

54'0"  
40'0"  
SB12

Beach 119th St

Beach 120th St

Beach 121st St

Beach 122nd St

Beach Channel Dr

Newport Ave

**NYC**  
**DDC**  
Department of  
Design and  
Construction



Louis Berger

DDC PROJECT NO. SANDHW11 WOL NO.: 11364-LEA-4-10681  
**BORING LOCATION PLAN - EASTERN SECTION**  
PHASE II SUBSURFACE CORRIDOR INVESTIGATION  
FOR BEACH CHANNEL DRIVE  
BEACH CHANNEL DRIVE BETWEEN  
108TH STREET AND 145TH STREET  
QUEENS, NEW YORK

SCALE: 1" = 100' DATE: 8/8/2016 APPENDIX: A-5

**Legend**  
● Soil Boring Location



**NYC** Department of Design and Construction

Louis Berger

DDC PROJECT NO. SANDHW11 WOL NO.: 11364-LBA-4-10691

**BORING LOCATION PLAN - EASTERN SECTION**  
 PHASE II SUBSURFACE CORRIDOR INVESTIGATION  
 FOR BEACH CHANNEL DRIVE  
 BEACH CHANNEL DRIVE BETWEEN  
 100TH STREET AND 145TH STREET  
 QUEENS, NEW YORK

SCALE: 1" = 100' DATE: 8/8/2016 APPENDIX: A-6

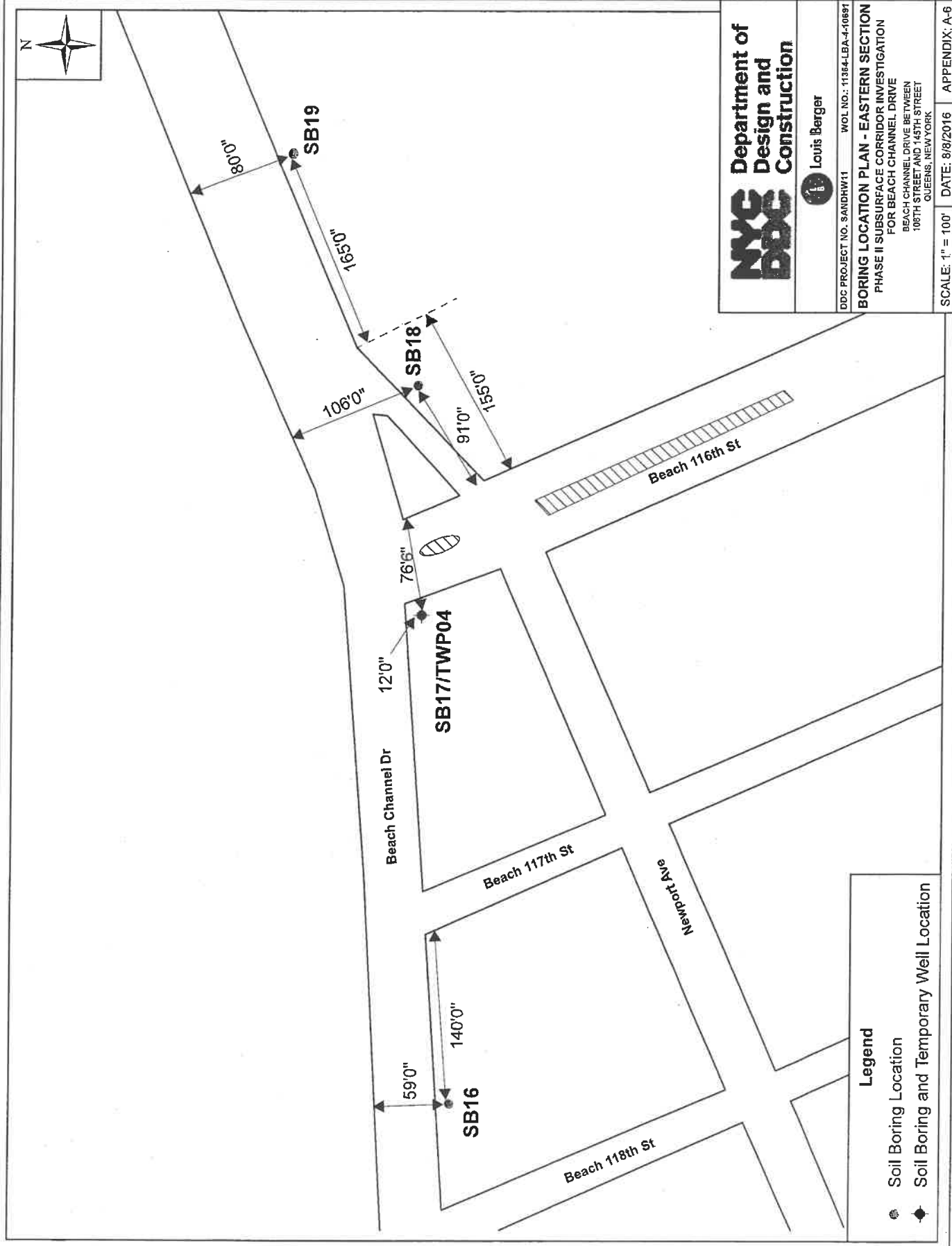

- Legend**
- Soil Boring Location
  - ◆ Soil Boring and Temporary Well Location



Beach Channel Dr

Beach 108th St

72'0"

SB21

38'0"

Rockaway Fwy

Rockaway Beach Blvd

75'0"

SB20

10'10"

**NYC**  
**DDC**  
**Construction**

Louis Berger

DDC PROJECT NO. SANDHW11 WOL NO.: T1364-LBA-4-10691

**BORING LOCATION PLAN - EASTERN SECTION**  
PHASE II SUBSURFACE CORRIDOR INVESTIGATION  
FOR BEACH CHANNEL DRIVE

BEACH CHANNEL DRIVE BETWEEN  
108TH STREET AND 145TH STREET  
QUEENS, NEW YORK

SCALE: 1" = 200' DATE: 8/8/2016 APPENDIX A-7

**Legend**  
● Soil Boring Location



**NYC**  
**DDC**  
**Construction**

Department of  
Design and  
Construction

Louis Berger

DDC PROJECT NO. SANDHW11 WOL NO.: 11364-LBA-4-10851

**BORING LOCATION PLAN - EASTERN SECTION**  
PHASE II SUBSURFACE CORRIDOR INVESTIGATION  
FOR BEACH CHANNEL DRIVE  
BEACH CHANNEL DRIVE BETWEEN  
108TH STREET AND 145TH STREET  
QUEENS, NEW YORK

SCALE: 1" = 100' DATE: 8/8/2016 APPENDIX: A-8

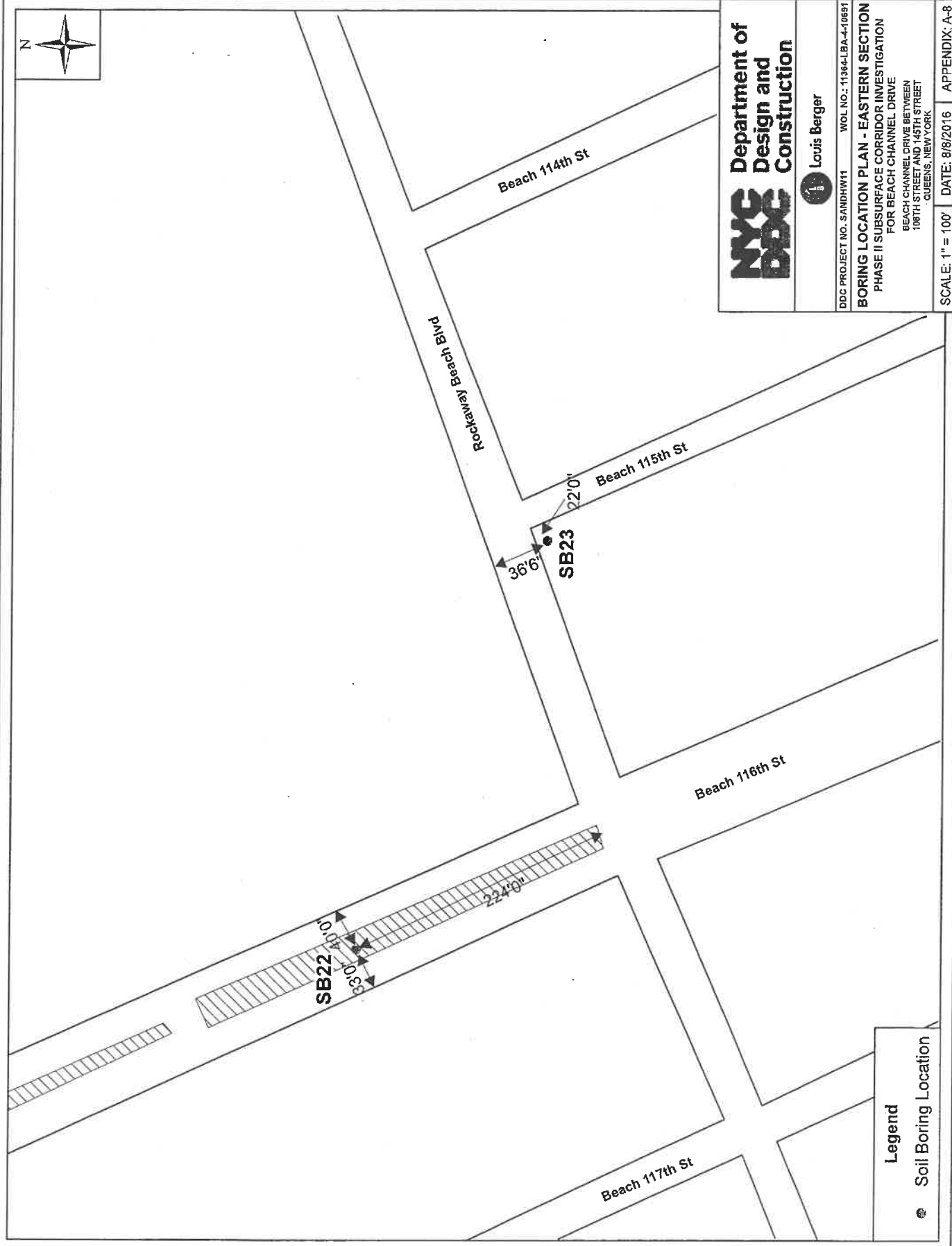

**Legend**

● Soil Boring Location



**APPENDIX B**  
**GEOLOGIC BORING LOGS**



Louis Berger

# Drilling Log

Page 1 of 1

**BORING NO.:** SB01

**LOCATION:** Queens, NY

**CLIENT:** New York City Department of Design and Construction

**PROJECT NO.:** 2011040.093

**PROJECT:** Beach Channel Drive

**FMS ID#:** SANDHW11

**DRILLING CONTRACTOR:** Zebra Technical Services, LLC

**WOL #:** 11364-LBA-4-10691

**DRILLING METHOD:** Vactron and Airknife

**DATE STARTED:** 7/18/2016

### BOREHOLE DATA

### WELL DATA

**DATE FINISHED:** 7/18/2016

**Diameter (in):** 6

**Well Diameter (in):** N/A

**DRILLER:** E. Moraitis

**Total Depth (ft.):** 6

**Total Depth (ft.):** N/A

**LBA INSPECTOR:** J. Ganz

**Depth to Refusal (ft.):** N/A

**Screen Length (ft.):** N/A

**NORTHING (ft):** 149108.12

**Depth to Water (ft.):** 6

**Depth to Water (ft.):** N/A

**EASTING (ft):** 1022451.77

**Depth to Rock (ft.):** N/A

**Slot Size (in):** N/A

**SURFACE ELEVATION (ft):** N/A

**NOTES:** Soil description based on Unified Soil Classification System (USCS), Burnmister Classification and Munsell Rock Color Chart.

Soil boring was pre-cleared to 6 ft bg.

Well Construction	Depth (feet)	Lithology	USCS	Sample Interval	Sample Recovery	PID Reading (ppm)	Description and Stratigraphy	Remarks
	0		FILL			<1	Dark yellowish brown (10YR 4/2) medium to fine SAND, trace Silt, little coarse to fine Gravel; dry.	Sand (Fill)  Collected grab sample SB01 from 5.5 to 6.0 ft bg and composite sample SB01 from 0 to 6.0 ft bg
	2		FILL			<1	Pale yellowish brown (10YR 6/2) medium to fine SAND, trace fine Gravel; dry.	
	4		FILL			<1	Pale yellowish brown (10YR 6/2) coarse to fine SAND; moist.	
	6						Total Depth of Boring 6 feet.	



# Drilling Log

Page 1 of 1

**BORING NO.:** SB02

**LOCATION:** Queens, NY

**CLIENT:** New York City Department of Design and Construction

**PROJECT NO.:** 2011040.093

**PROJECT:** Beach Channel Drive

**FMS ID#:** SANDHW11

**DRILLING CONTRACTOR:** Zebra Technical Services, LLC

**WOL #:** 11364-LBA-4-10691

**DRILLING METHOD:** Vactron and Airknife

**DATE STARTED:** 7/19/2016

**BOREHOLE DATA**

**WELL DATA**

**DATE FINISHED:** 7/19/2016

**Diameter (in):** 6

**Well Diameter (in):** N/A

**DRILLER:** E. Moraitis

**Total Depth (ft.):** 6

**Total Depth (ft.):** N/A

**LBA INSPECTOR:** J. Ganz

**Depth to Refusal (ft):** N/A

**Screen Length (ft):** N/A

**NORTHING (ft):** 149663.44

**Depth to Water (ft.):** N/A

**Depth to Water (ft.):** N/A

**EASTING (ft):** 1023166.49

**Depth to Rock (ft.):** N/A

**Slot Size (in):** N/A

**SURFACE ELEVATION (ft):** N/A

**NOTES:** Soil description based on Unified Soil Classification System (USCS), Burnmaster Classification and Munsell Rock Color Chart.

Soil boring was pre-cleared to 6 ft bg.

Well Construction	Depth (feet)	Lithology	USCS	Sample Interval	Sample Recovery	PID Reading (ppm)	Description and Stratigraphy	Remarks	
	0		FILL			<1	Dark yellowish brown (10YR 4/2) medium to fine SAND, little Silt, trace fine Gravel; moist.	Sand (Fill)  Collected grab sample SB02 from 5.5 to 6.0 ft bg and composite sample SB02 from 0 to 6.0 ft bg	
	6.0		FILL			<1	Pale yellowish brown (10YR 6/2) coarse to fine SAND, trace fine Gravel; moist.		
	Total Depth of Boring 6 feet.								



Louis Berger

# Drilling Log

Page 1 of 1

**BORING NO.:** SB03

**LOCATION:** Queens, NY

**CLIENT:** New York City Department of Design and Construction

**PROJECT NO.:** 2011040.093

**PROJECT:** Beach Channel Drive

**FMS ID#:** SANDHW11

**DRILLING CONTRACTOR:** Zebra Technical Services, LLC

**WOL #:** 11364-LBA-4-10691

**DRILLING METHOD:** Vactron and Airknife

**DATE STARTED:** 7/19/2016

### BOREHOLE DATA

### WELL DATA

**DATE FINISHED:** 7/19/2016

**Diameter (in):** 6

**Well Diameter (in):** N/A

**DRILLER:** E. Moraitis

**Total Depth (ft.):** 6

**Total Depth (ft.):** N/A

**LBA INSPECTOR:** J. Ganz

**Depth to Refusal (ft):** N/A

**Screen Length (ft):** N/A

**NORTHING (ft):** 150105.19

**Depth to Water (ft.):** 6

**Depth to Water (ft.):** N/A

**EASTING (ft):** 1023799.96

**Depth to Rock (ft.):** N/A

**Slot Size (in):** N/A

**SURFACE ELEVATION (ft):** N/A

**NOTES:** Soil description based on Unified Soil Classification System (USCS), Burmister Classification and Munsell Rock Color Chart.

Soil boring was pre-cleared to 6 ft bg.

Well Construction	Depth (feet)	Lithology	USCS	Sample Interval	Sample Recovery	PID Reading (ppm)	Description and Stratigraphy	Remarks	
	0		FILL			△	Dark yellowish brown (10YR 4/2) medium to fine SAND, little Silt, trace fine Gravel; moist.	Sand (Fill) Collected grab sample SB03 from 5.5 to 6.0 ft bg and composite sample SB03 from 0 to 6.0 ft bg	
	6		FILL			△	Pale yellowish brown (10YR 6/2) coarse to fine SAND, trace Gravel; moist.		
	Total Depth of Boring 6 feet.								▽



Louis Berger

# Drilling Log

Page 1 of 1

**BORING NO.:** SB04

**LOCATION:** Queens, NY

**CLIENT:** New York City Department of Design and Construction

**PROJECT NO.:** 2011040.093

**PROJECT:** Beach Channel Drive

**FMS ID#:** SANDHW11

**DRILLING CONTRACTOR:** Zebra Technical Services, LLC

**WOL #:** 11364-LBA-4-10691

**DRILLING METHOD:** Vactron and Airknife

**DATE STARTED:** 7/18/2016

### BOREHOLE DATA

### WELL DATA

**DATE FINISHED:** 7/18/2016

**Diameter (in):** 6

**Well Diameter (in):** N/A

**DRILLER:** E. Moraitis

**Total Depth (ft.):** 6

**Total Depth (ft.):** N/A

**LBA INSPECTOR:** J. Ganz

**Depth to Refusal (ft):** N/A

**Screen Length (ft):** N/A

**NORTHING (ft):** 150596.96

**Depth to Water (ft.):** 6

**Depth to Water (ft.):** N/A

**EASTING (ft):** 1024517.82

**Depth to Rock (ft.):** N/A

**Slot Size (in):** N/A

**SURFACE ELEVATION (ft):** N/A

**NOTES:** Soil description based on Unified Soil Classification System (USCS), Burnmister Classification and Munsell Rock Color Chart.

Soil boring was pre-cleared to 6 ft bg.

Well Construction	Depth (feet)	Lithology	USCS	Sample Interval	Sample Recovery	PID Reading (ppm)	Description and Stratigraphy	Remarks
	0		FILL			<1	Dusky yellowish brown (10YR 2/2) SILT, little medium to fine Sand; moist.	Silt (Fill)
	0.5		FILL			<1	Dark yellowish brown (10YR 4/2) medium to fine SAND, trace Silt, trace fine Gravel; moist.	Sand (Fill)
	2							
	4		FILL			<1	Pale yellowish brown (10YR 6/2) coarse to fine SAND, trace fine Gravel; moist.	Collected grab sample SB04 from 5.5 to 6.0 ft bg and composite sample SB04 from 0 to 6.0 ft bg
	6						Total Depth of Boring 6 feet.	▽



Louis Berger

# Drilling Log

Page 1 of 1

**BORING NO.:** SB05

**LOCATION:** Queens, NY

**CLIENT:** New York City Department of Design and Construction

**PROJECT NO.:** 2011040.093

**PROJECT:** Beach Channel Drive

**FMS ID#:** SANDHW11

**DRILLING CONTRACTOR:** Zebra Technical Services, LLC

**WOL #:** 11364-LBA-4-10691

**DRILLING METHOD:** Vactron and Airknife

**DATE STARTED:** 7/19/2016

### BOREHOLE DATA

### WELL DATA

**DATE FINISHED:** 7/19/2016

**Diameter (in):** 6

**Well Diameter (in):** N/A

**DRILLER:** E. Moraitis

**Total Depth (ft.):** 6

**Total Depth (ft.):** N/A

**LBA INSPECTOR:** J. Ganz

**Depth to Refusal (ft):** N/A

**Screen Length (ft):** N/A

**NORTHING (ft):** 151081.44

**Depth to Water (ft.):** N/A

**Depth to Water (ft.):** N/A

**EASTING (ft):** 1025289.85

**Depth to Rock (ft.):** N/A

**Slot Size (in):** N/A

**SURFACE ELEVATION (ft):** N/A

**NOTES:** Soil description based on Unified Soil Classification System (USCS), Burnmister Classification and Munsell Rock Color Chart.

Soil boring was pre-cleared to 6 ft bg.

Well Construction	Depth (feet)	Lithology	USCS	Sample Interval	Sample Recovery	PID Reading (ppm)	Description and Stratigraphy	Remarks
	0		FILL			<1	Dark yellowish brown (10YR 4/2) medium to fine SAND, little Silt; moist.	Sand (Fill)
	5.5		FILL			<1	Pale yellowish brown (10YR 6/2) medium to fine SAND, trace coarse to fine Gravel; moist.	Collected grab sample SB05 from 5.5 to 6.0 ft bg and composite sample SB05 from 0 to 6.0 ft bg
	6						Total Depth of Boring 6 feet.	

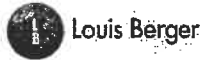

# Drilling Log

Page 1 of 1

**BORING NO.:** SB06

**LOCATION:** Queens, NY

**CLIENT:** New York City Department of Design and Construction

**PROJECT NO.:** 2011040.093

**PROJECT:** Beach Channel Drive

**FMS ID#:** SANDHW11

**DRILLING CONTRACTOR:** Zebra Technical Services, LLC

**WOL #:** 11364-LBA-4-10691

**DRILLING METHOD:** Vactron and Airknife

**DATE STARTED:** 7/19/2016

**BOREHOLE DATA**

**WELL DATA**

**DATE FINISHED:** 7/19/2016

**Diameter (in):** 6

**Well Diameter (in):** N/A

**DRILLER:** E. Moraitis

**Total Depth (ft.):** 6

**Total Depth (ft.):** N/A

**LBA INSPECTOR:** J. Ganz

**Depth to Refusal (ft.):** N/A

**Screen Length (ft.):** N/A

**NORTHING (ft):** 151338.79

**Depth to Water (ft.):** N/A

**Depth to Water (ft.):** N/A

**EASTING (ft):** 1026365.07

**Depth to Rock (ft.):** N/A

**Slot Size (in):** N/A

**SURFACE ELEVATION (ft):** N/A

**NOTES:** Soil description based on Unified Soil Classification System (USCS), Burmister Classification and Munsell Rock Color Chart.

Soil boring was pre-cleared to 6 ft bg.

Well Construction	Depth (feet)	Lithology	USCS	Sample Interval	Sample Recovery	PID Reading (ppm)	Description and Stratigraphy	Remarks
	0		FILL			<1	Dark yellowish brown (10YR 4/2) medium to fine SAND, little Silt, little coarse to fine Gravel; moist.	Sand (Fill)  Collected grab sample SB04 from 5.5 to 6.0 ft bg and composite sample SB04 from 0 to 6.0 ft bg
	0.5		FILL			<1	Pale yellowish brown (10YR 6/2) medium to fine SAND, trace coarse to fine Gravel (5% fill material - asphalt, brick, glass, slag); moist.	
	6						Total Depth of Boring 6 feet.	



Louis Berger

# Drilling Log

Page 1 of 2

**BORING NO.:** SB07

**LOCATION:** Queens, NY

**CLIENT:** New York City Department of Design and Construction

**PROJECT NO.:** 2011040.093

**PROJECT:** Beach Channel Drive

**FMS ID#:** SANDHW11

**DRILLING CONTRACTOR:** Zebra Technical Services, LLC

**WOL #:** 11364-LBA-4-10691

**DRILLING METHOD:** Direct Push

**DATE STARTED:** 7/21/2016

### BOREHOLE DATA

### WELL DATA

**DATE FINISHED:** 7/25/2016

**Diameter (in):** 2

**Well Diameter (in):** N/A

**DRILLER:** E. Moraitis

**Total Depth (ft.):** 10

**Total Depth (ft.):** N/A

**LBA INSPECTOR:** J. Ganz

**Depth to Refusal (ft.):** N/A

**Screen Length (ft.):** N/A

**NORTHING (ft):** 151220.93

**Depth to Water (ft.):** 6.3

**Depth to Water (ft.):** N/A

**EASTING (ft):** 1026858.82

**Depth to Rock (ft.):** N/A

**Slot Size (in):** N/A

**SURFACE ELEVATION (ft):** N/A

**NOTES:** Soil description based on Unified Soil Classification System (USCS), Burmister Classification and Munsell Rock Color Chart.

Soil boring was pre-cleared to 6 ft bg.

Well Construction	Depth (feet)	Lithology	USCS	Sample Interval	Sample Recovery	PID Reading (ppm)	Description and Stratigraphy	Remarks
			FILL			<1	Dusky yellowish brown (10YR 2/2) medium to fine SAND, little Silt; moist.	Sand (Fill)
			FILL			<1	Pale yellowish brown (10YR 6/2) coarse to fine SAND; moist.	
	2							
	4							
	6		SP			<1	Moderate yellowish brown (10YR 5/4) to dark yellowish brown (10YR 4/2) coarse to fine SAND, trace fine Gravel; wet.	∇





# Drilling Log

Page 2 of 2

**BORING NO.:** SB07

**LOCATION:** Queens, NY

**CLIENT:** New York City Department of Design and Construction

**PROJECT NO.:** 2011040.093

**PROJECT:** Beach Channel Drive

**FMS ID#:** SANDHW11

**DRILLING CONTRACTOR:** Zebra Technical Services, LLC

**WOL #:** 11364-LBA-4-10691

**DRILLING METHOD:** Direct Push

**DATE STARTED:** 7/21/2016

**BOREHOLE DATA**

**WELL DATA**

**DATE FINISHED:** 7/25/2016

**Diameter (in):** 2

**Well Diameter (in):** N/A

**DRILLER:** E. Moraitis

**Total Depth (ft.):** 10

**Total Depth (ft.):** N/A

**LBA INSPECTOR:** J. Ganz

**Depth to Refusal (ft.):** N/A

**Screen Length (ft.):** N/A

**NORTHING (ft):** 151220.93

**Depth to Water (ft.):** 6.3

**Depth to Water (ft.):** N/A

**EASTING (ft):** 1026858.82

**Depth to Rock (ft.):** N/A

**Slot Size (in):** N/A

**SURFACE ELEVATION (ft):** N/A

**NOTES:** Soil description based on Unified Soil Classification System (USCS), Burmister Classification and Munsell Rock Color Chart.

Soil boring was pre-cleared to 6 ft bg.

Well Construction	Depth (feet)	Lithology	USCS	Sample Interval	Sample Recovery	PID Reading (ppm)	Description and Stratigraphy	Remarks
	8		SP			<1	Moderate yellowish brown (10YR 5/4) to dark yellowish brown (10YR 4/2) coarse to fine SAND, trace fine Gravel; wet.	Sand, Collected grab sample SB07 from 5.8 to 6.3 ft bg and composite sample SB07 from 0 to 6.3 ft bg
	10						Total Depth of Boring 10 feet.	
	12							
	14							



Louis Berger

# Drilling Log

Page 1 of 2

**BORING NO.:** SB08

**LOCATION:** Queens, NY

**CLIENT:** New York City Department of Design and Construction

**PROJECT NO.:** 2011040.093

**PROJECT:** Beach Channel Drive

**FMS ID#:** SANDHW11

**DRILLING CONTRACTOR:** Zebra Technical Services, LLC

**WOL #:** 11364-LBA-4-10691

**DRILLING METHOD:** Direct Push

**DATE STARTED:** 7/20/2016

### BOREHOLE DATA

### WELL DATA

**DATE FINISHED:** 7/25/2016

**Diameter (in):** 2

**Well Diameter (in):** N/A

**DRILLER:** E. Moraitis

**Total Depth (ft.):** 10

**Total Depth (ft.):** N/A

**LBA INSPECTOR:** J. Ganz

**Depth to Refusal (ft.):** N/A

**Screen Length (ft.):** N/A

**NORTHING (ft):** 151133.84

**Depth to Water (ft.):** 6

**Depth to Water (ft.):** N/A

**EASTING (ft):** 1027036.20

**Depth to Rock (ft.):** N/A

**Slot Size (in):** N/A

**SURFACE ELEVATION (ft):** N/A

**NOTES:** Soil description based on Unified Soil Classification System (USCS), Burmister Classification and Munsell Rock Color Chart.  
Soil boring was pre-cleared to 6 ft bg.

Well Construction	Depth (feet)	Lithology	USCS	Sample Interval	Sample Recovery	PID Reading (ppm)	Description and Stratigraphy	Remarks
	0	CONCRETE				<1	Light gray (N7) CONCRETE; dry.	Concrete
	0	FILL				<1	Dark yellowish brown (10YR 4/2) medium to fine SAND, trace Silt, some coarse to fine Gravel; moist.	Gravelly Sand (Fill) Sand (Fill)
	0	FILL				<1	Pale yellowish brown (10YR 6/2) coarse to fine SAND; moist.	
	2							
	4							
	6		SP			<1	Pale yellowish brown (10YR 6/2) coarse to fine SAND, trace fine Gravel; wet.	▽



Louis Berger

# Drilling Log

Page 2 of 2

**BORING NO.:** SB08

**LOCATION:** Queens, NY

**CLIENT:** New York City Department of Design and Construction

**PROJECT NO.:** 2011040.093

**PROJECT:** Beach Channel Drive

**FMS ID#:** SANDHW11

**DRILLING CONTRACTOR:** Zebra Technical Services, LLC

**WOL #:** 11364-LBA-4-10691

**DRILLING METHOD:** Direct Push

**DATE STARTED:** 7/20/2016

### BOREHOLE DATA

### WELL DATA

**DATE FINISHED:** 7/25/2016

**Diameter (in):** 2

**Well Diameter (in):** N/A

**DRILLER:** E. Moraitis

**Total Depth (ft.):** 10

**Total Depth (ft.):** N/A

**LBA INSPECTOR:** J. Ganz

**Depth to Refusal (ft.):** N/A

**Screen Length (ft.):** N/A

**NORTHING (ft):** 151133.84

**Depth to Water (ft.):** 6

**Depth to Water (ft.):** N/A

**EASTING (ft):** 1027036.20

**Depth to Rock (ft.):** N/A

**Slot Size (in):** N/A

**SURFACE ELEVATION (ft):** N/A

**NOTES:** Soil description based on Unified Soil Classification System (USCS), Burmister Classification and Munsell Rock Color Chart.

Soil boring was pre-cleared to 6 ft bg.

Well Construction	Depth (feet)	Lithology	USCS	Sample Interval	Sample Recovery	PID Reading (ppm)	Description and Stratigraphy	Remarks
	8		SP			<1	Pale yellowish brown (10YR 6/2) coarse to fine SAND, trace fine Gravel; wet.	Sand, Collected grab sample SB08 from 5.5 to 6.0 ft bg and composite sample SB08 from 0.6 to 6.0 ft bg
	10						Total Depth of Boring 10 feet.	



Louis Berger

# Drilling Log

Page 1 of 2

**BORING NO.:** SB09

**LOCATION:** Queens, NY

**CLIENT:** New York City Department of Design and Construction

**PROJECT NO.:** 2011040.093

**PROJECT:** Beach Channel Drive

**FMS ID#:** SANDHW11

**DRILLING CONTRACTOR:** Zebra Technical Services, LLC

**WOL #:** 11364-LBA-4-10691

**DRILLING METHOD:** Direct Push

**DATE STARTED:** 7/21/2016

### BOREHOLE DATA

### WELL DATA

**DATE FINISHED:** 7/25/2016

**Diameter (in):** 2

**Well Diameter (in):** N/A

**DRILLER:** E. Moraitis

**Total Depth (ft.):** 10

**Total Depth (ft.):** N/A

**LBA INSPECTOR:** J. Ganz

**Depth to Refusal (ft):** N/A

**Screen Length (ft):** N/A

**NORTHING (ft):** 151161.91

**Depth to Water (ft.):** 6

**Depth to Water (ft.):** N/A

**EASTING (ft):** 1027130.93

**Depth to Rock (ft.):** N/A

**Slot Size (in):** N/A

**SURFACE ELEVATION (ft):** N/A

**NOTES:** Soil description based on Unified Soil Classification System (USCS), Burmister Classification and Munsell Rock Color Chart.  
Soil boring was pre-cleared to 6 ft bg.

Well Construction	Depth (feet)	Lithology	USCS	Sample Interval	Sample Recovery	PID Reading (ppm)	Description and Stratigraphy	Remarks
	0.0 - 0.3	CONCRETE				<1	Light gray (N7) CONCRETE; dry.	Concrete
	0.3 - 5.5	FILL				<1	Dark yellowish brown (10YR 4/2) medium to fine SAND, trace Silt, some coarse to fine Gravel; moist.	Gravelly Sand (Fill)
	5.5 - 6.0	FILL				<1	Pale yellowish brown (10YR 6/2) to dark yellowish brown (10YR 4/2) coarse to fine SAND, and coarse to fine Gravel (50% fill material - concrete); moist.	Sand (Fill), Collected grab sample SB09 from 5.5 to 6.0 ft bg and composite sample SB09 from 0.3 to 6.0 ft bg
	6.0 - 10.0	SP				<1	Moderate yellowish brown (10YR 5/4) to pale yellowish brown (10YR 6/2) coarse to fine SAND, trace fine Gravel; wet.	Sand



# Drilling Log

Page 2 of 2

**BORING NO.:** SB09

**LOCATION:** Queens, NY

**CLIENT:** New York City Department of Design and Construction

**PROJECT NO.:** 2011040.093

**PROJECT:** Beach Channel Drive

**FMS ID#:** SANDHW11

**DRILLING CONTRACTOR:** Zebra Technical Services, LLC

**WOL #:** 11364-LBA-4-10691

**DRILLING METHOD:** Direct Push

**DATE STARTED:** 7/21/2016

**BOREHOLE DATA**

**WELL DATA**

**DATE FINISHED:** 7/25/2016

**Diameter (in):** 2

**Well Diameter (in):** N/A

**DRILLER:** E. Moraitis

**Total Depth (ft.):** 10

**Total Depth (ft.):** N/A

**LBA INSPECTOR:** J. Ganz

**Depth to Refusal (ft.):** N/A

**Screen Length (ft.):** N/A

**NORTHING (ft):** 151161.91

**Depth to Water (ft.):** 6

**Depth to Water (ft.):** N/A

**EASTING (ft):** 1027130.93

**Depth to Rock (ft.):** N/A

**Slot Size (in):** N/A

**SURFACE ELEVATION (ft):** N/A

**NOTES:** Soil description based on Unified Soil Classification System (USCS), Burmister Classification and Munsell Rock Color Chart.

Soil boring was pre-cleared to 6 ft bg.

Well Construction	Depth (feet)	Lithology	USCS	Sample Interval	Sample Recovery	PID Reading (ppm)	Description and Stratigraphy	Remarks
	8		SP			<1	Moderate yellowish brown (10YR 5/4) to pale yellowish brown (10YR 6/2) coarse to fine SAND, trace fine Gravel; wet.	Sand
	10						Total Depth of Boring 10 feet.	



Louis Berger

# Drilling Log

Page 1 of 2

**BORING NO.:** SB10

**LOCATION:** Queens, NY

**CLIENT:** New York City Department of Design and Construction

**PROJECT NO.:** 2011040.093

**PROJECT:** Beach Channel Drive

**FMS ID#:** SANDHW11

**DRILLING CONTRACTOR:** Zebra Technical Services, LLC

**WOL #:** 11364-LBA-4-10691

**DRILLING METHOD:** Direct Push

**DATE STARTED:** 7/20/2016

### BOREHOLE DATA

### WELL DATA

**DATE FINISHED:** 7/25/2016

**Diameter (in):** 2

**Well Diameter (in):** N/A

**DRILLER:** E. Moraitis

**Total Depth (ft.):** 10

**Total Depth (ft.):** N/A

**LBA INSPECTOR:** J. Ganz

**Depth to Refusal (ft):** N/A

**Screen Length (ft):** N/A

**NORTHING (ft):** 151049.29

**Depth to Water (ft.):** 6

**Depth to Water (ft.):** N/A

**EASTING (ft):** 1027126.46

**Depth to Rock (ft.):** N/A

**Slot Size (in):** N/A

**SURFACE ELEVATION (ft):** N/A

**NOTES:** Soil description based on Unified Soil Classification System (USCS), Burmister Classification and Munsell Rock Color Chart.

Soil boring was pre-cleared to 6 ft bg.

Well Construction	Depth (feet)	Lithology	USCS	Sample Interval	Sample Recovery	PID Reading (ppm)	Description and Stratigraphy	Remarks
	0.0	CONCRETE				<1	Light gray (N7) CONCRETE; dry.	Concrete
	0.4	FILL				<1	Dusky yellowish brown (10YR 2/2) medium to fine SAND, trace Silt, little coarse to fine Gravel; moist.	Sand (Fill) Sand, Collected grab sample SB10 from 5.5 to 6.0 ft bg and composite sample SB10 from 0.4 to 6.0 ft bg
	0.4	FILL				<1	Pale yellowish brown (10YR 6/2) coarse to fine SAND; moist.	
	6.0		SP			<1	Pale yellowish brown (10YR 6/2) coarse to fine SAND; wet.	∇



# Drilling Log

Page 2 of 2

**BORING NO.:** SB10

**LOCATION:** Queens, NY

**CLIENT:** New York City Department of Design and Construction

**PROJECT NO.:** 2011040.093

**PROJECT:** Beach Channel Drive

**FMS ID#:** SANDHW11

**DRILLING CONTRACTOR:** Zebra Technical Services, LLC

**WOL #:** 11364-LBA-4-10691

**DRILLING METHOD:** Direct Push

**DATE STARTED:** 7/20/2016

**BOREHOLE DATA**

**WELL DATA**

**DATE FINISHED:** 7/25/2016

**Diameter (in):** 2

**Well Diameter (in):** N/A

**DRILLER:** E. Moraitis

**Total Depth (ft.):** 10

**Total Depth (ft.):** N/A

**LBA INSPECTOR:** J. Ganz

**Depth to Refusal (ft):** N/A

**Screen Length (ft):** N/A

**NORTHING (ft):** 151049.29

**Depth to Water (ft.):** 6

**Depth to Water (ft.):** N/A

**EASTING (ft):** 1027126.46

**Depth to Rock (ft.):** N/A

**Slot Size (in):** N/A

**SURFACE ELEVATION (ft):** N/A

**NOTES:** Soil description based on Unified Soil Classification System (USCS), Burmister Classification and Munsell Rock Color Chart.

Soil boring was pre-cleared to 6 ft bg.

Well Construction	Depth (feet)	Lithology	USCS	Sample Interval	Sample Recovery	PID Reading (ppm)	Description and Stratigraphy	Remarks
	8	SP	SP			<1	Pale yellowish brown (10YR 6/2) coarse to fine SAND; wet.	
		SP-SM	SP-SM			<1	Dark yellowish brown (10YR 4/2) medium to fine SAND, little Silt; wet.	
		SP	SP			<1	Light olive gray (5Y 5/2) coarse SAND; wet.	
	10						Total Depth of Boring 10 feet.	
	12							



Louis Berger

# Drilling Log

Page 1 of 2

**BORING NO.:** SB11

**LOCATION:** Queens, NY

**CLIENT:** New York City Department of Design and Construction

**PROJECT NO.:** 2011040.093

**PROJECT:** Beach Channel Drive

**FMS ID#:** SANDHW11

**DRILLING CONTRACTOR:** Zebra Technical Services, LLC

**WOL #:** 11364-LBA-4-10691

**DRILLING METHOD:** Direct Push

**DATE STARTED:** 7/21/2016

### BOREHOLE DATA

### WELL DATA

**DATE FINISHED:** 7/28/2016

**Diameter (in):** 2

**Well Diameter (in):** N/A

**DRILLER:** E. Moraitis

**Total Depth (ft.):** 13

**Total Depth (ft.):** N/A

**LBA INSPECTOR:** J. Ganz

**Depth to Refusal (ft):** N/A

**Screen Length (ft):** N/A

**NORTHING (ft):** 151130.47

**Depth to Water (ft.):** 5.8

**Depth to Water (ft.):** N/A

**EASTING (ft):** 1027422.64

**Depth to Rock (ft.):** N/A

**Slot Size (in):** N/A

**SURFACE ELEVATION (ft):** N/A

**NOTES:** Soil description based on Unified Soil Classification System (USCS), Burnister Classification and Munsell Rock Color Chart.

Soil boring was pre-cleared to 6 ft bg. Collected groundwater sample TWP03 from temporary well

Well Construction	Depth (feet)	Lithology	USCS	Sample Interval	Sample Recovery	PID Reading (ppm)	Description and Stratigraphy	Remarks
	0		FILL			<1	Dark yellowish brown (10YR 4/2) medium to fine SAND, trace Silt; moist.	Sand (Fill)  Collected grab sample SB11 from 5.3 to 5.8 ft bg and composite sample SB11 from 0 to 5.8 ft bg
	5.8		FILL			<1	Pale yellowish brown (10YR 6/2) coarse to fine SAND, trace fine Gravel; moist.	
	6		SP			<1	Pale yellowish brown (10YR 6/2) coarse to fine SAND, trace fine Gravel; wet.	Sand





# Drilling Log

Page 2 of 2

**BORING NO.:** SB11

**LOCATION:** Queens, NY

**CLIENT:** New York City Department of Design and Construction

**PROJECT NO.:** 2011040.093

**PROJECT:** Beach Channel Drive

**FMS ID#:** SANDHW11

**DRILLING CONTRACTOR:** Zebra Technical Services, LLC

**WOL #:** 11364-LBA-4-10691

**DRILLING METHOD:** Direct Push

**DATE STARTED:** 7/21/2016

**BOREHOLE DATA**

**WELL DATA**

**DATE FINISHED:** 7/28/2016

**Diameter (in):** 2

**Well Diameter (in):** N/A

**DRILLER:** E. Moraitis

**Total Depth (ft.):** 13

**Total Depth (ft.):** N/A

**LBA INSPECTOR:** J. Ganz

**Depth to Refusal (ft.):** N/A

**Screen Length (ft.):** N/A

**NORTHING (ft):** 151130.47

**Depth to Water (ft.):** 5.8

**Depth to Water (ft.):** N/A

**EASTING (ft):** 1027422.64

**Depth to Rock (ft.):** N/A

**Slot Size (in):** N/A

**SURFACE ELEVATION (ft):** N/A

**NOTES:** Soil description based on Unified Soil Classification System (USCS), Burmister Classification and Munsell Rock Color Chart.

Soil boring was pre-cleared to 6 ft bg. Collected groundwater sample TWP03 from temporary well

Well Construction	Depth (feet)	Lithology	USCS	Sample Interval	Sample Recovery	PID Reading (ppm)	Description and Stratigraphy	Remarks
	8		SP			<1	Pale yellowish brown (10YR 6/2) coarse to fine SAND, trace fine Gravel; wet.	Sand
	10		SP			<1	Pale yellowish brown (10YR 6/2) to greenish black (5GY 2/1) coarse to fine SAND, trace fine Gravel; wet.	
	12							
							Total Depth of Boring 13 feet.	



Louis Berger

# Drilling Log

Page 1 of 2

**BORING NO.:** SB12

**LOCATION:** Queens, NY

**CLIENT:** New York City Department of Design and Construction

**PROJECT NO.:** 2011040.093

**PROJECT:** Beach Channel Drive

**FMS ID#:** SANDHW11

**DRILLING CONTRACTOR:** Zebra Technical Services, LLC

**WOL #:** 11364-LBA-4-10691

**DRILLING METHOD:** Direct Push

**DATE STARTED:** 7/21/2016

### BOREHOLE DATA

### WELL DATA

**DATE FINISHED:** 7/26/2016

**Diameter (in):** 2

**Well Diameter (in):** N/A

**DRILLER:** E. Moraitis

**Total Depth (ft.):** 10

**Total Depth (ft.):** N/A

**LBA INSPECTOR:** J. Ganz

**Depth to Refusal (ft):** N/A

**Screen Length (ft):** N/A

**NORTHING (ft):** 151142.03

**Depth to Water (ft.):** 6

**Depth to Water (ft.):** N/A

**EASTING (ft):** 1027612.01

**Depth to Rock (ft.):** N/A

**Slot Size (in):** N/A

**SURFACE ELEVATION (ft):** N/A

**NOTES:** Soil description based on Unified Soil Classification System (USCS), Burmister Classification and Munsell Rock Color Chart.  
Soil boring was pre-cleared to 6 ft bg.

Well Construction	Depth (feet)	Lithology	USCS	Sample Interval	Sample Recovery	PID Reading (ppm)	Description and Stratigraphy	Remarks
	0.0	CONCRETE				<1	Light gray (N7) CONCRETE; dry.	Concrete
	0.5	FILL				<1	Dark yellowish brown (10YR 4/2) medium to fine SAND, trace fine Gravel; moist.	Sand (Fill)
	1.0	FILL				<1	Moderate yellowish brown (10YR 5/4) coarse to fine SAND, trace fine Gravel; moist.	
	1.5	FILL				<1	Pale yellowish brown (10YR 6/2) coarse to fine SAND; moist.	
	2.0	FILL				<1		
	6.0	SP				<1	Pale yellowish brown (10YR 6/2) to light brownish gray (5YR 6/1) coarse to fine SAND, trace fine Gravel; wet.	Sand $\nabla$



# Drilling Log

Page 2 of 2

**BORING NO.:** SB12

**LOCATION:** Queens, NY

**CLIENT:** New York City Department of Design and Construction

**PROJECT NO.:** 2011040.093

**PROJECT:** Beach Channel Drive

**FMS ID#:** SANDHW11

**DRILLING CONTRACTOR:** Zebra Technical Services, LLC

**WOL #:** 11364-LBA-4-10691

**DRILLING METHOD:** Direct Push

**DATE STARTED:** 7/21/2016

**BOREHOLE DATA**

**WELL DATA**

**DATE FINISHED:** 7/26/2016

**Diameter (in):** 2

**Well Diameter (in):** N/A

**DRILLER:** E. Moraitis

**Total Depth (ft.):** 10

**Total Depth (ft.):** N/A

**LBA INSPECTOR:** J. Ganz

**Depth to Refusal (ft.):** N/A

**Screen Length (ft.):** N/A

**NORTHING (ft):** 151142.03

**Depth to Water (ft.):** 6

**Depth to Water (ft.):** N/A

**EASTING (ft):** 1027612.01

**Depth to Rock (ft.):** N/A





**Slot Size (in):** N/A

**SURFACE ELEVATION (ft):** N/A

**NOTES:** Soil description based on Unified Soil Classification System (USCS), Burmister Classification and Munsell Rock Color Chart.

Soil boring was pre-cleared to 6 ft bg.

Well Construction	Depth (feet)	Lithology	USCS	Sample Interval	Sample Recovery	PID Reading (ppm)	Description and Stratigraphy	Remarks
	8		SP			<1	Pale yellowish brown (10YR 6/2) to light brownish gray (5YR 6/1) coarse to fine SAND, trace fine Gravel; wet.	Sand
	10						Total Depth of Boring 10 feet.	
	12							
	14							

 <b>Louis Berger</b>		<h1 style="text-align: center;">Drilling Log</h1> <p style="text-align: center;">Page 1 of 2</p>		<b>BORING NO.: SB13</b>				
				<b>LOCATION: Queens, NY</b>				
<b>CLIENT:</b> New York City Department of Design and Construction			<b>PROJECT NO.:</b> 2011040.093					
<b>PROJECT:</b> Beach Channel Drive			<b>FMS ID#:</b> SANDHW11					
<b>DRILLING CONTRACTOR:</b> Zebra Technical Services, LLC			<b>WOL #:</b> 11364-LBA-4-10691					
<b>DRILLING METHOD:</b> Direct Push			<b>DATE STARTED:</b> 7/22/2016					
<b>BOREHOLE DATA</b>		<b>WELL DATA</b>		<b>DATE FINISHED:</b> 7/26/2016				
<b>Diameter (in):</b>	2	<b>Well Diameter (in):</b>	N/A	<b>DRILLER:</b> E. Moraitis				
<b>Total Depth (ft.):</b>	10	<b>Total Depth (ft.):</b>	N/A	<b>LBA INSPECTOR:</b> J. Ganz				
<b>Depth to Refusal (ft):</b>	N/A	<b>Screen Length (ft):</b>	N/A	<b>NORTHING (ft):</b> 151156.62				
<b>Depth to Water (ft.):</b>	6	<b>Depth to Water (ft.):</b>	N/A	<b>EASTING (ft):</b> 1027993.36				
<b>Depth to Rock (ft.):</b>	N/A	<b>Slot Size (in):</b>	N/A	<b>SURFACE ELEVATION (ft):</b> N/A				
<b>NOTES:</b> Soil description based on Unified Soil Classification System (USCS), Burmister Classification and Munsell Rock Color Chart. Soil boring was pre-cleared to 6 ft bg.								
Well Construction	Depth (feet)	Lithology	USCS	Sample Interval	Sample Recovery	PID Reading (ppm)	Description and Stratigraphy	Remarks
			CONCRETE			<1	Light gray (N7) CONCRETE; dry.	Concrete
			FILL			<1	Dark yellowish brown (10YR 4/2) to dusky yellowish brown (10YR 2/2) coarse to fine SAND, trace Silt, some coarse to fine Gravel; moist.	Gravelly Sand (Fill)
			FILL			<1	Pale yellowish brown (10YR 6/2) to dark yellowish brown (10YR 4/2) coarse to fine SAND; moist.	Sand (Fill), Collected grab sample SB13 from 5.5 to 6.0 ft bg and composite sample SB13 from 0.5 to 6.0 ft bg
	2							
	4							
	6		SP			<1	Pale yellowish brown (10YR 6/2) coarse to medium SAND, trace coarse to fine Gravel; wet.	Sand ▽



# Drilling Log

Page 2 of 2

**BORING NO.:** SB13

**LOCATION:** Queens, NY

**CLIENT:** New York City Department of Design and Construction

**PROJECT NO.:** 2011040.093

**PROJECT:** Beach Channel Drive

**FMS ID#:** SANDHW11

**DRILLING CONTRACTOR:** Zebra Technical Services, LLC

**WOL #:** 11364-LBA-4-10691

**DRILLING METHOD:** Direct Push

**DATE STARTED:** 7/22/2016

**BOREHOLE DATA**

**WELL DATA**

**DATE FINISHED:** 7/26/2016

**Diameter (in):** 2

**Well Diameter (in):** N/A

**DRILLER:** E. Moraitis

**Total Depth (ft.):** 10

**Total Depth (ft.):** N/A

**LBA INSPECTOR:** J. Ganz

**Depth to Refusal (ft.):** N/A

**Screen Length (ft.):** N/A

**NORTHING (ft):** 151156.62

**Depth to Water (ft.):** 6

**Depth to Water (ft.):** N/A

**EASTING (ft):** 1027993.36

**Depth to Rock (ft.):** N/A

**Slot Size (in):** N/A

**SURFACE ELEVATION (ft):** N/A

**NOTES:** Soil description based on Unified Soil Classification System (USCS), Burmister Classification and Munsell Rock Color Chart.

Soil boring was pre-cleared to 6 ft bg.

Well Construction	Depth (feet)	Lithology	USCS	Sample Interval	Sample Recovery	PID Reading (ppm)	Description and Stratigraphy	Remarks
	8		SP			<1	Pale yellowish brown (10YR 6/2) coarse to medium SAND, trace coarse to fine Gravel; wet.	Sand
	10						Total Depth of Boring 10 feet.	
	12							



Louis Berger

# Drilling Log

Page 1 of 2

**BORING NO.:** SB14

**LOCATION:** Queens, NY

**CLIENT:** New York City Department of Design and Construction

**PROJECT NO.:** 2011040.093

**PROJECT:** Beach Channel Drive

**FMS ID#:** SANDHW11

**DRILLING CONTRACTOR:** Zebra Technical Services, LLC

**WOL #:** 11364-LBA-4-10691

**DRILLING METHOD:** Direct Push

**DATE STARTED:** 7/27/2016

### BOREHOLE DATA

### WELL DATA

**DATE FINISHED:** 7/27/2016

**Diameter (in):** 2

**Well Diameter (in):** N/A

**DRILLER:** E. Moraitis

**Total Depth (ft.):** 13

**Total Depth (ft.):** N/A

**LBA INSPECTOR:** J. Ganz

**Depth to Refusal (ft.):** N/A

**Screen Length (ft.):** N/A

**NORTHING (ft):** 151177.45

**Depth to Water (ft.):** 6

**Depth to Water (ft.):** N/A

**EASTING (ft):** 1028204.88

**Depth to Rock (ft.):** N/A

**Slot Size (in):** N/A

**SURFACE ELEVATION (ft):** N/A

**NOTES:** Soil description based on Unified Soil Classification System (USCS), Burmister Classification and Munsell Rock Color Chart.

Soil boring was pre-cleared to 6 ft bg.

Well Construction	Depth (feet)	Lithology	USCS	Sample Interval	Sample Recovery	PID Reading (ppm)	Description and Stratigraphy	Remarks
	0.4		FILL			<1	Dark yellowish brown (10YR 4/2) medium to fine SAND, little Silt, trace fine Gravel; moist.	Sand (Fill)  Collected grab sample SB14 from 5.5 to 6.0 ft bg and composite sample SB14 from 0.4 to 6.0 ft bg
	0.4 to 6.0		FLL			<1	Pale yellowish brown (10YR 6/2) coarse to fine SAND, trace coarse to fine Gravel; moist.	
	6.0		SP			<1	Pale yellowish brown (10YR 6/2) to light brown (5YR 5/6) coarse to fine SAND, trace coarse to fine Gravel; wet.	Sand ▽



# Drilling Log

Page 2 of 2

**BORING NO.:** SB14

**LOCATION:** Queens, NY

**CLIENT:** New York City Department of Design and Construction

**PROJECT NO.:** 2011040.093

**PROJECT:** Beach Channel Drive

**FMS ID#:** SANDHW11

**DRILLING CONTRACTOR:** Zebra Technical Services, LLC

**WOL #:** 11364-LBA-4-10691

**DRILLING METHOD:** Direct Push

**DATE STARTED:** 7/27/2016

**BOREHOLE DATA**

**WELL DATA**

**DATE FINISHED:** 7/27/2016

**Diameter (in):** 2

**Well Diameter (in):** N/A

**DRILLER:** E. Moraitis

**Total Depth (ft.):** 13

**Total Depth (ft.):** N/A

**LBA INSPECTOR:** J. Ganz

**Depth to Refusal (ft.):** N/A

**Screen Length (ft.):** N/A

**NORTHING (ft):** 151177.45

**Depth to Water (ft.):** 6

**Depth to Water (ft.):** N/A

**EASTING (ft):** 1028204.88

**Depth to Rock (ft.):** N/A

**Slot Size (in):** N/A

**SURFACE ELEVATION (ft):** N/A

**NOTES:** Soil description based on Unified Soil Classification System (USCS), Burnmister Classification and Munsell Rock Color Chart.

Soil boring was pre-cleared to 6 ft bg.

Well Construction	Depth (feet)	Lithology	USCS	Sample Interval	Sample Recovery	PID Reading (ppm)	Description and Stratigraphy	Remarks
			SP			<1	Pale yellowish brown (10YR 6/2) to light brown (5YR 5/6) coarse to fine SAND, trace coarse to fine Gravel; wet.	Sand
	8		SP-SM			<1	Light brown (5YR 5/6) coarse to fine SAND, little Silt, trace fine Gravel; wet.	
			SP			<1	Pale yellowish brown (10YR 6/2) coarse to fine SAND, trace fine Gravel; wet.	
	10		SP			<1	Greenish gray (5G 6/1) coarse to fine SAND, trace fine Gravel; wet.	
	12		SP			<1	Greenish gray (5G 6/1) coarse to fine SAND, trace fine Gravel; wet.	
							Total Depth of Boring 13 feet.	



Louis Berger

# Drilling Log

Page 1 of 2

**BORING NO.:** SB15

**LOCATION:** Queens, NY

**CLIENT:** New York City Department of Design and Construction

**PROJECT NO.:** 2011040.093

**PROJECT:** Beach Channel Drive

**FMS ID#:** SANDHW11

**DRILLING CONTRACTOR:** Zebra Technical Services, LLC

**WOL #:** 11364-LBA-4-10691

**DRILLING METHOD:** Direct Push

**DATE STARTED:** 7/27/2016

### BOREHOLE DATA

### WELL DATA

**DATE FINISHED:** 7/27/2016

**Diameter (in):** 2

**Well Diameter (in):** N/A

**DRILLER:** E. Moraitis

**Total Depth (ft.):** 10

**Total Depth (ft.):** N/A

**LBA INSPECTOR:** J. Ganz

**Depth to Refusal (ft):** N/A

**Screen Length (ft):** N/A

**NORTHING (ft):** 151194.13

**Depth to Water (ft.):** 6

**Depth to Water (ft.):** N/A

**EASTING (ft):** 1028462.24

**Depth to Rock (ft.):** N/A

**Slot Size (in):** N/A

**SURFACE ELEVATION (ft):** N/A

**NOTES:** Soil description based on Unified Soil Classification System (USCS), Burmister Classification and Munsell Rock Color Chart.  
Soil boring was pre-cleared to 6 ft bg.

Well Construction	Depth (feet)	Lithology	USCS	Sample Interval	Sample Recovery	PID Reading (ppm)	Description and Stratigraphy	Remarks
	0 - 0.5	CONCRETE				<1	Light gray (N7) CONCRETE; dry.	Concrete
	0.5 - 6.0	FILL				<1	Pale yellowish brown (10YR 6/2) coarse to fine SAND, trace coarse to fine Gravel; moist.	Sand (Fill), Collected grab sample SB15 from 5.5 to 6.0 ft bg and composite sample SB15 from 0.5 to 6.0 ft bg
	6.0 - 10.0	SP				<1	Pale yellowish brown (10YR 6/2) coarse to fine SAND, trace coarse to fine Gravel; wet.	Sand ▽





# Drilling Log

Page 2 of 2

**BORING NO.:** SB15

**LOCATION:** Queens, NY

**CLIENT:** New York City Department of Design and Construction

**PROJECT NO.:** 2011040.093

**PROJECT:** Beach Channel Drive

**FMS ID#:** SANDHW11

**DRILLING CONTRACTOR:** Zebra Technical Services, LLC

**WOL #:** 11364-LBA-4-10691

**DRILLING METHOD:** Direct Push

**DATE STARTED:** 7/27/2016

**BOREHOLE DATA**

**WELL DATA**

**DATE FINISHED:** 7/27/2016

**Diameter (in):** 2

**Well Diameter (in):** N/A

**DRILLER:** E. Moraitis

**Total Depth (ft.):** 10

**Total Depth (ft.):** N/A

**LBA INSPECTOR:** J. Ganz

**Depth to Refusal (ft):** N/A

**Screen Length (ft):** N/A

**NORTHING (ft):** 151194.13

**Depth to Water (ft.):** 6

**Depth to Water (ft.):** N/A

**EASTING (ft):** 1028462.24

**Depth to Rock (ft.):** N/A

**Slot Size (in):** N/A

**SURFACE ELEVATION (ft):** N/A

**NOTES:** Soil description based on Unified Soil Classification System (USCS), Burnister Classification and Munsell Rock Color Chart.

Soil boring was pre-cleared to 6 ft bg.

Well Construction	Depth (feet)	Lithology	USCS	Sample Interval	Sample Recovery	PID Reading (ppm)	Description and Stratigraphy	Remarks
	8		SP			<1	Pale yellowish brown (10YR 6/2) coarse to fine SAND, trace coarse to fine Gravel; wet.	Sand
			SP-SM			<1	Light brown (5YR 5/6) coarse to fine SAND, little Silt, trace coarse to fine Gravel; wet.	
	10						Total Depth of Boring 10 feet.	



Louis Berger

# Drilling Log

Page 1 of 2

**BORING NO.:** SB16

**LOCATION:** Queens, NY

**CLIENT:** New York City Department of Design and Construction

**PROJECT NO.:** 2011040.093

**PROJECT:** Beach Channel Drive

**FMS ID#:** SANDHW11

**DRILLING CONTRACTOR:** Zebra Technical Services, LLC

**WOL #:** 11364-LBA-4-10691

**DRILLING METHOD:** Direct Push

**DATE STARTED:** 7/27/2016

### BOREHOLE DATA

### WELL DATA

**DATE FINISHED:** 7/27/2016

**Diameter (in):** 2

**Well Diameter (in):** N/A

**DRILLER:** E. Moraitis

**Total Depth (ft.):** 13

**Total Depth (ft.):** N/A

**LBA INSPECTOR:** J. Ganz

**Depth to Refusal (ft):** N/A

**Screen Length (ft):** N/A

**NORTHING (ft):** 151209.75

**Depth to Water (ft.):** 6

**Depth to Water (ft.):** N/A

**EASTING (ft):** 1028719.60

**Depth to Rock (ft.):** N/A

**Slot Size (in):** N/A

**SURFACE ELEVATION (ft):** N/A

**NOTES:** Soil description based on Unified Soil Classification System (USCS), Burmister Classification and Munsell Rock Color Chart.

Soil boring was pre-cleared to 6 ft bg.

Well Construction	Depth (feet)	Lithology	USCS	Sample Interval	Sample Recovery	PID Reading (ppm)	Description and Stratigraphy	Remarks
			CONCRETE			<1	Light gray (N7) CONCRETE; dry.	Concrete
			FILL			1.2	Dark yellowish brown (10YR 4/2) medium to fine SAND, trace Silt, little coarse to fine Gravel; moist.	Sand (Fill), petroleum odor, Collected grab sample SB16 from 0.7 to 1.2 ft bg Concrete Sand (Fill)
			CONCRETE			<1	Light gray (N7) CONCRETE; dry.	
	2		FILL			<1	Dark yellowish brown (10YR 4/2) medium to fine SAND, trace Silt, trace coarse to fine Gravel; moist.	
			FILL			<1	Pale yellowish brown (10YR 6/2) coarse to fine SAND, trace coarse to fine Gravel; moist.	
	6		SP			<1	Pale yellowish brown (10YR 6/2) coarse to fine SAND, trace coarse to fine Gravel; moist.	Sand $\nabla$



# Drilling Log

Page 2 of 2

**BORING NO.:** SB16

**LOCATION:** Queens, NY

**CLIENT:** New York City Department of Design and Construction

**PROJECT NO.:** 2011040.093

**PROJECT:** Beach Channel Drive

**FMS ID#:** SANDHW11

**DRILLING CONTRACTOR:** Zebra Technical Services, LLC

**WOL #:** 11364-LBA-4-10691

**DRILLING METHOD:** Direct Push

**DATE STARTED:** 7/27/2016

**BOREHOLE DATA**

**WELL DATA**

**DATE FINISHED:** 7/27/2016

**Diameter (in):** 2

**Well Diameter (in):** N/A

**DRILLER:** E. Moraitis

**Total Depth (ft.):** 13

**Total Depth (ft.):** N/A

**LBA INSPECTOR:** J. Ganz

**Depth to Refusal (ft.):** N/A

**Screen Length (ft.):** N/A

**NORTHING (ft):** 151209.75

**Depth to Water (ft.):** 6

**Depth to Water (ft.):** N/A

**EASTING (ft):** 1028719.60

**Depth to Rock (ft.):** N/A

**Slot Size (in):** N/A

**SURFACE ELEVATION (ft):** N/A

**NOTES:** Soil description based on Unified Soil Classification System (USCS), Burmister Classification and Munsell Rock Color Chart.

Soil boring was pre-cleared to 6 ft bg.

Well Construction	Depth (feet)	Lithology	USCS	Sample Interval	Sample Recovery	PID Reading (ppm)	Description and Stratigraphy	Remarks
	8		SP			<1	Pale yellowish brown (10YR 6/2) coarse to fine SAND, trace coarse to fine Gravel; moist.	Sand
	10		SP			<1	Pale yellowish brown (10YR 6/2) coarse to fine SAND; moist.	
	12							
							Total Depth of Boring 13 feet.	



Louis Berger

# Drilling Log

Page 1 of 2

**BORING NO.:** SB17

**LOCATION:** Queens, NY

**CLIENT:** New York City Department of Design and Construction

**PROJECT NO.:** 2011040.093

**PROJECT:** Beach Channel Drive

**FMS ID#:** SANDHW11

**DRILLING CONTRACTOR:** Zebra Technical Services, LLC

**WOL #:** 11364-LBA-4-10691

**DRILLING METHOD:** Direct Push

**DATE STARTED:** 7/20/2016

### BOREHOLE DATA

### WELL DATA

**DATE FINISHED:** 7/28/2016

**Diameter (in):** 2

**Well Diameter (in):** N/A

**DRILLER:** E. Moraitis

**Total Depth (ft.):** 13

**Total Depth (ft.):** N/A

**LBA INSPECTOR:** J. Ganz

**Depth to Refusal (ft):** N/A

**Screen Length (ft):** N/A

**NORTHING (ft):** 151234.76

**Depth to Water (ft.):** 6

**Depth to Water (ft.):** N/A

**EASTING (ft):** 1029123.88

**Depth to Rock (ft.):** N/A

**Slot Size (in):** N/A

**SURFACE ELEVATION (ft):** N/A

**NOTES:** Soil description based on Unified Soil Classification System (USCS), Bunnister Classification and Munsell Rock Color Chart.

Soil boring was pre-cleared to 6 ft bg. Collected groundwater sample TWP04 from temporary well

Well Construction	Depth (feet)	Lithology	USCS	Sample Interval	Sample Recovery	PID Reading (ppm)	Description and Stratigraphy	Remarks
	0 - 2		FILL			<1	Dark yellowish brown (10YR 4/2) medium to fine SAND, little Silt, trace coarse to fine Gravel; dry.	Sand (Fill)
	2 - 4		FILL			<1	Pale yellowish brown (10YR 6/2) coarse to fine SAND; moist.	Collected grab sample SB17 from 5.5 to 6.0 ft bg and composite sample SB17 from 0 to 6.0 ft bgs
	4 - 6		SP			<1	Dark yellowish brown (10YR 4/2) to grayish red (10R 4/2) coarse to fine SAND, trace Silt, trace coarse to fine Gravel; wet.	Sand $\nabla$
	6 - 13		SP			<1	Pale yellowish brown (10YR 6/2) to light bluish gray (5B 7/1) coarse to fine SAND, trace fine Gravel; wet.	



# Drilling Log

Page 2 of 2

**BORING NO.:** SB17

**LOCATION:** Queens, NY

**CLIENT:** New York City Department of Design and Construction

**PROJECT NO.:** 2011040.093

**PROJECT:** Beach Channel Drive

**FMS ID#:** SANDHW11

**DRILLING CONTRACTOR:** Zebra Technical Services, LLC

**WOL #:** 11364-LBA-4-10691

**DRILLING METHOD:** Direct Push

**DATE STARTED:** 7/20/2016

**BOREHOLE DATA**

**WELL DATA**

**DATE FINISHED:** 7/28/2016

**Diameter (in):** 2

**Well Diameter (in):** N/A

**DRILLER:** E. Moraitis

**Total Depth (ft.):** 13

**Total Depth (ft.):** N/A

**LBA INSPECTOR:** J. Ganz

**Depth to Refusal (ft.):** N/A

**Screen Length (ft.):** N/A

**NORTHING (ft):** 151234.76

**Depth to Water (ft.):** 6

**Depth to Water (ft.):** N/A

**EASTING (ft):** 1029123.88

**Depth to Rock (ft.):** N/A

**Slot Size (in):** N/A

**SURFACE ELEVATION (ft):** N/A

**NOTES:** Soil description based on Unified Soil Classification System (USCS), Burmister Classification and Munsell Rock Color Chart.

Soil boring was pre-cleared to 6 ft bg. Collected groundwater sample TWP04 from temporary well

Well Construction	Depth (feet)	Lithology	USCS	Sample Interval	Sample Recovery	PID Reading (ppm)	Description and Stratigraphy	Remarks
	8		SP			<1	Pale yellowish brown (10YR 6/2) to light bluish gray (5B 7/1) coarse to fine SAND, trace fine Gravel; wet.	
	10		SP			<1	Pale yellowish brown (10YR 6/2) to light bluish gray (5B 7/1) coarse to fine SAND, trace fine Gravel; wet.	
	12							
							Total Depth of Boring 13 feet.	



Louis Berger

# Drilling Log

Page 1 of 2

**BORING NO.:** SB18

**LOCATION:** Queens, NY

**CLIENT:** New York City Department of Design and Construction

**PROJECT NO.:** 2011040.093

**PROJECT:** Beach Channel Drive

**FMS ID#:** SANDHW11

**DRILLING CONTRACTOR:** Zebra Technical Services, LLC

**WOL #:** 11364-LBA-4-10691

**DRILLING METHOD:** Direct Push

**DATE STARTED:** 7/20/2016

### BOREHOLE DATA

### WELL DATA

**DATE FINISHED:** 7/25/2016

**Diameter (in):** 2

**Well Diameter (in):** N/A

**DRILLER:** E. Moraitis

**Total Depth (ft.):** 10

**Total Depth (ft.):** N/A

**LBA INSPECTOR:** J. Ganz

**Depth to Refusal (ft):** N/A

**Screen Length (ft):** N/A

**NORTHING (ft):** 151238.93

**Depth to Water (ft.):** 6.5

**Depth to Water (ft.):** N/A

**EASTING (ft):** 1029314.55

**Depth to Rock (ft.):** N/A

**Slot Size (in):** N/A

**SURFACE ELEVATION (ft):** N/A

**NOTES:** Soil description based on Unified Soil Classification System (USCS), Burmister Classification and Munsell Rock Color Chart.

Soil boring was pre-cleared to 6 ft bg.

Well Construction	Depth (feet)	Lithology	USCS	Sample Interval	Sample Recovery	PID Reading (ppm)	Description and Stratigraphy	Remarks
	0		FILL			<1	Dark yellowish brown (10YR 4/2) medium to fine SAND, trace Silt, trace coarse to fine Gravel (3% fill material: wire, asphalt); dry.	Sand (Fill)
	2							
	4							
	5		FILL			<1	Pale yellowish brown (10YR 6/2) coarse to fine SAND; moist.	
	6		SP			671	Greenish black (5GY 2/1) coarse to fine SAND, trace Silt; wet.	∇



# Drilling Log

Page 2 of 2

**BORING NO.:** SB18

**LOCATION:** Queens, NY

**CLIENT:** New York City Department of Design and Construction

**PROJECT NO.:** 2011040.093

**PROJECT:** Beach Channel Drive

**FMS ID#:** SANDHW11

**DRILLING CONTRACTOR:** Zebra Technical Services, LLC

**WOL #:** 11364-LBA-4-10691

**DRILLING METHOD:** Direct Push

**DATE STARTED:** 7/20/2016

**BOREHOLE DATA**

**WELL DATA**

**DATE FINISHED:** 7/25/2016

**Diameter (in):** 2

**Well Diameter (in):** N/A

**DRILLER:** E. Moraitis

**Total Depth (ft.):** 10

**Total Depth (ft.):** N/A

**LBA INSPECTOR:** J. Ganz

**Depth to Refusal (ft.):** N/A

**Screen Length (ft.):** N/A

**NORTHING (ft):** 151238.93

**Depth to Water (ft.):** 6.5

**Depth to Water (ft.):** N/A

**EASTING (ft):** 1029314.55

**Depth to Rock (ft.):** N/A

**Slot Size (in):** N/A

**SURFACE ELEVATION (ft):** N/A

**NOTES:** Soil description based on Unified Soil Classification System (USCS), Burmister Classification and Munsell Rock Color Chart.

Soil boring was pre-cleared to 6 ft bg.

Well Construction	Depth (feet)	Lithology	USCS	Sample Interval	Sample Recovery	PID Reading (ppm)	Description and Stratigraphy	Remarks
	8		SP			671	Greenish black (5GY 2/1) coarse to fine SAND, trace Silt; wet.	Sand, Petroleum odor and visibly stained soil from 6.5 to 10 ft bg, Collected grab sample SB18 from 6.0 to 6.5 ft bg and composite sample SB18 from 0 to 6.5 ft bg
			SP			308	Olive gray (5Y 4/1) to medium bluish gray (5B 5/1) coarse to fine SAND; wet.	
	10						Total Depth of Boring 10 feet.	



Louis Berger

# Drilling Log

Page 1 of 1

**BORING NO.:** SB19

**LOCATION:** Queens, NY

**CLIENT:** New York City Department of Design and Construction

**PROJECT NO.:** 2011040.093

**PROJECT:** Beach Channel Drive

**FMS ID#:** SANDHW11

**DRILLING CONTRACTOR:** Zebra Technical Services, LLC

**WOL #:** 11364-LBA-4-10691

**DRILLING METHOD:** Vactron and Airknife

**DATE STARTED:** 7/20/2016

### BOREHOLE DATA

### WELL DATA

**DATE FINISHED:** 7/20/2016

**Diameter (in):** 6

**Well Diameter (in):** N/A

**DRILLER:** E. Moraitis

**Total Depth (ft.):** 6

**Total Depth (ft.):** N/A

**LBA INSPECTOR:** J. Ganz

**Depth to Refusal (ft.):** N/A

**Screen Length (ft.):** N/A

**NORTHING (ft):** 151342.08

**Depth to Water (ft.):** N/A

**Depth to Water (ft.):** N/A

**EASTING (ft):** 1029507.31

**Depth to Rock (ft.):** N/A

**Slot Size (in):** N/A

**SURFACE ELEVATION (ft):** N/A

**NOTES:** Soil description based on Unified Soil Classification System (USCS), Burnmister Classification and Munsell Rock Color Chart.

Soil boring was pre-cleared to 6 ft bg.

Well Construction	Depth (feet)	Lithology	USCS	Sample Interval	Sample Recovery	PID Reading (ppm)	Description and Stratigraphy	Remarks
	0.0	CONCRETE				<1	Light gray (N7) CONCRETE; dry.	Concrete
	0.4	GP				<1	Dark gray (N3) coarse to fine GRAVEL, trace Silt, some medium to fine Sand; moist.	Gravel (subbase)
	0.4	FILL				<1	Moderate yellowish brown (10YR 5/4) coarse to fine SAND, trace fine Gravel; moist.	Sand (Fill), Collected grab sample SB19 from 5.5 to 6.0 ft bg and composite sample SB19 from 0.4 to 6.0 ft bg
	6.0						Total Depth of Boring 6 feet.	





# Drilling Log

Page 1 of 1

**BORING NO.:** SB20

**LOCATION:** Queens, NY

**CLIENT:** New York City Department of Design and Construction

**PROJECT NO.:** 2011040.093

**PROJECT:** Beach Channel Drive

**FMS ID#:** SANDHW11

**DRILLING CONTRACTOR:** Zebra Technical Services, LLC

**WOL #:** 11364-LBA-4-10691

**DRILLING METHOD:** Vactron and Airknife

**DATE STARTED:** 7/19/2016

**BOREHOLE DATA**

**WELL DATA**

**DATE FINISHED:** 7/19/2016

**Diameter (in):** 6

**Well Diameter (in):** N/A

**DRILLER:** E. Moraitis

**Total Depth (ft.):** 6

**Total Depth (ft.):** N/A

**LBA INSPECTOR:** J. Ganz

**Depth to Refusal (ft.):** N/A

**Screen Length (ft.):** N/A

**NORTHING (ft):** 151690.09

**Depth to Water (ft.):** N/A

**Depth to Water (ft.):** N/A

**EASTING (ft):** 1030357.54

**Depth to Rock (ft.):** N/A

**Slot Size (in):** N/A

**SURFACE ELEVATION (ft):** N/A

**NOTES:** Soil description based on Unified Soil Classification System (USCS), Burmister Classification and Munsell Rock Color Chart.

Soil boring was pre-cleared to 6 ft bg.

Well Construction	Depth (feet)	Lithology	USCS	Sample Interval	Sample Recovery	PID Reading (ppm)	Description and Stratigraphy	Remarks
	0		FILL			<1	Dark yellowish brown (10YR 4/2) medium to fine SAND, little Silt, trace coarse Gravel; moist.	Sand (Fill)
	0		FILL			<1	Pale yellowish brown (10YR 6/2) coarse to fine SAND, trace fine Gravel; moist.	
	2							
	4		FILL			<1	Dark yellowish orange (10YR 6/6) coarse to medium SAND, trace fine Gravel; moist.	Collected grab sample SB20 from 5.5 to 6.0 ft bg and composite sample SB20 from 0 to 6.0 ft bg
	4		FILL			<1	Pale yellowish brown (10YR 6/2) coarse to fine SAND, trace fine Gravel; moist.	
							Total Depth of Boring 6 feet.	



Louis Berger

# Drilling Log

Page 1 of 1

**BORING NO.:** SB21

**LOCATION:** Queens, NY

**CLIENT:** New York City Department of Design and Construction

**PROJECT NO.:** 2011040.093

**PROJECT:** Beach Channel Drive

**FMS ID#:** SANDHW11

**DRILLING CONTRACTOR:** Zebra Technical Services, LLC

**WOL #:** 11364-LBA-4-10691

**DRILLING METHOD:** Vactron and Airknife

**DATE STARTED:** 7/19/2016

### BOREHOLE DATA

### WELL DATA

**DATE FINISHED:** 7/19/2016

**Diameter (in):** 6

**Well Diameter (in):** N/A

**DRILLER:** E. Moraitis

**Total Depth (ft.):** 6

**Total Depth (ft.):** N/A

**LBA INSPECTOR:** J. Ganz

**Depth to Refusal (ft.):** N/A

**Screen Length (ft.):** N/A

**NORTHING (ft):** 151983.92

**Depth to Water (ft.):** N/A

**Depth to Water (ft.):** N/A

**EASTING (ft):** 1031161.93

**Depth to Rock (ft.):** N/A

**Slot Size (in):** N/A

**SURFACE ELEVATION (ft):** N/A

**NOTES:** Soil description based on Unified Soil Classification System (USCS), Burmister Classification and Munsell Rock Color Chart.

Soil boring was pre-cleared to 6 ft bg.

Well Construction	Depth (feet)	Lithology	USCS	Sample Interval	Sample Recovery	PID Reading (ppm)	Description and Stratigraphy	Remarks
	0		FILL			<1	Moderate yellowish brown (10YR 5/4) medium to fine SAND, trace Silt, little coarse to fine Gravel; dry.	Sand (Fill)  Collected grab sample SB21 from 5.5 to 6.0 ft bg and composite sample SB21 from 0 to 6.0 ft bg
	0.5		FILL			<1	Pale yellowish brown (10YR 6/2) coarse to fine SAND, trace fine Gravel; moist.	
	6						Total Depth of Boring 6 feet.	



# Drilling Log

Page 1 of 1

**BORING NO.:** SB22

**LOCATION:** Queens, NY

**CLIENT:** New York City Department of Design and Construction

**PROJECT NO.:** 2011040.093

**PROJECT:** Beach Channel Drive

**FMS ID#:** SANDHW11

**DRILLING CONTRACTOR:** Zebra Technical Services, LLC

**WOL #:** 11364-LBA-4-10691

**DRILLING METHOD:** Vactron and Airknife

**DATE STARTED:** 7/20/2016

**BOREHOLE DATA**

**WELL DATA**

**DATE FINISHED:** 7/20/2016

**Diameter (in):** 6

**Well Diameter (in):** N/A

**DRILLER:** E. Moraitis

**Total Depth (ft.):** 6

**Total Depth (ft.):** N/A

**LBA INSPECTOR:** J. Ganz

**Depth to Refusal (ft.):** N/A

**Screen Length (ft.):** N/A

**NORTHING (ft):** 150778.39

**Depth to Water (ft.):** N/A

**Depth to Water (ft.):** N/A

**EASTING (ft):** 1029372.90

**Depth to Rock (ft.):** N/A

**Slot Size (in):** N/A

**SURFACE ELEVATION (ft):** N/A

**NOTES:** Soil description based on Unified Soil Classification System (USCS), Burnmister Classification and Munsell Rock Color Chart.

Soil boring was pre-cleared to 6 ft bg.

Well Construction	Depth (feet)	Lithology	USCS	Sample Interval	Sample Recovery	PID Reading (ppm)	Description and Stratigraphy	Remarks
	0		FILL			<1	Dark yellowish brown (10YR 4/2) medium to fine SAND, some coarse to fine Gravel; dry.	Gravelly Sand (Fill)  Sand (Fill), Collected grab sample SB22 from 5.5 to 6.0 ft bg and composite sample SB22 from 0 to 6.0 ft bg
	2		FILL			<1	Pale yellowish brown (10YR 6/2) coarse to fine SAND; dry.	
	4		FILL			<1	Pale yellowish brown (10YR 6/2) to dark yellowish orange (10YR 6/6) coarse to fine SAND, trace Silt, trace fine Gravel; moist.	
	6						Total Depth of Boring 6 feet.	



Louis Berger

# Drilling Log

Page 1 of 1

**BORING NO.:** SB23

**LOCATION:** Queens, NY

**CLIENT:** New York City Department of Design and Construction

**PROJECT NO.:** 2011040.093

**PROJECT:** Beach Channel Drive

**FMS ID#:** SANDHW11

**DRILLING CONTRACTOR:** Zebra Technical Services, LLC

**WOL #:** 11364-LBA-4-10691

**DRILLING METHOD:** Vactron and Airknife

**DATE STARTED:** 7/20/2016

### BOREHOLE DATA

### WELL DATA

**DATE FINISHED:** 7/20/2016

**Diameter (in):** 6

**Well Diameter (in):** N/A

**DRILLER:** E. Moraitis

**Total Depth (ft.):** 6

**Total Depth (ft.):** N/A

**LBA INSPECTOR:** J. Ganz

**Depth to Refusal (ft.):** N/A

**Screen Length (ft.):** N/A

**NORTHING (ft):** 150621.88

**Depth to Water (ft.):** 4.9

**Depth to Water (ft.):** N/A

**EASTING (ft):** 1029711.76

**Depth to Rock (ft.):** N/A

**Slot Size (in):** N/A

**SURFACE ELEVATION (ft):** N/A

**NOTES:** Soil description based on Unified Soil Classification System (USCS), Burmister Classification and Munsell Rock Color Chart.  
Soil boring was pre-cleared to 6 ft bg.

Well Construction	Depth (feet)	Lithology	USCS	Sample Interval	Sample Recovery	PID Reading (ppm)	Description and Stratigraphy	Remarks
	0		FILL			<1	Pale yellowish brown (10YR 6/2) coarse to fine SAND, trace fine Gravel; dry.	Sand (Fill)
	2							
	4		FILL			<1	Pale yellowish brown (10YR 6/2) to dark yellowish orange (10YR 6/6) coarse to fine SAND, trace Silt, trace fine Gravel; moist.	Collected grab sample SB23 from 4.4 to 4.9 ft bg, ▽ composite sample SB23 from 0 to 4.9 ft bg
			FILL			<1	Pale yellowish brown (10YR 6/2) coarse to fine SAND; wet.	
							Total Depth of Boring 6 feet.	

(NO TEXT ON THIS PAGE)

**UI - PAGES**

**UTILITY INTERFERENCES SECTION**

---

**NOTICE**

THE PAGES CONTAINED IN THIS SECTION (UI - PAGES) REPRESENT ADDITIONAL CONTRACT REQUIREMENTS APPLYING TO WORK PERFORMED IN THE PRESENCE OF PRIVATELY OWNED UTILITY FACILITIES.

(NO TEXT ON THIS PAGE)

## UTILITY INTERFERENCES (UI) SECTION

DATED: December 1, 2016

1. The Contractor shall be responsible for compliance with all the provisions of the following Sections and Schedules, which are hereby made a part of the original contract documents:
  - A. "UI SECTION: Additional Contract Requirements Applying to Work Performed in the Presence of Privately Owned Utility Facilities" (Pages UI-3 through UI-11).
  - B. Schedule U-1 (Page UI-13).
  - C. Schedule U-2 National Grid (Pages UI-14 through UI-16).  
Long Island Power Authority (Pages UI-17 through UI-21).  
Verizon (Pages UI-22 through UI-29)  
Time Warner Cable (Pages UI-30 through UI-31).
  - D. Schedule U-3 Page UI-32 (as per the Private Utilities reference document for UI SECTION called "CET SPECIFICATIONS AND SKETCHES", dated November 2010), and Sketches (Page UI-33) - PSEG (Pages UI-34 through UI-36), Time Warner Cable (Pages UI-37 through UI-39), and Test Pits (Pages UI-40 through UI-42) in this Section UI-Pages.
2. Each facility operator shall provide inspectors at the work site to inspect methods of interference work, verify quantities and items of Utility Work, and coordinate all phases of the facility operator operations.
3. In addition, the following statements are made to provide clarification of various Paragraphs under UI Section:
  - A. UI Section, Paragraph 4, requires the Contractor to immediately commence negotiations with each Company for an Interference Agreement under which the Company will compensate the Contractor for any Interference Work which the Company does not elect to perform with its own forces or by specialty contractors retained by the Company. Thus the Contractor is on notice that its work under the Contract may be affected by Interference Work performed by (a) the Contractor pursuant to a separate Interference Agreement with the Company, (b) the Company, or (c) partly by each.
  - B. UI Section, Paragraph 2, informs the Contractor that the duration of the Contract as shown in Schedule A includes the time which may be necessary for the Contractor to perform the necessary Interference Work.



- C. The Contractor is hereby informed that the duration of the Contract as shown in Schedule A includes the time which may be necessary for the Company to perform whatever portion of the Interference Work which the Company elects to perform with its own forces or by specialty contractors retained by the Company.
- D. UI Section informs the Contractor that the City has entered into an Interference Agreement with the Companies regarding interferences to the City work in this Contract created by the facilities owned and/or operated by such Companies. Pursuant to this Section, a sample of the Utility Agreement letter as executed by the Companies is annexed on page UI-12, as an Exhibit to the Contract. Signed copies of those Utility Agreement letters are on file with New York City Department of Design and Construction (DDC).
- E. The City has no contract with any of the Companies for work on or adjacent to the site of work under this Contract, and the Companies are not "Other Contractors" as defined for the purposes of this Contract. The Contractor is reminded, however, that pursuant to UI Section, Paragraph 4, the City will not compensate the Contractor for any direct and/or indirect costs related to Interference Work, regardless of whether such Interference Work is covered by an Interference Agreement between the Contractor and the Company or is performed by the Company using its own forces or by specialty contractors retained by the Company.
- F. UI Section, Paragraph 14, provides that the provisions of UI Section are material provisions of the Contract and that the Contractor's failure to comply with the procedures set forth in UI Section are sufficient for the Commissioner to declare the Contractor in default pursuant to Article 48 of the Contract.

Pursuant to this Section, the Contractor is informed that the Performance Bond required of the Contractor pursuant to the Contract is not deemed to guarantee performance of any of the Interference Work.

**Utility Interferences Section - Additional Contract Requirements Applicable to Work Performed in the Presence of Privately Owned Utility Facilities**

The Contractor is hereby notified that pursuant to the law and franchise agreements issued by the City, certain private utility and public service companies named in Schedule U-1 ("the Companies") own and/or operate surface and/or subsurface facilities within the limits of this contract. The existence of these facilities impacts the productivity of the City work called for in the contract. In order to improve coordination of the City construction with the private utility facilities owned and/or operated by the Companies named in Schedule U-1, Article 1.06.30 of the Standard Highway Specifications of the New York City Department of Transportation, Dated August 1, 2015; and/or Articles 10.15 through 10.18 of the Standard Sewer and Water Main Specifications of the New York City Department of Environmental Protection, Dated July 1, 2014; as applicable, are amended and will be implemented as follows:

**1. Pre-engineering:**

The anticipated scopes of private utility facilities interferences and anticipated work items and specifications are included in this contract. The locations of these interferences are indicated on the plans and/or listed in the specifications for this contract, and a schedule of estimated quantities by type of interference expected to be encountered within the limits of this project area have been listed on Schedule U-2. In addition, in Schedule U-3 the Companies have provided standard details and methods for supporting, protecting, relocating, and/or working around their facilities when they are in interference with City contract work.

**2. Means and methods for City work:**

a) The Contractor is hereby notified that the utility interferences identified on the plans and/or listed in the Specifications to be known conditions which may impact the performance of, and/or interferes with, City work. The Contractor will be required to perform such utility work as directed by the Resident Engineer in order to clear all utility interferences from the project site as required for satisfactory completion of City work within specified contract schedule.

b) In areas serviced by overhead lines on poles carrying electric, telecommunication and cable system, the Contractor understands and by bidding for this contract agrees that he/she has reviewed the schedule of estimated quantities by type of interference expected to be encountered within the limits of this project and that he/she will be required to perform the public work in the presence of these overhead lines and appurtenances located in areas adjacent and/or within the project area. As a consequence he/she will select means and method of construction appropriate to maintain the safety clearances required or as permitted by contract specifications (e.g. "CET 350 – Overhead Accommodation Protection of Overhead Facilities, Poles, and Appurtenances") in order to avoid damaging the insulation or shielding of these lines and also to prevent knocking

them down. The duration of the contract as shown in Schedule A thus includes the time which may be necessary for the Contractor to remove, repair, protect, support, shift, temporarily remove and replace, work around and/or work in the presence of the Companies' facilities ("Interference Work") as described on the plans and/or specifications of the contract during the progress of the City work.

**3. *Field inspection prior to construction:***

Prior to the start of any contract work in areas serviced by overhead electric lines, and after the award to the apparent low bidder for this contract, the Contractor must request a field walk of the project area along with the operator of the overhead electrical facilities and the DDC Engineer-In-Charge. At that time the facility operator, pursuant to contract specification (e.g. "CET 350 – Overhead Accommodation Protection of Overhead Facilities, Poles, and Appurtenances") will confirm the type and condition of the overhead electrical lines and the sufficiency of their insulating properties with respect to the means and methods proposed by the Contractor. The Contractor must be prepared to describe in enough details his/her proposed means and methods of construction operations in order to anticipate the likelihood that electric lines insulation would be cut or otherwise compromised. Also such details will allow the facility operator to anticipate the need for added insulation and/or shielding of non-insulated lines.

**4. *Compensation for interference work:***

Compensation for Interference Work is a matter of adjustment between the Contractor and each private utility company located within the limits of the project area and whose utility facilities are affected by City contract work. In particular, the City will not compensate the Contractor for any direct and/or indirect costs related to Interference Work, including, but not limited to, delay, lost profit, increased overhead, or any other impact costs which are deemed to be included in cost agreement between the Contractor and private utility company affected by such work. Upon receipt of a Notice of Award from the City, the Contractor shall immediately commence negotiations with each of the Companies concerning the manner in which and the price for which the Contractor, through its own forces or by others hired by it, will perform and be paid by the Company for all necessary Interference Work as defined above that the Company(ies) choose(s) not to perform with its(their) own forces or by specialty Contractors hired by it (them) (as per "Interference Agreement"). Specialty contractors' work is limited to (i) insulation installation and removal, (ii) live gas and steam work, (iii) cleanup and disposal of hazardous materials, (iv) splicing live electrical and telecommunications facilities, and (v) work not within the competence of general construction contractors.

**5. *Interference Agreement:***

a) The Companies have provided estimate of the quantity of each type of interferences expected to be encountered in the contract in Schedule U-2. The parties may negotiate an Interference Agreement in any format or manner they deem fit based on quantities and types of Interferences expected to be encountered on this Contract as stated in Schedule U-2.

b) Furthermore, in Schedule U-3, standard unit work measurement and payment provisions are specified and shall apply only if the Contractor and affected Utility companies enters into a unit price based on an Interference Agreement; otherwise the unit of work measurement, and payment provisions set forth in Schedule U-3 shall not apply. The Contractor shall notify the City upon concluding an Interference Agreement with each of the Companies, which shall be binding and final once concluded.

**6. *City contract work to continue without Interference Agreement:***

If, prior to the start of construction, as directed by the City's Order to work / Notice To Proceed (OTW/ NTP) date any of the Companies and the Contractor have not concluded an Interference Agreement as described above, then the City will issue to private utility company (ies) in a written "48 Hours' notice to Public Corporation" in accordance with the Administrative Code of the City of New York. Construction will then proceed as ordered and the Contractor will be directed by the Resident Engineer (RE) to perform the City work on Time, Material and Equipment basis (T&M) as specified in standard City contract agreement Article 26.2. T&M records will include identification of types of utility facilities interfering with City work, utility facility owners, specifying the nature and quantity of any materials, plant and equipment furnished or used in connection with the performance of such work and crew size, such as: name and number of each worker employed on such work. T&M records will also indicate the hours of active time, standby time and idle time. The Company (ies) and the Contractor will maintain separate records of the actual quantity and cost of labor, materials, and equipment expended, and will provide copies of this information to the other party on a daily basis for reconciliation. These T&M records along with cost evaluations will be submitted daily to the Resident Engineer for review and approval. The total cost of City work will be based on quantity of work performed multiplied by unit price contract bid items. The total interference cost will be calculated as the difference between the total T&M cost and total cost for City work. The Resident Engineer will conduct a monthly reconciliation session of the daily T&M records with the affected Company (ies) and the Contractor. If the Contractor and affected utility companies cannot reconcile their T&M records, by the last day of each month, then the Resident Engineer will submit the approved City's T&M records along with total cost evaluations to the DDC Director of Construction who will review these records and recommend approval and validity certification by the DDC Construction Assistant Commissioner.

a) Copies of the DDC approved and certified T&M records will then be transmitted by the DDC to the Contractor and the utility companies. These certified records may be used by the Contractor for compensation claims against the responsible private facility owners, or may be used by any party as supporting documentation in dispute regarding compensation for performing Interference Work as identified in Schedule U-2. The Contractor will be required to perform City work while invoices are submitted by the Contractor to the utility companies for payment within 30 days, or while compensation disputes between the Contractor and affected company (ies) are submitted to Binding Arbitration process described in Paragraph 10.

b) All issues related to utility work and/or delays due to compensation disputes or claims against utility companies are not allowable as justification for granting contract time extensions or delay claims against the City. The City may assess liquidated damages specified in the contract for net overall delays suffered by City contract work as a result of utility issues, disputes and claims.

c) The standard City contract dispute resolution process specified in Article 27 "Presentation of disputes to Commissioner", of the standard City contract agreement is not applicable to any disputes related to utility work and/or compensation for such work or claim against utility companies. Utility work issues, disputes and claims may only be submitted to Binding Arbitration process described in Paragraph 10.

d) The Contractor will notify the Resident Engineer when utility capital work not specified in Schedule U-2 and/or for utility work that require the intervention of company utility specialty crews causes excessive contractor's labor and equipment standby or idleness and, thereby jeopardizing the City project schedule. The Resident Engineer will submit the facts to the DDC Director of Construction who will recommend to the DDC Deputy Commissioner regarding the issuance of a "48 Hours' notice to Public Corporation" to the concerned utility company as authorized by the New York City Administrative Code Section 19-143 and/or Section 24-521 as applicable.

e) Utility delays caused by utility capital work not listed in Schedule U-2 and/or by unavailability of utility specialty crews cannot be discounted for earning any contractual bonus when such bonus clause is included in a contract. However, if such specified bonus is not earned or is disallowed by the City or if the City assesses specified liquidated damages as a result of such excessive delays, the Contractor may seek damages from the responsible utility company (ies).

**7. Extra utility work with Interference Agreement:**

If during construction the Contractor encounters utility facilities interferences or utility scope of work that it believes is not covered by the Interference Agreement as described above, then the Contractor shall immediately notify the Company in writing, with a copy to the City, describing the nature and location of the extra work in question. The Company then has five (5) business days to investigate the conditions and then:

a) Advise the Contractor and the City in writing that no interference with its facilities exists at the location in question, and hence that the Contractor may proceed with City work without providing for any impact from Company facilities;

b) Advise the Contractor and the City in writing that the Interference Agreement negotiated pursuant to Paragraph 6, above, provides for the scope of work encountered, specifying the exact unit items and/or terms of the agreement that cover the work;

c) Advise the Contractor and the City in writing that it intends to perform the necessary utility work with company forces or with its own contractor including, but not limited to, relocating its facility out of the way of the proposed City work. In this case, the Company shall provide a written schedule for the performance of the utility work it proposes to perform, which shall be subject to approval by the City based on its impact to the Contractor's currently approved progress schedule. Upon approval of the Company's schedule by the City, the Contractor shall provide access to the worksite to the Company and/or any contractors hired by it to perform this utility work. If necessary, the City may grant a contract time extension for delays caused by the performance of such utility work by the company.

d) Reasonably specify in writing the scope of work to be performed by the Contractor on behalf of the Company that is not covered under the Interference Agreement negotiated pursuant to Paragraph 6, including, but not limited to, relocating, supporting, and/or protecting the Company's facilities, and/or shifting the City facility if approved by the Resident Engineer, and/or otherwise changing its operations to work in the presence of the Company's facilities. Should the Company elect this option, it must adequately define and provide an initial price offer for the work required to be performed.

**8. Means and Methods for utility work:**

Upon receipt of the Company's determination pursuant to Paragraphs 7.b, or 7.d, above, the Contractor shall determine reasonable means and methods of performing the work defined by the Company. These means and methods are subject to approval of the Company, which shall not be unreasonably withheld. If, however, the Company objects to the Contractor's proposed means and methods then it shall define an alternate method of construction. Upon receipt of the Company's approval or its

proposed alternate method of construction, the Contractor shall commence performance of the work defined by the Company as soon as possible, and shall perform the work in a good, workmanlike, and efficient manner, using the means and methods approved by the Company, in order to permit the City work to proceed in the most expeditious manner possible, but without imposing unreasonable and/or unnecessary costs on the Company. It is expressly understood by all parties that the City's rights pursuant to Article 4 of the Contract apply to Utility Work performed pursuant to this Section.

**9. *Disputed utility work covered by an interference agreement:***

The City Work will continue as described in Paragraph 6 above. In the event of any dispute between the Company (ies) and the Contractor regarding any issue related to the performance of, or payment for, utility work, including, but not limited to, any indirect or impact costs incurred by the Contractor due to the Utility Work and/or to the existence of facilities owned or operated by the Company (ies) on the line of the work. The Company (ies) and the Contractor hereby agree to submit to each other a "Final Offer," in writing, by certified mail. Each party shall then have three business days to consider each other's Final Offer. In the event that neither party accepts the other's Final Offer within those three days, the Company (ies) and the Contractor agree to immediately submit the dispute to binding arbitration as described in Paragraph 10. During the pendency of any arbitration, the Company (ies) and the Contractor shall maintain separate records of the actual quantity and cost of labor, materials, and equipment expended, and to provide copies of this information to the other party on a daily basis for reconciliation. Any and all disagreement with the records maintained and provided by the other, must be documented in writing to all parties. However, these records are solely for the benefit of presentation to the arbitrator, whose decision may not necessarily be based on these records and in any event is final. Both parties should be aware that the City will not confirm or deny the accuracy of any records that is not certified by DDC. While the arbitration is pending, the Company shall pay the Contractor on a monthly basis, based on the price offered by the Company to the Contractor for the performance of the work.

**10. *Arbitration of utility work:***

The arbitration of the issues described above shall be conducted pursuant to the Construction Industry Arbitration Rules of the American Arbitration Association (hereinafter "the Rules" and "AAA") in effect on the date the arbitration is initiated except as set forth herein. The arbitration award shall be final and binding upon the parties to the arbitration and judgment upon the award may be entered in a court having jurisdiction.

- a) Once an arbitrator(s) has been appointed by the AAA, the arbitration shall be scheduled as promptly as possible given the arbitrator(s) and the parties' schedules.

- b) No later than seven days prior to the first arbitration hearing, Company and the Contractor shall submit to the arbitrator(s), and to each other, a summary of each party's respective position and such other information as is deemed appropriate, along with a copy of each party's Final Offer as specified in Paragraph 9.
- c) The arbitration shall be conducted and concluded in two days.
- d) On the morning of the first day of the arbitration, the Contractor and/or representatives shall have 3 ½ hrs to make a presentation of its claim to the arbitrator. During its presentation, the Contractor shall not be permitted to produce any documents or cost records which have not already been provided to the Company. The Contractor shall be permitted to produce any analysis or description of its claim which has been prepared for the purpose of its presentation.
- e) Company and/or its representatives shall have two hours to ask the Contractor questions about its claim and its presentation. Thereafter the arbitrator(s) shall have two hours to ask the Contractor questions about its claim and its presentation.
- f) On the morning of the second day of the arbitration, Company and/or its representatives shall have 3 ½ hours to make a presentation of its claim to the arbitrator. During its presentation, the Company shall not be permitted to produce any documents or cost records which have not already been provided to the Contractor. The Company shall be permitted to produce any analysis or description of its claim which has been prepared for the purpose of its presentation.
- g) The Contractor and/or its representatives shall have two hours to ask Company questions about its claim and its presentation. Thereafter the arbitrator(s) shall have two hours to ask Company questions about its claim and its presentation.
- h) Subject to the above time limitations, the arbitrator(s) may conduct the arbitration in such manner as the arbitrator(s) deems reasonable.
- i) The arbitrator(s) shall then have one week to select in writing, as the arbitrator ('s) award, that party's Final Offer which appears to be more reasonable, based on the presentations at the arbitration hearings.
- j) The arbitrator shall have no discretion to grant an award other than one of the two Final Offers submitted by the parties.
- k) Any award for work that has already been performed shall be paid on the 7<sup>th</sup> day after receipt of the arbitrator's decision, or on the 30<sup>th</sup> day after completion of the work, whichever is later. Payment for work not yet completed at the time of the arbitrator's decision shall be paid within 30 days of completion of work. Interest shall accrue from the date payment is due at the rate of 9% per annum. Either



party may cause judgment to be entered in accordance with the arbitrator(s) decision in a court in the State of New York, County of New York.

l) The arbitrator's fees and any other costs of the arbitration shall be initially shared equally by Company and the Contractor. The non-prevailing party shall then pay all arbitrator's fees and costs of the arbitration and shall reimburse the prevailing party for its share of such fees and costs theretofore paid.

m) The parties may, at any time, settle any matter submitted to arbitration.

**11. Order-out waiver:**

The Contractor and all subcontractors hired by it, if an Interference Agreement is executed as specified between the concerned parties, agree to waive any rights they may have, if any, under law, contract or otherwise to compel the City to assert any right the City may have, including the issuance of any directives required under the New York City Administrative Code, Section 19-143 and Section 24-521, to require any or all of the Companies to maintain, repair, replace, protect, support, shift, alter, relocate, and/or remove utility facilities in connection with the work to be performed under this contract. However, nothing in this Section shall preclude the City from exercising its rights under the Law to issue such a directive to the Company.

**12. Cost of insurance:**

Each of the named Companies, at their option and if an Interference Agreement is executed as specified between the concerned parties, may be named as an additional insured on all insurance policies required to be maintained under this contract. In the event that a Company opts to be so named as an additional insured, the actual incremental cost, if any, to the Contractor of providing such insurance coverage shall be borne by that Company. The Contractor shall provide a written statement from its insurance provider documenting the actual cost of this added coverage to the Company. Under no circumstances shall the cost of insurance coverage on behalf of any Company be borne by the City. Nothing in this paragraph shall be interpreted to imply the City's acceptance of any additional responsibility or liability for any matter related to the performance of Utility Work. In particular, the Company and the Contractor bear joint and full responsibility to ensure that any Utility Work performed by the Contractor is in compliance with all applicable government and Company regulations.

**13. Cost of utility interference work:**

The Companies, by virtue of participating in design alignment meetings and submitting their scope of Utility Interferences Work to the City, have agreed to perform their obligations described in this Section. It is expressly understood that the cost of Utility Work or any delays caused by such Utility Work shall not be a charge against the City, but shall be a matter for adjustment between the Contractor and the Company or Companies concerned. The City and the Contractor agree that the Companies are

third party beneficiaries of this Section of the contract, if an Interference Agreement is executed between the Contractor and utility company (ies). The provisions of this Section shall govern in all cases where Company property interferes with or is about to be disturbed by the City work, notwithstanding any other provision of the Contract, except for Natural Gas transmission/distribution facilities covered subject to the Gas Facility Cost Allocation Act (GFCAA) and covered separately in this contract.

**14. Default declaration:**

The Contractor agrees that the provisions of this Section are material provisions of the contract, and that the Contractor's failure to comply with the procedures set forth above are sufficient for the Commissioner to declare the Contractor in default pursuant to Article 48 of the Contract.

**15. NYS Labor Law:**

The Contractor is hereby advised that New York State Labor Law and/or, Davis-Bacon Act if federally funded, applies to public work. The work described in this Utility Interferences Section of the contract performed by utility company (ies) with their own forces or vendors hired by such company (ies) is not public work.

**16. Facility operators:**

The insurance requirements in Paragraph 12 of this UI Section apply to: (i) additional Companies, if any, who were not named in Schedule "A" but which have executed an Interference Agreement with the Contractor for utility work; and (ii) additional coverage, if any, paid for by Utility Companies whose utility facilities are located within the project limits, that they may require for the utility work pursuant to an Interference Agreement between the Contractor and such utility company (ies).

(End of Section)

"STANDARD UTILITY LETTER OF AGREEMENT"

(Name)  
Deputy Commissioner, Infrastructure Division  
Department of Design and Construction  
30-30 Thomson Avenue  
Long Island City, NY 11101

RE: City Work Performed in the Presence of Private Utility Facilities  
Project No: \_\_\_\_\_

Dear (Name):

This letter is to certify that \_\_\_\_\_, has requested the inclusion of the attached "Utility Interferences (UI) Section: Additional contract requirements applying to work performed in the presence of privately owned utility." The company agrees to abide by the terms of this UI Section at the company's own expenses due to their facilities interferences with the Public work.

Sincerely,

\_\_\_\_\_  
By: Authorized Company Representative

\_\_\_\_\_  
Title

NOTARY PUBLIC

CERTIFIED AS TO FORM  
AND LEGAL AUTHORITY:

By: \_\_\_\_\_

**SCHEDULE U-1**

**LISTING OF COMPANY (IES) NAMED FOR THIS CONTRACT**

<u>COMPANY NAME</u>	<u>CONTACT NAME</u>	<u>CONTACT TELEPHONE</u>
NATIONAL GRID	NEVILLE JACOBS	718-963-5612
LONG ISLAND POWER AUTHORITY	MIKE SZENCZY	516-949-8350
VERIZON	AUBREY MAKHANLALL	718-977-8165
TIME WARNER	JOHN PIAZZA	718-888-4261

**SCHEDULE U-2**

**nationalgrid** —

**Support & Protection**  
**CONTRACT NO. SANDHW11**  
**Reconstruction of Beach Channel Drive**  
**Borough of Queens**

<b>CET Item Number</b>	<b>Description</b>	<b>Unit</b>	<b>Estimated Quantity</b>
300	Special Care Excavation & Backfilling	CY	30
400	Test Pits	CY	60
636EA RD	Adjustment Of Utility Hardware (Under 7")	Each	5
636EB RD	Adjustment Of Utility Hardware (7" To 14")	Each	5
700	Special Modification Of Work To Accommodate Utilities	CY	20
710.1	Removal of Abandoned Utility Steel/Cast Iron Pipes	LF	300
802A	Special Care For Installation Of New Sidewalks	SF	60
802B	Special Care For Installation Of New Curbs	LF	40



CET ITEM NUMBER	DESCRIPTION
300	<b>Special Care Excavation &amp; Backfilling (C.Y.)</b>  At the following locations: AS ENCOUNTERED AND REQUIRED BY NATIONAL GRID Quantity – 30 CY
400	<b>Excavation of Test Pits(C.Y.)</b>  At the following locations: AS ENCOUNTERED AND REQUIRED BY NATIONAL GRID Quantity – 60 CY
636EA RD	<b>Adjustment Of Utility Hardware (under 7" width) Ea.</b>  At the following locations: AS ENCOUNTERED AND REQUIRED BY NATIONAL GRID Quantity – 5 Ea.
636EB RD	<b>Adjustment Of Utility Hardware (7" To 14") Ea.</b>  At the following locations: AS ENCOUNTERED AND REQUIRED BY NATIONAL GRID Quantity – 5 Ea.
700	<b>Special Modification Of Work To Accommodate Underground Utilities with Limited Cover</b>  At the following locations: AS ENCOUNTERED AND REQUIRED BY NATIONAL GRID Quantity – 20 CY
710.1	<b>Removal of Abandoned Utility Steel/Cast Iron Pipes</b>  At the following locations: AS ENCOUNTERED AND REQUIRED BY NATIONAL GRID Quantity – 300 LF



**802A Special Care For Installation Of New Sidewalks**

At the following locations:  
AS ENCOUNTERED AND REQUIRED BY NATIONAL GRID  
Quantity – 60 SF

**802B Special Care For Installation Of New Curbs**

At the following locations:  
AS ENCOUNTERED AND REQUIRED BY NATIONAL GRID  
Quantity – 40 LF

**FOR INFORMATION ONLY  
ENGINEER'S ESTIMATE OF QUANTITY AND TYPES OF INTERFERENCE  
FOR LONG ISLAND POWER AUTHORITY**

**SANDHW11**

CET ITEM	DESCRIPTION	UNIT	EST. QUAN.
CET 100.3	SUPPORT UTILITIES CROSSING TRENCH FOR CATCH BASIN CHUTE CONNECTION AND/OR TEST (TYPE .3)	EA	7
CET 101.3	SUPPORT UTILITIES CROSSING TRENCH FOR SEWERS 12" TO 24" IN DIAMATER (TYPE .3)	EA	1
CET108.3	SUPPORT UTILITIES CROSSING TRENCH FOR WATER MAIN UP TO AND INCL. 12" DIAMETER (TYPE .3)	EA	7
CET 109.3	SUPPORT UTILITIES CROSSING TRENCH FOR WATER MAIN OVER 12" TO 24" DIAMETER (TYPE .3)	EA	2
CET 225	INSTALLATION AND/OR REMOVAL OF CATCH BASINS WITH UTILITY INTERFERENCES	EA	5
CET 300	SUPPORT AND PROTECTION OF UTILITY FACILITIES DURING EXCAVATION	C.Y.	150
CET 350	OVERHEAD ACCOMMODATION, PROTECTION OF OVERHEAD FACILITIES, POLES AND APPURTENANCES	L.S.	1
CET 351	UTILITY POLE SUPPORTS	EA	14
CET 400	TEST PITS FOR UTILITY FACILITIES	C.Y.	20
CET 401	TRENCH EXCAVATION FOR ADJUSTMENT OF UTILITY FACILITIES	C.Y.	100
CET 402.1	ADJUST EXISTING CONCRETE ENCASED CONDUITS PLACE IN FINAL POSITION WITHOUT CONCRETE ENCASEMENT	L.F.	200
CET 402.2	ADJUST EXISTING NON CONCRETE ENCASED CONDUITS PLACED IN FINAL POSITION WITHOUT CONCRETE ENCASEMENT	L.F.	200
CET 636 EE RD	ADJUSTMENT OF UTILITY HARDWARE (34" TO UNDER 41" WIDTH)	EA	8



**LIPA**  
**SCOPE OF WORK SUPPORT AND PROTECTION**  
**SANDHW11**

CET 100.3	<p>SUPPORT UTILITIES OVER 2.0 SF, UP TO AND INCLUDING 6.0 SF, CROSSING FOR CATCH BASIN CHUTE CONNECTION AND/OR TEST PUT (TYPE .3)</p> <p><i>At the following locations:</i></p> <p>SHEET U3:                  (7) INTERSECTION OF BEACH 116<sup>th</sup> ST AND BEACH CHANNEL DR</p> <p><b>Total quantity for CET 100.3= 7</b></p>	EA
CET 101.3	<p>SUPPORT UTILITIES OVER 2.0 SF, UP TO AND INCLUDING 6.0 SF, CROSSING TRENCH FOR SEWERS 12" TO 24" DIAMETER (TYPE .3)</p> <p><i>At the following locations:</i></p> <p>SHEET U3:                  (1) INTERSECTION OF BEACH 116<sup>th</sup> ST AND BEACH CHANNEL DR</p> <p><b>Total quantity for CET 101.3 = 1</b></p>	EA
CET 108.3	<p>SUPPORT UTILITIES OVER 2.0 SF, UP TO AND INCLUDING 6.0 SF CROSSING TRENCH FOR WATER MAIN UP TO AND INCLUDING 12" DIAMETER (TYPE .3)</p> <p><i>At the following locations:</i></p> <p>SHEET U3:                  (1) BEACH 116<sup>th</sup> ST APPROX 10' S. OF BEACH CHANNEL DR                  (1) INTERSECTION OF BEACH 116<sup>th</sup> ST AND BEACH CHANNEL DR                  (1) BEACH CHANNEL DR. APPROX 275' EAST OF BEACH 116<sup>th</sup> ST                  (2) # 115-09 ROCKAWAY BEACH BLVD                  (2) #114-11 ROCKAWAY BEACH BLVD</p> <p><b>Total quantity for CET 108.3 = 7</b></p>	EA

**LIPA SCOPE OF WORK  
SUPPORT AND PROTECTION**

**SANDHW11**

CET 109.3	<p>SUPPORT UTILITIES OVER 2.0 SF UP TO AND INCLUDING 6.0 SF CROSSING TRENCH FOR WATER MAIN OVER 12" AND UP TO 24" DIAMETER (TYPE .3)</p> <p><i>At the following locations:</i></p> <p>SHEET U3: (1) INTERSECTION OF BEACH 116<sup>th</sup> ST AND BEACH CHANNEL DR SHEET U4: (1) #231 BEACH 116<sup>th</sup> ST</p> <p><b>Total quantity for CET 109.3 = 2</b></p>	EA
CET 225	<p>INSTALLATION AND/OR REMOVAL OF CATCH BASINS WITH UTILITY INTERFERENCE</p> <p><i>At the following locations:</i></p> <p>SHEET U3: (5) INTERSECTION OF BEACH 116<sup>th</sup> ST AND BEACH CHANNEL DR</p> <p><b>Total quantity for CET 225 = 5</b></p>	EA
CET 300	<p>SUPPORT AND PROTECTION OF UTILITY FACILITIES DURING EXCAVATION</p> <p><i>At the following locations:</i></p> <p>SHEET U3: (150) BEACH 116<sup>th</sup> ST</p> <p><b>Total quantity for CET 330 = 150</b></p>	C.Y.
CET 350	<p>OVERHEAD ACCOMMODATION, PROTECTION OF OVERHEAD FACILITIES, POLES AND APPURTENANCES</p> <p><i>At the following locations:</i></p> <p>Various Locations AS SHOWN ON THE CONTRACT DOCUMENTS</p> <p><b>Total quantity for CET 350 = 1</b></p>	L.S.

**LIPA SCOPE OF WORK  
SUPPORT AND PROTECTION**

**SANDHW11**

CET 351	<p>LONG ISLAND POWER AUTHORITY POLE SUPPORTS</p> <p><i>At the following locations:</i></p> <p><u>SHEET U2:</u>  (1) S/W/C OF BEACH 123<sup>rd</sup> AND BEACH CHANNEL DRIVE – POLE #14  (1) S/W/C OF BEACH 122<sup>nd</sup> AND BEACH CHANNEL DRIVE – POLE #112  (1) S/W/C OF BEACH 120<sup>th</sup> ST AND BEACH CHANNEL DRIVE – POLE #271</p> <p><u>SHEET U3:</u>  (1) S/E/C OF BEACH 117<sup>th</sup> AND BEACH CHANNEL DRIVE – POLE #14  (1) S/W/C OF BEACH 116<sup>th</sup> ST AND BEACH CHANNEL DRIVE – POLE #14x  (1) BEACH 116<sup>th</sup> ST AND CROTON – POLE #1  (1) N/W/C OF BEACH 116<sup>th</sup> ST AND BEACH CHANNEL DRIVE – POLE #263  (1) S/W/C OF BEACH 116<sup>th</sup> ST AND BEACH CHANNEL DRIVE – POLE #17</p> <p><u>SHEETS UI-U4:</u>  (6) VARIOUS LOCATIONS AS DIRECTED BY ENGINEER</p> <p><b>Total quantity for CET 351 = 14</b></p>	EA
CET 400	<p>TEST PITS FOR UTILITY FACILITIES</p> <p><i>At the following locations:</i></p> <p><u>SHEETS UI-U4:</u>  (20) VARIOUS LOCATIONS AS DIRECTED BY ENGINEER</p> <p><b>Total quantity for CET 400 = 20</b></p>	C.Y.
CET 401	<p>TRENCH EXCAVATION FOR ADJUSTMENT OF UTILITY FACILITIES</p> <p><i>At the following locations:</i></p> <p><u>SHEET U3:</u>  (100) BEACH 116<sup>th</sup> ST</p> <p><b>Total quantity for CET 401 = 100</b></p>	C.Y.
CET 402.1	<p>ADJUST EXISTING CONCRETE ENCASED CONDUITS PLACED IN FINAL POSITION WITHOUT CONCRETE ENCASEMENT</p> <p><i>At the following locations:</i></p> <p><u>SHEET U3:</u>  (200) BEACH 116<sup>th</sup> ST</p> <p><b>Total quantity for CET 402.1 = 200</b></p>	L.F.

LIPA  
SCOPE OF WORK SUPPORT AND PROTECTION

SANDHW11

CET 402.2	<p>ADJUST EXISTING NON-CONCRETE ENCASED CONDUITS PLACED IN FINAL POSITION WITHOUT CONCRETE ENCASEMENT</p> <p><i>At the following locations:</i></p> <p>SHEET U3: (200) BEACH 116<sup>th</sup> ST</p> <p><b>Total quantity for CET 402.2 = 200</b></p>	L.F.
CET 636EE RD	<p>ADJUSTMENT OF UTILITY HARDWARE (34" TO UNDER 41" WIDTH)</p> <p><i>At the following locations:</i></p> <p>SHEETS UI-U4: (8) VARIOUS LOCATIONS AS DIRECTED BY ENGINEER</p> <p><b>Total quantity for CET 636EE = 8</b></p>	EA

Verizon

For Information Only

November 2016

**SANDHW11**  
**Reconstruction of Beach Channel Drive from Beach 116th Street to Beach 124th**  
**Street**  
**Borough of Queens**  
**Schedule UI: Scope of Work for CET items**

CET ITEM	UNITS	TOTAL	DESCRIPTION
CET 100.1	EACH	2	UTILITIES CROSSING TRENCH FOR CATCH BASIN CHUTE CONNECTIONS AND/OR TEST PITS (TYPE .1)
CET 100.2	EACH	3	UTILITIES CROSSING TRENCH FOR CATCH BASIN CHUTE CONNECTIONS AND/OR TEST PITS (TYPE .2)
CET 100.3	EACH	3	UTILITIES CROSSING TRENCH FOR CATCH BASIN CHUTE CONNECTIONS AND/OR TEST PITS (TYPE .3)
CET 108.1	EACH	4	UTILITIES CROSSING TRENCH FOR WATER MAIN UP TO AND INCLUDING 12" DIAMETER (TYPE .1)
CET 108.2	EACH	4	UTILITIES CROSSING TRENCH FOR WATER MAIN UP TO AND INCLUDING 12" DIAMETER (TYPE .2)
CET 109.1	EACH	2	UTILITIES CROSSING TRENCH FOR WATER MAIN OVER 12" AND UP TO 24" DIAMETER (TYPE .1)
CET 109.2	EACH	2	UTILITIES CROSSING TRENCH FOR WATER MAIN OVER 12" AND UP TO 24" DIAMETER (TYPE .2)
CET 109.3	EACH	1	UTILITIES CROSSING TRENCH FOR WATER MAIN OVER 12" AND UP TO 24" DIAMETER (TYPE .3)
CET 200	LF	65	EXTRA DEPTH EXCAVATION OF CATCH BASIN CHUTE CONNECTION PIPES
CET 225.1A	EACH	2	INSTALLATION AND REMOVAL OF CATCH BASINS WITH UTILITY INTERFERENCES
CET 300	CY	28	SPECIAL CARE EXCAVATION AND BACKFILLING
CET 304 A	CY	5	FURNISH, DELIVER, AND INSTALL CONCRETE ROAD BASE
CET 305	TONS	1	FURNISH, DELIVER, AND INSTALL ASPHALT PAVING MIXTURES

Verizon

For Information Only

November 2016

**SANDHW11**  
**Reconstruction of Beach Channel Drive from Beach 116th Street to Beach 124th**  
**Street**  
**Borough of Queens**

**Schedule UI: Scope of Work for CET items**

CET 330T	LF	280	SUPPORT AND PROTECTION OF COMMUNICATION UTILITY FACILITIES DURING EXCAVATION OF CITY TRENCH WHEN FACILITIES LIE IN OR IN CLOSE PROXIMITY TO TRENCH LIMITS
CET 350	LS	1	OVERHEAD ACCOMMODATION PROTECTION OF OVERHEAD FACILITIES, POLES AND APPURTENANCES
CET 400	CY	5	TEST PITS FOR UTILITY FACILITIES
CET 401	CY	44	TRENCH EXCAVATION FOR ADJUSTMENT OF UTILITY FACILITIES
CET 402T.2A	DF	100	EXISTING NON-CONCRETE ENCASED TELECOMMUNICATION CONDUITS PLACED IN FINAL POSITION WITH CONCRETE ENCASEMENT
CET 403	SF	250	PLACING STEEL PROTECTION PLATES FOR UTILITY FACILITIES
CET 636 EE RD	EA	1	ADJUSTMENT OF UTILITY HARDWARE (34" TO UNDER 41" WIDTH)
CET 636 RM	CY	5	REBUILDING AND MODIFICATIONS TO UTILITY STRUCTURES
CET 700	CY	240	SPECIAL MODIFICATION OF WORK METHODS TO ACCOMMODATE PROTECT UNDERGROUND FACILITIES WITH LIMITED COVER
CET 798	LF	50	MODIFICATION OF NON-CONCRETE YOKE TROLLEY STRUCTURES REMOVAL WHEN CROSSING UTILITY FACILITIES

Verizon

For Information Only

November 2016

**SANDHW11**  
**Reconstruction of Beach Channel Drive from Beach 116th Street to Beach**  
**124th Street**  
**Borough of Queens**  
**Schedule UI: Scope of Work for CET items**

---

CET 100.1		QTY(EA)
UTILITIES CROSSING TRENCH FOR CATCH BASIN CHUTE CONNECTIONS AND/OR TEST PITS (TYPE .1)		
@ THE FOLLOWING LOCATIONS		
SEC INT OF BEACH 116TH STREET & NEWPORT AVENUE		2
<b>CET 100.1</b>	<b>TOTAL</b>	<b>2</b>

---

CET 100.2		QTY(EA)
UTILITIES CROSSING TRENCH FOR CATCH BASIN CHUTE CONNECTIONS AND/OR TEST PITS (TYPE .2)		
@ THE FOLLOWING LOCATIONS		
SWC INT OF BEACH 116TH STREET & NEWPORT AVENUE		1
SEC INT OF BEACH 116TH STREET & NEWPORT AVENUE		2
<b>CET 100.2</b>	<b>TOTAL</b>	<b>3</b>

---

CET 100.3		QTY(EA)
UTILITIES CROSSING TRENCH FOR CATCH BASIN CHUTE CONNECTIONS AND/OR TEST PITS (TYPE .3)		
@ THE FOLLOWING LOCATIONS		
SWC INT OF BEACH 116TH STREET & NEWPORT AVENUE		1
SEC INT OF BEACH 116TH STREET & NEWPORT AVENUE		2
<b>CET 100.3</b>	<b>TOTAL</b>	<b>3</b>

---

CET 108.1		QTY(EA)
UTILITIES CROSSING TRENCH FOR WATER MAIN UP TO AND INCLUDING 12" DIAMETER (TYPE .1)		
@ THE FOLLOWING LOCATIONS		
S SIDE OF BEACH 116TH STREET BTWN NEWPORT AVENUE & BEACH CHANNEL DR		1
NEC INT OF ROCKAWAY BEACH BLVD & BEACH 114TH STREET		1
NEC INT OF ROCKAWAY BEACH BLVD & BEACH 115TH STREET		1
SWC INT OF BEACH 116TH STREET & ROCKAWAY BEACH BLVD		1
<b>CET 108.1</b>	<b>TOTAL</b>	<b>4</b>

---

**Verizon**

For Information Only

November 2016

**SANDHW11**  
**Reconstruction of Beach Channel Drive from Beach 116th Street to Beach**  
**124th Street**  
**Borough of Queens**  
**Schedule UI: Scope of Work for CET items**

---

<b>CET 108.2</b>		<b>QTY(EA)</b>
<b>UTILITIES CROSSING TRENCH FOR WATER MAIN UP TO AND INCLUDING</b>		
<b>12" DIAMETER (TYPE .2)</b>		
@ THE FOLLOWING LOCATIONS		
S SIDE OF BEACH 116TH ST BTWN NEWPORT AVE & BEACH CHANNEL DR		1
SEC INT OF BEACH 116TH STREET & BEACH CHANNEL DRIVE		1
NEC INT OF ROCKAWAY BEACH BLVD & BEACH 114TH STREET		1
NEC INT OF ROCKAWAY BEACH BLVD & BEACH 115TH STREET		1
<b>CET 108.2</b>	<b>TOTAL</b>	<b>4</b>
<hr/>		
<b>CET 109.1</b>		<b>QTY(EA)</b>
<b>UTILITIES CROSSING TRENCH FOR WATER MAIN OVER 12" AND UP TO</b>		
<b>24" DIAMETER (TYPE .1)</b>		
@ THE FOLLOWING LOCATIONS		
SEC INT OF ROCKAWAY BEACH BLVD & BEACH 115TH STREET		1
SEC INT OF ROCKAWAY BEACH BLVD & BEACH 114TH STREET		1
<b>CET 109.1</b>	<b>TOTAL</b>	<b>2</b>
<hr/>		
<b>CET 109.2</b>		<b>QTY(EA)</b>
<b>UTILITIES CROSSING TRENCH FOR WATER MAIN OVER 12" AND UP TO</b>		
<b>24" DIAMETER (TYPE .2)</b>		
@ THE FOLLOWING LOCATIONS		
SWC INT OF BEACH 116TH STREET & NEWPORT AVENUE		1
NWC INT OF BEACH 116TH STREET & ROCKAWAY BEACH BLVD		1
<b>CET 109.2</b>	<b>TOTAL</b>	<b>2</b>
<hr/>		
<b>CET 109.3</b>		<b>QTY(EA)</b>
<b>UTILITIES CROSSING TRENCH FOR WATER MAIN OVER 12" AND UP TO</b>		
<b>24" DIAMETER (TYPE .3)</b>		
@ THE FOLLOWING LOCATIONS		
SWC INT OF BEACH 116TH STREET & NEWPORT AVENUE		1
<b>CET 109.3</b>	<b>TOTAL</b>	<b>1</b>
<hr/>		



**Verizon**

For Information Only

**November 2016**

**SANDHW11**  
**Reconstruction of Beach Channel Drive from Beach 116th Street to Beach**  
**124th Street**  
**Borough of Queens**  
**Schedule UI: Scope of Work for CET items**

---

<b>CET 200</b>		
<b>EXTRA DEPTH EXCAVATION OF CATCH BASIN CHUTE CONNECTION PIPES</b>		
@ THE FOLLOWING LOCATIONS		
		QTY(LF)
SWC INT OF BEACH 116TH STREET & NEWPORT AVENUE		25
SEC INT OF BEACH 116TH STREET & NEWPORT AVENUE		30
S SIDE OF BEACH 116TH STREET BTWN NEWPORT AVENUE & BEACH CHANNEL DR		10
<b>CET 200</b>	<b>TOTAL</b>	<b>65</b>
<hr/>		
<b>CET 225.1A</b>		
<b>INSTALLATION AND REMOVAL OF CATCH BASINS WITH</b>		
<b>UTILITY INTERFERENCES</b>		
@ THE FOLLOWING LOCATIONS		
		QTY(EA)
SEC INT OF NEWPORT AVENUE & BEACH 116TH STREET		1
SWC INT OF NEWPORT AVENUE & BEACH 116TH STREET		1
<b>CET 225.1A</b>	<b>TOTAL</b>	<b>2</b>
<hr/>		
<b>CET 300</b>		
<b>SPECIAL CARE EXCAVATION AND BACKFILLING</b>		
@ THE FOLLOWING LOCATIONS		
		QTY(CY)
S SIDE OF BEACH CHANNEL DRIVE BTWN BEACH 116TH ST & ROCKAWAY FWY		28
<b>CET 300</b>	<b>TOTAL</b>	<b>28</b>
<hr/>		
<b>CET 304 A</b>		
<b>FURNISH, DELIVER, AND INSTALL CONCRETE ROAD BASE</b>		
@ THE FOLLOWING LOCATIONS		
		QTY(CY)
AS ENCOUNTERED AND DIRECTED BY THE VERIZON FIELD REPRESENTATIVE		5
<b>CET 304 A</b>	<b>TOTAL</b>	<b>5</b>
<hr/>		

**Verizon**

For Information Only

November 2016

**SANDHW11****Reconstruction of Beach Channel Drive from Beach 116th Street to Beach  
124th Street****Borough of Queens****Schedule UI: Scope of Work for CET items**

<b>CET 305</b>		
<b>FURNISH, DELIVER, AND INSTALL ASPHALT PAVING MIXTURES</b>		
<b>@ THE FOLLOWING LOCATIONS</b>		
AS ENCOUNTERED AND DIRECTED BY THE VERIZON FIELD REPRESENTATIVE		QTY(TONS) 1
<b>CET 305</b>	<b>TOTAL</b>	<b>1</b>
<hr/>		
<b>CET 330T</b>		
<b>SUPPORT AND PROTECTION OF COMMUNICATION UTILITY FACILITIES</b>		
<b>DURING EXCAVATION OF CITY TRENCH WHEN FACILITIES LIE IN OR</b>		
<b>IN CLOSE PROXIMITY TO TRENCH LIMITS</b>		
<b>@ THE FOLLOWING LOCATIONS</b>		
S SIDE OF BEACH 116TH STREET FROM NEWPORT AVENUE TO BEACH CHANNEL DR		QTY(LF) 150
S SIDE INT OF BEACH 116TH STREET & NEWPORT AVENUE		30
N SIDE OF ROCKAWAY BEACH BLVD BTWN BEACH 116TH STREET & BEACH 114TH STREET		100
<b>CET 330T</b>	<b>TOTAL</b>	<b>280</b>
<hr/>		
<b>CET 350</b>		
<b>OVERHEAD ACCOMMODATION PROTECTION OF OVERHEAD</b>		
<b>FACILITIES, POLES AND APPURTENANCES</b>		
<b>@ THE FOLLOWING LOCATIONS</b>		
AS ENCOUNTERED AND DIRECTED BY THE VERIZON FIELD REPRESENTATIVE		QTY(LS) 1
<b>CET 350</b>	<b>TOTAL</b>	<b>1</b>
<hr/>		
<b>CET 400</b>		
<b>TEST PITS FOR UTILITY FACILITIES</b>		
<b>@ THE FOLLOWING LOCATIONS</b>		
AS ENCOUNTERED AND DIRECTED BY THE VERIZON FIELD REPRESENTATIVE		QTY(CY) 5
<b>CET 400</b>	<b>TOTAL</b>	<b>5</b>
<hr/>		

**Verizon**

For Information Only

November 2016

**SANDHW11**  
**Reconstruction of Beach Channel Drive from Beach 116th Street to Beach**  
**124th Street**  
**Borough of Queens**  
**Schedule UI: Scope of Work for CET items**

---

<b>CET 401</b>		
<b>TRENCH EXCAVATION FOR ADJUSTMENT OF UTILITY FACILITIES</b>		
<b>@ THE FOLLOWING LOCATIONS</b>		
		QTY(CY)
AS ENCOUNTERED AND DIRECTED BY THE VERIZON FIELD REPRESENTATIVE		44
<b>CET 401</b>	<b>TOTAL</b>	<b>44</b>
<hr/>		
<b>CET 402T.2A</b>		
<b>EXISTING NON-CONCRETE ENCASED TELECOMMUNICATION CONDUITS</b>		
<b>PLACED IN FINAL POSITION WITH CONCRETE ENCASEMENT</b>		
<b>@ THE FOLLOWING LOCATIONS</b>		
		QTY(DF)
AS ENCOUNTERED AND DIRECTED BY THE VERIZON FIELD REPRESENTATIVE		100
<b>CET 402T.2A</b>	<b>TOTAL</b>	<b>100</b>
<hr/>		
<b>CET 403</b>		
<b>PLACING STEEL PROTECTION PLATES FOR UTILITY FACILITIES</b>		
<b>@ THE FOLLOWING LOCATIONS</b>		
		QTY(SF)
AS ENCOUNTERED & DIRECTED BY THE VERIZON FIELD REPRESENTATIVE		250
<b>CET 403</b>	<b>TOTAL</b>	<b>250</b>
<hr/>		
<b>CET 636 EE RD</b>		
<b>ADJUSTMENT OF UTILITY HARDWARE (34" TO UNDER 41" WIDTH)</b>		
<b>@ THE FOLLOWING LOCATIONS</b>		
		QTY(EA)
E SIDE INT OF BEACH 116TH STREET & NEWPORT AVENUE		1
<b>CET 636 EE RD</b>	<b>TOTAL</b>	<b>1</b>
<hr/>		
<b>CET 636 RM</b>		
<b>REBUILDING AND MODIFICATIONS TO UTILITY STRUCTURES</b>		
<b>@ THE FOLLOWING LOCATIONS</b>		
		QTY(CY)
E SIDE INT OF BEACH 116TH STREET & NEWPORT AVENUE		5
<b>CET 636 RM</b>	<b>TOTAL</b>	<b>5</b>

**Verizon**

For Information Only

November 2016

**SANDHW11  
 Reconstruction of Beach Channel Drive from Beach 116th Street to Beach  
 124th Street  
 Borough of Queens**

**Schedule UI: Scope of Work for CET items**

---

**CET 700**

**SPECIAL MODIFICATION OF WORK METHODS TO ACCOMMODATE/  
 PROTECT UNDERGROUND FACILITIES WITH LIMITED COVER  
 @ THE FOLLOWING LOCATIONS**

	QTY(CY)
S SIDE INT OF BEACH 116TH STREET & NEWPORT AVENUE	65
S SIDE OF BEACH 116TH ST FROM NEWPORT AVE TO BEACH CHANNEL DR	78
S SIDE OF BEACH CHANNEL DR BTWN BEACH 116TH STREET & ROCKAWAY FWY	97
<b>CET 700</b>	<b>TOTAL 240</b>

---

**CET 798**

**MODIFICATION OF NON- CONCRETE YOKE TROLLEY STRUCTURE  
 REMOVAL WHEN CROSSING UTILITY FACILITIES  
 @ THE FOLLOWING LOCATIONS**

	QTY(LF)
AS ENCOUNTERED & DIRECTED BY THE VERIZON FIELD REPRESENTATIVE	50
<b>CET 798</b>	<b>TOTAL 50</b>

---

**FOR INFORMATION ONLY**  
**ENGINEER'S ESTIMATE OF QUANTITIES AND TYPES OF INTERFERENCE**  
**TIME WARNER CABLE OF NEW YORK CITY**  
**SANDHW11**  
**Reconstruction of Beach Channel Drive**  
**Borough of Queens**

CET ITEM	DESCRIPTION	UNITS	ESTIMATED QUANTITY
350	OVERHEAD ACCOMMODATION, PROTECTION OF OVERHEAD FACILITIES, POLES & APPURTENANCES	LS	1

**TIME WARNER CABLE  
SUPPORT & PROTECTION  
SANDHW11  
Reconstruction of Beach Channel Drive  
Borough of Queens**

CET 350	OVERHEAD ACCOMMODATION, PROTECTION OF OVERHEAD FACILITIES, POLES & APPURTENANCES	LS
	At the following locations:	1
	AS ENCOUNTERED	
		Total quantity for CET
350		1

## **SCHEDULE U-3**

(NO TEXT IN THIS SECTION)

# SKETCHES

(NO TEXT IN THIS SECTION)



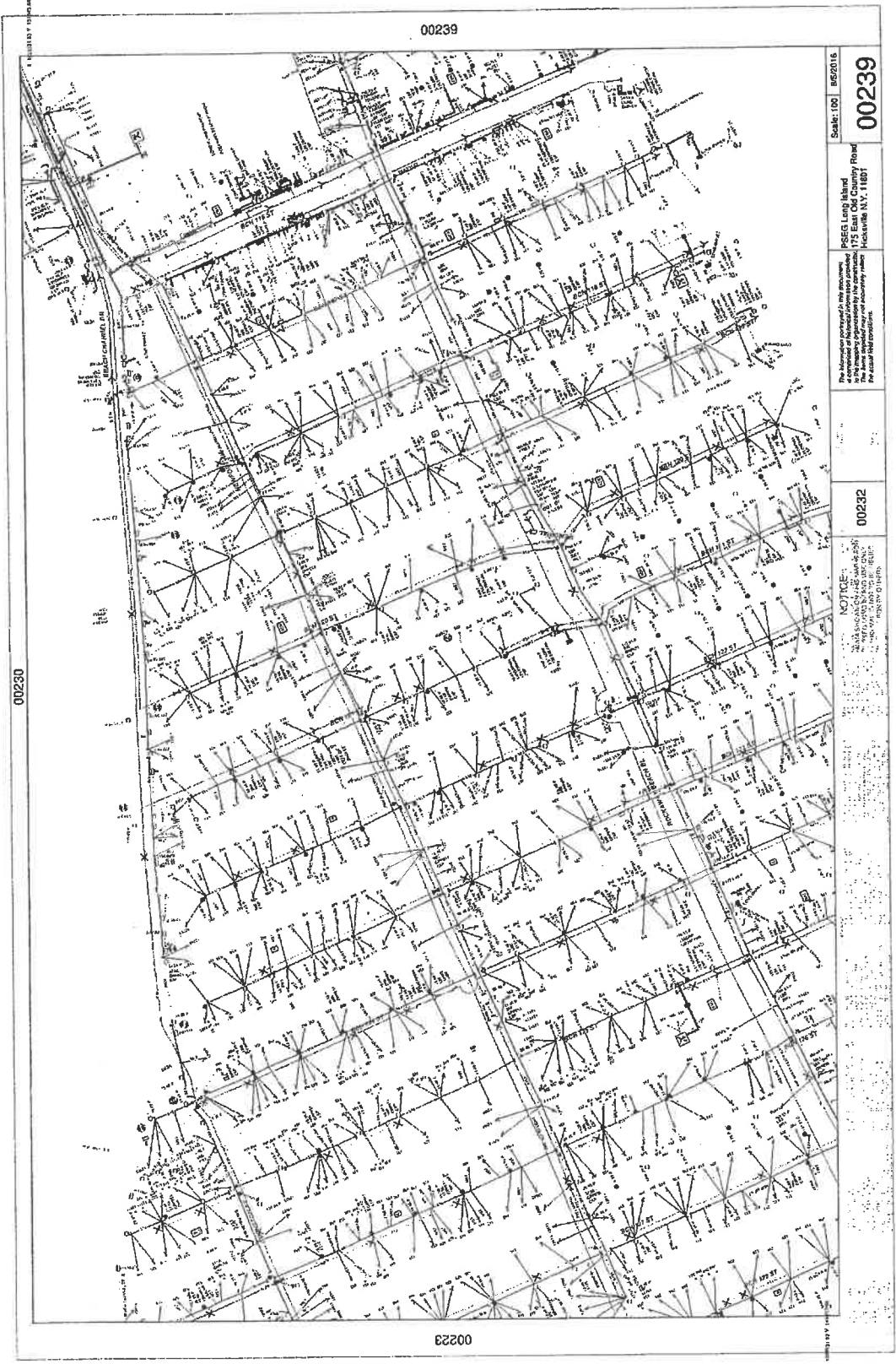

Scale: 1"=100' 06/2016  
00239

00232

NOTICE: This drawing is the property of PSEG Long Island and is not to be used for any other project without the written consent of PSEG Long Island.

**SANDHW11**  
**PSEG Existing Facilities**  
PSEG Long Island  
175 East Old Country Road

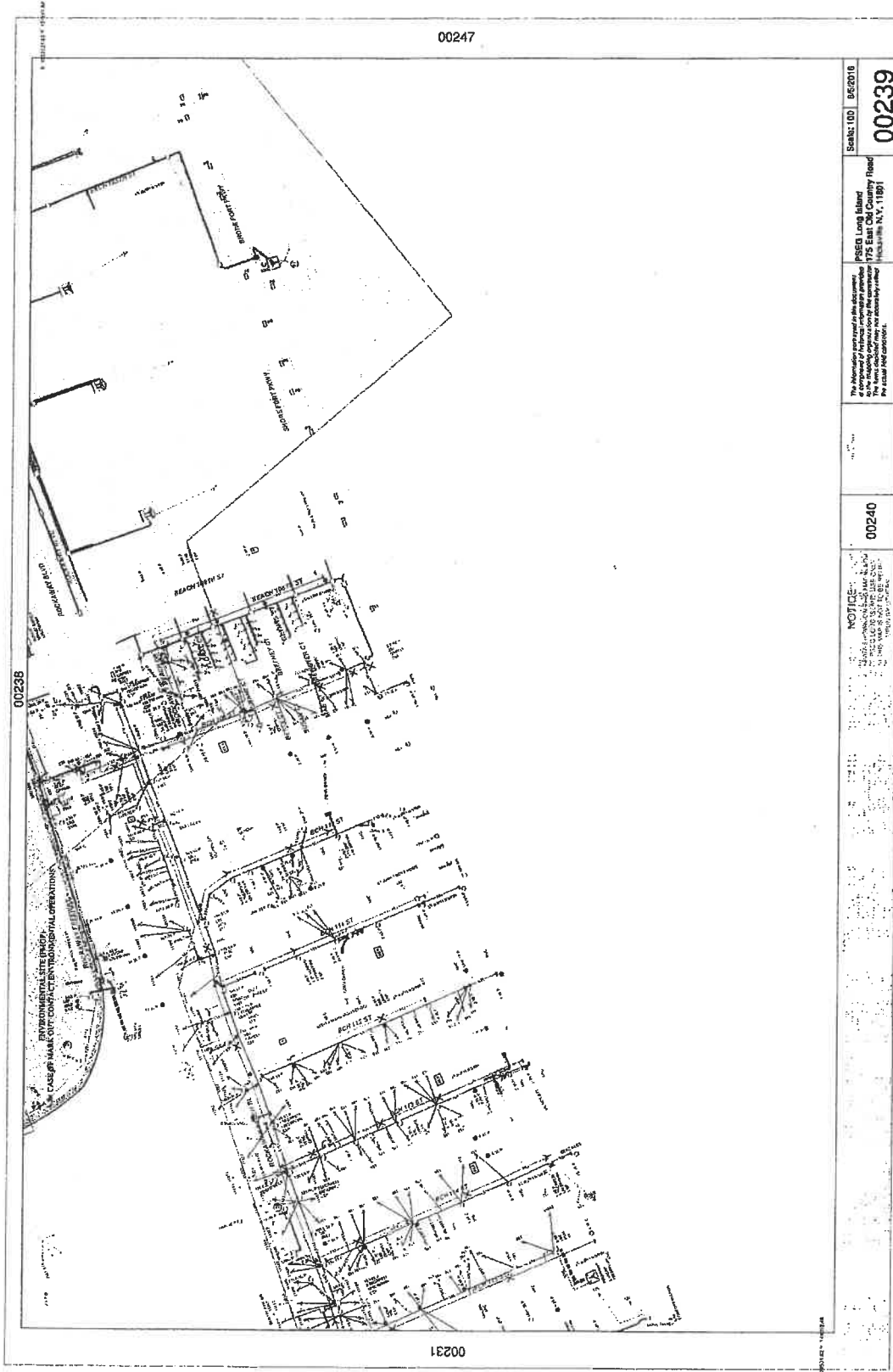

**SANDHW11**  
**PSEG Existing Facilities**  
 PSEG Long Island  
 175 East Old Country Road

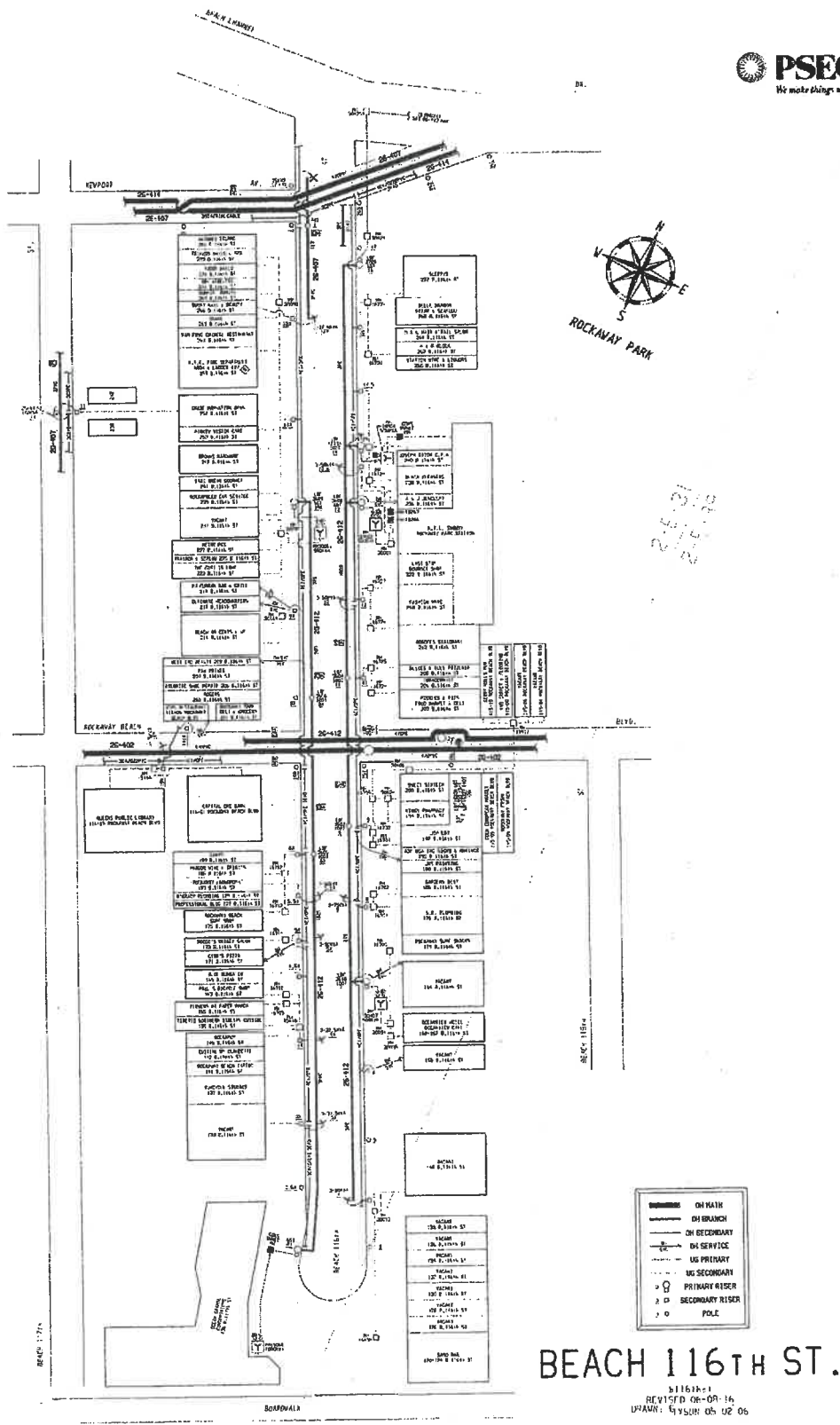

**SANDHW11**  
**PSEG Existing Facilities**  
 PSEG Long Island  
 175 East Old Country Road

**BEACH 116TH ST.**

111611-1  
 REVISED 06-08-16  
 DRAWN: 4/520R 05 02 06

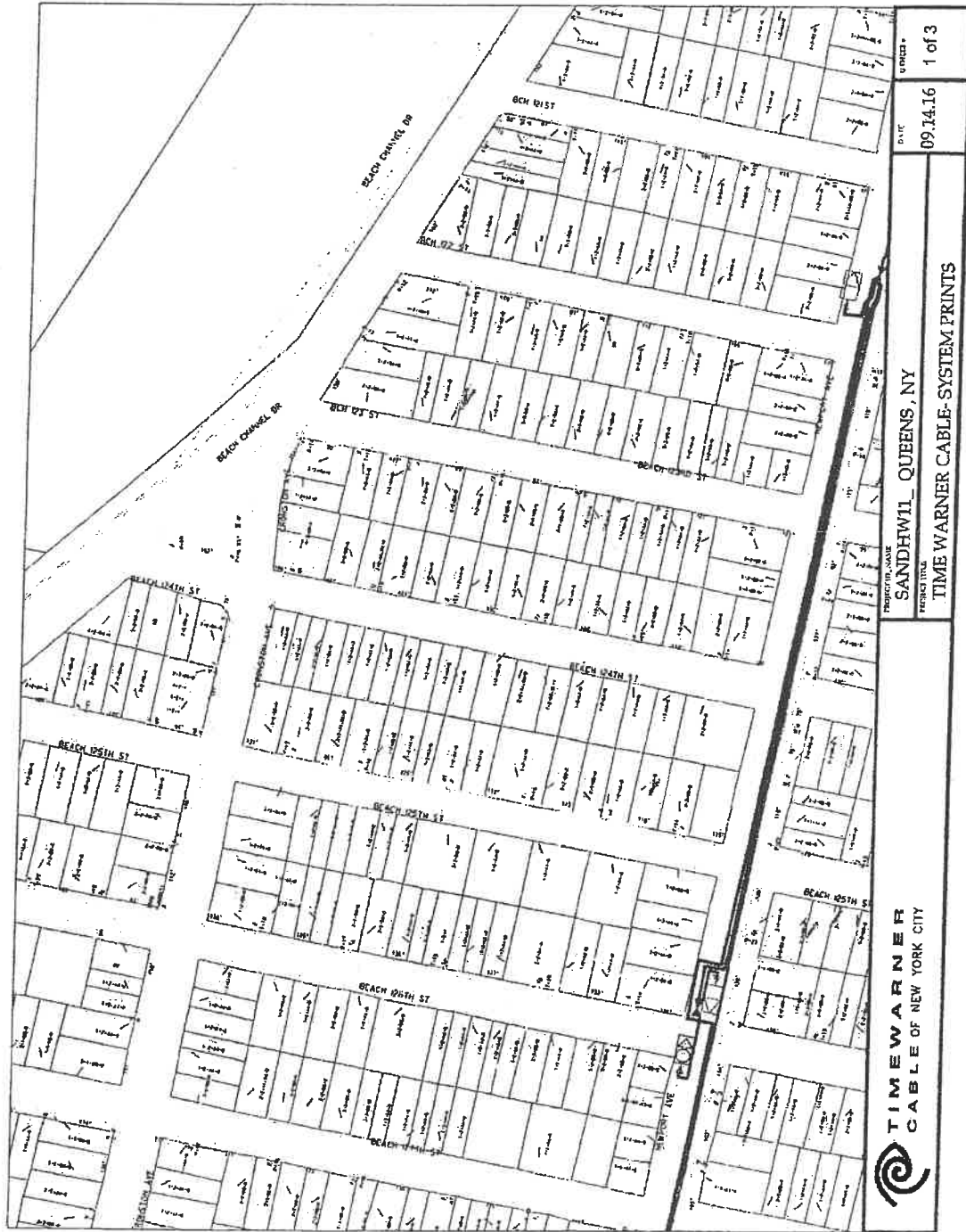

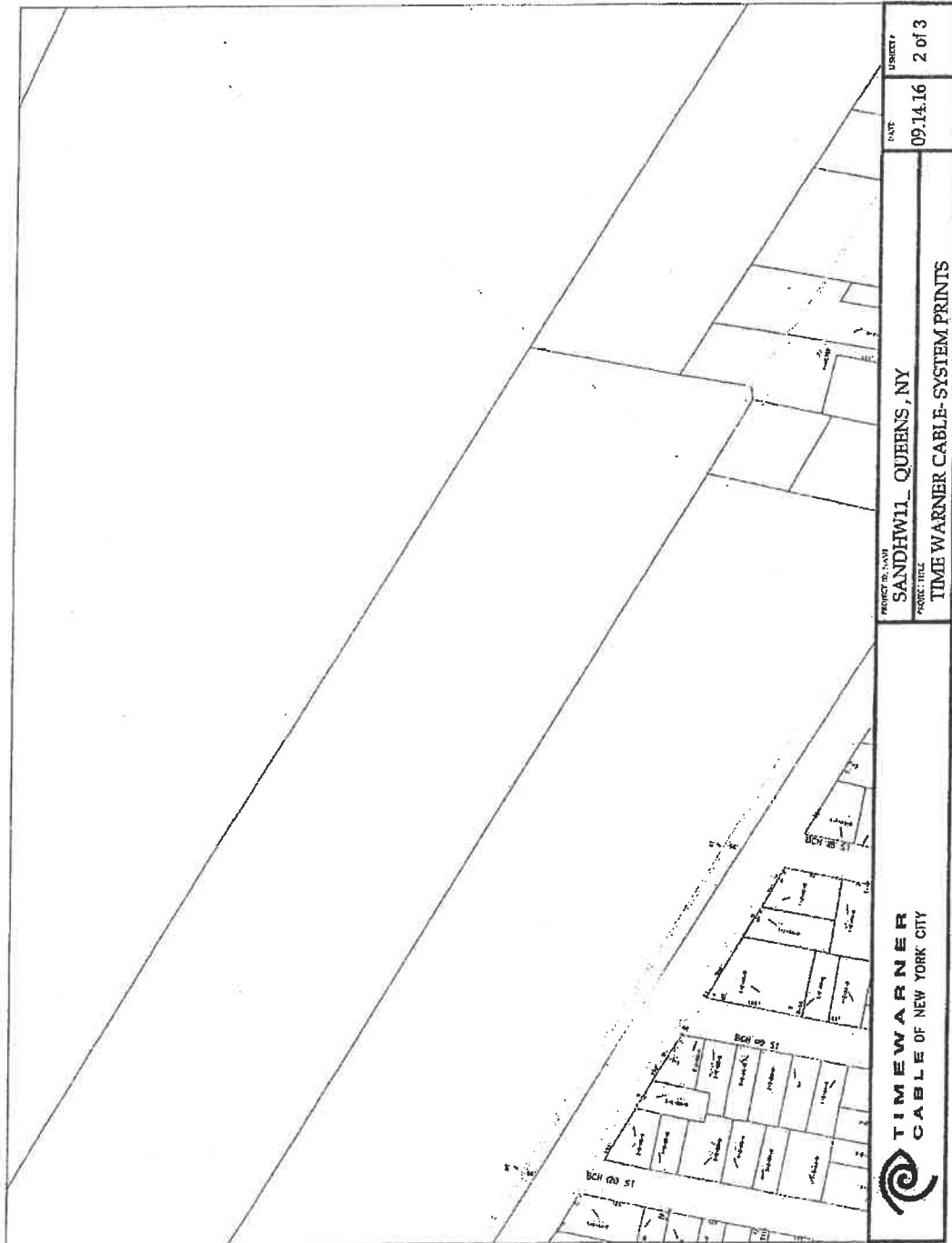

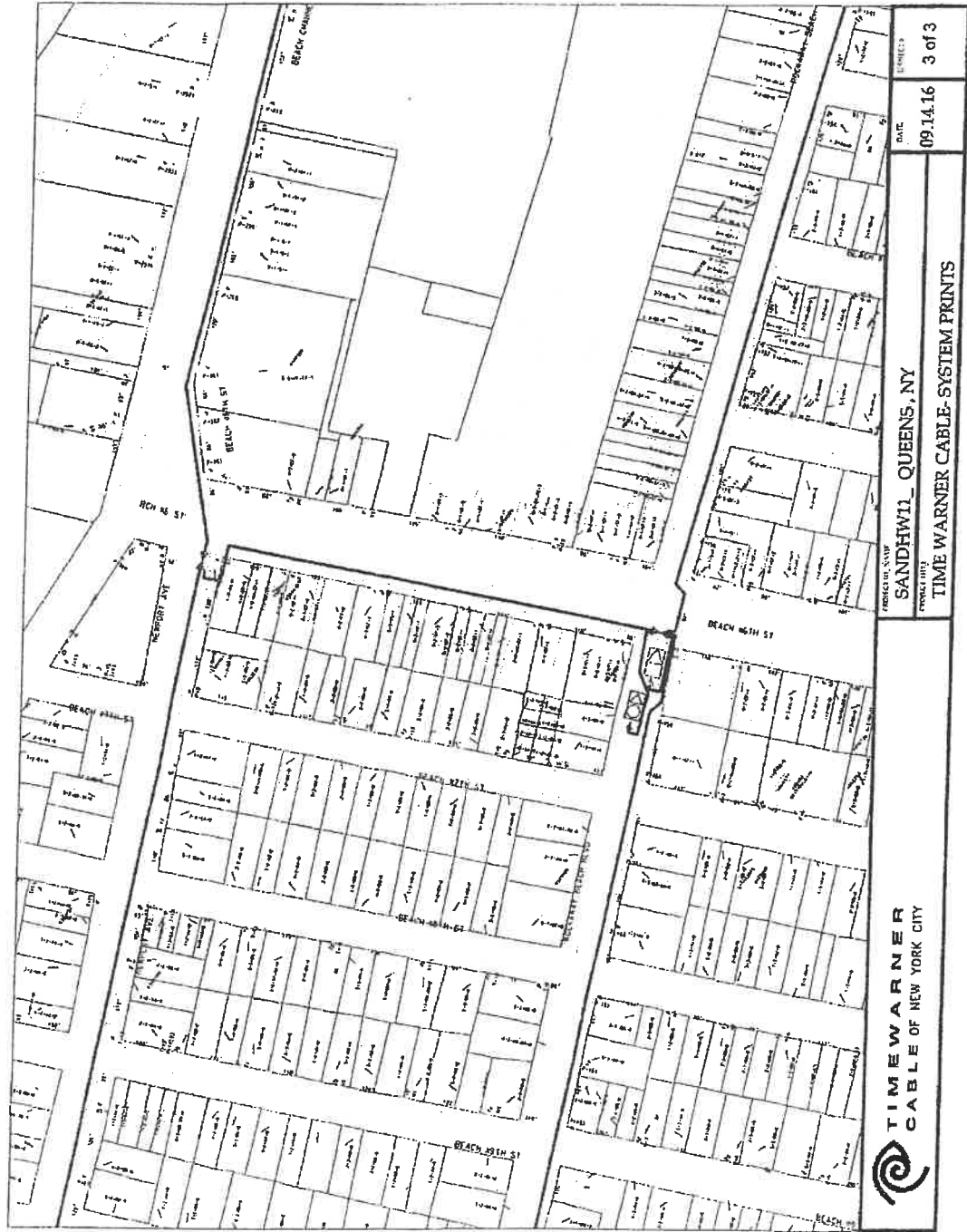

# TEST PITS

- (1) **THESE TEST PITS DETAIL EXISTING CONDITIONS (AS OF BID DATE) OF UTILITIES AND OTHER SUBSURFACE FACILITIES AT LOCATIONS AS SHOWN ON THE TEST PIT LOCATIONS PLAN OF THE CONTRACT DRAWINGS.**
  
- (2) **DEPTHS OF FACILITIES ARE FROM EXISTING ROADWAY AND SIDEWALK ELEVATIONS AS SHOWN, OFFSETS ARE FROM EXISTING CURB, PROPERTY AND BUILDING LINES, AS SHOWN.**
  
- (3) **RELEVANT ITEMS ARE NOTED ON EACH TEST PIT DIAGRAM.**

(NO TEXT IN THIS SECTION)

**verizon** SHEET NO. 1 OF 1

JOB: RECONSTRUCTION OF BEACH CH. DR. PREPARED BY: CHRISTIAN FAVALORA DATE: 11-01-16

JOB NO: SANDHW11 CHECKED BY: ANDREW MATARAZZO DATE: 11-02-16

TEST PIT # 13 LOCATION: ON ROCKAWAY BEACH BOULEVARD BETWEEN

PURPOSE: LOCATE UTILITIES BEACH 116TH STREET AND BEACH 115TH STREET

TRENCH DIMENSIONS  
 6'-0" X 4'-0" X 3'-6"

**ROCKAWAY BEACH BOULEVARD**

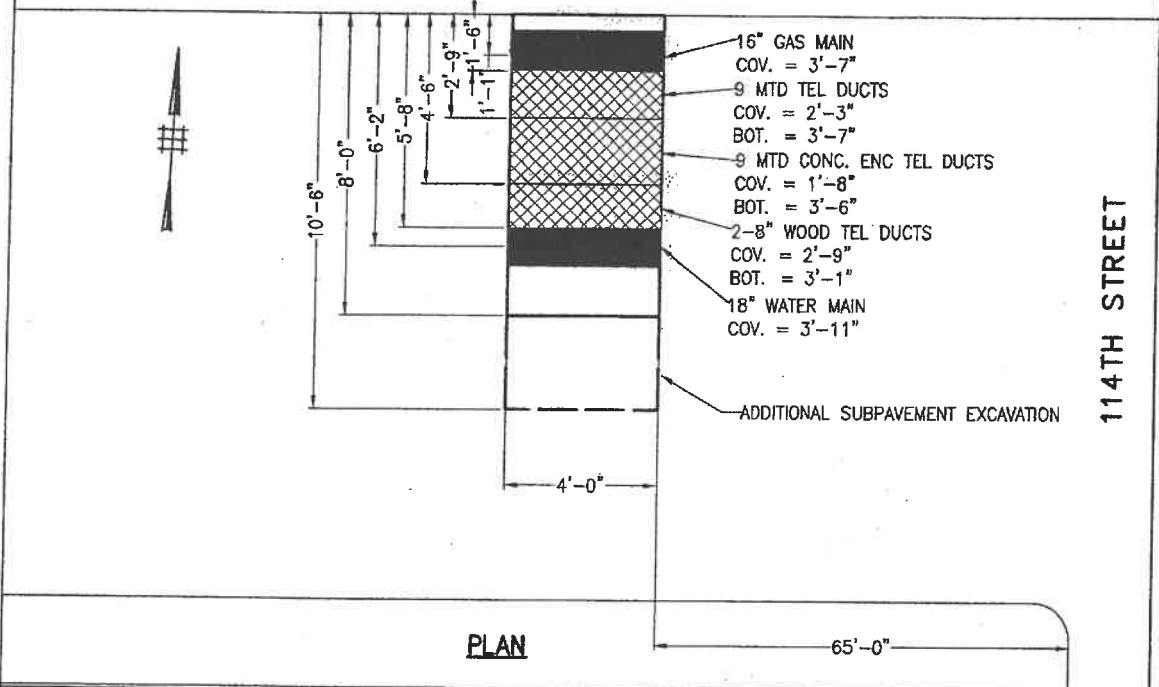

**PLAN**

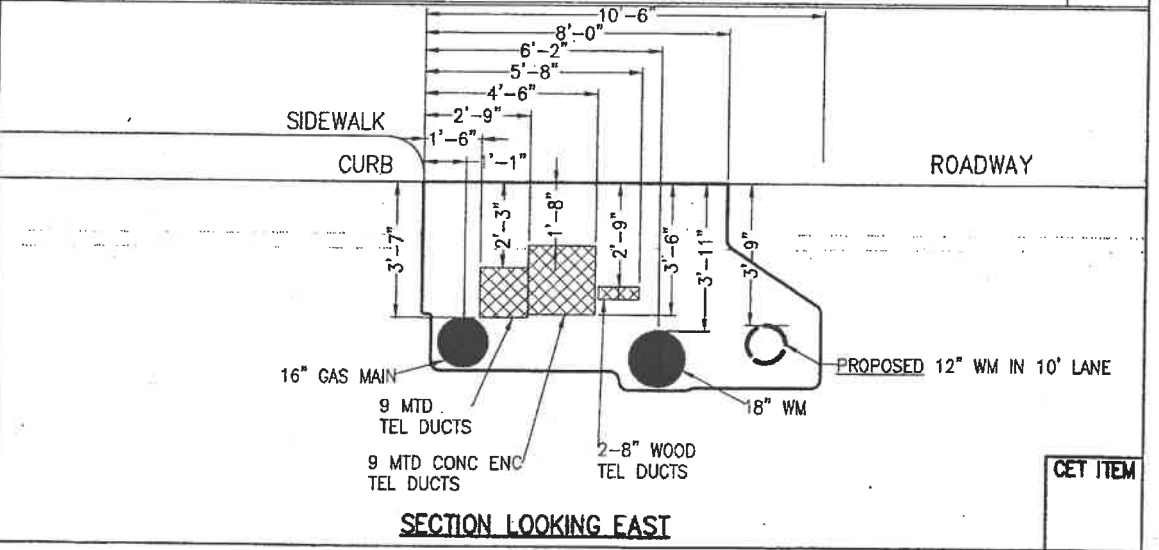

**SECTION LOOKING EAST**

**CET ITEM**



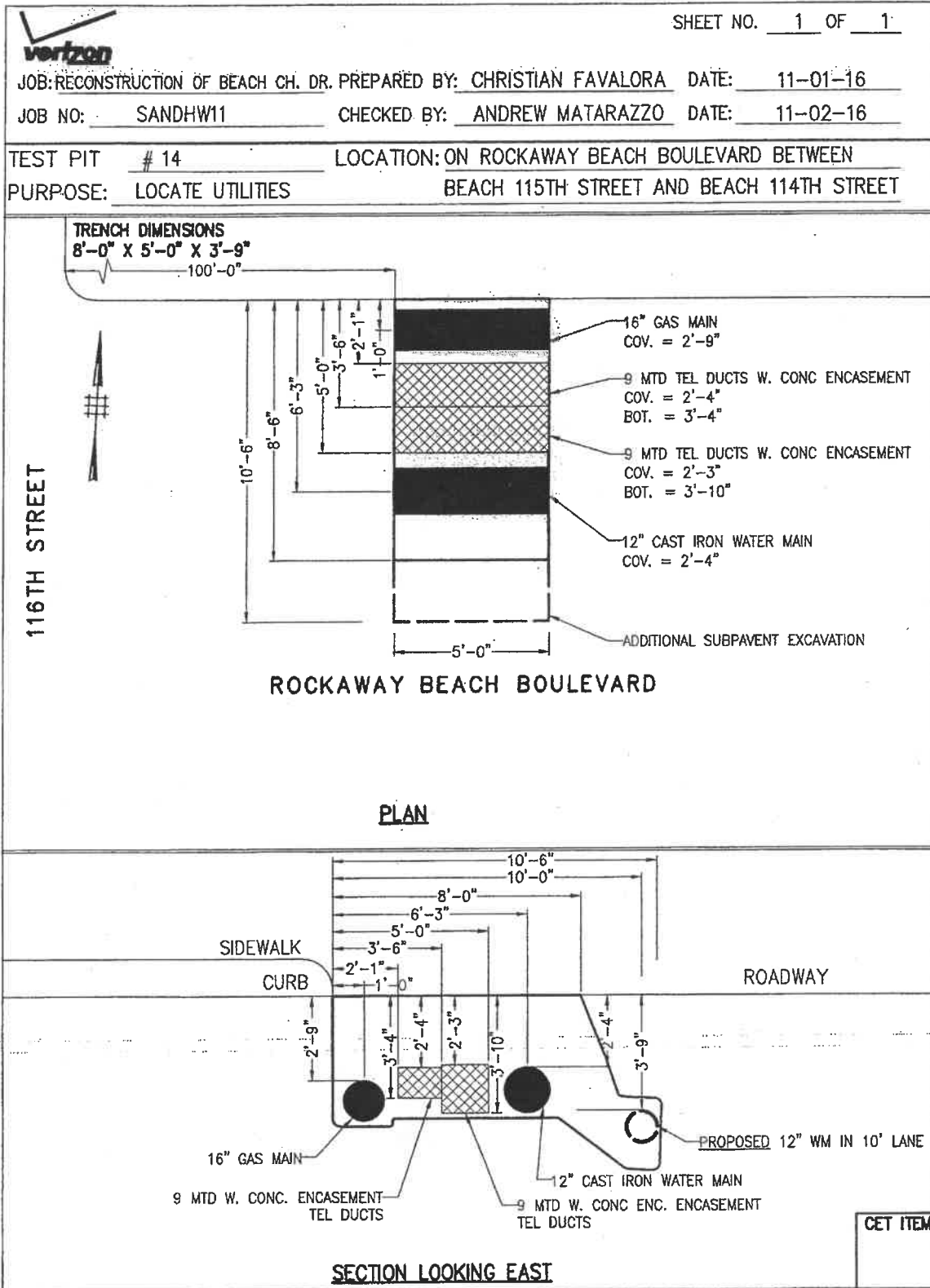

CITY OF NEW YORK  
 DEPARTMENT OF DESIGN AND CONSTRUCTION  
 DIVISION OF INFRASTRUCTURE

# ADDENDA CONTROL SHEET

BID OPENING DATE: April 13, 2017

PROJECT NO.: SANDHW11

DESCRIPTION: RECONSTRUCTION OF BEACH CHANNEL DRIVE (QUEENS)

Addendum		Addendum Contains:				
No.	Date	Revised Bid Date/Time	Revised Bid Schedule	Questions & Responses	Additional Ammendments	Drawings (number)
1	3/24/2017	<input checked="" type="checkbox"/>	<input type="checkbox"/>	<input checked="" type="checkbox"/>	<input type="checkbox"/>	<input type="checkbox"/> (0)
		<input type="checkbox"/>	<input type="checkbox"/>	<input type="checkbox"/>	<input type="checkbox"/>	<input type="checkbox"/> (0)
		<input type="checkbox"/>	<input type="checkbox"/>	<input type="checkbox"/>	<input type="checkbox"/>	<input type="checkbox"/> (0)
		<input type="checkbox"/>	<input type="checkbox"/>	<input type="checkbox"/>	<input type="checkbox"/>	<input type="checkbox"/> (0)
		<input type="checkbox"/>	<input type="checkbox"/>	<input type="checkbox"/>	<input type="checkbox"/>	<input type="checkbox"/> (0)
		<input type="checkbox"/>	<input type="checkbox"/>	<input type="checkbox"/>	<input type="checkbox"/>	<input type="checkbox"/> (0)
		<input type="checkbox"/>	<input type="checkbox"/>	<input type="checkbox"/>	<input type="checkbox"/>	<input type="checkbox"/> (0)
		<input type="checkbox"/>	<input type="checkbox"/>	<input type="checkbox"/>	<input type="checkbox"/>	<input type="checkbox"/> (0)
		<input type="checkbox"/>	<input type="checkbox"/>	<input type="checkbox"/>	<input type="checkbox"/>	<input type="checkbox"/> (0)
		<input type="checkbox"/>	<input type="checkbox"/>	<input type="checkbox"/>	<input type="checkbox"/>	<input type="checkbox"/> (0)
		<input type="checkbox"/>	<input type="checkbox"/>	<input type="checkbox"/>	<input type="checkbox"/>	<input type="checkbox"/> (0)
		<input type="checkbox"/>	<input type="checkbox"/>	<input type="checkbox"/>	<input type="checkbox"/>	<input type="checkbox"/> (0)
		<input type="checkbox"/>	<input type="checkbox"/>	<input type="checkbox"/>	<input type="checkbox"/>	<input type="checkbox"/> (0)

The Table above is a guide. Refer to the referenced Addendum for specific information.



ATTACH TO CONTRACT DOCUMENTS

THE CITY OF NEW YORK  
DEPARTMENT OF DESIGN AND CONSTRUCTION  
INFRASTRUCTURE DIVISION  
BUREAU OF DESIGN

PROJECT ID: SANDHW11

RECONSTRUCTION OF

BEACH CHANNEL DRIVE  
BETWEEN BEACH 116TH STREET AND BEACH 124TH STREET

INCLUDING SEWER, WATER MAIN, YAFFIC SIGNAL  
AND STREET LIGHTING WORK

Together With All Work Incidental Thereto

BOROUGH OF QUEENS  
CITY OF NEW YORK

ADDENDUM NO. 1

DATED: March 24, 2017

THIS ADDENDUM IS HEREBY MADE A PART OF THE CONTRACT DOCUMENTS

1. Refer to the Bid and Contract Documents, VOLUME 1 OF 3, Attachment 1 - Bid Information on Page A-1;  
Change the dates shown for Submission of Bids and for Bid Opening from "March 31, 2017" to read "April 13, 2017".
2. Refer to the Bid and Contract Documents, VOLUME 1 OF 3, SCHEDULE B - M/WBE Utilization Plan on Page 13;  
Change the date shown for Bid/Proposal Response Date from from "March 31, 2017" to read "April 13, 2017"
3. For additional information, see the attached ONE (1) page of "Questions Submitted by Bidders and DDC's Responses".

END OF ADDENDUM NO. 1

By signing in the space provided below, the bidder acknowledges receipt of this Addendum consisting of ONE (1) page and ONE (1) page Attachment.

THIS ADDENDUM MUST BE SIGNED BY ALL BIDDERS AND ATTACHED TO THEIR BID

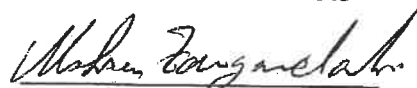

MOHSEN ZARGARELAHI, P.E.  
Assistant Commissioner

\_\_\_\_\_  
Name of Bidder

By: \_\_\_\_\_



Questions Submitted by Bidders and DDC's Responses

QUESTION #1: There are Buy America requirements in this bid according to Attachment E in Book 3. However, in the Bid Submission Requirements in Book 1, there is no requirement for a Buy America Certification, and there is no form for this in any of the books. Please advise.

DDC'S RESPONSE: Buy America certification is not required to be submitted with the bid for projects funded with FHWA funds. Refer to TF-Pages Attachment "E" in Volume 3 for certification and reporting requirements throughout the execution of the contract.

QUESTION #2: Please clarify whether precast concrete manholes, precast concrete catch basins, and reinforced concrete pipe require domestic steel reinforcement, including rebar or wire mesh.

DDC'S RESPONSE: "Buy America" applies to all iron and steel used as permanent materials on the contract, regardless of the material's intended use, including reinforcement for concrete structures.



CITY OF NEW YORK  
DEPARTMENT OF DESIGN AND CONSTRUCTION  
DIVISION OF INFRASTRUCTURE

## ADDENDA CONTROL SHEET

BID OPENING DATE: April 13, 2017

PROJECT NO.: SANDHW11

DESCRIPTION: RECONSTRUCTION OF BEACH CHANNEL DRIVE (QUEENS)

Addendum		Addendum Contains:				
No.	Date	Revised Bid Date/Time	Revised Bid Schedule	Questions & Responses	Additional Ammendments	Drawings (number)
1	3/24/2017	<input checked="" type="checkbox"/>	<input type="checkbox"/>	<input checked="" type="checkbox"/>	<input type="checkbox"/>	<input type="checkbox"/> (0)
2	4/03/2017	<input type="checkbox"/>	<input type="checkbox"/>	<input type="checkbox"/>	<input checked="" type="checkbox"/>	<input type="checkbox"/> (0)
		<input type="checkbox"/>	<input type="checkbox"/>	<input type="checkbox"/>	<input type="checkbox"/>	<input type="checkbox"/> (0)
		<input type="checkbox"/>	<input type="checkbox"/>	<input type="checkbox"/>	<input type="checkbox"/>	<input type="checkbox"/> (0)
		<input type="checkbox"/>	<input type="checkbox"/>	<input type="checkbox"/>	<input type="checkbox"/>	<input type="checkbox"/> (0)
		<input type="checkbox"/>	<input type="checkbox"/>	<input type="checkbox"/>	<input type="checkbox"/>	<input type="checkbox"/> (0)
		<input type="checkbox"/>	<input type="checkbox"/>	<input type="checkbox"/>	<input type="checkbox"/>	<input type="checkbox"/> (0)
		<input type="checkbox"/>	<input type="checkbox"/>	<input type="checkbox"/>	<input type="checkbox"/>	<input type="checkbox"/> (0)
		<input type="checkbox"/>	<input type="checkbox"/>	<input type="checkbox"/>	<input type="checkbox"/>	<input type="checkbox"/> (0)
		<input type="checkbox"/>	<input type="checkbox"/>	<input type="checkbox"/>	<input type="checkbox"/>	<input type="checkbox"/> (0)
		<input type="checkbox"/>	<input type="checkbox"/>	<input type="checkbox"/>	<input type="checkbox"/>	<input type="checkbox"/> (0)
		<input type="checkbox"/>	<input type="checkbox"/>	<input type="checkbox"/>	<input type="checkbox"/>	<input type="checkbox"/> (0)
		<input type="checkbox"/>	<input type="checkbox"/>	<input type="checkbox"/>	<input type="checkbox"/>	<input type="checkbox"/> (0)

The Table above is a guide. Refer to the referenced Addendum for specific information.



ATTACH TO CONTRACT DOCUMENTS

THE CITY OF NEW YORK  
DEPARTMENT OF DESIGN AND CONSTRUCTION  
INFRASTRUCTURE DIVISION  
BUREAU OF DESIGN

PROJECT ID: SANDHW11

RECONSTRUCTION OF

BEACH CHANNEL DRIVE  
BETWEEN BEACH 116TH STREET AND BEACH 124TH STREET

INCLUDING SEWER, WATER MAIN, YAFFIC SIGNAL  
AND STREET LIGHTING WORK

Together With All Work incidental Thereto

BOROUGH OF QUEENS  
CITY OF NEW YORK

ADDENDUM NO. 2

DATED: April 3, 2017

THIS ADDENDUM IS HEREBY MADE A PART OF THE CONTRACT DOCUMENTS

1. Refer to the Bid and Contract Documents, VOLUME 1 OF 3, BID BOOKLET, "Notices to Bidders";  
Delete Notices to Bidders in its entirety;  
Insert attached "Notices to Bidders".
2. Refer to the Bid and Contract Documents, VOLUME 2 OF 3;  
Delete VOLUME 2 OF 3 in its entirety;  
Insert attached revised VOLUME 2 OF 3.
3. Refer to the Bid and Contract Documents, VOLUME 3 OF 3, SCHEDULE A;  
Delete SCHEDULE A in its entirety;  
Insert attached revised SCHEDULE A.

END OF ADDENDUM NO. 2

By signing in the space provided below, the bidder acknowledges receipt of this Addendum consisting of ONE (1) page and TWO HUNDRED NINETY-NINE (299) pages Attachment.

THIS ADDENDUM MUST BE SIGNED BY ALL BIDDERS AND ATTACHED TO THEIR BID

  
MOHSEN ZARGARELAHI, P.E.  
Assistant Commissioner

\_\_\_\_\_  
Name of Bidder

By: \_\_\_\_\_

# Notices to Bidders

## Pre-Bid Questions (PBQs)

**Please be advised that PBQs should be submitted to the Agency Contact Person (CSB\_projectinquiries@ddc.nyc.gov) at least five (5) business days (by 5:00 PM EST) prior to the bid opening date as indicated in ATTACHMENT 1 - BID INFORMATION, page A-1 and SCHEDULE B, page 13, VOLUME 1 OF 3 of this BID BOOKLET.**

All PBQs must reference the Project ID. If a Bidder has multiple PBQs for the same Project ID, the PBQs must be numbered sequentially, even if they are submitted separately.

## Apprenticeship Program

*If Apprenticeship Program is required as noted on Page 19 of this BID BOOKLET, the following notice applies:*

Please be advised that, pursuant to the authority granted to the City under Labor Law §816-b, the New York City Department of Design and Construction hereby requires that the contractor awarded a contract as a result of this solicitation, and any of its subcontractors with subcontracts worth two million dollars or over, have, prior to entering into such contract or subcontract, apprenticeship agreements appropriate for the type and scope of work to be performed that have been registered with, and approved by, the New York State Commissioner of Labor. In addition, the contractor and its subcontractors will be required to show that such apprenticeship program/s have successfully passed the two year Probation period following the initial registration date of such program/s with the New York State Department of Labor.

The failure to prove, upon request, that these requirements have been met shall result in the contract not being awarded to the contractor or the subcontractor not being approved.

Please be further advised that, pursuant to Labor Law §220, the allowable ratio of apprentices to journeypersons in any craft classification shall not be greater than the ratio permitted to the contractor as to its workforce on any job under the registered apprenticeship program.

# Notices to Bidders

## NYC Construction Loan Pilot Program

The New York City Department of Small Business Services (SBS), in conjunction with the New York Business Development Corporation (NYBDC), have established a **NYC Construction Loan** pilot program to provide prime contractors and subcontractors financing for mobilization costs on certain City construction projects.

Under this initiative, loans are available for early stage mobilization needs such as insurance, labor, supplies and equipment. Bidders are strongly encouraged to visit "Growing Your Business" at [www.nyc.gov/nycbusiness](http://www.nyc.gov/nycbusiness) to learn more about the loan or contact [constructionloan@sbs.nyc.gov](mailto:constructionloan@sbs.nyc.gov) / (212) 513-6444 to obtain details and to determine preliminary eligibility.

A successful loan applicant will be required to make an assignment of its contract (or subcontract) payments to the lender NYBDC until the loan is repaid. If the loan is to a subcontractor, a prime contractor must honor the terms of such an assignment.

A prime contractor may not discriminate against a subcontractor or potential subcontractor by reason of the subcontractor's participation, or nonparticipation, in the NYC Construction loan program.



**Department of  
Design and  
Construction**

**THE CITY OF NEW YORK  
DEPARTMENT OF DESIGN AND CONSTRUCTION  
DIVISION OF INFRASTRUCTURE**

30-30 THOMSON AVENUE  
LONG ISLAND CITY, NEW YORK 11101-3045  
TELEPHONE (718) 391-1000  
WEBSITE [www.nyc.gov/buildnyc](http://www.nyc.gov/buildnyc)

**VOLUME 2 OF 3**

**INFORMATION FOR BIDDERS  
CONTRACT  
PERFORMANCE AND PAYMENT BONDS  
PREVAILING WAGE SCHEDULE**

FOR FURNISHING ALL LABOR AND MATERIALS NECESSARY AND REQUIRED FOR:

FOR THE DEPARTMENT OF TRANSPORTATION  
PREPARED BY

*IN HOUSE DESIGN*

**MARCH 15, 2017**





**CITY OF NEW YORK**

**DEPARTMENT OF  
DESIGN AND CONSTRUCTION  
DIVISION OF INFRASTRUCTURES**

**INFORMATION FOR BIDDERS**

**JUNE 2015**

**(NO TEXT ON THIS PAGE)**

**CITY OF NEW YORK CITY  
DEPARTMENT OF DESIGN AND CONSTRUCTION  
INFORMATION FOR BIDDERS**

**TABLE OF CONTENTS**

SECTION 1.	DESCRIPTION AND LOCATION OF WORK	1
SECTION 2.	TIME AND PLACE FOR RECEIPT OF BIDS	1
SECTION 3.	DEFINITIONS	1
SECTION 4.	INVITATION FOR BIDS AND CONTRACT DOCUMENTS	1
SECTION 5.	PRE-BID CONFERENCE	2
SECTION 6.	AGENCY CONTACT	2
SECTION 7.	BIDDER'S OATH	2
SECTION 8.	EXAMINATION AND VIEWING OF SITE, CONSIDERATION OF OTHER SOURCES OF INFORMATION AND CHANGED CONDITIONS	2
SECTION 9.	EXAMINATION OF PROPOSED CONTRACT	3
SECTION 10.	FORM OF BID	3
SECTION 11.	IRREVOCABILITY OF BID	3
SECTION 12.	ACKNOWLEDGMENT OF AMENDMENTS	4
SECTION 13.	BID SAMPLES AND DESCRIPTIVE LITERATURE	4
SECTION 14.	PROPRIETARY INFORMATION/TRADE SECRETS	4
SECTION 15.	PRE-OPENING MODIFICATION OR WITHDRAWAL OF BIDS	4
SECTION 16.	BID EVALUATION AND AWARD	4
SECTION 17.	LATE BIDS, LATE WITHDRAWALS AND LATE MODIFICATIONS	5
SECTION 18.	WITHDRAWAL OF BIDS.	5
SECTION 19.	MISTAKE IN BIDS	5
SECTION 20.	LOW TIE BIDS	6
SECTION 21.	REJECTION OF BIDS	6
SECTION 22.	RIGHT TO APPEAL DETERMINATIONS OF NON-RESPONSIVENESS OR NON-RESPONSIBILITY AND RIGHT TO PROTEST SOLICITATIONS AND AWARD	7
SECTION 23.	AFFIRMATIVE ACTION AND EQUAL EMPLOYMENT OPPORTUNITY	7
SECTION 24.	VENDEX QUESTIONNAIRES	7
SECTION 25.	COMPLAINTS ABOUT THE BID PROCESS	8
SECTION 26.	BID, PERFORMANCE AND PAYMENT SECURITY	8
SECTION 27.	FAILURE TO EXECUTE CONTRACT	9
SECTION 28.	BIDDER RESPONSIBILITIES AND QUALIFICATIONS	9
SECTION 29.	EMPLOYMENT REPORT	10
SECTION 30.	LABOR LAW REQUIREMENTS	10
SECTION 31.	INSURANCE	10
SECTION 32.	LUMP SUM CONTRACTS	11
SECTION 33.	UNIT PRICE CONTRACTS	11
SECTION 34.	EXCISE TAX	11
SECTION 35.	LICENSES AND PERMITS	11
SECTION 36.	MULTIPLE PRIME CONTRACTORS	11
SECTION 37.	LOCALLY BASED ENTERPRISE REQUIREMENTS (LBE)	12
SECTION 38.	BID SUBMISSION REQUIREMENTS	13
SECTION 39.	COMPTROLLER'S CERTIFICATE	14
SECTION 40.	PROCUREMENT POLICY BOARD RULES	14
SECTION 41.	DDC SAFETY REQUIREMENTS	14



**(NO TEXT ON THIS PAGE)**

## INFORMATION FOR BIDDERS

### 1. Description and Location of Work

The description and location of the work for which bids are requested are specified in Attachment 1, "Bid Information". Attachment 1 is included as page A-1 of the Bid Booklet.

### 2. Time and Place for Receipt of Bids

Sealed bids shall be received on or before the date and hour specified in Attachment 1, at which time they will be publicly opened and read aloud in the presence of the Commissioner or his or her representative, and any bidders who may desire to be present.

### 3. Definitions

The definitions set forth in the Procurement Policy Board Rules shall apply to this Invitation For Bids.

### 4. Invitation For Bids and Contract Documents

(A) Except for titles, sub-titles, headings, running headlines, tables of contents and indices (all of which are printed herein merely for convenience) the following, except for such portions thereof as may be specifically excluded, shall be deemed to be part of the Contract and the Invitation for Bids.

- (1) All provisions required by law to be inserted in this Contract, whether actually inserted or not
- (2) The Contract Drawings and Specifications
- (3) The General Conditions, the General Requirements and the Special Conditions, if any
- (4) The Contract
- (5) The Information for Bidders; Request for Proposals; Notice of Solicitation and Proposal For Bids; Bid or Proposal, and, if used, the Bid Booklet
- (6) The Budget Director's Certificate; all Addenda issued prior to the receipt of the bids; the Notice of Award; Performance and Payment Bonds, if required; and the Notice to Proceed with the Work.

(B) For particulars as to this procurement, including quantity and quality of the purchase, extent of the work or labor to be performed, delivery and performance schedule, and any other special instructions, prospective bidders are referred to the Invitation For Bids Documents. A copy of such documents can be obtained at the location set forth in Attachment 1.

(C) Deposit for Copy of Invitation For Bids Documents: Prospective bidders may obtain a copy of the Invitation For Bids Documents by complying with the conditions set forth in the Notice of Solicitation. The deposit must be in the form of a check or money order made payable to the City of New York, and drawn upon a state or national bank or trust company, or a check of such bank or trust company signed by a duly authorized officer thereof.

(D) Return of Invitation For Bids Documents: All Invitation For Bids Documents must be returned to the Department upon request. If the bidder elects not to submit a bid thereunder, the

Invitation For Bids Documents shall be returned to the Department, along with a statement that no bid will be submitted.

(E) Return of Deposit: Such deposit will be returned within 30 days after the award of the contract or the rejection of all bids as set forth in the advertisement, provided the Invitation For Bids Documents are returned to the location specified in Attachment 1, in physical condition satisfactory to the Commissioner.

(F) Additional Copies: Additional copies of the Invitation For Bids Documents may be obtained, subject to the conditions set forth in the advertisement for bids.

5. Pre-Bid Conference

A pre-bid conference shall be held as set forth in Attachment 1. Nothing stated at the pre-bid conference shall change the terms or conditions of the Invitation For Bids Documents, unless a change is made by written amendment as provided in Section 9 below. Failure to attend a mandatory pre-bid conference shall constitute grounds for the rejection of the bid.

6. Agency Contact

Any questions or correspondence relating to this bid solicitation shall be addressed to the Agency Contact person specified in Attachment 1.

7. Bidder's Oath

(A) The bid shall be properly signed by an authorized representative of the bidder and the bid shall be verified by the written oath of the authorized representative who signed the bid, that the several matters stated and information furnished therein are in all aspects true.

(B) A materially false statement willfully or fraudulently made in connection with the bid or any of the forms completed and submitted with the bid may result in the termination of any Contract between the City and the Bidder. As a result, the Bidder may be barred from participating in future City contracts as well as be subject to possible criminal prosecution.

8. Examination and Viewing of Site

(A) Pre-Bidding (Investigation) Viewing of Site - Bidders must carefully view and examine the site of the proposed work, as well as its adjacent area, and seek other usual sources of information, for they will be conclusively presumed to have full knowledge of any and all conditions on, about or above the site relating to or affecting in any way the performance of the work to be done under the Contract which were or should have been indicated to a reasonably prudent bidder. To arrange a date for visiting the work site, bidders are to contact the Agency Contact person specified in Attachment 1.

(B) Should the contractor encounter during the progress of the work subsurface conditions at the site materially differing from any shown on the Contract Drawings or indicated in the Specifications or such subsurface conditions as could not reasonably have been anticipated by the contractor and were not anticipated by the City, which conditions will materially affect the cost of the work to be done under the

Contract, the attention of the Commissioner must be called immediately to such conditions before they are disturbed. The Commissioner shall thereupon promptly investigate the conditions. If he finds that they do so materially differ, or that they could not have been reasonably anticipated by the contractor and were not anticipated by the City, the Contract may be modified with his written approval.

9. Examination of Proposed Contract

(A) Request for Interpretation or Correction: Prospective bidders must examine the Contract Documents carefully and before bidding must request the Commissioner in writing for an interpretation or correction of every patent ambiguity, inconsistency or error therein which should have been discovered by a reasonably prudent bidder. Such interpretation or correction, as well as any additional contract provisions the Commissioner may decide to include, will be issued in writing by the Commissioner as an addendum to the Contract, which will be transmitted to each person recorded as having received a copy of the Contract Documents from the Department. Transmission of such addendum will be by mail, e-mail, facsimile or hand delivery. Such addendum will also be posted at the place where the Contract Documents are available for the inspection of prospective bidders. Upon transmission as provided for herein, such addendum shall become a part of the Contract Documents, and binding on all bidders, whether or not actual notice of such addendum is shown.

(B) Only Commissioner's Interpretation or Correction Binding: Only the written interpretation or correction so given by the Commissioner shall be binding, and prospective bidders are warned that no other officer, agent or employee of the City is authorized to give information concerning, or to explain or interpret, the Contract.

(C) Documents given to a subcontractor for the purpose of soliciting the subcontractor's bid shall include either a copy of the bid cover sheet or a separate information sheet setting forth the project name, the Contract number (if available), the contracting agency and the Project's location.

10. Form of Bid

Each bid must be submitted upon the prescribed form and must contain: a) the name, residence and place of business of the person or persons making the same; b) the names of all persons interested therein, and if no other person is so interested, such fact must be distinctly stated; c) a statement to the effect that it is made without any connection with any other person making a bid for the same purpose and that it is in all respects fair and without collusion or fraud; d) a statement that no Council member or other officer or employee or person whose salary is payable in whole or part from the City Treasury is directly or indirectly interested therein or in the supplies, materials or equipment and work or labor to which it relates, or in any portion of the profits thereof; e) a statement that the bidder is not in arrears to the City or to any agency upon a debt or contract or taxes, and is not a defaulter as surety or otherwise upon any obligation to the City to any agency thereof, except as set forth in the bid.

THE BID SHALL BE TYPEWRITTEN OR WRITTEN LEGIBLY IN INK. THE BID SHALL BE SIGNED IN INK. ERASURES OR ALTERATIONS SHALL BE INITIALED BY THE SIGNER IN INK. FAILURE TO CONFORM TO THE REQUIREMENTS OF THIS SECTION 10 SHALL RESULT IN THE REJECTION OF THE BID.

11. Irrevocability of Bid

The prices set forth in the bid cannot be revoked and shall be effective until the award of the Contract, unless the bid is withdrawn as provided for in Sections 15 and 18 below.

12. Acknowledgment of Amendments

The receipt of any amendment to the Contract Documents shall be acknowledged by the bidder in its bid submission.

13. Bid Samples and Descriptive Literature

Bid samples and descriptive literature shall not be submitted by the bidder, unless expressly requested elsewhere in the Contract or Contract Documents. Any unsolicited bid samples or descriptive literature which are submitted shall not be examined or tested and shall not be deemed to vary any of the provisions of this Contract.

14. Proprietary Information/Trade Secrets

(A) The bidder shall identify those portions of the bid which it deems to be confidential, proprietary information or trade secrets, and provide justification why such materials shall not be disclosed by the City. All such materials shall be clearly indicated by stamping the pages on which such information appears, at the top and bottom thereof with the word "Confidential". Such materials stamped "Confidential" must be easily separable from the non-confidential sections of the bid.

(B) All such materials so indicated shall be reviewed by the Agency and any decision not to honor a request for confidentiality shall be communicated in writing to the bidder. For those bids which are unsuccessful, all such confidential materials shall be returned to the bidder. Prices, makes and model or catalog numbers of the items offered, deliveries, and terms of payment shall be publicly available after bid opening, regardless of any designation of confidentiality made by the bidder.

15. Pre-Opening Modification or Withdrawal of Bids

Bids may be modified or withdrawn by written notice received in the office designated in Attachment 1, before the time and date set for the bid opening. If a bid is withdrawn in accordance with this Section, the bid security, if any, shall be returned to the bidder.

16. Bid Evaluation and Award

In accordance with the New York City Charter, the Procurement Policy Board Rules and the terms and conditions of this Invitation For Bids, this Contract shall be awarded, if at all, to the responsible bidder whose bid meets the requirements and evaluation criteria set forth in the Invitation For Bids, and whose bid price is either the most favorable bid price or, if the Invitation For Bids so states, the most favorable evaluated bid price. A bid may not be evaluated for any requirement or criterion that is not disclosed in the Invitation For Bids.

Restriction: No negotiations with any bidder shall be allowed to take place except under the circumstances and in the manner set forth in Section 21. Nothing in this Section shall be deemed to permit a contract award to a bidder submitting a higher quality item than that designated in the Invitation For Bids, if that bid is not also the most favorable bid.

17. Late Bids, Late Withdrawals and Late Modifications

Any bid received at the place designated in the solicitation after the time and date set for receipt of bids is late and shall not be considered. Any request for withdrawal or modification received at the place designated in the solicitation after the time and date set for receipt of bids is late and shall not be considered. The exception to this provision is that a late modification of a successful bid that makes the bid terms more favorable to the City shall be considered at any time it is received.

18. Withdrawal of Bids

Except as provided for in Section 15, above, a bidder may not withdraw its bid before the expiration of forty-five (45) days after the date of the opening of bids; thereafter, a bidder may withdraw its bid only in writing and in advance of an actual award. If within sixty (60) days after the execution of the Contract, the Commissioner fails to fix the date for commencement of work by written notice to the bidder, the bidder, at his option, may ask to be relieved of his obligation to perform the work called for by written notice to the Commissioner. If such notice is given to the Commissioner, and the request to withdraw is granted, the bidder waives all claims in connection with this Contract.

19. Mistake in Bids

(A) Mistake Discovered Before Bid Opening: A bidder may correct mistakes discovered before the time and date set for bid opening by withdrawing or correcting the bid as provided in Section 15 above.

(B) Mistakes Discovered Before Award

(1) In accordance with General Municipal Law (Section 103, subdivision .11), where a unilateral error or mistake is discovered in a bid, such bid may be withdrawn upon written approval of the Agency Chief Contracting Officer if the following conditions are met:

- (a) The mistake is known or made known to the agency prior to the awarding of the Contract or within 3 days after the opening of the bid, whichever period is shorter; and
- (b) The price bid was based upon an error of such magnitude that enforcement would be unconscionable; and
- (c) The bid was submitted in good faith and the bidder submits credible evidence that the mistake was a clerical error as opposed to a judgment error; and
- (d) The error in the bid is actually due to an unintentional and substantial arithmetic error or an unintentional omission of a substantial quantity of work, labor, material or services made directly in the compilation of the bid, which unintentional arithmetic error or unintentional omission can be clearly shown by objective evidence drawn from inspection of the original work paper, documents, or materials used in the preparation of the bid sought to be withdrawn; and
- (e) It is possible to place the agency in the same position as existed prior to the bid.

(2) Unless otherwise required by law, the sole remedy for a bid mistake in accordance with this Article shall be withdrawal of the bid, and the return of the bid bond, or other security, if any, to the bidder. Thereafter, the agency may, in its discretion, award the Contract to the next lowest bidder or rebid the Contract. Any amendment to or reformation of a bid or a Contract to rectify such an error or mistake

therein is strictly prohibited.

(3) If the mistake and the intended correct bid are clearly evident on the face of the bid document, the bid shall be corrected to the intended correct bid and may not be withdrawn. Examples of mistakes that may be corrected are typographical errors, errors in extending unit prices, transposition errors and arithmetical errors.

20. Low Tie Bids

(A) When two or more low responsive bids from responsible bidders are identical in price, meeting all the requirements and criteria set forth in the Invitation For Bids, the Agency Chief Contracting Officer will break the tie in the following manner and order of priority:

- (1) Award to a certified New York City small, minority or woman-owned business entity bidder;
- (2) Award to a New York City bidder;
- (3) Award to a certified New York State small, minority or woman-owned business bidder;
- (4) Award to a New York State bidder.

(B) If two or more bidders still remain equally eligible after application of paragraph (A) above, award shall be made by a drawing by lot limited to those bidders. The bidders involved shall be invited to attend the drawing. A witness shall be present to verify the drawing and shall certify the results on the bid tabulation sheet.

21. Rejection of Bids

(A) Rejection of Individual Bids: The Agency may reject a bid if:

- (1) The bidder fails to furnish any of the information required pursuant to Section 24 or 28 hereof; or if
- (2) The bidder is determined to be not responsible pursuant to the Procurement Policy Board Rules; or if
- (3) The bid is determined to be non-responsive pursuant to the Procurement Policy Board Rules; or if
- (4) The bid, in the opinion of the Agency Chief Contracting Officer, contains unbalanced bid prices and is thus non-responsive, unless the bidder can show that the prices are not unbalanced for the probable required quantity of items, or if the imbalance is corrected pursuant to Section 15.

(B) Rejection of All Bids: The Agency, upon written approval by the Agency Chief Contracting Officer, may reject all bids and may elect to resolicit bids if in its sole opinion it shall deem it in the best interest of the City so to do.

(C) Rejection of All Bids and Negotiation With All Responsible Bidders: The Agency Head may determine that it is appropriate to cancel the Invitation For Bids after bid opening and before award and to complete the acquisition by negotiation. This determination shall be based on one of the following reasons:

- (1) All otherwise acceptable bids received are at unreasonable prices, or only one bid is received and the Agency Chief Contracting Officer cannot determine the reasonableness of the bid price, or no responsive bid has been received from a responsible bidder; or
  - (2) In the judgment of the Agency Chief Contracting Officer, the bids were not independently arrived at in open competition, were collusive, or were submitted in bad faith.
- (D) When the Agency has determined that the Invitation for Bids is to be canceled and that use of negotiation is appropriate to complete the acquisition, the contracting officer may negotiate and award the Contract without issuing a new solicitation, subject to the following conditions:
- (1) prior notice of the intention to negotiate and a reasonable opportunity to negotiate have been given by the contracting officer to each responsible bidder that submitted a bid in response to the Invitation for Bids;
  - (2) the negotiated price is the lowest negotiated price offered by a responsible bidder; and
  - (3) the negotiated price is lower than the lowest rejected bid price of a responsible bidder that submitted a bid in response to the Invitation for Bids.

22. Right to Appeal Determinations of Non-Responsiveness or Non-Responsibility and Right to Protest Solicitations and Award

The bidder has the right to appeal a determination of non-responsiveness or non-responsibility and has the right to protest a solicitation and award. For further information concerning these rights, the bidder is directed to the Procurement Policy Board Rules.

23. Affirmative Action and Equal Employment Opportunity

This Invitation For Bids is subject to applicable provisions of Federal, State and Local Laws and executive orders requiring affirmative action and equal employment opportunity.

24. VENDEX Questionnaires

(A) Requirement: Pursuant to Administrative Code Section 6-116.2 and the PPB Rules, bidders may be obligated to complete and submit VENDEX Questionnaires. Generally, if this bid is \$100,000 or more, or if this bid when added to the sum total of all contracts, concessions and franchises the bidder has received from the City and any subcontracts received from City contractors over the past twelve months, equals or exceeds \$100,000, Vendex Questionnaires must be completed. If required, Vendex Questionnaires must be completed and submitted before any award of contract may be made or before approval is given for a proposed subcontractor. Non-compliance with these submission requirements may result in the disqualification of the bid, disapproval of a subcontractor, subsequent withdrawal of approval for the use of an approved subcontractor, or the cancellation of the contract after its award.

(B) Submission: Vendex Questionnaires must be submitted directly to the Mayor's Office of Contract Services, ATTN: Vendex, 253 Broadway, 9th Floor, New York, New York 10007. In addition, the bidder must submit a Confirmation of Vendex Compliance to the agency. A form for this confirmation is set forth in the Bid Booklet.

(C) Obtaining Forms: Vendex Questionnaires, as well as detailed instructions, may be obtained at [www.nyc.gov/vendex](http://www.nyc.gov/vendex). The bidder may also obtain Vendex forms and instructions by contacting the



Agency Chief Contracting Office or the contract person for this contract.

25. Complaints About the Bid Process

The New York City Comptroller is charged with the audit of contracts in New York City. Any vendor who believes that there has been unfairness, favoritism or impropriety in the bid process should inform the Comptroller, Office of Contract Administration, One Centre Street, Room 835, New York, New York; telephone number (212)669-2797.

26. Bid, Performance and Payment Security

(A) Bid Security: Each bid must be accompanied by bid security in an amount and type specified in Attachment 1 (page A-1 of the Bid Booklet). The bid security shall assure the City of New York of the adherence of the bidder to its proposal, the execution of the Contract, and the furnishing of Performance and Payment Bonds by the bidder, if required in Attachment 1. Bid security shall be returned to the bidder as follows:

- (1) Within ten (10) days after the bid opening, the Comptroller will be notified to return the deposits of all but the three (3) lowest bidders. Within five (5) days after the award, the Comptroller will be notified to return the deposits of the remaining two unsuccessful bidders.
- (2) Within five (5) days after the execution of the Contract and acceptance of the Contractor's bonds, the Comptroller will be notified to return the bid security of the successful bidder or, if performance and payment bonds are not required, only after the sum retained under Article 21 of the Contract equals the amount of the bid security.
- (3) Where all bids are rejected, the Comptroller will be notified to return the deposit of the three (3) lowest bidders at the time of rejection.

(B) Performance and Payment Security: Performance and Payment Security must be provided in an amount and type specified in Attachment 1 (page A-1 of the Bid Booklet). The performance and payment security shall be delivered by the contractor prior to or at the time of execution of the Contract. If a contractor fails to deliver the required performance and payment security, its bid security shall be enforced, and an award of Contract may be made to the next lowest responsible and responsive bidder, or the contract may be rebid.

(C) Acceptable Types of Security: Acceptable types of security for bids, performance, and payment shall be limited to the following:

- (1) a one-time bond in a form satisfactory to the City;
- (2) a bank certified check or money order;
- (3) obligations of the City of New York; or
- (4) other financial instruments as determined by the Office of Construction in consultation with the Comptroller.

Whenever the successful bidder deposits obligations of the City of New York as performance and payment security, the Comptroller may sell and use the proceeds thereof for any purpose for which the principal or surety on such bond would be liable under the terms of the Contract. If the money is deposited with the Comptroller, the successful bidder shall not be entitled to receive interest on such money from the City.

(D) Form of Bonds: Security provided in the form of bonds must be prepared on the form of bonds authorized by the City of New York. Forms for bid, performance, and payment bonds are included in the Invitation for Bids Documents. Such bonds must have as surety thereunder such surety company or companies as are: (1) approved by the City of New York; (2) authorized to do business in the State of New York, and (3) approved by the Department of the Treasury of the United States. Premiums for any required bonds must be included in the base bid.

The bidder is advised that submission of a bid bond where the surety on such bond fails to meet the criteria set forth herein, shall result in the rejection of the bid as non-responsive.

The Department of the Treasury of the United States advises that information concerning approved surety companies may be obtained as follows: (1) from the Government Printing Office at 202-512-1800; (2) through the Internet at <http://www.fms.treas.gov/c570/index.html>, and (3) through a computerized public bulletin board, which can be accessed by using your computer modem and dialing 202-874-6887.

(E) Power of Attorney: Attorneys in fact who sign bid, performance, or payment bonds must file with each bond a certified copy of their power of attorney to sign said bonds.

27. Failure to Execute Contract

In the event of failure of the successful bidder to execute the Contract and furnish the required security within ten (10) days after notice of the award of the Contract, the deposit of the successful bidder or so much thereof as shall be applicable to the amount of the award made shall be retained by the City, and the successful bidder shall be liable for and hereby agrees to pay on demand the difference between the price bid and the price for which such Contract shall be subsequently awarded, including the cost of any required reletting and less the amount of such deposit. No plea of mistake in such accepted bid shall be available to the bidder for the recovery of the deposit or as a defense to any action based upon such accepted bid. Further, should the bidder's failure to comply with this Section cause any funding agency, body or group (Federal, State, City, Public, Private, etc.) to terminate, cancel or reduce the funding on this project, the bidder in such event shall be liable also to the City for the amount of actual funding withdrawn by such agency on this project, less the amount of the forfeited deposit.

28. Bidder Responsibilities and Qualifications

(A) Bidders must include with their bids all information necessary for a determination of bidder responsibility, as set forth in the Specifications.

(B) The Agency may require any bidder or prospective bidder to furnish all books of account, records, vouchers, statements or other information concerning the bidder's financial status for examination as may be required by the Agency to ascertain the bidder's responsibility and capability to perform the Contract. If required, a bidder must also submit a sworn statement setting forth such information as the Agency may require concerning present and proposed plant and equipment, the personnel and qualifications of his working organizations, prior experience and performance record.

(C) Oral Examination on Qualifications: In addition thereto, and when directed by the Agency, the bidder, or a responsible officer, agent or employee of the bidder, must submit to an oral examination to be conducted by the Agency in relation to his proposed tentative plan and schedule of

operations, and such other matters as the Agency may deem necessary in order to determine the bidder's ability and responsibility to perform the work in accordance with the Contract. Each person so examined must sign and verify a stenographic transcript of such examination noting thereon such corrections as such person may desire to make.

(D) If the bidder fails or refuses to supply any of the documents or information set forth in paragraph (B) hereof or fails to comply with any of the requirements thereof, the Agency may reject the bid.

29. Employment Report

In accordance with Executive Order No. 50 (1980) as modified by Executive Order 108 (1986), the filing of a completed Employment Report (ER) is a requirement of doing business with the City of New York for construction contractors with contracts of \$1,000,000 or more and subcontractors with construction subcontracts of \$750,000 or more. The required forms and information are included in the Bid Booklet.

30. Labor Law Requirements

(A) General: The successful bidder will be required to comply strictly with all Federal, State and local labor laws and regulations.

(B) New York State Labor Law: This Contract is subject to New York State Labor Law Section 220, which requires that construction workers on the site be paid prevailing wages and supplements. The Contractor is reminded that all wage provisions of this Contract will be enforced strictly and failure to comply will be considered when evaluating performance. Noncompliance may result in the contractor being debarred by the City from future contracts. Complaints filed with the Comptroller may result in decisions which may debar a contractor from bidding contracts with any state governmental entity and other political subdivisions.

(C) Records: The Contractor is expected to submit accurate payroll reports and other required documents and verify attendance and job classifications being utilized in compliance with the law, Contract provisions and agency procedures.

31. Insurance

(A) Bidders are advised that the insurance requirements contained herein are regarded as material terms of the Contract. As required by Article 22 of the Contract, the contractor must effect and maintain with companies licensed and authorized to do business in the State of New York, the types of insurance set forth therein, when required by and in the amounts set forth in Schedule A of the General Conditions. Such required insurance must be provided from the date the contractor is ordered to commence work and up to the date of final acceptance of all required work.

(B) The contractor must, within ten days of receipt of the notice of award, submit the following insurance documentation: (a) original certificate of insurance for general liability in the amount required by Schedule A of the General Conditions, and (b) original certificates of insurance or other proof of coverage for workers' compensation and disability benefits, as required by Section 57 of the New York State Workers' Compensation Law and Section 220 of the Disability Benefits Law.

32. Lump Sum Contracts

(A) Comparison of Bids: Bids on Lump Sum Contracts will be compared on the basis of the lump sum price bid, adjusted for alternate prices bid, if any.

(B) Lump Sum Bids for "General Construction Work" which include excavation shall include all necessary excavation work defined in the Specifications as being included in the lump sum bid. The bidder shall also bid a unit price for the additional cost of excavating material which is defined in the Specifications as excavation for which additional payment will be made. The total estimated additional cost of removing such material will be taken as the quantity set forth in the Engineer's Estimate multiplied by the unit price bid. This total estimated cost of additional excavation shall be added to the lump sum bid for the General Construction Work for the purpose of comparing bids to determine the low bidder.

(C) Variations from Engineer's Estimate: The Engineer's Estimate of the quantity of excavation for which additional payment will be made is approximate only and is given solely to be used as a uniform basis for the comparison of bids and such estimate is not to be considered as part of this contract. The quantities actually required to complete the contract work may be more or less than the quantities in the Engineer's Estimate and, if so, no action for damages or for loss of profits shall accrue to the contractor by reason thereof.

33. Unit Price Contracts

(A) Comparison of Bids: Bids on Unit Price Contracts will be compared on the basis of a total estimated price, arrived at by taking the sum of the estimated quantities of such items, in accordance with the Engineer's Estimate of Quantities set forth in the Bid Schedule, multiplied by the corresponding unit prices, and including any lump sum bids on individual items.

(B) Variations from Engineer's Estimate: Bidders are warned that the Engineer's Estimate of Quantities on the various items of work and materials is approximate only, given solely to be used as a uniform basis for the comparison of bids, and is not to be considered part of this contract. The quantities actually required to complete the contract work may be less or more than so estimated, and if so, no action for damages or for loss of profits shall accrue to the contractor by reason thereof.

(C) Overruns: The terms and conditions applicable to overruns of unit price items are set forth in Article 26 of the Contract.

34. Excise Tax

Bidders are referred to the Specifications for information on Federal Excise Tax exemptions.

35. Licenses and Permits

The successful bidder will be required to obtain all necessary licenses and permits necessary to perform the work.

36. Multiple Prime Contractors

If more than one prime contractor will be involved on this project, all contractors are required to examine the Invitation for Bid packages for all other parts of the project.

**37. Locally Based Enterprise Requirements (LBE)**

This Contract is subject to the requirements of Administrative Code, Section 6-108.1, and the regulations promulgated thereunder. No construction contract will be awarded unless and until these requirements have been complied with in their entirety. The bidder is advised of the provisions set forth below, as well as the provisions with respect to the Locally Based Enterprise Program contained in Article 67 of the Contract. The contractor is advised that:

- (A) If any portion of the Contract is subcontracted, not less than ten percent of the total dollar amount of the contract shall be awarded to locally based enterprises ("LBEs"); except, where less than ten percent of the total dollar amount of the Contract is subcontracted, such lesser percentage shall be so awarded.
- (B) No contractor shall require performance and payment bonds from LBE subcontractors.
- (C) No Contract shall be awarded unless the contractor first identifies in its bid:
  - (1) the percentage, dollar amount and type of work to be subcontracted; and
  - (2) the percentage, dollar amount and type of work to be subcontracted to LBEs.
- (D) Within ten calendar days after notification of low bid, the apparent low bidder shall submit an "LBE Participation Schedule" to the contracting agency. If such schedule does not identify sufficient LBE subcontractors to meet the requirements of Administrative Code Section 6-108.1, the apparent low bidder shall submit documentation of its good faith efforts to meet such requirements.
  - (1) The "LBE Participation Schedule" shall include:
    - (a) the name and address of each LBE that will be given a subcontract,
    - (b) the percentage, dollar amount and type of work to be subcontracted to the LBE, and
    - (c) the dates when the LBE subcontract work will commence and end.
  - (2) The following documents shall be attached to the "LBE Participation Schedule":
    - (a) verification letters from each subcontractor listed in the "LBE Participation Schedule" stating that the LBE will enter into a formal agreement for work,
    - (b) certification documents of any proposed LBE subcontractor which is not on the LBE certified list, and
    - (c) copies of the certification letter of any proposed subcontractor which is an LBE.
  - (3) Documentation of good faith efforts to achieve the required LBE percentage shall include as appropriate but not limited to the following:
    - (a) attendance at prebid meetings, when scheduled by the agency, to advise bidders of contract requirements;

- (b) advertisement where appropriate in general circulation media, trade association publications and small business media of the specific subcontracts that would be at least equal to the percentage goal for LBE utilization specified by the contractor;
- (c) written notification to association of small, minority and women contractors soliciting specific subcontractors;
- (d) written notification by certified mail to LBE firms that their interest in the contract is solicited for specific work items and their estimated values;
- (e) demonstration of efforts made to select portions of the work for performance by LBE firms in order to increase the likelihood of achieving the stated goal;
- (f) documented efforts to negotiate with LBE firms for specific subcontracts, including at a minimum:
  - (i) The names, address and telephone numbers of LBE firms that are contacted;
  - (ii) A description of the information provided to LBE firms regarding the plans and specifications for portions of the work to be performed;
  - (iii) Documentation showing that no reasonable price can be obtained from LBE firms;
  - (iv) A statement of why agreements with LBE firms were not reached;
- (g) a statement of the reason for rejecting any LBE firm which the contractor deemed to be unqualified; and
- (h) documentation of efforts made to assist the LBE firms contacted that needed assistance in obtaining required insurance.

(E) Unless otherwise waived by the Commissioner with the approval of the Office of Economic and Financial Opportunity, failure of a proposed contractor to provide the information required by paragraphs (C) and (D) above may render the bid non-responsive and the Contract may not be awarded to the bidder. If the contractor states that it will subcontract a specific portion of the work, but can demonstrate despite good faith efforts it cannot achieve its required LBE percentage for subcontracted work until after award of Contract, the Contract may be awarded, subject to a letter of compliance from the contractor stating that it will comply with Administrative Code Section 6-108.1 and subject to approval by the Commissioner. If the contractor has not met its required LBE percentage prior to award, the contractor shall demonstrate that a good faith effort has been made subsequent to award to obtain LBEs on each subcontract until it meets the required percentage.

(F) When a bidder indicates prior to award that no work will be subcontracted, no work may be subcontracted without the prior written approval of the Commissioner, which shall be granted only if the contractor in good faith seeks LBE subcontractors at least six weeks prior to the start of work.

(G) The contractor may not substitute or change any LBE which was identified prior to award of the contract without the written permission of the Commissioner. The contractor shall make a written application to the Commissioner for permission to make such substitution or change, explaining why the contractor needs to change its LBE subcontractor and how the contractor will meet its LBE subcontracting requirement. Copies of such application must be served on the originally identified LBE by certified mail return receipt requested, as well as the proposed substitute LBE. The Commissioner shall determine whether or not to grant the contractor's request for substitution.

### 38. Bid Submission Requirements

The following forms, all of which are contained in the Bid Booklet, are to be completed and submitted with the bid:

- (1) Bid Schedule and Bid Form, including Affirmation
- (2) Bid Security (if required; see Attachment 1 on Page A-1)
- (3) M/WBE Subcontractor Utilization Plan (if participation goals have been established)

**FAILURE TO SUBMIT ITEMS (1), (2) AND (3)  
WILL RESULT IN THE DISQUALIFICATION OF THE BID.**

- (4) Safety Questionnaire
- (5) Construction Employment Report (if bid is \$1,000,000 or more)
- (6) Contract Certificate (if bid is less than \$1,000,000)
- (7) Confirmation of Vendex Compliance
- (8) Special Experience Requirements (if applicable to this contract)
- (9) Apprenticeship Program Questionnaire (if applicable)

**FAILURE TO SUBMIT ITEMS (4) THROUGH (9)  
MAY RESULT IN THE DISQUALIFICATION OF THE BID.**

39. Comptroller's Certificate

This Contract shall not be binding or of any force unless it is registered by the Comptroller in accordance with Section 328 of the City Charter and the Procurement Policy Board Rules. This Contract shall continue in force only after annual appropriation of funds by the City of New York and certification as hereinabove set forth.

40. Procurement Policy Board Rules

This Invitation For Bids is subject to the Rules of the Procurement Policy Board of the City of New York. In the event of a conflict between said Rules and a provision of this Invitation For Bids, the Rules shall take precedence.

41. DDC Safety Requirements

The DDC Safety Requirements apply to the work to be performed pursuant to the Contract. The DDC Safety Requirements are set forth on the following pages.

**CITY OF NEW YORK**  
**DEPARTMENT OF DESIGN AND CONSTRUCTION**  
**SAFETY REQUIREMENTS**

June 2015

---

*THE DDC SAFETY REQUIREMENTS INCLUDE THE FOLLOWING SECTIONS:*

- I. POLICY ON SITE SAFETY
- II. PURPOSE
- III. DEFINITIONS
- IV. RESPONSIBILITIES
- V. SAFETY QUESTIONNAIRE
- VI. SAFETY PROGRAM AND SITE SAFETY PLAN
- VII. KICK-OFF/PRE-CONSTRUCTION MEETINGS AND SAFETY REVIEW
- VIII. EVALUATION DURING WORK IN PROGRESS
- IX. SAFETY PERFORMANCE EVALUATION



City of New York Department of Design and Construction: Safety Requirements  
Safety and Site Support- Quality Assurance and Construction Safety

## I. POLICY ON SITE SAFETY

The City of New York Department of Design and Construction (DDC) is committed to a policy of injury and illness prevention and risk management for construction work that will ensure the safety and health of the workers engaged in the projects and the protection of the general public. Therefore, it is DDC's policy that work carried out by Contractors on DDC jobsites must, at a minimum, comply with applicable federal, state and city laws, rules and regulations, including without limitation:

- U. S. Department of Labor 29 Code of Federal Regulations (CFR) Part 1926 and applicable Sub-parts of Part 1910 – U.S. Occupational Safety and Health Administration (OSHA); New York State Department of Labor Industrial Code Rule 23 – Protection in Construction, Demolition and Excavation;
- New York City Construction Codes, Title 28
- NYC Department of Transportation Title 34 Chapter 2 – Highway Rules
- New York State Department of Labor Industrial Code Rule 16 NYCRR Part 753
- Title 15 of the Rules of the City of New York, Chapter 13 Citywide Construction Dust Mitigation
- Manual on Uniform Traffic Control Devices (MUTCD)
- Title 15 of the Rules of the City of New York, Chapter 28 Citywide Construction Noise Mitigation

## II. PURPOSE

The purpose of this policy is to ensure that Contractors perform their work and supervise their employees in accordance with all applicable federal, state and city rules and regulations. Further, Contractors will be expected to minimize or eliminate jobsite and public hazards, through a planning, inspection, auditing and corrective action process. The goal is to control risks so that injuries, illnesses and accidents to contractors' employees, DDC employees and the general public, as well as damage to city-owned and private property, are reduced to the lowest level feasible.

## III. DEFINITIONS

**Agency Chief Contracting Officer (ACCO):** The ACCO shall mean the person delegated authority by the Commissioner to organize and supervise the procurement activity of subordinate Agency staff in conjunction with the CCPO.

**Competent Person:** As defined by OSHA, an individual who is capable of identifying existing and predictable hazards in the surroundings or working conditions that are unsanitary, hazardous, or dangerous to employees or the general public, and who has authorization to take prompt corrective measures to eliminate them.

**Construction Safety Auditor:** A representative of the QA&CS Construction Safety Unit who provides inspection and assessment services to enhance health and safety on all DDC construction projects. The activities of the Construction Safety Auditor include performing site surveys, reviewing health and safety plans, reviewing construction permits, and rendering technical advice and assistance to DDC Resident Engineers and Project Managers.

**Construction Safety Unit:** A part of QA&CS within the Division of Program Management/ Safety & Site Support that assesses contractor safety on DDC jobsites and advises responsible parties of needed corrective actions.

**City of New York Department of Design and Construction: Safety Requirements  
Safety and Site Support- Quality Assurance and Construction Safety**

**Construction Superintendent:** A representative of the contractor responsible for overseeing performance of the required construction work. This individual must engage in sound construction practices, and is responsible to maintain a safe work site. In the case of a project involving the demolition, alteration or new construction of buildings, the Construction Superintendent must be licensed by the NYC Department of Buildings.

**Contractor:** For purposes of these Safety Requirements, the term "Contractor" shall mean any person or entity that enters into a contract for the performance of construction work on a DDC project. The term "Contractor" shall include any person or entity which enters into any of the following types of contracts: (1) a prime construction contract for a specific project, (2) a prime construction contract using the Job Order Contracting System ("JOCS Contract"); and (3) a subcontract with a CM/Builder ("First Tier Subcontract").

**Daily Safety Job Briefing:** Daily jobsite safety meetings, giving to all jobsite personnel by contractor, with the purpose of discussing project specific safety procedures for the scheduled construction work.

**Director - Quality Assurance and Construction Safety (QA&CS):** Responsible for the operations of the QACS Construction Safety Unit and the DDC Site Safety management programs.

**Job Hazard Analysis (JHA):** A process of identifying the major job steps and any potential site-specific hazards that may be present during construction and establishing the means and methods to eliminate or control those hazards.

**Qualified Person:** As defined by OSHA, an individual who, by possession of a recognized degree, certificate, license or professional standing, or who by extensive knowledge, training, and experience, has successfully demonstrated his or her ability to solve problems relating to the subject matter, the work, or the project. Qualified Persons are required under regulation to address issues pertaining, but without limit, to fall protection, scaffold design and trenching and shoring, among others.

**Project Site:** Those areas indicated in the Contract Documents where the Work is to be performed.

**Project Safety Representative:** The designated project safety representative shall have completed an authorized 30 hour OSHA Construction Safety Course and other safety training applicable to Contractor's/subcontractor's project work. Except in instances where a dedicated Project Safety Manager is required, a Project Safety Representative may also function as a superintendent, foreman or crew leader on the Project, but must have sufficient experience and authority to undertake corrective actions and must qualify to be a competent person. No work is to be performed on site when a Project Safety Representative is not present.

**Project Safety Manager:** A dedicated, full-time project safety manager may be a contractual requirement on large projects or projects deemed by DDC to be particularly high risk. This would be in addition or in lieu of a Contractor's Project Safety Representative. This individual shall not have any other assigned duties. This individual shall have received, at a minimum an authorized 30 hour OSHA Construction Safety Course. Other examples of acceptable training are OSHA Safety and Health Standards for the Construction Industry training program (OSHA 510), Certified Safety Professional (CSP), Certified Industrial Hygienist (CIH), or a degree/certificate in a safety and health from a college-level curriculum.

A Project Safety Manager shall possess the additional training, years of experience, and skills necessary to thoroughly understand the health and safety hazards and controls for large construction projects, including the full scope of the specific Work.

**QA&CS - Quality Assurance and Construction Safety of the New York City Department of Design and Construction.**

**City of New York Department of Design and Construction: Safety Requirements  
Safety and Site Support- Quality Assurance and Construction Safety**

**Resident Engineer (RE) / Construction Project Manager (CPM):** Representative of the Commissioner duly designated by the Commissioner to be his/her representative at the site of the work. (The RE/CPM may be a third-party consultant, including a Construction Management firm, retained by DDC)

**Safety Program:** Established by the Contractor that covers all operations of that Contractor and establishes the Contractor's overall safety policy, regulatory compliance plan and minimum safety standards. The Safety Program must be submitted prior to the commencement of work at the site and is subject to review and acceptance by the Construction Safety Unit.

**Safety Questionnaire:** Used by DDC to evaluate Contractor's current and past safety performance. It is required to be completed by all Contractors initially when submitting bids for Construction work, or when being pre-qualified and updated annually or as requested by the DDC.

**Site Safety Manager:** For certain projects, as defined in NYC Construction Codes – Title 28, the Contractor shall provide a Site Safety Manager with a Site Safety Manager License issued by the NYC Department of Building.

**Site Safety Plan:** A site-specific safety plan developed by the Contractor for a specific project. The Site Safety Plan must identify hazards associated with the project, and include specific safety procedures and training appropriate and necessary to complete the work. The Site Safety Plan must be submitted prior to the commencement of work at the site and is subject to review and acceptance by the Construction Safety Unit.

**Unsafe or Unhealthy Condition:** A condition that could be potentially hazardous to the health and safety of personnel or the public, and/or damaging to equipment, machinery, property or the environment.

**Weekly Safety Meetings:** Weekly documented jobsite safety meetings, given to all jobsite personnel by contractor, with the purpose of discussing general safety topics and job specific requirements encountered at the DDC work site.

**Work:** The construction required by the Contract Documents whether completed or partially completed, performed by the Contractor/ subcontractors. Work refers to the furnishing of labor, furnishing and incorporating materials and equipment into the construction and providing any service required by the Contract Documents to fulfill the Contractor's obligation to complete the Project.

#### **IV. RESPONSIBILITIES**

All persons who manage, perform, and provide support for construction projects shall conduct operations in compliance with the requirements identified in this Policy and all applicable governing regulatory agency requirements and guidelines pertaining to safety in construction.

##### **A. DDC or CM Resident Engineer / Construction Project Manager**

- Monitors the issuance of safety-related permits, approvals and drawings and maintains copies on site.
- Monitors construction-related work activities to confirm that they are conducted in accordance with DDC policies and all applicable regulations that pertain to construction safety.
- Maintains documentation and periodically attends weekly safety meetings and daily safety job briefings.
- Notifies the Construction Safety Unit and the ACCO's Insurance and Risk Management Unit of project-related accidents and emergencies, as per DDC's Construction Safety Emergency and Accident Notification and Response Protocol.
- Gathers facts related to all accidents and prepares DDC Construction Accident Report.

City of New York Department of Design and Construction: Safety Requirements  
Safety and Site Support- Quality Assurance and Construction Safety

- Notifies the Construction Safety Unit within two (2) hours of the start of an inspection by any outside regulatory agency personnel, including OSHA, NYC DOB or others and forwards a copy of the inspection report within three days of its receipt.
- Monitors the conditions at the site for conformance with the contractor's Site Safety Plan and DDC construction documents.
- Notifies the contractor and DDC in the event that any condition or activity exists that is not in compliance with the contractor's Site Safety Plan, applicable federal, state or local codes or any condition that presents a potential risk of injury to the public or workers or possible damage to property.
- Notifies DDC of any unsafe or unhealthy condition and directs the contractor to provide such labor, materials, equipment and supervision to abate such conditions.
- Escort and assist QA&CS Construction Safety Auditors during the field and record inspections.
- Reports emergency conditions to the Construction Safety Unit immediately.

**B. Contractors**

- Submit a completed Safety Questionnaire and other safety performance related documentation with its bid or as part of a pre-qualification package.
- Complete a written Job Hazard Analysis (JHA) that identifies safety hazards for project specific work tasks and hazard control methods. A written JHA shall be available at the site for reference and included in the Site Safety Plan submitted by the contractor.
- Submit a Site Safety Plan and Safety Program within 30 days from the Award Date or as otherwise directed. The Site Safety Plan and Safety Program are subject to review and acceptance by the Construction Safety Unit prior to the commencement of work at the site. The Site Safety Plan shall be revised and updated as necessary.
- Develop project specific safety procedures to protect general public during all construction activities for the duration of the project.
- Ensure that all employees are aware of the hazards associated with the project through documented formal and informal training and/or other communications. Conduct and document weekly safety meetings and daily job briefing sessions for the duration of the project. Documentation to be provided to the RE/CPM on a monthly basis.
- Name the Project Safety Representative and Project Safety Manager, if required. The Contractor will be required to identify the Project Safety Representative and Project Safety Manager in the Site Safety Plan. Resumes, outlining the qualification and experience for the Project Safety Representative and Project Safety Manager, shall be available upon request. DDC reserves the right to request that the Contractor replace any Project Safety Representative or Project Safety Manager for any reason at any time during the project.
- Name a Competent Person(s). The Contractor will be required to identify a Competent Person(s) in the Site Safety Plan.
- Comply with all mandated federal, state and local safety and health rules and regulations.
- Comply with all provisions of the Site Safety Plan.
- Conduct applicable safety training prior to the commencement of work at the site. All training records (OSHA 10-hour, flagger, scaffold, fall protection, confined space entry, etc.) shall be provided to the RE/CPM prior to mobilization, included in the Site Safety Plan, kept current during the course of the project, and available for review. Prior to performing any work on DDC project all employees shall have successfully completed, within the previous five calendar years, a 10 Hour OSHA construction safety course.
- As part of the Site Safety Plan, prepare a site specific programs and plans, such as MPT plan, steel erection plan, confined space program, fall protection plan, demolition plan, etc. (if not otherwise provided in the contract documents) and comply with all of its provisions.
- Conduct and document site-specific safety orientation for Contractor personnel to review the hazards associated with the project as identified in the Site Safety Plan and the specific safety procedures and

City of New York Department of Design and Construction: Safety Requirements  
Safety and Site Support— Quality Assurance and Construction Safety

controls that will be used to protect workers, the general public and property. The Project Safety Representative and/or Project Safety Manager will conduct this training prior to mobilization and provide documentation to the RE/CPM.

- Provide, replace and adequately maintain at or around the project site, suitable and sufficient signage, lights, barricades and enclosures (fences, sidewalk sheds, netting, bracing, etc.).
- Report unsafe or unhealthy conditions to the RE/CPM as soon as practical, but no more than 24 hours after discovery, and take prompt actions to remove or abate such conditions.
- Report any accidents involving injuries to workers or the general public, as well as property damage, to the RE/CPM within one (1) hour.
- Following an accident, the Contractor shall not remove or alter any equipment, structure, material, or evidence related to the accident. Exception: Immediate emergency procedures taken to secure structures, temporary construction, operations, or equipment that pose a continued imminent danger or facilitate assistance for persons who are trapped or who have sustained bodily injury.
- Notify the RE/CPM within one (1) hour of the start of an inspection by any outside regulatory agency personnel, including OSHA, NYC DOB or others.
- Maintain all records pertaining to all required compliance documents and accident and injury reports.
- Address DDC recommendations on safety, which shall in no way relieve the Contractor of its responsibilities for safety on the project. The Contractor has sole responsibility for safety.

#### V. SAFETY QUESTIONNAIRE

DDC requires that all Contractors provide information regarding their current and past safety performance and programs. This will be accomplished by the use of the DDC Safety Questionnaire. As a part of the bid submittal package, the contractor must submit a completed DDC Safety Questionnaire listing company workers' compensation experience modification rating and OSHA Incident Rates for the three (3) years prior to the date of the bid opening. DDC may request a Contractor to update its Questionnaire at any time or to provide more detailed information. The Contractor must provide the requested information within 15 days.

The following criteria will be used by DDC in reviewing the Contractor's responsibility, which will be based on the information provided on the questionnaire:

- Criteria 1: OSHA Injury and Illness Rates (I&IR) are no greater than the average for the industry (based on the most current Bureau of Labor Statistics data for the Contractors SIC code); and
- Criteria 2: Insurance workers compensation Experience Modification Rate (EMR) equal to or less than 1.0; and
- Criteria 3: Any willful violations issued by OSHA or NYC DOB within the last three (3) years; and
- Criteria 4: A fatality (worker or member of public) and injuries, requiring OSHA notification, experienced on or near Contractor's worksite within the last three (3) years; and
- Criteria 5: Past safety performance on DDC projects (accidents; status of safety program and site safety plan submittals; etc.)
- Criteria 6: OSHA violation history for the last three (3) years;
- Criteria 7: Contractor shall provide OSHA Injury and Illness Records (currently OSHA 300 and 300A Logs) for the last three (3) years.

If the Contractor fails to meet the basic criteria listed above, the Construction Safety Unit may request, through the ACCO, more details concerning the Contractor's safety experience. DDC may request the Contractor to provide copies of, among other things, accident investigation reports, OSHA records, OSHA and NYC DOB citations, EPA citations and written corrective action plan.

City of New York Department of Design and Construction: Safety Requirements  
Safety and Site Support- Quality Assurance and Construction Safety

**VI. SAFETY PROGRAM AND SITE SAFETY PLAN**

Within thirty (30) days from the Award Date, or as otherwise directed, the Contractor shall submit the following: (1) Safety Program, and (2) Site Safety Plan. The Safety Program shall set forth the Contractor's overall safety policy, regulatory compliance plan and minimum safety standards. The Site Safety Plan shall identify project work scope, safety hazards associated with the project tasks, and include specific safety procedures and training appropriate and necessary to complete the work. The Safety Program and the Site Safety Plan are subject to review and acceptance by the Construction Safety Unit prior to the commencement of work at the site. Failure by the Contractor to submit an acceptable Site Safety Plan and Safety Program shall be grounds for default.

**Safety Program:** Corporate Safety Program established by the Contractor that includes the Contractor's overall safety policy, regulatory compliance plan and basic safety procedures covering all aspects of construction operations, performed by the Contractor. The Safety Program shall be a written document with a separate section describing each element of the Safety Program. The Safety Program shall have at minimum the following elements applicable to the Contractor's operations:

- Responsibility and Organization - Contractor's company organization chart, including titles, names, contact information, roles and responsibilities for key personnel, etc.
- Safety Training Program - Contractor's corporate training program.
- Hazard Corrective Actions - Criteria for safety inspections, identification of safety non-compliances, implementation and verification of corrective actions, forms to document safety inspections results, etc.
- Accident/Exposure Investigation
- Recordkeeping and Reporting Injuries - Responsible staff; reporting and recording criteria; OSHA 300 and 300A form completion, etc.
- Fire Protection and Prevention Program
- Housekeeping
- Illumination
- Sanitation
- Personal Protective Equipment (PPE) - Company policy for the use of head protection, foot protection, hearing protection, eye and face protection, protective clothing, and any additional protective equipment based on work tasks; PPE inspection and replacement policy.
- Hazard Communication Program
- Employee Emergency Action Plan
- Protection of Underground Facilities and Utilities
- Ionizing/Nonionizing Radiation
- Material Handling, Storage, Use and Disposal
- Tools - Hand and Power
- Signs, Signals, and Barricades
- Scaffold - Local Law 52 requirements, installation, use, inspection, dismantling, training and general safety requirements.
- Welding and Cutting
- Electrical Safety
- Fall Protection
- Cranes, Derricks, Hoists, Elevators, Conveyors
- Excavation Safety
- Concrete and Masonry Construction
- Maintenance and Protection of Traffic
- Steel Erection
- Demolition
- Blasting and the Use of Explosives
- Stairways and Ladders

City of New York Department of Design and Construction: Safety Requirements  
Safety and Site Support- Quality Assurance and Construction Safety

- Toxic and Hazardous Substances
- Alcohol and Drug Abuse Policy
- Rodents and Vermin
- Occupational Noise Exposure
- Confined Space Program – General confined Space Program: training requirements, confined space hazard evaluation procedure, atmospheric testing procedure, confined space classification, permit-required procedure, communication procedure, rescue procedure, forms, etc.
- Construction Vehicles/Heavy Equipment
- Dust Control Procedures

**Site Safety Plan:** The Site Safety Plan shall be a written document and shall apply to all project specific Contractor and subcontractor operations, and shall have at a minimum, the following elements with each element described in a separate section (It may be necessary to modify the basic format for certain unique or high-risk projects, such as tunnels or high-rise construction):

- Project Work Scope – Detailed information regarding work tasks that will be performed by contractor and subcontractors under the project.
- Responsibility and Organization – Contractor's organization chart with responsible staff for the project, including titles, names, contact information, roles and responsibilities.
- Safety Training and Education – OSHA 10 Hours training, requirements for daily safety briefings and weekly safety meetings, any work task specific training, responsible staff for implementation of training program for the project.
- Job Hazard Analysis (JHA) – Project specific Job Hazard Analysis including work tasks, identified hazards, hazard control methods (administrative, engineering, PPE), contractor's name, project id, location, name and signature of a certifying person, hazard assessment date.
- Protection of Public
- Hazard Corrective Actions – Responsible staff, forms, frequency of safety inspections and implementation of corrective actions.
- Accident/Exposure Investigation – Accident/incident notification procedure of DDC project staff. Project specific procedures for accident investigation and implementation of corrective actions.
- First Aid and Medical Attention – Responsible staff, location and inspection of First Aid kit, directions to local hospitals; emergency telephone numbers.
- Project Specific Fire Protection and Prevention Program.
- Project Specific Illumination Procedure.
- Project Specific Sanitation Procedure.
- Personal Protective Equipment (PPE)
- Hazard Communication Program – Responsible staff; training; SDS records, project specific list of chemical; location of the program and SDS records.
- Means of Egress – Information regarding free and unobstructed egress from all parts of the building or structure; exit marking; maintenance of means of egress, etc.
- Employee Emergency Action Plan – Project specific: responsible staff, emergency alarm system, evacuation procedure, procedure to account for employees after evacuation, etc.
- Evacuation Plan – Project specific evacuation plan (drawing/scheme) with exists and evacuation routes.
- Protection of Underground Facilities and Utilities, including responsible staff.
- Ionizing/Nonionizing Radiation – Competent person, license and qualification requirements, type of radiation, employees exposure and protection, etc.
- Material Handling, Storage, Use and Disposal – Project specific information regarding material storage and disposal.
- Signs, Signals, and Barricades – Use of danger/warning signs, sidewalk closure, safety instruction signs, pedestrian fencing and barricades, etc.
- Scaffold – Project specific scaffold types, training, scaffold drawings, competent person, criteria for project specific scaffold, falling object protection.

**City of New York Department of Design and Construction: Safety Requirements  
Safety and Site Support- Quality Assurance and Construction Safety**

- Welding and Cutting – project specific procedure for welding and cutting, including all necessary safety requirements such as fire prevention, personal protective equipment, hot work permits, FDNY certificate requirements.
- Fall Protection – Project specific information regarding selected fall protection systems, fall protection plan.
- Cranes, Derrick, Hoists, Elevators, Conveyors – project specific equipment information including type, rated load capacity, manufacture specification requirements, competent person, exposure to falling load, inspection, recordkeeping, clearance requirements, communication procedure, ground lines, permits.
- Excavation Safety – Competent person, project specific protective system.
- Maintenance and Protection of Traffic Plan – Project specific MPT plan, flagmen training.
- Steel Erection – Site specific erection plan, requirements for applicable written notifications, competent person.
- Demolition – Engineering survey, including written evidence, disconnection of all effected utilities, identification of all hazardous chemicals, materials, gases, etc., floor openings, chutes, inspection and maintenance of all stairs/passageways, removal of materials/debris/structural elements, lock out/tag out, competent person.
- Blasting and the Use of Explosives – Project specific safety procedures, warning signs, training/qualification, transportation, storage and use of explosives, inspection.
- Toxic and Hazardous Substances – Safety procedures for substances to be used on project.
- Noise Mitigation Plan – Completed project specific Noise Mitigation Plan.
- Confined Space Program – Project specific Confined Space Program, responsible staff, training records, equipment information, rescue procedure, list of project specific confined spaces, forms.
- Construction Vehicles/Heavy Equipment – Type of construction vehicles/heavy equipment to be used on site.
- Dust Mitigation Plan – Completed project specific Dust Mitigation Plan.

The most critical component of the Site Safety Plan is the Job Hazard Analysis (JHA) section. The JHA form is a written document prepared by the contractor. The contractor must conduct a site and task assessment JHA to identify the major job steps and any potential safety or environmental hazards related to performance of the work, eliminate or implement controls for the potential hazards, and identify proper personal protective equipment for the task. The JHA shall be communicated to all contractor/subcontractor personnel on site.

The initial Job Hazard Assessment form shall be included in the contractor's Site Safety Plan and the current form shall be available at the construction site for reference.

Certain DDC programs, such as Job Order Contracting System (JOCS), may not necessarily require Site Safety Plans. The JOCS contractor shall submit a Safety Program. The Site Safety Plan requirement for the JOCS contractor will be determined by QA&CS based on a project work scope, construction activities and project location. In addition, certain DDC Operating Units may establish client-specific program or safety requirements. The contractor's Site Safety Plan must address such client-specific program or safety requirements.

## **VII. KICK-OFF MEETINGS/PRE-CONSTRUCTION AND SAFETY REVIEW**

RE/CPM shall invite QA&CS Construction Safety Unit to the construction kick-off meeting. A QA&CS representative will participate in this meeting with the Contractor and RE/CPM prior to the start of the project for the purpose of:

- A. Reviewing the safety issues detailed in the contract.
- B. Reviewing the Site Safety Plan.
- C. Reviewing any new issues or information that was not previously addressed.
- D. Discussing planned inspections and audits of the site by QA&CS personnel.



City of New York Department of Design and Construction: Safety Requirements  
Safety and Site Support- Quality Assurance and Construction Safety

**VIII. EVALUATION DURING WORK IN PROGRESS**

The Contractor's adherence to these Safety Requirements will be monitored throughout the project. This will be accomplished by the following:

- A. Use of a safety checklist by a representative of the Construction Safety Unit or other designated DDC representative or Consultant during regular, unannounced inspections of the job site. Field Exit Conferences will be held with the RE/CPM, Contractor Project Safety Representatives.
- B. The RE/CPM will continually monitor the safety and environmental performance of the contractor's employees and work methods. Deficiencies shall be brought to the attention of the contractor's representative on site for immediate correction. The DDC representative will maintain a written record of these deficiencies and have these records available upon request. Any critical deficiencies shall be immediately reported to QA&CS phone# (718) 391-1624 or (718) 391-1911.
- C. If the Contractor's safety performance during the project is not up to DDC standards (safety performance measure, accident/incident rate, etc.) the Director - QA&CS, or his/her designee will meet with the Contractor's Project Safety Representative and or Project Safety Manager, the DDC Project Manager, the RE/CPM, and the DDC Environmental Specialist (if environmental issues are involved). The purpose of this meeting is to 1) determine the level of non-compliance; 2) explain and clarify the safety/environmental provisions; 3) agree on a future course of action to correct the deficiencies.
- D. If the deficiencies continue to occur with inadequate attention by the contractor, this shall, among other remedies available, be grounds for default.
- E. The contractor shall within 1 hour inform the RE/CPM/CM of all accidents/incidents including all fatalities, any injuries to employees or members of the general public, and property damage (e.g., structural damage, equipment rollovers, utility damage, loads dropped from crane). The RE/CPM shall notify the Construction Safety Unit as per DDC's Construction Safety Emergency and Accident Notification and Response Protocol and shall maintain a record of all contractor accidents/incidents for the project.
- F. The Construction Safety Unit shall be notified within two (2) hours of the start of any NYS-DOL/ NYC-COSH/ OSHA/ EPA inspections.

**IX. SAFETY PERFORMANCE EVALUATION**

The contractor's safety record, including accident/incident history and DDC safety inspection results, will be considered as part of the Contractor's performance evaluation at the conclusion of the project. Poor safety performance during the course of the project shall be a reason to rate a Contractor unsatisfactory which may be reflected in the City's Vendex system and will be considered for future procurement actions as set forth in the City's Procurement Policy Board Rules.

**CITY OF NEW YORK**  
**STANDARD CONSTRUCTION CONTRACT**

**March 2017**

**( NO TEXT ON THIS PAGE )**

**CITY OF NEW YORK  
STANDARD CONSTRUCTION CONTRACT**

**TABLE OF CONTENTS**

CHAPTER I: THE CONTRACT AND DEFINITIONS .....	1
ARTICLE 1. THE CONTRACT .....	1
ARTICLE 2. DEFINITIONS .....	1
CHAPTER II: THE WORK AND ITS PERFORMANCE .....	4
ARTICLE 3. CHARACTER OF THE WORK .....	4
ARTICLE 4. MEANS AND METHODS OF CONSTRUCTION .....	4
ARTICLE 5. COMPLIANCE WITH LAWS .....	5
ARTICLE 6. INSPECTION .....	10
ARTICLE 7. PROTECTION OF WORK AND OF PERSONS AND PROPERTY; NOTICES AND INDEMNIFICATION .....	11
CHAPTER III: TIME PROVISIONS .....	12
ARTICLE 8. COMMENCEMENT AND PROSECUTION OF THE WORK .....	12
ARTICLE 9. PROGRESS SCHEDULES .....	13
ARTICLE 10. REQUESTS FOR INFORMATION OR APPROVAL .....	13
ARTICLE 11. NOTICE OF CONDITIONS CAUSING DELAY AND DOCUMENTATION OF DAMAGES CAUSED BY DELAY .....	14
ARTICLE 12. COORDINATION WITH OTHER CONTRACTORS .....	18
ARTICLE 13. EXTENSION OF TIME FOR PERFORMANCE .....	19
ARTICLE 14. COMPLETION AND FINAL ACCEPTANCE OF THE WORK .....	21
ARTICLE 15. LIQUIDATED DAMAGES .....	23
ARTICLE 16. OCCUPATION OR USE PRIOR TO COMPLETION .....	23
CHAPTER IV: SUBCONTRACTS AND ASSIGNMENTS .....	24
ARTICLE 17. SUBCONTRACTS .....	24
ARTICLE 18. ASSIGNMENTS .....	26
CHAPTER V: CONTRACTOR'S SECURITY AND GUARANTEE .....	26
ARTICLE 19. SECURITY DEPOSIT .....	26
ARTICLE 20. PAYMENT GUARANTEE .....	27
ARTICLE 21. RETAINED PERCENTAGE .....	29
ARTICLE 22. INSURANCE .....	30
ARTICLE 23. MONEY RETAINED AGAINST CLAIMS .....	36
ARTICLE 24. MAINTENANCE AND GUARANTY .....	37
CHAPTER VI: CHANGES, EXTRA WORK, AND DOCUMENTATION OF CLAIM .....	38
ARTICLE 25. CHANGES .....	38
ARTICLE 26. METHODS OF PAYMENT FOR OVERRUNS AND EXTRA WORK .....	38
ARTICLE 27. RESOLUTION OF DISPUTES .....	41
ARTICLE 28. RECORD KEEPING FOR EXTRA OR DISPUTED WORK OR WORK ON A TIME & MATERIALS BASIS .....	45
ARTICLE 29. OMITTED WORK .....	46
ARTICLE 30. NOTICE AND DOCUMENTATION OF COSTS AND DAMAGES; PRODUCTION OF FINANCIAL RECORDS .....	46
CHAPTER VII: POWERS OF THE RESIDENT ENGINEER, THE ENGINEER OR ARCHITECT AND THE COMMISSIONER .....	48
ARTICLE 31. THE RESIDENT ENGINEER .....	48
ARTICLE 32. THE ENGINEER OR ARCHITECT OR PROJECT MANAGER .....	48
ARTICLE 33. THE COMMISSIONER .....	48
ARTICLE 34. NO ESTOPPEL .....	49
CHAPTER VIII: LABOR PROVISIONS .....	49
ARTICLE 35. EMPLOYEES .....	49
ARTICLE 36. NO DISCRIMINATION .....	57
ARTICLE 37. LABOR LAW REQUIREMENTS .....	59

ARTICLE 38. PAYROLL REPORTS .....	64
ARTICLE 39. DUST HAZARDS .....	64
CHAPTER IX: PARTIAL AND FINAL PAYMENTS .....	65
ARTICLE 40. CONTRACT PRICE .....	65
ARTICLE 41. BID BREAKDOWN ON LUMP SUM.....	65
ARTICLE 42. PARTIAL PAYMENTS.....	65
ARTICLE 43. PROMPT PAYMENT.....	66
ARTICLE 44. SUBSTANTIAL COMPLETION PAYMENT.....	66
ARTICLE 45. FINAL PAYMENT.....	67
ARTICLE 46. ACCEPTANCE OF FINAL PAYMENT.....	68
ARTICLE 47. APPROVAL BY PUBLIC DESIGN COMMISSION.....	69
CHAPTER X: CONTRACTOR'S DEFAULT .....	69
ARTICLE 48. COMMISSIONER'S RIGHT TO DECLARE CONTRACTOR IN DEFAULT.....	69
ARTICLE 49. EXERCISE OF THE RIGHT TO DECLARE DEFAULT.....	71
ARTICLE 50. QUITTING THE SITE.....	71
ARTICLE 51. COMPLETION OF THE WORK.....	71
ARTICLE 52. PARTIAL DEFAULT .....	71
ARTICLE 53. PERFORMANCE OF UNCOMPLETED WORK.....	72
ARTICLE 54. OTHER REMEDIES.....	72
CHAPTER XI: MISCELLANEOUS PROVISIONS .....	72
ARTICLE 55. CONTRACTOR'S WARRANTIES.....	72
ARTICLE 56. CLAIMS AND ACTIONS THEREON.....	73
ARTICLE 57. INFRINGEMENT .....	73
ARTICLE 58. NO CLAIM AGAINST OFFICIALS, AGENTS OR EMPLOYEES.....	74
ARTICLE 59. SERVICE OF NOTICES .....	74
ARTICLE 60. UNLAWFUL PROVISIONS DEEMED STRICKEN FROM CONTRACT.....	74
ARTICLE 61. ALL LEGAL PROVISIONS DEEMED INCLUDED .....	74
ARTICLE 62. TAX EXEMPTION .....	74
ARTICLE 63. INVESTIGATION(S) CLAUSE.....	76
ARTICLE 64. TERMINATION BY THE CITY .....	78
ARTICLE 65. CHOICE OF LAW, CONSENT TO JURISDICTION AND VENUE .....	80
ARTICLE 66. PARTICIPATION IN AN INTERNATIONAL BOYCOTT .....	81
ARTICLE 67. LOCALLY BASED ENTERPRISE PROGRAM .....	82
ARTICLE 68. ANTITRUST.....	82
ARTICLE 69. MACBRIDE PRINCIPLES PROVISIONS .....	83
ARTICLE 70. ELECTRONIC FILING/NYC DEVELOPMENT HUB .....	85
ARTICLE 71. PROHIBITION OF TROPICAL HARDWOODS.....	85
ARTICLE 72. CONFLICTS OF INTEREST.....	85
ARTICLE 73. MERGER CLAUSE.....	85
ARTICLE 74. STATEMENT OF WORK.....	85
ARTICLE 75. COMPENSATION TO BE PAID TO CONTRACTOR.....	85
ARTICLE 76. ELECTRONIC FUNDS TRANSFER.....	85
ARTICLE 77. RECORDS RETENTION.....	86
ARTICLE 78. EXAMINATION AND VIEWING OF SITE, CONSIDERATION OF OTHER SOURCES OF INFORMATION AND CHANGED SITE CONDITIONS.....	86

<b>ARTICLE 79: PARTICIPATION BY MINORITY-OWNED AND WOMEN-OWNED BUSINESS ENTERPRISES IN CITY PROCUREMENT .....</b>	<b>87</b>
<b>SIGNATURES .....</b>	<b>95</b>
<b>ACKNOWLEDGMENT BY CORPORATION .....</b>	<b>96</b>
<b>ACKNOWLEDGMENT BY PARTNERSHIP.....</b>	<b>96</b>
<b>ACKNOWLEDGMENT BY INDIVIDUAL .....</b>	<b>96</b>
<b>ACKNOWLEDGMENT BY COMMISSIONER .....</b>	<b>97</b>
<b>AUTHORITY .....</b>	<b>98</b>
<b>COMPTROLLER'S CERTIFICATE .....</b>	<b>98</b>
<b>MAYOR'S CERTIFICATE .....</b>	<b>99</b>
<b>PERFORMANCE BOND #1 .....</b>	<b>100</b>
<b>PERFORMANCE BOND #2.....</b>	<b>104</b>
<b>PAYMENT BOND .....</b>	<b>108</b>

---

( NO TEXT ON THIS PAGE )

**WITNESSETH:**

The parties, in consideration of the mutual agreements contained herein, agree as follows:

**CHAPTER I: THE CONTRACT AND DEFINITIONS**

**ARTICLE 1. THE CONTRACT**

1.1 Except for titles, subtitles, headings, running headlines, tables of contents and indices (all of which are printed herein merely for convenience), the following, except for such portions thereof as may be specifically excluded, shall be deemed to be part of this Contract:

1.1.1 All provisions required by law to be inserted in this Contract, whether actually inserted or not;

1.1.2 The Contract Drawings and Specifications;

1.1.3 The General Conditions and Special Conditions, if any;

1.1.4 The Contract;

1.1.5 The Information for Bidders; Request for Proposals; Notice of Solicitation and Proposal For Bids; Bid or Proposal, and, if used, the Bid Booklet;

1.1.6 All Addenda issued prior to the receipt of the bids; the Notice of Award; Performance and Payment Bonds, if required; and the Notice to Proceed or the Order to Work.

1.2 Should any conflict occur in or between the Drawings and Specifications, the Contractor shall be deemed to have estimated the most expensive way of doing the Work, unless the Contractor shall have asked for and obtained a decision in writing from the Commissioner of the Agency that is entering into this Contract, before the submission of its bid, as to what shall govern.

**ARTICLE 2. DEFINITIONS**

2.1 The following words and expressions, or pronouns used in their stead, shall, wherever they appear in this Contract, be construed as follows, unless a different meaning is clear from the context:

2.1.1 "Addendum" or "Addenda" shall mean the additional Contract provisions and/or technical clarifications issued in writing by the Commissioner prior to the receipt of bids.

2.1.2 "Agency" shall mean a city, county, borough or other office, position, department, division, bureau, board or commission, or a corporation, institution or agency of government, the expenses of which are paid in whole or in part from the City treasury.

2.1.3 "Agency Chief Contracting Officer" (ACCO) shall mean a person delegated authority by the Commissioner to organize and supervise the procurement activity of subordinate Agency staff in conjunction with the CCPO, or his/her duly authorized representative.



2.1.4 **"Allowance"** shall mean a sum of money which the Agency may include in the total amount of the Contract for such specific contingencies as the Agency believes may be necessary to complete the Work, e.g., lead or asbestos remediation, and for which the Contractor will be paid on the basis of stipulated unit prices or a formula set forth in the Contract or negotiated between the parties provided, however, that if the Contractor is not directed to use the Allowance, the Contractor shall have no right to such money and it shall be deducted from the total amount of the Contract.

2.1.5 **"City"** shall mean the City of New York.

2.1.6 **"City Chief Procurement Officer" (CCPO)** shall mean a person delegated authority by the Mayor to coordinate and oversee the procurement activity of Mayoral agency staff, including the ACCO and any offices which have oversight responsibility for the procurement of construction, or his/her duly authorized representative.

2.1.7 **"Commissioner"** shall mean the head of the Agency that has entered into this Contract, or his/her duly authorized representative.

2.1.8 **"Comptroller"** shall mean the Comptroller of the City of New York.

2.1.9 **"Contract"** or **"Contract Documents"** shall mean each of the various parts of the contract referred to in Article 1 hereof, both as a whole and severally.

2.1.10 **"Contract Drawings"** shall mean only those drawings specifically entitled as such and listed in the Specifications or in any Addendum, or any drawings furnished by the Commissioner, pertaining or supplemental thereto.

2.1.11 **"Contract Work"** shall mean everything required to be furnished and done by the Contractor by any one or more of the parts of the Contract referred to in Article 1, except Extra Work as hereinafter defined.

2.1.12 **"Contractor"** shall mean the entity which executed this Contract, whether a corporation, firm, partnership, joint venture, individual, or any combination thereof, and its, their, his/her successors, personal representatives, executors, administrators, and assigns, and any person, firm, partnership, joint venture, individual, or corporation which shall at any time be substituted in the place of the Contractor under this Contract.

2.1.13 **"Days"** shall mean calendar days, except where otherwise specified.

2.1.14 **"Engineer"** or **"Architect"** or **"Project Manager"** shall mean the person so designated in writing by the Commissioner in the Notice to Proceed or the Order to Work to act as such in relation to this Contract, including a private Architect or Engineer or Project Manager, as the case may be. Subject to written approval by the Commissioner, the Engineer, Architect or Project Manager may designate an authorized representative.

2.1.15 **"Engineering Audit Officer" (EAO)** shall mean the person so designated by the Commissioner to perform responsible auditing functions hereunder.

2.1.16 **"Extra Work"** shall mean Work other than that required by the Contract at the time of award which is authorized by the Commissioner pursuant to Chapter VI of this Contract.

2.1.17 **"Federal-Aid Contract"** shall mean a contract in which the United States (federal) Government provides financial funding as so designated in the Information for Bidders.

2.1.18 **"Final Acceptance"** shall mean final written acceptance of all the Work by the Commissioner, a copy of which shall be sent to the Contractor.

2.1.19 **"Final Approved Punch List"** shall mean a list, approved pursuant to Article 14.2.2, specifying those items of Work to be completed by the Contractor after Substantial Completion and dates for the completion of each item of Work.

2.1.20 **"Law"** or **"Laws"** shall mean the Constitution of the State of New York, the New York City Charter, the New York City Administrative Code, a statute of the United States or of the State of New York, a local law of the City of New York, any ordinance, rule or regulation having the force of law, or common law.

2.1.21 **"Materialman"** shall mean any corporation, firm, partnership, joint venture, or individual, other than employees of the Contractor, who or which contracts with the Contractor or any Subcontractor, to fabricate or deliver, or who actually fabricates or delivers, plant, materials or equipment to be incorporated in the Work.

2.1.22 **"Means and Methods of Construction"** shall mean the labor, materials, temporary structures, tools, plant, and construction equipment, and the manner and time of their use, necessary to accomplish the result intended by this Contract.

2.1.23 **"Notice to Proceed"** or **"Order to Work"** shall mean the written notice issued by the Commissioner specifying the time for commencement of the Work and the Engineer, Architect or Project Manager.

2.1.24 **"Other Contractor(s)"** shall mean any contractor (other than the entity which executed this Contract or its Subcontractors) who or which has a contract with the City for work on or adjacent to the building or Site of the Work.

2.1.25 **"Payroll Taxes"** shall mean State Unemployment Insurance (SUI), Federal Unemployment Insurance (FUI), and payments pursuant to the Federal Insurance Contributions Act (FICA).

2.1.26 **"Project"** shall mean the public improvement to which this Contract relates.

2.1.27 **"Procurement Policy Board"** (PPB) shall mean the Agency of the City of New York whose function is to establish comprehensive and consistent procurement policies and rules which shall have broad application throughout the City.

2.1.28 **"Required Quantity"** in a unit price Contract shall mean the actual quantity of any item of Work or materials which is required to be performed or furnished in order to comply with the Contract.

2.1.29 **"Resident Engineer"** shall mean the representative of the Commissioner duly designated by the Commissioner to be his/her representative at the site of the Work.

2.1.30 **"Site"** shall mean the area upon or in which the Contractor's operations are carried on, and such other areas adjacent thereto as may be designated as such by the Engineer.

2.1.31 "Small Tools" shall mean items that are ordinarily required for a worker's job function, including but not limited to, equipment that ordinarily has no licensing, insurance or substantive storage costs associated with it; such as circular and chain saws, impact drills, threaders, benders, wrenches, socket tools, etc.

2.1.32 "Specifications" shall mean all of the directions, requirements, and standards of performance applying to the Work as hereinafter detailed and designated under the Specifications.

2.1.33 "Subcontractor" shall mean any person, firm or corporation, other than employees of the Contractor, who or which contracts with the Contractor or with its subcontractors to furnish, or actually furnishes labor, or labor and materials, or labor and equipment, or superintendence, supervision and/or management at the Site. Wherever the word Subcontractor appears, it shall also mean sub-Subcontractor.

2.1.34 "Substantial Completion" shall mean the written determination by the Engineer that the Work required under this Contract is substantially, but not entirely, complete and the approval of the Final Approved Punch List.

2.1.35 "Work" shall mean all services required to complete the Project in accordance with the Contract Documents, including without limitation, labor, material, superintendence, management, administration, equipment, and incidentals, and obtaining any and all permits, certifications and licenses as may be necessary and required to complete the Work, and shall include both Contract Work and Extra Work.

## **CHAPTER II: THE WORK AND ITS PERFORMANCE**

### **ARTICLE 3. CHARACTER OF THE WORK**

3.1 Unless otherwise expressly provided in the Contract Drawings, Specifications, and Addenda, the Work shall be performed in accordance with the best modern practice, utilizing, unless otherwise specified in writing, new and unused materials of standard first grade quality and workmanship and design of the highest quality, to the satisfaction of the Commissioner.

### **ARTICLE 4. MEANS AND METHODS OF CONSTRUCTION**

4.1 Unless otherwise expressly provided in the Contract Drawings, Specifications, and Addenda, the Means and Methods of Construction shall be such as the Contractor may choose; subject, however, to the Engineer's right to reject the Means and Methods of Construction proposed by the Contractor which in the opinion of the Engineer:

4.1.1 Will constitute or create a hazard to the Work, or to persons or property; or

4.1.2 Will not produce finished Work in accordance with the terms of the Contract; or

4.1.3 Will be detrimental to the overall progress of the Project.

4.2 The Engineer's approval of the Contractor's Means and Methods of Construction, or his/her failure to exercise his/her right to reject such means or methods, shall not relieve the Contractor

of its obligation to complete the Work as provided in this Contract; nor shall the exercise of such right to reject create a cause of action for damages.

#### **ARTICLE 5. COMPLIANCE WITH LAWS**

5.1 The Contractor shall comply with all Laws applicable to this Contract and to the Work to be done hereunder.

5.2 Procurement Policy Board Rules: This Contract is subject to the Rules of the PPB ("PPB Rules") in effect at the time of the bid opening for this Contract. In the event of a conflict between the PPB Rules and a provision of this Contract, the PPB Rules shall take precedence.

5.3 Noise Control Code provisions.

5.3.1 In accordance with the provisions of Section 24-216(b) of the Administrative Code of the City ("Administrative Code"), Noise Abatement Contract Compliance, devices and activities which will be operated, conducted, constructed or manufactured pursuant to this Contract and which are subject to the provisions of the City Noise Control Code shall be operated, conducted, constructed, or manufactured without causing a violation of the Administrative Code. Such devices and activities shall incorporate advances in the art of noise control development for the kind and level of noise emitted or produced by such devices and activities, in accordance with regulations issued by the Commissioner of the City Department of Environmental Protection.

5.3.2 The Contractor agrees to comply with Section 24-219 of the Administrative Code and implementing rules codified at 15 Rules of the City of New York ("RCNY") Section 28-100 *et seq.* In accordance with such provisions, the Contractor, if the Contractor is the responsible party under such regulations, shall prepare and post a Construction Noise Mitigation Plan at each Site, in which the Contractor shall certify that all construction tools and equipment have been maintained so that they operate at normal manufacturers operating specifications. If the Contractor cannot make this certification, it must have in place an Alternative Noise Mitigation Plan approved by the City Department of Environmental Protection. In addition, the Contractor's certified Construction Noise Mitigation Plan is subject inspection by the City Department of Environmental Protection in accordance with Section 28-101 of Title 15 of RCNY. No Contract Work may take place at a Site unless there is a Construction Noise Mitigation Plan or approved Alternative Noise Mitigation Plan in place. In addition, the Contractor shall create and implement a noise mitigation training program. Failure to comply with these requirements may result in fines and other penalties pursuant to the applicable provisions of the Administrative Code and RCNY.

5.4 Ultra Low Sulfur Diesel Fuel: In accordance with the provisions of Section 24-163.3 of the Administrative Code, the Contractor specifically agrees as follows:

5.4.1 Definitions. For purposes of this Article 5.4, the following definitions apply:

5.4.1(a) "Contractor" means any person or entity that enters into a Public Works Contract with a City Agency, or any person or entity that enters into an agreement with such person or entity, to perform work or provide labor or services related to such Public Works Contract.

5.4.1(b) "Motor Vehicle" means any self-propelled vehicle designed for transporting persons or property on a street or highway.

5.4.1(c) "Nonroad Engine" means an internal combustion engine (including the fuel system) that is not used in a Motor Vehicle or a vehicle used solely for competition, or that is not subject to standards promulgated under Section 7411 or Section 7521 of Title 42 of the United States Code, except that this term shall apply to internal combustion engines used to power generators, compressors or similar equipment used in any construction program or project.

5.4.1(d) "Nonroad Vehicle" means a vehicle that is powered by a Nonroad Engine, fifty (50) horsepower and greater, and that is not a Motor Vehicle or a vehicle used solely for competition, which shall include, but not be limited to, excavators, backhoes, cranes, compressors, generators, bulldozers, and similar equipment, except that this term shall not apply to horticultural maintenance vehicles used for landscaping purposes that are powered by a Nonroad Engine of sixty-five (65) horsepower or less and that are not used in any construction program or project.

5.4.1(e) "Public Works Contract" means a contract with a City Agency for a construction program or project involving the construction, demolition, restoration, rehabilitation, repair, renovation, or abatement of any building, structure, tunnel, excavation, roadway, park or bridge; a contract with a City Agency for the preparation for any construction program or project involving the construction, demolition, restoration, rehabilitation, repair, renovation, or abatement of any building, structure, tunnel, excavation, roadway, park or bridge; or a contract with a City Agency for any final work involved in the completion of any construction program or project involving the construction, demolition, restoration, rehabilitation, repair, renovation, or abatement of any building, structure, tunnel, excavation, roadway, park or bridge.

5.4.1(f) "Ultra Low Sulfur Diesel Fuel" means diesel fuel that has a sulfur content of no more than fifteen parts per million (15 ppm).

#### 5.4.2 Ultra Low Sulfur Diesel Fuel

5.4.2(a) All Contractors shall use Ultra Low Sulfur Diesel Fuel in diesel-powered Nonroad Vehicles in the performance of this Contract.

5.4.2(b) Notwithstanding the requirements of Article 5.4.2(a), Contractors may use diesel fuel that has a sulfur content of no more than thirty parts per million (30 ppm) to fulfill the requirements of this Article 5.4.2, where the Commissioner of the City Department of Environmental Protection ("DEP Commissioner") has issued a determination that a sufficient quantity of Ultra Low Sulfur Diesel Fuel is not available to meet the needs of Agencies and Contractors. Any such determination shall expire after six (6) months unless renewed.

5.4.2(c) Contractors shall not be required to comply with this Article 5.4.2 where the City Agency letting this Contract makes a written finding, which is approved, in writing, by the DEP Commissioner, that a sufficient quantity of Ultra Low Sulfur Diesel Fuel, or diesel fuel that has a sulfur content of no more than thirty parts per million (30 ppm) is not available to meet the requirements of Section 24-163.3 of the Administrative Code, provided that such Contractor in its fulfillment of the

requirements of this Contract, to the extent practicable, shall use whatever quantity of Ultra Low Sulfur Diesel Fuel or diesel fuel that has a sulfur content of no more than thirty parts per million (30 ppm) is available. Any finding made pursuant to this Article 5.4.2(c) shall expire after sixty (60) Days, at which time the requirements of this Article 5.4.2 shall be in full force and effect unless the City Agency renews the finding in writing and such renewal is approved by the DEP Commissioner.

5.4.2(d) Contractors may check on determinations and approvals issued by the DEP Commissioner pursuant to Section 24-163.3 of the Administrative Code, if any, at [www.dep.nyc.gov](http://www.dep.nyc.gov) or by contacting the City Agency letting this Contract,

5.4.2(e) The requirements of this Article 5.4.2 do not apply where they are precluded by federal or State funding requirements or where the Contract is an emergency procurement.

#### 5.4.3 Best Available Technology

5.4.3(a) All Contractors shall utilize the best available technology for reducing the emission of pollutants for diesel-powered Nonroad Vehicles in the performance of this Contract. For determinations of best available technology for each type of diesel-powered Nonroad Vehicle, Contractors shall comply with the regulations of the City Department of Environmental Protection, as and when adopted, Chapter 14 of Title 15 of the Rules of the City of New York (RCNY). The Contractor shall fully document all steps in the best available technology selection process and shall furnish such documentation to the City Agency or the DEP Commissioner upon request. The Contractor shall retain all documentation generated in the best available technology selection process for as long as the selected best available technology is in use.

5.4.3(b) No Contractor shall be required to replace best available technology for reducing the emission of pollutants or other authorized technology utilized for a diesel-powered Nonroad Vehicle in accordance with the provisions of this Article 5.4.3 within three (3) years of having first utilized such technology for such vehicle.

5.4.3(c) This Article 5.4.3 shall not apply to any vehicle used to satisfy the requirements of a specific Public Works Contract for fewer than twenty (20) Days.

5.4.3(d) The Contractor shall not be required to comply with this Article 5.4.3 with respect to a diesel-powered Nonroad Vehicle under the following circumstances:

5.4.3(d)(i) Where the City Agency makes a written finding, which is approved, in writing, by the DEP Commissioner, that the best available technology for reducing the emission of pollutants as required by this Article 5.4.3 is unavailable for such vehicle, the Contractor shall use whatever technology for reducing the emission of pollutants, if any, is available and appropriate for such vehicle.

5.4.3(d)(ii) Where the DEP Commissioner has issued a written waiver based upon the Contractor having demonstrated to the DEP Commissioner that the use of the best available technology for reducing the emission of pollutants might endanger the operator of such vehicle or those working near such vehicle, due to engine malfunction, the Contractor shall use whatever technology for

reducing the emission of pollutants, if any, is available and appropriate for such vehicle, which would not endanger the operator of such vehicle or those working near such vehicle.

5.4.3(d)(iii) In determining which technology to use for the purposes of Articles 5.4.3(d)(i) and 5.4.3(d)(ii) above, the Contractor shall primarily consider the reduction in emissions of particulate matter and secondarily consider the reduction in emissions of nitrogen oxides associated with the use of such technology, which shall in no event result in an increase in the emissions of either such pollutant.

5.4.3(d)(iv) The Contractor shall submit requests for a finding or a waiver pursuant to this Article 5.4.3(d) in writing to the DEP Commissioner, with a copy to the ACCO of the City Agency letting this Contract. Any finding or waiver made or issued pursuant to Articles 5.4.3(d)(i) and 5.4.3(d)(ii) above shall expire after one hundred eighty (180) Days, at which time the requirements of Article 5.4.3(a) shall be in full force and effect unless the City Agency renews the finding, in writing, and the DEP Commissioner approves such finding, in writing, or the DEP Commissioner renews the waiver, in writing.

5.4.3(e) The requirements of this Article 5.4.3 do not apply where they are precluded by federal or State funding requirements or where the Contract is an emergency procurement.

5.4.4 Section 24-163 of the Administrative Code. The Contractor shall comply with Section 24-163 of the Administrative Code related to the idling of the engines of motor vehicles while parking.

#### 5.4.5 Compliance

5.4.5(a) The Contractor's compliance with Article 5.4 may be independently monitored. If it is determined that the Contractor has failed to comply with any provision of Article 5.4, any costs associated with any independent monitoring incurred by the City shall be reimbursed by the Contractor.

5.4.5(b) Any Contractor who violates any provision of Article 5.4, except as provided in Article 5.4.5(c) below, shall be liable for a civil penalty between the amounts of one thousand (\$1,000) and ten thousand (\$10,000) dollars, in addition to twice the amount of money saved by such Contractor for failure to comply with Article 5.4.

5.4.5(c) No Contractor shall make a false claim with respect to the provisions of Article 5.4 to a City Agency. Where a Contractor has been found to have done so, such Contractor shall be liable for a civil penalty of twenty thousand (\$20,000) dollars, in addition to twice the amount of money saved by such Contractor in association with having made such false claim.

#### 5.4.6 Reporting

5.4.6(a) For all Public Works Contracts covered by this Article 5.4, the Contractor shall report to the City Agency the following information:

5.4.6(a)(i) The total number of diesel-powered Nonroad Vehicles used to fulfill the requirements of this Public Works Contract;

5.4.6(a)(ii) The number of such Nonroad Vehicles that were powered by Ultra Low Sulfur Diesel Fuel;

5.4.6(a)(iii) The number of such Nonroad Vehicles that utilized the best available technology for reducing the emission of pollutants, including a breakdown by vehicle model and the type of technology;

5.4.6(a)(iv) The number of such Nonroad Vehicles that utilized such other authorized technology in accordance with Article 5.4.3, including a breakdown by vehicle model and the type of technology used for each such vehicle;

5.4.6(a)(v) The locations where such Nonroad Vehicles were used; and

5.4.6(a)(vi) Where a determination is in effect pursuant to Article 5.4.2(b) or 5.4.2(c), detailed information concerning the Contractor's efforts to obtain Ultra Low Sulfur Diesel Fuel or diesel fuel that has a sulfur content of no more than thirty parts per million (30 ppm).

5.4.6(b) The Contractor shall submit the information required by Article 5.4.6(a) at the completion of Work under the Public Works Contract and on a yearly basis no later than August 1 throughout the term of the Public Works Contract. The yearly report shall cover Work performed during the preceding fiscal year (July 1 - June 30).

5.5 Ultra Low Sulfur Diesel Fuel. In accordance with the Coordinated Construction Act for Lower Manhattan, as amended:

5.5.1 Definitions. For purposes of this Article 5.5, the following definitions apply:

5.5.1(a) "Lower Manhattan" means the area to the south of and within the following lines: a line beginning at a point where the United States pierhead line in the Hudson River as it exists now or may be extended would intersect with the southerly line of West Houston Street in the Borough of Manhattan extended, thence easterly along the southerly side of West Houston Street to the southerly side of Houston Street, thence easterly along the southerly side of Houston Street to the southerly side of East Houston Street, thence northeasterly along the southerly side of East Houston Street to the point where it would intersect with the United States pierhead line in the East River as it exists now or may be extended, including tax lots within or immediately adjacent thereto.

5.5.1(b) "Lower Manhattan Redevelopment Project" means any project in Lower Manhattan that is funded in whole or in part with federal or State funding, or any project intended to improve transportation between Lower Manhattan and the two air terminals in the City known as LaGuardia Airport and John F. Kennedy International Airport, or between Lower Manhattan and the air terminal in Newark known as Newark Liberty International Airport, and that is funded in whole or in part with federal funding.



5.5.1(c) "Nonroad Engine" means an internal combustion engine (including the fuel system) that is not used in a Motor Vehicle or a vehicle used solely for competition, or that is not subject to standards promulgated under Section 7411 or Section 7521 of Title 42 of the United States Code, except that this term shall apply to internal combustion engines used to power generators, compressors or similar equipment used in any construction program or project.

5.5.1(d) "Nonroad Vehicle" means a vehicle that is powered by a Nonroad Engine, fifty (50) horsepower (HP) and greater, and that is not a Motor Vehicle or a vehicle used solely for competition, which shall include, but not be limited to, excavators, backhoes, cranes, compressors, generators, bulldozers, and similar equipment, except that this term shall not apply to horticultural maintenance vehicles used for landscaping purposes that are powered by a Nonroad Engine of sixty-five (65) HP or less and that are not used in any construction program or project.

5.5.1(e) "Ultra Low Sulfur Diesel Fuel" means diesel fuel that has a sulfur content of no more than fifteen parts per million (15 ppm).

5.5.2 Requirements. Contractors and Subcontractors are required to use only Ultra Low Sulfur Diesel Fuel to power the diesel-powered Nonroad Vehicles with engine HP rating of fifty (50) HP and above used on a Lower Manhattan Redevelopment Project and, where practicable, to reduce the emission of pollutants by retrofitting such Nonroad Vehicles with oxidation catalysts, particulate filters, or technology that achieves lowest particulate matter emissions.

5.6 Pesticides. In accordance with Section 17-1209 of the Administrative Code, to the extent that the Contractor or any Subcontractor applies pesticides to any property owned or leased by the City, the Contractor, and any Subcontractor shall comply with Chapter 12 of the Administrative Code.

5.7 Waste Treatment, Storage, and Disposal Facilities and Transporters. In connection with the Work, the Contractor and any Subcontractor shall use only those waste treatment, storage, and disposal facilities and waste transporters that possess the requisite license, permit or other governmental approval necessary to treat, store, dispose, or transport the waste, materials or hazardous substances.

5.8 Environmentally Preferable Purchasing. The Contractor shall ensure that products purchased or leased by the Contractor or any Subcontractor for the Work that are not specified by the City or are submitted as equivalents to a product specified by the City comply with the requirements of the New York City Environmentally Preferable Purchasing Program contained in Chapter 11 of Title 43 of the RCNY, pursuant to Chapter 3 of Title 6 of the Administrative Code.

## **ARTICLE 6. INSPECTION**

6.1 During the progress of the Work and up to the date of Final Acceptance, the Contractor shall at all times afford the representatives of the City every reasonable, safe, and proper facility for inspecting all Work done or being done at the Site and also for inspecting the manufacture or preparation of materials and equipment at the place of such manufacture or preparation.

6.2 The Contractor's obligation hereunder shall include the uncovering or taking down of finished Work and its restoration thereafter; provided, however, that the order to uncover, take down and restore shall be in writing, and further provided that if Work thus exposed proves satisfactory, and if the Contractor has complied with Article 6.1, such uncovering or taking down and restoration shall be

considered an item of Extra Work to be paid for in accordance with the provisions of Article 26. If the Work thus exposed proves unsatisfactory, the City has no obligation to compensate the Contractor for the uncovering, taking down or restoration.

6.3 Inspection and approval by the Commissioner, the Engineer, Project Manager, or Resident Engineer, of finished Work or of Work being performed, or of materials and equipment at the place of manufacture or preparation, shall not relieve the Contractor of its obligation to perform the Work in strict accordance with the Contract. Finished or unfinished Work not found to be in strict accordance with the Contract shall be replaced as directed by the Engineer, even though such Work may have been previously approved and paid for. Such corrective Work is Contract Work and shall not be deemed Extra Work.

6.4 Rejected Work and materials shall be promptly taken down and removed from the Site, which must at all times be kept in a reasonably clean and neat condition.

#### **ARTICLE 7. PROTECTION OF WORK AND OF PERSONS AND PROPERTY; NOTICES AND INDEMNIFICATION**

7.1 During the performance of the Work and up to the date of Final Acceptance, the Contractor shall be under an absolute obligation to protect the finished and unfinished Work against any damage, loss, injury, theft and/or vandalism and in the event of such damage, loss, injury, theft and/or vandalism, it shall promptly replace and/or repair such Work at the Contractor's sole cost and expense, as directed by the Resident Engineer. The obligation to deliver finished Work in strict accordance with the Contract prior to Final Acceptance shall be absolute and shall not be affected by the Resident Engineer's approval of, or failure to prohibit, the Means and Methods of Construction used by the Contractor.

7.2 During the performance of the Work and up to the date of Final Acceptance, the Contractor shall take all reasonable precautions to protect all persons and the property of the City and of others from damage, loss or injury resulting from the Contractor's, and/or its Subcontractors' operations under this Contract. The Contractor's obligation to protect shall include the duty to provide, place or replace, and adequately maintain at or about the Site suitable and sufficient protection such as lights, barricades, and enclosures.

7.3 The Contractor shall comply with the notification requirements set forth below in the event of any loss, damage or injury to Work, persons or property, or any accidents arising out of the operations of the Contractor and/or its Subcontractors under this Contract.

7.3.1 The Contractor shall make a full and complete report in writing to the Resident Engineer within three (3) Days after the occurrence.

7.3.2 The Contractor shall also send written notice of any such event to all insurance carriers that issued potentially responsive policies (including commercial general liability insurance carriers for events relating to the Contractor's own employees) no later than twenty (20) days after such event and again no later than twenty (20) days after the initiation of any claim and/or action resulting therefrom. Such notice shall contain the following information: the number of the insurance policy, the name of the Named Insured, the date and location of the incident, and the identity of the persons injured or property damaged. For any policy on which the City and/or the Engineer, Architect, or Project Manager are Additional Insureds, such notice shall expressly specify that "this notice is

being given on behalf of the City of New York as Additional Insured, such other Additional Insureds, as well as the Named Insured.”

7.3.2(a) Whenever such notice is sent under a policy on which the City is an Additional Insured, the Contractor shall provide copies of the notice to the Comptroller, the Commissioner and the City Corporation Counsel. The copy to the Comptroller shall be sent to the Insurance Unit, NYC Comptroller’s Office, 1 Centre Street – Room 1222, New York, New York, 10007. The copy to the Commissioner shall be sent to the address set forth in Schedule A of the General Conditions. The copy to the City Corporation Counsel shall be sent to Insurance Claims Specialist, Affirmative Litigation Division, New York City Law Department, 100 Church Street, New York, New York 10007.

7.3.2(b) If the Contractor fails to provide any of the foregoing notices to any appropriate insurance carrier(s) in a timely and complete manner, the Contractor shall indemnify the City for all losses, judgments, settlements, and expenses, including reasonable attorneys’ fees, arising from an insurer’s disclaimer of coverage citing late notice by or on behalf of the City.

7.4 To the fullest extent permitted by law, the Contractor shall defend, indemnify, and hold the City, its employees, and officials (the “Indemnitees”) harmless against any and all claims (including but not limited to claims asserted by any employee of the Contractor and/or its Subcontractors) and costs and expenses of whatever kind (including but not limited to payment or reimbursement of attorneys’ fees and disbursements) allegedly arising out of or in any way related to the operations of the Contractor and/or its Subcontractors in the performance of this Contract or from the Contractor’s and/or its Subcontractors’ failure to comply with any of the provisions of this Contract or of the Law. Such costs and expenses shall include all those incurred in defending the underlying claim and those incurred in connection with the enforcement of this Article 7.4 by way of cross-claim, third-party claim, declaratory action or otherwise. The parties expressly agree that the indemnification obligation hereunder contemplates (1) full indemnity in the event of liability imposed against the Indemnitees without negligence and solely by reason of statute, operation of Law or otherwise; and (2) partial indemnity in the event of any actual negligence on the part of the Indemnitees either causing or contributing to the underlying claim (in which case, indemnification will be limited to any liability imposed over and above that percentage attributable to actual fault whether by statute, by operation of Law, or otherwise). Where partial indemnity is provided hereunder, all costs and expenses shall be indemnified on a pro rata basis.

7.4.1 Indemnification under Article 7.4 or any other provision of the Contract shall operate whether or not Contractor or its Subcontractors have placed and maintained the insurance specified under Article 22.

7.5 The provisions of this Article 7 shall not be deemed to create any new right of action in favor of third parties against the Contractor or the City.

### **CHAPTER III: TIME PROVISIONS**

#### **ARTICLE 8. COMMENCEMENT AND PROSECUTION OF THE WORK**

8.1 The Contractor shall commence the Work on the date specified in the Notice to Proceed or the Order to Work. The time for performance of the Work under the Contract shall be computed from

the date specified in the **Notice to Proceed** or the **Order to Work**. **TIME BEING OF THE ESSENCE** to the City, the **Contractor** shall thereafter prosecute the **Work** diligently, using such **Means and Methods of Construction** as are in accord with Article 4 herein and as will assure its completion not later than the date specified in this Contract, or on the date to which the time for completion may be extended.

#### **ARTICLE 9. PROGRESS SCHEDULES**

9.1 To enable the **Work** to be performed in an orderly and expeditious manner, the **Contractor**, within fifteen (15) **Days** after the **Notice to Proceed** or **Order to Work**, unless otherwise directed by the **Engineer**, shall submit to the **Engineer** a proposed progress schedule based on the Critical Path Method in the form of a bar graph or in such other form as specified by the **Engineer**, and monthly cash flow requirements, showing:

9.1.1 The anticipated time of commencement and completion of each of the various operations to be performed under this **Contract**; and

9.1.2 The sequence and interrelation of each of these operations with the others and with those of other related contracts; and

9.1.3 The estimated time required for fabrication or delivery, or both, of all materials and equipment required for the **Work**, including the anticipated time for obtaining required approvals pursuant to Article 10; and

9.1.4 The estimated amount in dollars the **Contractor** will claim on a monthly basis.

9.2 The proposed schedule shall be revised as directed by the **Engineer**, until finally approved by the **Engineer**, and after such approval, subject to the provisions of Article 11, shall be strictly adhered to by the **Contractor**.

9.3 If the **Contractor** shall fail to adhere to the approved progress schedule, or to the schedule as revised pursuant to Article 11, it shall promptly adopt such other or additional **Means and Methods of Construction**, at its sole cost and expense, as will make up for the time lost and will assure completion in accordance with the approved progress schedule. The approval by the City of a progress schedule which is shorter than the time allotted under the **Contract** shall not create any liability for the City if the approved progress schedule is not met.

9.4 The **Contractor** will not receive any payments until the proposed progress schedule is submitted.

#### **ARTICLE 10. REQUESTS FOR INFORMATION OR APPROVAL**

10.1 From time to time as the **Work** progresses and in the sequence indicated by the approved progress schedule, the **Contractor** shall submit to the **Engineer** a specific request in writing for each item of information or approval required by the **Contractor**. These requests shall state the latest date upon which the information or approval is actually required by the **Contractor**, and shall be submitted in a reasonable time in advance thereof to provide the **Engineer** a sufficient time to act upon such submissions, or any necessary re-submissions thereof.

10.2 The Contractor shall not have any right to an extension of time on account of delays due to the Contractor's failure to submit requests for the required information or the required approval in accordance with the above requirements.

**ARTICLE 11. NOTICE OF CONDITIONS CAUSING DELAY AND DOCUMENTATION OF DAMAGES CAUSED BY DELAY**

11.1 After the commencement of any condition which is causing or may cause a delay in completion of the Work, including conditions for which the Contractor may be entitled to an extension of time, the following notifications and submittals are required:

11.1.1 Within fifteen (15) Days after the Contractor becomes aware or reasonably should be aware of each such condition, the Contractor must notify the Resident Engineer or Engineer, as directed by the Commissioner, in writing of the existence, nature and effect of such condition upon the approved progress schedule and the Work, and must state why and in what respects, if any, the condition is causing or may cause a delay. Such notice shall include a description of the construction activities that are or could be affected by the condition and may include any recommendations the Contractor may have to address the delay condition and any activities the Contractor may take to avoid or minimize the delay.

11.1.2 If the Contractor shall claim to be sustaining damages for delay as provided for in this Article 11, within forty-five (45) Days from the time such damages are first incurred for each such condition, the Contractor shall submit to the Commissioner a verified written statement of the details and estimates of the amounts of such damages, including categories of expected damages and projected monthly costs, together with documentary evidence of such damages as the Contractor may have at the time of submission ("statement of delay damages"), as further detailed in Article 11.6. The Contractor may submit the above statement within such additional time as may be granted by the Commissioner in writing upon written request therefor.

11.1.3 Articles 11.1.1 and 11.1.2 do not relieve the Contractor of its obligation to comply with the provisions of Article 44.

11.2 Failure of the Contractor to strictly comply with the requirements of Article 11.1.1 may, in the discretion of the Commissioner, be deemed sufficient cause to deny any extension of time on account of delay arising out of such condition. Failure of the Contractor to strictly comply with the requirements of both Articles 11.1.1 and 11.1.2 shall be deemed a conclusive waiver by the Contractor of any and all claims for damages for delay arising from such condition and no right to recover on such claims shall exist.

11.3 When appropriate and directed by the Engineer, the progress schedule shall be revised by the Contractor until finally approved by the Engineer. The revised progress schedule must be strictly adhered to by the Contractor.

11.4 Compensable Delays

11.4.1 The Contractor agrees to make claim only for additional costs attributable to delay in the performance of this Contract necessarily extending the time for completion of the Work or resulting from acceleration directed by the Commissioner and required to maintain the progress schedule, occasioned solely by any act or omission to act of the City listed below. The Contractor also agrees that delay from any other cause shall be

compensated, if at all, solely by an extension of time to complete the performance of the Work.

- 11.4.1.1 The failure of the City to take reasonable measures to coordinate and progress the Work to the extent required by the Contract, except that the City shall not be responsible for the Contractor's obligation to coordinate and progress the Work of its Subcontractors.
- 11.4.1.2 Unreasonable delays attributable to the review of shop drawings, the issuance of change orders, or the cumulative impact of change orders that were not brought about by any act or omission of the Contractor.
- 11.4.1.3 The unavailability of the Site caused by acts or omissions of the City..
- 11.4.1.4 The issuance by the Engineer of a stop work order that was not brought about through any act or omission of the Contractor.
- 11.4.1.5 Differing site conditions or environmental hazards that were neither known nor reasonably ascertainable on a pre-bid inspection of the Site or review of the bid documents or other publicly available sources, and that are not ordinarily encountered in the Project's geographical area or neighborhood or in the type of Work to be performed.
- 11.4.1.6 Delays caused by the City's bad faith or its willful, malicious, or grossly negligent conduct;
- 11.4.1.7 Delays not contemplated by the parties;
- 11.4.1.8 Delays so unreasonable that they constitute an intentional abandonment of the Contract by the City; and
- 11.4.1.9 Delays resulting from the City's breach of a fundamental obligation of the Contract.

11.4.2 No claim may be made for any alleged delay in Substantial Completion of the Work if the Work will be or is substantially completed by the date of Substantial Completion provided for in Schedule A unless acceleration has been directed by the Commissioner to meet the date of Substantial Completion set forth in Schedule A, or unless there is a provision in the Contract providing for additional compensation for early completion.

11.4.3 The provisions of this Article 11 apply only to claims for additional costs attributable to delay and do not preclude determinations by the Commissioner allowing reimbursements for additional costs for Extra Work pursuant to Articles 25 and 26 of this Contract. To the extent that any cost attributable to delay is reimbursed as part of a change order, no additional claim for compensation under this Article 11 shall be allowed.

11.5 Non-Compensable Delays. The Contractor agrees to make no claim for, and is deemed to have included in its bid prices for the various items of the Contract, the extra/additional costs attributable to any delays caused by or attributable to the items set forth below. For such items, the Contractor shall be compensated, if at all, solely by an extension of time to complete the performance of the Work, in accordance with the provisions of Article 13. Such extensions of time will be granted, if at all, pursuant to the grounds set forth in Article 13.3.

11.5.1 The acts or omissions of any third parties, including but not limited to Other Contractors, public/ governmental bodies (other than City Agencies), utilities or private enterprises, who are disclosed in the Contract Documents or are ordinarily encountered or generally recognized as related to the Work;

11.5.2 Any situation which was within the contemplation of the parties at the time of entering into the **Contract**, including any delay indicated or disclosed in the **Contract Documents** or that would be generally recognized by a reasonably prudent contractor as related to the nature of the **Work**, and/or the existence of any facility or appurtenance owned, operated or maintained by any third party, as indicated or disclosed in the **Contract Documents** or ordinarily encountered or generally recognized as related to the nature of the **Work**;

11.5.3 Restraining orders, injunctions or judgments issued by a court which were caused by a Contractor's submission, action or inaction or by a Contractor's **Means and Methods of Construction**, or by third parties, unless such order, injunction or judgment was the result of an act or omission by the **City**;

11.5.4 Any labor boycott, strike, picketing, lockout or similar situation;

11.5.5 Any shortages of supplies or materials, or unavailability of equipment, required by the **Contract Work**;

11.5.6 Climatic conditions, storms, floods, droughts, tidal waves, fires, hurricanes, earthquakes, landslides or other catastrophes or acts of God, or acts of war or of the public enemy or terrorist acts, including the **City's** reasonable responses thereto; and

11.5.7 **Extra Work** which does not significantly affect the overall completion of the **Contract**, reasonable delays in the review or issuance of change orders or field orders<sup>#</sup> and/or in shop drawing reviews or approvals.

#### 11.6 Required Content of Submission of Statement of Delay Damages

11.6.1 In the verified written statement of delay damages required by Article 11.1.2, the following information shall be provided by the **Contractor**:

11.6.1.1 For each delay, the start and end dates of the claimed periods of delay and, in addition, a description of the operations that were delayed, an explanation of how they were delayed, and the reasons for the delay, including identifying the applicable act or omission of the **City** listed in Article 11.4.

11.6.1.2 A detailed factual statement of the claim providing all necessary dates, locations and items of **Work** affected by the claim.

11.6.1.3 The estimated amount of additional compensation sought and a breakdown of that amount into categories as described in Article 11.7.

11.6.1.4 Any additional information requested by the **Commissioner**.

#### 11.7 Recoverable Costs

11.7.1 Delay damages may be recoverable for the following costs actually and necessarily incurred in the performance of the **Work**:

11.7.1.1 Direct labor, including payroll taxes (subject to statutory wage caps) and supplemental benefits, based on time and materials records;

11.7.1.2 Necessary materials (including transportation to the **Site**), based on time and material records;

- 11.7.1.3 Reasonable rental value of necessary plant and equipment other than small tools, plus fuel/energy costs according to the applicable formula set forth in Articles 26.2.4 and/or 26.2.8, based on time and material records;
- 11.7.1.4 Additional insurance and bond costs;
- 11.7.1.5 Extended Site overhead, field office rental, salaries of field office staff, on-site project managers and superintendents, field office staff vehicles, Project-specific storage, field office utilities and telephone, and field office consumables;
- 11.7.1.6 Labor escalation costs based on actual costs;
- 11.7.1.7 Materials and equipment escalation costs based on applicable industry indices unless documentation of actual increased cost is provided;
- 11.7.1.8 Additional material and equipment storage costs based on actual documented costs and additional costs necessitated by extended manufacturer warranty periods; and
- 11.7.1.9 Extended home office overhead calculated based on the following formula:
  - (1) Subtract from the original Contract amount the amount earned by original contractual Substantial Completion date (not including change orders);
  - (2) Remove 15% overhead and profit from the calculation in item (1) by dividing the results of item (1) by 1.15;
  - (3) Multiply the result of item (2) by 7.25% for the total home office overhead;
  - (4) Multiply the result of item (3) by 7.25% for the total profit; and
  - (5) The total extended home office overhead will be the total of items (3) and (4).

11.7.2 Recoverable Subcontractor Costs. When the Work is performed by a Subcontractor, the Contractor may be paid the actual and necessary costs of such subcontracted Work as outlined above in Articles 11.7.1.1 through 11.7.1.8, and an additional overhead of 5% of the costs outlined in Articles 11.7.1.1 through 11.7.1.3.

11.7.3 Non-Recoverable Costs. The parties agree that the City will have no liability for the following items and the Contractor agrees it shall make no claim for the following items:

- 11.7.3.1 Profit, or loss of anticipated or unanticipated profit, except as provided in Article 11.7.1.9;
- 11.7.3.2 Consequential damages, including, but not limited to, construction or bridge loans or interest paid on such loans, loss of bonding capacity, bidding opportunities, or interest in investment, or any resulting insolvency;
- 11.7.3.3 Indirect costs or expenses of any nature except those included in Article 11.7.1;
- 11.7.3.4 Direct or indirect costs attributable to performance of Work where the Contractor, because of situations or conditions within its control, has not progressed the Work in a satisfactory manner; and
- 11.7.3.5 Attorneys' fees and dispute and claims preparation expenses.



- 11.8 Any claims for delay under this Article 11 are not subject to the jurisdiction of the Contract Dispute Resolution Board pursuant to the dispute resolution process set forth in Article 27.
- 11.9 Any compensation provided to the Contractor in accordance with this Article 11 will be made pursuant to a claim filed with the Comptroller. Nothing in this Article 11 extends the time for the Contractor to file an action with respect to a claim within six months after Substantial Completion pursuant to Article 56.

## **ARTICLE 12. COORDINATION WITH OTHER CONTRACTORS**

12.1 During the progress of the Work, Other Contractors may be engaged in performing other work or may be awarded other contracts for additional work on this Project. In that event, the Contractor shall coordinate the Work to be done hereunder with the work of such Other Contractors and the Contractor shall fully cooperate with such Other Contractors and carefully fit its own Work to that provided under other contracts as may be directed by the Engineer. The Contractor shall not commit or permit any act which will interfere with the performance of work by any Other Contractors.

12.2 If the Engineer determines that the Contractor is failing to coordinate its Work with the work of Other Contractors as the Engineer has directed, then the Commissioner shall have the right to withhold any payments otherwise due hereunder until the Contractor completely complies with the Engineer's directions.

12.3 The Contractor shall notify the Engineer in writing if any Other Contractor on this Project is failing to coordinate its work with the Work of this Contract. If the Engineer finds such charges to be true, the Engineer shall promptly issue such directions to the Other Contractor with respect thereto as the situation may require. The City shall not, however, be liable for any damages suffered by any Other Contractor's failure to coordinate its work with the Work of this Contract or by reason of the Other Contractor's failure to promptly comply with the directions so issued by the Engineer, or by reason of any Other Contractor's default in performance, it being understood that the City does not guarantee the responsibility or continued efficiency of any contractor. The Contractor agrees to make no claim against the City for any damages relating to or arising out of any directions issued by the Engineer pursuant to this Article 12 (including but not limited to the failure of any Other Contractor to comply or promptly comply with such directions), or the failure of any Other Contractor to coordinate its work, or the default in performance of any Other Contractor.

12.4 The Contractor shall indemnify and hold the City harmless from any and all claims or judgments for damages and from costs and expenses to which the City may be subjected or which it may suffer or incur by reason of the Contractor's failure to comply with the Engineer's directions promptly; and the Comptroller shall have the right to exercise the powers reserved in Article 23 with respect to any claims which may be made for damages due to the Contractor's failure to comply with the Engineer's directions promptly. Insofar as the facts and Law relating to any claim would preclude the City from being completely indemnified by the Contractor, the City shall be partially indemnified by the Contractor to the fullest extent provided by Law.

12.5 Should the Contractor sustain any damage through any act or omission of any Other Contractor having a contract with the City for the performance of work upon the Site or of work which may be necessary to be performed for the proper prosecution of the Work to be performed hereunder, or through any act or omission of a subcontractor of such Other Contractor, the Contractor shall have no claim against the City for such damage, but shall have a right to recover such damage from the Other

**Contractor** under the provision similar to the following provisions which apply to this **Contract** and have been or will be inserted in the contracts with such **Other Contractors**:

12.5.1 Should any **Other Contractor** having or who shall hereafter have a contract with the **City** for the performance of work upon the **Site** sustain any damage through any act or omission of the **Contractor** hereunder or through any act or omission of any **Subcontractor** of the **Contractor**, the **Contractor** agrees to reimburse such **Other Contractor** for all such damages and to defend at its own expense any action based upon such claim and if any judgment or claim (even if the allegations of the action are without merit) against the **City** shall be allowed the **Contractor** shall pay or satisfy such judgment or claim and pay all costs and expenses in connection therewith and agrees to indemnify and hold the **City** harmless from all such claims. Insofar as the facts and Law relating to any claim would preclude the **City** from being completely indemnified by the **Contractor**, the **City** shall be partially indemnified by the **Contractor** to the fullest extent provided by Law.

12.6 The **City's** right to indemnification hereunder shall in no way be diminished, waived or discharged by its recourse to assessment of liquidated damages as provided in Article 15, or by the exercise of any other remedy provided for by **Contract** or by Law.

### **ARTICLE 13. EXTENSION OF TIME FOR PERFORMANCE**

13.1 If performance by the **Contractor** is delayed for a reason set forth in Article 13.3, the **Contractor** may be allowed a reasonable extension of time in conformance with this Article 13 and the **PPB Rules**.

13.2 Any extension of time may be granted only by the **ACCO** or by the Board for the Extension of Time (hereafter "**Board**") (as set forth below) upon written application by the **Contractor**.

13.3 Grounds for Extension: If such application is made, the **Contractor** shall be entitled to an extension of time for delay in completion of the **Work** caused solely:

13.3.1 By the acts or omissions of the **City**, its officials, agents or employees; or

13.3.2 By the act or omissions of **Other Contractors** on this **Project**; or

13.3.3 By supervening conditions entirely beyond the control of either party hereto (such as, but not limited to, acts of God or the public enemy, excessive inclement weather, war or other national emergency making performance temporarily impossible or illegal, or strikes or labor disputes not brought about by any act or omission of the **Contractor**).

13.3.4 The **Contractor** shall, however, be entitled to an extension of time for such causes only for the number of **Days** of delay which the **ACCO** or the **Board** may determine to be due solely to such causes, and then only if the **Contractor** shall have strictly complied with all of the requirements of Articles 9 and 10.

13.4 The **Contractor** shall not be entitled to receive a separate extension of time for each of several causes of delay operating concurrently, but, if at all, only for the actual period of delay in completion of the **Work** as determined by the **ACCO** or the **Board**, irrespective of the number of causes contributing to produce such delay. If one of several causes of delay operating concurrently results from any act, fault or omission of the **Contractor** or of its **Subcontractors** or **Materialmen**, and would of itself (irrespective

of the concurrent causes) have delayed the Work, no extension of time will be allowed for the period of delay resulting from such act, fault or omission.

13.5 The determination made by the ACCO or the Board on an application for an extension of time shall be binding and conclusive on the Contractor.

13.6 The ACCO or the Board acting entirely within their discretion may grant an application for an extension of time for causes of delay other than those herein referred.

13.7 Permitting the Contractor to continue with the Work after the time fixed for its completion has expired, or after the time to which such completion may have been extended has expired, or the making of any payment to the Contractor after such time, shall in no way operate as a waiver on the part of the City of any of its rights under this Contract.

**13.8 Application for Extension of Time:**

13.8.1 Before the Contractor's time extension request will be considered, the Contractor shall notify the ACCO of the condition which allegedly has caused or is causing the delay, and shall submit a written application to the ACCO identifying:

13.8.1(a) The Contractor; the registration number; and Project description;

13.8.1(b) Liquidated damage assessment rate, as specified in the Contract;

13.8.1(c) Original total bid price;

13.8.1(d) The original Contract start date and completion date;

13.8.1(e) Any previous time extensions granted (number and duration); and

13.8.1(f) The extension of time requested.

13.8.2 In addition, the application for extension of time shall set forth in detail:

13.8.2(a) The nature of each alleged cause of delay in completing the Work;

13.8.2(b) The date upon which each such cause of delay began and ended and the number of Days attributable to each such cause;

13.8.2(c) A statement that the Contractor waives all claims except for those delineated in the application, and the particulars of any claims which the Contractor does not agree to waive. For time extensions for Substantial Completion and final completion payments, the application shall include a detailed statement of the dollar amounts of each element of claim item reserved; and

13.8.2(d) A statement indicating the Contractor's understanding that the time extension is granted only for purposes of permitting continuation of Contract performance and payment for Work performed and that the City retains its right to conduct an investigation and assess liquidated damages as appropriate in the future.

**13.9 Analysis and Approval of Time Extensions:**

13.9.1 For time extensions for partial payments, a written determination shall be made by the ACCO who may, for good and sufficient cause, extend the time for the performance of the Contract as follows:

13.9.1(a) If the Work is to be completed within six (6) months, the time for performance may be extended for sixty (60) Days;

13.9.1(b) If the Work is to be completed within less than one (1) year but more than six (6) months, an extension of ninety (90) Days may be granted;

13.9.1(c) If the Contract period exceeds one (1) year, besides the extension granted in Article 13.9.1(b), an additional thirty (30) Days may be granted for each multiple of six (6) months involved beyond the one (1) year period; or

13.9.1(d) If exceptional circumstances exist, the ACCO may extend the time for performance beyond the extensions in Articles 13.9.1(a), 13.9.1(b), and 13.9.1(c). In that event, the ACCO shall file with the Mayor's Office of Contract Services a written explanation of the exceptional circumstances.

13.9.2 For extensions of time for Substantial Completion and final completion payments, the Engineer, in consultation with the ACCO, shall prepare a written analysis of the delay (including a preliminary determination of the causes of delay, the beginning and end dates for each such cause of delay, and whether the delays are excusable under the terms of this Contract). The report shall be subject to review by and approval of the Board, which shall have authority to question its analysis and determinations and request additional facts or documentation. The report as reviewed and made final by the Board shall be made a part of the Agency contract file. Neither the report itself nor anything contained therein shall operate as a waiver or release of any claim the City may have against the Contractor for either actual or liquidated damages.

13.9.3 Approval Mechanism for Time Extensions for Substantial Completion or Final Completion Payments: An extension shall be granted only with the approval of the Board which is comprised of the ACCO of the Agency, the City Corporation Counsel, and the Comptroller, or their authorized representatives.

13.9.4 Neither the granting of any application for an extension of time to the Contractor or any Other Contractor on this Project nor the papers, records or reports related to any application for or grant of an extension of time or determination related thereto shall be referred to or offered in evidence by the Contractor or its attorneys in any action or proceeding.

13.10 No Damage for Delay: The Contractor agrees to make no claim for damages for delay in the performance of this Contract occasioned by any act or omission to act of the City or any of its representatives, except as provided for in Article 11.

#### **ARTICLE 14. COMPLETION AND FINAL ACCEPTANCE OF THE WORK**

14.1 Date for Substantial Completion: The Contractor shall substantially complete the Work within the time fixed in Schedule A of the General Conditions, or within the time to which such Substantial Completion may be extended.

14.2 **Determining the Date of Substantial Completion:** The Work will be deemed to be substantially complete when the two conditions set forth below have been met.

14.2.1 **Inspection:** The Engineer or Resident Engineer, as applicable, has inspected the Work and has made a written determination that it is substantially complete.

14.2.2 **Approval of Final Approved Punch List and Date for Final Acceptance:** Following inspection of the Work, the Engineer/Resident Engineer shall furnish the Contractor with a final punch list, specifying all items of Work to be completed and proposing dates for the completion of each specified item of Work. The Contractor shall then submit in writing to the Engineer/Resident Engineer within ten (10) Days of the Engineer/Resident Engineer furnishing the final punch list either acceptance of the dates or proposed alternative dates for the completion of each specified item of Work. If the Contractor neither accepts the dates nor proposes alternative dates within ten (10) Days, the schedule proposed by the Engineer/Resident Engineer shall be deemed accepted. If the Contractor proposes alternative dates, then, within a reasonable time after receipt, the Engineer/Resident Engineer, in a written notification to the Contractor, shall approve the Contractor's completion dates or, if they are unable to agree, the Engineer/Resident Engineer shall establish dates for the completion of each item of Work. The latest completion date specified shall be the date for Final Acceptance of the Work.

14.3 **Date of Substantial Completion.** The date of approval of the Final Approved Punch List, shall be the date of Substantial Completion. The date of approval of the Final Approved Punch List shall be either (a) if the Contractor approves the final punch list and proposed dates for completion furnished by the Engineer/Resident Engineer, the date of the Contractor's approval; or (b) if the Contractor neither accepts the dates nor proposes alternative dates, ten (10) Days after the Engineer/Resident Engineer furnishes the Contractor with a final punch list and proposed dates for completion; or (c) if the Contractor proposes alternative dates, the date that the Engineer/Resident Engineer sends written notification to the Contractor either approving the Contractor's proposed alternative dates or establishing dates for the completion for each item of Work.

14.4 **Determining the Date of Final Acceptance:** The Work will be accepted as final and complete as of the date of the Engineer's/Resident Engineer's inspection if, upon such inspection, the Engineer/Resident Engineer finds that all items on the Final Approved Punch List are complete and no further Work remains to be done. The Commissioner will then issue a written determination of Final Acceptance.

14.5 **Request for Inspection:** Inspection of the Work by the Engineer/Resident Engineer for the purpose of Substantial Completion or Final Acceptance shall be made within fourteen (14) Days after receipt of the Contractor's written request therefor.

14.6 **Request for Re-inspection:** If upon inspection for the purpose of Substantial Completion or Final Acceptance, the Engineer/Resident Engineer determines that there are items of Work still to be performed, the Contractor shall promptly perform them and then request a re-inspection. If upon re-inspection, the Engineer/Resident Engineer determines that the Work is substantially complete or finally accepted, the date of such re-inspection shall be the date of Substantial Completion or Final Acceptance. Re-inspection by the Engineer/Resident Engineer shall be made within ten (10) Days after receipt of the Contractor's written request therefor.

14.7 Initiation of Inspection by the Engineer/Resident Engineer: If the Contractor does not request inspection or re-inspection of the Work for the purpose of Substantial Completion or Final Acceptance, the Engineer/Resident Engineer may initiate such inspection or re-inspection.

#### **ARTICLE 15. LIQUIDATED DAMAGES**

15.1 In the event the Contractor fails to substantially complete the Work within the time fixed for such Substantial Completion in Schedule A of the General Conditions, plus authorized time extensions, or if the Contractor, in the sole determination of the Commissioner, has abandoned the Work, the Contractor shall pay to the City the sum fixed in Schedule A of the General Conditions, for each and every Day that the time consumed in substantially completing the Work exceeds the time allowed therefor; which said sum, in view of the difficulty of accurately ascertaining the loss which the City will suffer by reason of delay in the Substantial Completion of the Work hereunder, is hereby fixed and agreed as the liquidated damages that the City will suffer by reason of such delay, and not as a penalty. This Article 15 shall also apply to the Contractor whether or not the Contractor is defaulted pursuant to Chapter X of this Contract. Neither the failure to assess liquidated damages nor the granting of any time extension shall operate as a waiver or release of any claim the City may have against the Contractor for either actual or liquidated damages.

15.2 Liquidated damages received hereunder are not intended to be nor shall they be treated as either a partial or full waiver or discharge of the City's right to indemnification, or the Contractor's obligation to indemnify the City, or to any other remedy provided for in this Contract or by Law.

15.3 The Commissioner may deduct and retain out of the monies which may become due hereunder, the amount of any such liquidated damages; and in case the amount which may become due hereunder shall be less than the amount of liquidated damages suffered by the City, the Contractor shall be liable to pay the difference.

#### **ARTICLE 16. OCCUPATION OR USE PRIOR TO COMPLETION**

16.1 Unless otherwise provided for in the Specifications, the Commissioner may take over, use, occupy or operate any part of the Work at any time prior to Final Acceptance, upon written notification to the Contractor. The Engineer or Resident Engineer, as applicable, shall inspect the part of the Work to be taken over, used, occupied, or operated, and will furnish the Contractor with a written statement of the Work, if any, which remains to be performed on such part. The Contractor shall not object to, nor interfere with, the Commissioner's decision to exercise the rights granted by Article 16. In the event the Commissioner takes over, uses, occupies, or operates any part of the Work:

16.1.1 the Engineer/Resident Engineer shall issue a written determination of Substantial Completion with respect to such part of the Work;

16.1.2 the Contractor shall be relieved of its absolute obligation to protect such part of the unfinished Work in accordance with Article 7;

16.1.3 the Contractor's guarantee on such part of the Work shall begin on the date of such use by the City; and;

16.1.4 the Contractor shall be entitled to a return of so much of the amount retained in accordance with Article 21 as it relates to such part of the Work, except so much thereof as may be retained under Articles 24 and 44.

## CHAPTER IV: SUBCONTRACTS AND ASSIGNMENTS

### ARTICLE 17. SUBCONTRACTS

17.1 The Contractor shall not make subcontracts totaling an amount more than the percentage of the total Contract price fixed in Schedule A of the General Conditions, without prior written permission from the Commissioner. All subcontracts made by the Contractor shall be in writing. No Work may be performed by a Subcontractor prior to the Contractor entering into a written subcontract with the Subcontractor and complying with the provisions of this Article 17.

17.2 Before making any subcontracts, the Contractor shall submit a written statement to the Commissioner giving the name and address of the proposed Subcontractor; the portion of the Work and materials which it is to perform and furnish; the cost of the subcontract; the VENDEX questionnaire if required; the proposed subcontract if requested by the Commissioner; and any other information tending to prove that the proposed Subcontractor has the necessary facilities, skill, integrity, past experience, and financial resources to perform the Work in accordance with the terms and conditions of this Contract.

17.3 In addition to the requirements in Article 17.2, Contractor is required to list the Subcontractor in the web based Subcontractor Reporting System through the City's Payee Information Portal (PIP), available at [www.nyc.gov/pip](http://www.nyc.gov/pip).<sup>1</sup> For each Subcontractor listed, Contractor is required to provide the following information: maximum contract value, description of Subcontractor's Work, start and end date of the subcontract and identification of the Subcontractor's industry. Thereafter, Contractor will be required to report in the system the payments made to each Subcontractor within 30 days of making the payment. If any of the required information changes throughout the Term of the Contract, Contractor will be required to revise the information in the system.

Failure of the Contractor to list a Subcontractor and/or to report Subcontractor payments in a timely fashion may result in the Commissioner declaring the Contractor in default of the Contract and will subject Contractor to liquidated damages in the amount of \$100 per day for each day that the Contractor fails to identify a Subcontractor along with the required information about the Subcontractor and/or fails to report payments to a Subcontractor, beyond the time frames set forth herein or in the notice from the City. Article 15 shall govern the issue of liquidated damages.

17.4 If an approved Subcontractor elects to subcontract any portion of its subcontract, the proposed sub-subcontract shall be submitted in the same manner as directed above.

17.5 The Commissioner will notify the Contractor in writing whether the proposed Subcontractor is approved. If the proposed Subcontractor is not approved, the Contractor may submit another proposed Subcontractor unless the Contractor decides to do the Work. No Subcontractor shall be permitted to enter or perform any work on the Site unless approved.

17.6 Before entering into any subcontract hereunder, the Contractor shall provide the proposed Subcontractor with a complete copy of this document and inform the proposed Subcontractor fully and completely of all provisions and requirements of this Contract relating either directly or indirectly to the Work to be performed and the materials to be furnished under such subcontract, and every such

<sup>1</sup> In order to use the new system, a PIP account will be required. Detailed instructions on creating a PIP account and using the new system are also available at [www.nyc.gov/pip](http://www.nyc.gov/pip). Additional assistance with PIP may be obtained by emailing the Financial Information Services Agency Help Desk at [pip@fisa.nyc.gov](mailto:pip@fisa.nyc.gov).

**Subcontractor shall expressly stipulate that all labor performed and materials furnished by the Subcontractor shall strictly comply with the requirements of this Contract.**

**17.7 Documents given to a prospective Subcontractor for the purpose of soliciting the Subcontractor's bid shall include either a copy of the bid cover or a separate information sheet setting forth the Project name, the Contract number (if available), the Agency (as noted in Article 2.1.6), and the Project's location.**

**17.8 The Commissioner's approval of a Subcontractor shall not relieve the Contractor of any of its responsibilities, duties, and liabilities hereunder. The Contractor shall be solely responsible to the City for the acts or defaults of its Subcontractor and of such Subcontractor's officers, agents, and employees, each of whom shall, for this purpose, be deemed to be the agent or employee of the Contractor to the extent of its subcontract.**

**17.9 If the Subcontractor fails to maintain the necessary facilities, skill, integrity, past experience, and financial resources (other than due to the Contractor's failure to make payments where required) to perform the Work in accordance with the terms and conditions of this Contract, the Contractor shall promptly notify the Commissioner and replace such Subcontractor with a newly approved Subcontractor in accordance with this Article 17.**

**17.10 The Contractor shall be responsible for ensuring that all Subcontractors performing Work at the Site maintain all insurance required by Law.**

**17.11 The Contractor shall promptly, upon request, file with the Engineer a conformed copy of the subcontract and its cost. The subcontract shall provide the following:**

**17.11.1 Payment to Subcontractors: The agreement between the Contractor and its Subcontractor shall contain the same terms and conditions as to method of payment for Work, labor, and materials, and as to retained percentages, as are contained in this Contract.**

**17.11.2 Prevailing Rate of Wages: The agreement between the Contractor and its Subcontractor shall include the prevailing wage rates and supplemental benefits to be paid in accordance with Labor Law Section 220.**

**17.11.3 Section 6-123 of the Administrative Code: Pursuant to the requirements of Section 6-123 of the Administrative Code, every agreement between the Contractor and a Subcontractor in excess of fifty thousand (\$50,000) dollars shall include a provision that the Subcontractor shall not engage in any unlawful discriminatory practice as defined in Title VIII of the Administrative Code (Section 8-101 *et seq.*).**

**17.11.4 All requirements required pursuant to federal and/or state grant agreement(s), if applicable to the Work.**

**17.12 The Commissioner may deduct from the amounts certified under this Contract to be due to the Contractor, the sum or sums due and owing from the Contractor to the Subcontractors according to the terms of the said subcontracts, and in case of dispute between the Contractor and its Subcontractor, or Subcontractors, as to the amount due and owing, the Commissioner may deduct and withhold from the amounts certified under this Contract to be due to the Contractor such sum or sums as may be claimed by such Subcontractor, or Subcontractors, in a sworn affidavit, to be due and owing until such time as such claim or claims shall have been finally resolved.**



17.13 On contracts where performance bonds and payment bonds are executed, the Contractor shall include on each requisition for payment the following data: Subcontractor's name, value of the subcontract, total amount previously paid to Subcontractor for Work previously requisitioned, and the amount, including retainage, to be paid to the Subcontractor for Work included in the requisition.

17.14 On Contracts where performance bonds and payment bonds are not executed, the Contractor shall include with each requisition for payment submitted hereunder, a signed statement from each and every Subcontractor and/or Materialman for whom payment is requested in such requisition. Such signed statement shall be on the letterhead of the Subcontractor and/or Materialman for whom payment is requested and shall (i) verify that such Subcontractor and/or Materialman has been paid in full for all Work performed and/or material supplied to date, exclusive of any amount retained and any amount included on the current requisition, and (ii) state the total amount of retainage to date, exclusive of any amount retained on the current requisition.

#### ARTICLE 18. ASSIGNMENTS

18.1 The Contractor shall not assign, transfer, convey or otherwise dispose of this Contract, or the right to execute it, or the right, title or interest in or to it or any part thereof, or assign, by power of attorney or otherwise any of the monies due or to become due under this Contract, unless the previous written consent of the Commissioner shall first be obtained thereto, and the giving of any such consent to a particular assignment shall not dispense with the necessity of such consent to any further or other assignments.

18.2 Such assignment, transfer, conveyance or other disposition of this Contract shall not be valid until filed in the office of the Commissioner and the Comptroller, with the written consent of the Commissioner endorsed thereon or attached thereto.

18.3 Failure to obtain the previous written consent of the Commissioner to such an assignment, transfer, conveyance or other disposition, may result in the revocation and annulment of this Contract. The City shall thereupon be relieved and discharged from any further liability to the Contractor, its assignees, transferees or sublessees, who shall forfeit and lose all monies therefor earned under the Contract, except so much as may be required to pay the Contractor's employees.

18.4 The provisions of this clause shall not hinder, prevent, or affect an assignment by the Contractor for the benefit of its creditors made pursuant to the Laws of the State of New York.

18.5 This Contract may be assigned by the City to any corporation, agency or instrumentality having authority to accept such assignment.

### **CHAPTER V: CONTRACTOR'S SECURITY AND GUARANTEE**

#### ARTICLE 19. SECURITY DEPOSIT

19.1 If performance and payment bonds are required, the City shall retain the bid security to ensure that the successful bidder executes the Contract and furnishes the required payment and performance security within ten (10) Days after notice of the award of the Contract. If the successful bidder fails to execute the Contract and furnish the required payment and performance security, the City shall retain such bid security as set forth in the Information for Bidders. If the successful bidder executes the

Contract and furnishes the required payment and performance security, the City shall return the bid security within a reasonable time after the furnishing of such bonds and execution of the Contract by the City.

19.2 If performance and payment bonds are not required, the bid security shall be retained by the City as security for the Contractor's faithful performance of the Contract. If partial payments are provided, the bid security will be returned to the Contractor after the sum retained under Article 21 equals the amount of the bid security, subject to other provisions of this Contract. If partial payments are not provided, the bid security will be released when final payment is certified by the City for payment.

19.3 If the Contractor is declared in default under Article 48 prior to the return of the deposit, or if any claim is made such as referred to in Article 23, the amount of such deposit, or so much thereof as the Comptroller may deem necessary, may be retained and then applied by the Comptroller:

19.3.1 To compensate the City for any expense, loss or damage suffered or incurred by reason of or resulting from such default, including the cost of re-letting and liquidated damages; or

19.3.2 To indemnify the City against any and all claims.

#### ARTICLE 20. PAYMENT GUARANTEE

20.1 On Contracts where one hundred (100%) percent performance bonds and payment bonds are executed, this Article 20 does not apply.

20.2 In the event the terms of this Contract do not require the Contractor to provide a payment bond or where the Contract does not require a payment bond for one hundred (100%) percent of the Contract price, the City shall, in accordance with the terms of this Article 20, guarantee payment of all lawful claims for:

20.2.1 Wages and compensation for labor performed and/or services rendered; and

20.2.2 Materials, equipment, and supplies provided, whether incorporated into the Work or not, when demands have been filed with the City as provided hereinafter by any person, firm, or corporation which furnished labor, material, equipment, supplies, or any combination thereof, in connection with the Work performed hereunder (hereinafter referred to as the "beneficiary") at the direction of the City or the Contractor.

20.3 The provisions of Article 20.2 are subject to the following limitations and conditions:

20.3.1 If the Contractor provides a payment bond for a value that is less than one hundred (100%) percent of the value of the Contract Work, the payment bond provided by the Contractor shall be primary (and non-contributing) to the payment guarantee provided under this Article 20.

20.3.2 The guarantee is made for the benefit of all beneficiaries as defined in Article 20.2 provided that those beneficiaries strictly adhere to the terms and conditions of Article 20.3.4 and 20.3.5.

20.3.3 Nothing in this Article 20 shall prevent a beneficiary providing labor, services or material for the Work from suing the Contractor for any amounts due and owing the beneficiary by the Contractor.

20.3.4 Every person who has furnished labor or material, to the Contractor or to a Subcontractor of the Contractor, in the prosecution of the Work and who has not been paid in full therefor before the expiration of a period of ninety (90) Days after the date on which the last of the labor was performed or material was furnished by him/her for which the claim is made, shall have the right to sue on this payment guarantee in his/her own name for the amount, or the balance thereof, unpaid at the time of commencement of the action; provided, however, that a person having a direct contractual relationship with a Subcontractor of the Contractor but no contractual relationship express or implied with the Contractor shall not have a right of action upon the guarantee unless he/she shall have given written notice to the Contractor within one hundred twenty (120) Days from the date on which the last of the labor was performed or the last of the material was furnished, for which his/her claim is made, stating with substantial accuracy the amount claimed and the name of the party to whom the material was furnished or for whom the labor was performed. The notice shall be served by delivering the same personally to the Contractor or by mailing the same by registered mail, postage prepaid, in an envelope addressed to the Contractor at any place where it maintains an office or conducts its business; provided, however, that where such notice is actually received by the Contractor by other means, such notice shall be deemed sufficient.

20.3.5 Except as provided in Labor Law Section 220-g, no action on this payment guarantee shall be commenced after the expiration of the one-year limitations period set forth in Section 137(4)(b) of the State Finance Law.

20.3.6 The Contractor shall promptly forward to the City any notice or demand received pursuant to Article 20.3.4. The Contractor shall inform the City of any defenses to the notice or demand and shall forward to the City any documents the City requests concerning the notice or demand.

20.3.7 All demands made against the City by a beneficiary of this payment guarantee shall be presented to the Engineer along with all written documentation concerning the demand which the Engineer deems reasonably appropriate or necessary, which may include, but shall not be limited to: the subcontract; any invoices presented to the Contractor for payment; the notarized statement of the beneficiary that the demand is due and payable, that a request for payment has been made of the Contractor and that the demand has not been paid by the Contractor within the time allowed for such payment by the subcontract; and copies of any correspondence between the beneficiary and the Contractor concerning such demand. The City shall notify the Contractor that a demand has been made. The Contractor shall inform the City of any defenses to the demand and shall forward to the City any documents the City requests concerning the demand.

20.3.8 The City shall make payment only if, after considering all defenses presented by the Contractor, it determines that the payment is due and owing to the beneficiary making the demand.

20.3.9 No beneficiary shall be entitled to interest from the City, or to any other costs, including, but not limited to, attorneys' fees, except to the extent required by State Finance Law Section 137.

20.4 Upon the receipt by the City of a demand pursuant to this Article 20, the City may withhold from any payment otherwise due and owing to the Contractor under this Contract an amount sufficient to satisfy the demand.

20.4.1 In the event the City determines that the demand is valid, the City shall notify the Contractor of such determination and the amount thereof and direct the Contractor to immediately pay such amount to the beneficiary. In the event the Contractor, within seven (7) Days of receipt of such notification from the City, fails to pay the beneficiary, such failure shall constitute an automatic and irrevocable assignment of payment by the Contractor to the beneficiary for the amount of the demand determined by the City to be valid. The Contractor, without further notification or other process, hereby gives its unconditional consent to such assignment of payment to the beneficiary and authorizes the City, on its behalf, to take all necessary actions to implement such assignment of payment, including without limitation the execution of any instrument or documentation necessary to effectuate such assignment.

20.4.2 In the event that the amount otherwise due and owing to the Contractor by the City is insufficient to satisfy such demand, the City may, at its option, require payment from the Contractor of an amount sufficient to cover such demand and exercise any other right to require or recover payment which the City may have under Law or Contract.

20.4.3 In the event the City determines that the demand is invalid, any amount withheld pending the City's review of such demand shall be paid to the Contractor; provided, however, no lien has been filed. In the event a claim or an action has been filed, the terms and conditions set forth in Article 23 shall apply. In the event a lien has been filed, the parties will be governed by the provisions of the Lien Law of the State of New York.

20.5 The provisions of this Article 20 shall not prevent the City and the Contractor from resolving disputes in accordance with the PPB Rules, where applicable.

20.6 In the event the City determines that the beneficiary is entitled to payment pursuant to this Article 20, such determination and any defenses and counterclaims raised by the Contractor shall be taken into account in evaluating the Contractor's performance.

20.7 Nothing in this Article 20 shall relieve the Contractor of the obligation to pay the claims of all persons with valid and lawful claims against the Contractor relating to the Work.

20.8 The Contractor shall not require any performance, payment or other bonds of any Subcontractor if this Contract does not require such bonds of the Contractor.

20.9 The payment guarantee made pursuant to this Article 20 shall be construed in a manner consistent with Section 137 of the State Finance Law and shall afford to persons furnishing labor or materials to the Contractor or its Subcontractors in the prosecution of the Work under this Contract all of the rights and remedies afforded to such persons by such section, including but not limited to, the right to commence an action against the City on the payment guarantee provided by this Article 20 within the one-year limitations period set forth in Section 137(4)(b).

#### **ARTICLE 21. RETAINED PERCENTAGE**

21.1 If this Contract requires one hundred (100%) percent performance and payment security, then as further security for the faithful performance of this Contract, the Commissioner shall deduct, and

retain until the substantial completion of the Work, five (5%) percent of the value of Work certified for payment in each partial payment voucher.

21.2 If this Contract does not require one hundred (100%) percent performance and payment security and if the price for which this Contract was awarded does not exceed one million (\$1,000,000) dollars, then as further security for the faithful performance of this Contract, the Commissioner shall deduct, and retain until the substantial completion of the Work, five (5%) percent of the value of Work certified for payment in each partial payment voucher.

21.3 If this Contract does not require one hundred (100%) percent performance and payment security and if the price for which this Contract was awarded exceeds one million (\$1,000,000) dollars, then as further security for the faithful performance of this Contract, the Commissioner shall deduct, and retain until the substantial completion of the Work, up to ten (10%) percent of the value of Work certified for payment in each partial payment voucher. The percentage to be retained is set forth in Schedule A of the General Conditions.

## **ARTICLE 22. INSURANCE**

22.1 Types of Insurance: The Contractor shall procure and maintain the following types of insurance if, and as indicated, in Schedule A of the General Conditions (with the minimum limits and special conditions specified in Schedule A). Such insurance shall be maintained from the date the Contractor is required to provide Proof of Insurance pursuant to Article 22.3.1 through the date of completion of all required Work (including punch list work as certified in writing by the Resident Engineer), except for insurance required pursuant to Article 22.1.4, which may terminate upon Substantial Completion of the Contract. All insurance shall meet the requirements set forth in this Article 22. Wherever this Article requires that insurance coverage be "at least as broad" as a specified form (including all ISO forms), there is no obligation that the form itself be used, provided that the Contractor can demonstrate that the alternative form or endorsement contained in its policy provides coverage at least as broad as the specified form.

22.1.1 Commercial General Liability Insurance: The Contractor shall provide Commercial General Liability Insurance covering claims for property damage and/or bodily injury, including death, which may arise from any of the operations under this Contract. Coverage under this insurance shall be at least as broad as that provided by the latest edition of Insurance Services Office ("ISO") Form CG 0001. Such insurance shall be "occurrence" based rather than "claims-made" and include, without limitation, the following types of coverage: premises operations; products and completed operations; contractual liability (including the tort liability of another assumed in a contract); broad form property damage; independent contractors; explosion, collapse and underground (XCU); construction means and methods; and incidental malpractice. Such insurance shall contain a "per project" aggregate limit, as specified in Schedule A, that applies separately to operations under this Contract.

22.1.1(a) Such Commercial General Liability Insurance shall name the City as an Additional Insured. Coverage for the City shall specifically include the City's officials and employees, be at least as broad as the latest edition of ISO Form CG 20 10 and provide completed operations coverage at least as broad as the latest edition of ISO Form CG 20 37.

22.1.1(b) Such Commercial General Liability Insurance shall name all other entities designated as additional insureds in Schedule A but only for claims arising from the

**Contractor's operations under this Contract, with coverage at least as broad as the latest edition of ISO Form CG 20 26.**

**22.1.1(c) If the Work requires a permit from the Department of Buildings pursuant to 1 RCNY Section 101-08, the Contractor shall provide Commercial General Liability Insurance with limits of at least those required by 1 RCNY section 101-08 or greater limits required by the Agency in accordance with Schedule A. If the Work does not require such a permit, the minimum limits shall be those provided for in Schedule A.**

**22.1.1(d) If any of the Work includes repair of a waterborne vessel owned by or to be delivered to the City, such Commercial General Liability shall include, or be endorsed to include, Ship Repairer's Legal Liability Coverage to protect against, without limitation, liability arising from navigation of such vessels prior to delivery to and acceptance by the City.**

**22.1.2 Workers' Compensation Insurance, Employers' Liability Insurance, and Disability Benefits Insurance: The Contractor shall provide, and shall cause its Subcontractors to provide, Workers Compensation Insurance, Employers' Liability Insurance, and Disability Benefits Insurance in accordance with the Laws of the State of New York on behalf of all employees providing services under this Contract (except for those employees, if any, for which the Laws require insurance only pursuant to Article 22.1.3).**

**22.1.3 United States Longshoremen's and Harbor Workers Act and/or Jones Act Insurance: If specified in Schedule A of the General Conditions or if required by Law, the Contractor shall provide insurance in accordance with the United States Longshoremen's and Harbor Workers Act and/or the Jones Act, on behalf of all qualifying employees providing services under this Contract.**

**22.1.4 Builders Risk Insurance: If specified in Schedule A of the General Conditions, the Contractor shall provide Builders Risk Insurance on a completed value form for the total value of the Work through Substantial Completion of the Work in its entirety. Such insurance shall be provided on an All Risk basis and include coverage, without limitation, for windstorm (including named windstorm), storm surge, flood and earth movement. Unless waived by the Commissioner, it shall include coverage for ordinance and law, demolition and increased costs of construction, debris removal, pollutant clean up and removal, and expediting costs. Such insurance shall cover, without limitation, (a) all buildings and/or structures involved in the Work, as well as temporary structures at the Site, and (b) any property that is intended to become a permanent part of such building or structure, whether such property is on the Site, in transit or in temporary storage. Policies shall name the Contractor as Named Insured and list the City as both an Additional Insured and a Loss Payee as its interest may appear.**

**22.1.4(a) Policies of such insurance shall specify that, in the event a loss occurs at an occupied facility, occupancy of such facility is permitted without the consent of the issuing insurance company.**

**22.1.4(b) Such insurance may be provided through an Installation Floater, at the Contractor's option, if it otherwise conforms with the requirements of this Article 22.1.4.**

**22.1.5 Commercial Automobile Liability Insurance: The Contractor shall provide Commercial Automobile Liability Insurance for liability arising out of ownership,**

maintenance or use of any owned (if any), non-owned and hired vehicles to be used in connection with this Contract. Coverage shall be at least as broad as the latest edition of ISO Form CA0001. If vehicles are used for transporting hazardous materials, the Automobile Liability Insurance shall be endorsed to provide pollution liability broadened coverage for covered vehicles (endorsement CA 99 48) as well as proof of MCS 90.

**22.1.6 Contractors Pollution Liability Insurance:** If specified in Schedule A of the General Conditions, the Contractor shall maintain, or cause the Subcontractor doing such Work to maintain, Contractor's Pollution Liability Insurance covering bodily injury and property damage. Such insurance shall provide coverage for actual, alleged or threatened emission, discharge, dispersal, seepage, release or escape of pollutants (including asbestos), including any loss, cost or expense incurred as a result of any cleanup of pollutants (including asbestos) or in the investigation, settlement or defense of any claim, action, or proceedings arising from the operations under this Contract. Such insurance shall be in the Contractor's name and list the City as an Additional Insured and any other entity specified in Schedule A. Coverage shall include, without limitation, (a) loss of use of damaged property or of property that has not been physically injured, (b) transportation, and (c) non-owned disposal sites.

**22.1.6(a) Coverage for the City as Additional Insured shall specifically include the City's officials and employees and be at least as broad as provided to the Contractor for this Project.**

**22.1.6(b) If such insurance is written on a claims-made policy, such policy shall have a retroactive date on or before the effective date of this Contract, and continuous coverage shall be maintained, or an extended discovery period exercised, for a period of not less than three (3) years from the time the Work under this Contract is completed.**

**22.1.7 Marine Insurance:**

**22.1.7(a) Marine Protection and Indemnity Insurance:** If specified in Schedule A of the General Conditions or if the Contractor engages in marine operations in the execution of any part of the Work, the Contractor shall maintain, or cause the Subcontractor doing such Work to maintain, Marine Protection and Indemnity Insurance with coverage at least as broad as Form SP-23. The insurance shall provide coverage for the Contractor or Subcontractor (whichever is doing this Work) and for the City (together with its officials and employees) and any other entity specified in Schedule A as an Additional Insured for bodily injury and property damage arising from marine operations under this Contract. Coverage shall include, without limitation, injury or death of crew members (if not fully provided through other insurance), removal of wreck, damage to piers, wharves and other fixed or floating objects and loss of or damage to any other vessel or craft, or to property on such other vessel or craft.

**22.1.7(b) Hull and Machinery Insurance:** If specified in Schedule A of the General Conditions or if the Contractor engages in marine operations in the execution of any part of the Work, the Contractor shall maintain, or cause the Subcontractor doing such Work to maintain, Hull and Machinery Insurance with coverage for the Contractor or Subcontractor (whichever is doing this Work) and for the City (together with its officials and employees) as Additional Insured at least as broad as the latest edition of American Institute Tug Form for all tugs used under this

**Contract and Collision Liability** at least as broad as the latest edition of American Institute Hull Clauses.

22.1.7(c) **Marine Pollution Liability Insurance:** If specified in Schedule A of the General Conditions or if the **Contractor** engages in marine operations in the execution of any part of the **Work**, the **Contractor** shall maintain, or cause the **Subcontractor** doing such **Work** to maintain, Marine Pollution Liability Insurance covering itself (or the **Subcontractor** doing such **Work**) as Named Insured and the **City** (together with its officials and employees) and any other entity specified in Schedule A as an Additional Insured. Coverage shall be at least as broad as that provided by the latest edition of Water Quality Insurance Syndicate Form and include, without limitation, liability arising from the discharge or substantial threat of a discharge of oil, or from the release or threatened release of a hazardous substance including injury to, or economic losses resulting from, the destruction of or damage to real property, personal property or natural resources.

22.1.8 The **Contractor** shall provide such other types of insurance, at such minimum limits and with such conditions, as are specified in Schedule A of the General Conditions.

## 22.2 General Requirements for Insurance Coverage and Policies:

22.2.1 All required insurance policies shall be maintained with companies that may lawfully issue the required policy and have an A.M. Best rating of at least A-/VII or a Standard and Poor's rating of at least A, unless prior written approval is obtained from the **City Corporation Counsel**.

22.2.2 The **Contractor** shall be solely responsible for the payment of all premiums for all required policies and all deductibles and self-insured retentions to which such policies are subject, whether or not the **City** is an insured under the policy.

22.2.3 In his/her sole discretion, the **Commissioner** may, subject to the approval of the **Comptroller** and the **City Corporation Counsel**, accept Letters of Credit and/or custodial accounts in lieu of required insurance.

22.2.4 The **City's** limits of coverage for all types of insurance required pursuant to Schedule A of the General Conditions shall be the greater of (i) the minimum limits set forth in Schedule A or (ii) the limits provided to the **Contractor** as Named Insured under all primary, excess, and umbrella policies of that type of coverage.

22.2.5 The **Contractor** may satisfy its insurance obligations under this Article 22 through primary policies or a combination of primary and excess/umbrella policies, so long as all policies provide the scope of coverage required herein.

22.2.6 Policies of insurance provided pursuant to this Article 22 shall be primary and non-contributing to any insurance or self-insurance maintained by the **City**.

## 22.3 Proof of Insurance:

22.3.1 For all types of insurance required by Article 22.1 and Schedule A, except for insurance required by Articles 22.1.4 and 22.1.7, the **Contractor** shall file proof of insurance in accordance with this Article 22.3 within ten (10) Days of award. For insurance



provided pursuant to Articles 22.1.4 and 22.1.7, proof shall be filed by a date specified by the **Commissioner** or ten (10) **Days** prior to the commencement of the portion of the **Work** covered by such policy, whichever is earlier.

22.3.2 For **Workers' Compensation Insurance** provided pursuant to Article 22.1.2, the **Contractor** shall submit one of the following forms: C-105.2 **Certificate of Workers' Compensation Insurance**; U-26.3 - **State Insurance Fund Certificate of Workers' Compensation Insurance**; **Request for WC/DB Exemption (Form CE-200)**; equivalent or successor forms used by the **New York State Workers' Compensation Board**; or other proof of insurance in a form acceptable to the **Commissioner**. For **Disability Benefits Insurance** provided pursuant to Article 22.1.2, the **Contractor** shall submit **DB-120.1 - Certificate Of Insurance Coverage Under The NYS Disability Benefits Law, Request for WC/DB Exemption (Form CE-200)**; equivalent or successor forms used by the **New York State Workers' Compensation Board**; or other proof of insurance in a form acceptable to the **Commissioner**. **ACORD forms are not acceptable.**

22.3.3 For policies provided pursuant to all of Article 22.1 other than Article 22.1.2, the **Contractor** shall submit one or more **Certificates of Insurance** on forms acceptable to the **Commissioner**. All such **Certificates of Insurance** shall certify (a) the issuance and effectiveness of such policies of insurance, each with the specified minimum limits (b) for insurance secured pursuant to Article 22.1.1 that the **City** and any other entity specified in **Schedule A** is an **Additional Insured** thereunder; (c) in the event insurance is required pursuant to Article 22.1.6 and/or Article 22.1.7, that the **City** is an **Additional Insured** thereunder; (d) the company code issued to the insurance company by the **National Association of Insurance Commissioners (the NAIC number)**; and (e) the number assigned to the **Contract** by the **City**. All such **Certificates of Insurance** shall be accompanied by either a duly executed "**Certification by Insurance Broker or Agent**" in the form contained in **Part III of Schedule A** or copies of all policies referenced in such **Certificate of Insurance** as certified by an authorized representative of the issuing insurance carrier. If any policy is not available at the time of submission, certified binders may be submitted until such time as the policy is available, at which time a certified copy of the policy shall be submitted.

22.3.4 Documentation confirming renewals of insurance shall be submitted to the **Commissioner** prior to the expiration date of coverage of policies required under this **Contract**. Such proofs of insurance shall comply with the requirements of Articles 22.3.2 and 22.3.3.

22.3.5 The **Contractor** shall be obligated to provide the **City** with a copy of any policy of insurance provided pursuant to this Article 22 upon the demand for such policy by the **Commissioner** or the **City Corporation Counsel**.

#### 22.4 Operations of the Contractor:

22.4.1 The **Contractor** shall not commence the **Work** unless and until all required certificates have been submitted to and accepted by the **Commissioner**. Acceptance by the **Commissioner** of a certificate does not excuse the **Contractor** from securing insurance consistent with all provisions of this Article 22 or of any liability arising from its failure to do so.

22.4.2 The **Contractor** shall be responsible for providing continuous insurance coverage in the manner, form, and limits required by this **Contract** and shall be authorized to perform **Work** only during the effective period of all required coverage.

22.4.3 In the event that any of the required insurance policies lapse, are revoked, suspended or otherwise terminated, for whatever cause, the Contractor shall immediately stop all Work, and shall not recommence Work until authorized in writing to do so by the Commissioner. Upon quitting the Site, except as otherwise directed by the Commissioner, the Contractor shall leave all plant, materials, equipment, tools, and supplies on the Site. Contract time shall continue to run during such periods and no extensions of time will be granted. The Commissioner may also declare the Contractor in default for failure to maintain required insurance.

22.4.4 In the event the Contractor receives notice, from an insurance company or other person, that any insurance policy required under this Article 22 shall be cancelled or terminated (or has been cancelled or terminated) for any reason, the Contractor shall immediately forward a copy of such notice to both the Commissioner and the New York City Comptroller, attn: Office of Contract Administration, Municipal Building, One Centre Street, room 1005, New York, New York 10007. Notwithstanding the foregoing, the Contractor shall ensure that there is no interruption in any of the insurance coverage required under this Article 22.

22.4.5 Where notice of loss, damage, occurrence, accident, claim or suit is required under an insurance policy maintained in accordance with this Article 22, the Contractor shall notify in writing all insurance carriers that issued potentially responsive policies of any such event relating to any operations under this Contract (including notice to Commercial General Liability insurance carriers for events relating to the Contractor's own employees) no later than 20 days after such event. For any policy where the City is an Additional Insured, such notice shall expressly specify that "this notice is being given on behalf of the City of New York as Insured as well as the Named Insured." Such notice shall also contain the following information: the number of the insurance policy, the name of the named insured, the date and location of the damage, occurrence, or accident, and the identity of the persons or things injured, damaged or lost. The Contractor shall simultaneously send a copy of such notice to the City of New York c/o Insurance Claims Specialist, Affirmative Litigation Division, New York City Law Department, 100 Church Street, New York, New York 10007.

22.4.6 In the event of any loss, accident, claim, action, or other event that does or can give rise to a claim under any insurance policy required under this Article 22, the Contractor shall at all times fully cooperate with the City with regard to such potential or actual claim.

**22.5 Subcontractor Insurance:** In the event the Contractor requires any Subcontractor to procure insurance with regard to any operations under this Contract and requires such Subcontractor to name the Contractor as an Additional Insured thereunder, the Contractor shall ensure that the Subcontractor name the City, including its officials and employees, as an Additional Insured with coverage at least as broad as the most recent edition of ISO Form CG 20 26.

22.6 Wherever reference is made in Article 7 or this Article 22 to documents to be sent to the Commissioner (e.g., notices, filings, or submissions), such documents shall be sent to the address set forth in Schedule A of the General Conditions. In the event no address is set forth in Schedule A, such documents are to be sent to the Commissioner's address as provided elsewhere in this Contract.

22.7 Apart from damages or losses covered by insurance provided pursuant to Articles 22.1.2, 22.1.3, or 22.1.5, the Contractor waives all rights against the City, including its officials and employees, for any damages or losses that are covered under any insurance required under this Article 22 (whether or

not such insurance is actually procured or claims are paid thereunder) or any other insurance applicable to the operations of the Contractor and/or its employees, agents, or Subcontractors.

22.8 In the event the Contractor utilizes a self-insurance program to satisfy any of the requirements of this Article 22, the Contractor shall ensure that any such self-insurance program provides the City with all rights that would be provided by traditional insurance under this Article 22, including but not limited to the defense and indemnification obligations that insurers are required to undertake in liability policies.

22.9 Materiality/Non-Waiver: The Contractor's failure to secure policies in complete conformity with this Article 22, or to give an insurance company timely notice of any sort required in this Contract or to do anything else required by this Article 22 shall constitute a material breach of this Contract. Such breach shall not be waived or otherwise excused by any action or inaction by the City at any time.

22.10 Pursuant to General Municipal Law Section 108, this Contract shall be void and of no effect unless Contractor maintains Workers' Compensation Insurance for the term of this Contract to the extent required and in compliance with the New York State Workers' Compensation Law.

22.11 Other Remedies: Insurance coverage provided pursuant to this Article 22 or otherwise shall not relieve the Contractor of any liability under this Contract, nor shall it preclude the City from exercising any rights or taking such other actions available to it under any other provisions of this Contract or Law.

#### **ARTICLE 23. MONEY RETAINED AGAINST CLAIMS**

23.1 If any claim shall be made by any person or entity (including Other Contractors with the City on this Project) against the City or against the Contractor and the City for any of the following:

- (a) An alleged loss, damage, injury, theft or vandalism of any of the kinds referred to in Articles 7 and 12, plus the reasonable costs of defending the City, which in the opinion of the Comptroller may not be paid by an insurance company (for any reason whatsoever); or
- (b) An infringement of copyrights, patents or use of patented articles, tools, etc., as referred to in Article 57; or
- (c) Damage claimed to have been caused directly or indirectly by the failure of the Contractor to perform the Work in strict accordance with this Contract,

the amount of such claim, or so much thereof as the Comptroller may deem necessary, may be withheld by the Comptroller, as security against such claim, from any money due hereunder. The Comptroller, in his/her discretion, may permit the Contractor to substitute other satisfactory security in lieu of the monies so withheld.

23.2 If an action on such claim is timely commenced and the liability of the City, or the Contractor, or both, shall have been established therein by a final judgment of a court of competent jurisdiction, or if such claim shall have been admitted by the Contractor to be valid, the Comptroller shall pay such judgment or admitted claim out of the monies retained by the Comptroller under the provisions of this Article 23, and return the balance, if any, without interest, to the Contractor.

## **ARTICLE 24. MAINTENANCE AND GUARANTY**

24.1 The Contractor shall promptly repair, replace, restore or rebuild, as the Commissioner may determine, any finished Work in which defects of materials or workmanship may appear or to which damage may occur because of such defects, during the one (1) year period subsequent to the date of Substantial Completion (or use and occupancy in accordance with Article 16), except where other periods of maintenance and guaranty are provided for in Schedule A.

24.2 As security for the faithful performance of its obligations hereunder, the Contractor, upon filing its requisition for payment on Substantial Completion, shall deposit with the Commissioner a sum equal to one (1%) percent of the price (or the amount fixed in Schedule A of the General Conditions) in cash or certified check upon a state or national bank and trust company or a check of such bank and trust company signed by a duly authorized officer thereof and drawn to the order of the Comptroller, or obligations of the City, which the Comptroller may approve as of equal value with the sum so required.

24.3 In lieu of the above, the Contractor may make such security payment to the City by authorizing the Commissioner in writing to deduct the amount from the Substantial Completion payment which shall be deemed the deposit required above.

24.4 If the Contractor has faithfully performed all of its obligations hereunder the Commissioner shall so certify to the Comptroller within five (5) Days after the expiration of one (1) year from the date of Substantial Completion and acceptance of the Work or within thirty (30) Days after the expiration of the guarantee period fixed in the Specifications. The security payment shall be repaid to the Contractor without interest within thirty (30) Days after certification by the Commissioner to the Comptroller that the Contractor has faithfully performed all of its obligations hereunder.

24.5 Notice by the Commissioner to the Contractor to repair, replace, rebuild or restore such defective or damaged Work shall be timely, pursuant to this article, if given not later than ten (10) Days subsequent to the expiration of the one (1) year period or other periods provided for herein.

24.6 If the Contractor shall fail to repair, replace, rebuild or restore such defective or damaged Work promptly after receiving such notice, the Commissioner shall have the right to have the Work done by others in the same manner as provided for in the completion of a defaulted Contract, under Article 51.

24.7 If the security payment so deposited is insufficient to cover the cost of such Work, the Contractor shall be liable to pay such deficiency on demand by the Commissioner.

24.8 The Engineer's certificate setting forth the fair and reasonable cost of repairing, replacing, rebuilding or restoring any damaged or defective Work when performed by one other than the Contractor, shall be binding and conclusive upon the Contractor as to the amount thereof.

24.9 The Contractor shall obtain all manufacturers' warranties and guaranties of all equipment and materials required by this Contract in the name of the City and shall deliver same to the Commissioner. All of the City's rights and title and interest in and to said manufacturers' warranties and guaranties may be assigned by the City to any subsequent purchasers of such equipment and materials or lessees of the premises into which the equipment and materials have been installed.

## CHAPTER VI: CHANGES, EXTRA WORK, AND DOCUMENTATION OF CLAIM

### ARTICLE 25. CHANGES

25.1 Changes may be made to this Contract only as duly authorized in writing by the Commissioner in accordance with the Law and this Contract. All such changes, modifications, and amendments will become a part of the Contract. Work so ordered shall be performed by the Contractor.

25.2 Contract changes will be made only for Work necessary to complete the Work included in the original scope of the Contract and/or for non-material changes to the scope of the Contract. Changes are not permitted for any material alteration in the scope of Work in the Contract.

25.3 The Contractor shall be entitled to a price adjustment for Extra Work performed pursuant to a written change order. Adjustments to price shall be computed in one or more of the following ways:

25.3.1 By applicable unit prices specified in the Contract; and/or

25.3.2 By agreement of a fixed price; and/or

25.3.3 By time and material records; and/or

25.3.4 In any other manner approved by the CCPO.

25.4 All payments for change orders are subject to pre-audit by the Engineering Audit Officer and may be post-audited by the Comptroller and/or the Agency.

### ARTICLE 26. METHODS OF PAYMENT FOR OVERRUNS AND EXTRA WORK

26.1 **Overrun of Unit Price Item:** An overrun is any quantity of a unit price item which the Contractor is directed to provide which is in excess of one hundred twenty-five (125%) percent of the estimated quantity for that item set forth in the bid schedule.

26.1.1 For any unit price item, the Contractor will be paid at the unit price bid for any quantity up to one hundred twenty-five (125%) percent of the estimated quantity for that item set forth in the bid schedule. If during the progress of the Work, the actual quantity of any unit price item required to complete the Work approaches the estimated quantity for that item, and for any reason it appears that the actual quantity of any unit price item necessary to complete the Work will exceed the estimated quantity for that item by twenty-five (25%) percent, the Contractor shall immediately notify the Engineer of such anticipated overrun. The Contractor shall not be compensated for any quantity of a unit price item provided which is in excess of one hundred twenty-five (125%) percent of the estimated quantity for that item set forth in the bid schedule without written authorization from the Engineer.

26.1.2 If the actual quantity of any unit price item necessary to complete the Work will exceed one hundred twenty five (125%) percent of the estimated quantity for that item set forth in the bid schedule, the City reserves the right and the Contractor agrees to negotiate a new unit price for such item. In no event shall such negotiated new unit price exceed the unit bid price. If the City and Contractor cannot agree on a new unit price, then the City shall order the Contractor and the Contractor agrees to provide additional quantities of

the item on the basis of time and material records for the actual and reasonable cost as determined under Article 26.2, but in no event at a unit price exceeding the unit price bid.

**26.2 Extra Work:** For Extra Work where payment is by agreement on a fixed price in accordance with Article 25.3.2, the price to be paid for such Extra Work shall be based on the fair and reasonable estimated cost of the items set forth below. For Extra Work where payment is based on time and material records in accordance with Article 25.3.3, the price to be paid for such Extra Work shall be the actual and reasonable cost of the items set forth below, calculated in accordance with the formula specified therein, if any.

26.2.1 Necessary materials (including transportation to the Site); plus

26.2.2 Necessary direct labor, including payroll taxes (subject to statutory wage caps) and supplemental benefits; plus

26.2.3 Sales and personal property taxes, if any, required to be paid on materials not incorporated into such Extra Work; plus

26.2.4 Reasonable rental value of Contractor-owned (or Subcontractor-owned, as applicable), necessary plant and equipment other than Small Tools, plus fuel/energy costs. Except for fuel costs for pick-up trucks which shall be reimbursed based on a consumption of five (5) gallons per shift, fuel costs shall be reimbursed based on actual costs or, in the absence of auditable documentation, the following fuel consumption formula per operating hour:  $(.035) \times (\text{HP rating}) \times (\text{Fuel cost/gallon})$ . Reasonable rental value is defined as the lower of either seventy-five percent of the monthly prorated rental rates established in "The AED Green Book, Rental Rates and Specifications for Construction Equipment" published by Equipment Watch (the "Green Book"), or seventy-five percent of the monthly prorated rental rates established in the "Rental Rate Blue Book for Construction Equipment" published by Equipment Watch (the "Blue Book") (the applicable Blue Book rate being for rental only without the addition of any operational costs listed in the Blue Book). The reasonable rental value is deemed to be inclusive of all operating costs except for fuel/energy consumption and equipment operator's wages/costs. For multiple shift utilization, reimbursement shall be calculated as follows: first shift shall be seventy-five (75%) percent of such rental rates; second shift shall be sixty (60%) percent of the first shift rate; and third shift shall be forty (40%) percent of the first shift rate. Equipment on standby shall be reimbursed at one-third (1/3) the prorated monthly rental rate. Contractor-owned (or Subcontractor-owned, as applicable) equipment includes equipment from rental companies affiliated with or controlled by the Contractor (or Subcontractor, as applicable), as determined by the Commissioner. In establishing cost reimbursement for non-operating Contractor-owned (or Subcontractor-owned, as applicable) equipment (scaffolding, sheeting systems, road plates, etc.), the City may restrict reimbursement to a purchase-salvage/life cycle basis if less than the computed rental costs; plus

26.2.5 Necessary installation and dismantling of such plant and equipment, including transportation to and from the Site, if any, provided that, in the case of non-Contractor-owned (or non-Subcontractor-owned, as applicable) equipment rented from a third party, the cost of installation and dismantling are not allowable if such costs are included in the rental rate; plus

26.2.6 Necessary fees charged by governmental entities; plus

26.2.7 Necessary construction-related service fees charged by non-governmental entities, such as landfill tipping fees; plus

26.2.8 Reasonable rental costs of non-Contractor-owned (or non-Subcontractor-owned, as applicable) necessary plant and equipment other than Small Tools, plus fuel/energy costs. Except for fuel costs for pick-up trucks which shall be reimbursed based on a consumption of five (5) gallons per shift, fuel costs shall be reimbursed based on actual costs or, in the absence of auditable documentation, the following fuel consumption formula per hour of operation:  $(.035) \times (\text{HP rating}) \times (\text{Fuel cost/gallon})$ . In lieu of renting, the City reserves the right to direct the purchase of non-operating equipment (scaffolding, sheeting systems, road plates, etc.), with payment on a purchase-salvage/life cycle basis, if less than the projected rental costs; plus

26.2.9 Workers' Compensation Insurance, and any insurance coverage expressly required by the City for the performance of the Extra Work which is different than the types of insurance required by Article 22 and Schedule A of the General Conditions. The cost of Workers' Compensation Insurance is subject to applicable payroll limitation caps and shall be based upon the carrier's Manual Rate for such insurance derived from the applicable class Loss Cost ("LC") and carrier's Lost Cost Multiplier ("LCM") approved by the New York State Department of Financial Services, and with the exception of experience rating, rate modifiers as promulgated by the New York Compensation Insurance Rating Board ("NYCIRB"); plus

26.2.10 Additional costs incurred as a result of the Extra Work for performance and payment bonds; plus

26.2.11 Twelve percent (12%) percent of the total of items in Articles 26.2.1 through 26.2.5 as compensation for overhead, except that no percentage for overhead will be allowed on Payroll Taxes or on the premium portion of overtime pay or on sales and personal property taxes. Overhead shall include without limitation, all costs and expenses in connection with administration, management superintendence, small tools, and insurance required by Schedule A of the General Conditions other than Workers' Compensation Insurance; plus

26.2.12 Ten (10%) percent of the total of items in Articles 26.2.1 through 26.2.5, plus the items in Article 26.2.11, as compensation for profit, except that no percentage for profit will be allowed on Payroll Taxes or on the premium portion of overtime pay or on sales and personal property taxes; plus

26.2.13 Five (5%) percent of the total of items in Articles 26.2.6 through 26.2.10 as compensation for overhead and profit.

26.3 Where the Extra Work is performed in whole or in part by other than the Contractor's own forces pursuant to Article 26.2, the Contractor shall be paid, subject to pre-audit by the Engineering Audit Officer, the cost of such Work computed in accordance with Article 26.2 above, plus an additional allowance of five (5%) percent to cover the Contractor's overhead and profit.

26.4 Where a change is ordered, involving both Extra Work and omitted or reduced Contract Work, the Contract price shall be adjusted, subject to pre-audit by the EAO, in an amount based on the difference between the cost of such Extra Work and of the omitted or reduced Work.

26.5 Where the Contractor and the Commissioner can agree upon a fixed price for Extra Work in accordance with Article 25.3.2 or another method of payment for Extra Work in accordance with

Article 25.3.4, or for Extra Work ordered in connection with omitted Work, such method, subject to pre-audit by the EAO, may, at the option of the Commissioner, be substituted for the cost plus a percentage method provided in Article 26.2; provided, however, that if the Extra Work is performed by a Subcontractor, the Contractor shall not be entitled to receive more than an additional allowance of five (5%) percent for overhead and profit over the cost of such Subcontractor's Work as computed in accordance with Article 26.2.

## **ARTICLE 27. RESOLUTION OF DISPUTES**

27.1 All disputes between the City and the Contractor of the kind delineated in this Article 27.1 that arise under, or by virtue of, this Contract shall be finally resolved in accordance with the provisions of this Article 27 and the PPB Rules. This procedure for resolving all disputes of the kind delineated herein shall be the exclusive means of resolving any such disputes.

27.1.1 This Article 27 shall not apply to disputes concerning matters dealt with in other sections of the PPB Rules, or to disputes involving patents, copyrights, trademarks, or trade secrets (as interpreted by the courts of New York State) relating to proprietary rights in computer software.

27.1.2 This Article 27 shall apply only to disputes about the scope of Work delineated by the Contract, the interpretation of Contract documents, the amount to be paid for Extra Work or disputed work performed in connection with the Contract, the conformity of the Contractor's Work to the Contract, and the acceptability and quality of the Contractor's Work; such disputes arise when the Engineer, Resident Engineer, Engineering Audit Officer, or other designee of the Commissioner makes a determination with which the Contractor disagrees.

27.2 All determinations required by this Article 27 shall be made in writing clearly stated, with a reasoned explanation for the determination based on the information and evidence presented to the party making the determination. Failure to make such determination within the time required by this Article 27 shall be deemed a non-determination without prejudice that will allow application to the next level.

27.3 During such time as any dispute is being presented, heard, and considered pursuant to this Article 27, the Contract terms shall remain in force and the Contractor shall continue to perform Work as directed by the ACCO or the Engineer. Failure of the Contractor to continue Work as directed shall constitute a waiver by the Contractor of its claim.

27.4 Presentation of Disputes to Commissioner.

Notice of Dispute and Agency Response. The Contractor shall present its dispute in writing ("Notice of Dispute") to the Commissioner within thirty (30) Days of receiving written notice of the determination or action that is the subject of the dispute. This notice requirement shall not be read to replace any other notice requirements contained in the Contract. The Notice of Dispute shall include all the facts, evidence, documents, or other basis upon which the Contractor relies in support of its position, as well as a detailed computation demonstrating how any amount of money claimed by the Contractor in the dispute was arrived at. Within thirty (30) Days after receipt of the detailed written submission comprising the complete Notice of Dispute, the Engineer, Resident Engineer, Engineering Audit Officer, or other designee of the Commissioner shall submit to the Commissioner all materials he or she deems pertinent to the dispute. Following initial submissions to the Commissioner, either party may demand of the other the production of any document or other material the demanding party believes may be relevant to the dispute. The requested party shall produce all relevant materials that are not otherwise



protected by a legal privilege recognized by the courts of New York State. Any question of relevancy shall be determined by the **Commissioner** whose decision shall be final. Willful failure of the **Contractor** to produce any requested material whose relevancy the **Contractor** has not disputed, or whose relevancy has been affirmatively determined, shall constitute a waiver by the **Contractor** of its claim.

**27.4.1 Commissioner Inquiry.** The **Commissioner** shall examine the material and may, in his or her discretion, convene an informal conference with the **Contractor**, the **ACCO**, and the **Engineer, Resident Engineer, Engineering Audit Officer**, or other designee of the **Commissioner** to resolve the issue by mutual consent prior to reaching a determination. The **Commissioner** may seek such technical or other expertise as he or she shall deem appropriate, including the use of neutral mediators, and require any such additional material from either or both parties as he or she deems fit. The **Commissioner's** ability to render, and the effect of, a decision hereunder shall not be impaired by any negotiations in connection with the dispute presented, whether or not the **Commissioner** participated therein. The **Commissioner** may or, at the request of any party to the dispute, shall compel the participation of any **Other Contractor** with a contract related to the **Work** of this **Contract**, and that **Contractor** shall be bound by the decision of the **Commissioner**. Any **Other Contractor** thus brought into the dispute resolution proceeding shall have the same rights and obligations under this Article 27 as the **Contractor** initiating the dispute.

**27.4.2 Commissioner Determination.** Within thirty (30) **Days** after the receipt of all materials and information, or such longer time as may be agreed to by the parties, the **Commissioner** shall make his or her determination and shall deliver or send a copy of such determination to the **Contractor**, the **ACCO**, and **Engineer, Resident Engineer, Engineering Audit Officer**, or other designee of the **Commissioner**, as applicable, together with a statement concerning how the decision may be appealed.

**27.4.3 Finality of Commissioner's Decision.** The **Commissioner's** decision shall be final and binding on all parties, unless presented to the Contract Dispute Resolution Board pursuant to this Article 27. The **City** may not take a petition to the Contract Dispute Resolution Board. However, should the **Contractor** take such a petition, the **City** may seek, and the Contract Dispute Resolution Board may render, a determination less favorable to the **Contractor** and more favorable to the **City** than the decision of the **Commissioner**.

**27.5 Presentation of Dispute to the Comptroller.** Before any dispute may be brought by the **Contractor** to the Contract Dispute Resolution Board, the **Contractor** must first present its claim to the **Comptroller** for his or her review, investigation, and possible adjustment.

**27.5.1 Time, Form, and Content of Notice.** Within thirty (30) **Days** of its receipt of a decision by the **Commissioner**, the **Contractor** shall submit to the **Comptroller** and to the **Commissioner** a Notice of Claim regarding its dispute with the **Agency**. The Notice of Claim shall consist of (i) a brief written statement of the substance of the dispute, the amount of money, if any, claimed and the reason(s) the **Contractor** contends the dispute was wrongly decided by the **Commissioner**; (ii) a copy of the written decision of the **Commissioner**; and (iii) a copy of all materials submitted by the **Contractor** to the **Agency**, including the Notice of Dispute. The **Contractor** may not present to the **Comptroller** any material not presented to the **Commissioner**, except at the request of the **Comptroller**.

**27.5.2 Response.** Within thirty (30) Days of receipt of the Notice of Claim, the Agency shall make available to the Comptroller a copy of all material submitted by the Agency to the Commissioner in connection with the dispute. The Agency may not present to the Comptroller any material not presented to the Commissioner except at the request of the Comptroller.

**27.5.3 Comptroller Investigation.** The Comptroller may investigate the claim in dispute and, in the course of such investigation, may exercise all powers provided in Sections 7-201 and 7-203 of the Administrative Code. In addition, the Comptroller may demand of either party, and such party shall provide, whatever additional material the Comptroller deems pertinent to the claim, including original business records of the Contractor. Willful failure of the Contractor to produce within fifteen (15) Days any material requested by the Comptroller shall constitute a waiver by the Contractor of its claim. The Comptroller may also schedule an informal conference to be attended by the Contractor, Agency representatives, and any other personnel desired by the Comptroller.

**27.5.4 Opportunity of Comptroller to Compromise or Adjust Claim.** The Comptroller shall have forty-five (45) Days from his or her receipt of all materials referred to in Article 27.5.3 to investigate the disputed claim. The period for investigation and compromise may be further extended by agreement between the Contractor and the Comptroller, to a maximum of ninety (90) Days from the Comptroller's receipt of all materials. The Contractor may not present its petition to the Contract Dispute Resolution Board until the period for investigation and compromise delineated in this Article 27.5.4 has expired. In compromising or adjusting any claim hereunder, the Comptroller may not revise or disregard the terms of the Contract between the parties.

**27.6 Contract Dispute Resolution Board.** There shall be a Contract Dispute Resolution Board composed of:

**27.6.1** The chief administrative law judge of the Office of Administrative Trials and Hearings (OATH) or his/her designated OATH administrative law judge, who shall act as chairperson, and may adopt operational procedures and issue such orders consistent with this Article 27 as may be necessary in the execution of the Contract Dispute Resolution Board's functions, including, but not limited to, granting extensions of time to present or respond to submissions;

**27.6.2** The CCPO or his/her designee; any designee shall have the requisite background to consider and resolve the merits of the dispute and shall not have participated personally and substantially in the particular matter that is the subject of the dispute or report to anyone who so participated; and

**27.6.3** A person with appropriate expertise who is not an employee of the City. This person shall be selected by the presiding administrative law judge from a prequalified panel of individuals, established and administered by OATH with appropriate background to act as decision-makers in a dispute. Such individual may not have a contract or dispute with the City or be an officer or employee of any company or organization that does, or regularly represents persons, companies, or organizations having disputes with the City.

**27.7** Petition to the Contract Dispute Resolution Board. In the event the claim has not been settled or adjusted by the Comptroller within the period provided in this Article 27, the Contractor,

within thirty (30) Days thereafter, may petition the Contract Dispute Resolution Board to review the Commissioner's determination.

**27.7.1 Form and Content of Petition by Contractor.** The Contractor shall present its dispute to the Contract Dispute Resolution Board in the form of a petition, which shall include (i) a brief written statement of the substance of the dispute, the amount of money, if any, claimed, and the reason(s) the Contractor contends the dispute was wrongly decided by the Commissioner; (ii) a copy of the written Decision of the Commissioner, (iii) copies of all materials submitted by the Contractor to the Agency; (iv) a copy of the written decision of the Comptroller, if any, and (v) copies of all correspondence with, or written material submitted by the Contractor, to the Comptroller. The Contractor shall concurrently submit four (4) complete sets of the Petition: one set to the City Corporation Counsel (Attn: Commercial and Real Estate Litigation Division) and three (3) sets to the Contract Dispute Resolution Board at OATH's offices with proof of service on the City Corporation Counsel. In addition, the Contractor shall submit a copy of the written statement of the substance of the dispute, cited in (i) above, to both the Commissioner and the Comptroller.

**27.7.2 Agency Response.** Within thirty (30) Days of its receipt of the Petition by the City Corporation Counsel, the Agency shall respond to the brief written statement of the Contractor and make available to the Contract Dispute Resolution Board all material it submitted to the Commissioner and Comptroller. Three (3) complete copies of the Agency response shall be provided to the Contract Dispute Resolution Board and one to the Contractor. Extensions of time for submittal of the Agency response shall be given as necessary upon a showing of good cause or, upon consent of the parties, for an initial period of up to thirty (30) Days.

**27.7.3 Further Proceedings.** The Contract Dispute Resolution Board shall permit the Contractor to present its case by submission of memoranda, briefs, and oral argument. The Contract Dispute Resolution Board shall also permit the Agency to present its case in response to the Contractor by submission of memoranda, briefs, and oral argument. If requested by the City Corporation Counsel, the Comptroller shall provide reasonable assistance in the preparation of the Agency's case. Neither the Contractor nor the Agency may support its case with any documentation or other material that was not considered by the Comptroller, unless requested by the Contract Dispute Resolution Board. The Contract Dispute Resolution Board, in its discretion, may seek such technical or other expert advice as it shall deem appropriate and may seek, on its own or upon application of a party, any such additional material from any party as it deems fit. The Contract Dispute Resolution Board, in its discretion, may combine more than one dispute between the parties for concurrent resolution.

**27.7.4 Contract Dispute Resolution Board Determination.** Within forty-five (45) Days of the conclusion of all written submissions and oral arguments, the Contract Dispute Resolution Board shall render a written decision resolving the dispute. In an unusually complex case, the Contract Dispute Resolution Board may render its decision in a longer period, not to exceed ninety (90) Days, and shall so advise the parties at the commencement of this period. The Contract Dispute Resolution Board's decision must be consistent with the terms of the Contract. Decisions of the Contract Dispute Resolution Board shall only resolve matters before the Contract Dispute Resolution Board and shall not have precedential effect with respect to matters not before the Contract Dispute Resolution Board.

27.7.5 Notification of Contract Dispute Resolution Board Decision. The Contract Dispute Resolution Board shall send a copy of its decision to the Contractor, the ACCO, the Engineer, the Comptroller, the City Corporation Counsel, the CCPO, and the PPB. A decision in favor of the Contractor shall be subject to the prompt payment provisions of the PPB Rules. The Required Payment Date shall be thirty (30) Days after the date the parties are formally notified of the Contract Dispute Resolution Board's decision.

27.7.6 Finality of Contract Dispute Resolution Board Decision. The Contract Dispute Resolution Board's decision shall be final and binding on all parties. Any party may seek review of the Contract Dispute Resolution Board's decision solely in the form of a challenge, filed within four (4) months of the date of the Contract Dispute Resolution Board's decision, in a court of competent jurisdiction of the State of New York, County of New York pursuant to Article 78 of the Civil Practice Law and Rules. Such review by the court shall be limited to the question of whether or not the Contract Dispute Resolution Board's decision was made in violation of lawful procedure, was affected by an error of Law, or was arbitrary and capricious or an abuse of discretion. No evidence or information shall be introduced or relied upon in such proceeding that was not presented to the Contract Dispute Resolution Board in accordance with this Article 27.

27.8 Any termination, cancellation, or alleged breach of the Contract prior to or during the pendency of any proceedings pursuant to this Article 27 shall not affect or impair the ability of the Commissioner or Contract Dispute Resolution Board to make a binding and final decision pursuant to this Article 27.

#### **ARTICLE 28. RECORD KEEPING FOR EXTRA OR DISPUTED WORK OR WORK ON A TIME & MATERIALS BASIS**

28.1 While the Contractor or any of its Subcontractors is performing Work on a time and material basis or Extra Work on a time and material basis ordered by the Commissioner under Article 25, or where the Contractor believes that it or any of its Subcontractors is performing Extra Work but a final determination by Agency has not been made, or the Contractor or any of its Subcontractors is performing disputed Work (whether on or off the Site), or complying with a determination or order under protest in accordance with Articles 11, 27, and 30, in each such case the Contractor shall furnish the Resident Engineer daily with three (3) copies of written statements signed by the Contractor's representative at the Site showing:

28.1.1 The name, trade, and number of each worker employed on such Work or engaged in complying with such determination or order, the number of hours employed, and the character of the Work each is doing; and

28.1.2 The nature and quantity of any materials, plant and equipment furnished or used in connection with the performance of such Work or compliance with such determination or order, and from whom purchased or rented.

28.2 A copy of such statement will be countersigned by the Resident Engineer, noting thereon any items not agreed to or questioned, and will be returned to the Contractor within two (2) Days after submission.

28.3 The Contractor and its Subcontractors, when required by the Commissioner, or the Comptroller, shall also produce for inspection, at the office of the Contractor or Subcontractor, any and all of its books, bid documents, financial statements, vouchers, records, daily job diaries and reports,

and cancelled checks, and any other documents relating to showing the nature and quantity of the labor, materials, plant and equipment actually used in the performance of such Work, or in complying with such determination or order, and the amounts expended therefor, and shall permit the Commissioner and the Comptroller to make such extracts therefrom, or copies thereof, as they or either of them may desire.

28.4 In connection with the examination provided for herein, the Commissioner, upon demand therefor, will produce for inspection by the Contractor such records as the Agency may have with respect to such Extra Work or disputed Work performed under protest pursuant to order of the Commissioner, except those records and reports which may have been prepared for the purpose of determining the accuracy and validity of the Contractor's claim.

28.5 Failure to comply strictly with these requirements shall constitute a waiver of any claim for extra compensation or damages on account of the performance of such Work or compliance with such determination or order.

#### **ARTICLE 29. OMITTED WORK**

29.1 If any Contract Work in a lump sum Contract, or if any part of a lump sum item in a unit price, lump sum, or percentage-bid Contract is omitted by the Commissioner pursuant to Article 33, the Contract price, subject to audit by the EAO, shall be reduced by a pro rata portion of the lump sum bid amount based upon the percent of Work omitted subject to Article 29.4. For the purpose of determining the pro rata portion of the lump sum bid amount, the bid breakdown submitted in accordance with Article 41 shall be considered, but shall not be the determining factor.

29.2 If the whole of a lump sum item or units of any other item is so omitted by the Commissioner in a unit price, lump sum, or percentage-bid Contract, then no payment will be made therefor except as provided in Article 29.4.

29.3 For units that have been ordered but are only partially completed, the unit price shall be reduced by a pro rata portion of the unit price bid based upon the percentage of Work omitted subject to Article 29.4.

29.4 In the event the Contractor, with respect to any omitted Work, has purchased any non-cancelable material and/or equipment that is not capable of use except in the performance of this Contract and has been specifically fabricated for the sole purpose of this Contract, but not yet incorporated into the Work, the Contractor shall be paid for such material and/or equipment in accordance with Article 64.2.1(b); provided, however, such payment is contingent upon the Contractor's delivery of such material and/or equipment in acceptable condition to a location designated by the City.

29.5 The Contractor agrees to make no claim for damages or for loss of overhead and profit with regard to any omitted Work.

#### **ARTICLE 30. NOTICE AND DOCUMENTATION OF COSTS AND DAMAGES; PRODUCTION OF FINANCIAL RECORDS**

30.1 If the Contractor shall claim to be sustaining damages by reason of any act or omission of the City or its agents, it shall submit to the Commissioner within forty-five (45) Days from the time such damages are first incurred, and every thirty (30) Days thereafter to the extent additional damages are being incurred for the same condition, verified statements of the details and the amounts of such

damages, together with documentary evidence of such damages. The Contractor may submit any of the above statements within such additional time as may be granted by the Commissioner in writing upon written request therefor. Failure of the Commissioner to respond in writing to a written request for additional time within thirty (30) Days shall be deemed a denial of the request. On failure of the Contractor to strictly comply with the foregoing provisions, such claims shall be deemed waived and no right to recover on such claims shall exist. Damages that the Contractor may claim in any action or dispute resolution procedure arising under or by reason of this Contract shall not be different from or in excess of the statements and documentation made pursuant to this Article 30. This Article 30.1 does not apply to claims submitted to the Commissioner pursuant to Article 11 or to claims disputing a determination under Article 27.

30.2 In addition to the foregoing statements, the Contractor shall, upon notice from the Commissioner, produce for examination at the Contractor's office, by the Engineer, Architect or Project Manager, all of its books of account, bills, invoices, payrolls, subcontracts, time books, daily reports, bank deposit books, bank statements, check books, and cancelled checks, showing all of its acts and transactions in connection with or relating to or arising by reason of this Contract, and submit itself and persons in its employment, for examination under oath by any person designated by the Commissioner or Comptroller to investigate claims made or disputes against the City under this Contract. At such examination, a duly authorized representative of the Contractor may be present.

30.3 In addition to the statements required under Article 28 and this Article 30, the Contractor and/or its Subcontractor shall, within thirty (30) Days upon notice from the Commissioner or Comptroller, produce for examination at the Contractor's and/or Subcontractor's office, by a representative of either the Commissioner or Comptroller, all of its books of account, bid documents, financial statements, accountant workpapers, bills, invoices, payrolls, subcontracts, time books, daily reports, bank deposit books, bank statements, check books, and cancelled checks, showing all of its acts and transactions in connection with or relating to or arising by reason of this Contract. Further, the Contractor and/or its Subcontractor shall submit any person in its employment, for examination under oath by any person designated by the Commissioner or Comptroller to investigate claims made or disputes against the City under this Contract. At such examination, a duly authorized representative of the Contractor may be present.

30.4 Unless the information and examination required under Article 30.3 is provided by the Contractor and/or its Subcontractor upon thirty (30) Days' notice from the Commissioner or Comptroller, or upon the Commissioner's or Comptroller's written authorization to extend the time to comply, the City shall be released from all claims arising under, relating to or by reason of this Contract, except for sums certified by the Commissioner to be due under the provisions of this Contract. It is further stipulated and agreed that no person has the power to waive any of the foregoing provisions and that in any action or dispute resolution procedure against the City to recover any sum in excess of the sums certified by the Commissioner to be due under or by reason of this Contract, the Contractor must allege in its complaint and prove, at trial or during such dispute resolution procedure, compliance with the provisions of this Article 30.

30.5 In addition, after the commencement of any action or dispute resolution procedure by the Contractor arising under or by reason of this Contract, the City shall have the right to require the Contractor to produce for examination under oath, up until the trial of the action or hearing before the Contract Dispute Resolution Board, the books and documents described in Article 30.3 and submit itself and all persons in its employ for examination under oath. If this Article 30 is not complied with as required, then the Contractor hereby consents to the dismissal of the action or dispute resolution procedure.

**CHAPTER VII: POWERS OF THE RESIDENT ENGINEER, THE ENGINEER OR ARCHITECT AND THE COMMISSIONER**

**ARTICLE 31. THE RESIDENT ENGINEER**

31.1 The Resident Engineer shall have the power to inspect, supervise, and control the performance of the Work, subject to review by the Commissioner. The Resident Engineer shall not, however, have the power to issue an Extra Work order, except as specifically designated in writing by the Commissioner.

**ARTICLE 32. THE ENGINEER OR ARCHITECT OR PROJECT MANAGER**

32.1 The Engineer or Architect or Project Manager, in addition to those matters elsewhere herein delegated to the Engineer and expressly made subject to his/her determination, direction or approval, shall have the power, subject to review by the Commissioner:

32.1.1 To determine the amount, quality, and location of the Work to be paid for hereunder; and

32.1.2 To determine all questions in relation to the Work, to interpret the Contract Drawings, Specifications, and Addenda, and to resolve all patent inconsistencies or ambiguities therein; and

32.1.3 To determine how the Work of this Contract shall be coordinated with Work of Other Contractors engaged simultaneously on this Project, including the power to suspend any part of the Work, but not the whole thereof; and

32.1.4 To make minor changes in the Work as he/she deems necessary, provided such changes do not result in a net change in the cost to the City or to the Contractor of the Work to be done under the Contract; and

32.1.5 To amplify the Contract Drawings, add explanatory information and furnish additional Specifications and drawings, consistent with this Contract.

32.2 The foregoing enumeration shall not imply any limitation upon the power of the Engineer or Architect or Project Manager, for it is the intent of this Contract that all of the Work shall generally be subject to his/her determination, direction, and approval, except where the determination, direction or approval of someone other than the Engineer or Architect or Project Manager is expressly called for herein.

32.3 The Engineer or Architect or Project Manager shall not, however, have the power to issue an Extra Work order, except as specifically designated in writing by the Commissioner.

**ARTICLE 33. THE COMMISSIONER**

33.1 The Commissioner, in addition to those matters elsewhere herein expressly made subject to his/her determination, direction or approval, shall have the power:

33.1.1 To review and make determinations on any and all questions in relation to this Contract and its performance; and

33.1.2 To modify or change this Contract so as to require the performance of Extra Work (subject, however, to the limitations specified in Article 25) or the omission of Contract Work; and

33.1.3 To suspend the whole or any part of the Work whenever in his/her judgment such suspension is required:

33.1.3(a) In the interest of the City generally; or

33.1.3(b) To coordinate the Work of the various contractors engaged on this Project pursuant to the provisions of Article 12; or

33.1.3(c) To expedite the completion of the entire Project even though the completion of this particular Contract may thereby be delayed.

#### **ARTICLE 34. NO ESTOPPEL**

34.1 Neither the City nor any Agency, official, agent or employee thereof, shall be bound, precluded or estopped by any determination, decision, approval, order, letter, payment or certificate made or given under or in connection with this Contract by the City, the Commissioner, the Engineer, the Resident Engineer, or any other official, agent or employee of the City, either before or after the final completion and acceptance of the Work and payment therefor:

34.1.1 From showing the true and correct classification, amount, quality or character of the Work actually done; or that any such determination, decision, order, letter, payment or certificate was untrue, incorrect or improperly made in any particular, or that the Work, or any part thereof, does not in fact conform to the requirements of this Contract; and

34.1.2 From demanding and recovering from the Contractor any overpayment made to it, or such damages as the City may sustain by reason of the Contractor's failure to perform each and every part of its Contract.

### **CHAPTER VIII: LABOR PROVISIONS**

#### **ARTICLE 35. EMPLOYEES**

35.1 The Contractor and its Subcontractors shall not employ on the Work:

35.1.1 Anyone who is not competent, faithful and skilled in the Work for which he/she shall be employed; and whenever the Commissioner shall inform the Contractor, in writing, that any employee is, in his/her opinion, incompetent, unfaithful or disobedient, that employee shall be discharged from the Work forthwith, and shall not again be employed upon it; or



35.1.2 Any labor, materials or means whose employment, or utilization during the course of this Contract, may tend to or in any way cause or result in strikes, work stoppages, delays, suspension of Work or similar troubles by workers employed by the Contractor or its Subcontractors, or by any of the trades working in or about the buildings and premises where Work is being performed under this Contract, or by Other Contractors or their Subcontractors pursuant to other contracts, or on any other building or premises owned or operated by the City, its Agencies, departments, boards or authorities. Any violation by the Contractor of this requirement may, upon certification of the Commissioner, be considered as proper and sufficient cause for declaring the Contractor to be in default, and for the City to take action against it as set forth in Chapter X of this Contract, or such other article of this Contract as the Commissioner may deem proper; or

35.1.3 In accordance with Section 220.3-e of the Labor Law of the State of New York (hereinafter "Labor Law"), the Contractor and its Subcontractors shall not employ on the Work any apprentice, unless he/she is a registered individual, under a bona fide program registered with the New York State Department of Labor. The allowable ratio of apprentices to journey-level workers in any craft classification shall not be greater than the ratio permitted to the Contractor as to its work force on any job under the registered program. Any employee listed on a payroll at an apprentice wage rate, who is not registered as above, shall be paid the wage rate determined by the Comptroller of the City for the classification of Work actually performed. The Contractor or Subcontractor will be required to furnish written evidence of the registration of its program and apprentices as well as all the appropriate ratios and wage rates, for the area of the construction prior to using any apprentices on the Contract Work.

35.2 If the total cost of the Work under this Contract is at least two hundred fifty thousand (\$250,000) dollars, all laborers, workers, and mechanics employed in the performance of the Contract on the public work site, either by the Contractor, Subcontractor or other person doing or contracting to do the whole or a part of the Work contemplated by the Contract, shall be certified prior to performing any Work as having successfully completed a course in construction safety and health approved by the United States Department of Labor's Occupational Safety and Health Administration that is at least ten (10) hours in duration.

35.3 In accordance with Local Law Nos. 30-2012 and 33-2012, codified at sections 6-132 and 12-113 of the Administrative Code, respectively,

35.3.1 The Contractor shall not take an adverse personnel action with respect to an officer or employee in retaliation for such officer or employee making a report of information concerning conduct which such officer or employee knows or reasonably believes to involve corruption, criminal activity, conflict of interest, gross mismanagement or abuse of authority by any officer or employee relating to this Contract to (a) the Commissioner of the Department of Investigation, (b) a member of the New York City Council, the Public Advocate, or the Comptroller, or (c) the CCPO, ACCO, Agency head, or Commissioner.

35.3.2 If any of the Contractor's officers or employees believes that he or she has been the subject of an adverse personnel action in violation of Article 35.3.1, he or she shall be entitled to bring a cause of action against the Contractor to recover all relief necessary to make him or her whole. Such relief may include but is not limited to: (a) an injunction to restrain continued retaliation, (b) reinstatement to the position such employee would have had but for the retaliation or to an equivalent position, (c) reinstatement of full fringe benefits and seniority rights, (d) payment of two times back

pay, plus interest, and (e) compensation for any special damages sustained as a result of the retaliation, including litigation costs and reasonable attorney's fees.

35.3.3 The Contractor shall post a notice provided by the City in a prominent and accessible place on any site where work pursuant to the Contract is performed that contains information about:

35.3.3(a) how its employees can report to the New York City Department of Investigation allegations of fraud, false claims, criminality or corruption arising out of or in connection with the Contract; and

35.3.3(b) the rights and remedies afforded to its employees under Administrative Code sections 7-805 (the New York City False Claims Act) and 12-113 (the Whistleblower Protection Expansion Act) for lawful acts taken in connection with the reporting of allegations of fraud, false claims, criminality or corruption in connection with the Contract.

35.3.4 For the purposes of this Article 35.3, "adverse personnel action" includes dismissal, demotion, suspension, disciplinary action, negative performance evaluation, any action resulting in loss of staff, office space, equipment or other benefit, failure to appoint, failure to promote, or any transfer or assignment or failure to transfer or assign against the wishes of the affected officer or employee.

35.3.5 This Article 35.3 is applicable to all of the Contractor's Subcontractors having subcontracts with a value in excess of \$100,000; accordingly, the Contractor shall include this rider in all subcontracts with a value in excess of \$100,000.

35.4 Article 35.3 is not applicable to this Contract if it is valued at \$100,000 or less. Articles 35.3.1, 35.3.2, 35.3.4, and 35.3.5 are not applicable to this Contract if it was solicited pursuant to a finding of an emergency.

### 35.5 Paid Sick Leave Law.

#### 35.5.1 Introduction and General Provisions.

35.5.1(a) The Earned Sick Time Act, also known as the Paid Sick Leave Law ("PSLL"), requires covered employees who annually perform more than 80 hours of work in New York City to be provided with paid sick time.<sup>2</sup> Contractors of the City or of other governmental entities may be required to provide sick time pursuant to the PSLL.

35.5.1(b) The PSLL became effective on April 1, 2014, and is codified at Title 20, Chapter 8, of the New York City Administrative Code. It is administered by the City's Department of Consumer Affairs ("DCA"); DCA's rules promulgated under the PSLL are codified at Chapter 7 of Title 6 of the Rules of the City of New York ("Rules").

<sup>2</sup> Pursuant to the PSLL, if fewer than five employees work for the same employer, as determined pursuant to New York City Administrative Code § 20-912(g), such employer has the option of providing such employees uncompensated sick time.

35.5.1(c) The Contractor agrees to comply in all respects with the PSLL and the Rules, and as amended, if applicable, in the performance of this Contract. The Contractor further acknowledges that such compliance is a material term of this Contract and that failure to comply with the PSLL in performance of this Contract may result in its termination.

35.5.1(d) The Contractor must notify the Agency Chief Contracting Officer of the Agency with whom it is contracting in writing within ten (10) days of receipt of a complaint (whether oral or written) regarding the PSLL involving the performance of this Contract. Additionally, the Contractor must cooperate with DCA's education efforts and must comply with DCA's subpoenas and other document demands as set forth in the PSLL and Rules.

35.5.1(e) The PSLL is summarized below for the convenience of the Contractor. The Contractor is advised to review the PSLL and Rules in their entirety. On the website [www.nyc.gov/PaidSickLeave](http://www.nyc.gov/PaidSickLeave) there are links to the PSLL and the associated Rules as well as additional resources for employers, such as Frequently Asked Questions, timekeeping tools and model forms, and an event calendar of upcoming presentations and webinars at which the Contractor can get more information about how to comply with the PSLL. The Contractor acknowledges that it is responsible for compliance with the PSLL notwithstanding any inconsistent language contained herein.

#### 35.5.2 Pursuant to the PSLL and the Rules: Applicability, Accrual, and Use.

35.5.2(a) An employee who works within the City of New York for more than eighty hours in any consecutive 12-month period designated by the employer as its "calendar year" pursuant to the PSLL ("Year") must be provided sick time. Employers must provide a minimum of one hour of sick time for every 30 hours worked by an employee and compensation for such sick time must be provided at the greater of the employee's regular hourly rate or the minimum wage. Employers are not required to provide more than 40 hours of sick time to an employee in any Year.

35.5.2(b) An employee has the right to determine how much sick time he or she will use, provided that employers may set a reasonable minimum increment for the use of sick time not to exceed four hours per Day. In addition, an employee may carry over up to 40 hours of unused sick time to the following Year, provided that no employer is required to allow the use of more than forty hours of sick time in a Year or carry over unused paid sick time if the employee is paid for such unused sick time and the employer provides the employee with at least the legally required amount of paid sick time for such employee for the immediately subsequent Year on the first Day of such Year.

35.5.2(c) An employee entitled to sick time pursuant to the PSLL may use sick time for any of the following:

- i. such employee's mental illness, physical illness, injury, or health condition or the care of such illness, injury, or condition or such employee's need for medical diagnosis or preventive medical care;
- ii. such employee's care of a family member (an employee's child, spouse, domestic partner, parent, sibling, grandchild or grandparent, or the child or parent of an employee's spouse or domestic partner) who has a mental

- illness, physical illness, injury or health condition or who has a need for medical diagnosis or preventive medical care;
- iii. closure of such employee's place of business by order of a public official due to a public health emergency; or
  - iv. such employee's need to care for a child whose school or childcare provider has been closed due to a public health emergency.

35.5.2(d) An employer must not require an employee, as a condition of taking sick time, to search for a replacement. However, an employer may require an employee to provide: reasonable notice of the need to use sick time; reasonable documentation that the use of sick time was needed for a reason above if for an absence of more than three consecutive work days; and/or written confirmation that an employee used sick time pursuant to the PSSL. However, an employer may not require documentation specifying the nature of a medical condition or otherwise require disclosure of the details of a medical condition as a condition of providing sick time and health information obtained solely due to an employee's use of sick time pursuant to the PSSL must be treated by the employer as confidential.

35.5.2(e) If an employer chooses to impose any permissible discretionary requirement as a condition of using sick time, it must provide to all employees a written policy containing those requirements, using a delivery method that reasonably ensures that employees receive the policy. If such employer has not provided its written policy, it may not deny sick time to an employee because of non-compliance with such a policy.

35.5.2(f) Sick time to which an employee is entitled must be paid no later than the payday for the next regular payroll period beginning after the sick time was used.

35.5.3 Exemptions and Exceptions. Notwithstanding the above, the PSSL does not apply to any of the following:

35.5.3(a) an independent contractor who does not meet the definition of employee under section 190(2) of the New York State Labor Law;

35.5.3(b) an employee covered by a valid collective bargaining agreement in effect on April 1, 2014, until the termination of such agreement;

35.5.3(c) an employee in the construction or grocery industry covered by a valid collective bargaining agreement if the provisions of the PSSL are expressly waived in such collective bargaining agreement;

35.5.3(d) an employee covered by another valid collective bargaining agreement if such provisions are expressly waived in such agreement and such agreement provides a benefit comparable to that provided by the PSSL for such employee;

35.5.3(e) an audiologist, occupational therapist, physical therapist, or speech language pathologist who is licensed by the New York State Department of Education and who calls in for work assignments at will, determines his or her own schedule, has the ability to reject or accept any assignment referred to him or her, and is paid an average hourly wage that is at least four times the federal minimum wage;

35.5.3(f) an employee in a work study program under Section 2753 of Chapter 42 of the United States Code;

35.5.3(g) an employee whose work is compensated by a qualified scholarship program as that term is defined in the Internal Revenue Code, Section 117 of Chapter 20 of the United States Code; or

35.5.3(h) a participant in a Work Experience Program (WEP) under section 336-c of the New York State Social Services Law.

**35.5.4 Retaliation Prohibited.** An employer may not threaten or engage in retaliation against an employee for exercising or attempting in good faith to exercise any right provided by the PSL. In addition, an employer may not interfere with any investigation, proceeding, or hearing pursuant to the PSL.

**35.5.5 Notice of Rights.**

35.5.5(a) An employer must provide its employees with written notice of their rights pursuant to the PSL. Such notice must be in English and the primary language spoken by an employee, provided that DCA has made available a translation into such language. Downloadable notices are available on DCA's website at <http://www.nyc.gov/html/dca/html/law/PaidSickLeave.shtml>.

35.5.5(b) Any person or entity that willfully violates these notice requirements is subject to a civil penalty in an amount not to exceed fifty dollars for each employee who was not given appropriate notice.

**35.5.6 Records.** An employer must retain records documenting its compliance with the PSL for a period of at least three years, and must allow DCA to access such records in furtherance of an investigation related to an alleged violation of the PSL.

**35.5.7 Enforcement and Penalties.**

35.5.7(a) Upon receiving a complaint alleging a violation of the PSL, DCA has the right to investigate such complaint and attempt to resolve it through mediation. Within 30 Days of written notification of a complaint by DCA, or sooner in certain circumstances, the employer must provide DCA with a written response and such other information as DCA may request. If DCA believes that a violation of the PSL has occurred, it has the right to issue a notice of violation to the employer.

35.5.7(b) DCA has the power to grant an employee or former employee all appropriate relief as set forth in New York City Administrative Code § 20-924(d). Such relief may include, among other remedies, treble damages for the wages that should have been paid, damages for unlawful retaliation, and damages and reinstatement for unlawful discharge. In addition, DCA may impose on an employer found to have violated the PSL civil penalties not to exceed \$500 for a first violation, \$750 for a second violation within two years of the first violation, and \$1,000 for each succeeding violation within two years of the previous violation.

**35.5.8 More Generous Policies and Other Legal Requirements.** Nothing in the PSL is intended to discourage, prohibit, diminish, or impair the adoption or retention of a more generous sick time policy, or the obligation of an employer to comply with any contract,

collective bargaining agreement, employment benefit plan or other agreement providing more generous sick time. The PSLI provides minimum requirements pertaining to sick time and does not preempt, limit or otherwise affect the applicability of any other law, regulation, rule, requirement, policy or standard that provides for greater accrual or use by employees of sick leave or time, whether paid or unpaid, or that extends other protections to employees. The PSLI may not be construed as creating or imposing any requirement in conflict with any federal or state law, rule or regulation.

**35.6 HireNYC: Hiring and Reporting Requirements.** This Article 35.6 applies to construction contracts of \$1,000,000 or more. The Contractor shall comply with the requirements of Articles 35.6.1-35.6.5 for all non-trades jobs (e.g., for an administrative position arising out of Work and located in New York City). The Contractor shall reasonably cooperate with SBS and the City on specific outreach events, including "Hire-on-the-Spot" events, for the hiring of trades workers in connection with the Work. If provided elsewhere in this Contract, this Contract is subject to a project labor agreement.

**35.6.1 Enrollment.** The Contractor shall enroll with the HireNYC system, found at [www.nyc.gov/sbs](http://www.nyc.gov/sbs), within thirty (30) days after the registration of this Contract pursuant to Section 328 of the New York City Charter. The Contractor shall provide information about the business, designate a primary contact and say whether it intends to hire for any entry to mid-level job opportunities arising from this Contract and located in New York City, and, if so, the approximate start date of the first hire.

**35.6.2 Job Posting Requirements.**

**35.6.2(a)** Once enrolled in HireNYC, the Contractor agrees to update the HireNYC portal with all entry to mid-level job opportunities arising from this Contract and located in New York City, if any, which shall be defined as jobs requiring no more than an associate degree, as provided by the New York State Department of Labor (see Column F of <https://labor.ny.gov/stats/2012-2022-NYS-Employment-Prospects.xls>). The information to be updated includes the types of entry and mid-level positions made available from the work arising from the Contract and located in New York City, the number of positions, the anticipated schedule of initiating the hiring process for these positions, and the contact information for the Contractor's representative charged with overseeing hiring. The Contractor must update the HireNYC portal with any hiring needs arising from the contract and located in New York City, and the requirements of the jobs to be filled, no less than three weeks prior to the intended first day of employment for each new position, except with the permission of SBS, not to be unreasonably withheld, and must also update the HireNYC portal as set forth below.

**35.6.2(b)** After enrollment through HireNYC and submission of relevant information, SBS will work with the Contractor to develop a recruitment plan which will outline the candidate screening process, and will provide clear instructions as to when, where, and how interviews will take place. HireNYC will screen applicants based on employer requirements and refer applicants whom it believes are qualified to the Contractor for interviews. The Contractor must interview referred applicants whom it believes are qualified.

**35.6.2(c)** After completing an interview of a candidate referred by HireNYC, the Contractor must provide feedback via the portal within twenty (20) business days to indicate which candidates were interviewed and hired, if any. In addition, the Contractor shall provide the start date of new hires, and additional information

reasonably related to such hires, within twenty (20) business days after the start date. In the event the Contractor does not have any job openings covered by this Rider in any given year, the Contractor shall be required to provide an annual update to HireNYC to that effect. For this purpose, the reporting year shall run from the date of the registration of the Contract pursuant to Charter section 328 and each anniversary date.

35.6.2(d) These requirements do not limit the Contractor's ability to assess the qualifications of prospective workers, and to make final hiring and retention decisions. No provision of this Article 35.6 shall be interpreted so as to require the Contractor to employ any particular worker.

35.6.2(e) In addition, the provisions of this Article 35.6 shall not apply to positions that the Contractor intends to fill with employees employed pursuant to the job retention provision of Section 22-505 of the Administrative Code of the City of New York. The Contractor shall not be required to report such openings with HireNYC. However, the Contractor shall enroll with the HireNYC system pursuant to Article 35.6.1, above, and, if such positions subsequently become open, then the remaining provisions of this Article 35.6 will apply.

35.6.3 Breach and Liquidated Damages. If the Contractor fails to comply with the terms of the Contract and this Article 35.6 (1) by not enrolling its business with HireNYC; (2) by not informing HireNYC, as required, of open positions; or (3) by failing to interview a qualified candidate, the Agency may assess liquidated damages in the amount of two-thousand five hundred dollars (\$2,500) per breach. For all other events of noncompliance with the terms of this Article 35.6, the Agency may assess liquidated damages in the amount of five hundred dollars (\$500) per breach. Furthermore, in the event the Contractor breaches the requirements of this Article 35.6 during the term of the Contract, the City may hold the Contractor in default of this Contract.

35.6.4 Audit Compliance. In addition to the auditing requirements set forth in other parts of the Contract, the Contractor shall permit SBS and the City to inspect any and all records concerning or relating to job openings or the hiring of individuals for work arising from the Contract and located in New York City. The Contractor shall permit an inspection within seven (7) business days of the request.

35.6.5 Other Reporting Requirements. The Contractor shall report to the City, on a monthly basis, all information reasonably requested by the City that is necessary for the City to comply with any reporting requirements imposed by Law, including any requirement that the City maintain a publicly accessible database. In addition, the Contractor agrees to comply with all reporting requirements imposed by Law, or as otherwise requested by the City.

35.6.6 Federal Hiring Requirements. If this Contract is federally funded (as indicated elsewhere in this Contract), the Contractor shall comply with all federal hiring requirements as may be set forth in this Contract, including, as applicable: (a) Section 3 of the HUD Act of 1968, which requires, to the greatest extent feasible, economic opportunities for 30 percent of new hires be given to low- and very low-income persons, particularly persons who are recipients of HUD assistance for housing and Executive Order 11246, which prohibits discrimination in employment due to race, color, religion, sex or national origin, and requires the implementation of goals for minority and female participation for work involving any construction trade.

## ARTICLE 36. NO DISCRIMINATION

36.1 The Contractor specifically agrees, as required by Labor Law Section 220-e, as amended, that:

36.1.1 In the hiring of employees for the performance of Work under this Contract or any subcontract hereunder, neither the Contractor, Subcontractor, nor any person acting on behalf of such Contractor or Subcontractor, shall by reason of race, creed, color or national origin discriminate against any citizen of the State of New York who is qualified and available to perform the Work to which the employment relates;

36.1.2 Neither the Contractor, Subcontractor, nor any person on its behalf shall, in any manner, discriminate against or intimidate any employee hired for the performance of Work under this Contract on account of race, creed, color or national origin;

36.1.3 There may be deducted from the amount payable to the Contractor by the City under this Contract a penalty of fifty (\$50.00) dollars for each person for each Day during which such person was discriminated against or intimidated in violation of the provisions of this Contract; and

36.1.4 This Contract may be cancelled or terminated by the City and all moneys due or to become due hereunder may be forfeited, for a second or any subsequent violation of the terms or conditions of this Article 36.

36.1.5 This Article 36 covers all construction, alteration and repair of any public building or public work occurring in the State of New York and the manufacture, sale, and distribution of materials, equipment, and supplies to the extent that such operations are performed within the State of New York pursuant to this Contract.

36.2 The Contractor specifically agrees, as required by Section 6-108 of the Administrative Code, as amended, that:

36.2.1 It shall be unlawful for any person engaged in the construction, alteration or repair of buildings or engaged in the construction or repair of streets or highways pursuant to a Contract with the City or engaged in the manufacture, sale or distribution of materials, equipment or supplies pursuant to a Contract with the City to refuse to employ or to refuse to continue in any employment any person on account of the race, color or creed of such person.

36.2.2 It shall be unlawful for any person or any servant, agent or employee of any person, described in Article 36.1.2, to ask, indicate or transmit, orally or in writing, directly or indirectly, the race, color or creed or religious affiliation of any person employed or seeking employment from such person, firm or corporation.

36.2.3 Breach of the foregoing provisions shall be deemed a violation of a material provision of this Contract.

36.2.4 Any person, or the employee, manager or owner of or officer of such firm or corporation who shall violate any of the provisions of this Article 36.2 shall, upon



conviction thereof, be punished by a fine of not more than one hundred (\$100.00) dollars or by imprisonment for not more than thirty (30) Days, or both.

36.3 This Contract is subject to the requirements of Executive Order No. 50 (1980) ("E.O. 50"), as revised, and the rules and regulations promulgated thereunder. No contract will be awarded unless and until these requirements have been complied with in their entirety. By signing this Contract, the Contractor agrees that it:

36.3.1 Will not engage in any unlawful discrimination against any employee or applicant for employment because of race, creed, color, national origin, sex, age, disability, marital status or sexual orientation with respect to all employment decisions including, but not limited to, recruitment, hiring, upgrading, demotion, downgrading, transfer, training, rates of pay or other forms of compensation, layoff, termination, and all other terms and conditions of employment; and

36.3.2 Will not engage in any unlawful discrimination in the selection of Subcontractors on the basis of the owner's race, color, creed, national origin, sex, age, disability, marital status or sexual orientation; and

36.3.3 Will state in all solicitations or advertisements for employees placed by or on behalf of the Contractor that all qualified applicants will receive consideration for employment without unlawful discrimination based on race, creed, color, national origin, sex, age, citizens status, disability, marital status, sexual orientation, or that it is an equal employment opportunity employer; and

36.3.4 Will send to each labor organization or representative of workers with which it has a collective bargaining agreement or other contract or memorandum of understanding, written notification of its equal employment opportunity commitments under E.O. 50 and the rules and regulations promulgated thereunder; and

36.3.5 Will furnish, before the award of the Contract, all information and reports, including an employment report, that are required by E.O. 50, the rules and regulations promulgated thereunder, and orders of the City Department of Business Services, Division of Labor Services (DLS) and will permit access to its books, records, and accounts by the DLS for the purposes of investigation to ascertain compliance with such rules, regulations, and orders.

36.4 The Contractor understands that in the event of its noncompliance with the nondiscrimination clauses of this Contract or with any of such rules, regulations, or orders, such noncompliance shall constitute a material breach of this Contract and noncompliance with E.O. 50 and the rules and regulations promulgated thereunder. After a hearing held pursuant to the rules of the DLS, the Director of the DLS may direct the Commissioner to impose any or all of the following sanctions:

36.4.1 Disapproval of the Contractor; and/or

36.4.2 Suspension or termination of the Contract; and/or

36.4.3 Declaring the Contractor in default; and/or

36.4.4 In lieu of any of the foregoing sanctions, the Director of the DLS may impose an employment program.

In addition to any actions taken under this Contract, failure to comply with E.O. 50 and the rules and regulations promulgated thereunder, in one or more instances, may result in a City Agency declaring the Contractor to be non-responsible in future procurements. The Contractor further agrees that it will refrain from entering into any Contract or Contract modification subject to E.O. 50 and the rules and regulations promulgated thereunder with a Subcontractor who is not in compliance with the requirements of E.O. 50 and the rules and regulations promulgated thereunder.

36.5 The Contractor specifically agrees, as required by Section 6-123 of the Administrative Code, that:

36.5.1 The Contractor will not engage in any unlawful discriminatory practice in violation of Title 8 of the Administrative Code; and

36.5.2 Any failure to comply with this Article 36.5 may subject the Contractor to the remedies set forth in Section 6-123 of the Administrative Code, including, where appropriate, sanctions such as withholding of payment, imposition of an employment program, finding the Contractor to be in default, cancellation of the Contract, or any other sanction or remedy provided by Law or Contract.

#### **ARTICLE 37. LABOR LAW REQUIREMENTS**

37.1 The Contractor shall strictly comply with all applicable provisions of the Labor Law, as amended. Such compliance is a material term of this Contract.

37.2 The Contractor specifically agrees, as required by Labor Law Sections 220 and 220-d, as amended, that:

37.2.1 **Hours of Work:** No laborer, worker, or mechanic in the employ of the Contractor, Subcontractor or other person doing or contracting to do the whole or a part of the Work contemplated by this Contract shall be permitted or required to work more than eight (8) hours in any one (1) Day, or more than five (5) Days in any one (1) week, except as provided in the Labor Law and in cases of extraordinary emergency including fire, flood, or danger to life or property, or in the case of national emergency when so proclaimed by the President of the United States of America.

37.2.2 In situations in which there are not sufficient laborers, workers, and mechanics who may be employed to carry on expeditiously the Work contemplated by this Contract as a result of such restrictions upon the number of hours and Days of labor, and the immediate commencement or prosecution or completion without undue delay of the Work is necessary for the preservation of the Site and/or for the protection of the life and limb of the persons using the same, such laborers, workers, and mechanics shall be permitted or required to work more than eight (8) hours in any one (1) Day; or five (5) Days in any one (1) week; provided, however, that upon application of any Contractor, the Commissioner shall have first certified to the Commissioner of Labor of the State of New York (hereinafter "Commissioner of Labor") that such public Work is of an important nature and that a delay in carrying it to completion would result in serious disadvantage to the public; and provided, further, that such Commissioner of Labor shall have determined that such an emergency does in fact exist as provided in Labor Law Section 220.2.

37.2.3 Failure of the Commissioner to make such a certification to the Commissioner of Labor shall not entitle the Contractor to damages for delay or for any cause whatsoever.

37.2.4 **Prevailing Rate of Wages:** The wages to be paid for a legal day's Work to laborers, workers, or mechanics employed upon the Work contemplated by this Contract or upon any materials to be used thereon shall not be less than the "prevailing rate of wage" as defined in Labor Law Section 220, and as fixed by the Comptroller in the attached Schedule of Wage Rates and in updated schedules thereof. The prevailing wage rates and supplemental benefits to be paid are those in effect at the time the Work is being performed.

37.2.5 **Requests for interpretation or correction in the Information for Bidders** includes all requests for clarification of the classification of trades to be employed in the performance of the Work under this Contract. In the event that a trade not listed in the Contract is in fact employed during the performance of this Contract, the Contractor shall be required to obtain from the Agency the prevailing wage rates and supplementary benefits for the trades used and to complete the performance of this Contract at the price at which the Contract was awarded.

37.2.6 **Minimum Wages:** Except for employees whose wage is required to be fixed pursuant to Labor Law Section 220, all persons employed by the Contractor and any Subcontractor in the manufacture or furnishing of the supplies, materials, or equipment, or the furnishing of work, labor, or services, used in the performance of this Contract, shall be paid, without subsequent deduction or rebate unless expressly authorized by Law, not less than the sum mandated by Law.

37.3 **Working Conditions:** No part of the Work, labor or services shall be performed or rendered by the Contractor in any plants, factories, buildings or surroundings or under working conditions which are unsanitary or hazardous or dangerous to the health and safety of employees engaged in the performance of this Contract. Compliance with the safety, sanitary, and factory inspection Laws of the state in which the Work is to be performed shall be prima facie evidence of compliance with this Article 37.3.

37.4 **Prevailing Wage Enforcement:** The Contractor agrees to pay for all costs incurred by the City in enforcing prevailing wage requirements, including the cost of any investigation conducted by or on behalf of the Agency or the Comptroller, where the City discovers a failure to comply with any of the requirements of this Article 37 by the Contractor or its Subcontractor(s). The Contractor also agrees that, should it fail or refuse to pay for any such investigation, the Agency is hereby authorized to deduct from a Contractor's account an amount equal to the cost of such investigation.

37.4.1 The Labor Law Section 220 and Section 220-d, as amended, provide that this Contract shall be forfeited and no sum paid for any Work done hereunder on a second conviction for willfully paying less than:

37.4.1(a) The stipulated prevailing wage scale as provided in Labor Law section 220, as amended, or

37.4.1(b) The stipulated minimum hourly wage scale as provided in Labor Law section 220-d, as amended.

37.4.2 For any breach or violation of either working conditions (Article 37.3) or minimum wages (Article 37.2.6) provisions, the party responsible therefor shall be liable to the City for liquidated damages, which may be withheld from any amounts due on any contracts with the City of such party responsible, or may be recovered in actions brought by the City.

Corporation Counsel in the name of the City, in addition to damages for any other breach of this Contract, for a sum equal to the amount of any underpayment of wages due to any employee engaged in the performance of this Contract. In addition, the Commissioner shall have the right to cancel contracts and enter into other contracts for the completion of the original contract, with or without public letting, and the original Contractor shall be liable for any additional cost. All sums withheld or recovered as deductions, rebates, refunds, or underpayment of wages hereunder, shall be held in a special deposit account and shall be paid without interest, on order of the Comptroller, directly to the employees who have been paid less than minimum rates of pay as set forth herein and on whose account such sums were withheld or recovered, provided that no claims by employees for such payments shall be entertained unless made within two (2) years from the date of actual notice to the Contractor of the withholding or recovery of such sums by the City.

37.4.3 A determination by the Comptroller that a Contractor and/or its Subcontractor willfully violated Labor Law Section 220 will be forwarded to the City's five District Attorneys for review.

37.4.4 The Contractor's or Subcontractor's noncompliance with this Article 37.4 and Labor Law Section 220 may result in an unsatisfactory performance evaluation and the Comptroller may also find and determine that the Contractor or Subcontractor willfully violated the New York Labor Law.

37.4.4(a) An unsatisfactory performance evaluation for noncompliance with this Article 37.4 may result in a determination that the Contractor is a non-responsible bidder on subsequent procurements with the City and thus a rejection of a future award of a contract with the City, as well as any other sanctions provided for by Law.

37.4.4(b) Labor Law Section 220-b, as amended, provides that when two (2) final determinations have been rendered against a Contractor or Subcontractor within any consecutive six (6) year period determining that such Contractor or Subcontractor has willfully failed to pay the prevailing rate of wages or to provide supplements in accordance with the Labor Law and this Article 37.4, whether such failures were concurrent or consecutive and whether or not such final determinations concerning separate public works projects are rendered simultaneously, such Contractor or Subcontractor shall be ineligible to submit a bid on or be awarded any public works contract with the City for a period of five (5) years from the second final determination. If the final determination involves the falsification of payroll records or the kickback of wages or supplements, the Contractor or Subcontractor shall be ineligible to submit a bid on or be awarded any public works contract with the City for a period of five (5) years from the first final determination.

37.4.4(c) Labor Law Section 220, as amended, provides that the Contractor or Subcontractor found to have violated this Article 37.4 may be directed to make payment of wages or supplements including interest found to be due, and the Contractor or Subcontractor may be directed to make payment of a further sum as a civil penalty in an amount not exceeding twenty-five (25%) percent of the total amount found to be due.

37.5 The Contractor and its Subcontractors shall within ten (10) Days after mailing of a Notice of Award or written order, post in prominent and conspicuous places in each and every plant, factory, building, and structure where employees of the Contractor and its Subcontractors engaged in the

performance of this **Contract** are employed, notices furnished by the **City**, in relation to prevailing wages and supplements, minimum wages, and other stipulations contained in Sections 220 and 220-h of the Labor Law, and the **Contractor** and its **Subcontractors** shall continue to keep such notices posted in such prominent and conspicuous places until **Final Acceptance** of the supplies, materials, equipment, or **Work**, labor, or services required to be furnished or rendered under this **Contract**.

37.6 The **Contractor** shall strictly comply with all of the provisions of Articles 37.6.1 through 37.6.5, and provide for all workers, laborers or mechanics in its employ, the following:

37.6.1 **Notices Posted At Site:** Post, in a location designated by the **City**, schedules of prevailing wages and supplements for this **Project**, a copy of all re-determinations of such schedules for the **Project**, the **Workers' Compensation Law Section 51** notice, all other notices required by **Law** to be posted at the **Site**, the **City** notice that this **Project** is a public works project on which each worker is entitled to receive the prevailing wages and supplements for the occupation at which he or she is working, and all other notices which the **City** directs the **Contractor** to post. The **Contractor** shall provide a surface for such notices which is satisfactory to the **City**. The **Contractor** shall maintain and keep current such notices in a legible manner and shall replace any notice or schedule which is damaged, defaced, illegible or removed for any reason. The **Contractor** shall post such notices before commencing any **Work** on the **Site** and shall maintain such notices until all **Work** on the **Site** is complete; and

37.6.2 **Daily Site Sign-in Sheets:** Maintain daily **Site** sign-in sheets, and require that **Subcontractors** maintain daily **Site** sign-in sheets for its employees, which include blank spaces for an employee's name to be both printed and signed, job title, date started and Social Security number, the time the employee began work and the time the employee left work, until **Final Acceptance** of the supplies, materials, equipment, or **Work**, labor, or services to be furnished or rendered under this **Contract** unless exception is granted by the **Comptroller** upon application by the **Agency**. In the alternative, subject to the approval of the **CCPO**, the **Contractor** and **Subcontractor** may maintain an electronic or biometric sign-in system, which provides the information required by this Article 37.6.2; and

37.6.3 **Individual Employee Information Notices:** Distribute a notice to each worker, laborer or mechanic employed under this **Contract**, in a form provided by the **Agency**, that this **Project** is a public works project on which each worker, laborer or mechanic is entitled to receive the prevailing rate of wages and supplements for the occupation at which he or she is working. If the total cost of the **Work** under this **Contract** is at least two hundred fifty thousand (\$250,000) dollars, such notice shall also include a statement that each worker, laborer or mechanic must be certified prior to performing any **Work** as having successfully completed a course in construction safety and health approved by the United States Department of Labor's Occupational Safety and Health Administration that is at least ten (10) hours in duration. Such notice shall be distributed to each worker before he or she starts performing any **Work** of this **Contract** and with the first paycheck after July first of each year. "Worker, laborer or mechanic" includes employees of the **Contractor** and all **Subcontractors** and all employees of suppliers entering the **Site**. At the time of distribution, the **Contractor** shall have each worker, laborer or mechanic sign a statement, in a form provided by the **Agency**, certifying that the worker has received the notice required by this Article 37.6.3, which signed statement shall be maintained with the payroll records required by this **Contract**; and

37.6.3(a) The **Contractor** and each **Subcontractor** shall notify each worker, laborer or mechanic employed under this **Contract** in writing of the prevailing rate of

wages for their particular job classification. Such notification shall be given to every worker, laborer, and mechanic on their first pay stub and with every pay stub thereafter; and

**37.6.4 Site Laminated Identification Badges:** The Contractor shall provide laminated identification badges which include a photograph of the worker's, laborer's or mechanic's face and indicate the worker's, laborer's or mechanic's name, trade, employer's name, and employment starting date (month/day/year). Further, the Contractor shall require as a condition of employment on the Site, that each and every worker, laborer or mechanic wear the laminated identification badge at all times and that it may be seen by any representative of the City. The Commissioner may grant a written waiver from the requirement that the laminated identification badge include a photograph if the Contractor demonstrates that the identity of an individual wearing a laminated identification badge can be easily verified by another method; and

**37.6.5 Language Other Than English Used On Site:** Provide the ACCO notice when three (3) or more employees (worker and/or laborer and/or mechanic) on the Site, at any time, speak a language other than English. The ACCO will then provide the Contractor the notices described in Article 37.6.1 in that language or languages as may be required. The Contractor is responsible for all distributions under this Article 37; and

**37.6.6 Provision of Records:** The Contractor and Subcontractor(s) shall produce within five (5) Days on the Site of the Work and upon a written order of the Engineer, the Commissioner, the ACCO, the Agency EAO, or the Comptroller, such records as are required to be kept by this Article 37.6; and

**37.6.7** The Contractor and Subcontractor(s) shall pay employees by check or direct deposit. If this Contract is for an amount greater than one million (\$1,000,000) dollars, checks issued by the Contractor to covered employees shall be generated by a payroll service or automated payroll system (an in-house system may be used if approved by the Agency). For any subcontract for an amount greater than seven hundred fifty thousand (\$750,000) dollars, checks issued by a Subcontractor to covered employees shall be generated by a payroll service or automated payroll system (an in-house system may be used if approved by the Agency); and

**37.6.8** The failure of the Contractor or Subcontractor(s) to comply with the provisions of Articles 37.6.1 through 37.6.7 may result in the Commissioner declaring the Contractor in default and/or the withholding of payments otherwise due under the Contract.

**37.7** The Contractor and its Subcontractors shall keep such employment and payroll records as are required by Section 220 of the Labor Law. The failure of the Contractor or Subcontractor(s) to comply with the provisions of this Article 37.7 may result in the Commissioner declaring the Contractor in default and/or the withholding of payments otherwise due under the Contract.

**37.8** At the time the Contractor makes application for each partial payment and for final payment, the Contractor shall submit to the Commissioner a written payroll certification, in the form provided by this Contract, of compliance with the prevailing wage, minimum wage, and other provisions and stipulations required by Labor Law Section 220 and of compliance with the training requirements of Labor Law Section 220-h set forth in Article 35.2. This certification of compliance shall be a condition precedent to payment and no payment shall be made to the Contractor unless and until each such certification shall have been submitted to and received by the Commissioner.

37.9 This Contract is executed by the Contractor with the express warranty and representation that the Contractor is not disqualified under the provisions of Section 220 of the Labor Law from the award of the Contract.

37.10 Any breach or violation of any of the foregoing shall be deemed a breach or violation of a material provision of this Contract, and grounds for cancellation thereof by the City.

#### **ARTICLE 38. PAYROLL REPORTS**

38.1 The Contractor and its Subcontractor(s) shall maintain on the Site during the performance of the Work the original payrolls or transcripts thereof which the Contractor and its Subcontractor(s) are required to maintain and shall submit such original payrolls or transcripts, subscribed and affirmed by it as true, within thirty (30) Days after issuance of its first payroll, and every thirty (30) Days thereafter, pursuant to Labor Law Section 220(3-a)(a)(iii). The Contractor and Subcontractor(s) shall submit such original payrolls or transcripts along with each and every payment requisition. If payment requisitions are not submitted at least once a month, the Contractor and its Subcontractor(s) shall submit original payrolls and transcripts both along with its payment requisitions and independently of its payment requisitions.

38.2 The Contractor shall maintain payrolls or transcripts thereof for six (6) years from the date of completion of the Work on this Contract. If such payrolls and transcripts are maintained outside of New York City after the completion of the Work and their production is required pursuant to this Article 38, the Contractor shall produce such records in New York City upon request by the City.

38.3 The Contractor and Subcontractor(s) shall comply with any written order, direction, or request made by the Engineer, the Commissioner, the ACCO, the Agency EAO, the Agency Labor Law Investigator(s), or the Comptroller, to provide to the requesting party any of the following information and/or records within five (5) Days of such written order, direction, or request:

38.3.1 Such original payrolls or transcripts thereof subscribed and affirmed by it as true and the statements signed by each worker pursuant to this Chapter VIII; and/or

38.3.2 Attendance sheets for each Day on which any employee of the Contractor and/or any of the Subcontractor(s) performed Work on the Site, which attendance sheet shall be in a form acceptable to the Agency and shall provide information acceptable to the Agency to identify each such employee; and/or

38.3.3 Any other information to satisfy the Engineer, the Commissioner, the ACCO, the Agency EAO, the Agency Labor Law Investigator(s) or the Comptroller, that this Chapter VIII and the Labor Law, as to the hours of employment and prevailing rates of wages and/or supplemental benefits, are being observed.

38.4 The failure of the Contractor or Subcontractor(s) to comply with the provisions of Articles 38.1 and/or 38.2 may result in the Commissioner declaring the Contractor in default and/or the withholding of payments otherwise due under the Contract.

#### **ARTICLE 39. DUST HAZARDS**

39.1 Should a harmful dust hazard be created in performing the Work of this Contract, for the elimination of which appliances or methods have been approved by the Board of Standards and Appeals

of the City of New York, such appliances and methods shall be installed, maintained, and effectively operated during the continuance of such harmful dust hazard. Failure to comply with this provision after notice shall make this Contract voidable at the sole discretion of the City.

## **CHAPTER IX: PARTIAL AND FINAL PAYMENTS**

### **ARTICLE 40. CONTRACT PRICE**

40.1 The City shall pay, and the Contractor agrees to accept, in full consideration for the Contractor's performance of the Work subject to the terms and conditions hereof, the lump sum price or unit prices for which this Contract was awarded, plus the amount required to be paid for any Extra Work ordered by the Commissioner under Article 25, less credit for any Work omitted pursuant to Article 29.

### **ARTICLE 41. BID BREAKDOWN ON LUMP SUM**

41.1 Within fifteen (15) Days after the commencement date specified in the Notice to Proceed or Order to Work, unless otherwise directed by the Resident Engineer, the Contractor shall submit to the Resident Engineer a breakdown of its bid price, or of lump sums bid for items of the Contract, showing the various operations to be performed under the Contract, as directed in the progress schedule required under Article 9, and the value of each of such operations, the total of such items to equal the lump sum price bid. Said breakdown must be approved in writing by the Resident Engineer.

41.2 No partial payment will be approved until the Contractor submits a bid breakdown that is acceptable to the Resident Engineer.

41.3 The Contractor shall also submit such other information relating to the bid breakdown as directed by the Resident Engineer. Thereafter, the breakdown may be used only for checking the Contractor's applications for partial payments hereunder, but shall not be binding upon the City, the Commissioner, or the Engineer for any purpose whatsoever.

### **ARTICLE 42. PARTIAL PAYMENTS**

42.1 From time to time as the Work progresses satisfactorily, but not more often than once each calendar month (except where the Commissioner approves in writing the submission of invoices on a more frequent basis and for invoices relating to Work performed pursuant to a change order), the Contractor may submit to the Engineer a requisition for a partial payment in the prescribed form, which shall contain an estimate of the quantity and the fair value of the Work done during the payment period.

42.2 Partial payments may be made for materials, fixtures, and equipment in advance of their actual incorporation in the Work, as the Commissioner may approve, and upon the terms and conditions set forth in the General Conditions.

42.3 The Contractor shall also submit to the Commissioner in connection with every application for partial payment a verified statement in the form prescribed by the Comptroller setting forth the information required under Labor Law Section 220-a.



42.4 Within thirty (30) Days after receipt of a satisfactory payment application, and within sixty (60) Days after receipt of a satisfactory payment application in relation to Work performed pursuant to a change order, the Engineer will prepare and certify, and the Commissioner will approve, a voucher for a partial payment in the amount of such approved estimate, less any and all deductions authorized to be made by the Commissioner under the terms of this Contract or by Law.

#### **ARTICLE 43. PROMPT PAYMENT**

43.1 The Prompt Payment provisions of the PPB Rules in effect at the time of the bid will be applicable to payments made under this Contract. The provisions require the payment to the Contractor of interest on payments made after the required payment date, except as set forth in the PPB Rules.

43.2 The Contractor shall submit a proper invoice to receive payment, except where the Contract provides that the Contractor will be paid at predetermined intervals without having to submit an invoice for each scheduled payment.

43.3 Determination of interest due will be made in accordance with the PPB Rules.

43.4 If the Contractor is paid interest, the proportionate share(s) of that interest shall be forwarded by the Contractor to its Subcontractor(s).

43.5 The Contractor shall pay each Subcontractor or Materialman not later than seven (7) Days after receipt of payment out of amounts paid to the Contractor by the City for Work performed by the Subcontractor or Materialman under this Contract.

43.5.1 If Contractor fails to make any payment to any Subcontractor or Materialman within seven (7) Days after receipt of payment by the City pursuant to this Article 43.5, then the Contractor shall pay interest on amounts due to such Subcontractor or Materialman at the rate of interest in effect on the date such payment is made by the Contractor computed in accordance with Section 756-b (1)(b) of the New York General Business Law. Accrual of interest shall commence on the Day immediately following the expiration of the seventh Day following receipt of payment by the Contractor from the City and shall end on the date on which payment is made.

43.6 The Contractor shall include in each of its subcontracts a provision requiring each Subcontractor to make payment to each of its Subcontractors or Materialmen for Work performed under this Contract in the same manner and within the same time period set forth above.

#### **ARTICLE 44. SUBSTANTIAL COMPLETION PAYMENT**

44.1 The Contractor shall submit with the Substantial Completion requisition:

44.1.1 A final verified statement of any pending Article 27 disputes in accordance with the PPB Rules and this Contract and any and all alleged claims against the City, in any way connected with or arising out of this Contract (including those as to which details may have been furnished pursuant to Articles 11, 27, 28, and 30) setting forth with respect to each such claim the total amount thereof, the various items of labor and materials included therein, and the alleged value of each item; and if the alleged claim be one for delay, the alleged cause of each such delay, the period or periods of time, giving the dates when the

Contractor claims the performance of the Work or a particular part thereof was delayed, and an itemized statement and breakdown of the amount claimed for each such delay.

44.1.1(a) With respect to each such claim, the Commissioner, the Comptroller and, in the event of litigation, the City Corporation Counsel shall have the same right to inspect, and to make extracts or copies of, the Contractor's books, vouchers, records, etc., as is referred to in Articles 11, 27, 28, and 30. Nothing contained in this Article 44.1.1(a) is intended to or shall relieve the Contractor from the obligation of complying strictly with Articles 11, 27, 28, and 30. The Contractor is warned that unless such claims are completely set forth as herein required, the Contractor upon acceptance of the Substantial Completion payment pursuant to this Article 44, will have waived any such claims.

44.1.2 A Final Approved Punch List.

44.1.3 Where required, a request for an extension of time to achieve Substantial Completion or final extension of time.

44.2 The Commissioner shall issue a voucher calling for payment of any part or all of the balance due for Work performed under the Contract, including monies retained under Article 21, less any and all deductions authorized to be made by the Commissioner, under this Contract or by Law, and less twice the amount the Commissioner considers necessary to ensure the completion of the balance of the Work by the Contractor. Such a payment shall be considered a partial and not a final payment. No Substantial Completion payment shall be made under this Article 44 where the Contractor failed to complete the Work within the time fixed for such completion in the Schedule A of the General Conditions, or within the time to which completion may have been extended, until an extension or extensions of time for the completion of Work have been acted upon pursuant to Article 13.

44.3 No further partial payments shall be made to the Contractor after Substantial Completion, except the Substantial Completion payment and payment pursuant to any Contractor's requisition that were properly filed with the Commissioner prior to the date of Substantial Completion; however, the Commissioner may grant a waiver for further partial payments after the date of Substantial Completion to permit payments for change order Work and/or release of retainage and deposits pursuant to Articles 21 and 24. Such waiver shall be in writing.

44.4 The Contractor acknowledges that nothing contained in this Article 44 is intended to or shall in any way diminish the force and effect of Article 13.

#### **ARTICLE 45. FINAL PAYMENT**

45.1 After completion and Final Acceptance of the Work, the Contractor shall submit all required certificates and documents, together with a requisition for the balance claimed to be due under the Contract, less the amount authorized to be retained for maintenance under Article 24. Such submission shall be within 90 days of the date of the Commissioner's written determination of Final Acceptance, or within such additional time as may be granted by the Commissioner in writing. If the Contractor fails to submit all required certificates and documents within the time allowed, no payment of the balance claimed shall be made to the Contractor and the Contractor shall be deemed to have forfeited its right to payment of any balance claimed. A verified statement similar to that required in connection with applications for partial payments shall also be submitted to the Commissioner.

45.2 Amended Verified Statement of Claims: The Contractor shall also submit with the final requisition any amendments to the final verified statement of any pending dispute resolution procedures in accordance with the PPB Rules and this Contract and any and all alleged claims against the City, in any way connected with or arising out of this Contract (including those as to which details may have been furnished pursuant to Articles 11, 27, 28, and 30) that have occurred subsequent to **Substantial Completion**, setting forth with respect to each such claim the total amount thereof, the various items of labor and materials included therein, and the alleged value of each such item; and if the alleged claim be one for delay, the alleged cause of each such delay, the period or periods of time, giving the dates when the Contractor claims the performance of the Work or a particular part thereof was delayed, and an itemized statement and breakdown of the amount claimed for each such delay. With reference to each such claim, the Commissioner, the Comptroller and, in the event of litigation, the City Corporation Counsel shall have the same right to inspect, and to make extracts or copies of, the Contractor's books, vouchers, records, etc., as is referred to in Articles 11, 27, 28, and 30. Nothing contained in this Article 45.2, is intended to or shall relieve the Contractor from the obligation of complying strictly with Articles 11, 27, 28, and 30. The Contractor is warned that unless such claims are completely set forth as herein required, the Contractor, upon acceptance of the Final Payment pursuant to Article 46, will have waived any such claims.

45.3 Preparation of Final Voucher: Upon determining the balance due hereunder other than on account of claims, the Engineer will prepare and certify, for the Commissioner's approval, a voucher for final payment in that amount less any and all deductions authorized to be made by the Commissioner under this Contract or by Law. In the case of a lump sum Contract, the Commissioner shall certify the voucher for final payment within thirty (30) Days from the date of completion and acceptance of the Work, provided all requests for extensions of time have been acted upon.

45.3.1 All prior certificates and vouchers upon which partial payments were made, being merely estimates made to enable the Contractor to prosecute the Work more advantageously, shall be subject to correction in the final voucher, and the certification of the Engineer thereon and the approval of the Commissioner thereof, shall be conditions precedent to the right of the Contractor to receive any money hereunder. Such final voucher shall be binding and conclusive upon the Contractor.

45.3.2 Payment pursuant to such final voucher, less any deductions authorized to be made by the Commissioner under this Contract or by Law, shall constitute the final payment, and shall be made by the Comptroller within thirty (30) Days after the filing of such voucher in his/her office.

45.4 The Contractor acknowledges that nothing contained in this Article 45 is intended to or shall in any way diminish the force and effect of Article 13.

#### **ARTICLE 46. ACCEPTANCE OF FINAL PAYMENT**

46.1 The acceptance by the Contractor, or by anyone claiming by or through it, of the final payment, whether such payment be made pursuant to any judgment of any court, or otherwise, shall constitute and operate as a release of the City from any and all claims of and liability to the Contractor for anything heretofore done or furnished for the Contractor relating to or arising out of this Contract and the Work done hereunder, and for any prior act, neglect or default on the part of the City or any of its officials, agents or employees, excepting only a claim against the City for the amounts deducted or retained in accordance with the terms and provisions of this Contract or by Law, and excepting any claims, not otherwise waived, or any pending dispute resolution procedures which are contained in the

verified statement filed with the Contractor's substantial and final requisitions pursuant to Articles 44 and 45.

46.2 The Contractor is warned that the execution by it of a release, in connection with the acceptance of the final payment, containing language purporting to reserve claims other than those herein specifically excepted from the operation of this Article 46, or those for amounts deducted by the Commissioner from the final requisition or from the final payment as certified by the Engineer and approved by the Commissioner, shall not be effective to reserve such claims, anything stated to the Contractor orally or in writing by any official, agent or employee of the City to the contrary notwithstanding.

46.3 Should the Contractor refuse to accept the final payment as tendered by the Comptroller, it shall constitute a waiver of any right to interest thereon.

46.4 The Contractor, however, shall not be barred by this Article 46 from commencing an action for breach of Contract to the extent permitted by Law and by the terms of the Contract for any claims that are contained in the verified statement filed with the Contractor's substantial and final requisitions pursuant to Articles 44 and 45 or that arose after submission of the final payment requisition, provided that a detailed and verified statement of claim is served upon the contracting Agency and Comptroller not later than forty (40) Days after the making of such final payment by electronic funds transfer (EFT) or the mailing of such final payment. The statement shall specify the items upon which the claim will be based and any such claim shall be limited to such items.

#### **ARTICLE 47. APPROVAL BY PUBLIC DESIGN COMMISSION**

47.1 All works of art, including paintings, mural decorations, stained glass, statues, bas-reliefs, and other sculptures, monuments, fountains, arches, and other structures of a permanent character intended for ornament or commemoration, and every design of the same to be used in the performance of this Contract, and the design of all bridges, approaches, buildings, gates, fences, lamps, or structures to be erected, pursuant to the terms of this Contract, shall be submitted to the Art Commission, d/b/a the Public Design Commission of the City of New York, and shall be approved by the Public Design Commission prior to the erection or placing in position of the same. The final payment shall not become due or payable under this Contract unless and until the Public Design Commission shall certify that the design for the Work herein contracted for has been approved by the said Public Design Commission, and that the same has been executed in substantial accordance with the design so approved, pursuant to the provisions of Chapter 37, Section 854 of the City Charter, as amended.

### **CHAPTER X: CONTRACTOR'S DEFAULT**

#### **ARTICLE 48. COMMISSIONER'S RIGHT TO DECLARE CONTRACTOR IN DEFAULT**

48.1 In addition to those instances specifically referred to in other Articles herein, the Commissioner shall have the right to declare the Contractor in default of this Contract if:

48.1.1 The Contractor fails to commence Work when notified to do so by the Commissioner; or if

48.1.2 The Contractor shall abandon the Work; or if

48.1.3 The Contractor shall refuse to proceed with the Work when and as directed by the Commissioner; or if

48.1.4 The Contractor shall, without just cause, reduce its working force to a number which, if maintained, would be insufficient, in the opinion of the Commissioner, to complete the Work in accordance with the progress schedule; or if

48.1.5 The Contractor shall fail or refuse to increase sufficiently such working force when ordered to do so by the Commissioner; or if

48.1.6 The Contractor shall sublet, assign, transfer, convert or otherwise dispose of this Contract other than as herein specified; or sell or assign a majority interest in the Contractor; or if

48.1.7 The Contractor fails to secure and maintain all required insurance; or if

48.1.8 A receiver or receivers are appointed to take charge of the Contractor's property or affairs; or if

48.1.9 The Commissioner shall be of the opinion that the Contractor is or has been unnecessarily or unreasonably or willfully delaying the performance and completion of the Work, or the award of necessary subcontracts, or the placing of necessary material and equipment orders; or if

48.1.10 The Commissioner shall be of the opinion that the Contractor is or has been willfully or in bad faith violating any of the provisions of this Contract; or if

48.1.11 The Commissioner shall be of the opinion that the Work cannot be completed within the time herein provided therefor or within the time to which such completion may have been extended; provided, however, that the impossibility of timely completion is, in the Commissioner's opinion, attributable to conditions within the Contractor's control; or if

48.1.12 The Work is not completed within the time herein provided therefor or within the time to which the Contractor may be entitled to have such completion extended; or if

48.1.13 Any statement or representation of the Contractor in the Contract or in any document submitted by the Contractor with respect to the Work, the Project, or the Contract (or for purposes of securing the Contract) was untrue or incorrect when made; or if

48.1.14 The Contractor or any of its officers, directors, partners, five (5%) percent shareholders, principals, or other persons substantially involved in its activities, commits any of the acts or omissions specified as the grounds for debarment in the PPB Rules.

48.2 Before the Commissioner shall exercise his/her right to declare the Contractor in default, the Commissioner shall give the Contractor an opportunity to be heard, upon not less than two (2) Days' notice.

#### **ARTICLE 49. EXERCISE OF THE RIGHT TO DECLARE DEFAULT**

49.1 The right to declare the Contractor in default for any of the grounds specified or referred to in Article 48 shall be exercised by sending the Contractor a notice, signed by the Commissioner, setting forth the ground or grounds upon which such default is declared (hereinafter referred to as a "Notice of Default").

49.2 The Commissioner's determination that the Contractor is in default shall be conclusive, final, and binding on the parties and such a finding shall preclude the Contractor from commencing a plenary action for any damages relating to the Contract. If the Contractor protests the determination of the Commissioner, the Contractor may commence an action in a court of competent jurisdiction of the State of New York under Article 78 of the New York Civil Practice Law and Rules.

#### **ARTICLE 50. QUITTING THE SITE**

50.1 Upon receipt of such notice the Contractor shall immediately discontinue all further operations under this Contract and shall immediately quit the Site, leaving untouched all plant, materials, equipment, tools, and supplies then on the Site.

#### **ARTICLE 51. COMPLETION OF THE WORK**

51.1 The Commissioner, after declaring the Contractor in default, may then have the Work completed by such means and in such manner, by contract with or without public letting, or otherwise, as he/she may deem advisable, utilizing for such purpose such of the Contractor's plant, materials, equipment, tools, and supplies remaining on the Site, and also such Subcontractors, as he/she may deem advisable.

51.2 After such completion, the Commissioner shall make a certificate stating the expense incurred in such completion, which shall include the cost of re-letting and also the total amount of liquidated damages (at the rate provided for in the Contract) from the date when the Work should have been completed by the Contractor in accordance with the terms hereof to the date of actual completion of the Work. Such certificate shall be binding and conclusive upon the Contractor, its sureties, and any person claiming under the Contractor, as to the amount thereof.

51.3 The expense of such completion, including any and all related and incidental costs, as so certified by the Commissioner, and any liquidated damages assessed against the Contractor, shall be charged against and deducted out of monies which are earned by the Contractor prior to the date of default. Should the expense of such completion, as certified by the Commissioner, exceed the total sum which would have been payable under the Contract if it had been completed by the Contractor, any excess shall be paid by the Contractor.

#### **ARTICLE 52. PARTIAL DEFAULT**

52.1 In case the Commissioner shall declare the Contractor in default as to a part of the Work only, the Contractor shall discontinue such part, shall continue performing the remainder of the Work in strict conformity with the terms of this Contract, and shall in no way hinder or interfere with any Other Contractor(s) or persons whom the Commissioner may engage to complete the Work as to which the Contractor was declared in default.

52.2 The provisions of this Chapter relating to declaring the Contractor in default as to the entire Work shall be equally applicable to a declaration of partial default, except that the Commissioner shall be entitled to utilize for completion of the part of the Work as to which the Contractor was declared in default only such plant, materials, equipment, tools, and supplies as had been previously used by the Contractor on such part.

#### **ARTICLE 53. PERFORMANCE OF UNCOMPLETED WORK**

53.1 In completing the whole or any part of the Work under the provisions of this Chapter X, the Commissioner shall have the power to depart from or change or vary the terms and provisions of this Contract, provided, however, that such departure, change or variation is made for the purpose of reducing the time or expense of such completion. Such departure, change or variation, even to the extent of accepting a lesser or different performance, shall not affect the conclusiveness of the Commissioner's certificate of the cost of completion referred to in Article 51, nor shall it constitute a defense to an action to recover the amount by which such certificate exceeds the amount which would have been payable to the Contractor hereunder but for its default.

#### **ARTICLE 54. OTHER REMEDIES**

54.1 In addition to the right to declare the Contractor in default pursuant to this Chapter X, the Commissioner shall have the absolute right, in his/her sole discretion and without a hearing, to complete or cause to be completed in the same manner as described in Articles 51 and 53, any or all unsatisfactory or uncompleted punch list Work that remains after the completion date specified in the Final Approved Punch List. A written notice of the exercise of this right shall be sent to the Contractor who shall immediately quit the Site in accordance with the provisions of Article 50.

54.2 The expense of completion permitted under Article 54.1, including any and all related and incidental costs, as so certified by the Commissioner, shall be charged against and deducted out of monies which have been earned by the Contractor prior to the date of the exercise of the right set forth in Article 54.1; the balance of such monies, if any, subject to the other provisions of this Contract, to be paid to the Contractor without interest after such completion. Should the expense of such completion, as certified by the Commissioner, exceed the total sum which would have been payable under the Contract if it had been completed by the Contractor, any excess shall be paid by the Contractor.

54.3 The previous provisions of this Chapter X shall be in addition to any and all other remedies available under Law or in equity.

54.4 The exercise by the City of any remedy set forth herein shall not be deemed a waiver by the City of any other legal or equitable remedy contained in this Contract or provided under Law.

### **CHAPTER XI: MISCELLANEOUS PROVISIONS**

#### **ARTICLE 55. CONTRACTOR'S WARRANTIES**

55.1 In consideration of, and to induce, the award of this Contract to the Contractor, the Contractor represents and warrants:

55.1.1 That it is financially solvent, sufficiently experienced and competent to perform the Work; and

55.1.2 That the facts stated in its bid and the information given by it pursuant to the Information for Bidders is true and correct in all respects; and

55.1.3 That it has read and complied with all requirements set forth in the Contract.

#### **ARTICLE 56. CLAIMS AND ACTIONS THEREON**

56.1 Any claim, that is not subject to dispute resolution under the PPB Rules or this Contract, against the City for damages for breach of Contract shall not be made or asserted in any action, unless the Contractor shall have strictly complied with all requirements relating to the giving of notice and of information with respect to such claims, as herein before provided.

56.2 Nor shall any action be instituted or maintained on any such claims unless such action is commenced within six (6) months after Substantial Completion; except that:

56.2.1 Any claims arising out of events occurring after Substantial Completion and before Final Acceptance of the Work shall be asserted within six (6) months of Final Acceptance of the Work;

56.2.2 If the Commissioner exercises his/her right to complete or cause to complete any or all unsatisfactory or uncompleted punch list Work that remains after the completion date specified in the Final Approved Punch List pursuant to Article 54, any such action shall be commenced within six (6) months from the date the Commissioner notifies the Contractor in writing that he/she has exercised such right. Any claims for monies deducted, retained or withheld under the provisions of this Contract shall be asserted within six (6) months after the date when such monies otherwise become due and payable hereunder; and

56.2.3 If the Commissioner exercises his/her right to terminate the Contract pursuant to Article 64, any such action shall be commenced within six (6) months of the date the Commissioner exercises said right.

#### **ARTICLE 57. INFRINGEMENT**

57.1 The Contractor shall be solely responsible for and shall defend, indemnify, and hold the City harmless from any and all claims (even if the allegations of the lawsuit are without merit) and judgments for damages and from costs and expenses to which the City may be subject to or which it may suffer or incur allegedly arising out of or in connection with any infringement by the Contractor of any copyright, trade secrets, trademark or patent rights or any other property or personal right of any third party by the Contractor and/or its Subcontractors in the performance or completion of the Work. Insofar as the facts or Law relating to any claim would preclude the City from being completely indemnified by the Contractor, the City shall be partially indemnified by the Contractor to the fullest extent permitted by Law.



**ARTICLE 58. NO CLAIM AGAINST OFFICIALS, AGENTS OR EMPLOYEES**

58.1 No claim whatsoever shall be made by the Contractor against any official, agent or employee of the City for, or on account of, anything done or omitted to be done in connection with this Contract.

**ARTICLE 59. SERVICE OF NOTICES**

59.1 The Contractor hereby designates the business address, fax number, and email address specified in its bid, as the place where all notices, directions or other communications to the Contractor may be delivered, or to which they may be mailed. Any notice, direction, or communication from either party to the other shall be in writing and shall be deemed to have been given when (i) delivered personally; (ii) sent by certified mail, return receipt requested; (iii) delivered by overnight or same day courier service in a properly addressed envelope with confirmation; or (iv) sent by fax or email and, unless receipt of the fax or e-mail is acknowledged by the recipient by fax or e-mail, deposited in a post office box regularly maintained by the United States Postal Service in a properly addressed, postage pre-paid envelope.

59.2 Contractor's notice address, email address, or fax number may be changed at any time by an instrument in writing, executed and acknowledged by the Contractor, and delivered to the Commissioner.

59.3 Nothing herein contained shall, however, be deemed to preclude or render inoperative the service of any notice, direction or other communication upon the Contractor personally, or, if the Contractor is a corporation, upon any officer thereof.

**ARTICLE 60. UNLAWFUL PROVISIONS DEEMED STRICKEN FROM CONTRACT**

60.1 If this Contract contains any unlawful provision not an essential part of the Contract and which shall not appear to have been a controlling or material inducement to the making thereof, the same shall be deemed of no effect and shall, upon notice by either party, be deemed stricken from the Contract without affecting the binding force of the remainder.

**ARTICLE 61. ALL LEGAL PROVISIONS DEEMED INCLUDED**

61.1 It is the intent and understanding of the parties to this Contract that each and every provision of Law required to be inserted in this Contract shall be and is inserted herein. Furthermore, it is hereby stipulated that every such provision is to be deemed to be inserted herein, and if, through mistake or otherwise, any such provision is not inserted, or is not inserted in correct form, then this Contract shall forthwith upon the application of either party be amended by such insertion so as to comply strictly with the Law and without prejudice to the rights of either party hereunder.

**ARTICLE 62. TAX EXEMPTION**

62.1 The City is exempt from payment of Federal, State, and local taxes, including sales and compensating use taxes of the State of New York and its cities and counties on all tangible personal property sold to the City pursuant to the provisions of this Contract. These taxes are not to be included in bids. However, this exemption does not apply to tools, machinery, equipment or other property leased by or to the Contractor, Subcontractor or Materialman or to tangible personal property which, even

though it is consumed, is not incorporated into the completed Work (consumable supplies) and tangible personal property that the Contractor is required to remove from the Site during or upon completion of the Work. The Contractor and its Subcontractors and Materialmen shall be responsible for and pay any and all applicable taxes, including sales and compensating use taxes, on such leased tools, machinery, equipment or other property and upon all such consumable supplies and tangible personal property that the Contractor is required to remove from the Site during or upon completion of the Work.

62.2 The Contractor agrees to sell and the City agrees to purchase all tangible personal property, other than consumable supplies and other tangible personal property that the Contractor is required to remove from the Site during or upon completion of the Work, that is required, necessary or proper for or incidental to the construction of the Project covered by this Contract. The sum paid under this Contract for such tangible personal property shall be in full payment and consideration for the sale of such tangible personal property.

62.2.1 The Contractor agrees to construct the Project and to perform all Work, labor and services rendered, necessary, proper or incidental thereto for the sum shown in the bid for the performance of such Work, labor, and services, and the sum so paid pursuant to this Contract for such Work, labor, and services, shall be in full consideration for the performance by the Contractor of all its duties and obligations under this Contract in connection with said Work, labor, and services.

62.3 20 NYCRR Section 541.3(d) provides that a Contractor's purchases of tangible personal property that is either incorporated into real property owned by a governmental entity or purchased for and sold to a governmental entity are exempt from sales and use tax. The City shall not pay sales tax for any such tangible personal property that it purchases from the Contractor pursuant to the Contract. With respect to such tangible personal property, the Contractor, at the request of the City, shall furnish to the City such bills of sale and other instruments as may be required by the City, properly executed, acknowledged and delivered assuring to the City title to such tangible personal property, free of liens and/or encumbrances, and the Contractor shall mark or otherwise identify all such tangible personal property as the property of the City.

62.4 Title to all tangible personal property to be sold by the Contractor to the City pursuant to the provisions of the Contract shall immediately vest in and become the sole property of the City upon delivery of such tangible personal property to the Site. Notwithstanding such transfer of title, the Contractor shall have the full and continuing responsibility to install such tangible personal property in accordance with the provisions of this Contract, protect it, maintain it in a proper condition and forthwith repair, replace and make good any damage thereto, theft or disappearance thereof, and furnish additional tangible personal property in place of any that may be lost, stolen or rendered unusable, without cost to the City, until such time as the Work covered by the Contract is fully accepted by the City. Such transfer of title shall in no way affect any of the Contractor's obligations hereunder. In the event that, after title has passed to the City, any of the tangible personal property is rejected as being defective or otherwise unsatisfactory, title to all such tangible personal property shall be deemed to have been transferred back to the Contractor.

62.5 The purchase by Subcontractors or Materialmen of tangible personal property to be sold hereunder shall be a purchase or procurement for resale to the Contractor (either directly or through other Subcontractors) and therefore not subject to the aforesaid sales and compensating use taxes, provided that the subcontracts and purchase agreements provide for the resale of such tangible personal property and that such subcontracts and purchase agreements are in a form similar to this Contract with respect to the separation of the sale of consumable supplies and tangible personal property that the

Contractor is required to remove from the Site during or upon completion of the Work from the Work and labor, services, and any other matters to be provided, and provided further that the subcontracts and purchase agreements provide separate prices for tangible personal property and all other services and matters. Such separation shall actually be followed in practice, including the separation of payments for tangible personal property from the payments for other Work and labor and other things to be provided.

62.6 The Contractor and its Subcontractors and Materialmen shall furnish a Contractor Exempt Purchase Certificate to all persons, firms or corporations from which they purchase tangible personal property for the performance of the Work covered by this Contract.

62.7 In the event any of the provisions of this Article 62 shall be deemed to be in conflict with any other provisions of this Contract or create any ambiguity, then the provisions of this Article 62 shall control.

### ARTICLE 63. INVESTIGATION(S) CLAUSE

63.1 The parties to this Contract agree to cooperate fully and faithfully with any investigation, audit or inquiry conducted by a United States, a State of New York (State) or a City governmental agency or authority that is empowered directly or by designation to compel the attendance of witnesses and to examine witnesses under oath, or conducted by the Inspector General of a governmental agency that is a party in interest to the transaction, submitted bid, submitted proposal, contract, lease, permit or license that is the subject of the investigation, audit or inquiry.

63.2 If any person who has been advised that his/her statement, and any information from such statement, will not be used against him/her in any subsequent criminal proceeding refuses to testify before a grand jury or other governmental agency or authority empowered directly or by designation to compel the attendance of witnesses and to examine witnesses under oath concerning the award of or performance under any transaction, agreement, lease, permit, contract, or license entered into with the City, the State, or any political subdivision or public authority thereof, or the Port Authority of New York and New Jersey, or any local development corporation within the City, or any public benefit corporation organized under the Laws of the State of New York, or;

63.3 If any person refuses to testify for a reason other than the assertion of his/her privilege against self incrimination in an investigation, audit or inquiry conducted by a City or State governmental agency or authority empowered directly or by designation to compel the attendance of witnesses and to take testimony under oath, or by the Inspector General of the governmental agency that is a party in interest in, and is seeking testimony concerning the award of, or performance under any transaction, agreement, lease, permit, contract, or license entered into with the City, the State, or any political subdivision thereof or any local development corporation within the City, then;

63.4 The Commissioner whose Agency is a party in interest to the transaction, submitted bid, submitted proposal, contract, lease, permit, or license shall convene a hearing, upon not less than five (5) Days' written notice to the parties involved to determine if any penalties should attach for the failure of a person to testify.

63.5 If any non-governmental party to the hearing requests an adjournment, the Commissioner who convened the hearing may, upon granting the adjournment, suspend any contract, lease, permit, or license, pending the final determination pursuant to Article 63.7 without the City incurring any penalty or damages for delay or otherwise.

63.6 The penalties which may attach after a final determination by the Commissioner may include but shall not exceed:

63.6.1 The disqualification for a period not to exceed five (5) years from the date of an adverse determination for any person, or any entity of which such person was a member at the time the testimony was sought, from submitting bids for, or transacting business with, or entering into or obtaining any contract, lease, permit or license with or from the City; and/or

63.6.2 The cancellation or termination of any and all such existing City contracts, leases, permits or licenses that the refusal to testify concerns and that have not been assigned as permitted under this Contract, nor the proceeds of which pledged, to an unaffiliated and unrelated institutional lender for fair value prior to the issuance of the notice scheduling the hearing, without the City incurring any penalty or damages on account of such cancellation or termination; monies lawfully due for goods delivered; work done, rentals, or fees accrued prior to the cancellation or termination shall be paid by the City.

63.7 The Commissioner shall consider and address in reaching his/her determination and in assessing an appropriate penalty the factors in Articles 63.7.1 and 63.7.2. The Commissioner may also consider, if relevant and appropriate, the criteria established in Articles 63.7.3 and 63.7.4, in addition to any other information which may be relevant and appropriate:

63.7.1 The party's good faith endeavors or lack thereof to cooperate fully and faithfully with any governmental investigation or audit, including but not limited to the discipline, discharge, or disassociation of any person failing to testify, the production of accurate and complete books and records, and the forthcoming testimony of all other members, agents, assignees or fiduciaries whose testimony is sought.

63.7.2 The relationship of the person who refused to testify to any entity that is a party to the hearing, including but not limited to, whether the person whose testimony is sought has an ownership interest in the entity and/or the degree of authority and responsibility the person has within the entity.

63.7.3 The nexus of the testimony sought to the subject entity and its contracts, leases, permits or licenses with the City.

63.7.4 The effect a penalty may have on an unaffiliated and unrelated party or entity that has a significant interest in an entity subject to penalties under Article 63.6, provided that the party or entity has given actual notice to the Commissioner upon the acquisition of the interest, or at the hearing called for in Article 63.4, gives notice and proves that such interest was previously acquired. Under either circumstance the party or entity shall present evidence at the hearing demonstrating the potential adverse impact a penalty will have on such person or entity.

63.8 Definitions:

63.8.1 The term "license" or "permit" as used in this Article 63 shall be defined as a license, permit, franchise or concession not granted as a matter of right.

63.8.2 The term "person" as used in this Article 63 shall be defined as any natural person doing business alone or associated with another person or entity as a partner, director, officer, principal or employee.

63.8.3 The term "entity" as used in this Article 63 shall be defined as any firm, partnership, corporation, association, joint venture, or person that receives monies, benefits, licenses, leases, or permits from or through the City or otherwise transacts business with the City.

63.8.4 The term "member" as used in this Article 63 shall be defined as any person associated with another person or entity as a partner, director, officer, principal or employee.

63.9 In addition to and notwithstanding any other provision of this Contract, the Commissioner may in his/her sole discretion terminate this Contract upon not less than three (3) Days' written notice in the event the Contractor fails to promptly report in writing to the Commissioner of the Department of Investigations ("DOI") of the City any solicitation of money, goods, requests for future employment or other benefit or thing of value, by or on behalf of any employee of the City or other person, firm, corporation or entity for any purpose which may be related to the procurement or obtaining of this Contract by the Contractor, or affecting the performance of this Contract.

#### **ARTICLE 64. TERMINATION BY THE CITY**

64.1 In addition to termination pursuant to any other article of this Contract, the Commissioner may, at any time, terminate this Contract by written notice to the Contractor. In the event of termination, the Contractor shall, upon receipt of such notice, unless otherwise directed by the Commissioner:

64.1.1 Stop Work on the date specified in the notice;

64.1.2 Take such action as may be necessary for the protection and preservation of the City's materials and property;

64.1.3 Cancel all cancelable orders for material and equipment;

64.1.4 Assign to the City and deliver to the Site or another location designated by the Commissioner, any non-cancelable orders for material and equipment that is not capable of use except in the performance of this Contract and has been specifically fabricated for the sole purpose of this Contract and not incorporated in the Work;

64.1.5 Take no action which will increase the amounts payable by the City under this Contract.

64.2 In the event of termination by the City pursuant to this Article 64, payment to the Contractor shall be in accordance with Articles 64.2.1, 64.2.2 or 64.2.3, to the extent that each respective article applies.

64.2.1 Lump Sum Contracts or Items: On all lump sum Contracts, or on lump sum items in a Contract, the City will pay the Contractor the sum of the amounts described in Articles 64.2.1(a) and 64.2.1(b), less all payments previously made pursuant to this Contract. On lump sum Contracts only, the City will also pay the Contractor an additional sum as provided in Article 64.2.1(c).

64.2.1(a) For Work completed prior to the notice of termination, the Contractor shall be paid a pro rata portion of the lump sum bid amount, plus approved change orders, based upon the percent completion of the Work, as determined by the

**Commissioner.** For the purpose of determining the pro rata portion of the lump sum bid amount to which the **Contractor** is entitled, the bid breakdown submitted in accordance with Article 41 shall be considered, but shall not be dispositive. The **Commissioner's** determination hereunder shall be final, binding, and conclusive.

64.2.1(b) For non-cancelable material and equipment that is not capable of use except in the performance of this **Contract** and has been specifically fabricated for the sole purpose of this **Contract**, but not yet incorporated in the **Work**, the **Contractor** shall be paid the lesser of the following, less salvage value:

64.2.1(b)(i) The Direct Cost, as defined in Article 64.2.4; or

64.2.1(b)(ii) The fair and reasonable value, if less than Direct Cost, of such material and equipment, plus necessary and reasonable delivery costs.

64.2.1(b)(iii) In addition, the **Contractor** shall be paid five (5%) percent of the amount described in Article 64.2.1(b)(i) or Article 64.2.1(b)(ii), whichever applies.

64.2.1(c) Except as otherwise provided in Article 64.2.1(d), on all lump sum **Contracts**, the **Contractor** shall be paid the percentage indicated below applied to the difference between the total lump sum bid amount and the total of all payments made prior to the notice of termination plus all payments allowed pursuant to Articles 64.2.1(a) and 64.2.1(b):

64.2.1(c)(i) Five (5%) percent of the first five million (\$5,000,000) dollars; and

64.2.1(c)(ii) Three (3%) percent of any amount between five million (\$5,000,000) dollars and fifteen million (\$15,000,000) dollars; plus

64.2.1(c)(iii) One (1%) percent of any amount over fifteen million (\$15,000,000) dollars.

64.2.1(d) In the event the **City** terminates a lump sum **Contract** pursuant to this Article 64 within ninety (90) **Days** after registration of the **Contract** with the **Comptroller**, the **Contractor** shall be paid one (1%) percent of the difference between the lump sum bid amount and the total of all payments made pursuant to this Article 64.2.

64.2.2 **Unit Price Contracts or Items:** On all unit price **Contracts**, or on unit price items in a **Contract**, the **City** will pay the **Contractor** the sum of the amounts described in Articles 64.2.2(a) and 64.2.2(b), less all payments previously made pursuant to this **Contract**:

64.2.2(a) For all completed units, the unit price stated in the **Contract**, and

64.2.2(b) For units that have been ordered but are only partially completed, the **Contractor** will be paid:

64.2.2(b)(i) A pro rata portion of the unit price stated in the **Contract** based upon the percent completion of the unit and

64.2.2(b)(ii) For non-cancelable material and equipment, payment will be made pursuant to Article 64.2.1(b).

64.2.3 Time and Materials Contracts or Items Based on Time and Material Records: On all Contracts or items in a Contract where payment for the Work is based on time and material records, the Contractor shall be paid in accordance with Article 26, less all payments previously made pursuant to this Contract.

64.2.4 Direct Costs: Direct Costs as used in this Article 64.2 shall mean:

64.2.4(a) The actual purchase price of material and equipment, plus necessary and reasonable delivery costs,

64.2.4(b) The actual cost of labor involved in construction and installation at the Site, and

64.2.4(c) The actual cost of necessary bonds and insurance purchased pursuant to requirements of this Contract less any amounts that have been or should be refunded by the Contractor's sureties or insurance carriers.

64.2.4(d) Direct Costs shall not include overhead.

64.3 In no event shall any payments under this Article 64 exceed the Contract price for such items.

64.4 All payments pursuant to Article 64 shall be in the nature of liquidated damages and shall be accepted by the Contractor in full satisfaction of all claims against the City.

64.5 The City may deduct or set off against any sums due and payable pursuant to this Article 64, any deductions authorized by this Contract or by Law (including but not limited to liquidated damages) and any claims it may have against the Contractor. The City's exercise of the right to terminate the Contract pursuant to this Article 64 shall not impair or otherwise effect the City's right to assert any claims it may have against the Contractor in a plenary action.

64.6 Where the Work covered by the Contract has been substantially completed, as determined in writing by the Commissioner, termination of the Work shall be handled as an omission of Work pursuant to Articles 29 and 33, in which case a change order will be issued to reflect an appropriate reduction in the Contract sum, or if the amount is determined after final payment, such amount shall be paid by the Contractor.

#### **ARTICLE 65. CHOICE OF LAW, CONSENT TO JURISDICTION AND VENUE**

65.1 This Contract shall be deemed to be executed in the City regardless of the domicile of the Contractor, and shall be governed by and construed in accordance with the Laws of the State of New York and the Laws of the United States, where applicable.

65.2 The parties agree that any and all claims asserted against the City arising under this Contract or related thereto shall be heard and determined in the courts of the State of New York ("New York State Courts") located in the City and County of New York. To effect this Contract and intent, the Contractor agrees:

65.2.1 If the City initiates any action against the Contractor in Federal court or in a New York State Court, service of process may be made on the Contractor either in person, wherever such Contractor may be found, or by registered mail addressed to the Contractor at its address as set forth in this Contract, or to such other address as the Contractor may provide to the City in writing; and

65.2.2 With respect to any action between the City and the Contractor in a New York State Court, the Contractor hereby expressly waives and relinquishes any rights it might otherwise have:

65.2.2(a) To move to dismiss on grounds of forum non conveniens;

65.2.2(b) To remove to Federal Court; and

65.2.2(c) To move for a change of venue to a New York State Court outside New York County.

65.2.3 With respect to any action brought by the City against the Contractor in a Federal Court located in the City, the Contractor expressly waives and relinquishes any right it might otherwise have to move to transfer the action to a Federal Court outside the City.

65.2.4 If the Contractor commences any action against the City in a court located other than in the City and County of New York, upon request of the City, the Contractor shall either consent to a transfer of the action to a New York State Court of competent jurisdiction located in the City and County of New York or, if the Court where the action is initially brought will not or cannot transfer the action, the Contractor shall consent to dismiss such action without prejudice and may thereafter reinstate the action in a New York State Court of competent jurisdiction in New York County.

65.3 If any provision(s) of this Article 65 is held unenforceable for any reason, each and all other provision(s) shall nevertheless remain in full force and effect.

#### **ARTICLE 66. PARTICIPATION IN AN INTERNATIONAL BOYCOTT**

66.1 The Contractor agrees that neither the Contractor nor any substantially owned affiliated company is participating or shall participate in an international boycott in violation of the provisions of the Federal Export Administration Act of 1979, as amended, or the regulations of the United States Department of Commerce (Commerce Department) promulgated thereunder.

66.2 Upon the final determination by the Commerce Department or any other agency of the United States as to, or conviction of the Contractor or a substantially-owned affiliated company thereof for participation in an international boycott in violation of the provisions of the Export Administration Act of 1979, as amended, or the regulations promulgated thereunder, the Comptroller may, at his/her option, render forfeit and void this Contract.

66.3 The Contractor shall comply in all respects, with the provisions of Section 6-114 of the Administrative Code and the rules and regulations issued by the Comptroller thereunder.



## **ARTICLE 67. LOCALLY BASED ENTERPRISE PROGRAM**

67.1 This Contract is subject to the requirements of Section 6-108.1 of the Administrative Code and regulations promulgated thereunder. No construction contract shall be awarded unless and until these requirements have been complied with in their entirety; however, compliance with this Article 67 is not required if the Agency sets Subcontractor Participation Goals for Minority- and Women-Owned Business Enterprises (M/WBEs).

67.2 Unless specifically waived by the Commissioner with the approval of the Division of Economic and Financial Opportunity of the City Department of Business Services, if any portion of the Contract is subcontracted, not less than ten (10%) percent of the total dollar amount of the Contract shall be awarded to locally based enterprises (LBEs); except that where less than ten (10%) percent of the total dollar amount of the Contract is subcontracted, such lesser percentage shall be so awarded.

67.3 The Contractor shall not require performance and payment bonds from LBE Subcontractors.

67.4 If the Contractor has indicated prior to award that no Work will be subcontracted, no Work shall be subcontracted without the prior approval of the Commissioner, which shall be granted only if the Contractor makes a good faith effort beginning at least six (6) weeks before the Work is to be performed to obtain LBE Subcontractors to perform the Work.

67.5 If the Contractor has not identified sufficient LBE Subcontractors prior to award, it shall sign a letter of compliance stating that it complies with Section 6-108.1 of the Administrative Code, recognizes that achieving the LBE requirement is a condition of its Contract, and shall submit documentation demonstrating its good faith efforts to obtain LBEs. After award, the Contractor shall begin to solicit LBE's to perform subcontracted Work at least six (6) weeks before the date such Work is to be performed and shall demonstrate that a good faith effort has been made to obtain LBEs on each subcontract until it meets the required percentage.

67.6 Failure of the Contractor to comply with the requirements of Section 6-108.1 of the Administrative Code and the regulations promulgated thereunder shall constitute a material breach of this Contract. Remedy for such breach may include the imposition of any or all of the following sanctions:

67.6.1 Reducing the Contractor's compensation by an amount equal to the dollar value of the percentage of the LBE subcontracting requirement not complied with;

67.6.2 Declaring the Contractor in default;

67.6.3 If the Contractor is an LBE, de-certifying and declaring the Contractor ineligible to participate in the LBE program for a period of up to three (3) years.

## **ARTICLE 68. ANTITRUST**

68.1 The Contractor hereby assigns, sells, and transfers to the City all right, title, and interest in and to any claims and causes of action arising under the antitrust Laws of New York State or of the United States relating to the particular goods or services purchased or procured by the City under this Contract.

**ARTICLE 69. MacBRIDE PRINCIPLES PROVISIONS**

**69.1 Notice To All Prospective Contractors:**

69.1.1 Local Law No. 34 of 1991 became effective on September 10, 1991 and added Section 6-115.1 of the Administrative Code. The local Law provides for certain restrictions on City Contracts to express the opposition of the people of the City to employment discrimination practices in Northern Ireland to promote freedom of work-place opportunity.

69.1.2 Pursuant to Section 6-115.1, prospective Contractors for Contracts to provide goods or services involving an expenditure of an amount greater than ten thousand (\$10,000.) dollars, or for construction involving an amount greater than fifteen thousand (\$15,000.) dollars, are asked to sign a rider in which they covenant and represent, as a material condition of their Contract, that any business operations in Northern Ireland conducted by the Contractor and any individual or legal entity in which the Contractor holds a ten (10%) percent or greater ownership interest in the Contractor will be conducted in accordance with the MacBride Principles of nondiscrimination in employment.

69.1.3 Prospective Contractors are not required to agree to these conditions. However, in the case of Contracts let by competitive sealed bidding, whenever the lowest responsible bidder has not agreed to stipulate to the conditions set forth in this notice and another bidder who has agreed to stipulate to such conditions has submitted a bid within five (5%) percent of the lowest responsible bid for a Contract to supply goods, services or construction of comparable quality, the Agency shall refer such bids to the Mayor, the Speaker or other officials, as appropriate, who may determine, in accordance with applicable Law, that it is in the best interest of the City that the Contract be awarded to other than the lowest responsible pursuant to Section 313(b)(2) of the City Charter.

69.1.4 In the case of Contracts let by other than competitive sealed bidding, if a prospective Contractor does not agree to these conditions, no Agency, elected official or the City Council shall award the Contract to that bidder unless the Agency seeking to use the goods, services or construction certifies in writing that the Contract is necessary for the Agency to perform its functions and there is no other responsible Contractor who will supply goods, services or construction of comparable quality at a comparable price.

69.2 In accordance with Section 6-115.1 of the Administrative Code, the Contractor stipulates that such Contractor and any individual or legal entity in which the Contractor holds a ten (10%) percent or greater ownership interest in the Contractor either:

69.2.1 Have no business operations in Northern Ireland, or

69.2.2 Shall take lawful steps in good faith to conduct any business operations they have in Northern Ireland in accordance with the MacBride Principles, and shall permit independent monitoring of their compliance with such principles.

69.3 For purposes of this Article, the following terms shall have the following meanings:

69.3.1 "MacBride Principles" shall mean those principles relating to nondiscrimination in employment and freedom of work-place opportunity which require employers doing business in Northern Ireland to:

69.3.1(a) increase the representation of individuals from under-represented religious groups in the workforce, including managerial, supervisory, administrative, clerical and technical jobs;

69.3.1(b) take steps to promote adequate security for the protection of employees from under-represented religious groups both at the work-place and while traveling to and from Work;

69.3.1(c) ban provocative religious or political emblems from the workplace;

69.3.1(d) publicly advertise all job openings and make special recruitment efforts to attract applicants from under-represented religious groups;

69.3.1(e) establish layoff, recall, and termination procedures which do not in practice favor a particular religious group;

69.3.1(f) abolish all job reservations, apprenticeship restrictions and different employment criteria which discriminate on the basis of religion;

69.3.1(g) develop training programs that will prepare substantial numbers of current employees from under-represented religious groups for skilled jobs, including the expansion of existing programs and the creation of new programs to train, upgrade, and improve the skills of workers from under-represented religious groups;

69.3.1(h) establish procedures to assess, identify, and actively recruit employees from under-represented religious groups with potential for further advancement; and

69.3.1(i) appoint a senior management staff member to oversee affirmative action efforts and develop a timetable to ensure their full implementation.

69.4 The Contractor agrees that the covenants and representations in Article 69.2 are material conditions to this Contract. In the event the Agency receives information that the Contractor who made the stipulation required by this Article 69 is in violation thereof, the Agency shall review such information and give the Contractor an opportunity to respond. If the Agency finds that a violation has occurred, the Agency shall have the right to declare the Contractor in default and/or terminate this Contract for cause and procure supplies, services or Work from another source in the manner the Agency deems proper. In the event of such termination, the Contractor shall pay to the Agency, or the Agency in its sole discretion may withhold from any amounts otherwise payable to the Contractor, the difference between the Contract price for the uncompleted portion of this Contract and the cost to the Agency of completing performance of this Contract either itself or by engaging another Contractor or Contractors. In the case of a requirement Contract, the Contractor shall be liable for such difference in price for the entire amount of supplies required by the Agency for the uncompleted term of Contractor's Contract. In the case of a construction Contract, the Agency shall also have the right to hold the Contractor in partial or total default in accordance with the default provisions of this Contract, and/or may seek debarment or suspension of the Contractor. The rights and remedies of the Agency hereunder shall be in addition to, and not in lieu of, any rights and remedies the Agency has pursuant to this Contract or by operation of Law.

**ARTICLE 70. ELECTRONIC FILING/NYC DEVELOPMENT HUB**

70.1 The Contractor shall electronically file all alteration type-2 and alteration type-3 applications via the New York City Development Hub Web site, except applications for the following types of minor alterations: enlargements, curb cuts, legalizations, fire alarms, builders pavement plans, and jobs filed on Landmark Preservation Commission calendared properties. All such filings must be professionally certified. Information about electronic filing via the New York City Development Hub is available on the City Department of Buildings Web site at [www.nyc.gov/buildings](http://www.nyc.gov/buildings).

**ARTICLE 71. PROHIBITION OF TROPICAL HARDWOODS**

71.1 Tropical hardwoods, as defined in Section 165 of the New York State Finance Law (Finance Law), shall not be utilized in the performance of this Contract except as expressly permitted by Section 165 of the Finance Law.

**ARTICLE 72. CONFLICTS OF INTEREST**

72.1 Section 2604 of the City Charter and other related provisions of the City Charter, the Administrative Code, and the Penal Law are applicable under the terms of this Contract in relation to conflicts of interest and shall be extended to Subcontractors authorized to perform Work, labor and services pursuant to this Contract and further, it shall be the duty and responsibility of the Contractor to so inform its respective Subcontractors. Notice is hereby given that, under certain circumstances, penalties may be invoked against the donor as well as the recipient of any form of valuable gift.

**ARTICLE 73. MERGER CLAUSE**

73.1 The written Contract herein, contains all the terms and conditions agreed upon by the parties hereto, and no other agreement, oral or otherwise, regarding the subject matter of this Contract shall be deemed to exist or to bind any of the parties hereto, or to vary any of the terms contained herein.

**ARTICLE 74. STATEMENT OF WORK**

74.1 The Contractor shall furnish all labor and materials and perform all Work in strict accordance with the Specifications and Addenda thereto, numbered as shown in Schedule A.

**ARTICLE 75. COMPENSATION TO BE PAID TO CONTRACTOR**

75.1 The City will pay and the Contractor will accept in full consideration for the performance of the Contract, subject to additions and deductions as provided herein, the total sum shown in Schedule A, this said sum being the amount at which the Contract was awarded to the Contractor at a public letting thereof, based upon the Contractor's bid for the Contract.

**ARTICLE 76. ELECTRONIC FUNDS TRANSFER**

76.1 In accordance with Section 6-107.1 of the Administrative Code, the Contractor agrees to accept payments under this Contract from the City by electronic funds transfer (EFT). An EFT is any

transfer of funds, other than a transaction originated by check, draft or similar paper instrument, which is initiated through an electronic terminal, telephonic instrument or computer or magnetic tape so as to order, instruct or authorize a financial institution to debit or credit an account. Prior to the first payment made under this Contract, the Contractor shall designate one financial institution or other authorized payment agent and shall complete the attached "EFT Vendor Payment Enrollment Form" in order to provide the Commissioner of the City Department of Finance with information necessary for the Contractor to receive electronic funds transfer payments through a designated financial institution or authorized payment agent. The crediting of the amount of a payment to the appropriate account on the books of a financial institution or other authorized payment agent designated by the Contractor shall constitute full satisfaction by the City for the amount of the payment under this Contract. The account information supplied by the Contractor to facilitate the electronic funds transfer shall remain confidential to the fullest extent provided by Law.

76.2 The Commissioner may waive the application of the requirements of this Article 76 to payments on contracts entered into pursuant to Section 315 of the City Charter. In addition, the Commissioner of the Department of Finance and the Comptroller may jointly issue standards pursuant to which the Agency may waive the requirements of this Article 76 for payments in the following circumstances: (i) for individuals or classes of individuals for whom compliance imposes a hardship; (ii) for classifications or types of checks; or (iii) in other circumstances as may be necessary in the interest of the City.

#### **ARTICLE 77. RECORDS RETENTION**

77.1 The Contractor agrees to retain all books, records, and other documents relevant to this Contract for six years after the final payment or termination of this Contract, whichever is later. City, state, and federal auditors and any other persons duly authorized by the City shall have full access to and the right to examine any such books, records, and other documents during the retention period.

#### **ARTICLE 78. EXAMINATION AND VIEWING OF SITE, CONSIDERATION OF OTHER SOURCES OF INFORMATION AND CHANGED SITE CONDITIONS**

78.1 Pre-Bidding (Investigation) Viewing of Site – Bidders must carefully view and examine the Site of the proposed Work, as well as its adjacent area, and seek other usual sources of information, for they will be conclusively presumed to have full knowledge of any and all conditions and hazards on, about or above the Site relating to or affecting in any way the performance of the Work to be done under the Contract that were or should have been known by a reasonably prudent bidder. To arrange a date for visiting the Site, bidders are to contact the Agency contact person specified in the bid documents.

78.2 Should the Contractor encounter during the progress of the Work site conditions or environmental hazards at the Site materially differing from any shown on the Contract Drawings or indicated in the Specifications or such conditions or environmental hazards as could not reasonably have been anticipated by the Contractor, which conditions or hazards will materially affect the cost of the Work to be done under the Contract, the attention of the Commissioner must be called immediately to such conditions or hazards before they are disturbed. The Commissioner shall thereupon promptly investigate the conditions or hazards. If the Commissioner finds that they do so materially differ, and that they could not have been reasonably anticipated by the Contractor, the Contract may be modified with the Commissioner's written approval.

**ARTICLE 79. PARTICIPATION BY MINORITY-OWNED AND WOMEN-OWNED  
BUSINESS ENTERPRISES IN CITY PROCUREMENT**

**NOTICE TO ALL PROSPECTIVE CONTRACTORS**

**ARTICLE I. M/WBE PROGRAM**

Local Law No. 129 of 2005 added and Local Law 1 of 2013 amended Section 6-129 of the Administrative Code of the City of New York (hereinafter "Section 6-129"). Section 6-129 establishes the program for participation in City procurement ("M/WBE Program") by minority-owned business enterprises ("MBEs") and women-owned business enterprises ("WBEs"), certified in accordance with Section 1304 of the New York City Charter. As stated in Section 6-129, the intent of the program is to address the impact of discrimination on the City's procurement process, and to promote the public interest in avoiding fraud and favoritism in the procurement process, increasing competition for City business, and lowering contract costs. The contract provisions contained herein are pursuant to Section 6-129, and the rules of the Department of Small Business Services ("DSBS") promulgated thereunder.

**If this Contract is subject to the M/WBE Program established by Section 6-129, the specific requirements of MBE and/or WBE participation for this Contract are set forth in Schedule B of the Contract (entitled the "M/WBE Utilization Plan"), and are detailed below. The Contractor must comply with all applicable MBE and WBE requirements for this Contract.**

All provisions of Section 6-129 are hereby incorporated in the Contract by reference and all terms used herein that are not defined herein shall have the meanings given such terms in Section 6-129. Article I, Part A, below, sets forth provisions related to the participation goals for construction, standard and professional services contracts. Article I, Part B, below, sets forth miscellaneous provisions related to the M/WBE Program.

**PART A**

**PARTICIPATION GOALS FOR CONSTRUCTION, STANDARD  
AND PROFESSIONAL SERVICES CONTRACTS OR TASK ORDERS**

1. The MBE and/or WBE Participation Goals established for this Contract or Task Orders issued pursuant to this Contract, ("Participation Goals"), as applicable, are set forth on Schedule B, Part I to this Contract (see Page 1, line 1 Total Participation Goals) or will be set forth on Schedule B, Part I to Task Orders issued pursuant to this Contract, as applicable.

The **Participation Goals** represent a percentage of the total dollar value of the Contract or Task Order, as applicable, that may be achieved by awarding subcontracts to firms certified with New York City Department of Small Business Services as MBEs and/or WBEs, and/or by crediting the participation of prime contractors and/or qualified joint ventures as provided in Section 3 below, unless the goals have been waived or modified by Agency in accordance with Section 6-129 and Part A, Sections 10 and 11 below, respectively.

2. If **Participation Goals** have been established for this Contract or Task Orders issued pursuant to this Contract, Contractor agrees or shall agree as a material term of the Contract that Contractor shall be subject to the **Participation Goals**, unless the goals are waived or modified by Agency in accordance with Section 6-129 and Part A, Sections 10 and 11 below, respectively.

3. If **Participation Goals** have been established for this Contract or Task Order issued pursuant to this Contract, a Contractor that is an MBE and/or WBE shall be permitted to count its own participation toward fulfillment of the relevant **Participation Goal**, provided that in accordance with Section 6-129 the value of Contractor's participation shall be determined by subtracting from the total value of the Contract or Task Order, as applicable, any amounts that the Contractor pays to direct subcontractors (as defined in Section 6-129(c)(13)), and provided further that a Contractor that is certified as both an MBE and a WBE may count its own participation either toward the goal for MBEs or the goal for WBEs, but not both.

A Contractor that is a qualified joint venture (as defined in Section 6-129(c)(30)) shall be permitted to count a percentage of its own participation toward fulfillment of the relevant **Participation Goal**. In accordance with Section 6-129, the value of Contractor's participation shall be determined by subtracting from the total value of the Contract or Task Order, as applicable, any amounts that Contractor pays to direct subcontractors, and then multiplying the remainder by the percentage to be applied to total profit to determine the amount to which an MBE or WBE is entitled pursuant to the joint venture agreement, provided that where a participant in a joint venture is certified as both an MBE and a WBE, such amount shall be counted either toward the goal for MBEs or the goal for WBEs, but not both.

4. A. If **Participation Goals** have been established for this Contract, a prospective contractor shall be required to submit with its bid or proposal, as applicable, a completed Schedule B, M/WBE Utilization Plan, Part II (see Pages 2-4) indicating: (a) whether the contractor is an MBE or WBE, or qualified joint venture; (b) the percentage of work it intends to award to direct subcontractors; and (c) in cases where the contractor intends to award direct subcontracts, a description of the type and dollar value of work designated for participation by MBEs and/or WBEs, and the time frames in which such work is scheduled to begin and end. In the event that this M/WBE Utilization Plan indicates that the bidder or proposer, as applicable, does not intend to meet the **Participation Goals**, the bid or proposal, as applicable, shall be deemed non-responsive, unless Agency has granted the bidder or proposer, as applicable, a pre-award waiver of the Participation Goals in accordance with Section 6-129 and Part A, Section 10 below.

B. (i) If this Contract is for a master services agreement or other requirements type contract that will result in the issuance of Task Orders that will be individually registered ("Master Services Agreement") and is subject to M/WBE **Participation Goals**, a prospective contractor shall be required to submit with its bid or proposal, as applicable, a completed Schedule B, M/WBE Participation Requirements for Master Services Agreements That Will Require Individually Registered Task Orders, Part II (page 2) indicating the prospective contractor's certification and required affirmations to make all reasonable good faith efforts to meet participation goals established on each individual Task Order issued pursuant to this Contract, or if a partial waiver is obtained or such goals are modified by the Agency, to meet the modified **Participation Goals** by soliciting and obtaining the participation of certified MBE and/or WBE firms. In the event that the Schedule B indicates that the bidder or proposer, as applicable, does not intend to meet the **Participation Goals** that may be established on Task Orders issued pursuant to this Contract, the bid or proposal, as applicable, shall be deemed nonresponsive.

(ii) **Participation Goals** on a Master Services Agreement will be established for individual Task Orders issued after the Master Services Agreement is awarded. If **Participation Goals** have been established on a Task Order, a contractor shall be required to submit a Schedule B – M/WBE Utilization Plan For Independently Registered Task Orders That Are Issued Pursuant to Master Services Agreements, Part II (see Pages 2-4) indicating: (a) whether the contractor is an MBE or WBE, or qualified joint venture; (b) the percentage of work it intends to award to direct subcontractors; and (c) in cases where the contractor intends to award direct subcontracts, a description of the type and dollar value of work designated for participation by MBEs and/or WBEs, and the time frames in which such work is scheduled to begin and end. The contractor must engage in good faith efforts to meet the **Participation Goals** as established for the Task Order unless Agency has granted the contractor a pre-award waiver of the Participation Goals in accordance with Section 6-129 and Part A, Section 10 below.

**C. THE BIDDER/PROPOSER MUST COMPLETE THE SCHEDULE B INCLUDED HEREIN (SCHEDULE B, PART II). A SCHEDULE B SUBMITTED BY THE BIDDER/PROPOSER WHICH DOES NOT INCLUDE THE VENDOR CERTIFICATION AND REQUIRED AFFIRMATIONS (SEE SECTION V OF PART II) WILL BE DEEMED TO BE NON-RESPONSIVE, UNLESS A FULL WAIVER OF THE PARTICIPATION GOALS IS GRANTED (SCHEDULE B, PART III). IN THE EVENT THAT THE CITY DETERMINES THAT THE BIDDER/PROPOSER HAS SUBMITTED A SCHEDULE B WHERE THE VENDOR CERTIFICATION AND REQUIRED AFFIRMATIONS ARE COMPLETED BUT OTHER ASPECTS OF THE SCHEDULE B ARE NOT COMPLETE, OR CONTAIN A COPY OR COMPUTATION ERROR THAT IS AT ODDS WITH THE VENDOR CERTIFICATION AND AFFIRMATIONS, THE BIDDER/PROPOSER WILL BE NOTIFIED BY THE AGENCY AND WILL BE GIVEN FOUR (4) CALENDAR DAYS FROM RECEIPT OF NOTIFICATION TO CURE THE SPECIFIED DEFICIENCIES AND RETURN A COMPLETED SCHEDULE B TO THE AGENCY. FAILURE TO DO SO WILL RESULT IN A DETERMINATION THAT THE BID/PROPOSAL IS NON-RESPONSIVE. RECEIPT OF NOTIFICATION IS DEFINED AS THE DATE NOTICE IS E-MAILED OR FAXED (IF THE BIDDER/PROPOSER HAS PROVIDED AN E-MAIL ADDRESS OR FAX NUMBER), OR NO LATER THAN FIVE (5) CALENDAR DAYS FROM THE DATE OF MAILING OR UPON DELIVERY, IF DELIVERED.**

5. Where an M/WBE Utilization Plan has been submitted, the Contractor shall, within 30 days of issuance by Agency of a notice to proceed, submit a list of proposed persons or entities to which it intends to award subcontracts within the subsequent 12 months. In the case of multiyear contracts, such list shall also be submitted every year thereafter. The Agency may also require the Contractor to report periodically about the contracts awarded by its direct subcontractors to indirect subcontractors (as defined in Section 6-129(c)(22)). **PLEASE NOTE: If this Contract is a public works project subject to GML §101(5) (i.e., a contract valued at or below \$3M for projects in New York City) or if the Contract is subject to a project labor agreement in accordance with Labor Law §222, and the bidder is required to identify at the time of bid submission its intended subcontractors for the Wicks trades (plumbing and gas fitting; steam heating, hot water heating, ventilating and air conditioning (HVAC); and electric wiring), the Contractor must identify all those to which it intends to award construction subcontracts for any portion of the Wicks trade work at the time of bid submission, regardless of what point in the life of the contract such subcontracts will occur. In identifying intended subcontractors in the bid submission, bidders may satisfy any Participation Goals established for this Contract by proposing one or more subcontractors that are MBEs and/or WBEs for any portion of the Wicks trade work. In the event that the Contractor's selection of a subcontractor is disapproved, the Contractor shall have a reasonable time to propose alternate subcontractors.**

6. MBE and WBE firms must be certified by DSBS in order for the Contractor to credit such firms' participation toward the attainment of the **Participation Goals**. Such certification must occur prior to the



firms' commencement of work. A list of MBE and WBE firms may be obtained from the DSBS website at [www.nyc.gov/buycertified](http://www.nyc.gov/buycertified), by emailing DSBS at [buyer@sbs.nyc.gov](mailto:buyer@sbs.nyc.gov), by calling (212) 513-6356, or by visiting or writing DSBS at 110 William St., New York, New York, 10038, 7th floor. Eligible firms that have not yet been certified may contact DSBS in order to seek certification by visiting [www.nyc.gov/getcertified](http://www.nyc.gov/getcertified), emailing [MWBE@sbs.nyc.gov](mailto:MWBE@sbs.nyc.gov), or calling the DSBS certification helpline at (212) 513-6311. A firm that is certified as both an MBE and a WBE may be counted either toward the goal for MBEs or the goal for WBEs, but not both. No credit shall be given for participation by a graduate MBE or graduate WBE, as defined in Section 6-129(c)(20).

7. Where an M/WBE Utilization Plan has been submitted, the Contractor shall, with each voucher for payment, and/or periodically as Agency may require, submit statements, certified under penalty of perjury, which shall include, but not be limited to, the total amount the Contractor paid to its direct subcontractors, and, where applicable pursuant to Section 6-129(j), the total amount direct subcontractors paid to indirect subcontractors; the names, addresses and contact numbers of each MBE or WBE hired as a subcontractor by the Contractor, and, where applicable, hired by any of the Contractor's direct subcontractors; and the dates and amounts paid to each MBE or WBE. The Contractor shall also submit, along with its voucher for final payment: the total amount it paid to subcontractors, and, where applicable pursuant to Section 6-129(j), the total amount its direct subcontractors paid directly to their indirect subcontractors; and a final list, certified under penalty of perjury, which shall include the name, address and contact information of each subcontractor that is an MBE or WBE, the work performed by, and the dates and amounts paid to each.

8. If payments made to, or work performed by, MBEs or WBEs are less than the amount specified in the Contractor's M/WBE Utilization Plan, Agency shall take appropriate action, in accordance with Section 6-129 and Article II below, unless the Contractor has obtained a modification of its M/WBE Utilization Plan in accordance with Section 6-129 and Part A, Section 11 below.

9. Where an M/WBE Utilization Plan has been submitted, and the Contractor requests a change order the value of which exceeds the greater of 10 percent of the Contract or Task Order, as applicable, or \$500,000, Agency shall review the scope of work for the Contract or Task Order, as applicable, and the scale and types of work involved in the change order, and determine whether the **Participation Goals** should be modified.

10. **Pre-award waiver of the Participation Goals.** (a) A bidder or proposer, or contractor with respect to a Task Order, may seek a pre-award full or partial waiver of the **Participation Goals** in accordance with Section 6-129, which requests that Agency change one or more **Participation Goals** on the grounds that the **Participation Goals** are unreasonable in light of the availability of certified firms to perform the services required, or by demonstrating that it has legitimate business reasons for proposing a lower level of subcontracting in its M/WBE Utilization Plan.

(b) To apply for a full or partial waiver of the **Participation Goals**, a bidder, proposer, or contractor, as applicable, must complete Part III (Page 5) of Schedule B and submit such request no later than seven (7) calendar days prior to the date and time the bids, proposals, or Task Orders are due, in writing to the Agency by email at [poped@ddc.nyc.gov](mailto:poped@ddc.nyc.gov) or via facsimile at (718) 391-1886. Bidders, proposers, or contractors, as applicable, who have submitted requests will receive an Agency response by no later than two (2) calendar days prior to the due date for bids, proposals, or Task Orders; provided, however, that if that date would fall on a weekend or holiday, an Agency response will be provided by close-of-business on the business day before such weekend or holiday date.

(c) If the Agency determines that the **Participation Goals** are unreasonable in light of the availability of certified firms to perform the services required, it shall revise the solicitation and extend the deadline for bids and proposals, or revise the Task Order, as applicable.

(d) Agency may grant a full or partial waiver of the **Participation Goals** to a bidder, proposer or contractor, as applicable, who demonstrates—before submission of the bid, proposal or Task Order, as applicable—that it has legitimate business reasons for proposing the level of subcontracting in its **M/WBE Utilization Plan**. In making its determination, Agency shall consider factors that shall include, but not be limited to, whether the bidder, proposer or contractor, as applicable, has the capacity and the bona fide intention to perform the Contract without any subcontracting, or to perform the Contract without awarding the amount of subcontracts represented by the **Participation Goals**. In making such determination, Agency may consider whether the **M/WBE Utilization Plan** is consistent with past subcontracting practices of the bidder, proposer or contractor, as applicable, whether the bidder, proposer or contractor, as applicable, has made efforts to form a joint venture with a certified firm, and whether the bidder, proposer, or contractor, as applicable, has made good faith efforts to identify other portions of the Contract that it intends to subcontract.

11. **Modification of M/WBE Utilization Plan.** (a) A Contractor may request a modification of its **M/WBE Utilization Plan** after award of this Contract. **PLEASE NOTE: If this Contract is a public works project subject to GML §101(5) (i.e., a contract valued at or below \$3M for projects in New York City) or if the Contract is subject to a project labor agreement in accordance with Labor Law §222, and the bidder is required to identify at the time of bid submission its intended subcontractors for the Wicks trades (plumbing and gas fitting; steam heating, hot water heating, ventilating and air conditioning (HVAC); and electric wiring), the Contractor may request a Modification of its M/WBE Utilization Plan as part of its bid submission.** The Agency may grant a request for Modification of a Contractor's **M/WBE Utilization Plan** if it determines that the Contractor has established, with appropriate documentary and other evidence, that it made reasonable, good faith efforts to meet the **Participation Goals**. In making such determination, Agency shall consider evidence of the following efforts, as applicable, along with any other relevant factors:

- (i) The Contractor advertised opportunities to participate in the Contract, where appropriate, in general circulation media, trade and professional association publications and small business media, and publications of minority and women's business organizations;
- (ii) The Contractor provided notice of specific opportunities to participate in the Contract, in a timely manner, to minority and women's business organizations;
- (iii) The Contractor sent written notices, by certified mail or facsimile, in a timely manner, to advise MBEs or WBEs that their interest in the Contract was solicited;
- (iv) The Contractor made efforts to identify portions of the work that could be substituted for portions originally designated for participation by MBEs and/or WBEs in the **M/WBE Utilization Plan**, and for which the Contractor claims an inability to retain MBEs or WBEs;
- (v) The Contractor held meetings with MBEs and/or WBEs prior to the date their bids or proposals were due, for the purpose of explaining in detail the scope and requirements of the work for which their bids or proposals were solicited;
- (vi) The Contractor made efforts to negotiate with MBEs and/or WBEs as relevant to perform specific subcontracts, or act as suppliers or service providers;
- (vii) Timely written requests for assistance made by the Contractor to Agency's **M/WBE liaison officer** and to DSBS;
- (viii) Description of how recommendations made by DSBS and Agency were acted upon and an explanation of why action upon such recommendations did not lead to the desired level of participation of MBEs and/or WBEs.

Agency's **M/WBE officer** shall provide written notice to the Contractor of the determination.

(b) The Agency may modify the **Participation Goals** when the scope of the work has been changed by the Agency in a manner that affects the scale and types of work that the Contractor indicated in its **M/WBE Utilization Plan** would be awarded to subcontractors.

12. If this Contract is for an indefinite quantity of construction, standard or professional services or is a requirements type contract and the Contractor has submitted an M/WBE Utilization Plan and has committed to subcontract work to MBEs and/or WBEs in order to meet the **Participation Goals**, the Contractor will not be deemed in violation of the M/WBE Program requirements for this Contract with regard to any work which was intended to be subcontracted to an MBE and/or WBE to the extent that the Agency has determined that such work is not needed.

13. If **Participation Goals** have been established for this Contract or a Task Order issued pursuant to this Contract, at least once annually during the term of the Contract or Task Order, as applicable, Agency shall review the Contractor's progress toward attainment of its M/WBE Utilization Plan, including but not limited to, by reviewing the percentage of work the Contractor has actually awarded to MBE and/or WBE subcontractors and the payments the Contractor made to such subcontractors.

14. If **Participation Goals** have been established for this Contract or a Task Order issued pursuant to this Contract, Agency shall evaluate and assess the Contractor's performance in meeting those goals, and such evaluation and assessment shall become part of the Contractor's overall contract performance evaluation.

#### **PART B: MISCELLANEOUS**

1. The Contractor shall take notice that, if this solicitation requires the establishment of an M/WBE Utilization Plan, the resulting contract may be audited by DSBS to determine compliance with Section 6-129. See §6-129(e)(10). Furthermore, such resulting contract may also be examined by the City's Comptroller to assess compliance with the M/WBE Utilization Plan.

2. Pursuant to DSBS rules, construction contracts that include a requirement for an M/WBE Utilization Plan shall not be subject to the law governing Locally Based Enterprises set forth in Section 6-108.1 of the Administrative Code of the City of New York.

3. DSBS is available to assist contractors and potential contractors in determining the availability of MBEs and/or WBEs to participate as subcontractors, and in identifying opportunities that are appropriate for participation by MBEs and/or WBEs in contracts.

4. Prospective contractors are encouraged to enter into qualified joint venture agreements with MBEs and/or WBEs as defined by Section 6-129(c)(30).

5. By submitting a bid or proposal the Contractor hereby acknowledges its understanding of the M/WBE Program requirements set forth herein and the pertinent provisions of Section 6-129, and any rules promulgated thereunder, and if awarded this Contract, the Contractor hereby agrees to comply with the M/WBE Program requirements of this Contract and pertinent provisions of Section 6-129, and any rules promulgated thereunder, all of which shall be deemed to be material terms of this Contract. The Contractor hereby agrees to make all reasonable, good faith efforts to solicit and obtain the participation of MBEs and/or WBEs to meet the required **Participation Goals**.

#### **ARTICLE II. ENFORCEMENT**

1. If Agency determines that a bidder or proposer, as applicable, has, in relation to this procurement, violated Section 6-129 or the DSBS rules promulgated pursuant to Section 6-129, Agency may disqualify such bidder or proposer, as applicable, from competing for this Contract and the Agency may revoke such bidder's or proposer's prequalification status, if applicable.

2. Whenever Agency believes that the Contractor or a subcontractor is not in compliance with Section 6-129 or the DSBS rules promulgated pursuant to Section 6-129, or any provision of this Contract that implements Section 6-129, including, but not limited to any M/WBE Utilization Plan, Agency shall send a written notice to the Contractor describing the alleged noncompliance and offering the Contractor an opportunity to be heard. Agency shall then conduct an investigation to determine whether such Contractor or subcontractor is in compliance.

3. In the event that the Contractor has been found to have violated Section 6-129, the DSBS rules promulgated pursuant to Section 6-129, or any provision of this Contract that implements Section 6-129, including, but not limited to, any M/WBE Utilization Plan, Agency may determine that one of the following actions should be taken:

- (a) entering into an agreement with the Contractor allowing the Contractor to cure the violation;
- (b) revoking the Contractor's pre-qualification to bid or make proposals for future contracts;
- (c) making a finding that the Contractor is in default of the Contract;
- (d) terminating the Contract;
- (e) declaring the Contractor to be in breach of Contract;
- (f) withholding payment or reimbursement;
- (g) determining not to renew the Contract;
- (h) assessing actual and consequential damages;
- (i) assessing liquidated damages or reducing fees, provided that liquidated damages may be based on amounts representing costs of delays in carrying out the purposes of the M/WBE Program, or in meeting the purposes of the Contract, the costs of meeting utilization goals through additional procurements, the administrative costs of investigation and enforcement, or other factors set forth in the Contract;
- (j) exercising rights under the Contract to procure goods, services or construction from another contractor and charge the cost of such contract to the Contractor that has been found to be in noncompliance; or
- (k) taking any other appropriate remedy.

4. If an M/WBE Utilization Plan has been submitted, and pursuant to this Article II, Section 3, the Contractor has been found to have failed to fulfill its **Participation Goals** contained in its M/WBE Utilization Plan or the **Participation Goals** as modified by Agency pursuant to Article I, Part A, Section 11, Agency may assess liquidated damages in the amount of ten percent (10%) of the difference between the dollar amount of work required to be awarded to MBE and/or WBE firms to meet the **Participation Goals** and the dollar amount the Contractor actually awarded and paid, and/or credited, to MBE and/or WBE firms. In view of the difficulty of accurately ascertaining the loss which the City will suffer by reason of Contractor's failure to meet the **Participation Goals**, the foregoing amount is hereby fixed and agreed as the liquidated damages that the City will suffer by reason of such failure, and not as a penalty. Agency may deduct and retain out of any monies which may become due under this Contract the amount of any such liquidated damages; and in case the amount which may become due under this Contract shall be less than the amount of liquidated damages suffered by the City, the Contractor shall be liable to pay the difference.

5. Whenever Agency has reason to believe that an MBE and/or WBE is not qualified for certification, or is participating in a contract in a manner that does not serve a commercially useful function (as defined in Section 6-129(c)(8)), or has violated any provision of Section 6-129, Agency shall notify the Commissioner of DSBS who shall determine whether the certification of such business enterprise should be revoked.

6. Statements made in any instrument submitted to Agency pursuant to Section 6-129 shall be submitted under penalty of perjury and any false or misleading statement or omission shall be grounds for the application of any applicable criminal and/or civil penalties for perjury. The making of a false or fraudulent statement by an MBE and/or WBE in any instrument submitted pursuant to Section 6-129 shall, in addition, be grounds for revocation of its certification.

7. The Contractor's record in implementing its M/WBE Utilization Plan shall be a factor in the evaluation of its performance. Whenever Agency determines that a Contractor's compliance with an M/WBE Utilization Plan has been unsatisfactory, Agency shall, after consultation with the City Chief Procurement Officer, file an advice of caution form for inclusion in VENDEX as caution data.

IN WITNESS WHEREOF, the Commissioner, on behalf of the City of New York, and the Contractor, have executed this agreement in quadruplicate, two parts of which are to remain with the Commissioner, another to be filed with the Comptroller of the City, and the fourth to be delivered to the Contractor.

THE CITY OF NEW YORK

By: \_\_\_\_\_  
Commissioner

CONTRACTOR:

By: \_\_\_\_\_  
(Member of Firm or Officer of Corporation)

Title: \_\_\_\_\_

(Where Contractor is a Corporation, add):  
Attest:

\_\_\_\_\_  
Secretary

(Seal)

**ACKNOWLEDGEMENT OF PRINCIPAL, IF A CORPORATION**

State of \_\_\_\_\_ County of \_\_\_\_\_ ss:

On this \_\_\_\_\_ day of \_\_\_\_\_, \_\_\_\_\_, before me personally came \_\_\_\_\_  
to me known who, being by me duly sworn did depose and say that he resides at \_\_\_\_\_  
\_\_\_\_\_ that he is the \_\_\_\_\_

of the corporation described in and which executed the foregoing instrument; that he knows the seal of said corporation; that one of the seals affixed to said instrument is such seal; that it was so affixed by order of the directors of said corporation, and that he signed his name thereto by like order.

\_\_\_\_\_  
Notary Public or Commissioner of Deeds

**ACKNOWLEDGEMENT OF PRINCIPAL, IF A PARTNERSHIP**

State of \_\_\_\_\_ County of \_\_\_\_\_ ss:

On this \_\_\_\_\_ day of \_\_\_\_\_, \_\_\_\_\_, before me personally appeared \_\_\_\_\_  
to me known, and known to me to be one of the members of the firm of \_\_\_\_\_

\_\_\_\_\_ described in and who executed the foregoing instrument; and he  
acknowledged to me that he executed the same as and for the act and deed of said firm.

\_\_\_\_\_  
Notary Public or Commissioner of Deeds

**ACKNOWLEDGEMENT OF PRINCIPAL, IF AN INDIVIDUAL**

State of \_\_\_\_\_ County of \_\_\_\_\_ ss:

On this \_\_\_\_\_ day of \_\_\_\_\_, \_\_\_\_\_, before me personally appeared \_\_\_\_\_  
to me known, and known to me to be the person described in and who executed the foregoing instrument;  
and acknowledged that he executed the same.

\_\_\_\_\_  
Notary Public or Commissioner of Deeds

ACKNOWLEDGEMENT BY COMMISSIONER

State of \_\_\_\_\_ County of \_\_\_\_\_ ss:

On this \_\_\_\_\_ day of \_\_\_\_\_, \_\_\_\_\_, before me personally came \_\_\_\_\_ to me known, and known to be the Deputy Commissioner of the Department of Design and Construction of The City of New York, the person described as such in and who as such executed the foregoing instrument and acknowledged to me that he executed the same as Deputy Commissioner for the purposes therein mentioned.

\_\_\_\_\_  
Notary Public or Commissioner of Deeds



AUTHORITY

MAYOR'S CERTIFICATE NO. CBX  
BUDGET DIRECTOR'S CERTIFICATE NO.

DATED  
DATED

APPROPRIATION  
COMMISSIONER'S CERTIFICATE

In conformity with the provisions of Section 6-101 of the Administrative Code of the City of New York, it is hereby certified that the estimated cost of the work, materials and supplies required by the within Contract, amounting to

\_\_\_\_\_  
\_\_\_\_\_

Dollars (\$ \_\_\_\_\_)

is chargeable to the fund of the Department of Design and Construction entitled Code

\_\_\_\_\_  
\_\_\_\_\_  
\_\_\_\_\_

Department of Design and Construction

I hereby certify that the specifications contained herein comply with the terms and conditions of the BUDGET.

\_\_\_\_\_  
Commissioner

COMPTROLLER'S CERTIFICATE

The City of New York \_\_\_\_\_

Pursuant to the provisions of Section 6-101 of the Administrative Code of the City of New York, I hereby certify that there remains unapplied and unexpended a balance of the above mentioned fund applicable to this Contract sufficient to pay the estimated expense of executing the same viz:

\$ \_\_\_\_\_

\_\_\_\_\_  
Comptroller

**MAYOR'S CERTIFICATE OR  
CERTIFICATE OF THE DIRECTOR  
OF THE BUDGET**

**Performance Bond #1 (Pages 100 to 103): Use if the total contract price is \$5 Million Or Less. Performance Bond #1 has been approved by the U.S. Small Business Administration ("SBA") for participation in its Bond Guarantee Program.**

PERFORMANCE BOND #1 (Page 1)

**PERFORMANCE BOND #1**

**KNOW ALL PERSONS BY THESE PRESENTS,;**

That we, \_\_\_\_\_  
\_\_\_\_\_  
\_\_\_\_\_

hereinafter referred to as the "Principal,"  
and, \_\_\_\_\_  
\_\_\_\_\_  
\_\_\_\_\_

hereinafter referred to as the "Surety" ("Sureties") are held and firmly bound to THE CITY OF NEW YORK, hereinafter referred to as the "City" or to its successors and assigns in the penal sum of \_\_\_\_\_  
\_\_\_\_\_  
\_\_\_\_\_

(\$ \_\_\_\_\_) Dollars, lawful money of the United States for the payment of which said sum of money well and truly to be made, we, and each of us, bind ourselves, our heirs, executors, administrators, successors and assigns, jointly and severally, firmly by these presents.

**WHEREAS**, the Principal is about to enter, or has entered, into a Contract in writing with the City for \_\_\_\_\_  
\_\_\_\_\_

a copy of which Contract is annexed to and hereby made a part of this bond as though herein set forth in full;

**NOW, THEREFORE**, the conditions of this obligation are such that if the Principal, his or its representatives or assigns, shall well and faithfully perform the said Contract and all modifications, amendments, additions and alterations thereto that may hereafter be made, according to its terms and its true intent and meaning, including repair and or replacement of defective work and guarantees of maintenance for the periods stated in the Contract, and shall fully indemnify and save harmless the City from all cost and damage which it may suffer by reason of the Principal's default of the Contract, and shall fully reimburse and repay the City for all outlay and expense which the City may incur in making

**Performance Bond #1 (Pages 100 to 103): Use if the total contract price is \$5 Million Or Less. Performance Bond #1 has been approved by the U.S. Small Business Administration ("SBA") for participation in its Bond Guarantee Program.**

PERFORMANCE BOND #1 (Page 2)

good any such default and shall protect the said City of New York against, and pay any and all amounts, damages, cost and judgments which may or shall be recovered against said City or its officers or agents or which the said City of New York may be called upon to pay any person or corporation by reason of any damages arising or growing out of the Principal's default of the Contract, then this obligation shall be null and void, otherwise to remain in full force and effect.

The Surety (Sureties), for value received, hereby stipulates and agrees, upon written notice from the City that the City has determined that the Principal is in default of the Contract, to (1) pay the City the cost to complete the contract as determined by the City in excess of the balance of the Contract held by the City, plus any damages or costs to which the City is entitled, up to the full amount of the above penal sum, (2) fully perform and complete the Work to be performed under the Contract, pursuant to the terms, conditions, and covenants thereof, or (3) tender a completion Contractor that is acceptable to the City. The Surety (Sureties) further agrees, at its option, either to notify the City that it elects to pay the city the cost of completion plus any applicable damages and costs under option (1) above, or to commence and diligently perform the Work specified in the Contract, including physical site work, within twenty-five (25) business days after written notice thereof from the City and, if the Surety elects to fully perform and complete the Work, then to complete all Work within the time set forth in the Contract or such other time as agreed to between the City and Surety in accordance with the Contract. If the Surety elects to tender payment pursuant to (1) above, then the Surety shall tender such amount within fifteen (15) business days notification from the City of the cost of completion. The Surety and the City reserve all rights and defenses each may have against the other; provided, however, that the Surety expressly agrees that its reservation of rights shall not provide a basis for non-performance of its obligation to pay the City the cost of completion, to commence and complete all Work as provided herein, or to tender a completion contractor.

The Surety (Sureties), for value received, for itself and its successors and assigns, hereby stipulates and agrees that the obligation of said Surety (Sureties) and its bond shall be in no way impaired or affected by any extension of time, modification, omission, addition, or change in or to the said Contract or the Work to be performed thereunder, or by any payment thereunder before the time required therein, or by any waiver of any provisions thereof, or any moneys due or to become due thereunder; and said Surety (Sureties) does hereby waive notice of any and all of such extensions, modifications, omissions, additions, changes, payments, and waivers, and hereby expressly stipulates and agrees that any and all things done and omitted to be done by and in relation to subcontractors shall have the same effect as to said Surety (Sureties) as though done or omitted to be done by or in relation to said Principal. Notwithstanding the above, if the City makes payments to the Principal before the time required by the contract that in the aggregate exceed \$100,000 or 10% of the Contract price, whichever is less, and that have not become earned prior to the Principal being found to be in default, then all payments made to the Principal before the time required by the Contract shall be added to the remaining contract value available to be paid for the completion of the Contract as if such sums had not been paid to the Principal, but shall not provide a basis for non-performance of its obligation to pay the City the cost of completion, to commence and to complete all Work as provided herein, or to tender a completion contractor.

**Performance Bond #1 (Pages 100 to 103): Use if the total contract price is \$5 Million Or Less. Performance Bond #1 has been approved by the U.S. Small Business Administration ("SBA") for participation in its Bond Guarantee Program.**

PERFORMANCE BOND #1 (Page 3)

IN WITNESS WHEREOF, The Principal and the Surety (Sureties) have hereunto set their hands and seals, and such of them as are corporations have caused their corporate seals to be hereunto affixed and these presents to be signed by their proper officers, this

\_\_\_\_\_ day of \_\_\_\_\_, 20\_\_\_\_.  
(Seal)

\_\_\_\_\_  
Principal (L.S.)

By: \_\_\_\_\_  
(Seal) Surety

By: \_\_\_\_\_  
(Seal) Surety

By: \_\_\_\_\_  
(Seal) Surety

By: \_\_\_\_\_  
(Seal) Surety

By: \_\_\_\_\_  
(Seal) Surety

By: \_\_\_\_\_

Bond Premium Rate \_\_\_\_\_

Bond Premium Cost \_\_\_\_\_

If the Contractor (Principal) is a partnership, the bond should be signed by each of the individuals who are partners.

If the Contractor (Principal) is a corporation, the bond should be signed in its correct corporate name by a duly authorized officer, agent, or attorney-in-fact.

There should be executed an appropriate number of counterparts of the bond corresponding to the number of counterparts of the Contract.

**Performance Bond #1 (Pages 100 to 103): Use if the total contract price is \$5 Million Or Less. Performance Bond #1 has been approved by the U.S. Small Business Administration ("SBA") for participation in its Bond Guarantee Program.**

PERFORMANCE BOND #1 (Page 4)

**ACKNOWLEDGMENT OF PRINCIPAL IF A CORPORATION**

State of \_\_\_\_\_ County of \_\_\_\_\_ ss:

On this \_\_\_\_\_ day of \_\_\_\_\_, 20\_\_\_\_ before me personally came \_\_\_\_\_, to me known, who, being by me duly sworn did depose and say that he/she resides at \_\_\_\_\_

\_\_\_\_\_ ; that he/she is the \_\_\_\_\_ of the corporation described in and which executed the foregoing instrument; and that he/she signed his/her name to the foregoing instrument by order of the directors of said corporation as the duly authorized and binding act thereof.

\_\_\_\_\_  
Notary Public or Commissioner of Deeds.

**ACKNOWLEDGMENT OF PRINCIPAL IF A PARTNERSHIP**

State of \_\_\_\_\_ County of \_\_\_\_\_ ss:

On this \_\_\_\_\_ day of \_\_\_\_\_, 20\_\_\_\_ before me personally came \_\_\_\_\_, to me known, who, being by me duly sworn did depose and say that he/she resides at \_\_\_\_\_

\_\_\_\_\_ ; that he/she is \_\_\_\_\_ partner of \_\_\_\_\_, a limited/general partnership existing under the laws of the State of \_\_\_\_\_, the partnership described in and which executed the foregoing instrument; and that he/she signed his/her name to the foregoing instrument as the duly authorized and binding act of said partnership.

\_\_\_\_\_  
Notary Public or Commissioner of Deeds.

**ACKNOWLEDGMENT OF PRINCIPAL IF AN INDIVIDUAL**

State of \_\_\_\_\_ County of \_\_\_\_\_ ss:

On this \_\_\_\_\_ day of \_\_\_\_\_, 20\_\_\_\_ before me personally came \_\_\_\_\_, to me known, who, being by me duly sworn did depose and say that he/she resides at \_\_\_\_\_

\_\_\_\_\_ , and that he/she is the individual whose name is subscribed to the within instrument and acknowledged to me that by his/her signature on the instrument, said individual executed the instrument.

\_\_\_\_\_  
Notary Public or Commissioner of Deeds

Each executed bond should be accompanied by: (a) appropriate acknowledgments of the respective parties; (b) appropriate duly certified copy of Power of Attorney or other certificate of authority where bond is executed by agent, officer or other representative of Principal or Surety; (c) a duly certified extract from By-Laws or resolutions of Surety under which Power of Attorney or other certificate of authority of its agent, officer or representative was issued, and (d) certified copy of latest published financial statement of assets and liabilities of Surety.

\*\*\*\*\*

Affix Acknowledgments and Justification of Sureties.

**Performance Bond #2 (Pages 104 to 107): Use if the total contract price is more than \$5 Million.**

PERFORMANCE BOND #2 (Page 1)

**PERFORMANCE BOND #2**

**KNOW ALL PERSONS BY THESE PRESENTS:**

That we, \_\_\_\_\_

\_\_\_\_\_

\_\_\_\_\_

hereinafter referred to as the "Principal,"

and, \_\_\_\_\_

\_\_\_\_\_

\_\_\_\_\_

hereinafter referred to as the "Surety" ("Sureties") are held and firmly bound to THE CITY OF NEW YORK, hereinafter referred to as the "City" or to its successors and assigns in the penal sum of \_\_\_\_\_

\_\_\_\_\_

\_\_\_\_\_

(\$ \_\_\_\_\_) Dollars, lawful money of the United States for the payment of which said sum of money well and truly to be made, we, and each of us, bind ourselves, our heirs, executors, administrators, successors and assigns, jointly and severally, firmly by these presents.

**WHEREAS**, the Principal is about to enter, or has entered, into a Contract in writing with the City for

\_\_\_\_\_

\_\_\_\_\_

a copy of which Contract is annexed to and hereby made a part of this bond as though herein set forth in full;

**NOW, THEREFORE**, the conditions of this obligation are such that if the Principal, his or its representatives or assigns, shall well and faithfully perform the said Contract and all modifications, amendments, additions and alterations thereto that may hereafter be made, according to its terms and its true intent and meaning, including repair and or replacement of defective work and guarantees of maintenance for the periods stated in the Contract, and shall fully indemnify and save harmless the City from all cost and damage which it may suffer by reason of the Principal's default of the Contract, and shall fully reimburse and repay the City for all outlay and expense which the City may incur in making

**Performance Bond #2 (Pages 104 to 107): Use if the total contract price is more than \$5 Million.**

PERFORMANCE BOND #2 (Page 2)

good any such default and shall protect the said City of New York against, and pay any and all amounts, damages, cost and judgments which may or shall be recovered against said City or its officers or agents or which the said City of New York may be called upon to pay any person or corporation by reason of any damages arising or growing out of the Principal's default of the Contract, then this obligation shall be null and void, otherwise to remain in full force and effect.

The Surety (Sureties), for value received, hereby stipulates and agrees, upon written notice from the City that the City has determined that the Principal is in default of the Contract, to either (1) pay the full amount of the above penal sum in complete discharge and exoneration of this bond and of all the liabilities of the Surety relating to this bond, or (2) fully perform and complete the Work to be performed under the Contract, pursuant to the terms, conditions, and covenants thereof. The Surety (Sureties) further agrees, at its option, either to tender the penal sum or to commence and diligently perform the Work specified in the Contract, including physical site work, within twenty-five (25) business days after written notice thereof from the City and to complete all Work within the time set forth in the Contract or such other time as agreed to between the City and Surety in accordance with the Contract. The Surety and the City reserve all rights and defenses each may have against the other; provided, however, that the Surety expressly agrees that its reservation of rights shall not provide a basis for non-performance of its obligation to commence and to complete all Work as provided herein.

The Surety (Sureties), for value received, for itself and its successors and assigns, hereby stipulates and agrees that the obligation of said Surety (Sureties) and its bond shall be in no way impaired or affected by any extension of time, modification, omission, addition, or change in or to the said Contract or the Work to be performed thereunder, or by any payment thereunder before the time required therein, or by any waiver of any provisions thereof, or by any assignment, subletting or other transfer thereof or of any Work to be performed or any moneys due or to become due thereunder; and said Surety (Sureties) does hereby waive notice of any and all of such extensions, modifications, omissions, additions, changes, payments, waivers, assignments, subcontracts and transfers, and hereby expressly stipulates and agrees that any and all things done and omitted to be done by and in relation to assignees, subcontractors, and other transferees shall have the same effect as to said Surety (Sureties) as though done or omitted to be done by or in relation to said Principal.



**Performance Bond #2 (Pages 104 to 107): Use if the total contract price is more than \$5 Million.**

PERFORMANCE BOND #2 (Page 3)

**IN WITNESS WHEREOF**, The Principal and the Surety (Sureties) have hereunto set their hands and seals, and such of them as are corporations have caused their corporate seals to be hereunto affixed and these presents to be signed by their proper officers, this

\_\_\_\_\_ day of \_\_\_\_\_ 20\_\_\_\_\_.  
(Seal)

\_\_\_\_\_  
Principal (L.S.)

(Seal) By: \_\_\_\_\_  
Surety

(Seal) By: \_\_\_\_\_  
Surety

(Seal) By: \_\_\_\_\_  
Surety

(Seal) By: \_\_\_\_\_  
Surety

(Seal) By: \_\_\_\_\_  
Surety

(Seal) By: \_\_\_\_\_

Bond Premium Rate \_\_\_\_\_

Bond Premium Cost \_\_\_\_\_

If the Contractor (Principal) is a partnership, the bond should be signed by each of the individuals who are partners.

If the Contractor (Principal) is a corporation, the bond should be signed in its correct corporate name by a duly authorized officer, agent, or attorney-in-fact.

There should be executed an appropriate number of counterparts of the bond corresponding to the number of counterparts of the Contract.

**Performance Bond #2 (Pages 104 to 107): Use if the total contract price is more than \$5 Million.**

PERFORMANCE BOND #2 (Page 4)

**ACKNOWLEDGMENT OF PRINCIPAL IF A CORPORATION**

State of \_\_\_\_\_ County of \_\_\_\_\_ ss:

On this \_\_\_\_\_ day of \_\_\_\_\_, 20 \_\_\_\_\_ before me personally came \_\_\_\_\_, to me known, who, being by me duly sworn did depose and say that he resides at \_\_\_\_\_

\_\_\_\_\_ ; that he/she is the \_\_\_\_\_ of the corporation described in and which executed the foregoing instrument; that he/she signed his/her name to the foregoing instrument by order of the directors of said corporation as the duly authorized and binding act thereof.

\_\_\_\_\_  
Notary Public or Commissioner of Deeds.

**ACKNOWLEDGMENT OF PRINCIPAL IF A PARTNERSHIP**

State of \_\_\_\_\_ County of \_\_\_\_\_ ss:

On this \_\_\_\_\_ day of \_\_\_\_\_, 20 \_\_\_\_\_ before me personally came \_\_\_\_\_, to me known, who, being by me duly sworn did depose and say that he/she resides at \_\_\_\_\_

\_\_\_\_\_ ; that he/she is \_\_\_\_\_ partner of \_\_\_\_\_, a limited/general partnership existing under the laws of the State of \_\_\_\_\_, the partnership described in and which executed the foregoing instrument; and that he/she signed his/her name to the foregoing instrument as the duly authorized and binding act of said partnership.

\_\_\_\_\_  
Notary Public or Commissioner of Deeds

**ACKNOWLEDGMENT OF PRINCIPAL IF AN INDIVIDUAL**

State of \_\_\_\_\_ County of \_\_\_\_\_ ss:

On this \_\_\_\_\_ day of \_\_\_\_\_, 20 \_\_\_\_\_ before me personally came \_\_\_\_\_, to me known, who, being by me duly sworn did depose and say that he/she resides at \_\_\_\_\_

\_\_\_\_\_ , and that he/she is the individual whose name is subscribed to the within instrument and acknowledged to me that by his/her signature on the instrument, said individual executed the instrument.

\_\_\_\_\_  
Notary Public or Commissioner of Deeds

Each executed bond should be accompanied by: (a) appropriate acknowledgments of the respective parties; (b) appropriate duly certified copy of Power of Attorney or other certificate of authority where bond is executed by agent, officer or other representative of Principal or Surety; (c) a duly certified extract from By-Laws or resolutions of Surety under which Power of Attorney or other certificate of authority of its agent, officer or representative was issued, and (d) certified copy of latest published financial statement of assets and liabilities of Surety.

\*\*\*\*\*

Affix Acknowledgments and Justification of Sureties.

**Payment Bond (Pages 108 to 111): Use for any contract for which a Payment Bond is required.**

PAYMENT BOND (Page 1)

PAYMENT BOND

KNOW ALL PERSONS BY THESE PRESENTS, That we, \_\_\_\_\_

\_\_\_\_\_  
\_\_\_\_\_  
\_\_\_\_\_

hereinafter referred to as the "Principal", and \_\_\_\_\_

\_\_\_\_\_  
\_\_\_\_\_  
\_\_\_\_\_

hereinafter referred to as the "Surety" ("Sureties") are held and firmly bound to THE CITY OF NEW YORK, hereinafter referred to as the "City" or to its successors and assigns, in the penal sum of

\_\_\_\_\_  
\_\_\_\_\_  
\_\_\_\_\_

(\$ \_\_\_\_\_) Dollars, lawful money of the United States, for the payment of which said sum of money well and truly to be made, we, and each of us, bind ourselves, our heirs, executors, administrators, successors and assigns, jointly and severally, firmly by these presents.

WHEREAS, the Principal is about to enter, or has entered, into a Contract in writing with the City for

\_\_\_\_\_  
\_\_\_\_\_  
\_\_\_\_\_

a copy of which Contract is annexed to and hereby made a part of this bond as though herein set forth in full;

NOW, THEREFORE, the conditions of this obligation are such that if the Principal, his or its representatives or assigns and other Subcontractors to whom Work under this Contract is sublet and his or their successors and assigns shall promptly pay or cause to be paid all lawful claims for

(a) Wages and compensation for labor performed and services rendered by all persons engaged in the prosecution of the Work under said Contract, and any amendment or extension thereof or addition thereto, whether such persons be agents servants or employees of the Principal or any such Subcontractor, including all persons so engaged who perform the work of laborers or mechanics at or in the vicinity of the site

**Payment Bond (Pages 108 to 111): Use for any contract for which a Payment Bond is required.**

PAYMENT BOND (Page 2)

of the Project regardless of any contractual relationship between the Principal or such Subcontractors, or his or their successors or assigns, on the one hand and such laborers or mechanics on the other, but not including office employees not regularly stationed at the site of the project; and

(b) Materials and supplies (whether incorporated in the permanent structure or not), as well as teams, fuels, oils, implements or machinery furnished, used or consumed by said Principal or any subcontractor at or in the vicinity of the site of the Project in the prosecution of the Work under said Contract and any amendment or extension thereof or addition thereto; then this obligation shall be void, otherwise to remain in full force and effect.

This bond is subject to the following additional conditions, limitations and agreements:

(a) The Principal and Surety (Sureties) agree that this bond shall be for the benefit of any materialmen or laborer having a just claim, as well as the City itself.

(b) All persons who have performed labor, rendered services or furnished materials and supplies, as aforesaid, shall have a direct right of action against the Principal and his, its or their successors and assigns, and the Surety (Sureties) herein, or against either or both or any of them and their successors and assigns. Such persons may sue in their own name, and may prosecute the suit to judgment and execution without the necessity of joining with any other persons as party plaintiff.

(c) The Principal and Surety (Sureties) agree that neither of them will hold the City liable for any judgment for costs of otherwise, obtained by either or both of them against a laborer or materialman in a suit brought by either a laborer or materialman under this bond for moneys allegedly due for performing work or furnishing material.

(d) The Surety (Sureties) or its successors and assigns shall not be liable for any compensation recoverable by an employee or laborer under the Workmen's Compensation Law.

(e) In no event shall the Surety (Sureties), or its successors or assigns, be liable for a greater sum than the penalty of this bond or be subject to any suit, action or proceeding hereon that is instituted by any person, firm, or corporation hereunder later than two years after the complete performance of said Contract and final settlement thereof.

The Principal, for himself and his successors and assigns, and the Surety (Sureties), for itself and its successors and assigns, do hereby expressly waive any objection that might be interposed as to the right of the City to require a bond containing the foregoing provisions, and they do hereby further expressly waive any defense which they or either of them might interpose to an action brought hereon by any person, firm or corporation, including subcontractors, materialmen and third persons, for work, labor, services, supplies or material performed rendered, or furnished as aforesaid upon the ground that there is no law authorizing the City to require the foregoing provisions to be placed in this bond.

And the Surety (Sureties), for value received, for itself and its successors and assigns, hereby stipulates and agrees that the obligation of said Surety (Sureties), and its bonds shall be in no way impaired or affected by any extension of time, modification, omission, addition, or change in or of the said Contract or the work to be performed thereunder, or by any payment thereunder before the time required therein, or by any waiver of any provisions thereof, or by any assignment, subletting or other transfer thereof or of any part thereof, or of any Work to be performed, or any moneys due to become due thereunder and said Surety (Sureties) does hereby waive notice of any and all of such extensions, modifications, omissions, additions, changes, payments, waivers, assignments, subcontracts and transfers, and hereby expressly stipulates and agrees that any and all things done and omitted to be done by and in relation to assignees, Subcontractors, and other transferees shall have the same effect as to said Surety (Sureties) as though done or omitted to be done or in relation to said Principal.

**Payment Bond (Pages 108 to 111): Use for any contract for which a Payment Bond is required.**

PAYMENT BOND (Page 3)

IN WITNESS WHEREOF, the Principal and the Surety (Sureties) have hereunto set their hands and seals, and such of them as are corporations have caused their corporate seals to be hereunto affixed and these presents to be signed by their proper officers, this \_\_\_\_\_ day of \_\_\_\_\_, \_\_\_\_\_.

(Seal) \_\_\_\_\_ (L.S.)  
Principal

By: \_\_\_\_\_

(Seal) \_\_\_\_\_  
Surety

By: \_\_\_\_\_

(Seal) \_\_\_\_\_  
Surety

By: \_\_\_\_\_

(Seal) \_\_\_\_\_  
Surety

By: \_\_\_\_\_

(Seal) \_\_\_\_\_  
Surety

By: \_\_\_\_\_

If the Contractor (Principal) is a partnership, the bond should be signed by each of the individuals who are partners.

If the Contractor (Principal) is a corporation, the bond should be signed in its correct corporate name by a duly authorized officer, agent, or attorney-in-fact.

There should be executed an appropriate number of counterparts of the bond corresponding to the number of counterparts of the Contract.

**Payment Bond (Pages 108 to 111): Use for any contract for which a Payment Bond is required.**

PAYMENT BOND (Page 4)

**ACKNOWLEDGMENT OF PRINCIPAL, IF A CORPORATION**

State of \_\_\_\_\_ County of \_\_\_\_\_ ss:

On this \_\_\_\_ day of \_\_\_\_\_, \_\_\_\_\_, before me personally came \_\_\_\_\_ to me known, who, being by me duly sworn did depose and say that he resides at \_\_\_\_\_ that he is the \_\_\_\_\_ of the corporation described in and which executed the foregoing instrument; that he knows the seal of said corporation; that one of the seals affixed to said instrument is such seal; that it was so affixed by order of the directors of said corporation, and that he signed his name thereto by like order.

\_\_\_\_\_  
Notary Public or Commissioner of Deeds

**ACKNOWLEDGMENT OF PRINCIPAL, IF A PARTNERSHIP**

State of \_\_\_\_\_ County of \_\_\_\_\_ ss:

On this \_\_\_\_ day of \_\_\_\_\_, \_\_\_\_\_, before me personally appeared \_\_\_\_\_ to me known, and known to me to be one of the members of the firm of \_\_\_\_\_ described in and who executed the foregoing instrument; and he acknowledged to me that he executed the same as and for the act and deed of said firm.

\_\_\_\_\_  
Notary Public or Commissioner of Deeds

**ACKNOWLEDGMENT OF PRINCIPAL, IF AN INDIVIDUAL**

State of \_\_\_\_\_ County of \_\_\_\_\_ ss:

On this \_\_\_\_ day of \_\_\_\_\_, \_\_\_\_\_, before me personally appeared \_\_\_\_\_ to me known, and known to me to be the person described in and who executed the foregoing instrument; and acknowledged that he executed the same.

\_\_\_\_\_  
Notary Public or Commissioner of Deeds

Each executed bond should be accompanied by: (a) appropriate acknowledgments of the respective parties; (b) appropriate duly certified copy of Power of Attorney or other certificate of authority where bond is executed by agent, officer or other representative of Principal or Surety; (c) a duly certified extract from By-Laws or resolutions of Surety under which Power of Attorney or other certificate of authority of its agent, officer or representative was issued, and (d) certified copy of latest published financial statement of assets and liabilities of Surety.

\*\*\*\*\*

Affix Acknowledgments and Justification of Sureties.

(NO TEXT ON THIS PAGE)

OFFICE OF THE COMPTROLLER, CITY OF NEW YORK  
§220 PREVAILING-WAGE SCHEDULE

LABOR LAW §220 PREVAILING WAGE SCHEDULE

Workers, Laborers and Mechanics employed on a public work project must receive not less than the prevailing rate of wage and benefits for the classification of work performed by each upon such public work. Pursuant to Labor Law §220 the Comptroller of the City of New York has promulgated this schedule solely for Workers, Laborers and Mechanics engaged by private contractors on New York City public work contracts.

This schedule is a compilation of separate determinations of the prevailing rate of wage and supplements made by the Comptroller for each trade classification listed herein pursuant to New York State Labor Law section 220 (5). The source of the wage and supplement rates, whether a collective bargaining agreement, survey data or other, is listed at the end of each classification.

Agency Chief Contracting Officers should contact the Bureau of Labor Law's Classification Unit with any questions concerning trade classifications, prevailing rates or prevailing practices with respect to procurement on New York City public works contracts. Contractors are advised to review the Comptroller's Prevailing Wage Schedule before bidding on public works contracts. Contractors with questions concerning trade classifications, prevailing rates or prevailing practices with respect to public works contracts in the procurement stage must contact the contracting agency responsible for the procurement.

Any error as to compensation under the prevailing wage law or other information as to trade classification, made by the contracting agency in the contract documents or in any other communication, will not preclude a finding against the contractor of prevailing wage violation.

Any questions concerning trade classifications, prevailing rates or prevailing practices on New York City public works contracts that have already been awarded may be directed to the Bureau of Labor Law's Classification Unit by calling (212) 669-7974. All callers must have the agency name and contract registration number available when calling with questions on public works contracts. Please direct all other compliance issues to: Bureau of Labor Law, Attn: Wasyl Kinach, P.E., Office of the Comptroller, 1 Centre Street, Room 1122, New York, N.Y. 10007; Fax (212) 669-4002.

The appropriate schedule of prevailing wages and benefits must be posted at all public work sites pursuant to Labor Law §220 (3-a) (a).

This schedule is applicable to work performed during the effective period, unless otherwise noted. Changes to this schedule are published on our web site [www.comptroller.nyc.gov](http://www.comptroller.nyc.gov). Contractors must pay the wages and supplements in effect when the worker, laborer, mechanic performs the work. Preliminary schedules for future one-year periods appear in the City Record on or about June 1 each succeeding year. Final schedules appear on or about July 1 in the City Record and on our web site [www.comptroller.nyc.gov](http://www.comptroller.nyc.gov).

The Comptroller's Office has attempted to include all overtime, shift and night differential, Holiday, Saturday, Sunday or other premium time work. However, this schedule does not set forth every prevailing practice with respect to such rates with which employers must comply. All such practices are nevertheless part of the employer's prevailing wage obligation and contained in the collective bargaining agreements of the prevailing wage unions. These collective bargaining agreements are available for inspection by appointment. Requests for appointments may be made by calling (212) 669-4443, Monday through Friday between the hours of 9 a.m. and 5 p.m.



OFFICE OF THE COMPTROLLER, CITY OF NEW YORK  
§220 PREVAILING WAGE SCHEDULE

Prevailing rates and ratios for apprentices are attached to this schedule in the Appendix. Pursuant to Labor Law §220 (3-e), only apprentices who are individually registered in a bona fide program to which the employer contractor is a participant, registered with the New York State Department of Labor, may be employed on a public work project. Workers who are not journey persons or not registered apprentices pursuant to Labor Law §220 (3-e) may not be substituted for apprentices and must be paid as journey persons.

Public Work construction, reconstruction, demolition, excavation, rehabilitation, repair, renovation, alteration, or improvement contracts awarded pursuant to a Project Labor Agreement ("PLA") in accordance with Labor Law section 222 may have different labor standards for shift, premium and overtime work. Please refer to the PLA's pre-negotiated labor agreements for wage and benefit rates applicable to work performed outside of the regular workday. More information is available at the Mayor's Office of Contract Services (MOCS) web page at <http://www.nyc.gov/html/mocs/html/vendors/pla.shtml>.

All the provisions of Labor Law section 220 remain applicable to PLA work including, but not limited to, the enforcement of prevailing wage requirements by the Comptroller; however, we will enforce shift, premium, overtime and other non-standard rates as they appear in a project's pre-negotiated labor agreement.

In order to meet their obligation to provide prevailing supplemental benefits to each covered employee, employers must either:

- 1) Provide bona-fide benefits which cost the employer no less than the prevailing supplemental benefits rate; or
- 2) Supplement the employee's hourly wage by an amount no less than the prevailing supplemental benefits rate; or
- 3) Provide a combination of bona-fide benefits and wage supplements which cost the employer no less than the prevailing supplemental benefits rate in total.

Particular attention should be given to the supplemental benefits requirement. Although in most instances the payment or provision for supplemental benefits is for each hour worked, some classifications require the payment or provision of supplemental benefits for each hour paid. Consequently, some prevailing practices require benefits to be purchased at the overtime, shift differential, Holiday, Saturday, Sunday or other premium time rate.

**Benefits are paid for EACH HOUR WORKED unless otherwise noted.**

Wasył Kinach, P.E.  
Director of Classifications  
Bureau of Labor Law

OFFICE OF THE COMPTROLLER, CITY OF NEW YORK  
§220 PREVAILING WAGE SCHEDULE

**TABLE OF CONTENTS**

<b><u>CLASSIFICATION</u></b>	<b><u>PAGE</u></b>
ASBESTOS HANDLER .....	5
BLASTER.....	5
BOILERMAKER.....	7
BRICKLAYER.....	8
CARPENTER - BUILDING COMMERCIAL .....	9
CARPENTER - HEAVY CONSTRUCTION WORK .....	10
CARPENTER - SIDEWALK SHED, SCAFFOLD AND HOIST.....	11
CEMENT & CONCRETE WORKER .....	12
CEMENT MASON.....	13
CORE DRILLER.....	14
DERRICKPERSON AND RIGGER .....	15
DIVER.....	16
DOCKBUILDER - PILE DRIVER .....	17
DRIVER: TRUCK (TEAMSTER).....	17
ELECTRICIAN .....	20
ELECTRICIAN - ALARM TECHNICIAN .....	23
ELECTRICIAN-STREET LIGHTING WORKER.....	24
ELEVATOR CONSTRUCTOR .....	26
ELEVATOR REPAIR & MAINTENANCE .....	27
ENGINEER.....	28
ENGINEER - CITY SURVEYOR AND CONSULTANT.....	32
ENGINEER - FIELD (BUILDING CONSTRUCTION).....	33
ENGINEER - FIELD (HEAVY CONSTRUCTION).....	34
ENGINEER - FIELD (STEEL ERECTION).....	35
ENGINEER - OPERATING .....	36
FLOOR COVERER .....	44
GLAZIER.....	45
GLAZIER - REPAIR & MAINTENANCE .....	46
HEAT AND FROST INSULATOR.....	47
HOUSE WRECKER .....	48
IRON WORKER - ORNAMENTAL .....	49
IRON WORKER - STRUCTURAL .....	50
LABORER.....	50

OFFICE OF THE COMPTROLLER, CITY OF NEW YORK  
 §220 PREVAILING WAGE SCHEDULE

LANDSCAPING .....	51
MARBLE MECHANIC .....	53
MASON TENDER .....	54
MASON TENDER (INTERIOR DEMOLITION WORKER) .....	55
METALLIC LATHER .....	56
MILLWRIGHT .....	57
MOSAIC MECHANIC .....	58
PAINTER .....	59
PAINTER - METAL POLISHER .....	60
PAINTER - STRIPER .....	61
PAINTER - STRUCTURAL STEEL .....	62
PAPERHANGER .....	63
PAVER AND ROADBUILDER .....	64
PLASTERER .....	65
PLASTERER - TENDER .....	66
PLUMBER .....	67
PLUMBER (MECHANICAL EQUIPMENT AND SERVICE) .....	68
PLUMBER (RESIDENTIAL RATES FOR 1, 2 AND 3 FAMILY HOME CONSTRUCTION) .....	69
PLUMBER: PUMP & TANK .....	70
POINTER, WATERPROOFER, CAULKER, SANDBLASTER, STEAMBLASTER .....	70
ROOFER .....	71
SHEET METAL WORKER .....	72
SHEET METAL WORKER - SPECIALTY .....	73
SHIPYARD WORKER .....	74
SIGN ERECTOR .....	75
STEAMFITTER .....	76
STEAMFITTER - REFRIGERATION AND AIR CONDITIONER .....	78
STONE MASON - SETTER .....	80
TAPER .....	81
TELECOMMUNICATION WORKER .....	81
TILE FINISHER .....	83
TILE LAYER - SETTER .....	83
TIMBERPERSON .....	84
TUNNEL WORKER .....	85
WELDER .....	87

OFFICE OF THE COMPTROLLER, CITY OF NEW YORK  
\$220 PREVAILING WAGE SCHEDULE

**ASBESTOS HANDLER**

(Hazardous Material; Disturbs, removes, encapsulates, repairs, or encloses friable asbestos material)

**Asbestos Handler**

Effective Period: 7/1/2016 - 6/30/2017

Wage Rate per Hour: \$36.00

Supplemental Benefit Rate per Hour: \$16.45

**Overtime**

Time and one half the regular rate after an 8 hour day.

Time and one half the regular rate for Sunday.

Time and one half the regular hourly rate after 40 hours in any work week.

**Overtime Holidays**

Time and one half the regular rate for work on the following holiday(s).

New Year's Day

Good Friday

Memorial Day

Independence Day

Labor Day

Thanksgiving Day

Christmas Day

Easter

**Paid Holidays**

None

(Local #78 and Local #12A)

---

**BLASTER**

**Blaster**

Effective Period: 7/1/2016 - 6/30/2017

Wage Rate per Hour: \$44.93

Supplemental Benefit Rate per Hour: \$46.24

**Blaster (Hydraulic)**

Effective Period: 7/1/2016 - 6/30/2017

OFFICE OF THE COMPTROLLER, CITY OF NEW YORK  
§220 PREVAILING WAGE SCHEDULE

Wage Rate per Hour: \$45.78  
Supplemental Benefit Rate per Hour: \$46.24

**Blaster - Trac Drill Hydraulic**

Effective Period: 7/1/2016 - 6/30/2017  
Wage Rate per Hour: \$40.12  
Supplemental Benefit Rate per Hour: \$46.24

**Blaster - Wagon: Air Trac: Quarry Bar: Drillrunners**

Effective Period: 7/1/2016 - 6/30/2017  
Wage Rate per Hour: \$39.31  
Supplemental Benefit Rate per Hour: \$46.24

**Blaster - Operators of Jack Hammers**

Chippers: Spaders: Concrete Breakers: and all other pneumatic tools of like usage: Walk Behind Self Propelled Hydraulic Asphalt and Concrete Breakers: Hydro (Water) Demolition

Effective Period: 7/1/2016 - 6/30/2017  
Wage Rate per Hour: \$38.23  
Supplemental Benefit Rate per Hour: \$46.24

**Blaster - Powder Carriers**

Effective Period: 7/1/2016 - 6/30/2017  
Wage Rate per Hour: \$34.20  
Supplemental Benefit Rate per Hour: \$46.24

**Blaster - Hydraulic Trac Drill Chuck Tender**

Effective Period: 7/1/2016 - 6/30/2017  
Wage Rate per Hour: \$32.88  
Supplemental Benefit Rate per Hour: \$46.24

**Blaster - Chuck Tender & Nipper**

Effective Period: 7/1/2016 - 6/30/2017  
Wage Rate per Hour: \$32.10  
Supplemental Benefit Rate per Hour: \$46.24

**Blaster - Magazine Keepers: (Watch Person)**

Effective Period: 7/1/2016 - 6/30/2017  
Wage Rate per Hour: \$17.80  
Supplemental Benefit Rate per Hour: \$46.24

OFFICE OF THE COMPTROLLER, CITY OF NEW YORK  
\$220 PREVAILING WAGE SCHEDULE

**Overtime Description**

**Magazine Keepers:**

Time and one half for work performed in excess of forty (40) hours per week and for work performed on Saturdays, Sundays and Holidays.

**All Other Employees:**

Time and one-half for the first two hours of overtime Monday through Friday, the first ten hours, the first ten hours of work on Saturday and for Make-up Time. Double time for all hours over ten Monday through Saturday (except make-up hours) and for all hours worked on Sunday and Holidays.

**Overtime Holidays**

Double time the regular rate for work on the following holiday(s).

- New Year's Day
- Memorial Day
- Independence Day
- Labor Day
- Columbus Day
- Presidential Election Day
- Thanksgiving Day
- Christmas Day

**Paid Holidays**

None

**Shift Rates**

A single shift shall be 8 hours plus an unpaid lunch, starting at 8:00 A.M (or between 6:00 A.M. and 10:00 A.M. on weekdays). When two (2) shifts are employed, each shift shall be 8 hours plus ½ hour unpaid lunch. When three (3) shifts are employed, each shift will work seven and one-half (7 ½) hours, but will be paid for eight (8) hours, since only one-half (½) hour is allowed for mealtime. When two (2) or more shifts are employed, single time will be paid for each shift. The first 8 hours of any and all work performed Monday through Friday inclusive of any off-shift shall be at the single time rate.

(Local #29)

---

---

**BOILERMAKER**

**Boilermaker**

Effective Period: 7/1/2016 - 12/31/2016

Wage Rate per Hour: \$53.36

Supplemental Benefit Rate per Hour: \$42.33

Supplemental Note: For time and one half overtime - \$62.88 For double overtime - \$83.42

Effective Period: 1/1/2017 - 6/30/2017

Wage Rate per Hour: \$55.23

Supplemental Benefit Rate per Hour: \$42.96

Supplemental Note: For time and one half overtime - \$63.82 For double overtime - \$84.68

PUBLISH DATE: 7/1/2016

EFFECTIVE PERIOD: JULY 1, 2016 THROUGH JUNE 30, 2017

Page 7 of 87

OFFICE OF THE COMPTROLLER, CITY OF NEW YORK  
§220 PREVAILING WAGE SCHEDULE

**Overtime Description**

For Repair and Maintenance work:

Time and one half the regular rate after an 8 hour day.

Time and one half the regular rate for Saturday.

Double time the regular rate for Sunday.

For New Construction work:

Double time the regular rate after an 8 hour day.

Double time the regular time rate for Saturday.

Double time the regular rate for Sunday.

**Overtime Holidays**

Double time the regular rate for work on the following holiday(s).

New Year's Day

President's Day

Memorial Day

Independence Day

Columbus Day

Election Day

Veteran's Day

Thanksgiving Day

Christmas Day

Quadruple time the regular rate for work on the following holiday(s).

Labor Day

**Paid Holidays**

Good Friday

Day after Thanksgiving

Day before Christmas

Day before New Year's Day

**Shift Rates**

When shifts are required, the first shift shall work eight (8) hours at the regular straight-time hourly rate. The second shift shall work seven and one-half (7 ½) hours and receive eight hours at the regular straight time hourly rate plus twenty-five cents (\$0.25) per hour. The third shift shall work seven (7) hours and receive eight hours at the regular straight time hourly rate plus fifty cents (\$0.50) per hour. A thirty (30) minute lunch period shall not be considered as time worked. Work in excess of the above shall be paid overtime at the appropriate new construction work or repair work overtime wage and supplemental benefit hourly rate.

(Local #5)

---

---

**BRICKLAYER**

**Bricklayer**

Effective Period: 7/1/2016 - 6/30/2017

Wage Rate per Hour: \$52.59

OFFICE OF THE COMPTROLLER, CITY OF NEW YORK  
§220 PREVAILING WAGE SCHEDULE

Supplemental Benefit Rate per Hour: \$30.00

**Overtime**

Time and one half the regular rate after a 7 hour day.

Time and one half the regular rate for Saturday.

Double time the regular rate for Sunday.

Saturday may be used as a make-up day at straight time when a day is lost during that week to inclement weather.

**Overtime Holidays**

Double time the regular rate for work on the following holiday(s).

New Year's Day

President's Day

Memorial Day

Independence Day

Labor Day

Thanksgiving Day

Christmas Day

**Paid Holidays**

None

**Shift Rates**

Overtime rates to be paid outside the regular scheduled work day.

(Bricklayer District Council)

---

---

**CARPENTER - BUILDING COMMERCIAL**

**Building Commercial**

Effective Period: 7/1/2016 - 6/30/2017

Wage Rate per Hour: \$52.50

Supplemental Benefit Rate per Hour: \$46.28

**Overtime**

Time and one half the regular rate after an 8 hour day.

Time and one half the regular rate for Saturday.

Double time the regular rate for Sunday.

Saturday may be used as a make-up day at straight time when a day is lost during that week to inclement weather.

**Overtime Holidays**

Double time the regular rate for work on the following holiday(s).

New Year's Day

Washington's Birthday



OFFICE OF THE COMPTROLLER, CITY OF NEW YORK  
\$220 PREVAILING WAGE SCHEDULE

Memorial Day  
Independence Day  
Labor Day  
Columbus Day  
Presidential Election Day  
Thanksgiving Day  
Day after Thanksgiving  
Christmas Day

**Paid Holidays**

None

**Shift Rates**

The second shift will receive one hour at the double time rate of pay for the last hour of the shift; eight hours pay for seven hours of work, nine hours pay for eight hours of work. There must be a first shift in order to work a second shift.

(Carpenters District Council)

---

---

**CARPENTER - HEAVY CONSTRUCTION WORK**  
(Construction of Engineering Structures and Building Foundations)

**Heavy Construction Work**

Effective Period: 7/1/2016 - 6/30/2017

Wage Rate per Hour: \$51.63

Supplemental Benefit Rate per Hour: \$48.65

**Overtime**

Time and one half the regular rate after an 8 hour day.

Time and one half the regular rate for Saturday.

Double time the regular rate for Sunday.

Saturday may be used as a make-up day at straight time when a day is lost during that week to inclement weather.

**Overtime Holidays**

Double time the regular rate for work on the following holiday(s).

New Year's Day

President's Day

Memorial Day

Independence Day

Labor Day

Columbus Day

Presidential Election Day

Thanksgiving Day

Christmas Day

OFFICE OF THE COMPTROLLER, CITY OF NEW YORK  
\$220 PREVAILING WAGE SCHEDULE

**Paid Holidays**

None

**Shift Rates**

Off shift work commencing between 5:00 P.M. and 11:00 P.M. shall work eight and one half hours allowing for one half hour for lunch. The wage rate shall be 113% of the straight time hourly wage rate.

(Carpenters District Council)

---

**CARPENTER - SIDEWALK SHED, SCAFFOLD AND HOIST**

**Carpenter - Hod Hoist**

(Assisted by Mason Tender)

Effective Period: 7/1/2016 - 6/30/2017

Wage Rate per Hour: \$50.50

Supplemental Benefit Rate per Hour: \$44.80

**Overtime**

Time and one half the regular rate after an 8 hour day.

Time and one half the regular rate for Saturday.

Double time the regular rate for Sunday.

Saturday may be used as a make-up day at straight time when a day is lost during that week to inclement weather.

**Overtime Holidays**

Double time the regular rate for work on the following holiday(s).

New Year's Day

President's Day

Memorial Day

Independence Day

Labor Day

Columbus Day

Presidential Election Day

Thanksgiving Day

Day after Thanksgiving

Christmas Day

**Paid Holidays**

None

**Shift Rates**

OFFICE OF THE COMPTROLLER, CITY OF NEW YORK  
\$220 PREVAILING WAGE SCHEDULE

The second shift will receive one hour at the double time rate of pay for the last hour of the shift; eight hours pay for seven hours of work, nine hours pay for eight hours of work. There must be a first shift in order to work a second shift.

(Carpenters District Council)

---

---

## **CEMENT & CONCRETE WORKER**

### **Cement & Concrete Worker**

Effective Period: 7/1/2016 - 6/30/2017

Wage Rate per Hour: **\$42.48**

Supplemental Benefit Rate per Hour: **\$23.00**

Supplemental Note: **\$25.75 on Saturdays; \$28.50 on Sundays & Holidays**

### **Cement & Concrete Worker - (Hired after 2/6/2016)**

Effective Period: 7/1/2016 - 6/30/2017

Wage Rate per Hour: **\$32.00**

Supplemental Benefit Rate per Hour: **\$16.00**

Supplemental Note: **\$17.25 on Saturdays; \$18.50 on Sundays & Holidays**

### **Overtime Description**

Time and one half the regular rate after 7 hour day (time and one half the regular rate after an 8 hour day when working with Dockbuilders on pile cap forms and for work below street level to the top of the foundation wall, not to exceed 2 feet or 3 feet above the sidewalk-brick shelf, when working on the foundation and structure.)

### **Overtime**

Time and one half the regular rate for Saturday.

Double time the regular rate for Sunday.

### **Overtime Holidays**

Double time the regular rate for work on the following holiday(s).

New Year's Day

President's Day

Good Friday

Memorial Day

Independence Day

Labor Day

Columbus Day

Presidential Election Day

Thanksgiving Day

Christmas Day

### **Paid Holidays**

1/2 day before Christmas Day

OFFICE OF THE COMPTROLLER, CITY OF NEW YORK  
\$220 PREVAILING WAGE SCHEDULE

1/2 day before New Year's Day

### Shift Rates

On shift work extending over a twenty-four hour period, all shifts are paid at straight time.

(Cement Concrete Workers District Council)

---

---

## CEMENT MASON

### Cement Mason

Effective Period: 7/1/2016 - 6/30/2017

Wage Rate per Hour: \$40.72

Supplemental Benefit Rate per Hour: \$38.96

Supplemental Note: For time and one half overtime - \$48.21; For double overtime - \$57.46

### Overtime Description

Time and one-half the regular rate after an 8 hour day, double time the regular rate after 10 hours. Time and one-half the regular rate on Saturday, double time the regular rate after 10 hours. Double time the regular rate on Sunday.

### Overtime Holidays

Double time the regular rate for work on the following holiday(s).

New Year's Day

President's Day

Good Friday

Memorial Day

Independence Day

Labor Day

Columbus Day

Presidential Election Day

Thanksgiving Day

Christmas Day

### Paid Holidays

Any worker who reports to work on Christmas Eve or New Year's Eve pursuant to his employer's instruction shall be entitled to three (3) hours afternoon pay without working.

### Shift Rates

For an off shift day, (work at times other than the regular 7:00 A.M. to 3:30 P.M. work day) a cement mason shall be paid at the regular hourly rate plus a 25% per hour differential. Four Days a week at Ten (10)hour day.

(Local #780) (BCA)

---

OFFICE OF THE COMPTROLLER, CITY OF NEW YORK  
§220 PREVAILING WAGE SCHEDULE

---

## **CORE DRILLER**

### **Core Driller**

Effective Period: 7/1/2016 - 6/30/2017

Wage Rate per Hour: **\$37.82**

Supplemental Benefit Rate per Hour: **\$24.00**

### **Core Driller Helper**

Effective Period: 7/1/2016 - 6/30/2017

Wage Rate per Hour: **\$30.17**

Supplemental Benefit Rate per Hour: **\$24.00**

### **Core Driller Helper(Third year in the industry)**

Effective Period: 7/1/2016 - 6/30/2017

Wage Rate per Hour: **\$27.15**

Supplemental Benefit Rate per Hour: **\$24.00**

### **Core Driller Helper (Second year in the industry)**

Effective Period: 7/1/2016 - 6/30/2017

Wage Rate per Hour: **\$24.14**

Supplemental Benefit Rate per Hour: **\$24.00**

### **Core Driller Helper (First year in the industry)**

Effective Period: 7/1/2016 - 6/30/2017

Wage Rate per Hour: **\$21.12**

Supplemental Benefit Rate per Hour: **\$24.00**

### **Overtime Description**

Time and one half the regular rate for work on a holiday plus Holiday pay when worked.

### **Overtime**

Time and one half the regular rate after an 8 hour day.

Time and one half the regular rate for Saturday.

Double time the regular rate for Sunday.

Time and one half the regular rate for work on the following holiday(s).

### **Paid Holidays**

New Year's Day

Memorial Day

Independence Day

Labor Day

OFFICE OF THE COMPTROLLER, CITY OF NEW YORK  
§220 PREVAILING WAGE SCHEDULE

Thanksgiving Day  
Christmas Day

### Shift Rates

The shift day shall be the continuous eight and one-half (8½) hours from 6:00 A.M. to 2:30 P.M. and from 2:30 P.M. to 11:00 P.M., including one-half (½) hour of employees regular rate of pay for lunch. When two (2) or more shifts are employed, single time shall be paid for each shift, but those employees employed on a shift other than from 8:00 A.M. to 5:00 P.M. shall, in addition, receive seventy-five cents (\$0.75) per hour differential for each hour worked. When three (3) shifts are needed, each shift shall work seven and one-half (7 ½) hours paid for eight (8) hours of labor and be permitted one-half (½) hour for mealtime.

(Carpenters District Council)

---

---

## DERRICKPERSON AND RIGGER

### Derrick Person & Rigger

Effective Period: 7/1/2016 - 6/30/2017

Wage Rate per Hour: \$45.48

Supplemental Benefit Rate per Hour: \$50.00

Supplemental Note: The above supplemental rate applies for work performed in Manhattan, Bronx, Brooklyn and Queens. \$51.42 - For work performed in Staten Island.

### Overtime Description

The first two hours of overtime on weekdays and the first seven hours of work on Saturdays are paid at time and one half for wages and supplemental benefits. All additional overtimes is paid at double time for wages and supplemental benefits. Deduct \$1.42 from the Staten Island hourly benefits rate before computing overtime.

### Overtime

Double time the regular rate for Sunday.

### Overtime Holidays

Double time the regular rate for work on the following holiday(s).

New Year's Day  
Washington's Birthday  
Good Friday  
Memorial Day  
Independence Day  
Labor Day  
Thanksgiving Day  
Christmas Day

### Paid Holidays

1/2 day on Christmas Eve if work is performed in the A.M.

(Local #197)

OFFICE OF THE COMPTROLLER, CITY OF NEW YORK  
§220 PREVAILING WAGE SCHEDULE

---

---

**DIVER**

**Diver (Marine)**

Effective Period: 7/1/2016 - 6/30/2017

Wage Rate per Hour: **\$65.38**

Supplemental Benefit Rate per Hour: **\$48.65**

**Diver Tender (Marine)**

Effective Period: 7/1/2016 - 6/30/2017

Wage Rate per Hour: **\$46.44**

Supplemental Benefit Rate per Hour: **\$48.65**

**Overtime**

Time and one half the regular rate after an 8 hour day.

Time and one half the regular rate for Saturday.

Double time the regular rate for Sunday.

Saturday may be used as a make-up day at straight time when a day is lost during that week to inclement weather.

**Overtime Holidays**

Double time the regular rate for work on the following holiday(s).

New Year's Day

President's Day

Memorial Day

Independence Day

Labor Day

Columbus Day

Presidential Election Day

Thanksgiving Day

Christmas Day

**Paid Holidays**

None

**Shift Rates**

When three shifts are utilized each shift shall work seven and one half-hours (7 1/2 hours) and paid for 8 hours, allowing for one half hour for lunch.

(Carpenters District Council)

---

---

## **DOCKBUILDER - PILE DRIVER**

### **Dockbuilder - Pile Driver**

Effective Period: 7/1/2016 - 6/30/2017

Wage Rate per Hour: **\$51.63**

Supplemental Benefit Rate per Hour: **\$48.65**

### **Overtime**

Time and one half the regular rate after an 8 hour day.

Time and one half the regular rate for Saturday.

Double time the regular rate for Sunday.

Saturday may be used as a make-up day at straight time when a day is lost during that week to inclement weather.

### **Overtime Holidays**

Double time the regular rate for work on the following holiday(s).

New Year's Day

President's Day

Memorial Day

Independence Day

Labor Day

Columbus Day

Presidential Election Day

Thanksgiving Day

Christmas Day

### **Paid Holidays**

None

### **Shift Rates**

Off shift work commencing between 5:00 P.M. and 11:00 P.M. shall work eight and one half hours allowing for one half hour for lunch. The wage rate shall be 113% of the straight time hourly wage rate.

(Carpenters District Council)

---

## **DRIVER: TRUCK (TEAMSTER)**

### **Driver - Dump Truck**

Effective Period: 7/1/2016 - 6/30/2017

Wage Rate per Hour: **\$40.15**

Supplemental Benefit Rate per Hour: **\$43.39**

Supplemental Note: Over 40 hours worked: at time and one half rate - **\$18.44**; at double time rate - **\$24.58**



OFFICE OF THE COMPTROLLER, CITY OF NEW YORK  
§220 PREVAILING WAGE SCHEDULE

**Driver - Tractor Trailer**

Effective Period: 7/1/2016 - 6/30/2017

Wage Rate per Hour: \$41.46

Supplemental Benefit Rate per Hour: \$43.65

Supplemental Note: Over 40 hours worked: at time and one half rate - \$16.65; at double time rate - \$22.20

**Driver - Euclid & Turnapull Operator**

Effective Period: 7/1/2016 - 6/30/2017

Wage Rate per Hour: \$42.03

Supplemental Benefit Rate per Hour: \$43.65

Supplemental Note: Over 40 hours worked: at time and one half rate - \$16.65; at double time rate - \$22.20

**Overtime Description**

For Paid Holidays: Holiday pay for all holidays shall be prorated based two hours per day for each day worked in the holiday week, not to exceed 8 hours of holiday pay. For Thanksgiving week, the prorated share shall be 5 1/3 hours of holiday pay for each day worked in Thanksgiving week.

**Overtime**

Time and one half the regular rate after an 8 hour day.

Time and one half the regular rate for Saturday.

Double time the regular rate for Sunday.

**Overtime Holidays**

Double time the regular rate for work on the following holiday(s).

New Year's Day

President's Day

Memorial Day

Independence Day

Labor Day

Columbus Day

Veteran's Day

Thanksgiving Day

Day after Thanksgiving

Christmas Day

**Paid Holidays**

New Year's Day

President's Day

Memorial Day

Independence Day

Labor Day

Columbus Day

Veteran's Day

Thanksgiving Day

Day after Thanksgiving

Christmas Day

**Shift Rates**

Off single shift work commencing between 6:00 P.M. and 5:00 A.M. shall work eight and one half hours allowing for one half hour for lunch and receive 9 hours pay for 8 hours of work.

OFFICE OF THE COMPTROLLER, CITY OF NEW YORK  
\$220 PREVAILING WAGE SCHEDULE

---

**Driver Redi-Mix (Sand & Gravel)**

Effective Period: 7/1/2016 - 6/30/2017

Wage Rate per Hour: \$36.30

Supplemental Benefit Rate per Hour: \$40.02

Supplemental Note: Over 40 hours worked: time and one half rate \$13.90, double time rate \$18.53

**Overtime Description**

For Paid Holidays: Employees working two (2) days in the calendar week in which the holiday falls are to paid for these holidays, provided they shape each remaining workday during that calendar week.

**Overtime**

Time and one half the regular rate after an 8 hour day.

Time and one half the regular rate for Saturday.

Double time the regular rate for Sunday.

**Overtime Holidays**

Double time the regular rate for work on the following holiday(s).

President's Day

Columbus Day

Veteran's Day

Triple time the regular rate for work on the following holiday(s).

New Year's Day

Memorial Day

Independence Day

Labor Day

Thanksgiving Day

Christmas Day

**Paid Holidays**

New Year's Day

President's Day

Memorial Day

Independence Day

Labor Day

Columbus Day

Election Day

Thanksgiving Day

Christmas Day

(Local #282)

---

---

OFFICE OF THE COMPTROLLER, CITY OF NEW YORK  
\$220 PREVAILING WAGE SCHEDULE

**ELECTRICIAN**

(Including all low voltage cabling carrying data; video; and voice in combination with data and or video.)

**Electrician "A" (Regular Day)**

Effective Period: 7/1/2016 - 5/10/2017

Wage Rate per Hour: **\$54.00**

Supplemental Benefit Rate per Hour: **\$51.86**

Effective Period: 5/11/2017 - 6/30/2017

Wage Rate per Hour: **\$56.00**

Supplemental Benefit Rate per Hour: **\$54.35**

**Electrician "A" (Regular Day Overtime)**

Effective Period: 7/1/2016 - 5/10/2017

Wage Rate per Hour: **\$81.00**

Supplemental Benefit Rate per Hour: **\$55.24**

Effective Period: 5/11/2017 - 6/30/2017

Wage Rate per Hour: **\$84.00**

Supplemental Benefit Rate per Hour: **\$57.86**

**Electrician "A" (Day Shift)**

Effective Period: 7/1/2016 - 5/10/2017

Wage Rate per Hour: **\$54.00**

Supplemental Benefit Rate per Hour: **\$51.86**

Effective Period: 5/11/2017 - 6/30/2017

Wage Rate per Hour: **\$56.00**

Supplemental Benefit Rate per Hour: **\$54.35**

**Electrician "A" (Day Shift Overtime After 8 hours)**

Effective Period: 7/1/2016 - 5/10/2017

Wage Rate per Hour: **\$81.00**

Supplemental Benefit Rate per Hour: **\$55.24**

Effective Period: 5/11/2017 - 6/30/2017

Wage Rate per Hour: **\$84.00**

Supplemental Benefit Rate per Hour: **\$57.86**

**Electrician "A" (Swing Shift)**

Effective Period: 7/1/2016 - 5/10/2017

OFFICE OF THE COMPTROLLER, CITY OF NEW YORK  
\$220 PREVAILING WAGE SCHEDULE

Wage Rate per Hour: \$63.36  
Supplemental Benefit Rate per Hour: \$59.01

Effective Period: 5/11/2017 - 6/30/2017  
Wage Rate per Hour: \$65.71  
Supplemental Benefit Rate per Hour: \$61.94

**Electrician "A" (Swing Shift Overtime After 7.5 hours)**

Effective Period: 7/1/2016 - 5/10/2017  
Wage Rate per Hour: \$95.04  
Supplemental Benefit Rate per Hour: \$62.98

Effective Period: 5/11/2017 - 6/30/2017  
Wage Rate per Hour: \$98.57  
Supplemental Benefit Rate per Hour: \$66.05

**Electrician "A" (Graveyard Shift)**

Effective Period: 7/1/2016 - 5/10/2017  
Wage Rate per Hour: \$70.97  
Supplemental Benefit Rate per Hour: \$65.05

Effective Period: 5/11/2017 - 6/30/2017  
Wage Rate per Hour: \$73.60  
Supplemental Benefit Rate per Hour: \$68.33

**Electrician "A" (Graveyard Shift Overtime After 7 hours)**

Effective Period: 7/1/2016 - 5/10/2017  
Wage Rate per Hour: \$106.46  
Supplemental Benefit Rate per Hour: \$69.50

Effective Period: 5/11/2017 - 6/30/2017  
Wage Rate per Hour: \$110.40  
Supplemental Benefit Rate per Hour: \$72.95

**Overtime**

Time and one half the regular rate after a 7 hour day.  
Time and one half the regular rate for Saturday.  
Time and one half the regular rate for Sunday.

**Overtime Holidays**

Time and one half the regular rate for work on a holiday.  
New Year's Day  
Martin Luther King Jr. Day  
President's Day  
Memorial Day  
Independence Day  
Labor Day

OFFICE OF THE COMPTROLLER, CITY OF NEW YORK  
§220 PREVAILING WAGE SCHEDULE

Columbus Day  
Veteran's Day  
Thanksgiving Day  
Day after Thanksgiving  
Christmas Day

**Paid Holidays**

None

**Shift Rates**

When so elected by the Employer, one or more shifts of at least five days duration may be scheduled as follows:  
Day Shift: 8:00 am to 4:30 pm, Swing Shift 4:30 pm to 12:30 am, Graveyard Shift: 12:30 am to 8:00 am.

For multiple shifts of temporary light and/or power, the temporary light and/or power employee shall be paid for 8 hours at the straight time rate. For three or less workers performing 8 hours temporary light and/or power the supplemental benefit rate is \$25.14 and effective 5/11/17 \$26.67.

---

**Electrician "M" (First 8 hours)**

"M" rated work shall be defined as jobbing: electrical work of limited duration and scope, also consisting of repairs and/or replacement of electrical and tele-data equipment. Includes all work necessary to retrofit, service, maintain and repair all kinds of lighting fixtures and local lighting controls and washing and cleaning of foregoing fixtures.

Effective Period: 7/1/2016 - 5/10/2017

Wage Rate per Hour: \$28.00

Supplemental Benefit Rate per Hour: \$21.85

First and Second Year "M" Wage Rate Per Hour: \$23.50

First and Second Year "M" Supplemental Rate: \$19.54

Effective Period: 5/11/2017 - 6/30/2017

Wage Rate per Hour: \$28.50

Supplemental Benefit Rate per Hour: \$22.10

First and Second Year "M" Wage Rate Per Hour: \$24.00

First and Second Year "M" Supplemental Rate: \$19.80

**Electrician "M" (Overtime After First 8 hours)**

"M" rated work shall be defined as jobbing: electrical work of limited duration and scope, also consisting of repairs and/or replacement of electrical and tele-data equipment. Includes all work necessary to retrofit, service, maintain and repair all kinds of lighting fixtures and local lighting controls and washing and cleaning of foregoing fixtures.

Effective Period: 7/1/2016 - 5/10/2017

Wage Rate per Hour: \$42.00

Supplemental Benefit Rate per Hour: \$23.60

First and Second Year "M" Wage Rate Per Hour: \$35.25

First and Second Year "M" Supplemental Rate: \$21.01

OFFICE OF THE COMPTROLLER, CITY OF NEW YORK  
§220 PREVAILING WAGE SCHEDULE

Effective Period: 5/11/2017 - 6/30/2017

Wage Rate per Hour: \$42.75

Supplemental Benefit Rate per Hour: \$23.89

First and Second Year "M" Wage Rate Per Hour: \$36.00

First and Second Year "M" Supplemental Rate: \$21.30

**Overtime**

Time and one half the regular rate after an 8 hour day.

Time and one half the regular rate for Saturday.

Time and one half the regular rate for Sunday.

**Overtime Holidays**

Time and one half the regular rate for work on the following holiday(s).

New Year's Day

Martin Luther King Jr. Day

President's Day

Memorial Day

Independence Day

Labor Day

Columbus Day

Veteran's Day

Thanksgiving Day

Day after Thanksgiving

Christmas Day

**Paid Holidays**

None

(Local #3)

---

---

**ELECTRICIAN - ALARM TECHNICIAN**

(Scope of Work - Inspect, test, repair, and replace defective, malfunctioning, or broken devices, components and controls of Fire, Burglar and Security Systems)

**Alarm Technician**

Effective Period: 7/1/2016 - 3/9/2017

Wage Rate per Hour: \$32.00

Supplemental Benefit Rate per Hour: \$15.47

Supplemental Note: \$13.97 only after 8 hours worked in a day

Effective Period: 3/10/2017 - 6/30/2017

Wage Rate per Hour: \$32.40

Supplemental Benefit Rate per Hour: \$16.10

OFFICE OF THE COMPTROLLER, CITY OF NEW YORK  
\$220 PREVAILING WAGE SCHEDULE

Supplemental Note: \$14.60 only after 8 hours worked in a day

**Overtime Description**

Time and one half the regular rate for work on the following holidays: Columbus Day, Veterans Day, Day after Thanksgiving.

Double time the regular rate for work on the following holidays: New Year's day, Martin Luther King Jr. Day, President's Day, Memorial Day, Independence Day, Labor Day, Thanksgiving Day, Christmas Day.

**Overtime**

Time and one half the regular rate after an 8 hour day.

Time and one half the regular rate for Saturday.

Double time the regular rate for Sunday.

**Paid Holidays**

- New Year's Day
- Martin Luther King Jr. Day
- President's Day
- Memorial Day
- Independence Day
- Labor Day
- Columbus Day
- Veteran's Day
- Thanksgiving Day
- Day after Thanksgiving
- Christmas Day

**Shift Rates**

Night Differential is based upon a ten percent (10%) differential between the hours of 4:00 P.M. and 12:30 A.M. and a fifteen percent (15%) differential for the hours 12:00 A.M. to 8:00 A.M.

**Vacation**

- At least 1 year of employment.....ten (10) days
- 5 years or more of employment.....fifteen (15) days
- 10 years of employment.....twenty (20) days
- Plus one Personal Day per year

**Sick Days:**

One day per Year. Up to 4 vacation days may be used as sick days.

(Local #3)

---

---

**ELECTRICIAN-STREET LIGHTING WORKER**

**Electrician - Electro Pole Electrician**

Effective Period: 7/1/2016 - 5/17/2017

Wage Rate per Hour: \$54.00

Supplemental Benefit Rate per Hour: \$53.69

OFFICE OF THE COMPTROLLER, CITY OF NEW YORK  
\$220 PREVAILING WAGE SCHEDULE

Effective Period: 5/18/2017 - 6/30/2017  
Wage Rate per Hour: \$56.00  
Supplemental Benefit Rate per Hour: \$56.26

**Electrician - Electro Pole Foundation Installer**

Effective Period: 7/1/2016 - 5/17/2017  
Wage Rate per Hour: \$40.93  
Supplemental Benefit Rate per Hour: \$40.12

Effective Period: 5/18/2017 - 6/30/2017  
Wage Rate per Hour: \$41.54  
Supplemental Benefit Rate per Hour: \$41.02

**Electrician - Electro Pole Maintainer**

Effective Period: 7/1/2016 - 5/17/2017  
Wage Rate per Hour: \$35.05  
Supplemental Benefit Rate per Hour: \$36.11

Effective Period: 5/18/2017 - 6/30/2017  
Wage Rate per Hour: \$35.58  
Supplemental Benefit Rate per Hour: \$36.89

**Overtime Description**

Electrician - Electro Pole Electrician: Time and one half the regular rate after a 7 hour day and after 5 consecutive days worked per week.

Electrician - Electro Pole Foundation Installer: Time and one half the regular rate after 8 hours within a 24 hour period and Saturday and Sunday.

Electrician - Electro Pole Maintainer: Time and one half the regular rate after a 7 hour day and after 5 consecutive days worked per week. Saturdays and Sundays may be used as a make-up day at straight time when a day is lost during the week to inclement weather.

**Overtime Holidays**

Time and one half the regular rate for work on the following holiday(s).

New Year's Day  
Martin Luther King Jr. Day  
President's Day  
Memorial Day  
Independence Day  
Labor Day  
Columbus Day  
Veteran's Day  
Thanksgiving Day  
Day after Thanksgiving  
Christmas Day

**Paid Holidays**

None



OFFICE OF THE COMPTROLLER, CITY OF NEW YORK  
§220 PREVAILING WAGE SCHEDULE

(Local #3)

---

---

## **ELEVATOR CONSTRUCTOR**

### **Elevator Constructor**

Effective Period: 7/1/2016 - 3/16/2017

Wage Rate per Hour: **\$60.96**

Supplemental Benefit Rate per Hour: **\$32.65**

Effective Period: 3/17/2017 - 6/30/2017

Wage Rate per Hour: **\$62.64**

Supplemental Benefit Rate per Hour: **\$34.25**

### **Overtime Description**

For New Construction: work performed after 7 or 8 hour day, Saturday, Sunday or between 4:30pm and 7:00am shall be paid at double time rate.

Existing buildings: work performed after an 8 hour day, Saturday, Sunday or between 5:30pm and 7:00 am shall be paid time and one half.

### **Overtime**

Double time the regular rate for work on the following holiday(s).

### **Paid Holidays**

New Year's Day  
President's Day  
Good Friday  
Memorial Day  
Independence Day  
Labor Day  
Columbus Day  
Veteran's Day  
Thanksgiving Day  
Day after Thanksgiving  
Christmas Day

### **Vacation**

Employer contributes 8% of regular basic hourly rate as vacation pay for employees with more than 15 years of service, and 6% for employees with 5 to 15 years of service, and 4% for employees with less than 5 years of service.

(Local #1)

---

---

OFFICE OF THE COMPTROLLER, CITY OF NEW YORK  
§220 PREVAILING WAGE SCHEDULE

## ELEVATOR REPAIR & MAINTENANCE

### Elevator Service/Modernization Mechanic

Effective Period: 7/1/2016 - 3/16/2017

Wage Rate per Hour: \$47.91

Supplemental Benefit Rate per Hour: \$32.51

Effective Period: 3/17/2017 - 6/30/2017

Wage Rate per Hour: \$49.14

Supplemental Benefit Rate per Hour: \$34.11

### Overtime Description

For Scheduled Service Work: Double time - work scheduled in advance by two or more workers performed on Sundays, Holidays, and between midnight and 7:00am.

### Overtime

Time and one half the regular rate after an 8 hour day.

Time and one half the regular rate for Saturday.

Time and one half the regular rate for Sunday.

Time and one half the regular rate for work on a holiday plus the day's pay.

### Paid Holidays

New Year's Day

President's Day

Good Friday

Memorial Day

Independence Day

Labor Day

Columbus Day

Veteran's Day

Thanksgiving Day

Day after Thanksgiving

Christmas Day

### Shift Rates

Afternoon shift - regularly hourly rate plus a (15%) fifteen percent differential. Graveyard shift - time and one half the regular rate.

### Vacation

Employer contributes 8% of regular basic hourly rate as vacation pay for employees with more than 15 years of service, and 6% for employees with 5 to 15 years of service, and 4% for employees with less than 5 years of service.

(Local #1)

---

---

OFFICE OF THE COMPTROLLER, CITY OF NEW YORK  
§220 PREVAILING WAGE SCHEDULE

## **ENGINEER**

### **Engineer - Heavy Construction Operating Engineer I**

Cherry pickers 20 tons and over and Loaders (rubber tired and/or tractor type with a manufacturer's minimum rated capacity of six cubic yards and over).

Effective Period: 7/1/2016 - 6/30/2017

Wage Rate per Hour: **\$65.94**

Supplemental Benefit Rate per Hour: **\$35.41**

Supplemental Note: **\$63.67** on overtime

Shift Wage Rate: **\$105.50**

### **Engineer - Heavy Construction Operating Engineer II**

Backhoes, Basin Machines, Groover, Mechanical Sweepers, Bobcat, Boom Truck, Barrier Transport (Barrier Mover) & machines of similar nature, Operation of Churn Drills and machines of a similar nature, Stetco Silent Hoist and machines of similar nature, Vac-A-alls, Meyers Machines, John Beam and machines of a similar nature, Ross Carriers and Travel Lifts and machines of a similar nature, Bulldozers, Scrapers and Turn-a-Pulls: Tugger Hoists (Used exclusively for handling excavated material); Tractors with attachments, Hyster and Roustabout Cranes, Cherry pickers, Austin Western, Grove and machines of a similar nature, Scoopmobiles, Monorails, Conveyors, Trenchers: Loaders-Rubber Tired and Tractor: Barber Greene and Elmco Loaders and Elmco Backhoes; Mighty Midget and similar breakers and Tampers, Curb and Gutter Pavers and Motor Patrol, Motor Graders and all machines of a similar nature. Locomotives 10 Tons or under. Mini-Max, Break-Tech and machines of a similar nature; Milling machines, robotic and demolition machines and machines of a similar nature, shot blaster, skid steer machines and machines of a similar nature including bobcat, pile rig rubber-tired excavator (37,000 lbs. and under), 2 man auger.

Effective Period: 7/1/2016 - 6/30/2017

Wage Rate per Hour: **\$63.98**

Supplemental Benefit Rate per Hour: **\$35.41**

Supplemental Note: **\$63.67** on overtime

Shift Wage Rate: **\$102.37**

### **Engineer - Heavy Construction Operating Engineer III**

Minor Equipment such as Tractors, Post Hole Diggers, Ditch Witch (Walk Behind), Road Finishing Machines, Rollers five tons and under, Tugger Hoists, Dual Purpose Trucks, Fork Lifts, and Dempsey Dumpers, Fireperson.

Effective Period: 7/1/2016 - 6/30/2017

Wage Rate per Hour: **\$60.69**

Supplemental Benefit Rate per Hour: **\$35.41**

Supplemental Note: **\$63.67** on overtime

Shift Wage Rate: **\$97.10**

### **Engineer - Heavy Construction Maintenance Engineer I**

Installing, Repairing, Maintaining, Dismantling and Manning of all equipment including Steel Cutting, Bending and Heat Sealing Machines, Mechanical Heaters, Grout Pumps, Bentonite Pumps & Plants, Screening Machines, Fusion Coupling Machines, Tunnel Boring Machines Moles and Machines of a similar nature, Power Packs, Mechanical Hydraulic Jacks; all drill rigs including but not limited to Churn, Rotary Caisson, Raised Bore & Drills

OFFICE OF THE COMPTROLLER, CITY OF NEW YORK  
\$220 PREVAILING WAGE SCHEDULE

of a similar nature; Personnel, Inspection & Safety Boats or any boats used to perform functions of same, Mine Hoists, Whirlies, all Climbing Cranes, all Tower Cranes, including but not limited to Truck Mounted and Crawler Type and machines of similar nature; Maintaining Hydraulic Drills and machines of a similar nature; Well Point System-Installation and dismantling; Burning, Welding, all Pumps regardless of size and/or motor power, except River Cofferdam Pumps and Wells Point Pumps; Motorized Buggies (three or more); equipment used in the cleaning and televising of sewers, but not limited to jet-rodder/vacuum truck, vacall/vactor, closed circuit television inspection equipment; high powered water pumps, jet pumps; screed machines and concrete finishing machines of a similar nature; vermeers.

Effective Period: 7/1/2016 - 6/30/2017

Wage Rate per Hour: \$63.68

Supplemental Benefit Rate per Hour: \$35.41

Supplemental Note: \$63.67 on overtime

Shift Wage Rate: \$101.89

**Engineer - Heavy Construction Maintenance Engineer II**

On Base Mounted Tower Cranes

Effective Period: 7/1/2016 - 6/30/2017

Wage Rate per Hour: \$83.66

Supplemental Benefit Rate per Hour: \$35.41

Supplemental Note: \$63.67 on overtime

Shift Wage Rate: \$133.86

**Engineer - Heavy Construction Maintenance Engineer III**

On Generators, Light Towers

Effective Period: 7/1/2016 - 6/30/2017

Wage Rate per Hour: \$42.01

Supplemental Benefit Rate per Hour: \$35.41

Supplemental Note: \$63.67 on overtime

Shift Wage Rate: \$67.22

**Engineer - Heavy Construction Maintenance Engineer IV**

On Pumps and Mixers including mud sucking

Effective Period: 7/1/2016 - 6/30/2017

Wage Rate per Hour: \$43.11

Supplemental Benefit Rate per Hour: \$35.41

Supplemental Note: \$63.67 on overtime

Shift Wage Rate: \$68.98

**Engineer - Heavy Construction Oilers I**

Gradalls, Cold Planer Grader, Concrete Pumps, Driving Truck Cranes, Driving and Operating Fuel and Grease Trucks.

Effective Period: 7/1/2016 - 6/30/2017

OFFICE OF THE COMPTROLLER, CITY OF NEW YORK  
\$220 PREVAILING WAGE SCHEDULE

Wage Rate per Hour: \$57.42  
Supplemental Benefit Rate per Hour: \$35.41  
Supplemental Note: \$63.67 on overtime  
Shift Wage Rate: \$91.87

**Engineer - Heavy Construction Oilers II**

All gasoline, electric, diesel or air operated Shovels, Draglines, Backhoes, Keystones, Pavers, Guniting Machines, Battery of Compressors, Crawler Cranes, two-person Trenching Machines.

Effective Period: 7/1/2016 - 6/30/2017  
Wage Rate per Hour: \$39.70  
Supplemental Benefit Rate per Hour: \$35.41  
Supplemental Note: \$63.67 on overtime  
Shift Wage Rate: \$63.52

**Engineer - Steel Erection Maintenance Engineers**

Derrick, Travelers, Tower, Crawler Tower and Climbing Cranes

Effective Period: 7/1/2016 - 6/30/2017  
Wage Rate per Hour: \$61.13  
Supplemental Benefit Rate per Hour: \$35.41  
Supplemental Note: \$63.67 on overtime  
Shift Wage Rate: \$97.81

**Engineer - Steel Erection Oiler I**

On a Truck Crane

Effective Period: 7/1/2016 - 6/30/2017  
Wage Rate per Hour: \$57.21  
Supplemental Benefit Rate per Hour: \$35.41  
Supplemental Note: \$63.67 on overtime  
Shift Wage Rate: \$91.54

**Engineer - Steel Erection Oiler II**

On a Crawler Crane

Effective Period: 7/1/2016 - 6/30/2017  
Wage Rate per Hour: \$43.54  
Supplemental Benefit Rate per Hour: \$35.41  
Supplemental Note: \$63.67 on overtime  
Shift Wage Rate: \$69.66

**Overtime Description**

On jobs of more than one shift, if the next shift employee fails to report for work through any cause over which the employer has no control, the employee on duty who works the next shift continues to work at the single time rate.

OFFICE OF THE COMPTROLLER, CITY OF NEW YORK  
§220 PREVAILING WAGE SCHEDULE

**Overtime**

Double time the regular rate after an 8 hour day.  
Double time the regular time rate for Saturday.  
Double time the regular rate for Sunday,  
Double time the regular rate for work on the following holiday(s).

**Paid Holidays**

New Year's Day  
Lincoln's Birthday  
President's Day  
Memorial Day  
Independence Day  
Labor Day  
Columbus Day  
Veteran's Day  
Thanksgiving Day  
Day after Thanksgiving  
Christmas Day

Employees must work at least one day in the payroll week in which the holiday occurs to receive the paid holiday

---

**Engineer - Building Work Maintenance Engineers I**

Installing, repairing, maintaining, dismantling (of all equipment including: Steel Cutting and Bending Machines, Mechanical Heaters, Mine Hoists, Climbing Cranes, Tower Cranes, Linden Peine, Lorain, Liebherr, Mannes, or machines of a similar nature, Well Point Systems, Deep Well Pumps, Concrete Mixers with loading Device, Concrete Plants, Motor Generators when used for temporary power and lights), skid steer machines of a similar nature including bobcat.

Effective Period: 7/1/2016 - 6/30/2017

Wage Rate per Hour: \$58.30

Supplemental Benefit Rate per Hour: \$35.41

Supplemental Note: \$63.67 on overtime

**Engineer - Building Work Maintenance Engineers II**

On Pumps, Generators, Mixers and Heaters

Effective Period: 7/1/2016 - 6/30/2017

Wage Rate per Hour: \$45.28

Supplemental Benefit Rate per Hour: \$35.41

Supplemental Note: \$63.67 on overtime

**Engineer - Building Work Oilers I**

All gasoline, electric, diesel or air operated Gradealls: Concrete Pumps, Overhead Cranes in Power Houses: Their duties shall be to assist the Engineer in oiling, greasing and repairing of all machines; Driving Truck Cranes: Driving and Operating Fuel and Grease Trucks, Cherrypickers (hydraulic cranes) over 70,000 GVW, and machines of a similar nature.

OFFICE OF THE COMPTROLLER, CITY OF NEW YORK  
§220 PREVAILING WAGE SCHEDULE

Effective Period: 7/1/2016 - 6/30/2017  
Wage Rate per Hour: \$55.42  
Supplemental Benefit Rate per Hour: \$35.41  
Supplemental Note: \$63.67 on overtime

**Engineer - Building Work Oilers II**

Oilers on Crawler Cranes, Backhoes, Trenching Machines, Gunite Machines, Compressors (three or more in Battery).

Effective Period: 7/1/2016 - 6/30/2017  
Wage Rate per Hour: \$41.16  
Supplemental Benefit Rate per Hour: \$35.41  
Supplemental Note: \$63.67 on overtime

**Overtime Description**

On jobs of more than one shift, if an Employee fails to report for work through any cause over which the Employer has no control, the Employee on duty will continue to work at the rate of single time.

**Overtime**

Double time the regular rate after an 8 hour day.  
Double time the regular time rate for Saturday.  
Double time the regular rate for Sunday.  
Double time the regular rate for work on the following holiday(s).

**Paid Holidays**

New Year's Day  
Lincoln's Birthday  
President's Day  
Memorial Day  
Independence Day  
Labor Day  
Columbus Day  
Veteran's Day  
Thanksgiving Day  
Christmas Day

Employees must work at least one day in the payroll week in which the holiday occurs to receive the paid holiday

**Shift Rates**

Off Shift: double time the regular hourly rate.

(Local #15)

---

---

**ENGINEER - CITY SURVEYOR AND CONSULTANT**

OFFICE OF THE COMPTROLLER, CITY OF NEW YORK  
§220 PREVAILING WAGE SCHEDULE

**Party Chief**

Effective Period: 7/1/2016 - 6/30/2017

Wage Rate per Hour: \$38.18

Supplemental Benefit Rate per Hour: \$20.15

Supplemental Note: Overtime Benefit Rate - \$27.65 per hour (time & one half) \$35.15 per hour (double time).

**Instrument Person**

Effective Period: 7/1/2016 - 6/30/2017

Wage Rate per Hour: \$31.47

Supplemental Benefit Rate per Hour: \$20.15

Supplemental Note: Overtime Benefit Rate - \$27.65 per hour (time & one half) \$35.15 per hour (double time).

**Rodperson**

Effective Period: 7/1/2016 - 6/30/2017

Wage Rate per Hour: \$27.24

Supplemental Benefit Rate per Hour: \$20.15

Supplemental Note: Overtime Benefit Rate - \$27.65 per hour (time & one half) \$35.15 per hour (double time).

**Overtime Description**

Time and one half the regular rate after an 8 hour day, Time and one half the regular rate for Saturday for the first eight hours worked, Double time the regular time rate for Saturday for work performed in excess of eight hours, Double time the regular rate for Sunday and Double time the regular rate for work on a holiday.

**Paid Holidays**

New Year's Day  
Lincoln's Birthday  
President's Day  
Memorial Day  
Independence Day  
Labor Day  
Columbus Day  
Veteran's Day  
Thanksgiving Day  
Day after Thanksgiving  
Christmas Day

Employees must work at least one day in the payroll week in which the holiday occurs to receive the paid holiday

(Operating Engineer Local #15-D)

---

**ENGINEER - FIELD (BUILDING CONSTRUCTION)**  
(Construction of Building Projects, Concrete Superstructures, etc.)



OFFICE OF THE COMPTROLLER, CITY OF NEW YORK  
\$220 PREVAILING WAGE SCHEDULE

**Field Engineer - BC Party Chief**

Effective Period: 7/1/2016 - 6/30/2017

Wage Rate per Hour: \$60.10

Supplemental Benefit Rate per Hour: \$32.15

Supplemental Note: Overtime Benefit Rate - \$44.90 per hour (time & one half) \$57.65 per hour (double time).

**Field Engineer - BC Instrument Person**

Effective Period: 7/1/2016 - 6/30/2017

Wage Rate per Hour: \$46.69

Supplemental Benefit Rate per Hour: \$32.15

Supplemental Note: Overtime Benefit Rate - \$44.90 per hour (time & one half) \$57.65 per hour (double time).

**Field Engineer - BC Rodperson**

Effective Period: 7/1/2016 - 6/30/2017

Wage Rate per Hour: \$30.20

Supplemental Benefit Rate per Hour: \$32.15

Supplemental Note: Overtime Benefit Rate - \$44.90 per hour (time & one half) \$57.65 per hour (double time).

**Overtime Description**

Time and one half the regular rate after a 7 hour work and time and one half the regular rate for Saturday for the first seven hours worked, Double time the regular time rate for Saturday for work performed in excess of seven hours, Double time the regular rate for Sunday and Double time the regular rate for work on a holiday.

**Paid Holidays**

New Year's Day

President's Day

Good Friday

Memorial Day

Independence Day

Labor Day

Columbus Day

Veteran's Day

Thanksgiving Day

Christmas Day

Employees must work at least one day in the payroll week in which the holiday occurs to receive the paid holiday

(Operating Engineer Local #15-D)

---

---

**ENGINEER - FIELD (HEAVY CONSTRUCTION)**

(Construction of Roads, Tunnels, Bridges, Sewers, Building Foundations, Engineering Structures etc.)

OFFICE OF THE COMPTROLLER, CITY OF NEW YORK  
§220 PREVAILING WAGE SCHEDULE

**Field Engineer - HC Party Chief**

Effective Period: 7/1/2016 - 6/30/2017

Wage Rate per Hour: \$68.09

Supplemental Benefit Rate per Hour: \$33.54

Supplemental Note: Overtime benefit rate - \$46.86 per hour (time & one half), \$60.18 per hour (double time).

**Field Engineer - HC Instrument Person**

Effective Period: 7/1/2016 - 6/30/2017

Wage Rate per Hour: \$49.98

Supplemental Benefit Rate per Hour: \$33.54

Supplemental Note: Overtime benefit rate - \$46.86 per hour (time & one half), \$60.18 per hour (double time).

**Field Engineer - HC Rodperson**

Effective Period: 7/1/2016 - 6/30/2017

Wage Rate per Hour: \$41.93

Supplemental Benefit Rate per Hour: \$33.54

Supplemental Note: Overtime benefit rate - \$46.86 per hour (time & one half), \$60.18 per hour (double time).

**Overtime Description**

Time and one half the regular rate after an 8 hour day, Time and one half the regular rate for Saturday for the first eight hours worked, Double time the regular time rate for Saturday for work performed in excess of eight hours, Double time the regular rate for Sunday and Double time the regular rate for work on a holiday.

**Paid Holidays**

New Year's Day

Lincoln's Birthday

President's Day

Memorial Day

Independence Day

Labor Day

Columbus Day

Veteran's Day

Thanksgiving Day

Christmas Day

Employees must work at least one day in the payroll week in which the holiday occurs to receive the paid holiday

(Operating Engineer Local #15-D)

---

**ENGINEER - FIELD (STEEL ERECTION)**

**Field Engineer - Steel Erection Party Chief**

OFFICE OF THE COMPTROLLER, CITY OF NEW YORK  
§220 PREVAILING WAGE SCHEDULE

Effective Period: 7/1/2016 - 6/30/2017

Wage Rate per Hour: \$63.64

Supplemental Benefit Rate per Hour: \$33.04

Supplemental Note: Overtime benefit rate - \$46.11 per hour (time & one half), \$59.18 per hour (double time).

**Field Engineer - Steel Erection Instrument Person**

Effective Period: 7/1/2016 - 6/30/2017

Wage Rate per Hour: \$49.59

Supplemental Benefit Rate per Hour: \$33.04

Supplemental Note: Overtime benefit rate - \$46.11 per hour (time & one half), \$59.18 per hour (double time).

**Field Engineer - Steel Erection Rodperson**

Effective Period: 7/1/2016 - 6/30/2017

Wage Rate per Hour: \$33.20

Supplemental Benefit Rate per Hour: \$33.04

Supplemental Note: Overtime benefit rate - \$46.11 per hour (time & one half), \$59.18 per hour (double time).

**Overtime Description**

Time and one half the regular rate for Saturday for the first eight hours worked.

Double time the regular rate for Saturday for work performed in excess of eight hours.

**Overtime**

Time and one half the regular rate after an 8 hour day.

Double time the regular rate for Sunday.

Double time the regular rate for work on the following holiday(s).

**Paid Holidays**

New Year's Day

Lincoln's Birthday

President's Day

Memorial Day

Independence Day

Labor Day

Columbus Day

Veteran's Day

Thanksgiving Day

Christmas Day

Employees must work at least one day in the payroll week in which the holiday occurs to receive the paid holiday

(Operating Engineer Local #15-D)

---

---

**ENGINEER - OPERATING**

**Operating Engineer - Road & Heavy Construction I**

OFFICE OF THE COMPTROLLER, CITY OF NEW YORK  
\$220 PREVAILING WAGE SCHEDULE

Back Filling Machines, Cranes, Mucking Machines and Dual Drum Paver.

Effective Period: 7/1/2016 - 6/30/2017

Wage Rate per Hour: \$73.90

Supplemental Benefit Rate per Hour: \$31.10

Supplemental Note: \$56.50 overtime hours

Shift Wage Rate: \$118.24

**Operating Engineer - Road & Heavy Construction II**

Backhoes, Power Shovels, Hydraulic Clam Shells, Steel Erection, Moles and machines of a similar nature.

Effective Period: 7/1/2016 - 6/30/2017

Wage Rate per Hour: \$76.51

Supplemental Benefit Rate per Hour: \$31.10

Supplemental Note: \$56.50 overtime hours

Shift Wage Rate: \$122.42

**Operating Engineer - Road & Heavy Construction III**

Mine Hoists, Cranes, etc. (Used as Mine Hoists)

Effective Period: 7/1/2016 - 6/30/2017

Wage Rate per Hour: \$78.96

Supplemental Benefit Rate per Hour: \$31.10

Supplemental Note: \$56.50 overtime hours

Shift Wage Rate: \$126.34

**Operating Engineer - Road & Heavy Construction IV**

Gradealls, Keystones, Cranes on land or water (with digging buckets), Bridge Cranes, Vermeer Cutter and machines of a similar nature, Trenching Machines.

Effective Period: 7/1/2016 - 6/30/2017

Wage Rate per Hour: \$77.07

Supplemental Benefit Rate per Hour: \$31.10

Supplemental Note: \$56.50 overtime hours

Shift Wage Rate: \$123.31

**Operating Engineer - Road & Heavy Construction V**

Pile Drivers & Rigs (employing Dock Builder foreperson): Derrick Boats, Tunnel Shovels.

Effective Period: 7/1/2016 - 6/30/2017

Wage Rate per Hour: \$75.55

Supplemental Benefit Rate per Hour: \$31.10

Supplemental Note: \$56.50 overtime hours

Shift Wage Rate: \$120.88

OFFICE OF THE COMPTROLLER, CITY OF NEW YORK  
§220 PREVAILING WAGE SCHEDULE

**Operating Engineer - Road & Heavy Construction VI**

Mixers (Concrete with loading attachment), Concrete Pavers, Cableways, Land Derricks, Power Houses (Low Air Pressure Units).

Effective Period: 7/1/2016 - 6/30/2017

Wage Rate per Hour: \$71.78

Supplemental Benefit Rate per Hour: \$31.10

Supplemental Note: \$56.50 overtime hours

Shift Wage Rate: \$114.85

**Operating Engineer - Road & Heavy Construction VII**

Barrier Movers , Barrier Transport and Machines of a Similar Nature.

Effective Period: 7/1/2016 - 6/30/2017

Wage Rate per Hour: \$57.96

Supplemental Benefit Rate per Hour: \$31.10

Supplemental Note: \$56.50 overtime hours

Shift Wage Rate: \$92.74

**Operating Engineer - Road & Heavy Construction VIII**

Utility Compressors

Effective Period: 7/1/2016 - 6/30/2017

Wage Rate per Hour: \$44.98

Supplemental Benefit Rate per Hour: \$31.10

Supplemental Note: \$56.50 overtime hours

Shift Wage Rate: \$56.70

**Operating Engineer - Road & Heavy Construction IX**

Horizontal Boring Rig

Effective Period: 7/1/2016 - 6/30/2017

Wage Rate per Hour: \$68.25

Supplemental Benefit Rate per Hour: \$31.10

Supplemental Note: \$56.50 overtime hours

Shift Wage Rate: \$109.20

**Operating Engineer - Road & Heavy Construction X**

Elevators (manually operated as personnel hoist).

Effective Period: 7/1/2016 - 6/30/2017

Wage Rate per Hour: \$62.73

Supplemental Benefit Rate per Hour: \$31.10

Supplemental Note: \$56.50 overtime hours

Shift Wage Rate: \$100.37

OFFICE OF THE COMPTROLLER, CITY OF NEW YORK  
\$220 PREVAILING WAGE SCHEDULE

**Operating Engineer - Road & Heavy Construction XI**

Compressors (Portable 3 or more in battery), Driving of Truck Mounted Compressors, Well-point Pumps, Tugger Machines Well Point Pumps, Churn Drill.

Effective Period: 7/1/2016 - 6/30/2017

Wage Rate per Hour: \$48.73

Supplemental Benefit Rate per Hour: \$31.10

Supplemental Note: \$56.50 overtime hours

Shift Wage Rate: \$77.97

**Operating Engineer - Road & Heavy Construction XII**

All Drills and Machines of a similar nature.

Effective Period: 7/1/2016 - 6/30/2017

Wage Rate per Hour: \$72.53

Supplemental Benefit Rate per Hour: \$31.10

Supplemental Note: \$56.50 overtime hours

Shift Wage Rate: \$116.05

**Operating Engineer - Road & Heavy Construction XIII**

Concrete Pumps, Concrete Plant, Stone Crushers, Double Drum Hoist, Power Houses (other than above).

Effective Period: 7/1/2016 - 6/30/2017

Wage Rate per Hour: \$70.24

Supplemental Benefit Rate per Hour: \$31.10

Supplemental Note: \$56.50 overtime hours

Shift Wage Rate: \$112.38

**Operating Engineer - Road & Heavy Construction XIV**

Concrete Mixer

Effective Period: 7/1/2016 - 6/30/2017

Wage Rate per Hour: \$67.16

Supplemental Benefit Rate per Hour: \$31.10

Supplemental Note: \$56.50 overtime hours

Shift Wage Rate: \$107.46

**Operating Engineer - Road & Heavy Construction XV**

Compressors (Portable Single or two in Battery, not over 100 feet apart), Pumps (River Cofferdam) and Welding Machines, Push Button Machines, All Engines Irrespective of Power (Power-Pac) used to drive auxillary equipment, Air, Hydraulic, etc.

Effective Period: 7/1/2016 - 6/30/2017

Wage Rate per Hour: \$45.27

OFFICE OF THE COMPTROLLER, CITY OF NEW YORK  
§220 PREVAILING WAGE SCHEDULE

Supplemental Benefit Rate per Hour: **\$31.10**  
Supplemental Note: **\$56.50** overtime hours  
Shift Wage Rate: **\$72.43**

**Operating Engineer - Road & Heavy Construction XVI**

Concrete Breaking Machines, Hoists (Single Drum), Load Masters, Locomotives (over ten tons) and Dinkies over ten tons, Hydraulic Crane-Second Engineer.

Effective Period: **7/1/2016 - 6/30/2017**  
Wage Rate per Hour: **\$64.13**  
Supplemental Benefit Rate per Hour: **\$31.10**  
Supplemental Note: **\$56.50** overtime hours  
Shift Wage Rate: **\$102.61**

**Operating Engineer - Road & Heavy Construction XVII**

On-Site concrete plant engineer, On-site Asphalt Plant Engineer, and Vibratory console.

Effective Period: **7/1/2016 - 6/30/2017**  
Wage Rate per Hour: **\$64.63**  
Supplemental Benefit Rate per Hour: **\$31.10**  
Supplemental Note: **\$56.50** overtime hours  
Shift Wage Rate: **\$103.41**

**Operating Engineer - Road & Heavy Construction XVIII**

Tower Crane

Effective Period: **7/1/2016 - 6/30/2017**  
Wage Rate per Hour: **\$92.76**  
Supplemental Benefit Rate per Hour: **\$31.10**  
Supplemental Note: **\$56.50** overtime hours  
Shift Wage Rate: **\$148.42**

**Operating Engineer - Paving I**

Asphalt Spreaders, Autogrades (C.M.I.), Roto/MII

Effective Period: **7/1/2016 - 6/30/2017**  
Wage Rate per Hour: **\$71.78**  
Supplemental Benefit Rate per Hour: **\$31.10**  
Supplemental Note: **\$56.50** overtime hours  
Shift Wage Rate: **\$114.85**

**Operating Engineer - Paving II**

Asphalt Roller

Effective Period: **7/1/2016 - 6/30/2017**

OFFICE OF THE COMPTROLLER, CITY OF NEW YORK  
\$220 PREVAILING WAGE SCHEDULE

Wage Rate per Hour: \$69.91  
Supplemental Benefit Rate per Hour: \$31.10  
Supplemental Note: \$56.50 overtime hours  
Shift Wage Rate: \$111.86

**Operating Engineer - Paving III**

Asphalt Plants

Effective Period: 7/1/2016 - 6/30/2017  
Wage Rate per Hour: \$59.14  
Supplemental Benefit Rate per Hour: \$31.10  
Supplemental Note: \$56.50 overtime hours  
Shift Wage Rate: \$94.62

**Operating Engineer - Concrete I**

Cranes

Effective Period: 7/1/2016 - 6/30/2017  
Wage Rate per Hour: \$76.73  
Supplemental Benefit Rate per Hour: \$31.10  
Supplemental Note: \$56.50 overtime hours

**Operating Engineer - Concrete II**

Compressors

Effective Period: 7/1/2016 - 6/30/2017  
Wage Rate per Hour: \$45.62  
Supplemental Benefit Rate per Hour: \$31.10  
Supplemental Note: \$56.50 overtime hours

**Operating Engineer - Concrete III**

Micro-traps (Negative Air Machines), Vac-All Remediation System.

Effective Period: 7/1/2016 - 6/30/2017  
Wage Rate per Hour: \$61.31  
Supplemental Benefit Rate per Hour: \$31.10  
Supplemental Note: \$56.50 overtime hours

**Operating Engineer - Steel Erection I**

Three Drum Derricks

Effective Period: 7/1/2016 - 6/30/2017  
Wage Rate per Hour: \$79.54  
Supplemental Benefit Rate per Hour: \$31.10  
Supplemental Note: \$56.50 overtime hours



OFFICE OF THE COMPTROLLER, CITY OF NEW YORK  
§220 PREVAILING WAGE SCHEDULE

Shift Wage Rate: \$127.26

**Operating Engineer - Steel Erection II**

Cranes, 2 Drum Derricks, Hydraulic Cranes, Fork Lifts and Boom Trucks.

Effective Period: 7/1/2016 - 6/30/2017

Wage Rate per Hour: \$76.43

Supplemental Benefit Rate per Hour: \$31.10

Supplemental Note: \$56.50 overtime hours

Shift Wage Rate: \$122.29

**Operating Engineer - Steel Erection III**

Compressors, Welding Machines.

Effective Period: 7/1/2016 - 6/30/2017

Wage Rate per Hour: \$45.34

Supplemental Benefit Rate per Hour: \$31.10

Supplemental Note: \$56.50 overtime hours

Shift Wage Rate: \$72.54

**Operating Engineer - Steel Erection IV**

Compressors - Not Combined with Welding Machine.

Effective Period: 7/1/2016 - 6/30/2017

Wage Rate per Hour: \$43.17

Supplemental Benefit Rate per Hour: \$31.10

Supplemental Note: \$56.50 overtime hours

Shift Wage Rate: \$69.07

**Operating Engineer - Building Work I**

Forklifts, Plaster (Platform machine), Plaster Bucket, Concrete Pump and all other equipment used for hoisting material.

Effective Period: 7/1/2016 - 6/30/2017

Wage Rate per Hour: \$63.12

Supplemental Benefit Rate per Hour: \$31.10

Supplemental Note: \$56.50 overtime hours

**Operating Engineer - Building Work II**

Compressors, Welding Machines (Cutting Concrete-Tank Work), Paint Spraying, Sandblasting, Pumps (with the exclusion of Concrete Pumps), All Engines irrespective of Power (Power-Pac) used to drive Auxiliary Equipment, Air, Hydraulic, Jacking System, etc.

Effective Period: 7/1/2016 - 6/30/2017

Wage Rate per Hour: \$47.26

OFFICE OF THE COMPTROLLER, CITY OF NEW YORK  
\$220 PREVAILING WAGE SCHEDULE

Supplemental Benefit Rate per Hour: **\$31.10**  
Supplemental Note: \$56.50 overtime hours

**Operating Engineer - Building Work III**

Double Drum

Effective Period: 7/1/2016 - 6/30/2017  
Wage Rate per Hour: **\$71.85**  
Supplemental Benefit Rate per Hour: **\$31.10**  
Supplemental Note: \$56.50 overtime hours

**Operating Engineer - Building Work IV**

Stone Derrick, Cranes, Hydraulic Cranes Boom Trucks.

Effective Period: 7/1/2016 - 6/30/2017  
Wage Rate per Hour: **\$76.12**  
Supplemental Benefit Rate per Hour: **\$31.10**  
Supplemental Note: \$56.50 overtime hours

**Operating Engineer - Building Work V**

Dismantling and Erection of Cranes, Relief Engineer.

Effective Period: 7/1/2016 - 6/30/2017  
Wage Rate per Hour: **\$70.13**  
Supplemental Benefit Rate per Hour: **\$31.10**  
Supplemental Note: \$56.50 overtime hours

**Operating Engineer - Building Work VI**

4 Pole Hoist, Single Drum Hoists.

Effective Period: 7/1/2016 - 6/30/2017  
Wage Rate per Hour: **\$69.39**  
Supplemental Benefit Rate per Hour: **\$31.10**  
Supplemental Note: \$56.50 overtime hours

**Operating Engineer - Building Work VII**

Rack & Pinion and House Cars

Effective Period: 7/1/2016 - 6/30/2017  
Wage Rate per Hour: **\$55.17**  
Supplemental Benefit Rate per Hour: **\$31.10**  
Supplemental Note: \$56.50 overtime hours  
For New House Car projects Wage Rate per Hour \$44.02

**Overtime Description**

OFFICE OF THE COMPTROLLER, CITY OF NEW YORK  
§220 PREVAILING WAGE SCHEDULE

On jobs of more than one shift, if an Employee fails to report for work through any cause over which the Employer has no control, the Employee on duty will continue to work at the rate of single time.

For House Cars and Rack & Pinion only: Overtime paid at time and one-half for all hours in excess of eight hours in a day, Saturday, Sunday and Holidays worked.

### Overtime

Double time the regular rate after an 8 hour day.

Double time the regular time rate for Saturday.

Double time the regular rate for Sunday.

Double time the regular rate for work on the following holiday(s).

### Paid Holidays

New Year's Day

Lincoln's Birthday

President's Day

Memorial Day

Independence Day

Labor Day

Columbus Day

Veteran's Day

Thanksgiving Day

Day after Thanksgiving

Christmas Day

Employees must work at least one day in the payroll week in which the holiday occurs to receive the paid holiday

### Shift Rates

For Steel Erection Only: Shifts may be worked at the single time rate at other than the regular working hours (8:00 A.M. to 4:30 P.M.) on the following work ONLY: Heavy construction jobs on work below the street level, over railroad tracks and on building jobs.

(Operating Engineer Local #14)

---

---

## FLOOR COVERER

(Interior vinyl composition tile, sheath vinyl linoleum and wood parquet tile including site preparation and synthetic turf not including site preparation)

### Floor Coverer

Effective Period: 7/1/2016 - 6/30/2017

Wage Rate per Hour: \$50.50

Supplemental Benefit Rate per Hour: \$45.88

### Overtime

Time and one half the regular rate after an 8 hour day.

OFFICE OF THE COMPTROLLER, CITY OF NEW YORK  
§220 PREVAILING WAGE SCHEDULE

Time and one half the regular rate for Saturday.  
Double time the regular rate for Sunday.

**Overtime Holidays**

Double time the regular rate for work on the following holiday(s).

New Year's Day  
President's Day  
Memorial Day  
Independence Day  
Labor Day  
Columbus Day  
Presidential Election Day  
Thanksgiving Day  
Day after Thanksgiving  
Christmas Day

**Paid Holidays**

1/2 day on Christmas Eve if work is performed in the A.M.  
1/2 day on New Year's Eve if work is performed in the A.M.

**Shift Rates**

Two shifts may be utilized with the first shift working 8:00 A.M. to the end of the shift at the straight time of pay. The second shift will receive one hour at double time rate for the last hour of the shift. (eight for seven, nine for eight).

(Carpenters District Council)

---

---

**GLAZIER**

(New Construction, Remodeling, and Alteration)

**Glazier**

Effective Period: 7/1/2016 - 6/30/2017

Wage Rate per Hour: \$44.45

Supplemental Benefit Rate per Hour: \$37.84

Supplemental Note: Supplemental Benefit Overtime Rate: \$46.84

**Overtime Description**

An optional 8th hour can be worked at straight time rate. If 9th hour is worked, then both hours or more (8th & 9th or more) will be at the double time rate of pay.

**Overtime**

Double time the regular rate after a 7 hour day.

Double time the regular time rate for Saturday.

Double time the regular rate for Sunday.

OFFICE OF THE COMPTROLLER, CITY OF NEW YORK  
§220 PREVAILING WAGE SCHEDULE

**Overtime Holidays**

Double time the regular rate for work on the following holiday(s).

New Year's Day  
President's Day  
Memorial Day  
Independence Day  
Labor Day  
Thanksgiving Day  
Day after Thanksgiving  
Christmas Day

**Paid Holidays**

None

**Shift Rates**

Shifts shall be any 7 hours beyond 4:00 P.M. for which the glazier shall receive 8 hours pay for 7 hours worked.

(Local #1281)

---

---

**GLAZIER - REPAIR & MAINTENANCE**

(For the Installation of Glass - All repair and maintenance work on a particular building, whenever performed, where the total cumulative contract value is under \$127,628. Except where enumerated (i.e. plate glass windows) does not apply to non-residential buildings.)

**Craft Jurisdiction for repair, maintenance and fabrication**

Plate glass replacement, Residential glass replacement, Residential mirrors and shower doors, Storm windows and storm doors, Residential replacement windows, Herculite door repairs, Door closer repairs, Retrofit apartment house (non commercial buildings), Glass tinting.

Effective Period: 7/1/2016 - 6/30/2017

Wage Rate per Hour: \$23.78

Supplemental Benefit Rate per Hour: \$20.14

**Overtime**

Time and one half the regular rate after an 8 hour day.

Double time the regular rate for Sunday.

Time and one half the regular hourly rate after 40 hours in any work week.

**Paid Holidays**

New Year's Day  
President's Day

OFFICE OF THE COMPTROLLER, CITY OF NEW YORK  
\$220 PREVAILING WAGE SCHEDULE

Memorial Day  
Independence Day  
Labor Day  
Thanksgiving Day  
Day after Thanksgiving  
Christmas Day

(Local #1281)

---

---

## HEAT AND FROST INSULATOR

### Heat & Frost Insulator

Effective Period: 7/1/2016 - 6/30/2017

Wage Rate per Hour: \$57.78

Supplemental Benefit Rate per Hour: \$38.96

### Overtime Description

Double time shall be paid for supplemental benefits during overtime work.  
8th hour paid at time and one half.

### Overtime

Double time the regular rate after an 8 hour day.  
Double time the regular time rate for Saturday.  
Double time the regular rate for Sunday.

### Overtime Holidays

Double time the regular rate for work on the following holiday(s).

New Year's Day  
Martin Luther King Jr. Day  
President's Day  
Memorial Day  
Independence Day  
Columbus Day  
Veteran's Day  
Thanksgiving Day  
Day after Thanksgiving  
Christmas Day

Triple time the regular rate for work on the following holiday(s).  
Labor Day

### Paid Holidays

None

### Shift Rates

OFFICE OF THE COMPTROLLER, CITY OF NEW YORK  
\$220 PREVAILING WAGE SCHEDULE

The first shift shall work seven hours at the regular straight time rate. The second and third shift shall work seven hours the regular straight time hourly rate plus a fourteen percent wage and benefit premium. Off hour work in occupied or retail buildings may be worked on weekdays with an increment of \$1.00 per hour and eight hours pay for seven (7) hours worked. Double time will apply for over seven (7) hours worked on weekdays, weekends or holidays.

(Local #12) (BCA)

---

---

## **HOUSE WRECKER (TOTAL DEMOLITION)**

### **House Wrecker - Tier A**

On all work sites the first, second, eleventh and every third House Wrecker thereafter will be Tier A House Wreckers (i.e. 1st, 2nd, 11th, 14th etc). Other House Wreckers may be Tier B House Wreckers.

Effective Period: 7/1/2016 - 6/30/2017

Wage Rate per Hour: **\$36.33**

Supplemental Benefit Rate per Hour: **\$27.77**

### **House Wrecker - Tier B**

Effective Period: 7/1/2016 - 6/30/2017

Wage Rate per Hour: **\$25.56**

Supplemental Benefit Rate per Hour: **\$20.45**

### **Overtime**

Time and one half the regular rate after an 8 hour day.

Time and one half the regular rate for Saturday.

Double time the regular rate for Sunday.

### **Overtime Holidays**

Double time the regular rate for work on the following holiday(s).

New Year's Day

President's Day

Memorial Day

Independence Day

Labor Day

Thanksgiving Day

Christmas Day

### **Paid Holidays**

None

OFFICE OF THE COMPTROLLER, CITY OF NEW YORK  
§220 PREVAILING WAGE SCHEDULE

(Mason Tenders District Council)

---

---

## **IRON WORKER - ORNAMENTAL**

### **Iron Worker - Ornamental**

Effective Period: 7/1/2016 - 6/30/2017

Wage Rate per Hour: **\$43.75**

Supplemental Benefit Rate per Hour: **\$49.57**

Supplemental Note: Supplemental benefits are to be paid at the applicable overtime rate when overtime is in effect.

### **Overtime Description**

Time and one half the regular rate after a 7 hour day for a maximum of two hours on any regular work day (the 8th and 9th hour) and double time shall be paid for all work on a regular work day thereafter, time and one half the regular rate for Saturday for the first seven hours of work and double time shall be paid for all work on a Saturday thereafter.

### **Overtime**

Double time the regular rate for Sunday.

### **Overtime Holidays**

Double time the regular rate for work on the following holiday(s):

New Year's Day

President's Day

Memorial Day

Independence Day

Labor Day

Thanksgiving Day

Christmas Day

### **Paid Holidays**

None

### **Shift Rates**

For off shift work - 8 hours pay for 7 hours of work. When two or three shifts are employed on a job, Monday through Friday, the workday for each shift shall be seven hours and paid for ten and one-half hours at the single time rate. When two or three shifts are worked on Saturday, Sunday or holidays, each shift shall be seven hours and paid fifteen and three-quarters hours.

(Local #580)

---

---



OFFICE OF THE COMPTROLLER, CITY OF NEW YORK  
§220 PREVAILING WAGE SCHEDULE

## **IRON WORKER - STRUCTURAL**

### **Iron Worker - Structural**

Effective Period: 7/1/2016 - 6/30/2017

Wage Rate per Hour: **\$49.50**

Supplemental Benefit Rate per Hour: **\$69.74**

Supplemental Note: Supplemental benefits are to be paid at the applicable overtime rate when overtime is in effect.

### **Overtime Description**

Monday through Friday- the first eight hours are paid at straight time, the 9th and 10th hours are paid at time and one-half the regular rate, all additional weekday overtime is paid at double the regular rate. Saturdays- the first eight hours are paid at time and one-half the regular rate, double time thereafter. Sunday-all shifts are paid at double time.

### **Overtime**

Time and one half the regular rate after an 8 hour day.  
Time and one half the regular rate for Saturday.  
Double time the regular rate for Sunday.

### **Overtime Holidays**

Double time the regular rate for work on the following holiday(s).

New Year's Day  
President's Day  
Memorial Day  
Independence Day  
Labor Day  
Thanksgiving Day  
Christmas Day

### **Paid Holidays**

1/2 day on Christmas Eve if work is performed in the A.M.  
1/2 day on New Year's Eve if work is performed in the A.M.

### **Shift Rates**

Monday through Friday - First Shift: First eight hours are paid at straight time, the 9th & 10th hours are paid at time and a half, double time paid thereafter. Second and third Shifts: First eight hours are paid at time and one-half, double time thereafter. Saturdays: All shifts, first eight hours paid at time and one-half, double time thereafter. Sunday all shifts are paid at double time.

(Local #40 & #361)

---

---

## **LABORER**

**(Foundation, Concrete, Excavating, Street Pipe Layer and Common)**

OFFICE OF THE COMPTROLLER, CITY OF NEW YORK  
§220 PREVAILING WAGE SCHEDULE

**Laborer**

Excavation and foundation work for buildings, heavy construction, engineering work, and hazardous waste removal in connection with the above work. Landscaping tasks in connection with heavy construction work, engineering work and building projects. Projects include, but are not limited to pollution plants, sewers, parks, subways, bridges, highways, etc.

Effective Period: 7/1/2016 - 6/30/2017

Wage Rate per Hour: \$41.00

Supplemental Benefit Rate per Hour: \$38.63

**Overtime**

Time and one half the regular rate after an 8 hour day.

Time and one half the regular rate for Saturday.

Double time the regular rate for Sunday.

**Overtime Holidays**

Double time the regular rate for work on the following holiday(s).

New Year's Day

Memorial Day

Independence Day

Labor Day

Columbus Day

Thanksgiving Day

Christmas Day

**Paid Holidays**

Labor Day

Thanksgiving Day

**Shift Rates**

When two shifts are employed, single time rate shall be paid for each shift. When three shifts are found necessary, each shift shall work seven and one half hours (7 ½), but shall be paid for eight (8) hours of labor, and be permitted one half hour for lunch.

(Local #731)

---

**LANDSCAPING**

(Landscaping tasks, as well as tree pruning, tree removing, spraying and maintenance in connection with the planting of street trees and the planting of trees in city parks but not when such activities are performed as part of, or in connection with, other construction or reconstruction projects.)

OFFICE OF THE COMPTROLLER, CITY OF NEW YORK  
§220 PREVAILING WAGE SCHEDULE

**Landscaper (Above 6 years experience)**

Effective Period: 7/1/2016 - 6/30/2017  
Wage Rate per Hour: \$27.00  
Supplemental Benefit Rate per Hour: \$14.55

**Landscaper (3 - 6 years experience)**

Effective Period: 7/1/2016 - 6/30/2017  
Wage Rate per Hour: \$26.00  
Supplemental Benefit Rate per Hour: \$14.55

**Landscaper (up to 3 years experience)**

Effective Period: 7/1/2016 - 6/30/2017  
Wage Rate per Hour: \$23.50  
Supplemental Benefit Rate per Hour: \$14.55

**Groundperson**

Effective Period: 7/1/2016 - 6/30/2017  
Wage Rate per Hour: \$23.50  
Supplemental Benefit Rate per Hour: \$14.55

**Tree Remover / Pruner**

Effective Period: 7/1/2016 - 6/30/2017  
Wage Rate per Hour: \$32.00  
Supplemental Benefit Rate per Hour: \$14.55

**Landscaper Sprayer (Pesticide Applicator)**

Effective Period: 7/1/2016 - 6/30/2017  
Wage Rate per Hour: \$22.00  
Supplemental Benefit Rate per Hour: \$14.55

**Watering - Plant Maintainer**

Effective Period: 7/1/2016 - 6/30/2017  
Wage Rate per Hour: \$17.00  
Supplemental Benefit Rate per Hour: \$14.55

**Overtime Description**

For all overtime work performed, supplemental benefits shall include an additional seventy-five (\$0.75) cents per hour.

**Overtime**

Time and one half the regular rate after an 8 hour day.

OFFICE OF THE COMPTROLLER, CITY OF NEW YORK  
\$220 PREVAILING WAGE SCHEDULE

Time and one half the regular rate for Saturday.  
Double time the regular rate for Sunday.  
Time and one half the regular rate for work on a holiday plus the day's pay.

**Paid Holidays**

New Year's Day  
Memorial Day  
Independence Day  
Labor Day  
Thanksgiving Day  
Christmas Day

**Shift Rates**

Work performed on a 4pm to 12am shift has a 15% differential. Work performed on a 12am to 8am shift has a 20% differential.

(Local #175)

---

---

**MARBLE MECHANIC**

**Marble Setter**

Effective Period: 7/1/2016 - 12/31/2016

Wage Rate per Hour: **\$52.32**

Supplemental Benefit Rate per Hour: **\$37.64**

Effective Period: 1/1/2017 - 6/30/2017

Wage Rate per Hour: **\$52.74**

Supplemental Benefit Rate per Hour: **\$38.67**

**Marble Finisher**

Effective Period: 7/1/2016 - 12/31/2016

Wage Rate per Hour: **\$41.11**

Supplemental Benefit Rate per Hour: **\$35.91**

Effective Period: 1/1/2017 - 6/30/2017

Wage Rate per Hour: **\$41.46**

Supplemental Benefit Rate per Hour: **\$36.64**

**Marble Polisher**

Effective Period: 7/1/2016 - 12/31/2016

Wage Rate per Hour: **\$37.49**

Supplemental Benefit Rate per Hour: **\$27.80**

OFFICE OF THE COMPTROLLER, CITY OF NEW YORK  
\$220 PREVAILING WAGE SCHEDULE

Effective Period: 1/1/2017 - 6/30/2017

Wage Rate per Hour: \$37.93

Supplemental Benefit Rate per Hour: \$28.33

### Overtime Description

Supplemental Benefit contributions are to be made at the applicable overtime rates. Time and one half the regular rate after a 7 hour day or time and one half the regular rate after an 8 hour day - chosen by Employer at the start of the project and then would last for the full duration of the project.

### Overtime

Time and one half the regular rate for Saturday.

Double time the regular rate for Sunday.

### Overtime Holidays

Double time the regular rate for work on the following holiday(s).

New Year's Day

President's Day

Good Friday

Memorial Day

Independence Day

Labor Day

Columbus Day

Veteran's Day

Thanksgiving Day

Day after Thanksgiving

Christmas Day

### Paid Holidays

None

(Local #7)

---

## MASON TENDER

### Mason Tender

Effective Period: 7/1/2016 - 6/30/2017

Wage Rate per Hour: \$37.55

Supplemental Benefit Rate per Hour: \$29.04

### Overtime

Time and one half the regular rate after an 8 hour day.

Time and one half the regular rate for Saturday.

Double time the regular rate for Sunday.

OFFICE OF THE COMPTROLLER, CITY OF NEW YORK  
\$220 PREVAILING WAGE SCHEDULE

Saturday may be used as a make-up day at straight time when a day is lost during that week to inclement weather.

**Overtime Holidays**

Double time the regular rate for work on the following holiday(s).

- New Year's Day
- President's Day
- Memorial Day
- Independence Day
- Labor Day
- Thanksgiving Day
- Christmas Day

**Paid Holidays**

None

**Shift Rates**

The Employer may work two (2) shifts with the first shift at the straight time wage rate and the second shift receiving eight (8) hours paid for seven (7) hours work at the straight time wage rate.

(Local #79)

---

---

**MASON TENDER (INTERIOR DEMOLITION WORKER)**

(The erection, building, moving, servicing and dismantling of enclosures, scaffolding, barricades, protection and site safety structures etc., on Interior Demolition jobs.)

**Mason Tender Tier A**

Effective Period: 7/1/2016 - 6/30/2017

Wage Rate per Hour: \$36.19

Supplemental Benefit Rate per Hour: \$22.95

**Mason Tender Tier B**

On Interior Demolition job sites 33 1/3 % of the employees shall be classified as Tier A Interior Demolition Workers and 66 2/3 % shall be classified as Tier B Interior Demolition Workers; provided that the employer may employ more than 33 1/3 % Tier A Interior Demolition Workers on the job site. Where the number of employees on a job site is not divisible by 3, the first additional employee (above the number of employees divisible by three) shall be a Tier B Interior Demolition Worker, and the second additional employee shall be a Tier A Interior Demolition Worker.

Effective Period: 7/1/2016 - 6/30/2017

Wage Rate per Hour: \$25.38

OFFICE OF THE COMPTROLLER, CITY OF NEW YORK  
§220 PREVAILING WAGE SCHEDULE

Supplemental Benefit Rate per Hour: **\$17.27**

**Overtime**

Time and one half the regular rate after an 8 hour day.  
Time and one half the regular rate for Sunday.

**Overtime Holidays**

Double time the regular rate for work on the following holiday(s).

New Year's Day  
President's Day  
Memorial Day  
Independence Day  
Labor Day  
Thanksgiving Day  
Christmas Day

**Paid Holidays**

None

(Local #79)

---

---

**METALLIC LATHER**

**Metallic Lather**

Effective Period: 7/1/2016 - 6/30/2017

Wage Rate per Hour: **\$44.53**

Supplemental Benefit Rate per Hour: **\$42.67**

Supplemental Note: Supplemental benefits for overtime are paid at the appropriate overtime rate.

**Overtime Description**

Overtime would be time and one half the regular rate after a seven (7) or eight (8) hours workday, which would be set at the start of the job.

**Overtime**

Time and one half the regular rate for Saturday.  
Double time the regular rate for Sunday.

**Overtime Holidays**

Double time the regular rate for work on the following holiday(s).

New Year's Day  
Washington's Birthday  
Memorial Day  
Independence Day  
Labor Day  
Columbus Day

OFFICE OF THE COMPTROLLER, CITY OF NEW YORK  
§220 PREVAILING WAGE SCHEDULE

Thanksgiving Day  
Christmas Day

**Paid Holidays**

1/2 day on Christmas Eve if work is performed in the A.M.  
1/2 day on New Year's Eve if work is performed in the A.M.

**Shift Rates**

There will be no shift differential paid on the first shift if more than one shift is employed. The shift differential will remain \$12/hour on the second and third shift for the first eight (8) hours if worked. There will be no pyramiding on overtime worked on second and third shifts. The time and one half (1.5x) rate will be against the base wage rate, not the shift differential

(Local #46)

---

---

**MILLWRIGHT**

**Millwright**

Effective Period: 7/1/2016 - 6/30/2017

Wage Rate per Hour: \$51.50

Supplemental Benefit Rate per Hour: \$52.41

**Overtime**

Time and one half the regular rate after an 8 hour day.

Time and one half the regular rate for Saturday.

Double time the regular rate for Sunday.

Saturday may be used as a make-up day at straight time when a day is lost during that week to inclement weather.

**Overtime Holidays**

Double time the regular rate for work on the following holiday(s).

New Year's Day

President's Day

Good Friday

Memorial Day

Independence Day

Labor Day

Columbus Day

Presidential Election Day

Thanksgiving Day

Christmas Day

**Paid Holidays**

1/2 day on Christmas Eve if work is performed in the A.M.

1/2 day on New Year's Eve if work is performed in the A.M.



OFFICE OF THE COMPTROLLER, CITY OF NEW YORK  
§220 PREVAILING WAGE SCHEDULE

**Shift Rates**

The first shift shall receive the straight time rate of pay. The second shift receives the straight time rate of pay plus fifteen (15%) per cent. Members of the second shift shall be allowed one half hour to eat, with this time being included in the hours of the workday established. There must be a first shift to work a second shift. All additional hours worked shall be paid at the time and one-half rate of pay plus fifteen (15%) per cent for weekday hours.

(Local #740)

---

**MOSAIC MECHANIC**

**Mosaic Mechanic - Mosaic & Terrazzo Mechanic**

Effective Period: 7/1/2016 - 6/30/2017

Wage Rate per Hour: \$46.52

Supplemental Benefit Rate per Hour: \$39.84

Supplemental Note: Supplemental benefits for overtime to be paid at the rate of \$50.86 per hour.

**Mosaic Mechanic - Mosaic & Terrazzo Finisher**

Effective Period: 7/1/2016 - 6/30/2017

Wage Rate per Hour: \$44.91

Supplemental Benefit Rate per Hour: \$39.83

Supplemental Note: Supplemental benefits for overtime to be paid at the rate of \$50.85 per hour.

**Mosaic Mechanic - Machine Operator Grinder**

Effective Period: 7/1/2016 - 6/30/2017

Wage Rate per Hour: \$44.91

Supplemental Benefit Rate per Hour: \$39.83

Supplemental Note: Supplemental benefits for overtime to be paid at the rate of \$50.85 per hour.

**Overtime**

Time and one half the regular rate after a 7 hour day.

Time and one half the regular rate for Saturday.

Double time the regular rate for Sunday.

**Overtime Holidays**

Double time the regular rate for work on the following holiday(s).

New Year's Day

Washington's Birthday

Good Friday

Independence Day

Labor Day

Columbus Day

OFFICE OF THE COMPTROLLER, CITY OF NEW YORK  
§220 PREVAILING WAGE SCHEDULE

Veteran's Day  
Thanksgiving Day  
Day after Thanksgiving  
Christmas Day

**Paid Holidays**  
None

(Local #7)

---

---

## **PAINTER**

### **Painter - Brush & Roller**

Effective Period: 7/1/2016 - 4/30/2017  
Wage Rate per Hour: \$42.50  
Supplemental Benefit Rate per Hour: \$26.62  
Supplemental Note: \$31.25 on overtime

Effective Period: 5/1/2017 - 6/30/2017  
Wage Rate per Hour: \$44.10  
Supplemental Benefit Rate per Hour: \$27.02  
Supplemental Note: \$ 31.65 on overtime

### **Spray & Scaffold / Decorative / Sandblast**

Effective Period: 7/1/2016 - 4/30/2017  
Wage Rate per Hour: \$45.50  
Supplemental Benefit Rate per Hour: \$26.62  
Supplemental Note: \$ 31.25 on overtime

Effective Period: 5/1/2017 - 6/30/2017  
Wage Rate per Hour: \$47.10  
Supplemental Benefit Rate per Hour: \$27.02  
Supplemental Note: \$ 31.65 on overtime

### **Overtime**

Time and one half the regular rate after a 7 hour day.  
Time and one half the regular rate for Saturday.  
Time and one half the regular rate for Sunday.

### **Overtime Holidays**

Time and one half the regular rate for work on the following holiday(s).  
New Year's Day  
President's Day  
Memorial Day

OFFICE OF THE COMPTROLLER, CITY OF NEW YORK  
§220 PREVAILING WAGE SCHEDULE

Independence Day  
Labor Day  
Columbus Day  
Thanksgiving Day  
Christmas Day

**Paid Holidays**  
None

(District Council of Painters #9)

---

---

**PAINTER - METAL POLISHER**

**METAL POLISHER**

Effective Period: 7/1/2016 - 6/30/2017  
Wage Rate per Hour: \$28.88  
Supplemental Benefit Rate per Hour: \$6.96

**METAL POLISHER - NEW CONSTRUCTION**

Effective Period: 7/1/2016 - 6/30/2017  
Wage Rate per Hour: \$29.83  
Supplemental Benefit Rate per Hour: \$6.96

**METAL POLISHER - SCAFFOLD OVER 34 FEET**

Effective Period: 7/1/2016 - 6/30/2017  
Wage Rate per Hour: \$32.38  
Supplemental Benefit Rate per Hour: \$6.96

**Overtime Description**

All work performed on Saturdays shall be paid at time-in-a half. The exception being; for suspended scaffold work and work deemed as a construction project; an eight (8) hour shift lost during the week due to circumstances beyond the control of the employer, up to a maximum of eight (8) hours per week, may be worked on Saturday at the straight time rate.

**Overtime**

Time and one half the regular rate after an 8 hour day.  
Time and one half the regular rate for Saturday.  
Double time the regular rate for Sunday.  
Saturday may be used as a make-up day at straight time when a day is lost during that week to inclement weather.  
Triple time the regular rate for work on the following holiday(s).

OFFICE OF THE COMPTROLLER, CITY OF NEW YORK  
\$220 PREVAILING WAGE SCHEDULE

**Paid Holidays**

New Year's Day  
Martin Luther King Jr. Day  
President's Day  
Memorial Day  
Independence Day  
Labor Day  
Columbus Day  
Veteran's Day  
Thanksgiving Day  
Day after Thanksgiving  
Christmas Day

**Shift Rates**

Four Days a week at Ten (10) hours straight a day.

Local 8A-28A

---

---

**PAINTER - STRIPER**

**Striper (paint)**

Effective Period: 7/1/2016 - 6/30/2017

Wage Rate per Hour: \$35.00

Supplemental Benefit Rate per Hour: \$12.32

Supplemental Note: Overtime Supplemental Benefit rate - \$8.02; New Hire Rate (0-3 months) - \$0.00

**Lineperson (thermoplastic)**

Effective Period: 7/1/2016 - 6/30/2017

Wage Rate per Hour: \$39.00

Supplemental Benefit Rate per Hour: \$12.32

Supplemental Note: Overtime Supplemental Benefit rate - \$8.02; New Hire Rate (0-3 months) - \$0.00

**Overtime**

Time and one half the regular rate after an 8 hour day.

Time and one half the regular rate for Saturday.

Double time the regular rate for Sunday.

Time and one half the regular rate for work on the following holiday(s).

**Paid Holidays**

New Year's Day  
Good Friday  
Memorial Day  
Independence Day  
Labor Day

OFFICE OF THE COMPTROLLER, CITY OF NEW YORK  
§220 PREVAILING WAGE SCHEDULE

Columbus Day  
Presidential Election Day  
Thanksgiving Day  
Day after Thanksgiving  
Christmas Day

### Shift Rates

Employees hired before April 1, 2003: 15% night shift premium differential for work commenced at 9:00 PM or later.

### Vacation

Employees with one to two years service shall accrue vacation based on hours worked: 250 hours worked - 1 day vacation; 500 hours worked - 2 days vacation; 750 hours worked - 3 days vacation; 900 hours worked - 4 days vacation; 1,000 hours worked - 5 days vacation. Employees with two to five years service receive two weeks vacation. Employees with five to twenty years service receive three weeks vacation. Employees with twenty to twenty-five years service receive four weeks vacation. Employees with 25 or more years service receive five weeks vacation. Vacation must be taken during winter months. 2 Personal Days except employees hired after 4/1/12 who do not have 2 years of service.

(Local #917)

---

## PAINTER - STRUCTURAL STEEL

### Painters on Structural Steel

Effective Period: 7/1/2016 - 6/30/2017

Wage Rate per Hour: \$49.00

Supplemental Benefit Rate per Hour: \$36.08

### Painter - Power Tool

Effective Period: 7/1/2016 - 6/30/2017

Wage Rate per Hour: \$55.00

Supplemental Benefit Rate per Hour: \$36.08

### Overtime Description

Supplemental Benefits shall be paid for each hour worked, up to forty (40) hours per week for the period of May 1st to November 15th or up to fifty (50) hours per week for the period of November 16th to April 30th.

### Overtime

Time and one half the regular rate after a 7 hour day.

Time and one half the regular rate for Saturday.

Time and one half the regular rate for Sunday.

### Overtime Holidays

Double time the regular rate for work on the following holiday(s).

New Year's Day

OFFICE OF THE COMPTROLLER, CITY OF NEW YORK  
§220 PREVAILING WAGE SCHEDULE

Memorial Day  
Independence Day  
Labor Day  
Thanksgiving Day  
Christmas Day

**Paid Holidays**

None

**Shift Rates**

Regular hourly rates plus a ten per cent (10%) differential

(Local #806)

---

**PAPERHANGER**

**Paperhanger**

Effective Period: 7/1/2016 - 6/30/2017

Wage Rate per Hour: **\$43.58**

Supplemental Benefit Rate per Hour: **\$30.73**

Supplemental Note: Supplemental benefits are to be paid at the appropriate straight time and overtime rate.

**Overtime**

Time and one half the regular rate after a 7 hour day.

Time and one half the regular rate for Saturday.

Time and one half the regular rate for Sunday.

**Overtime Holidays**

Time and one half the regular rate for work on the following holiday(s).

New Year's Day

President's Day

Memorial Day

Independence Day

Labor Day

Thanksgiving Day

Day after Thanksgiving

Christmas Day

**Paid Holidays**

None

**Shift Rates**

Evening shift - 4:30 P.M. to 12:00 Midnight (regular rate of pay); any work performed before 7:00 A.M. shall be at time and one half the regular base rate of pay.

OFFICE OF THE COMPTROLLER, CITY OF NEW YORK  
§220 PREVAILING WAGE SCHEDULE

(District Council of Painters #9)

---

---

## **PAVER AND ROADBUILDER**

### **Paver & Roadbuilder - Formsetter**

Effective Period: 7/1/2016 - 6/30/2017

Wage Rate per Hour: **\$45.35**

Supplemental Benefit Rate per Hour: **\$38.95**

### **Paver & Roadbuilder - Laborer**

Paving and road construction work, regardless of material used, including but not limited to preparation of job sites, removal of old surfaces, asphalt and/or concrete, by whatever method, including but not limited to milling; laying of concrete; laying of asphalt for temporary, patchwork, and utility paving (but not production paving); site preparation and incidental work before the installation of rubberized materials and similar surfaces; installation and repair of temporary construction fencing; slurry seal coating, maintenance of safety surfaces; play equipment installation, and other related work.

Effective Period: 7/1/2016 - 6/30/2017

Wage Rate per Hour: **\$41.48**

Supplemental Benefit Rate per Hour: **\$38.95**

### **Production Paver & Roadbuilder - Screed Person**

(Production paving is asphalt paving when using a paving machine or on a project where a paving machine is traditionally used)

Adjustment of paving machinery on production paving jobs.

Effective Period: 7/1/2016 - 6/30/2017

Wage Rate per Hour: **\$45.95**

Supplemental Benefit Rate per Hour: **\$38.95**

### **Production Paver & Roadbuilder - Raker**

Effective Period: 7/1/2016 - 6/30/2017

Wage Rate per Hour: **\$45.35**

Supplemental Benefit Rate per Hour: **\$38.95**

### **Production Paver & Roadbuilder - Shoveler**

General laborer (except removal of surfaces - see Paver and Roadbuilder-Laborer) including but not limited to tamper, AC paint and liquid tar work.

Effective Period: 7/1/2016 - 6/30/2017

OFFICE OF THE COMPTROLLER, CITY OF NEW YORK  
§220 PREVAILING WAGE SCHEDULE

Wage Rate per Hour: \$42.06

Supplemental Benefit Rate per Hour: \$38.95

### Overtime Description

If an employee works New Year's Day or Christmas Day, they receive the single time rate plus 25%.

### Overtime

Time and one half the regular rate after an 8 hour day.

Time and one half the regular rate for Saturday.

Double time the regular rate for Sunday.

### Overtime Holidays

Double time the regular rate for work on the following holiday(s).

Memorial Day

Independence Day

Labor Day

Columbus Day

Thanksgiving Day

### Shift Rates

When two shifts are employed, the work period for each shift shall be a continuous eight (8) hours. When three shifts are employed, each shift will work seven and one half (7 ½) hours but will be paid for eight (8) hours since only one half (1/2) hour is allowed for meal time.

When two or more shifts are employed, single time will be paid for each shift.

Night Work - On night work, the first eight (8) hours of work will be paid for at the single time rate, except that production paving work shall be paid at 10% over the single time rate for the screed person, rakers and shovelers directly involved only. This differential is to be paid when there is only one shift and the shift works at night. All other workers will be exempt. Hours worked over eight (8) hours during said shift shall be paid for at the time and one-half rate.

(Local #1010)

---

## PLASTERER

### Plasterer

Effective Period: 7/1/2016 - 6/30/2017

Wage Rate per Hour: \$43.93

Supplemental Benefit Rate per Hour: \$28.10

### Overtime

Time and one half the regular rate after a 7 hour day.

Time and one half the regular rate for Saturday.

Double time the regular rate for Sunday.



OFFICE OF THE COMPTROLLER, CITY OF NEW YORK  
§220 PREVAILING WAGE SCHEDULE

Saturday may be used as a make-up day at straight time when a day is lost during that week to inclement weather.

**Overtime Holidays**

Double time the regular rate for work on the following holiday(s).

New Year's Day  
Martin Luther King Jr. Day  
President's Day  
Good Friday  
Memorial Day  
Independence Day  
Labor Day  
Columbus Day  
Presidential Election Day  
Thanksgiving Day  
Christmas Day

**Paid Holidays**

None

**Shift Rates**

When it is not possible to conduct alteration work during regular work hours, in a building occupied by tenants, said work shall proceed on a shift basis; however work over seven (7) hours in any twenty four (24) hour period, the time after seven (7) hours shall be considered overtime.

The second shift shall start at a time between 3:30 p.m. and 7:00 p.m. and shall consist of seven (7) working hours and shall receive eight (8) hours of wages and benefits at the straight time rate. The workers on the second shift shall be allowed one-half (½) hour to eat with this time being included in the seven (7) hours of work.

(Local #262)

---

**PLASTERER - TENDER**

**Plasterer - Tender**

Effective Period: 7/1/2016 - 6/30/2017

Wage Rate per Hour: \$37.55

Supplemental Benefit Rate per Hour: \$29.04

**Overtime**

Time and one half the regular rate after an 8 hour day.

Time and one half the regular rate for Saturday.

Double time the regular rate for Sunday.

Saturday may be used as a make-up day at straight time when a day is lost during that week to inclement weather.

**Overtime Holidays**

OFFICE OF THE COMPTROLLER, CITY OF NEW YORK  
§220 PREVAILING WAGE SCHEDULE

Double time the regular rate for work on the following holiday(s).

New Year's Day  
Washington's Birthday  
Memorial Day  
Independence Day  
Labor Day  
Presidential Election Day  
Thanksgiving Day  
Christmas Day

**Paid Holidays**

None

**Shift Rates**

When work commences outside regular work hours, workers receive an hour additional (differential) wage and supplement payment. Eight hours pay for seven hours work or nine hours pay for eight hours work.

(Mason Tenders District Council)

---

---

**PLUMBER**

**Plumber**

Effective Period: 7/1/2016 - 6/30/2017

Wage Rate per Hour: **\$65.67**

Supplemental Benefit Rate per Hour: **\$29.28**

Supplemental Note: Overtime supplemental benefit rate per hour: **\$58.28**

**Plumber - Temporary Services**

Temporary Services - When there are no Plumbers on the job site, there may be three shifts designed to cover the entire twenty-four hour period, including weekends if necessary, at the following rate straight time.

Effective Period: 7/1/2016 - 6/30/2017

Wage Rate per Hour: **\$52.56**

Supplemental Benefit Rate per Hour: **\$23.40**

**Overtime Description**

Double time the regular rate after a 7 hour day - unless for new construction site work where the plumbing contract price is \$1.5 million or less, the hours of labor can be 8 hours per day at the employers option. On Alteration jobs when other mechanical trades at the site are working an eighth hour at straight time, then the plumber shall also work an eighth hour at straight time.

**Overtime**

Double time the regular time rate for Saturday.

Double time the regular rate for Sunday.

OFFICE OF THE COMPTROLLER, CITY OF NEW YORK  
§220 PREVAILING WAGE SCHEDULE

**Overtime Holidays**

Double time the regular rate for work on the following holiday(s).

New Year's Day  
President's Day  
Memorial Day  
Independence Day  
Labor Day  
Columbus Day  
Veteran's Day  
Thanksgiving Day  
Day after Thanksgiving  
Christmas Day

**Shift Rates**

Shift work, when directly specified in public agency or authority documents where plumbing contract is \$8 million or less, will be permitted. 30% shift premium shall be paid for wages and fringe benefits for 4:00 pm and midnight shifts Monday to Friday. 50% shift premium shall be paid for wages and fringe benefits for 4:00 pm and midnight shift work performed on weekends. For shift work on holidays, double time wages and fringe benefits shall be paid.

(Plumbers Local #1)

---

**PLUMBER (MECHANICAL EQUIPMENT AND SERVICE)**

(Mechanical Equipment and Service work shall include any repair and/or replacement of the present plumbing system.)

**Plumber**

Effective Period: 7/1/2016 - 6/30/2017

Wage Rate per Hour: **\$39.42**

Supplemental Benefit Rate per Hour: **\$14.19**

**Overtime**

Time and one half the regular rate after an 8 hour day.

Time and one half the regular rate for Saturday.

Time and one half the regular rate for Sunday.

**Overtime Holidays**

Time and one half the regular rate for work on the following holiday(s).

New Year's Day  
President's Day  
Memorial Day  
Independence Day  
Thanksgiving Day

OFFICE OF THE COMPTROLLER, CITY OF NEW YORK  
§220 PREVAILING WAGE SCHEDULE

Day after Thanksgiving  
Christmas Day

**Paid Holidays**

None

(Plumbers Local # 1)

---

---

**PLUMBER (RESIDENTIAL RATES FOR 1, 2 AND 3 FAMILY HOME  
CONSTRUCTION)**

Effective Period: 7/1/2016 - 6/30/2017

Wage Rate per Hour: \$45.47

Supplemental Benefit Rate per Hour: \$21.26

**Overtime**

Double time the regular rate after an 8 hour day.

Double time the regular time rate for Saturday.

Double time the regular rate for Sunday.

**Overtime Holidays**

Double time the regular rate for work on the following holiday(s).

New Year's Day

President's Day

Memorial Day

Independence Day

Labor Day

Columbus Day

Veteran's Day

Thanksgiving Day

Day after Thanksgiving

Christmas Day

**Paid Holidays**

None

**Shift Rates**

30% shift premium shall be paid for wages and fringe benefits for 4:00 pm and midnight shifts Monday to Friday.

50% shift premium shall be paid for wages and fringe benefits for 4:00 pm and midnight shift work performed on weekends. For shift work on holidays, double time wages and fringe benefits shall be paid.

(Plumbers Local #1)

---

---

OFFICE OF THE COMPTROLLER, CITY OF NEW YORK  
§220 PREVAILING WAGE SCHEDULE

**PLUMBER: PUMP & TANK**  
**Oil Trades (Installation and Maintenance)**

**Plumber - Pump & Tank**

Effective Period: 7/1/2016 - 6/30/2017

Wage Rate per Hour: \$63.52

Supplemental Benefit Rate per Hour: \$22.91

**Overtime**

Time and one half the regular rate after an 8 hour day.

Time and one half the regular rate for Saturday.

Time and one half the regular rate for Sunday.

**Overtime Holidays**

Time and one half the regular rate for work on the following holiday(s).

New Year's Day

President's Day

Memorial Day

Independence Day

Labor Day

Columbus Day

Veteran's Day

Thanksgiving Day

Day after Thanksgiving

Christmas Day

**Paid Holidays**

None

**Shift Rates**

All work outside the regular workday (8:00 A.M. to 3:30 P.M.) is to be paid at time and one half the regular hourly rate

(Plumbers Local #1)

---

**POINTER, WATERPROOFER, CAULKER, SANDBLASTER,  
STEAMBLASTER**  
**(Exterior Building Renovation)**

**Journey person**

OFFICE OF THE COMPTROLLER, CITY OF NEW YORK  
§220 PREVAILING WAGE SCHEDULE

Effective Period: 7/1/2016 - 6/30/2017

Wage Rate per Hour: \$50.04

Supplemental Benefit Rate per Hour: \$26.15

**Overtime**

Time and one half the regular rate after an 8 hour day.

Time and one half the regular rate for Saturday.

Time and one half the regular rate for Sunday.

Saturday may be used as a make-up day at straight time when a day is lost during that week to inclement weather.

**Overtime Holidays**

Time and one half the regular rate for work on the following holiday(s).

New Year's Day

Martin Luther King Jr. Day

President's Day

Memorial Day

Independence Day

Labor Day

Thanksgiving Day

Christmas Day

**Paid Holidays**

None

**Shift Rates**

All work outside the regular work day (an eight hour workday between the hours of 6:00 A.M. and 4:30 P.M.) is to be paid at time and one half the regular rate.

(Bricklayer District Council)

---

---

**ROOFER**

**Roofer**

Effective Period: 7/1/2016 - 6/30/2017

Wage Rate per Hour: \$40.70

Supplemental Benefit Rate per Hour: \$30.17

**Overtime**

Time and one half the regular rate after an 8 hour day.

Time and one half the regular rate for Saturday.

Time and one half the regular rate for Sunday.

**Overtime Holidays**

PUBLISH DATE: 7/1/2016

EFFECTIVE PERIOD: JULY 1, 2016 THROUGH JUNE 30, 2017

Page 71 of 87

OFFICE OF THE COMPTROLLER, CITY OF NEW YORK  
\$220 PREVAILING WAGE SCHEDULE

Time and one half the regular rate for work on the following holiday(s).

New Year's Day  
President's Day  
Memorial Day  
Independence Day  
Labor Day  
Presidential Election Day  
Thanksgiving Day  
Christmas Day

**Paid Holidays**

None

**Shift Rates**

Second shift - Regular hourly rate plus a 10% differential. Third shift - Regular hourly rate plus a 15% differential.

(Local #8)

---

---

**SHEET METAL WORKER**

**Sheet Metal Worker**

Effective Period: 7/1/2016 - 6/30/2017

Wage Rate per Hour: **\$47.70**

Supplemental Benefit Rate per Hour: **\$46.45**

Supplemental Note: Supplemental benefit contributions are to be made at the applicable overtime rates.

**Sheet Metal Worker - Fan Maintenance**

(The temporary operation of fans or blowers in new or existing buildings for heating and/or ventilation, and/or air conditioning prior to the completion of the project.)

Effective Period: 7/1/2016 - 6/30/2017

Wage Rate per Hour: **\$38.16**

Supplemental Benefit Rate per Hour: **\$46.45**

**Sheet Metal Worker - Duct Cleaner**

Effective Period: 7/1/2016 - 6/30/2017

Wage Rate per Hour: **\$12.90**

Supplemental Benefit Rate per Hour: **\$8.07**

**Overtime**

Time and one half the regular rate after an 8 hour day.

Time and one half the regular rate for Saturday.

Double time the regular rate for Sunday.

OFFICE OF THE COMPTROLLER, CITY OF NEW YORK  
§220 PREVAILING WAGE SCHEDULE

**Overtime Holidays**

Double time the regular rate for work on the following holiday(s).

New Year's Day  
Martin Luther King Jr. Day  
President's Day  
Memorial Day  
Independence Day  
Labor Day  
Columbus Day  
Veteran's Day  
Thanksgiving Day  
Day after Thanksgiving  
Christmas Day

**Paid Holidays**

None

**Shift Rates**

Work that can only be performed outside regular working hours (eight hours of work between 7:30 A.M. and 3:30 P.M.) - First shift (work between 3:30 P.M. and 11:30 P.M.) - 10% differential above the established hourly rate.  
Second shift (work between 11:30 P.M. and 7:30 A.M.) - 15% differential above the established hourly rate.

For Fan Maintenance: On all full shifts of fan maintenance work the straight time hourly rate of pay will be paid for each shift, including nights, Saturdays, Sundays, and holidays.

(Local #28)

---

---

**SHEET METAL WORKER - SPECIALTY  
(Decking & Siding)**

**Sheet Metal Specialty Worker**

The first worker to perform this work must be paid at the rate of the Sheet Metal Worker. The second and third workers shall be paid the Specialty Worker Rate. The ratio of One Sheet Metal Worker, then Two Specialty Workers shall be utilized thereafter.

Effective Period: 7/1/2016 - 6/30/2017

Wage Rate per Hour: \$43.25

Supplemental Benefit Rate per Hour: \$24.41

Supplemental Note: Supplemental benefit contributions are to be made at the applicable overtime rates.

**Overtime**

Time and one half the regular rate after an 8 hour day.

Time and one half the regular rate for Saturday.

Double time the regular rate for Sunday.



OFFICE OF THE COMPTROLLER, CITY OF NEW YORK  
§220 PREVAILING WAGE SCHEDULE

**Overtime Holidays**

Double time the regular rate for work on the following holiday(s).

New Year's Day  
Martin Luther King Jr. Day  
President's Day  
Memorial Day  
Independence Day  
Labor Day  
Columbus Day  
Veteran's Day  
Thanksgiving Day  
Christmas Day

**Paid Holidays**

None

(Local #28)

---

---

**SHIPYARD WORKER**

**Shipyard Mechanic - First Class**

Effective Period: 7/1/2016 - 6/30/2017  
Wage Rate per Hour: \$28.33  
Supplemental Benefit Rate per Hour: \$3.04

**Shipyard Mechanic - Second Class**

Effective Period: 7/1/2016 - 6/30/2017  
Wage Rate per Hour: \$22.18  
Supplemental Benefit Rate per Hour: \$2.80

**Shipyard Laborer - First Class**

Effective Period: 7/1/2016 - 6/30/2017  
Wage Rate per Hour: \$20.45  
Supplemental Benefit Rate per Hour: \$2.74

**Shipyard Laborer - Second Class**

Effective Period: 7/1/2016 - 6/30/2017  
Wage Rate per Hour: \$14.36  
Supplemental Benefit Rate per Hour: \$2.50

OFFICE OF THE COMPTROLLER, CITY OF NEW YORK  
§220 PREVAILING WAGE SCHEDULE

**Shipyard Dockhand - First Class**

Effective Period: 7/1/2016 - 6/30/2017

Wage Rate per Hour: \$22.70

Supplemental Benefit Rate per Hour: \$2.82

**Shipyard Dockhand - Second Class**

Effective Period: 7/1/2016 - 6/30/2017

Wage Rate per Hour: \$16.01

Supplemental Benefit Rate per Hour: \$2.57

**Overtime Description**

Work performed on holiday is paid double time the regular hourly wage rate plus holiday pay.

**Overtime**

Time and one half the regular rate after an 8 hour day.

Time and one half the regular rate for Saturday.

Double time the regular rate for Sunday.

Time and one half the regular hourly rate after 40 hours in any work week.

**Paid Holidays**

New Year's Day

Martin Luther King Jr. Day

President's Day

Good Friday

Memorial Day

Independence Day

Labor Day

Thanksgiving Day

Day after Thanksgiving

Christmas Day

Based on Survey Data

---

**SIGN ERECTOR**

(Sheet Metal, Plastic, Electric, and Neon)

**Sign Erector**

Effective Period: 7/1/2016 - 6/30/2017

Wage Rate per Hour: \$46.85

Supplemental Benefit Rate per Hour: \$48.57

OFFICE OF THE COMPTROLLER, CITY OF NEW YORK  
§220 PREVAILING WAGE SCHEDULE

**Overtime**

Time and one half the regular rate after a 7 hour day.

Time and one half the regular rate for Saturday.

Time and one half the regular rate for Sunday.

Time and one half the regular rate for work on the following holiday(s).

**Paid Holidays**

New Year's Day

Washington's Birthday

Memorial Day

Independence Day

Labor Day

Columbus Day

Election Day

Thanksgiving Day

Day after Thanksgiving

Christmas Day

**Shift Rates**

Time and one half the regular hourly rate is to be paid for all hours worked outside the regular workday either (7:00 A.M. through 2:30 P.M.) or (8:00 A.M. through 3:30 P.M.)

(Local #137)

---

---

**STEAMFITTER**

**Steamfitter I**

Effective Period: 7/1/2016 - 6/30/2017

Wage Rate per Hour: \$55.50

Supplemental Benefit Rate per Hour: \$54.29

Supplemental Note: Overtime supplemental benefit rate: \$107.84

**Steamfitter -Temporary Services**

The steamfitters shall not do any other work and shall not be permitted to work more than one shift in a twenty-four hour day. When steamfitters are present during the regular working day, no temporary services steamfitter will be required

Effective Period: 7/1/2016 - 6/30/2017

Wage Rate per Hour: \$42.18

Supplemental Benefit Rate per Hour: \$44.08

**Overtime**

Double time the regular rate after a 7 hour day.

Double time the regular time rate for Saturday.

OFFICE OF THE COMPTROLLER, CITY OF NEW YORK  
§220 PREVAILING WAGE SCHEDULE

Double time the regular rate for Sunday.

### **Overtime Holidays**

Double time the regular rate for work on the following holiday(s).

New Year's Day  
President's Day  
Memorial Day  
Independence Day  
Labor Day  
Columbus Day  
Veteran's Day  
Thanksgiving Day  
Day after Thanksgiving  
Christmas Day

### **Paid Holidays**

None

### **Shift Rates**

Work performed between 3:30 P.M. and 7:00 A.M. and on Saturdays, Sundays and Holidays shall be at double time the regular hourly rate and paid at the overtime supplemental benefit rate above.

---

### **Steamfitter II**

For heating, ventilation, air conditioning and mechanical public works contracts with a dollar value not to exceed \$15,000,000 and for fire protection/sprinkler public works contracts not to exceed \$1,500,000.

Effective Period: 7/1/2016 - 6/30/2017

Wage Rate per Hour: \$55.50

Supplemental Benefit Rate per Hour: \$54.29

Supplemental Note: Overtime supplemental benefit rate: \$107.84

### **Steamfitter -Temporary Services**

The steamfitters shall not do any other work and shall not be permitted to work more than one shift in a twenty-four hour day. When steamfitters are present during the regular working day, no temporary services steamfitter will be required.

Effective Period: 7/1/2016 - 6/30/2017

Wage Rate per Hour: \$42.18

Supplemental Benefit Rate per Hour: \$44.08

### **Overtime**

Double time the regular rate after an 8 hour day.

Double time the regular time rate for Saturday.

Double time the regular rate for Sunday.

### **Overtime Holidays**

OFFICE OF THE COMPTROLLER, CITY OF NEW YORK  
§220 PREVAILING WAGE SCHEDULE

Double time the regular rate for work on the following holiday(s).

New Year's Day  
President's Day  
Memorial Day  
Independence Day  
Labor Day  
Columbus Day  
Veteran's Day  
Thanksgiving Day  
Day after Thanksgiving  
Christmas Day

**Paid Holidays**

None

**Shift Rates**

May be performed outside of the regular workday except Saturday, Sunday and Holidays. A shift shall consist of eight working hours. All work performed in excess of eight hours shall be paid at double time. No shift shall commence after 7:00 P.M. on Friday or 7:00 P.M. the day before holidays. All work performed after 12:01 A.M. Saturday or 12:01 A.M. the day before a Holiday will be paid at double time. When shift work is performed the wage rate for regular time worked is a thirty percent premium together with fringe benefits.

On Transit Authority projects, where work is performed in the vicinity of tracks all shift work on weekends and holidays may be performed at the regular shift rates.

Local #638

---

**STEAMFITTER - REFRIGERATION AND AIR CONDITIONER  
(Maintenance and Installation Service Person)**

**Refrigeration and Air Conditioner Mechanic**

Effective Period: 7/1/2016 - 6/30/2017

Wage Rate per Hour: \$39.50

Supplemental Benefit Rate per Hour: \$15.06

**Refrigeration and Air Conditioner Service Person V**

Effective Period: 7/1/2016 - 6/30/2017

Wage Rate per Hour: \$32.46

Supplemental Benefit Rate per Hour: \$13.53

**Refrigeration and Air Conditioner Service Person IV**

Effective Period: 7/1/2016 - 6/30/2017

OFFICE OF THE COMPTROLLER, CITY OF NEW YORK  
\$220 PREVAILING WAGE SCHEDULE

Wage Rate per Hour: \$26.89

Supplemental Benefit Rate per Hour: \$12.26

**Refrigeration and Air Conditioner Service Person III**

Filter changing and maintenance thereof, oil and greasing, tower and coil cleaning, scraping and painting, general housekeeping, taking of water samples.

Effective Period: 7/1/2016 - 6/30/2017

Wage Rate per Hour: \$23.08

Supplemental Benefit Rate per Hour: \$11.31

**Refrigeration and Air Conditioner Service Person II**

Filter changing and maintenance thereof, oil and greasing, tower and coil cleaning, scraping and painting, general housekeeping, taking of water samples.

Effective Period: 7/1/2016 - 6/30/2017

Wage Rate per Hour: \$19.14

Supplemental Benefit Rate per Hour: \$10.43

**Refrigeration and Air Conditioner Service Person I**

Filter changing and maintenance thereof, oil and greasing, tower and coil cleaning, scraping and painting, general housekeeping, taking of water samples.

Effective Period: 7/1/2016 - 6/30/2017

Wage Rate per Hour: \$14.00

Supplemental Benefit Rate per Hour: \$9.46

**Overtime**

Time and one half the regular rate after an 8 hour day.

Time and one half the regular rate for Saturday.

Double time the regular rate for Sunday.

**Overtime Holidays**

Double time the regular rate for work on the following holiday(s).

New Year's Day

Independence Day

Labor Day

Veteran's Day

Thanksgiving Day

Christmas Day

Double time and one half the regular rate for work on the following holiday(s).

Martin Luther King Jr. Day

President's Day

Memorial Day

Columbus Day

**Paid Holidays**

OFFICE OF THE COMPTROLLER, CITY OF NEW YORK  
§220 PREVAILING WAGE SCHEDULE

New Year's Day  
Martin Luther King Jr. Day  
President's Day  
Memorial Day  
Independence Day  
Labor Day  
Columbus Day  
Veteran's Day  
Thanksgiving Day  
Christmas Day

(Local #638B)

---

---

## **STONE MASON - SETTER**

### **Stone Mason - Setters**

Effective Period: 7/1/2016 - 6/30/2017

Wage Rate per Hour: \$51.08

Supplemental Benefit Rate per Hour: \$38.10

### **Overtime**

Time and one half the regular rate after a 7 hour day.

Time and one half the regular rate for Saturday.

Double time the regular rate for Sunday.

### **Overtime Holidays**

Double time the regular rate for work on the following holiday(s).

New Year's Day

Washington's Birthday

Good Friday

Memorial Day

Independence Day

Labor Day

Thanksgiving Day

Christmas Day

### **Paid Holidays**

1/2 day on Christmas Eve if work is performed in the A.M.

### **Shift Rates**

For all work outside the regular workday (8:00 A.M. to 3:30 P.M. Monday through Friday), the pay shall be straight time plus a ten percent (10%) differential.

(Bricklayers District Council)

---

OFFICE OF THE COMPTROLLER, CITY OF NEW YORK  
§220 PREVAILING WAGE SCHEDULE

---

## **TAPER**

### **Drywall Taper**

Effective Period: 7/1/2016 - 12/27/2016

Wage Rate per Hour: \$47.32

Supplemental Benefit Rate per Hour: \$22.68

Effective Period: 12/28/2016 - 6/30/2017

Wage Rate per Hour: \$47.82

Supplemental Benefit Rate per Hour: \$22.68

### **Overtime**

Time and one half the regular rate after a 7 hour day.

Time and one half the regular rate for Saturday.

Time and one half the regular rate for Sunday.

### **Overtime Holidays**

Time and one half the regular rate for work on the following holiday(s).

New Year's Day

Martin Luther King Jr. Day

President's Day

Good Friday

Memorial Day

Independence Day

Labor Day

Columbus Day

Thanksgiving Day

Christmas Day

### **Paid Holidays**

Any worker who reports to work on Christmas Eve or New Year's Eve pursuant to his employer's instruction shall be entitled to three (3) hours afternoon pay without working.

### **Shift Rates**

Time and one half the regular rate outside the regular work hours (8:00 A.M. through 3:30 P.M.)

(Local #1974)

---

## **TELECOMMUNICATION WORKER (Voice Installation Only)**



OFFICE OF THE COMPTROLLER, CITY OF NEW YORK  
§220 PREVAILING WAGE SCHEDULE

**Telecommunication Worker**

Effective Period: 7/1/2016 - 6/30/2017

Wage Rate per Hour: **\$40.35**

Supplemental Benefit Rate per Hour: **\$13.19**

Supplemental Note: The above rate applies for Manhattan, Bronx, Brooklyn, Queens. \$12.64 for Staten Island only.

**Overtime**

Time and one half the regular rate after a 7 hour day.

Time and one half the regular rate for Saturday.

Time and one half the regular rate for Sunday.

**Overtime Holidays**

Time and one half the regular rate for work on the following holiday(s).

New Year's Day

Lincoln's Birthday

Washington's Birthday

Memorial Day

Independence Day

Labor Day

Columbus Day

Election Day

Veteran's Day

Thanksgiving Day

Christmas Day

**Paid Holidays**

New Year's Day

Lincoln's Birthday

Washington's Birthday

Memorial Day

Independence Day

Labor Day

Columbus Day

Election Day

Veteran's Day

Thanksgiving Day

Christmas Day

Employees have the option of observing either Martin Luther King's Birthday or the day after Thanksgiving instead of Lincoln's Birthday

**Shift Rates**

For any workday that starts before 8A.M. or ends after 6P.M. there is a 10% differential for the applicable worker's hourly rate.

**Vacation**

After 6 months.....one week.

After 12 months but less than 7 years.....two weeks.

After 7 or more but less than 15 years.....three weeks.

After 15 years or more but less than 25 years.....four weeks.

OFFICE OF THE COMPTROLLER, CITY OF NEW YORK  
\$220 PREVAILING WAGE SCHEDULE

(C.W.A.)

---

---

## TILE FINISHER

### Tile Finisher

Effective Period: 7/1/2016 - 6/30/2017

Wage Rate per Hour: **\$40.69**

Supplemental Benefit Rate per Hour: **\$30.58**

### **Overtime**

Time and one half the regular rate after a 7 hour day.

Time and one half the regular rate for Saturday.

Double time the regular rate for Sunday.

### **Overtime Holidays**

Double time the regular rate for work on the following holiday(s).

New Year's Day

President's Day

Good Friday

Memorial Day

Independence Day

Labor Day

Columbus Day

Veteran's Day

Thanksgiving Day

Day after Thanksgiving

Christmas Day

### **Paid Holidays**

None

### **Shift Rates**

Off shift work day (work performed outside the regular 8:00 A.M. to 3:30 P.M. workday): shift differential of one and one quarter (1¼) times the regular straight time rate of pay for the seven hours of actual off-shift work.

(Local #7)

---

---

## TILE LAYER - SETTER

### Tile Layer - Setter

PUBLISH DATE: 7/1/2016

EFFECTIVE PERIOD: JULY 1, 2016 THROUGH JUNE 30, 2017

Page 83 of 87

OFFICE OF THE COMPTROLLER, CITY OF NEW YORK  
§220 PREVAILING WAGE SCHEDULE

Effective Period: 7/1/2016 - 6/30/2017

Wage Rate per Hour: \$52.68

Supplemental Benefit Rate per Hour: \$34.48

**Overtime**

Time and one half the regular rate after a 7 hour day.

Time and one half the regular rate for Saturday.

Double time the regular rate for Sunday.

**Overtime Holidays**

Double time the regular rate for work on the following holiday(s).

New Year's Day

President's Day

Good Friday

Memorial Day

Independence Day

Labor Day

Columbus Day

Veteran's Day

Thanksgiving Day

Day after Thanksgiving

Christmas Day

**Shift Rates**

Off shift work day (work performed outside the regular 8:00 A.M. to 3:30 P.M. workday): shift differential of one and one quarter (1¼) times the regular straight time rate of pay for the seven hours of actual off-shift work.

(Local #7)

---

---

**TIMBERPERSON**

**Timberperson**

Effective Period: 7/1/2016 - 6/30/2017

Wage Rate per Hour: \$46.99

Supplemental Benefit Rate per Hour: \$48.26

**Overtime**

Time and one half the regular rate after an 8 hour day.

Time and one half the regular rate for Saturday.

Double time the regular rate for Sunday.

Saturday may be used as a make-up day at straight time when a day is lost during that week to inclement weather.

Time and one half the regular hourly rate after 40 hours in any work week.

OFFICE OF THE COMPTROLLER, CITY OF NEW YORK  
§220 PREVAILING WAGE SCHEDULE

**Overtime Holidays**

Double time the regular rate for work on the following holiday(s).

New Year's Day  
President's Day  
Memorial Day  
Independence Day  
Labor Day  
Columbus Day  
Presidential Election Day  
Thanksgiving Day  
Christmas Day

**Paid Holidays**

None

**Shift Rates**

Off shift work commencing between 5:00 P.M. and 11:00 P.M. shall work eight and one half hours allowing for one half hour for lunch. The wage rate shall be 113% of the straight time hourly wage rate.

(Local #1536)

---

**TUNNEL WORKER**

**Blasters, Mucking Machine Operators (Compressed Air Rates)**

Effective Period: 7/1/2016 - 6/30/2017

Wage Rate per Hour: \$60.97

Supplemental Benefit Rate per Hour: \$50.72

**Tunnel Workers (Compressed Air Rates)**

Effective Period: 7/1/2016 - 6/30/2017

Wage Rate per Hour: \$58.86

Supplemental Benefit Rate per Hour: \$49.03

**Top Nipper (Compressed Air Rates)**

Effective Period: 7/1/2016 - 6/30/2017

Wage Rate per Hour: \$57.78

Supplemental Benefit Rate per Hour: \$48.16

**Outside Lock Tender, Outside Gauge Tender, Muck Lock Tender (Compressed Air Rates)**

Effective Period: 7/1/2016 - 6/30/2017

OFFICE OF THE COMPTROLLER, CITY OF NEW YORK  
§220 PREVAILING WAGE SCHEDULE

Wage Rate per Hour: \$56.74  
Supplemental Benefit Rate per Hour: \$47.25

**Bottom Bell & Top Bell Signal Person: Shaft Person (Compressed Air Rates)**

Effective Period: 7/1/2016 - 6/30/2017  
Wage Rate per Hour: \$56.74  
Supplemental Benefit Rate per Hour: \$47.25

**Changehouse Attendant: Powder Watchperson (Compressed Air Rates)**

Effective Period: 7/1/2016 - 6/30/2017  
Wage Rate per Hour: \$49.69  
Supplemental Benefit Rate per Hour: \$44.69

**Blasters (Free Air Rates)**

Effective Period: 7/1/2016 - 6/30/2017  
Wage Rate per Hour: \$58.19  
Supplemental Benefit Rate per Hour: \$48.68

**Tunnel Workers (Free Air Rates)**

Effective Period: 7/1/2016 - 6/30/2017  
Wage Rate per Hour: \$55.69  
Supplemental Benefit Rate per Hour: \$46.61

**All Others (Free Air Rates)**

Effective Period: 7/1/2016 - 6/30/2017  
Wage Rate per Hour: \$51.45  
Supplemental Benefit Rate per Hour: \$43.13

**Microtunneling (Free Air Rates)**

Effective Period: 7/1/2016 - 6/30/2017  
Wage Rate per Hour: \$44.55  
Supplemental Benefit Rate per Hour: \$37.29

**Overtime Description**

For Repair-Maintenance Work on Existing Equipment and Facilities - Time and one half the regular rate after a 7 hour day, or for Saturday, or for Sunday. Double time the regular rate for work on a holiday.  
For Small-Bore Micro Tunneling Machines - Time and one-half the regular rate shall be paid for all overtime.

**Overtime**

Double time the regular rate after an 8 hour day.  
Double time the regular time rate for Saturday.  
Double time the regular rate for Sunday.  
Double time the regular rate for work on the following holiday(s).

OFFICE OF THE COMPTROLLER, CITY OF NEW YORK  
§220 PREVAILING WAGE SCHEDULE

**Paid Holidays**

New Year's Day  
Lincoln's Birthday  
President's Day  
Memorial Day  
Independence Day  
Labor Day  
Columbus Day  
Election Day  
Veteran's Day  
Thanksgiving Day  
Christmas Day

(Local #147)

---

---

**WELDER**

**TO BE PAID AT THE RATE OF THE JOURNEYPERSON IN THE TRADE  
PERFORMING THE WORK.**

**(NO TEXT THIS PAGE)**

**OFFICE OF THE COMPTROLLER**

**CITY OF NEW YORK**

**220 APPRENTICESHIP PREVAILING WAGE SCHEDULE**

**APPENDIX**

Pursuant to Labor Law §220 (3-e), only apprentices who are individually registered in a bona fide program to which the employer contractor is a participant and registered with the New York State Department of Labor, may be employed on a public work project.

Any employee listed on a payroll at an apprentice wage rate, who is not registered as above, shall be paid the journey person wage rate for the classification of work he actually performed.

Apprentice ratios are established to ensure the proper safety, training and supervision of apprentices. A ratio establishes the number of journey workers required for each apprentice in a program and on a job site. Ratios are interpreted as follows: in the case of a 1:1, 1:4 ratio, there must be one journey worker for the first apprentice, and four additional journey workers for each subsequent apprentice.



OFFICE OF THE COMPTROLLER, CITY OF NEW YORK  
 §220 APPRENTICESHIP PREVAILING WAGE SCHEDULE

**TABLE OF CONTENTS**

<b><u>CLASSIFICATION</u></b>	<b><u>PAGE</u></b>
ASBESTOS HANDLER .....	3
BOILERMAKER.....	3
BRICKLAYER.....	4
CARPENTER .....	5
CEMENT MASON.....	6
CEMENT AND CONCRETE WORKER .....	7
DERRICKPERSON & RIGGER (STONE) .....	8
DOCKBUILDER/PILE DRIVER .....	8
ELECTRICIAN .....	9
ELEVATOR CONSTRUCTOR.....	12
ELEVATOR REPAIR & MAINTENANCE .....	13
ENGINEER.....	14
ENGINEER - OPERATING .....	14
FLOOR COVERER .....	15
GLAZIER.....	16
HEAT & FROST INSULATOR.....	16
HOUSE WRECKER .....	17
IRON WORKER - ORNAMENTAL .....	18
IRON WORKER - STRUCTURAL .....	18
LABORER (FOUNDATION, CONCRETE, EXCAVATING, STREET PIPE LAYER & COMMON).....	19
MARBLE MECHANICS .....	20
MASON TENDER .....	21
METALLIC LATHER.....	22
MILLWRIGHT.....	22
PAVER AND ROADBUILDER.....	23
PAINTER.....	24
PAINTER - METAL POLISHER.....	25
PAINTER - STRUCTURAL STEEL .....	25
PLASTERER.....	26
PLASTERER - TENDER.....	27
PLUMBER.....	27
POINTER, WATERPROOFER, CAULKER, SANDBLASTER, STEAMBLASTER .....	29
ROOFER .....	29
SHEET METAL WORKER.....	30
SIGN ERECTOR .....	31
STEAMFITTER .....	32
STONE MASON - SETTER .....	33
TAPER .....	34
TILE LAYER - SETTER .....	35
TIMBERPERSON.....	35

OFFICE OF THE COMPTROLLER, CITY OF NEW YORK  
§220 APPRENTICESHIP PREVAILING WAGE SCHEDULE

**ASBESTOS HANDLER**

(Ratio of Apprentice Journeyman: 1 to 1, 1 to 3)

**Asbestos Handler (First 1000 Hours)**

Effective Period: 7/1/2016 - 6/30/2017  
Wage Rate Per Hour: 78% of Journeyman's rate  
Supplemental Benefit Rate Per Hour: \$16.45

**Asbestos Handler (Second 1000 Hours)**

Effective Period: 7/1/2016 - 6/30/2017  
Wage Rate Per Hour: 80% of Journeyman's rate  
Supplemental Benefit Rate Per Hour: \$16.45

**Asbestos Handler (Third 1000 Hours)**

Effective Period: 7/1/2016 - 6/30/2017  
Wage Rate Per Hour: 83% of Journeyman's rate  
Supplemental Benefit Rate Per Hour: \$16.45

**Asbestos Handler (Fourth 1000 Hours)**

Effective Period: 7/1/2016 - 6/30/2017  
Wage Rate Per Hour: 89% of Journeyman's rate  
Supplemental Benefit Rate Per Hour: \$16.45

(Local #78)

---

---

**BOILERMAKER**

(Ratio of Apprentice to Journeyman: 1 to 1, 1 to 3)

**Boilermaker (First Year)**

Effective Period: 7/1/2016 - 6/30/2017  
Wage Rate Per Hour: 65% of Journeyman's rate  
Supplemental Benefit Rate Per Hour: \$30.43  
Effective 1/1/2017 - Supplemental Benefit Rate Per Hour: \$30.84

**Boilermaker (Second Year: 1st Six Months)**

Effective Period: 7/1/2016 - 6/30/2017

OFFICE OF THE COMPTROLLER, CITY OF NEW YORK  
\$220 APPRENTICESHIP PREVAILING WAGE SCHEDULE

Wage Rate Per Hour: 70% of Journeyperson's rate  
Supplemental Benefit Rate Per Hour: \$32.13  
Effective 1/1/2017 - Supplemental Benefit Rate Per Hour: \$32.57

**Boilermaker (Second Year: 2nd Six Months)**

Effective Period: 7/1/2016 - 6/30/2017  
Wage Rate Per Hour: 75% of Journeyperson's rate  
Supplemental Benefit Rate Per Hour: \$33.82  
Effective 1/1/2017 - Supplemental Benefit Rate Per Hour: \$34.29

**Boilermaker (Third Year: 1st Six Months)**

Effective Period: 7/1/2016 - 6/30/2017  
Wage Rate Per Hour: 80% of Journeyperson's rate  
Supplemental Benefit Rate Per Hour: \$35.53  
Effective 1/1/2017 - Supplemental Benefit Rate Per Hour: \$36.03

**Boilermaker (Third Year: 2nd Six Months)**

Effective Period: 7/1/2016 - 6/30/2017  
Wage Rate Per Hour: 85% of Journeyperson's rate  
Supplemental Benefit Rate Per Hour: \$37.23  
Effective 1/1/2017 - Supplemental Benefit Rate Per Hour: \$37.76

**Boilermaker (Fourth Year: 1st Six Months)**

Effective Period: 7/1/2016 - 6/30/2017  
Wage Rate Per Hour: 90% of Journeyperson's rate  
Supplemental Benefit Rate Per Hour: \$38.93  
Effective 1/1/2017 - Supplemental Benefit Rate Per Hour: \$39.51

**Boilermaker (Fourth Year: 2nd Six Months)**

Effective Period: 7/1/2016 - 6/30/2017  
Wage Rate Per Hour: 95% of Journeyperson's rate  
Supplemental Benefit Rate Per Hour: \$40.63  
Effective 1/1/2017 - Supplemental Benefit Rate Per Hour: \$41.22

(Local #5)

---

---

**BRICKLAYER**

(Ratio of Apprentice to Journeyperson: 1 to 1, 1 to 4)

**Bricklayer (First 750 Hours)**

OFFICE OF THE COMPTROLLER, CITY OF NEW YORK  
§220 APPRENTICESHIP PREVAILING WAGE SCHEDULE

Effective Period: 7/1/2016 - 6/30/2017  
Wage Rate Per Hour: 50% of Journeyman's rate  
Supplemental Benefit Rate Per Hour: \$18.35

**Bricklayer (Second 750 Hours)**

Effective Period: 7/1/2016 - 6/30/2017  
Wage Rate Per Hour: 60% of Journeyman's rate  
Supplemental Benefit Rate Per Hour: \$18.35

**Bricklayer (Third 750 Hours)**

Effective Period: 7/1/2016 - 6/30/2017  
Wage Rate Per Hour: 70% of Journeyman's rate  
Supplemental Benefit Rate Per Hour: \$18.35

**Bricklayer (Fourth 750 Hours)**

Effective Period: 7/1/2016 - 6/30/2017  
Wage Rate Per Hour: 80% of Journeyman's rate  
Supplemental Benefit Rate Per Hour: \$18.35

**Bricklayer (Fifth 750 Hours)**

Effective Period: 7/1/2016 - 6/30/2017  
Wage Rate Per Hour: 90% of Journeyman's rate  
Supplemental Benefit Rate Per Hour: \$18.35

**Bricklayer (Sixth 750 Hours)**

Effective Period: 7/1/2016 - 6/30/2017  
Wage Rate Per Hour: 95% of Journeyman's rate  
Supplemental Benefit Rate Per Hour: \$18.35

(Bricklayer District Council)

---

---

**CARPENTER**

(Ratio of Apprentice to Journeyman: 1 to 1, 1 to 4)

**Carpenter (First Year)**

Effective Period: 7/1/2016 - 6/30/2017  
Wage Rate Per Hour: 40% of Journeyman's rate  
Supplemental Benefit Rate Per Hour For Building Apprentice: \$31.34

OFFICE OF THE COMPTROLLER, CITY OF NEW YORK  
\$220 APPRENTICESHIP PREVAILING WAGE SCHEDULE

Supplemental Benefit Rate Per Hour For Heavy Apprentice: \$32.52

**Carpenter (Second Year)**

Effective Period: 7/1/2016 - 6/30/2017

Wage Rate Per Hour: 50% of Journeyman's rate

Supplemental Benefit Rate Per Hour For Building Apprentice: \$31.34

Supplemental Benefit Rate Per Hour For Heavy Apprentice: \$32.52

**Carpenter (Third Year)**

Effective Period: 7/1/2016 - 6/30/2017

Wage Rate Per Hour: 65% of Journeyman's rate

Supplemental Benefit Rate Per Hour For Building Apprentice: \$31.34

Supplemental Benefit Rate Per Hour For Heavy Apprentice: \$32.52

**Carpenter (Fourth Year)**

Effective Period: 7/1/2016 - 6/30/2017

Wage Rate Per Hour: 80% of Journeyman's rate

Supplemental Benefit Rate Per Hour For Building Apprentice: \$31.34

Supplemental Benefit Rate Per Hour For Heavy Apprentice: \$32.52

(Carpenters District Council)

---

**CEMENT MASON**

(Ratio of Apprentice to Journeyman: 1 to 1, 1 to 4)

**Cement Mason (First Year)**

Effective Period: 7/1/2016 - 6/30/2017

Wage and Supplemental Rate Per Hour: 50% of Journeyman's Rate

**Cement Mason (Second Year)**

Effective Period: 7/1/2016 - 6/30/2017

Wage and Supplemental Rate Per Hour: 60% of Journeyman's Rate

**Cement Mason (Third Year)**

Effective Period: 7/1/2016 - 6/30/2017

Wage and Supplemental Rate Per Hour: 70% of Journeyman's Rate

(Local #780)

OFFICE OF THE COMPTROLLER, CITY OF NEW YORK  
§220 APPRENTICESHIP PREVAILING WAGE SCHEDULE

---

---

**CEMENT AND CONCRETE WORKER**  
(Ratio of Apprentice to Journeyman: 1 to 1, 1 to 3)

**Cement & Concrete Worker (First 1333 hours)**

Effective Period: 7/1/2016 - 6/30/2017  
Wage Rate Per Hour: 50% of Journeyman's rate  
Supplemental Benefit Rate Per Hour: \$16.25

**Cement & Concrete Worker (Second 1333 hours)**

Effective Period: 7/1/2016 - 6/30/2017  
Wage Rate Per Hour: 65% of Journeyman's rate  
Supplemental Benefit Rate Per Hour: \$21.08

**Cement & Concrete Worker (Last 1334 hours)**

Effective Period: 7/1/2016 - 6/30/2017  
Wage Rate Per Hour: 80% of Journeyman's rate  
Supplemental Benefit Rate Per Hour: \$21.90

**Cement & Concrete Worker (Hired after 2/6/2016 - First 1334 hours)**

Effective Period: 7/1/2016 - 6/30/2017  
Wage Rate Per Hour: \$17.00  
Supplemental Benefit Rate Per Hour: \$10.75

**Cement & Concrete Worker (Hired after 2/6/2016 - Second 1334 hours)**

Effective Period: 7/1/2016 - 6/30/2017  
Wage Rate Per Hour: \$22.10  
Supplemental Benefit Rate Per Hour: \$15.13

**Cement & Concrete Worker (Hired after 2/6/2016 - Last 1334 hours)**

Effective Period: 7/1/2016 - 6/30/2017  
Wage Rate Per Hour: \$27.20  
Supplemental Benefit Rate Per Hour: \$15.63

(Cement Concrete Workers District Council)

---

---

OFFICE OF THE COMPTROLLER, CITY OF NEW YORK  
§220 APPRENTICESHIP PREVAILING WAGE SCHEDULE

**DERRICKPERSON & RIGGER (STONE)**  
(Ratio of Apprentice to Journeyman: 1 to 1, 1 to 4)

**Derrickperson & Rigger (stone) - First Year**

Effective Period: 7/1/2016 - 6/30/2017  
Wage Rate Per Hour: 50% of Journeyman's rate  
Supplemental Benefit Rate Per Hour: 50% of Journeyman's rate

**Derrickperson & Rigger (stone) - Second Year: 1st Six Months**

Effective Period: 7/1/2016 - 6/30/2017  
Wage Rate Per Hour: 70% of Journeyman's rate  
Supplemental Benefit Rate Per Hour: 75% of Journeyman's rate

**Derrickperson & Rigger (stone) - Second Year: 2nd Six Months**

Effective Period: 7/1/2016 - 6/30/2017  
Wage Rate Per Hour: 80% of Journeyman's rate  
Supplemental Benefit Rate Per Hour: 75% of Journeyman's rate

**Derrickperson & Rigger (stone) - Third Year**

Effective Period: 7/1/2016 - 6/30/2017  
Wage Rate Per Hour: 90% of Journeyman's rate  
Supplemental Benefit Rate Per Hour: 75% of Journeyman's rate

(Local #197)

---

---

**DOCKBUILDER/PILE DRIVER**  
(Ratio of Apprentice to Journeyman: 1 to 1, 1 to 6)

**Dockbuilder/Pile Driver (First Year)**

Effective Period: 7/1/2016 - 6/30/2017  
Wage Rate Per Hour: 40% of Journeyman's rate  
Supplemental Benefit Rate Per Hour: \$32.52

**Dockbuilder/Pile Driver (Second Year)**

Effective Period: 7/1/2016 - 6/30/2017  
Wage Rate Per Hour: 50% of Journeyman's rate

OFFICE OF THE COMPTROLLER, CITY OF NEW YORK  
\$220 APPRENTICESHIP PREVAILING WAGE SCHEDULE

Supplemental Benefit Rate Per Hour: \$32.52

**Dockbuilder/Pile Driver (Third Year)**

Effective Period: 7/1/2016 - 6/30/2017

Wage Rate Per Hour: 65% of Journeyperson's rate

Supplemental Benefit Rate Per Hour: \$32.52

**Dockbuilder/Pile Driver (Fourth Year)**

Effective Period: 7/1/2016 - 6/30/2017

Wage Rate Per Hour: 80% of Journeyperson's rate

Supplemental Benefit Rate Per Hour: \$32.52

(Carpenters District Council)

---

**ELECTRICIAN**

(Ratio of Apprentice to Journeyperson: 1 to 1, 1 to 3)

**Electrician (First Term: 0-6 Months)**

Effective Period: 7/1/2016 - 5/10/2017

Wage Rate per Hour: \$13.50

Supplemental Benefit Rate per Hour: \$12.12

Overtime Supplemental Rate Per Hour: \$13.01

Effective Period: 5/11/2017 - 6/30/2017

Wage Rate per Hour: \$14.00

Supplemental Benefit Rate per Hour: \$12.37

Overtime Supplemental Rate Per Hour: \$13.29

**Electrician (First Term: 7-12 Months)**

Effective Period: 7/1/2016 - 5/10/2017

Wage Rate per Hour: \$14.50

Supplemental Benefit Rate per Hour: \$12.63

Overtime Supplemental Rate Per Hour: \$13.58

Effective Period: 5/11/2017 - 6/30/2017

Wage Rate per Hour: \$15.00

Supplemental Benefit Rate per Hour: \$12.88

Overtime Supplemental Rate Per Hour: \$13.87

**Electrician (Second Term: 0-6 Months)**



OFFICE OF THE COMPTROLLER, CITY OF NEW YORK  
§220 APPRENTICESHIP PREVAILING WAGE SCHEDULE

Effective Period: 7/1/2016 - 5/10/2017  
Wage Rate per Hour: \$15.50  
Supplemental Benefit Rate per Hour: \$13.14  
Overtime Supplemental Rate Per Hour: \$14.16

Effective Period: 5/11/2017 - 6/30/2017  
Wage Rate per Hour: \$16.00  
Supplemental Benefit Rate per Hour: \$13.39  
Overtime Supplemental Rate Per Hour: \$14.44

**Electrician (Second Term: 7-12 Months)**

Effective Period: 7/1/2016 - 5/10/2017  
Wage Rate per Hour: \$16.50  
Supplemental Benefit Rate per Hour: \$13.64  
Overtime Supplemental Rate Per Hour: \$14.73

Effective Period: 5/11/2017 - 6/30/2017  
Wage Rate per Hour: \$17.00  
Supplemental Benefit Rate per Hour: \$13.90  
Overtime Supplemental Rate Per Hour: \$15.02

**Electrician (Third Term: 0-6 Months)**

Effective Period: 7/1/2016 - 5/10/2017  
Wage Rate per Hour: \$17.50  
Supplemental Benefit Rate per Hour: \$14.15  
Overtime Supplemental Rate Per Hour: \$15.31

Effective Period: 5/11/2017 - 6/30/2017  
Wage Rate per Hour: \$18.00  
Supplemental Benefit Rate per Hour: \$14.41  
Overtime Supplemental Rate Per Hour: \$15.59

**Electrician (Third Term: 7-12 Months)**

Effective Period: 7/1/2016 - 5/10/2017  
Wage Rate per Hour: \$18.50  
Supplemental Benefit Rate per Hour: \$14.66  
Overtime Supplemental Rate Per Hour: \$15.88

Effective Period: 5/11/2017 - 6/30/2017  
Wage Rate per Hour: \$19.00  
Supplemental Benefit Rate per Hour: \$14.92  
Overtime Supplemental Rate Per Hour: \$16.17

**Electrician (Fourth Term: 0-6 Months)**

Effective Period: 7/1/2016 - 5/10/2017

OFFICE OF THE COMPTROLLER, CITY OF NEW YORK  
§220 APPRENTICESHIP PREVAILING WAGE SCHEDULE

Wage Rate per Hour: **\$19.50**  
Supplemental Benefit Rate per Hour: **\$15.17**  
Overtime Supplemental Rate Per Hour: **\$16.45**

Effective Period: **5/11/2017 - 6/30/2017**  
Wage Rate per Hour: **\$20.00**  
Supplemental Benefit Rate per Hour: **\$15.43**  
Overtime Supplemental Rate Per Hour: **\$16.75**

**Electrician (Fourth Term: 7-12 Months)**

Effective Period: **7/1/2016 - 5/10/2017**  
Wage Rate per Hour: **\$21.50**  
Supplemental Benefit Rate per Hour: **\$16.19**  
Overtime Supplemental Rate Per Hour: **\$17.60**

Effective Period: **5/11/2017 - 6/30/2017**  
Wage Rate per Hour: **\$22.00**  
Supplemental Benefit Rate per Hour: **\$16.44**  
Overtime Supplemental Rate Per Hour: **\$17.89**

**Electrician (Fifth Term: 0-12 Months)**

Effective Period: **7/1/2016 - 5/10/2017**  
Wage Rate per Hour: **\$23.50**  
Supplemental Benefit Rate per Hour: **\$19.54**  
Overtime Supplemental Rate Per Hour: **\$21.01**

Effective Period: **5/11/2017 - 6/30/2017**  
Wage Rate per Hour: **\$24.00**  
Supplemental Benefit Rate per Hour: **\$19.80**  
Overtime Supplemental Rate Per Hour: **\$21.30**

**Electrician (Fifth Term: 13-18 Months)**

Effective Period: **7/1/2016 - 5/10/2017**  
Wage Rate per Hour: **\$28.00**  
Supplemental Benefit Rate per Hour: **\$21.85**  
Overtime Supplemental Rate Per Hour: **\$23.60**

Effective Period: **5/11/2017 - 6/30/2017**  
Wage Rate per Hour: **\$28.50**  
Supplemental Benefit Rate per Hour: **\$22.10**  
Overtime Supplemental Rate Per Hour: **\$23.89**

**Overtime Description**

Overtime Wage paid at time and one half the regular rate

(Local #3)

OFFICE OF THE COMPTROLLER, CITY OF NEW YORK  
§220 APPRENTICESHIP PREVAILING WAGE SCHEDULE

---

---

**ELEVATOR CONSTRUCTOR**  
(Ratio of Apprentice to Journeyman: 1 to 1, 1 to 2)

**Elevator (Constructor) - First Year**

Effective Period: 7/1/2016 - 3/16/2017  
Wage Rate Per Hour: 50% of Journeyman's rate  
Supplemental Rate Per Hour: \$28.24

Effective Period: 3/17/2017 - 6/30/2017  
Wage Rate Per Hour: 50% of Journeyman's rate  
Supplemental Rate Per Hour: \$29.72

**Elevator (Constructor) - Second Year**

Effective Period: 7/1/2016 - 3/16/2017  
Wage Rate Per Hour: 55% of Journeyman's rate  
Supplemental Rate Per Hour: \$28.67

Effective Period: 3/17/2017 - 6/30/2017  
Wage Rate Per Hour: 55% of Journeyman's rate  
Supplemental Rate Per Hour: \$30.15

**Elevator (Constructor) - Third Year**

Effective Period: 7/1/2016 - 3/16/2017  
Wage Rate Per Hour: 65% of Journeyman's rate  
Supplemental Rate Per Hour: \$29.52

Effective Period: 3/17/2017 - 6/30/2017  
Wage Rate Per Hour: 65% of Journeyman's rate  
Supplemental Rate Per Hour: \$31.03

**Elevator (Constructor) - Fourth Year**

Effective Period: 7/1/2016 - 3/16/2017  
Wage Rate Per Hour: 75% of Journeyman's rate  
Supplemental Rate Per Hour: \$30.37

Effective Period: 3/17/2017 - 6/30/2017  
Wage Rate Per Hour: 75% of Journeyman's rate  
Supplemental Rate Per Hour: \$31.91

(Local #1)

---

**ELEVATOR REPAIR & MAINTENANCE**  
**(Ratio of Apprentice to Journeyman: 1 to 1, 1 to 2)**

**Elevator Service/Modernization Mechanic (First Year)**

Effective Period: 7/1/2016 - 3/16/2017  
Wage Rate Per Hour: 50% of Journeyman's rate  
Supplemental Benefit Per Hour: \$28.33

Effective Period: 3/17/2017 - 6/30/2017  
Wage Rate Per Hour: 50% of Journeyman's rate  
Supplemental Benefit Per Hour: \$29.80

**Elevator Service/Modernization Mechanic (Second Year)**

Effective Period: 7/1/2016 - 3/16/2017  
Wage Rate Per Hour: 55% of Journeyman's rate  
Supplemental Benefit Per Hour: \$28.74

Effective Period: 3/17/2017 - 6/30/2017  
Wage Rate Per Hour: 55% of Journeyman's rate  
Supplemental Benefit Per Hour: \$30.23

**Elevator Service/Modernization Mechanic (Third Year)**

Effective Period: 7/1/2016 - 3/16/2017  
Wage Rate Per Hour: 65% of Journeyman's rate  
Supplemental Benefit Per Hour: \$29.58

Effective Period: 3/17/2017 - 6/30/2017  
Wage Rate Per Hour: 65% of Journeyman's rate  
Supplemental Benefit Per Hour: \$31.09

**Elevator Service/Modernization Mechanic (Fourth Year)**

Effective Period: 7/1/2016 - 3/16/2017  
Wage Rate Per Hour: 75% of Journeyman's rate  
Supplemental Benefit Per Hour: \$30.42

Effective Period: 3/17/2017 - 6/30/2017  
Wage Rate Per Hour: 75% of Journeyman's rate  
Supplemental Benefit Per Hour: \$31.95

(Local #1)

---

OFFICE OF THE COMPTROLLER, CITY OF NEW YORK  
§220 APPRENTICESHIP PREVAILING WAGE SCHEDULE

---

**ENGINEER**

(Ratio of Apprentice to Journeyperson: 1 to 1, 1 to 5)

**Engineer - First Year**

Effective Period: 7/1/2016 - 6/30/2017

Wage Rate per Hour: **\$24.28**

Supplemental Benefit Rate per Hour: **\$23.41**

**Engineer - Second Year**

Effective Period: 7/1/2016 - 6/30/2017

Wage Rate per Hour: **\$30.35**

Supplemental Benefit Rate per Hour: **\$23.41**

**Engineer - Third Year**

Effective Period: 7/1/2016 - 6/30/2017

Wage Rate per Hour: **\$33.38**

Supplemental Benefit Rate per Hour: **\$23.41**

**Engineer - Fourth Year**

Effective Period: 7/1/2016 - 6/30/2017

Wage Rate per Hour: **\$36.41**

Supplemental Benefit Rate per Hour: **\$23.41**

(Local #15)

---

**ENGINEER - OPERATING**

(Ratio of Apprentice to Journeyperson: 1 to 1, 1 to 5)

**Operating Engineer - First Year**

Effective Period: 7/1/2016 - 6/30/2017

Wage Rate Per Hour 40% of Journeyperson's Rate

Supplemental Benefit Per Hour: **\$20.85**

**Operating Engineer - Second Year**

OFFICE OF THE COMPTROLLER, CITY OF NEW YORK  
\$220 APPRENTICESHIP PREVAILING WAGE SCHEDULE

Effective Period: 7/1/2016 - 6/30/2017  
Wage Rate Per Hour: 50% of Journeyman's Rate  
Supplemental Benefit Per Hour: \$20.85

**Operating Engineer - Third Year**

Effective Period: 7/1/2016 - 6/30/2017  
Wage Rate Per Hour: 60% of Journeyman's Rate  
Supplemental Benefit Per Hour: \$20.85

(Local #14)

---

---

**FLOOR COVERER**

(Ratio of Apprentice to Journeyman: 1 to 1, 1 to 4)

**Floor Coverer (First Year)**

Effective Period: 7/1/2016 - 6/30/2017  
Wage Rate Per Hour: 40% of Journeyman's rate  
Supplemental Rate Per Hour: \$31.14

**Floor Coverer (Second Year)**

Effective Period: 7/1/2016 - 6/30/2017  
Wage Rate Per Hour: 50% of Journeyman's rate  
Supplemental Rate Per Hour: \$31.14

**Floor Coverer (Third Year)**

Effective Period: 7/1/2016 - 6/30/2017  
Wage Rate Per Hour: 65% of Journeyman's rate  
Supplemental Rate Per Hour: \$31.14

**Floor Coverer (Fourth Year)**

Effective Period: 7/1/2016 - 6/30/2017  
Wage Rate Per Hour: 80% of Journeyman's rate  
Supplemental Rate Per Hour: \$31.14

(Carpenters District Council)

---

---

OFFICE OF THE COMPTROLLER, CITY OF NEW YORK  
\$220 APPRENTICESHIP PREVAILING WAGE SCHEDULE

**GLAZIER**

(Ratio of Apprentice to Journeyman: 1 to 1, 1 to 3)

**Glazier (First Year)**

Effective Period: 7/1/2016 - 6/30/2017  
Wage Rate Per Hour: 40% of Journeyman's rate  
Supplemental Rate Per Hour: \$14.14

**Glazier (Second Year)**

Effective Period: 7/1/2016 - 6/30/2017  
Wage Rate Per Hour: 50% of Journeyman's rate  
Supplemental Rate Per Hour: \$23.77

**Glazier (Third Year)**

Effective Period: 7/1/2016 - 6/30/2017  
Wage Rate Per Hour: 60% of Journeyman's rate  
Supplemental Rate Per Hour: \$26.73

**Glazier (Fourth Year)**

Effective Period: 7/1/2016 - 6/30/2017  
Wage Rate Per Hour: 80% of Journeyman's rate  
Supplemental Rate Per Hour: \$32.14

(Local #1281)

---

---

**HEAT & FROST INSULATOR**

(Ratio of Apprentice to Journeyman: 1 to 1, 1 to 4)

**Heat & Frost Insulator (First Year)**

Effective Period: 7/1/2016 - 6/30/2017  
Wage and Supplemental Rate Per Hour: 40% of Journeyman's rate

**Heat & Frost Insulator (Second Year)**

Effective Period: 7/1/2016 - 6/30/2017  
Wage and Supplemental Rate Per Hour: 60% of Journeyman's rate

OFFICE OF THE COMPTROLLER, CITY OF NEW YORK  
\$220 APPRENTICESHIP PREVAILING WAGE SCHEDULE

**Heat & Frost Insulator (Third Year)**

Effective Period: 7/1/2016 - 6/30/2017

Wage and Supplemental Rate Per Hour: 70% of Journeyperson's rate

**Heat & Frost Insulator (Fourth Year)**

Effective Period: 7/1/2016 - 6/30/2017

Wage and Supplemental Rate Per Hour: 80% of Journeyperson's rate

(Local #12)

---

---

**HOUSE WRECKER  
(TOTAL DEMOLITION)  
(Ratio of Apprentice to Journeyperson: 1 to 1, 1 to 3)**

**House Wrecker - First Year**

Effective Period: 7/1/2016 - 6/30/2017

Wage Rate per Hour: \$21.17

Supplemental Benefit Rate per Hour: \$17.99

**House Wrecker - Second Year**

Effective Period: 7/1/2016 - 6/30/2017

Wage Rate per Hour: \$22.32

Supplemental Benefit Rate per Hour: \$17.99

**House Wrecker - Third Year**

Effective Period: 7/1/2016 - 6/30/2017

Wage Rate per Hour: \$23.97

Supplemental Benefit Rate per Hour: \$17.99

**House Wrecker - Fourth Year**

Effective Period: 7/1/2016 - 6/30/2017

Wage Rate per Hour: \$26.53

Supplemental Benefit Rate per Hour: \$17.99

(Mason Tenders District Council)

---



OFFICE OF THE COMPTROLLER, CITY OF NEW YORK  
§220 APPRENTICESHIP PREVAILING WAGE SCHEDULE

---

**IRON WORKER - ORNAMENTAL**

(Ratio of Apprentice to Journeyman: 1 to 1, 1 to 4)

**Iron Worker (Ornamental) - 1st Ten Months**

Effective Period: 7/1/2016 - 6/30/2017  
Wage Rate Per Hour: 50% of Journeyman's rate  
Supplemental Rate Per Hour: \$37.90

**Iron Worker (Ornamental) - 11 -16 Months**

Effective Period: 7/1/2016 - 6/30/2017  
Wage Rate Per Hour: 55% of Journeyman's rate  
Supplemental Rate Per Hour: \$39.06

**Iron Worker (Ornamental) - 17 - 22 Months**

Effective Period: 7/1/2016 - 6/30/2017  
Wage Rate Per Hour: 60% of Journeyman's rate  
Supplemental Rate Per Hour: \$40.23

**Iron Worker (Ornamental) - 23 - 28 Months**

Effective Period: 7/1/2016 - 6/30/2017  
Wage Rate Per Hour: 70% of Journeyman's rate  
Supplemental Rate Per Hour: \$42.57

**Iron Worker (Ornamental) - 29 - 36 Months**

Effective Period: 7/1/2016 - 6/30/2017  
Wage Rate Per Hour: 80% of Journeyman's rate  
Supplemental Rate Per Hour: \$44.90

(Local #580)

---

**IRON WORKER - STRUCTURAL**

(Ratio of Apprentice to Journeyman: 1 to 1, 1 to 6)

**Iron Worker (Structural) - 1st Six Months**

OFFICE OF THE COMPTROLLER, CITY OF NEW YORK  
\$220 APPRENTICESHIP PREVAILING WAGE SCHEDULE

Effective Period: 7/1/2016 - 6/30/2017  
Wage Rate per Hour: \$25.85  
Supplemental Benefit Rate per Hour: \$48.35

**Iron Worker (Structural) - 7- 18 Months**

Effective Period: 7/1/2016 - 6/30/2017  
Wage Rate per Hour: \$26.45  
Supplemental Benefit Rate per Hour: \$48.35

**Iron Worker (Structural) - 19 - 36 months**

Effective Period: 7/1/2016 - 6/30/2017  
Wage Rate per Hour: \$27.05  
Supplemental Benefit Rate per Hour: \$48.35

(Local #40 and #361)

---

**LABORER (FOUNDATION, CONCRETE, EXCAVATING, STREET PIPE  
LAYER & COMMON)  
(Ratio Apprentice to Journeyman: 1 to 1, 1 to 3)**

**Laborer (Foundation, Concrete, Excavating, Street Pipe Layer & Common) - First  
1000 hours**

Effective Period: 7/1/2016 - 6/30/2017  
Wage Rate Per Hour: 50% of Journeyman's rate  
Supplemental Rate Per Hour: \$38.63

**Laborer (Foundation, Concrete, Excavating, Street Pipe Layer & Common) -  
Second 1000 hours**

Effective Period: 7/1/2016 - 6/30/2017  
Wage Rate Per Hour: 60% of Journeyman's rate  
Supplemental Rate Per Hour: \$38.63

**Laborer (Foundation, Concrete, Excavating, Street Pipe Layer & Common) -  
Third 1000 hours**

Effective Period: 7/1/2016 - 6/30/2017  
Wage Rate Per Hour: 75% of Journeyman's rate  
Supplemental Rate Per Hour: \$38.63

OFFICE OF THE COMPTROLLER, CITY OF NEW YORK  
§220 APPRENTICESHIP PREVAILING WAGE SCHEDULE

**Laborer (Foundation, Concrete, Excavating, Street Pipe Layer & Common) -  
Fourth 1000 hours**

Effective Period: 7/1/2016 - 6/30/2017  
Wage Rate Per Hour: 90% of Journeyperson's rate  
Supplemental Rate Per Hour: \$38.63

(Local #731)

---

---

**MARBLE MECHANICS  
(Ratio of Apprentice to Journeyperson: 1 to 1, 1 to 4)**

**Cutters & Setters - First 750 Hours**

Effective Period: 7/1/2016 - 6/30/2017  
Wage and Supplemental Rate Per Hour: 50% of Journeyperson's rate

NO BENEFITS PAID DURING THE FIRST TWO MONTHS (PROBATIONARY PERIOD)

**Cutters & Setters - Second 750 Hours**

Effective Period: 7/1/2016 - 6/30/2017  
Wage and Supplemental Rate Per Hour: 55% of Journeyperson's rate

**Cutters & Setters - Third 750 Hours**

Effective Period: 7/1/2016 - 6/30/2017  
Wage and Supplemental Rate Per Hour: 65% of Journeyperson's rate

**Cutters & Setters - Fourth 750 Hours**

Effective Period: 7/1/2016 - 6/30/2017  
Wage and Supplemental Rate Per Hour: 75% of Journeyperson's rate

**Cutters & Setters - Fifth 750 Hours**

Effective Period: 7/1/2016 - 6/30/2017  
Wage and Supplemental Rate Per Hour: 85% of Journeyperson's rate

**Cutters & Setters - Sixth 750 Hours**

Effective Period: 7/1/2016 - 6/30/2017  
Wage and Supplemental Rate Per Hour: 95% of Journeyperson's rate

OFFICE OF THE COMPTROLLER, CITY OF NEW YORK  
§220 APPRENTICESHIP PREVAILING WAGE SCHEDULE

**Polishers & Finishers - First 750 Hours**

Effective Period: 7/1/2016 - 6/30/2017

Wage and Supplemental Rate Per Hour: 50% of Journeyperson's rate

NO BENEFITS PAID DURING THE FIRST TWO MONTHS (PROBATIONARY PERIOD)

**Polishers & Finishers - Second 750 Hours**

Effective Period: 7/1/2016 - 6/30/2017

Wage and Supplemental Rate Per Hour: 60% of Journeyperson's rate

**Polishers & Finishers - Third 750 Hours**

Effective Period: 7/1/2016 - 6/30/2017

Wage and Supplemental Rate Per Hour: 75% of Journeyperson's rate

**Polishers & Finishers - Fourth 750 Hours**

Effective Period: 7/1/2016 - 6/30/2017

Wage and Supplemental Rate Per Hour: 90% of Journeyperson's rate

(Local #7)

---

---

**MASON TENDER**

(Ratio of Apprentice to Journeyperson: 1 to 1, 1 to 3)

**Mason Tender - First Year**

Effective Period: 7/1/2016 - 6/30/2017

Wage Rate per Hour: \$21.39

Supplemental Benefit Rate per Hour: \$19.10

**Mason Tender - Second Year**

Effective Period: 7/1/2016 - 6/30/2017

Wage Rate per Hour: \$22.54

Supplemental Benefit Rate per Hour: \$19.10

**Mason Tender - Third Year**

Effective Period: 7/1/2016 - 6/30/2017

Wage Rate per Hour: \$24.29

Supplemental Benefit Rate per Hour: \$19.15

OFFICE OF THE COMPTROLLER, CITY OF NEW YORK  
§220 APPRENTICESHIP PREVAILING WAGE SCHEDULE

**Mason Tender - Fourth Year**

Effective Period: 7/1/2016 - 6/30/2017  
Wage Rate per Hour: \$26.95  
Supplemental Benefit Rate per Hour: \$19.15

(Local #79)

---

**METALLIC LATHER**  
(Ratio of Apprentice to Journeyman: 1 to 1, 1 to 3)

**Metallic Lather (First Year)**

Effective Period: 7/1/2016 - 6/30/2017  
Wage Rate per Hour: \$23.01  
Supplemental Benefit Rate per Hour: \$17.95

**Metallic Lather (Second Year)**

Effective Period: 7/1/2016 - 6/30/2017  
Wage Rate per Hour: \$28.11  
Supplemental Benefit Rate per Hour: \$17.95

**Metallic Lather (Third Year)**

Effective Period: 7/1/2016 - 6/30/2017  
Wage Rate per Hour: \$33.21  
Supplemental Benefit Rate per Hour: \$17.95

(Local #46)

---

**MILLWRIGHT**  
(Ratio of Apprentice to Journeyman: 1 to 1, 1 to 4)

**Millwright (First Year)**

OFFICE OF THE COMPTROLLER, CITY OF NEW YORK  
\$220 APPRENTICESHIP PREVAILING WAGE SCHEDULE

Effective Period: 7/1/2016 - 6/30/2017  
Wage Rate per Hour: \$28.33  
Supplemental Benefit Rate per Hour: \$34.28

**Millwright (Second Year)**

Effective Period: 7/1/2016 - 6/30/2017  
Wage Rate per Hour: \$33.48  
Supplemental Benefit Rate per Hour: \$37.88

**Millwright (Third Year)**

Effective Period: 7/1/2016 - 6/30/2017  
Wage Rate per Hour: \$38.63  
Supplemental Benefit Rate per Hour: \$42.13

**Millwright (Fourth Year)**

Effective Period: 7/1/2016 - 6/30/2017  
Wage Rate per Hour: \$48.93  
Supplemental Benefit Rate per Hour: \$48.69

(Local #740)

---

---

**PAVER AND ROADBUILDER**  
(Ratio of Apprentice to Journeyperson: 1 to 1, 1 to 3)

**Paver and Roadbuilder - First Year (Minimum 1000 hours)**

Effective Period: 7/1/2016 - 6/30/2017  
Wage Rate per Hour: \$27.55  
Supplemental Benefit Rate per Hour: \$18.20

**Paver and Roadbuilder - Second Year (Minimum 1000 hours)**

Effective Period: 7/1/2016 - 6/30/2017  
Wage Rate per Hour: \$29.19  
Supplemental Benefit Rate per Hour: \$18.20

(Local #1010)

---

## **PAINTER**

**(Ratio of Apprentice to Journeyman: 1 to 1, 1 to 3)**

### **Painter - Brush & Roller - First Year**

**Effective Period: 7/1/2016 - 4/30/2017**

**Wage Rate per Hour: \$17.00**

**Supplemental Benefit Rate per Hour: \$12.38**

**Effective Period: 5/1/2017 - 6/30/2017**

**Wage Rate per Hour: \$17.64**

**Supplemental Benefit Rate per Hour: \$12.78**

### **Painter - Brush & Roller - Second Year**

**Effective Period: 7/1/2016 - 4/30/2017**

**Wage Rate per Hour: \$21.25**

**Supplemental Benefit Rate per Hour: \$16.23**

**Effective Period: 5/1/2017 - 6/30/2017**

**Wage Rate per Hour: \$22.05**

**Supplemental Benefit Rate per Hour: \$16.63**

### **Painter - Brush & Roller - Third Year**

**Effective Period: 7/1/2016 - 4/30/2017**

**Wage Rate per Hour: \$25.50**

**Supplemental Benefit Rate per Hour: \$19.14**

**Effective Period: 5/1/2017 - 6/30/2017**

**Wage Rate per Hour: \$26.46**

**Supplemental Benefit Rate per Hour: \$19.54**

### **Painter - Brush & Roller - Fourth Year**

**Effective Period: 7/1/2016 - 4/30/2017**

**Wage Rate per Hour: \$34.00**

**Supplemental Benefit Rate per Hour: \$24.52**

**Effective Period: 5/1/2017 - 6/30/2017**

**Wage Rate per Hour: \$35.28**

**Supplemental Benefit Rate per Hour: \$24.92**

**(District Council of Painters)**

OFFICE OF THE COMPTROLLER, CITY OF NEW YORK  
§220 APPRENTICESHIP PREVAILING WAGE SCHEDULE

---

---

**PAINTER - METAL POLISHER**

(Ratio of Apprentice to Journeyman: 1 to 1, 1 to 3)

**Metal Polisher (First Year)**

Effective Period: 7/1/2016 - 6/30/2017

Wage Rate per Hour: \$11.75

Supplemental Benefit Rate per Hour: \$5.13

**Metal Polisher (Second Year)**

Effective Period: 7/1/2016 - 6/30/2017

Wage Rate per Hour: \$13.00

Supplemental Benefit Rate per Hour: \$5.13

**Metal Polisher (Third Year)**

Effective Period: 7/1/2016 - 6/30/2017

Wage Rate per Hour: \$15.75

Supplemental Benefit Rate per Hour: \$5.13

(Local 8A-28)

---

---

**PAINTER - STRUCTURAL STEEL**

(Ratio of Apprentice to Journeyman: 1 to 1, 1 to 3)

**Painters - Structural Steel (First Year)**

Effective Period: 7/1/2016 - 6/30/2017

Wage and Supplemental Rate Per Hour: 40% of Journeyman's rate

**Painters - Structural Steel (Second Year)**

Effective Period: 7/1/2016 - 6/30/2017

Wage and Supplemental Rate Per Hour: 60% of Journeyman's rate

**Painters - Structural Steel (Third Year)**



OFFICE OF THE COMPTROLLER, CITY OF NEW YORK  
§220 APPRENTICESHIP PREVAILING WAGE SCHEDULE

Effective Period: 7/1/2016 - 6/30/2017

Wage and Supplemental Rate Per Hour: 80% of Journeyman's rate

(Local #806)

---

---

## **PLASTERER**

(Ratio of Apprentice to Journeyman: 1 to 1, 1 to 3)

### **Plasterer - First Year: 1st Six Months**

Effective Period: 7/1/2016 - 6/30/2017

Wage Rate Per Hour: 40% of Journeyman's rate

Supplemental Rate Per Hour: \$15.91

### **Plasterer - First Year: 2nd Six Months**

Effective Period: 7/1/2016 - 6/30/2017

Wage Rate Per Hour: 45% of Journeyman's rate

Supplemental Rate Per Hour: \$16.39

### **Plasterer - Second Year: 1st Six Months**

Effective Period: 7/1/2016 - 6/30/2017

Wage Rate Per Hour: 55% of Journeyman's rate

Supplemental Rate Per Hour: \$18.36

### **Plasterer - Second Year: 2nd Six Months**

Effective Period: 7/1/2016 - 6/30/2017

Wage Rate Per Hour: 60% of Journeyman's rate

Supplemental Rate Per Hour: \$19.44

### **Plasterer - Third Year: 1st Six Months**

Effective Period: 7/1/2016 - 6/30/2017

Wage Rate Per Hour: 70% of Journeyman's rate

Supplemental Rate Per Hour: \$21.61

### **Plasterer - Third Year: 2nd Six Months**

Effective Period: 7/1/2016 - 6/30/2017

Wage Rate Per Hour: 75% of Journeyman's rate

Supplemental Rate Per Hour: \$22.69

OFFICE OF THE COMPTROLLER, CITY OF NEW YORK  
§220 APPRENTICESHIP PREVAILING WAGE SCHEDULE

(Local #530)

---

---

**PLASTERER - TENDER**  
(Ratio of Apprentice to Journeyman: 1 to 1, 1 to 3)

**Plasterer Tender - First Year**

Effective Period: 7/1/2016 - 6/30/2017  
Wage Rate per Hour: \$21.39  
Supplemental Benefit Rate per Hour: \$19.10

**Plasterer Tender - Second Year**

Effective Period: 7/1/2016 - 6/30/2017  
Wage Rate per Hour: \$22.54  
Supplemental Benefit Rate per Hour: \$19.10

**Plasterer Tender - Third Year**

Effective Period: 7/1/2016 - 6/30/2017  
Wage Rate per Hour: \$24.29  
Supplemental Benefit Rate per Hour: \$19.15

**Plasterer Tender - Fourth Year**

Effective Period: 7/1/2016 - 6/30/2017  
Wage Rate per Hour: \$26.95  
Supplemental Benefit Rate per Hour: \$19.15

(Local #79)

---

---

**PLUMBER**  
(Ratio of Apprentice to Journeyman: 1 to 1, 1 to 3)

**Plumber - First Year: 1st Six Months**

Effective Period: 7/1/2016 - 6/30/2017

OFFICE OF THE COMPTROLLER, CITY OF NEW YORK  
§220 APPRENTICESHIP PREVAILING WAGE SCHEDULE

Wage Rate per Hour: \$14.00  
Supplemental Benefit Rate per Hour: \$0.71

**Plumber - First Year: 2nd Six Months**

Effective Period: 7/1/2016 - 6/30/2017  
Wage Rate per Hour: \$14.00  
Supplemental Benefit Rate per Hour: \$2.96

**Plumber - Second Year**

Effective Period: 7/1/2016 - 6/30/2017  
Wage Rate per Hour: \$24.07  
Supplemental Benefit Rate per Hour: \$13.21

**Plumber - Third Year**

Effective Period: 7/1/2016 - 6/30/2017  
Wage Rate per Hour: \$26.17  
Supplemental Benefit Rate per Hour: \$13.21

**Plumber - Fourth Year**

Effective Period: 7/1/2016 - 6/30/2017  
Wage Rate per Hour: \$29.02  
Supplemental Benefit Rate per Hour: \$13.21

**Plumber - Fifth Year: 1st Six Months**

Effective Period: 7/1/2016 - 6/30/2017  
Wage Rate per Hour: \$30.42  
Supplemental Benefit Rate per Hour: \$13.21

**Plumber - Fifth Year: 2nd Six Months**

Effective Period: 7/1/2016 - 6/30/2017  
Wage Rate per Hour: \$42.49  
Supplemental Benefit Rate per Hour: \$13.21

(Plumbers Local #1)

---

---

OFFICE OF THE COMPTROLLER, CITY OF NEW YORK  
§220 APPRENTICESHIP PREVAILING WAGE SCHEDULE

**POINTER, WATERPROOFER, CAULKER, SANDBLASTER,  
STEAMBLASTER**

(Exterior Building Renovation)

(Ratio of Apprentice to Journeyperson: 1 to 1, 1 to 4)

**Pointer, Waterproofer, Caulker, Sandblaster, Steamblaster - First Year**

Effective Period: 7/1/2016 - 6/30/2017

Wage Rate per Hour: \$26.52

Supplemental Benefit Rate per Hour: \$12.10

**Pointer, Waterproofer, Caulker, Sandblaster, Steamblaster - Second Year**

Effective Period: 7/1/2016 - 6/30/2017

Wage Rate per Hour: \$27.89

Supplemental Benefit Rate per Hour: \$16.75

**Pointer, Waterproofer, Caulker, Sandblaster, Steamblaster - Third Year**

Effective Period: 7/1/2016 - 6/30/2017

Wage Rate per Hour: \$33.98

Supplemental Benefit Rate per Hour: \$19.50

**Pointer, Waterproofer, Caulker, Sandblaster, Steamblaster - Fourth Year**

Effective Period: 7/1/2016 - 6/30/2017

Wage Rate per Hour: \$40.80

Supplemental Benefit Rate per Hour: \$20.35

(Bricklayer District Council)

---

---

**ROOFER**

(Ratio of Apprentice to Journeyperson: 1 to 1, 1 to 2)

**Roofer - First Year**

Effective Period: 7/1/2016 - 6/30/2017

Wage and Supplemental Rate Per Hour: 35% of Journeyperson's Rate

**Roofer - Second Year**

OFFICE OF THE COMPTROLLER, CITY OF NEW YORK  
§220 APPRENTICESHIP PREVAILING WAGE SCHEDULE

Effective Period: 7/1/2016 - 6/30/2017

Wage and Supplemental Rate Per Hour: 50% of Journeyperson's Rate

**Roofer - Third Year**

Effective Period: 7/1/2016 - 6/30/2017

Wage and Supplemental Rate Per Hour: 60% of Journeyperson's Rate

**Roofer - Fourth Year**

Effective Period: 7/1/2016 - 6/30/2017

Wage and Supplemental Rate Per Hour: 75% of Journeyperson's Rate

(Local #8)

---

---

**SHEET METAL WORKER**

(Ratio of Apprentice to Journeyperson: 1 to 1, 1 to 3)

**Sheet Metal Worker (0-6 Months)**

Effective Period: 7/1/2016 - 6/30/2017

Wage Rate Per Hour: 25% of Journeyperson's rate

Supplemental Rate Per Hour: \$6.35

**Sheet Metal Worker (7-18 Months)**

Effective Period: 7/1/2016 - 6/30/2017

Wage Rate Per Hour: 35% of Journeyperson's rate

Supplemental Rate Per Hour: \$17.12

**Sheet Metal Worker (19-30 Months)**

Effective Period: 7/1/2016 - 6/30/2017

Wage Rate Per Hour: 45% of Journeyperson's rate

Supplemental Rate Per Hour: \$23.54

**Sheet Metal Worker (31-36 Months)**

Effective Period: 7/1/2016 - 6/30/2017

Wage Rate Per Hour: 55% of Journeyperson's rate

Supplemental Rate Per Hour: \$27.70

**Sheet Metal Worker (37-42 Months)**

Effective Period: 7/1/2016 - 6/30/2017

OFFICE OF THE COMPTROLLER, CITY OF NEW YORK  
§220 APPRENTICESHIP PREVAILING WAGE SCHEDULE

Wage Rate Per Hour: 60% of Journeyperson's rate  
Supplemental Rate Per Hour: \$29.11

**Sheet Metal Worker (43-48 Months)**

Effective Period: 7/1/2016 - 6/30/2017  
Wage Rate Per Hour: 70% of Journeyperson's rate  
Supplemental Rate Per Hour: \$33.96

**Sheet Metal Worker (49-54 Months)**

Effective Period: 7/1/2016 - 6/30/2017  
Wage Rate Per Hour: 75% of Journeyperson's rate  
Supplemental Rate Per Hour: \$36.07

**Sheet Metal Worker (55-60 Months)**

Effective Period: 7/1/2016 - 6/30/2017  
Wage Rate Per Hour: 80% of Journeyperson's rate  
Supplemental Rate Per Hour: \$38.15

(Local #28)

---

---

**SIGN ERECTOR**

(Ratio of Apprentice to Journeyperson: 1 to 1, 1 to 4)

**Sign Erector - First Year: 1st Six Months**

Effective Period: 7/1/2016 - 6/30/2017  
Wage Rate Per Hour: 35% of Journeyperson's rate  
Supplemental Rate Per Hour: \$13.95

**Sign Erector - First Year: 2nd Six Months**

Effective Period: 7/1/2016 - 6/30/2017  
Wage Rate Per Hour: 40% of Journeyperson's rate  
Supplemental Rate Per Hour: \$15.83

**Sign Erector - Second Year: 1st Six Months**

Effective Period: 7/1/2016 - 6/30/2017  
Wage Rate Per Hour: 45% of Journeyperson's rate  
Supplemental Rate Per Hour: \$17.72

**Sign Erector - Second Year: 2nd Six Months**

OFFICE OF THE COMPTROLLER, CITY OF NEW YORK  
\$220 APPRENTICESHIP PREVAILING WAGE SCHEDULE

Effective Period: 7/1/2016 - 6/30/2017  
Wage Rate Per Hour: 50% of Journeyman's rate  
Supplemental Rate Per Hour: \$19.60

**Sign Erector - Third Year: 1st Six Months**

Effective Period: 7/1/2016 - 6/30/2017  
Wage Rate Per Hour: 55% of Journeyman's rate  
Supplemental Rate Per Hour: \$26.23

**Sign Erector - Third Year: 2nd Six Months**

Effective Period: 7/1/2016 - 6/30/2017  
Wage Rate Per Hour: 60% of Journeyman's rate  
Supplemental Rate Per Hour: \$28.24

**Sign Erector - Fourth Year: 1st Six Months**

Effective Period: 7/1/2016 - 6/30/2017  
Wage Rate Per Hour: 65% of Journeyman's rate  
Supplemental Rate Per Hour: \$30.98

**Sign Erector - Fourth Year: 2nd Six Months**

Effective Period: 7/1/2016 - 6/30/2017  
Wage Rate Per Hour: 70% of Journeyman's rate  
Supplemental Rate Per Hour: \$33.06

**Sign Erector - Fifth Year**

Effective Period: 7/1/2016 - 6/30/2017  
Wage Rate Per Hour: 75% of Journeyman's rate  
Supplemental Rate Per Hour: \$35.15

**Sign Erector - Sixth Year**

Effective Period: 7/1/2016 - 6/30/2017  
Wage Rate Per Hour: 80% of Journeyman's rate  
Supplemental Rate Per Hour: \$37.22

(Local #137)

---

---

**STEAMFITTER**

**(Ratio of Apprentice to Journeyman: 1 to 1, 1 to 3)**

OFFICE OF THE COMPTROLLER, CITY OF NEW YORK  
§220 APPRENTICESHIP PREVAILING WAGE SCHEDULE

**Steamfitter - First Year**

Effective Period: 7/1/2016 - 6/30/2017

Wage Rate and Supplemental Per Hour: 40% of Journeyperson's rate.

**Steamfitter - Second Year**

Effective Period: 7/1/2016 - 6/30/2017

Wage Rate and Supplemental Rate Per Hour: 50% of Journeyperson's rate.

**Steamfitter - Third Year**

Effective Period: 7/1/2016 - 6/30/2017

Wage Rate and Supplemental Rate per Hour: 65% of Journeyperson's rate.

**Steamfitter - Fourth Year**

Effective Period: 7/1/2016 - 6/30/2017

Wage Rate and Supplemental Rate Per Hour: 80% of Journeyperson's rate.

**Steamfitter - Fifth Year**

Effective Period: 7/1/2016 - 6/30/2017

Wage Rate and Supplemental Rate Per Hour: 85% of Journeyperson's rate.

(Local #638)

---

---

**STONE MASON - SETTER**

(Ratio Apprentice of Journeyperson: 1 to 1, 1 to 2)

**Stone Mason - Setters - First 750 Hours**

Effective Period: 7/1/2016 - 6/30/2017

Wage and Supplemental Rate Per Hour: 50% of Journeyperson's rate

**Stone Mason - Setters - Second 750 Hours**

Effective Period: 7/1/2016 - 6/30/2017

Wage Rate Per Hour: 60% of Journeyperson's rate

Supplemental Rate Per Hour: 50% of Journeyperson's rate

**Stone Mason - Setters - Third 750 Hours**



OFFICE OF THE COMPTROLLER, CITY OF NEW YORK  
\$220 APPRENTICESHIP PREVAILING WAGE SCHEDULE

Effective Period: 7/1/2016 - 6/30/2017  
Wage Rate Per Hour: 70% of Journeyperson's rate  
Supplemental Rate Per Hour: 50% of Journeyperson's rate

**Stone Mason - Setters - Fourth 750 Hours**

Effective Period: 7/1/2016 - 6/30/2017  
Wage Rate Per Hour: 80% of Journeyperson's rate  
Supplemental Rate Per Hour: 50% of Journeyperson's rate

**Stone Mason - Setters - Fifth 750 Hours**

Effective Period: 7/1/2016 - 6/30/2017  
Wage Rate Per Hour: 90% of Journeyperson's rate  
Supplemental Rate Per Hour: 50% of Journeyperson's rate

**Stone Mason - Setters - Sixth 750 Hours**

Effective Period: 7/1/2016 - 6/30/2017  
Wage Rate Per Hour: 100% of Journeyperson's rate  
Supplemental Rate Per Hour: 50% of Journeyperson's rate

(Bricklayers District Council)

---

**TAPER**

(Ratio of Apprentice to Journeyperson: 1 to 1, 1 to 4)

**Drywall Taper - First Year**

Effective Period: 7/1/2016 - 6/30/2017  
Wage and Supplemental Rate Per Hour: 40% of Journeyperson's rate

**Drywall Taper - Second Year**

Effective Period: 7/1/2016 - 6/30/2017  
Wage and Supplemental Rate Per Hour: 60% of Journeyperson's rate

**Drywall Taper - Third Year**

Effective Period: 7/1/2016 - 6/30/2017  
Wage and Supplemental Rate Per Hour: 80% of Journeyperson's rate

(Local #1974)

---

OFFICE OF THE COMPTROLLER, CITY OF NEW YORK  
§220 APPRENTICESHIP PREVAILING WAGE SCHEDULE

---

**TILE LAYER - SETTER**

(Ratio of Apprentice to Journeyman: 1 to 1, 1 to 4)

**Tile Layer - Setter - First 750 Hours**

Effective Period: 7/1/2016 - 6/30/2017

Wage and Supplemental Rate Per Hour: 50% of Journeyman's rate

**Tile Layer - Setter - Second 750 Hours**

Effective Period: 7/1/2016 - 6/30/2017

Wage and Supplemental Rate Per Hour: 55% of Journeyman's rate

**Tile Layer - Setter - Third 750 Hours**

Effective Period: 7/1/2016 - 6/30/2017

Wage and Supplemental Rate Per Hour: 65% of Journeyman's rate

**Tile Layer - Setter - Fourth 750 Hours**

Effective Period: 7/1/2016 - 6/30/2017

Wage and Supplemental Rate Per Hour: 75% of Journeyman's rate

**Tile Layer - Setter - Fifth 750 Hours**

Effective Period: 7/1/2016 - 6/30/2017

Wage and Supplemental Rate Per Hour: 85% of Journeyman's rate

**Tile Layer - Setter - Sixth 750 Hours**

Effective Period: 7/1/2016 - 6/30/2017

Wage and Supplemental Rate Per Hour: 95% of Journeyman's rate

(Local #7)

---

**TIMBERPERSON**

(Ratio of Apprentice to Journeyman: 1 to 1, 1 to 6)

**Timberperson - First Year**

**OFFICE OF THE COMPTROLLER, CITY OF NEW YORK  
§220 APPRENTICESHIP PREVAILING WAGE SCHEDULE**

**Effective Period: 7/1/2016 - 6/30/2017  
Wage Rate Per Hour: 40% of Journeyperson's rate  
Supplemental Rate Per Hour: \$32.33**

**Timberperson - Second Year**

**Effective Period: 7/1/2016 - 6/30/2017  
Wage Rate Per Hour: 50% of Journeyperson's rate  
Supplemental Rate Per Hour: \$32.33**

**Timberperson - Third Year**

**Effective Period: 7/1/2016 - 6/30/2017  
Wage Rate Per Hour: 65% of Journeyperson's rate  
Supplemental Rate Per Hour: \$32.33**

**Timberperson - Fourth Year**

**Effective Period: 7/1/2016 - 6/30/2017  
Wage Rate Per Hour: 80% of Journeyperson's rate  
Supplemental Rate Per Hour: \$32.33**

**(Local #1536)**

OFFICE OF THE COMPTROLLER, CITY OF NEW YORK  
§6-109 PREVAILING WAGE SCHEDULE

---

**NYC ADMINISTRATIVE CODE § 6-109 SCHEDULE OF "LIVING WAGES"**

Contractors who provide the following services to the City of New York must post a copy of this Living Wage Schedule at their work site(s) as required by New York City Administrative Code § 6-109:

- Building Services,
- Day Care Services,
- Food Services,
- Head Start Services,
- Homecare Services,
- Services to Persons with Cerebral Palsy, and
- Temporary Services.

In accordance with NYC Administrative Code § 6-109, the Comptroller of the City of New York promulgated this schedule of living wages for the above services on contracts for non-emergency work in excess of the small purchase limit set by the Procurement Policy Board; contracting agencies must annex this schedule to such contracts.

This schedule is a compilation of separate determinations of the prevailing rate of wage and supplements made by the Comptroller for each trade classification listed herein pursuant to New York City Administrative Code section 6-109. The source of the wage and supplement rates, whether a collective bargaining agreement, survey data or other, is listed at the end of each classification.

A city service contractor or subcontractor that provides homecare services, day care services, head start services or services to persons with cerebral palsy must pay its covered employees that directly render such services in performance of the city service contract or subcontract no less than the living wage and must provide its employees health benefits (supplemental benefits) or must supplement their hourly wage rate by an amount no less than the health benefits supplement rate. This requirement applies for each hour that the employee works performing the city service contract or subcontract.

A city service contractor or subcontractor that provides building services, food services or temporary services must pay its employees that are engaged in performing the city service contract or subcontract no less than the living wage or the prevailing wage, whichever is greater. Where the living wage is greater than the prevailing wage, the city service contractor or subcontractor must either provide its employees health benefits or must supplement their hourly wage rate by an amount no less than the health benefits supplement rate. Where the prevailing wage is greater than the living wage, the city service contractor or subcontractor must provide its employees the prevailing wage and supplements. These requirements apply for each hour that the employee works performing the city service contract or subcontract.

The appropriate schedule of living wages must be posted at all work sites pursuant to NYC Administrative Code 6-109.

The schedule is applicable for work performed during the effective period, unless otherwise noted. You will be notified of any changes to this schedule by addenda published on our web site [www.comptroller.nyc.gov](http://www.comptroller.nyc.gov). Schedules for future one-year periods will be published annually in the City Record on or about July 1<sup>st</sup> of each succeeding year and on our web site [www.comptroller.nyc.gov](http://www.comptroller.nyc.gov).

OFFICE OF THE COMPTROLLER, CITY OF NEW YORK  
§6-109 PREVAILING WAGE SCHEDULE

The living wage rate and the health benefit supplement rate are known through June 30 of each year and those rates are listed in this schedule.

The living wage rates listed in this schedule may not include all hourly wage calculations for overtime, shift differential, Holiday, Saturday, Sunday or other premium time work. Similarly, this schedule does not set forth every living wage practice with which employers must comply.

Some of the rates in this schedule are based on collective bargaining agreements. These agreements are available for inspection by appointment. Requests for appointments may be made by calling (212) 669-4443, Monday through Friday between the hours of 9 a.m. and 5 p.m.

Answers to questions concerning prevailing wage practices may be obtained from the Classification Unit by calling (212) 669-7974. Please direct all other compliance issues to; Bureau of Labor Law, Attn: Wasyl Kinach, P.E., Office of the Comptroller, 1 Centre Street, Room 1122, New York, N.Y. 10007; Fax (212) 669-4002.

Contractors are solely responsible for maintaining original payroll records, which delineate, among other things, the hours each employee worked within a given classification. Contractors using rates and/or classifications not promulgated by the Comptroller do so at their own risk. Additionally, prior to bid, an agency's chief contracting officer must contact the Bureau of Labor Law to obtain a wage determination for a work classification not published in this schedule.

The information listed below is intended to assist you in meeting your living wage and prevailing wage obligation. Contractors are advised to review the Comptroller's Living Wage Schedule prior to submitting a bid for City work. Any wage rate error made by the contracting agency in the contract documents will not preclude a finding against the contractor for an underpayment of the applicable living wage or the applicable prevailing wage.

This schedule sets forth the living wage and benefit rates required to be annexed to and form part of the contract specifications for work covered by New York City Administrative Code § 6-109. Contractors performing such work are required to pay not less than the rates specified in this schedule for the applicable trade or occupation.

**Benefits are paid for EACH HOUR WORKED unless otherwise noted.**

Wasyl Kinach, P.E.  
Director of Classifications  
Bureau of Labor Law

OFFICE OF THE COMPTROLLER, CITY OF NEW YORK  
§6-109 PREVAILING WAGE SCHEDULE

**TABLE OF CONTENTS**

<b><u>CLASSIFICATION</u></b>	<b><u>PAGE</u></b>
BUILDING CLEANER AND MAINTAINER (OFFICE).....	4
BUILDING CLEANER AND MAINTAINER (RESIDENTIAL).....	4
CLEANER (PARKING GARAGE) .....	4
DAY CARE SERVICES.....	4
FOOD SERVICE EMPLOYEES .....	4
HEAD START SERVICES .....	5
HOMECARE SERVICES .....	6
LANDSCAPING AND GROUNDSKEEPING WORKER.....	6
SECURITY GUARD (ARMED).....	6
SECURITY GUARD (UNARMED) .....	6
SERVICES TO PERSONS WITH CEREBRAL PALSY.....	7
TEMPORARY OFFICE SERVICES .....	7
WINDOW CLEANER .....	8

OFFICE OF THE COMPTROLLER, CITY OF NEW YORK  
§6-109 PREVAILING WAGE SCHEDULE

**BUILDING CLEANER AND MAINTAINER (OFFICE)**

For the above building service classification, see the Labor Law Section 230 Schedule.

---

---

**BUILDING CLEANER AND MAINTAINER (RESIDENTIAL)**

For the above building service classification, see the Labor Law Section 230 Schedule.

---

---

**CLEANER (PARKING GARAGE)**

For the above building service classification, see the Labor Law Section 230 Schedule.

---

---

**DAY CARE SERVICES**

**Day Care Services**

'Day Care Services' means provision of day care services through the city's center-based day care program administered under contract with the city's Administration for Children's Services. No other day care programs shall be covered, including family-based day care programs administered by city-contracted day care centers.

Effective Period: 7/1/2016 - 6/30/2017

Wage Rate per Hour: \$10.00

Supplemental Benefit Rate per Hour: \$1.50

(NYC Administrative Code §6-109)

---

---

**FOOD SERVICE EMPLOYEES**

**Cook**

OFFICE OF THE COMPTROLLER, CITY OF NEW YORK  
§6-109 PREVAILING WAGE SCHEDULE

Effective Period: 7/1/2016 - 6/30/2017  
Wage Rate per Hour: \$16.81  
Supplemental Benefit Rate per Hour: \$1.75

**Cafeteria Attendant**

Effective Period: 7/1/2016 - 6/30/2017  
Wage Rate per Hour: \$12.81  
Supplemental Benefit Rate per Hour: \$1.75

**Counter Attendant**

Effective Period: 7/1/2016 - 6/30/2017  
Wage Rate per Hour: \$12.24  
Supplemental Benefit Rate per Hour: \$1.75

**Kitchen Helper / Dishwasher**

Effective Period: 7/1/2016 - 6/30/2017  
Wage Rate per Hour: \$11.94  
Supplemental Benefit Rate per Hour: \$1.75

**Overtime**

Time and one half the regular hourly rate after 40 hours in any work week.

(Based on data from NYS Department of Labor Occupational Employment Statistics and US Department of Labor Bureau of Labor Statistics)

---

**HEAD START SERVICES**

**Head Start Services**

'Head Start Services' means provision of head start services through the city's center-based head start program administered under contract with the city's Administration for Children's Services. No other head start programs shall be covered.

Effective Period: 7/1/2016 - 6/30/2017  
Wage Rate per Hour: \$10.00  
Supplemental Benefit Rate per Hour: \$1.50

(NYC Administrative Code §6-109)

---



## **HEMOCARE SERVICES**

### **Home Care Services**

'Homecare Services' means the provision of homecare services under the city's Medicaid Personal Care/Home Attendant or Housekeeping Programs, including but not limited to the In-Home Services for the Elderly Programs administered by the Department for the Aging.

For homecare services provided under the Personal Care Services program, the wage and supplemental benefit rate above shall apply only as long as the state and federal government maintain their combined aggregate proportionate share of funding and approved rates for homecare services in effect as of the date of the enactment of this section.

For contractors or subcontractors providing homecare services, the supplemental benefit rate may be waived by the terms of a bona fide collective bargaining agreement with respect to employees who have never worked a minimum of eighty (80) hours per month for two consecutive months for that covered employer, but such provision may not be waived for any employee once a minimum of eighty (80) hours for two consecutive months has been achieved.

Effective Period: 7/1/2016 - 6/30/2017

Wage Rate per Hour: \$10.00

Supplemental Benefit Rate per Hour: \$1.50

(NYC Administrative Code §6-109)

---

## **LANDSCAPING AND GROUNDSKEEPING WORKER**

For the above building service classification, see the Labor Law Section 230 Schedule.

---

## **SECURITY GUARD (ARMED)**

For the above building service classification, see the Labor Law Section 230 Schedule.

---

## **SECURITY GUARD (UNARMED)**

For the above building service classification, see the Labor Law Section 230 Schedule.

---

OFFICE OF THE COMPTROLLER, CITY OF NEW YORK  
§6-109 PREVAILING WAGE SCHEDULE

---

---

## **SERVICES TO PERSONS WITH CEREBRAL PALSY**

### **Services To Person With Cerebral Palsy**

'Services to Persons with Cerebral Palsy' means provision of services which enable persons with cerebral palsy and related disabilities to lead independent and productive lives through an agency that provides health care, education, employment, housing and technology resources to such persons under contract with the city or the department of education.

Effective Period: 7/1/2016 - 6/30/2017

Wage Rate per Hour: \$10.00

Supplemental Benefit Rate per Hour: \$1.50

(NYC Administrative Code §6-109)

---

---

## **TEMPORARY OFFICE SERVICES**

### **Administrative Assistant**

Effective Period: 7/1/2016 - 6/30/2017

Wage Rate per Hour: \$34.97

Supplemental Benefit Rate per Hour: None

### **Cashier**

Effective Period: 7/1/2016 - 6/30/2017

Wage Rate per Hour: \$11.50

Supplemental Benefit Rate per Hour: None

### **Clerk (various)**

Effective Period: 7/1/2016 - 6/30/2017

Wage Rate per Hour: \$16.07

Supplemental Benefit Rate per Hour: None

### **Computer Assistant**

Effective Period: 7/1/2016 - 6/30/2017

Wage Rate per Hour: \$19.07

Supplemental Benefit Rate per Hour: None

OFFICE OF THE COMPTROLLER, CITY OF NEW YORK  
§6-109 PREVAILING WAGE SCHEDULE

**Data Entry Operator**

Effective Period: 7/1/2016 - 6/30/2017  
Wage Rate per Hour: **\$16.70**  
Supplemental Benefit Rate per Hour: None

**Receptionist**

Effective Period: 7/1/2016 - 6/30/2017  
Wage Rate per Hour: **\$15.78**  
Supplemental Benefit Rate per Hour: None

**Secretary (various)**

Effective Period: 7/1/2016 - 6/30/2017  
Wage Rate per Hour: **\$20.22**  
Supplemental Benefit Rate per Hour: None

**Word Processor**

Effective Period: 7/1/2016 - 6/30/2017  
Wage Rate per Hour: **\$20.32**  
Supplemental Benefit Rate per Hour: None

**Overtime**

Time and one half the regular hourly rate after 40 hours in any work week.

(Based on data from NYS Department of Labor Occupational Employment Statistics and US Department of Labor Bureau of Labor Statistics or NYC Administrative Code §6-109)

---

---

**WINDOW CLEANER**

For the above building service classification, see the Labor Law Section 230 Schedule.



Leonard A. Mancusi  
SENIOR ASSISTANT COMPTROLLER

THE CITY OF NEW YORK  
OFFICE OF THE COMPTROLLER  
1 CENTRE STREET ROOM 1120  
NEW YORK, N.Y. 10007-2341

TELEPHONE: (212) 669-3622  
FAX NUMBER: (212) 669-8499

ALAN G. HEVESI  
COMPTROLLER

**MEMORANDUM**

November 6, 2000

To Agency Chief Contracting Officers

From: Leonard A. Mancusi *[Signature]*

Re: Security at Construction Sites

Prior to the enactment of Administrative Code §6-109, security guards on construction sites were not subject to prevailing wages. Security guards under the New York State labor law are covered under §230 which provides that prevailing wages are to be paid for security guards in existing buildings. §6-109 of the Administrative Code which was enacted in 1996 closed this loophole by including all security guards working pursuant to a city contract as a prevailing wage trade.

Although some construction contract boilerplate language has been amended to include §6-109, sub-contractors performing security services have advised us that they were not aware of this provision and, since traditionally, security guards were not a covered trade on construction sites, and they were not advised by a prime contractor that they would have to pay prevailing wages, they have not been doing so.

To avoid the possibility of issuing stop payments against prime contractors for the failure of their security service sub-contractors to pay

*prevailing wages, we suggest that you write to all your existing security guard sub-contractors and their primes and in the future, upon approval of a security guard sub-contractor, advise the contractors of their obligation to pay prevailing wages under §6-109 of the Administrative Code.*

*As always, your cooperation is appreciated.*

**-LAM:er**  
**ACCO.SECURITY AT SITES**



**SCHEDULE A****(GENERAL CONDITIONS TO CONSTRUCTION CONTRACT  
(INCLUDING GENERAL CONDITIONS RELATED TO ARTICLE 22 – INSURANCE)****PART I. REQUIRED INFORMATION**

<p align="center"><b><u>INFORMATION FOR BIDDERS SECTION 26 BID SECURITY</u></b></p> <p><u>The Contractor shall obtain a bid security in the amount indicated to the right.</u></p>	<p>Required provided the TOTAL BID PRICE set forth on the Bid Form is \$1,000,000. or more.</p> <p>Certified Check: 5% of Bid Amount or Bond: 10% of Bid Amount</p>
<p align="center"><b><u>INFORMATION FOR BIDDERS SECTION 26 PERFORMANCE AND PAYMENT BONDS</u></b></p> <p><u>The Contractor shall obtain performance and payment bonds in the amount indicated to the right.</u></p>	<p>Required for contracts in the amount of \$1,000,000 or more.</p> <p>Performance Security and Payment Security shall each be in an amount equal to 100% of the Contract Price.</p>
<p align="center"><b><u>INFORMATION FOR BIDDERS DEPARTMENT OF DESIGN AND CONSTRUCTION SAFETY REQUIREMENTS</u></b></p> <p><u>The Contractor shall provide the safety personnel as indicated to the right.</u></p>	<p><input checked="" type="checkbox"/> Project Safety Representative</p> <p><input type="checkbox"/> Dedicated, full-time Project Safety Manager</p>
<p align="center"><b><u>CONTRACT ARTICLE 14 DATE FOR SUBSTANTIAL COMPLETION</u></b></p> <p><u>The Contractor shall substantially complete the Work in the number of calendar days indicated to the right.</u></p>	<p>See Page SA-4</p>
<p align="center"><b><u>CONTRACT ARTICLE 15 LIQUIDATED DAMAGES</u></b></p> <p><u>If the Contractor fails to substantially complete the Work within the time fixed for substantial completion plus authorized time extensions or if the Contractor, in the sole determination of the Commissioner, has abandoned the Work, the Contractor shall pay to the City the amount indicated to the right.</u></p>	<p>\$4,000.00 for each consecutive calendar day over substantial completion time</p>
<p align="center"><b><u>CONTRACT ARTICLE 17. SUB-CONTRACTOR</u></b></p> <p><u>The Contractor shall not make subcontracts totaling an amount more than the percentage of the total Contract price indicated to the right.</u></p>	<p>Not to exceed <u>49</u> % of the Contract price</p>

<p align="center"><b><u>CONTRACT ARTICLE 21.</u></b> <b><u>RETAINAGE</u></b></p> <p>The <b>Commissioner</b> shall deduct and retain until the substantial completion of the <b>Work</b> the percent value of the <b>Work</b> indicated to the right.</p>	<p><u>0</u> % of the value of the <b>Work</b></p>
<p align="center"><b><u>CONTRACT ARTICLE 22.</u></b> <b><u>(Per Directions Below)</u></b></p>	<p>See pages SA-5 through SA-13</p>
<p align="center"><b><u>CONTRACT ARTICLE 24.</u></b> <b><u>DEPOSIT GUARANTEE</u></b></p> <p>As security for the faithful performance of its obligations, the <b>Contractor</b>, upon filing its requisition for payment on <b>Substantial Completion</b>, shall deposit with the <b>Commissioner</b> a sum equal to the percentage of the <b>Contract</b> price indicated to the right.</p>	<p>1% of <b>Contract</b> price</p>
<p align="center"><b><u>CONTRACT ARTICLE 24.</u></b> <b><u>PERIOD OF GUARANTEE</u></b></p> <p>Periods of maintenance and guarantee other than the period set forth in Article 24.1 are indicated to the right.</p>	<p>Twenty-four (24) Months for Tree Planting</p>
<p align="center"><b><u>CONTRACT ARTICLE 74.</u></b> <b><u>STATEMENT OF WORK</u></b></p> <p>The <b>Contractor</b> shall furnish all labor and materials and perform all <b>Work</b> in strict accordance with the <b>Contract Drawings</b>, <b>Specifications</b>, and all <b>Addenda</b> thereto, as shown in the column to the right.</p>	<p><b>Addenda</b>, numbered:</p> <hr/>
<p align="center"><b><u>CONTRACT ARTICLE 75.</u></b> <b><u>COMPENSATION TO BE PAID TO CONTRACTOR</u></b></p> <p>The <b>City</b> shall pay and the <b>Contractor</b> shall accept in full consideration for the performance of the <b>Contract</b>, subject to additions and deductions as provided herein, the total sum shown in the column to the right, being the amount at which the <b>Contract</b> was awarded to the <b>Contractor</b> at a public letting thereof, based upon the <b>Contractor's</b> bid for the <b>Contract</b>.</p>	<p>Amount for which the <b>Contract</b> was Awarded:</p> <hr/> <p align="right">Dollars</p> <p>(\$ _____ )</p>
<p align="center"><b><u>CONTRACT ARTICLE 79.</u></b> <b><u>PARTICIPATION BY MINORITY-OWNED AND WOMEN-OWNED BUSINESS ENTERPRISES IN CITY PROCUREMENT</u></b></p>	<p>FHWA DBE goal of 13%, see page TF-D1, herein this book Volume 3 of 3</p>



<p align="center"><b><u>STANDARD HIGHWAY SPECIFICATIONS</u></b> <b><u>SECTION 6.40</u></b> <b><u>LIQUIDATED DAMAGES FOR ENGINEER'S FIELD OFFICE</u></b></p> <p>If the Contractor fails to satisfactorily provide the field office and all equipment specified in <b>Section 6.40 - Engineer's Field Office</b>, and/or if a cited deficiency exceed seventy two (72) hours after notice from the Engineer in writing, or is permitted to recur, liquidated damages will be assessed in the amount specified herein for each subsequent calendar day or part thereof that a cited deficiency resulting in nonpayment, as described in <b>Section 6.40.5</b>, is not corrected.</p>	<p>\$ <u>500.00</u> for each calendar day of deficiency</p>
<p align="center"><b><u>STANDARD HIGHWAY SPECIFICATIONS</u></b> <b><u>SECTION 6.70</u></b> <b><u>LIQUIDATED DAMAGES FOR MAINTENANCE AND PROTECTION OF TRAFFIC</u></b></p>	<p>\$ <u>250.00</u> for each instance of failure to comply with the Maintenance and Protection of Traffic requirements within three (3) hours after written notice from the Engineer.</p> <p>\$ <u>500.00</u> for each and every hour of failing to open the entire width of roadway to traffic the morning following a night/weekend work operation.</p>
<p align="center"><b><u>STANDARD HIGHWAY SPECIFICATIONS</u></b> <b><u>SECTION 7.13</u></b> <b><u>LIQUIDATED DAMAGES FOR MAINTENANCE OF SITE</u></b></p> <p>If the Contractor fails to comply, within three (3) consecutive hours after written notice from the Engineer, with the requirements of <b>Section 7.13 - Maintenance of Site</b>, the Contractor shall pay to the City of New York, until such notice has been complied with or rescinded, the sum specified above per calendar day, for each instance of such failure, as liquidated damages and not as a penalty, for such default.</p>	<p>\$ <u>800.00</u> for each calendar day, for each occurrence</p>

**Date for Substantial Completion (Reference: Article 14)**

The Contractor shall substantially complete the Work within the Final Contract Duration determined in accordance with the terms and conditions set forth herein.

The Base Contract Duration for this project is 730 consecutive calendar days ("ccds").

The Final Contract Duration shall be the Base Contract Duration when a check mark is indicated before the word "NO", below, and shall be the Base Contract Duration adjusted by the table set forth below when a check mark is indicated before the word "YES", below.

YES                       NO

When the Final Contract Duration is indicated above to be adjusted by the table below, the table may increase the Base Contract Duration depending on the date of scheduled substantial completion to avoid a scheduled substantial completion of the Work during the winter months. The date of scheduled substantial completion shall be determined by adding the Base Contract Duration to the date specified to commence work in the written Notice to Proceed. The Final Contract Duration shall then be determined as follows:

- (a) Find the row that corresponds to the month of substantial completion based on the Base Contract Duration added to the date specified to commence work in the written Notice to Proceed.
- (b) Find the number of days to be added to the Base Contract Duration in the table below. Add that number of days to the Base Contract Duration to obtain the Final Contract Duration in consecutive calendar days.

Month of Substantial Completion based on the Base Contract Duration	Number of Days of adjustment
January	150
February	120
March	90
April	60
May	30
June	0
July	0
August	0
September	0
October	0
November – December 15	0
December 16 – December 31	180

In addition, should Item No. 9.30, "Storm Water Pollution Prevention," exist in the Contract and the required Storm Water Pollution Prevention Plan (SWPPP) does not conform to NYSDEC's recommended Standards, an additional 60 ccd shall be added to the above Final Contract Duration.

**(GENERAL CONDITIONS RELATING TO ARTICLE 22 – INSURANCE)**

**PART II. TYPES OF INSURANCE, MINIMUM LIMITS AND SPECIAL CONDITIONS**

**Note:** All certificate(s) of insurance submitted pursuant to Contract Article 22.3. 3 must be accompanied by a Certification by Broker consistent with Part III below and include the following information:

- For each insurance policy, the name and NAIC number of issuing company, number of policy, and effective dates;
- Policy limits consistent with the requirements listed below;
- Additional insureds or loss payees consistent with the requirements listed below; and
- The number assigned to the Contract by the City (in the “Description of Operations” field).

Insurance indicated by a blackened box (■) or by X in a □ to left will be required under this contract

Types of Insurance (per Article 22 in its entirety, including listed paragraph)	Minimum Limits and Special Conditions
<p>■ Commercial General Liability Art. 22.1.1</p>	<p>The minimum limits shall be \$ <u>3,000,000</u> per occurrence and \$ <u>6,000,000</u> per project aggregate applicable to this <b>Contract</b>.</p> <p>Additional Insureds:</p> <ol style="list-style-type: none"> <li>1. City of New York, including its officials and employees, with coverage at least as broad as ISO Form CG 20 10 and CG 20 37,</li> <li>2. All person(s) or organization(s), if any, that Article 22.1.1(b) of the <b>Contract</b> requires to be named as Additional Insured(s), with coverage at least as broad as ISO Form CG 20 26. The Additional Insured endorsement shall either specify the entity's name, if known, or the entity's title (e.g., Project Manager),</li> <li>3. All person(s) or organization(s) serving in the functions defined in Article 2, such as: Engineer, Architect, Project Manager, Resident Engineer, etc.</li> <li>4. New York State, including its officials and employees,</li> <li>5. Federal Highway Administration (FHWA), its officials and employees.</li> <li>6. National Grid</li> </ol>

<ul style="list-style-type: none"><li><input checked="" type="checkbox"/> Workers' Compensation                      Art. 22.1.2</li><li><input checked="" type="checkbox"/> Disability Benefits Insurance              Art. 22.1.2</li><li><input checked="" type="checkbox"/> Employers' Liability                          Art. 22.1.2</li><li><input type="checkbox"/> Jones Act    Art. 22.1.3</li><li><input type="checkbox"/> U.S. Longshoremen's and Harbor Workers Compensation Act                      Art. 22.1.3</li></ul>	<p>Workers' Compensation, Employers' Liability, and Disability Benefits Insurance: Statutory per New York State law without regard to jurisdiction.</p> <p>Note: The following forms are acceptable: (1) New York State Workers' Compensation Board Form No. C-105.2, (2) State Insurance Fund Form No. U-26.3, (3) New York State Workers' Compensation Board Form No. DB-120.1 and (4) Request for WC/DB Exemption Form No. CE-200. The City will not accept an ACORD form as proof of Workers' Compensation or Disability Insurance.</p> <p>Jones Act and U.S. Longshoremen's and Harbor Workers' Compensation Act: Statutory per U.S. Law.</p> <ul style="list-style-type: none"><li>■ Additional Requirements:<ul style="list-style-type: none"><li>(1) NYCT "OUTSIDE CONTRACT" INSURANCE REQUIREMENTS: Workers' Compensation Insurance (including Employer's Liability Insurance) with limits of not less than \$2,000,000, which limit may be met by a combination of primary and excess insurance meeting the statutory limits of New York State.</li><li>(2) Two (2) certificates of such insurance shall be furnished to the Director, Risk Management, MTA Risk and Insurance Management Standards, Enforcement and Claims Unit, 2 Broadway, 21st Floor, New York, NY 10004.</li></ul></li></ul>
---	---

<p><input type="checkbox"/> Builders' Risk</p> <p>Art. 22.1.4</p>	<p><input type="checkbox"/> Required: 100% of total bid amount</p> <p><input type="checkbox"/> Required: 100 % of total bid amount for Item(s):</p> <p><b>Contractor</b> the Named Insured; the <b>City</b> both an Additional Insured and one of the loss payees as its interests may appear.</p> <p>If the <b>Work</b> does not involve construction of a new building or gut renovation work, the <b>Contractor</b> may provide an installation floater in lieu of Builders Risk insurance.</p> <p>Note: Builders Risk Insurance may terminate upon <b>Substantial Completion</b> of the <b>Work</b> in its entirety.</p>
<p><input checked="" type="checkbox"/> Commercial Auto Liability</p> <p>Art. 22.1.5</p>	<p><u>\$ 2,000,000</u> per accident combined single limit</p> <p>If vehicles are used for transporting hazardous materials, the <b>Contractor</b> shall provide pollution liability broadened coverage for covered vehicles (endorsement CA 99 48) as well as proof of MCS 90</p> <p>Additional Insureds:</p> <ul style="list-style-type: none"> <li>(1) City of New York, including its officials and employees, and</li> <li>(2) New York State, including its officials and employees, and,</li> <li>(3) FHWA, including its officials and employees.</li> </ul>

<input type="checkbox"/> Contractors Pollution Liability Art. 22.1.6	<p>\$ <u>5,000,000</u> per occurrence          \$ <u>5,000,000</u> aggregate</p> <p>Additional Insureds:          1. City of New York, including its officials and employees, and          2. _____          3. _____</p>
<input type="checkbox"/> Marine Protection and Indemnity Art. 22.1.7(a)	<p>\$ _____ each occurrence          \$ _____ aggregate</p> <p>Additional Insureds:          1. City of New York, including its officials and employees, and          2. _____          3. _____</p>
<input type="checkbox"/> Hull and Machinery Insurance Art. 22.1.7(b)	<p>\$ _____ per occurrence          \$ _____ aggregate</p> <p>Additional Insureds:          1. City of New York, including its officials and employees, and          2. _____          3. _____</p>
<input type="checkbox"/> Marine Pollution Liability Art. 22.1.7(c)	<p>\$ <u>1,000,000</u> per occurrence          \$ <u>1,000,000</u> aggregate</p> <p>Additional Insureds:          1. City of New York, including its officials and employees, and          2. _____          3. _____</p>

<p>[OTHER] <span style="float: right;">Art. 22.1.8</span></p> <p>■ <b>Railroad Protection Liability Policy</b></p> <p>(ISO-RIMA or equivalent form) approved by Permitter covering the work to be performed at the designated site and affording protection for damages arising out of bodily injury or death, physical damage to or destruction of property, including damage to the Insured's own property and conforming to the following:</p> <ul style="list-style-type: none"> <li>• Policy Endorsement CG 28 31 - Pollution Exclusion Amendment is required to be endorsed onto the policy when environmental-related work and/or exposures exist.</li> <li>• Indicate the Name and address of the Contractor to perform the work, the Contract # and the name of the railroad property where the work is being performed and the Agency Permit.</li> <li>• Evidence of Railroad Protective Liability Insurance, must be provided in the form of the <u>Original Policy. A detailed Insurance Binder (ACORD or Manuscript Form) will be accepted pending issuance of the Original Policy, which must be provided within 30 days of the Binder Approval.</u></li> </ul>	<p>\$ <u>2,000,000</u> per occurrence</p> <p>\$ <u>6,000,000</u> annual aggregate</p> <p>Named Insureds:</p> <ol style="list-style-type: none"> <li>1. New York City Transit Authority (NYCTA), the Manhattan and Bronx Surface Transit Operation Authority (MaBSTOA), the Staten Island Rapid Transit Operation Authority (SIRTOA), MTA Capital Construction Co., the Metropolitan Transportation Authority (MTA) including its subsidiaries and affiliates, and the City of New York (as Owner) and all other indemnified parties.</li> </ol>
---	---

<p>[OTHER] <span style="float: right;">Art. 22.1.8</span></p> <p><input type="checkbox"/> Professional Liability</p> <p>A. The Contractor's Professional Engineer shall maintain and submit evidence of Professional Liability Insurance in the minimum amount of \$1,000,000 per claim. The policy or policies shall include an endorsement to cover the liability assumed by the Contractor under this Contract arising out of the negligent performance of professional services or caused by an error, omission or negligent act of the Contractor's Professional Engineer or anyone employed by the Contractor's Professional Engineer.</p> <p>B. Claims-made policies will be accepted for Professional Liability Insurance. All such policies shall have an extended reporting period option or automatic coverage of not less than two (2) years. If available as an option, the Contractor's Professional Engineer shall purchase extended reporting period coverage effective on cancellation or termination of such insurance unless a new policy is secured with a retroactive date, including at least the last policy year.</p>	
<p>[OTHER] <span style="float: right;">Art. 22.1.8</span></p> <p><input checked="" type="checkbox"/> Engineer's Field Office</p> <p><b>Section 6.40, Standard Highway Specifications</b></p>	<p>Fire insurance, extended coverage and vandalism, malicious mischief and burglary, and theft insurance coverage in the amount of <u>\$40,000</u></p>
<p>[OTHER] <span style="float: right;">Art. 22.1.8</span></p> <p><input type="checkbox"/> The Following Additional Insurance Must Be Provided:</p> <p><b>Umbrella/Excess Liability Insurance</b> - The Contractor shall provide Umbrella/Excess Liability Insurance in the minimum amount of \$10,000,000 per Occurrence and \$10,000,000 in Aggregate. The policy terms and condition should be at least as broad as the underlying policies. The underlying policies should comply with the insurance provision as outlined by the contract. Defense cost should be in addition to the limit of liability. The City of New York, including its officials and employees, should be included as additional insured as respects to the noted project.</p>	



**SCHEDULE A**  
**(GENERAL CONDITIONS TO CONSTRUCTION CONTRACT)**  
**(GENERAL CONDITIONS RELATING TO ARTICLE 22 – INSURANCE)**

**PART III. CERTIFICATES OF INSURANCE**

All certificates of insurance (except certificates of insurance solely evidencing Workers' Compensation Insurance, Employer's Liability Insurance, and/or Disability Benefits Insurance) must be accompanied by one of the following:

- (1) the Certification by Insurance Broker or Agent on the following page setting forth the required information and signatures;

-- OR --

- (2) copies of all policies as certified by an authorized representative of the issuing insurance carrier that are referenced in such certificate of insurance. If any policy is not available at the time of submission, certified binders may be submitted until such time as the policy is available, at which time a certified copy of the policy shall be submitted.



**SCHEDULE A**

**(GENERAL CONDITIONS TO CONSTRUCTION CONTRACT)**

**PART IV. ADDRESS OF COMMISSIONER**

Wherever reference is made in Article 7 or Article 22 to documents to be sent to the **Commissioner** (e.g., notices, filings, or submissions), such documents shall be sent to the address set forth below or, in the absence of such address, to the **Commissioner's** address as provided elsewhere in this **Contract**.

\_\_\_\_\_  
DDC Director, Insurance Risk Manager

\_\_\_\_\_  
30 – 30 Thomson Avenue, 4th Floor (IDCNY Building)

\_\_\_\_\_  
Long Island City, NY 11101

\_\_\_\_\_

(NO FURTHER TEXT ON THIS PAGE)

**Project ID.: SANDHW11**

**(NO TEXT ON THIS PAGE)**



ATTACH TO CONTRACT DOCUMENTS

THE CITY OF NEW YORK  
DEPARTMENT OF DESIGN AND CONSTRUCTION  
INFRASTRUCTURE DIVISION  
BUREAU OF DESIGN

PROJECT ID: SANDHW11

RECONSTRUCTION OF

BEACH CHANNEL DRIVE  
BETWEEN BEACH 116TH STREET AND BEACH 124TH STREET

INCLUDING SEWER, WATER MAIN, YTAFFIC SIGNAL  
AND STREET LIGHTING WORK

Together With All Work Incidental Thereto

BOROUGH OF QUEENS  
CITY OF NEW YORK

ADDENDUM NO. 1

DATED: March 24, 2017

THIS ADDENDUM IS HEREBY MADE A PART OF THE CONTRACT DOCUMENTS

1. Refer to the Bid and Contract Documents, VOLUME 1 OF 3, Attachment 1 - Bid Information on Page A-1;  
Change the dates shown for Submission of Bids and for Bid Opening from "March 31, 2017" to read "April 13, 2017".
2. Refer to the Bid and Contract Documents, VOLUME 1 OF 3, SCHEDULE B - M/WBE Utilization Plan on Page 13;  
Change the date shown for Bid/Proposal Response Date from "March 31, 2017" to read "April 13, 2017"
3. For additional information, see the attached ONE (1) page of "Questions Submitted by Bidders and DDC's Responses".

END OF ADDENDUM NO. 1

By signing in the space provided below, the bidder acknowledges receipt of this Addendum consisting of ONE (1) page and ONE (1) page Attachment.

THIS ADDENDUM MUST BE SIGNED BY ALL BIDDERS AND ATTACHED TO THEIR BID

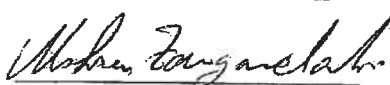

MOHSEN ZARGARELAHI, P.E.  
Assistant Commissioner

104 Alpha & Jm

Name of Bidder

By: \_\_\_\_\_



Questions Submitted by Bidders and DDC's Responses

QUESTION #1: There are Buy America requirements in this bid according to Attachment E in Book 3. However, in the Bid Submission Requirements in Book 1, there is no requirement for a Buy America Certification, and there is no form for this in any of the books. Please advise.

DDC'S RESPONSE: Buy America certification is not required to be submitted with the bid for projects funded with FHWA funds. Refer to TF-Pages Attachment "E" in Volume 3 for certification and reporting requirements throughout the execution of the contract.

QUESTION #2: Please clarify whether precast concrete manholes, precast concrete catch basins, and reinforced concrete pipe require domestic steel reinforcement, including rebar or wire mesh.

DDC's RESPONSE: "Buy America" applies to all iron and steel used as permanent materials on the contract, regardless of the material's intended use, including reinforcement for concrete structures.





ATTACH TO CONTRACT DOCUMENTS

THE CITY OF NEW YORK  
DEPARTMENT OF DESIGN AND CONSTRUCTION  
INFRASTRUCTURE DIVISION  
BUREAU OF DESIGN

PROJECT ID: SANDHW11

RECONSTRUCTION OF

BEACH CHANNEL DRIVE  
BETWEEN BEACH 116TH STREET AND BEACH 124TH STREET

INCLUDING SEWER, WATER MAIN, YTAFFIC SIGNAL  
AND STREET LIGHTING WORK  
Together With All Work Incidental Thereto

BOROUGH OF QUEENS  
CITY OF NEW YORK

ADDENDUM NO. 2

DATED: April 3, 2017

THIS ADDENDUM IS HEREBY MADE A PART OF THE CONTRACT DOCUMENTS

1. Refer to the Bid and Contract Documents, VOLUME 1 OF 3, BID BOOKLET, "Notices to Bidders";  
Delete Notices to Bidders in its entirety;  
Insert attached "Notices to Bidders".
2. Refer to the Bid and Contract Documents, VOLUME 2 OF 3;  
Delete VOLUME 2 OF 3 in its entirety;  
Insert attached revised VOLUME 2 OF 3.
3. Refer to the Bid and Contract Documents, VOLUME 3 OF 3, SCHEDULE A;  
Delete SCHEDULE A in its entirety;  
Insert attached revised SCHEDULE A.

END OF ADDENDUM NO. 2

By signing in the space provided below, the bidder acknowledges receipt of this Addendum consisting of ONE (1) page and TWO HUNDRED NINETY-NINE (299) pages. Attachment.

THIS ADDENDUM MUST BE SIGNED BY ALL BIDDERS AND ATTACHED TO THEIR BID

  
MOHSEN ZARGARELAHI, P.E.  
Assistant Commissioner

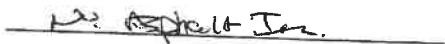
  
Name of Bidder

By: 



# Notices to Bidders

## Pre-Bid Questions (PBQs)

Please be advised that PBQs should be submitted to the Agency Contact Person (CSB\_projectinquiries@ddc.nyc.gov) at least five (5) business days (by 5:00 PM EST) prior to the bid opening date as indicated in ATTACHMENT 1 - BID INFORMATION, page A-1 and SCHEDULE B, page 13, VOLUME 1 OF 3 of this BID BOOKLET.

All PBQs must reference the Project ID. If a Bidder has multiple PBQs for the same Project ID, the PBQs must be numbered sequentially, even if they are submitted separately.

## Apprenticeship Program

*If Apprenticeship Program is required as noted on Page 19 of this BID BOOKLET, the following notice applies:*

Please be advised that, pursuant to the authority granted to the City under Labor Law §816-b, the New York City Department of Design and Construction hereby requires that the contractor awarded a contract as a result of this solicitation, and any of its subcontractors with subcontracts worth two million dollars or over, have, prior to entering into such contract or subcontract, apprenticeship agreements appropriate for the type and scope of work to be performed that have been registered with, and approved by, the New York State Commissioner of Labor. In addition, the contractor and its subcontractors will be required to show that such apprenticeship program/s have successfully passed the two year Probation period following the initial registration date of such program/s with the New York State Department of Labor.

The failure to prove, upon request, that these requirements have been met shall result in the contract not being awarded to the contractor or the subcontractor not being approved.

Please be further advised that, pursuant to Labor Law §220, the allowable ratio of apprentices to journeypersons in any craft classification shall not be greater than the ratio permitted to the contractor as to its workforce on any job under the registered apprenticeship program.



# Notices to Bidders

## NYC Construction Loan Pilot Program

The New York City Department of Small Business Services (SBS), in conjunction with the New York Business Development Corporation (NYBDC), have established a **NYC Construction Loan** pilot program to provide prime contractors and subcontractors financing for mobilization costs on certain City construction projects.

Under this initiative, loans are available for early stage mobilization needs such as insurance, labor, supplies and equipment. Bidders are strongly encouraged to visit "Growing Your Business" at [www.nyc.gov/nycbusiness](http://www.nyc.gov/nycbusiness) to learn more about the loan or contact [constructionloan@sbs.nyc.gov](mailto:constructionloan@sbs.nyc.gov) / (212) 513-6444 to obtain details and to determine preliminary eligibility.

A successful loan applicant will be required to make an assignment of its contract (or subcontract) payments to the lender NYBDC until the loan is repaid. If the loan is to a subcontractor, a prime contractor must honor the terms of such an assignment.

A prime contractor may not discriminate against a subcontractor or potential subcontractor by reason of the subcontractor's participation, or nonparticipation, in the NYC Construction loan program.



**Department of  
Design and  
Construction**

**THE CITY OF NEW YORK  
DEPARTMENT OF DESIGN AND CONSTRUCTION  
DIVISION OF INFRASTRUCTURE**

30-30 THOMSON AVENUE  
LONG ISLAND CITY, NEW YORK 11101-3045  
TELEPHONE (718) 391-1000  
WEBSITE [www.nyc.gov/buildnyc](http://www.nyc.gov/buildnyc)

**VOLUME 2 OF 3**

**INFORMATION FOR BIDDERS  
CONTRACT  
PERFORMANCE AND PAYMENT BONDS  
PREVAILING WAGE SCHEDULE**

**FOR FURNISHING ALL LABOR AND MATERIALS NECESSARY AND REQUIRED FOR:**

**FOR THE DEPARTMENT OF TRANSPORTATION  
PREPARED BY**

*IN HOUSE DESIGN*

**MARCH 15, 2017**

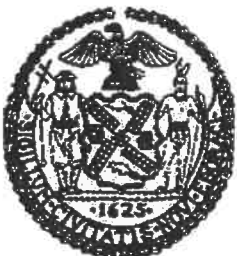





**CITY OF NEW YORK**

**DEPARTMENT OF  
DESIGN AND CONSTRUCTION  
DIVISION OF INFRASTRUCTURES**

**INFORMATION FOR BIDDERS**

**JUNE 2015**

**(NO TEXT ON THIS PAGE)**

**CITY OF NEW YORK CITY  
DEPARTMENT OF DESIGN AND CONSTRUCTION  
INFORMATION FOR BIDDERS**

**TABLE OF CONTENTS**

SECTION 1.	DESCRIPTION AND LOCATION OF WORK	1
SECTION 2.	TIME AND PLACE FOR RECEIPT OF BIDS	1
SECTION 3.	DEFINITIONS	1
SECTION 4.	INVITATION FOR BIDS AND CONTRACT DOCUMENTS	1
SECTION 5.	PRE-BID CONFERENCE	2
SECTION 6.	AGENCY CONTACT	2
SECTION 7.	BIDDER'S OATH	2
SECTION 8.	EXAMINATION AND VIEWING OF SITE, CONSIDERATION OF OTHER SOURCES OF INFORMATION AND CHANGED CONDITIONS	2
SECTION 9.	EXAMINATION OF PROPOSED CONTRACT	3
SECTION 10.	FORM OF BID	3
SECTION 11.	IRREVOCABILITY OF BID	3
SECTION 12.	ACKNOWLEDGMENT OF AMENDMENTS	4
SECTION 13.	BID SAMPLES AND DESCRIPTIVE LITERATURE	4
SECTION 14.	PROPRIETARY INFORMATION/TRADE SECRETS	4
SECTION 15.	PRE-OPENING MODIFICATION OR WITHDRAWAL OF BIDS	4
SECTION 16.	BID EVALUATION AND AWARD	4
SECTION 17.	LATE BIDS, LATE WITHDRAWALS AND LATE MODIFICATIONS	5
SECTION 18.	WITHDRAWAL OF BIDS.	5
SECTION 19.	MISTAKE IN BIDS	5
SECTION 20.	LOW TIE BIDS	6
SECTION 21.	REJECTION OF BIDS	6
SECTION 22.	RIGHT TO APPEAL DETERMINATIONS OF NON-RESPONSIVENESS OR NON-RESPONSIBILITY AND RIGHT TO PROTEST SOLICITATIONS AND AWARD	7
SECTION 23.	AFFIRMATIVE ACTION AND EQUAL EMPLOYMENT OPPORTUNITY	7
SECTION 24.	VENDEX QUESTIONNAIRES	7
SECTION 25.	COMPLAINTS ABOUT THE BID PROCESS	8
SECTION 26.	BID, PERFORMANCE AND PAYMENT SECURITY	8
SECTION 27.	FAILURE TO EXECUTE CONTRACT	9
SECTION 28.	BIDDER RESPONSIBILITIES AND QUALIFICATIONS	9
SECTION 29.	EMPLOYMENT REPORT	10
SECTION 30.	LABOR LAW REQUIREMENTS	10
SECTION 31.	INSURANCE	10
SECTION 32.	LUMP SUM CONTRACTS	11
SECTION 33.	UNIT PRICE CONTRACTS	11
SECTION 34.	EXCISE TAX	11
SECTION 35.	LICENSES AND PERMITS	11
SECTION 36.	MULTIPLE PRIME CONTRACTORS	11
SECTION 37.	LOCALLY BASED ENTERPRISE REQUIREMENTS (LBE)	12
SECTION 38.	BID SUBMISSION REQUIREMENTS	13
SECTION 39.	COMPTROLLER'S CERTIFICATE	14
SECTION 40.	PROCUREMENT POLICY BOARD RULES	14
SECTION 41.	DDC SAFETY REQUIREMENTS	14

**(NO TEXT ON THIS PAGE)**

## INFORMATION FOR BIDDERS

### 1. Description and Location of Work

The description and location of the work for which bids are requested are specified in Attachment 1, "Bid Information". Attachment 1 is included as page A-1 of the Bid Booklet.

### 2. Time and Place for Receipt of Bids

Sealed bids shall be received on or before the date and hour specified in Attachment 1, at which time they will be publicly opened and read aloud in the presence of the Commissioner or his or her representative, and any bidders who may desire to be present.

### 3. Definitions

The definitions set forth in the Procurement Policy Board Rules shall apply to this Invitation For Bids.

### 4. Invitation For Bids and Contract Documents

(A) Except for titles, sub-titles, headings, running headlines, tables of contents and indices (all of which are printed herein merely for convenience) the following, except for such portions thereof as may be specifically excluded, shall be deemed to be part of the Contract and the Invitation for Bids.

- (1) All provisions required by law to be inserted in this Contract, whether actually inserted or not.
- (2) The Contract Drawings and Specifications
- (3) The General Conditions, the General Requirements and the Special Conditions, if any
- (4) The Contract
- (5) The Information for Bidders; Request for Proposals; Notice of Solicitation and Proposal For Bids; Bid or Proposal, and, if used, the Bid Booklet
- (6) The Budget Director's Certificate; all Addenda issued prior to the receipt of the bids; the Notice of Award; Performance and Payment Bonds, if required; and the Notice to Proceed with the Work.

(B) For particulars as to this procurement, including quantity and quality of the purchase, extent of the work or labor to be performed, delivery and performance schedule, and any other special instructions, prospective bidders are referred to the Invitation For Bids Documents. A copy of such documents can be obtained at the location set forth in Attachment 1.

(C) Deposit for Copy of Invitation For Bids Documents: Prospective bidders may obtain a copy of the Invitation For Bids Documents by complying with the conditions set forth in the Notice of Solicitation. The deposit must be in the form of a check or money order made payable to the City of New York, and drawn upon a state or national bank or trust company, or a check of such bank or trust company signed by a duly authorized officer thereof.

(D) Return of Invitation For Bids Documents: All Invitation For Bids Documents must be returned to the Department upon request. If the bidder elects not to submit a bid thereunder, the

Invitation For Bids Documents shall be returned to the Department, along with a statement that no bid will be submitted.

(E) Return of Deposit: Such deposit will be returned within 30 days after the award of the contract or the rejection of all bids as set forth in the advertisement, provided the Invitation For Bids Documents are returned to the location specified in Attachment 1, in physical condition satisfactory to the Commissioner.

(F) Additional Copies: Additional copies of the Invitation For Bids Documents may be obtained, subject to the conditions set forth in the advertisement for bids.

5. Pre-Bid Conference

A pre-bid conference shall be held as set forth in Attachment 1. Nothing stated at the pre-bid conference shall change the terms or conditions of the Invitation For Bids Documents, unless a change is made by written amendment as provided in Section 9 below. Failure to attend a mandatory pre-bid conference shall constitute grounds for the rejection of the bid.

6. Agency Contact

Any questions or correspondence relating to this bid solicitation shall be addressed to the Agency Contact person specified in Attachment 1.

7. Bidder's Oath

(A) The bid shall be properly signed by an authorized representative of the bidder and the bid shall be verified by the written oath of the authorized representative who signed the bid, that the several matters stated and information furnished therein are in all aspects true.

(B) A materially false statement willfully or fraudulently made in connection with the bid or any of the forms completed and submitted with the bid may result in the termination of any Contract between the City and the Bidder. As a result, the Bidder may be barred from participating in future City contracts as well as be subject to possible criminal prosecution.

8. Examination and Viewing of Site

(A) Pre-Bidding (Investigation) Viewing of Site -Bidders must carefully view and examine the site of the proposed work, as well as its adjacent area, and seek other usual sources of information, for they will be conclusively presumed to have full knowledge of any and all conditions on, about or above the site relating to or affecting in any way the performance of the work to be done under the Contract which were or should have been indicated to a reasonably prudent bidder. To arrange a date for visiting the work site, bidders are to contact the Agency Contact person specified in Attachment 1.

(B) Should the contractor encounter during the progress of the work subsurface conditions at the site materially differing from any shown on the Contract Drawings or indicated in the Specifications or such subsurface conditions as could not reasonably have been anticipated by the contractor and were not anticipated by the City, which conditions will materially affect the cost of the work to be done under the

Contract, the attention of the Commissioner must be called immediately to such conditions before they are disturbed. The Commissioner shall thereupon promptly investigate the conditions. If he finds that they do so materially differ, or that they could not have been reasonably anticipated by the contractor and were not anticipated by the City, the Contract may be modified with his written approval.

9. Examination of Proposed Contract

(A) Request for Interpretation or Correction: Prospective bidders must examine the Contract Documents carefully and before bidding must request the Commissioner in writing for an interpretation or correction of every patent ambiguity, inconsistency or error therein which should have been discovered by a reasonably prudent bidder. Such interpretation or correction, as well as any additional contract provisions the Commissioner may decide to include, will be issued in writing by the Commissioner as an addendum to the Contract, which will be transmitted to each person recorded as having received a copy of the Contract Documents from the Department. Transmission of such addendum will be by mail, e-mail, facsimile or hand delivery. Such addendum will also be posted at the place where the Contract Documents are available for the inspection of prospective bidders. Upon transmission as provided for herein, such addendum shall become a part of the Contract Documents, and binding on all bidders, whether or not actual notice of such addendum is shown.

(B) Only Commissioner's Interpretation or Correction Binding: Only the written interpretation or correction so given by the Commissioner shall be binding, and prospective bidders are warned that no other officer, agent or employee of the City is authorized to give information concerning, or to explain or interpret, the Contract.

(C) Documents given to a subcontractor for the purpose of soliciting the subcontractor's bid shall include either a copy of the bid cover sheet or a separate information sheet setting forth the project name, the Contract number (if available), the contracting agency and the Project's location.

10. Form of Bid

Each bid must be submitted upon the prescribed form and must contain: a) the name, residence and place of business of the person or persons making the same; b) the names of all persons interested therein, and if no other person is so interested, such fact must be distinctly stated; c) a statement to the effect that it is made without any connection with any other person making a bid for the same purpose and that it is in all respects fair and without collusion or fraud; d) a statement that no Council member or other officer or employee or person whose salary is payable in whole or part from the City Treasury is directly or indirectly interested therein or in the supplies, materials or equipment and work or labor to which it relates, or in any portion of the profits thereof; e) a statement that the bidder is not in arrears to the City or to any agency upon a debt or contract or taxes, and is not a defaulter as surety or otherwise upon any obligation to the City to any agency thereof, except as set forth in the bid.

THE BID SHALL BE TYPEWRITTEN OR WRITTEN LEGIBLY IN INK. THE BID SHALL BE SIGNED IN INK. ERASURES OR ALTERATIONS SHALL BE INITIALED BY THE SIGNER IN INK. FAILURE TO CONFORM TO THE REQUIREMENTS OF THIS SECTION 10 SHALL RESULT IN THE REJECTION OF THE BID.

11. Irrevocability of Bid

The prices set forth in the bid cannot be revoked and shall be effective until the award of the Contract, unless the bid is withdrawn as provided for in Sections 15 and 18 below.

12. Acknowledgment of Amendments

The receipt of any amendment to the Contract Documents shall be acknowledged by the bidder in its bid submission.

13. Bid Samples and Descriptive Literature

Bid samples and descriptive literature shall not be submitted by the bidder, unless expressly requested elsewhere in the Contract or Contract Documents. Any unsolicited bid samples or descriptive literature which are submitted shall not be examined or tested and shall not be deemed to vary any of the provisions of this Contract.

14. Proprietary Information/Trade Secrets

(A) The bidder shall identify those portions of the bid which it deems to be confidential, proprietary information or trade secrets, and provide justification why such materials shall not be disclosed by the City. All such materials shall be clearly indicated by stamping the pages on which such information appears, at the top and bottom thereof with the word "Confidential". Such materials stamped "Confidential" must be easily separable from the non-confidential sections of the bid.

(B) All such materials so indicated shall be reviewed by the Agency and any decision not to honor a request for confidentiality shall be communicated in writing to the bidder. For those bids which are unsuccessful, all such confidential materials shall be returned to the bidder. Prices, makes and model or catalog numbers of the items offered, deliveries, and terms of payment shall be publicly available after bid opening, regardless of any designation of confidentiality made by the bidder.

15. Pre-Opening Modification or Withdrawal of Bids

Bids may be modified or withdrawn by written notice received in the office designated in Attachment 1, before the time and date set for the bid opening. If a bid is withdrawn in accordance with this Section, the bid security, if any, shall be returned to the bidder.

16. Bid Evaluation and Award

In accordance with the New York City Charter, the Procurement Policy Board Rules and the terms and conditions of this Invitation For Bids, this Contract shall be awarded, if at all, to the responsible bidder whose bid meets the requirements and evaluation criteria set forth in the Invitation For Bids, and whose bid price is either the most favorable bid price or, if the Invitation For Bids so states, the most favorable evaluated bid price. A bid may not be evaluated for any requirement or criterion that is not disclosed in the Invitation For Bids.

Restriction: No negotiations with any bidder shall be allowed to take place except under the circumstances and in the manner set forth in Section 21. Nothing in this Section shall be deemed to permit a contract award to a bidder submitting a higher quality item than that designated in the Invitation For Bids, if that bid is not also the most favorable bid.



17. Late Bids, Late Withdrawals and Late Modifications

Any bid received at the place designated in the solicitation after the time and date set for receipt of bids is late and shall not be considered. Any request for withdrawal or modification received at the place designated in the solicitation after the time and date set for receipt of bids is late and shall not be considered. The exception to this provision is that a late modification of a successful bid that makes the bid terms more favorable to the City shall be considered at any time it is received.

18. Withdrawal of Bids.

Except as provided for in Section 15, above, a bidder may not withdraw its bid before the expiration of forty-five (45) days after the date of the opening of bids; thereafter, a bidder may withdraw its bid only in writing and in advance of an actual award. If within sixty (60) days after the execution of the Contract, the Commissioner fails to fix the date for commencement of work by written notice to the bidder, the bidder, at his option, may ask to be relieved of his obligation to perform the work called for by written notice to the Commissioner. If such notice is given to the Commissioner, and the request to withdraw is granted, the bidder waives all claims in connection with this Contract.

19. Mistake in Bids

(A) Mistake Discovered Before Bid Opening: A bidder may correct mistakes discovered before the time and date set for bid opening by withdrawing or correcting the bid as provided in Section 15 above.

(B) Mistakes Discovered Before Award

(1) In accordance with General Municipal Law (Section 103, subdivision 11), where a unilateral error or mistake is discovered in a bid, such bid may be withdrawn upon written approval of the Agency Chief Contracting Officer if the following conditions are met:

- (a) The mistake is known or made known to the agency prior to the awarding of the Contract or within 3 days after the opening of the bid, whichever period is shorter; and
- (b) The price bid was based upon an error of such magnitude that enforcement would be unconscionable; and
- (c) The bid was submitted in good faith and the bidder submits credible evidence that the mistake was a clerical error as opposed to a judgment error; and
- (d) The error in the bid is actually due to an unintentional and substantial arithmetic error or an unintentional omission of a substantial quantity of work, labor, material or services made directly in the compilation of the bid, which unintentional arithmetic error or unintentional omission can be clearly shown by objective evidence drawn from inspection of the original work paper, documents, or materials used in the preparation of the bid sought to be withdrawn; and
- (e) It is possible to place the agency in the same position as existed prior to the bid.

(2) Unless otherwise required by law, the sole remedy for a bid mistake in accordance with this Article shall be withdrawal of the bid, and the return of the bid bond, or other security, if any, to the bidder. Thereafter, the agency may, in its discretion, award the Contract to the next lowest bidder or rebid the Contract. Any amendment to or reformation of a bid or a Contract to rectify such an error or mistake

therein is strictly prohibited.

(3) If the mistake and the intended correct bid are clearly evident on the face of the bid document, the bid shall be corrected to the intended correct bid and may not be withdrawn. Examples of mistakes that may be corrected are typographical errors, errors in extending unit prices, transposition errors and arithmetical errors.

## 20. Low Tie Bids

(A) When two or more low responsive bids from responsible bidders are identical in price, meeting all the requirements and criteria set forth in the Invitation For Bids, the Agency Chief Contracting Officer will break the tie in the following manner and order of priority:

- (1) Award to a certified New York City small, minority or woman-owned business entity bidder;
- (2) Award to a New York City bidder;
- (3) Award to a certified New York State small, minority or woman-owned business bidder;
- (4) Award to a New York State bidder.

(B) If two or more bidders still remain equally eligible after application of paragraph (A) above, award shall be made by a drawing by lot limited to those bidders. The bidders involved shall be invited to attend the drawing. A witness shall be present to verify the drawing and shall certify the results on the bid tabulation sheet.

## 21. Rejection of Bids

(A) Rejection of Individual Bids: The Agency may reject a bid if:

- (1) The bidder fails to furnish any of the information required pursuant to Section 24 or 28 hereof; or if
- (2) The bidder is determined to be not responsible pursuant to the Procurement Policy Board Rules; or if
- (3) The bid is determined to be non-responsive pursuant to the Procurement Policy Board Rules; or if
- (4) The bid, in the opinion of the Agency Chief Contracting Officer, contains unbalanced bid prices and is thus non-responsive, unless the bidder can show that the prices are not unbalanced for the probable required quantity of items, or if the imbalance is corrected pursuant to Section 15.

(B) Rejection of All Bids: The Agency, upon written approval by the Agency Chief Contracting Officer, may reject all bids and may elect to resolicit bids if in its sole opinion it shall deem it in the best interest of the City so to do.

(C) Rejection of All Bids and Negotiation With All Responsible Bidders: The Agency Head may determine that it is appropriate to cancel the Invitation For Bids after bid opening and before award and to complete the acquisition by negotiation. This determination shall be based on one of the following reasons:

- (1) All otherwise acceptable bids received are at unreasonable prices, or only one bid is received and the Agency Chief Contracting Officer cannot determine the reasonableness of the bid price, or no responsive bid has been received from a responsible bidder; or
  - (2) In the judgment of the Agency Chief Contracting Officer, the bids were not independently arrived at in open competition, were collusive, or were submitted in bad faith.
- (D) When the Agency has determined that the Invitation for Bids is to be canceled and that use of negotiation is appropriate to complete the acquisition, the contracting officer may negotiate and award the Contract without issuing a new solicitation, subject to the following conditions:
- (1) prior notice of the intention to negotiate and a reasonable opportunity to negotiate have been given by the contracting officer to each responsible bidder that submitted a bid in response to the Invitation for Bids;
  - (2) the negotiated price is the lowest negotiated price offered by a responsible bidder; and
  - (3) the negotiated price is lower than the lowest rejected bid price of a responsible bidder that submitted a bid in response to the Invitation for Bids.

22. Right to Appeal Determinations of Non-Responsiveness or Non-Responsibility and Right to Protest Solicitations and Award

The bidder has the right to appeal a determination of non-responsiveness or non-responsibility and has the right to protest a solicitation and award. For further information concerning these rights, the bidder is directed to the Procurement Policy Board Rules.

23. Affirmative Action and Equal Employment Opportunity

This Invitation For Bids is subject to applicable provisions of Federal, State and Local Laws and executive orders requiring affirmative action and equal employment opportunity.

24. VENDEX Questionnaires

(A) Requirement: Pursuant to Administrative Code Section 6-116.2 and the PPB Rules, bidders may be obligated to complete and submit VENDEX Questionnaires. Generally, if this bid is \$100,000 or more, or if this bid when added to the sum total of all contracts, concessions and franchises the bidder has received from the City and any subcontracts received from City contractors over the past twelve months, equals or exceeds \$100,000, Vendex Questionnaires must be completed. If required, Vendex Questionnaires must be completed and submitted before any award of contract may be made or before approval is given for a proposed subcontractor. Non-compliance with these submission requirements may result in the disqualification of the bid, disapproval of a subcontractor, subsequent withdrawal of approval for the use of an approved subcontractor, or the cancellation of the contract after its award.

(B) Submission: Vendex Questionnaires must be submitted directly to the Mayor's Office of Contract Services, ATTN: Vendex, 253 Broadway, 9th Floor, New York, New York 10007. In addition, the bidder must submit a Confirmation of Vendex Compliance to the agency. A form for this confirmation is set forth in the Bid Booklet.

(C) Obtaining Forms: Vendex Questionnaires, as well as detailed instructions, may be obtained at [www.nyc.gov/vendex](http://www.nyc.gov/vendex). The bidder may also obtain Vendex forms and instructions by contacting the

Agency Chief Contracting Office or the contract person for this contract.

25. Complaints About the Bid Process

The New York City Comptroller is charged with the audit of contracts in New York City. Any vendor who believes that there has been unfairness, favoritism or impropriety in the bid process should inform the Comptroller, Office of Contract Administration, One Centre Street, Room 835, New York, New York; telephone number (212)669-2797.

26. Bid Performance and Payment Security

(A) Bid Security: Each bid must be accompanied by bid security in an amount and type specified in Attachment 1 (page A-1 of the Bid Booklet). The bid security shall assure the City of New York of the adherence of the bidder to its proposal, the execution of the Contract, and the furnishing of Performance and Payment Bonds by the bidder, if required in Attachment 1. Bid security shall be returned to the bidder as follows:

- (1) Within ten (10) days after the bid opening, the Comptroller will be notified to return the deposits of all but the three (3) lowest bidders. Within five (5) days after the award, the Comptroller will be notified to return the deposits of the remaining two unsuccessful bidders.
- (2) Within five (5) days after the execution of the Contract and acceptance of the Contractor's bonds, the Comptroller will be notified to return the bid security of the successful bidder or, if performance and payment bonds are not required, only after the sum retained under Article 21 of the Contract equals the amount of the bid security.
- (3) Where all bids are rejected, the Comptroller will be notified to return the deposit of the three (3) lowest bidders at the time of rejection.

(B) Performance and Payment Security: Performance and Payment Security must be provided in an amount and type specified in Attachment 1 (page A-1 of the Bid Booklet). The performance and payment security shall be delivered by the contractor prior to or at the time of execution of the Contract. If a contractor fails to deliver the required performance and payment security, its bid security shall be enforced, and an award of Contract may be made to the next lowest responsible and responsive bidder, or the contract may be rebid.

(C) Acceptable Types of Security: Acceptable types of security for bids, performance, and payment shall be limited to the following:

- (1) a one-time bond in a form satisfactory to the City;
- (2) a bank certified check or money order;
- (3) obligations of the City of New York; or
- (4) other financial instruments as determined by the Office of Construction in consultation with the Comptroller.

Whenever the successful bidder deposits obligations of the City of New York as performance and payment security, the Comptroller may sell and use the proceeds thereof for any purpose for which the principal or surety on such bond would be liable under the terms of the Contract. If the money is deposited with the Comptroller, the successful bidder shall not be entitled to receive interest on such money from the City.

(D) Form of Bonds: Security provided in the form of bonds must be prepared on the form of bonds authorized by the City of New York. Forms for bid, performance, and payment bonds are included in the Invitation for Bids Documents. Such bonds must have as surety thereunder such surety company or companies as are: (1) approved by the City of New York; (2) authorized to do business in the State of New York, and (3) approved by the Department of the Treasury of the United States. Premiums for any required bonds must be included in the base bid.

The bidder is advised that submission of a bid bond where the surety on such bond fails to meet the criteria set forth herein, shall result in the rejection of the bid as non-responsive.

The Department of the Treasury of the United States advises that information concerning approved surety companies may be obtained as follows: (1) from the Government Printing Office at 202-512-1800; (2) through the Internet at <http://www.fms.treas.gov/e570/index.html>, and (3) through a computerized public bulletin board, which can be accessed by using your computer modem and dialing 202-874-6887.

(E) Power of Attorney: Attorneys in fact who sign bid, performance, or payment bonds must file with each bond a certified copy of their power of attorney to sign said bonds.

#### 27. Failure to Execute Contract

In the event of failure of the successful bidder to execute the Contract and furnish the required security within ten (10) days after notice of the award of the Contract, the deposit of the successful bidder or so much thereof as shall be applicable to the amount of the award made shall be retained by the City, and the successful bidder shall be liable for and hereby agrees to pay on demand the difference between the price bid and the price for which such Contract shall be subsequently awarded, including the cost of any required reletting and less the amount of such deposit. No plea of mistake in such accepted bid shall be available to the bidder for the recovery of the deposit or as a defense to any action based upon such accepted bid. Further, should the bidder's failure to comply with this Section cause any funding agency, body or group (Federal, State, City, Public, Private, etc.) to terminate, cancel or reduce the funding on this project, the bidder in such event shall be liable also to the City for the amount of actual funding withdrawn by such agency on this project, less the amount of the forfeited deposit.

#### 28. Bidder Responsibilities and Qualifications

(A) Bidders must include with their bids all information necessary for a determination of bidder responsibility, as set forth in the Specifications.

(B) The Agency may require any bidder or prospective bidder to furnish all books of account, records, vouchers, statements or other information concerning the bidder's financial status for examination as may be required by the Agency to ascertain the bidder's responsibility and capability to perform the Contract. If required, a bidder must also submit a sworn statement setting forth such information as the Agency may require concerning present and proposed plant and equipment, the personnel and qualifications of his working organizations, prior experience and performance record.

(C) Oral Examination on Qualifications: In addition thereto, and when directed by the Agency, the bidder, or a responsible officer, agent or employee of the bidder, must submit to an oral examination to be conducted by the Agency in relation to his proposed tentative plan and schedule of

operations, and such other matters as the Agency may deem necessary in order to determine the bidder's ability and responsibility to perform the work in accordance with the Contract. Each person so examined must sign and verify a stenographic transcript of such examination noting thereon such corrections as such person may desire to make.

(D) If the bidder fails or refuses to supply any of the documents or information set forth in paragraph (B) hereof or fails to comply with any of the requirements thereof, the Agency may reject the bid.

#### 29. Employment Report

In accordance with Executive Order No. 50 (1980) as modified by Executive Order 108 (1986), the filing of a completed Employment Report (ER) is a requirement of doing business with the City of New York for construction contractors with contracts of \$1,000,000 or more and subcontractors with construction subcontracts of \$750,000 or more. The required forms and information are included in the Bid Booklet.

#### 30. Labor Law Requirements

(A) General: The successful bidder will be required to comply strictly with all Federal, State and local labor laws and regulations.

(B) New York State Labor Law: This Contract is subject to New York State Labor Law Section 220, which requires that construction workers on the site be paid prevailing wages and supplements. The Contractor is reminded that all wage provisions of this Contract will be enforced strictly and failure to comply will be considered when evaluating performance. Noncompliance may result in the contractor being debarred by the City from future contracts. Complaints filed with the Comptroller may result in decisions which may debar a contractor from bidding contracts with any state governmental entity and other political subdivisions.

(C) Records: The Contractor is expected to submit accurate payroll reports and other required documents and verify attendance and job classifications being utilized in compliance with the law, Contract provisions and agency procedures.

#### 31. Insurance

(A) Bidders are advised that the insurance requirements contained herein are regarded as material terms of the Contract. As required by Article 22 of the Contract, the contractor must effect and maintain with companies licensed and authorized to do business in the State of New York, the types of insurance set forth therein, when required by and in the amounts set forth in Schedule A of the General Conditions. Such required insurance must be provided from the date the contractor is ordered to commence work and up to the date of final acceptance of all required work.

(B) The contractor must, within ten days of receipt of the notice of award, submit the following insurance documentation: (a) original certificate of insurance for general liability in the amount required by Schedule A of the General Conditions, and (b) original certificates of insurance or other proof of coverage for workers' compensation and disability benefits, as required by Section 57 of the New York State Workers' Compensation Law and Section 220 of the Disability Benefits Law.

32. Lump Sum Contracts

(A) Comparison of Bids: Bids on Lump Sum Contracts will be compared on the basis of the lump sum price bid, adjusted for alternate prices bid, if any.

(B) Lump Sum Bids for "General Construction Work" which include excavation shall include all necessary excavation work defined in the Specifications as being included in the lump sum bid. The bidder shall also bid a unit price for the additional cost of excavating material which is defined in the Specifications as excavation for which additional payment will be made. The total estimated additional cost of removing such material will be taken as the quantity set forth in the Engineer's Estimate multiplied by the unit price bid. This total estimated cost of additional excavation shall be added to the lump sum bid for the General Construction Work for the purpose of comparing bids to determine the low bidder.

(C) Variations from Engineer's Estimate: The Engineer's Estimate of the quantity of excavation for which additional payment will be made is approximate only and is given solely to be used as a uniform basis for the comparison of bids and such estimate is not to be considered as part of this contract. The quantities actually required to complete the contract work may be more or less than the quantities in the Engineer's Estimate and, if so, no action for damages or for loss of profits shall accrue to the contractor by reason thereof.

33. Unit Price Contracts

(A) Comparison of Bids: Bids on Unit Price Contracts will be compared on the basis of a total estimated price, arrived at by taking the sum of the estimated quantities of such items, in accordance with the Engineer's Estimate of Quantities set forth in the Bid Schedule, multiplied by the corresponding unit prices, and including any lump sum bids on individual items.

(B) Variations from Engineer's Estimate: Bidders are warned that the Engineer's Estimate of Quantities on the various items of work and materials is approximate only, given solely to be used as a uniform basis for the comparison of bids, and is not to be considered part of this contract. The quantities actually required to complete the contract work may be less or more than so estimated, and if so, no action for damages or for loss of profits shall accrue to the contractor by reason thereof.

(C) Overruns: The terms and conditions applicable to overruns of unit price items are set forth in Article 26 of the Contract.

34. Excise Tax

Bidders are referred to the Specifications for information on Federal Excise Tax exemptions.

35. Licenses and Permits

The successful bidder will be required to obtain all necessary licenses and permits necessary to perform the work.

36. Multiple Prime Contractors

If more than one prime contractor will be involved on this project, all contractors are required to examine the Invitation for Bid packages for all other parts of the project.

**37. Locally Based Enterprise Requirements (LBE)**

This Contract is subject to the requirements of Administrative Code, Section 6-108.1, and the regulations promulgated thereunder. No construction contract will be awarded unless and until these requirements have been complied with in their entirety. The bidder is advised of the provisions set forth below, as well as the provisions with respect to the Locally Based Enterprise Program contained in Article 67 of the Contract. The contractor is advised that:

- (A) If any portion of the Contract is subcontracted, not less than ten percent of the total dollar amount of the contract shall be awarded to locally based enterprises ("LBEs"); except, where less than ten percent of the total dollar amount of the Contract is subcontracted, such lesser percentage shall be so awarded.
- (B) No contractor shall require performance and payment bonds from LBE subcontractors.
- (C) No Contract shall be awarded unless the contractor first identifies in its bid:
  - (1) the percentage, dollar amount and type of work to be subcontracted; and
  - (2) the percentage, dollar amount and type of work to be subcontracted to LBEs.
- (D) Within ten calendar days after notification of low bid, the apparent low bidder shall submit an "LBE Participation Schedule" to the contracting agency. If such schedule does not identify sufficient LBE subcontractors to meet the requirements of Administrative Code Section 6-108.1, the apparent low bidder shall submit documentation of its good faith efforts to meet such requirements.
  - (1) The "LBE Participation Schedule" shall include:
    - (a) the name and address of each LBE that will be given a subcontract,
    - (b) the percentage, dollar amount and type of work to be subcontracted to the LBE, and
    - (c) the dates when the LBE subcontract work will commence and end.
  - (2) The following documents shall be attached to the "LBE Participation Schedule":
    - (a) verification letters from each subcontractor listed in the "LBE Participation Schedule" stating that the LBE will enter into a formal agreement for work,
    - (b) certification documents of any proposed LBE subcontractor which is not on the LBE certified list, and
    - (c) copies of the certification letter of any proposed subcontractor which is an LBE.
  - (3) Documentation of good faith efforts to achieve the required LBE percentage shall include as appropriate but not limited to the following:
    - (a) attendance at prebid meetings, when scheduled by the agency, to advise bidders of contract requirements;



- (b) advertisement where appropriate in general circulation media, trade association publications and small business media of the specific subcontracts that would be at least equal to the percentage goal for LBE utilization specified by the contractor;
- (c) written notification to association of small, minority and women contractors soliciting specific subcontractors;
- (d) written notification by certified mail to LBE firms that their interest in the contract is solicited for specific work items and their estimated values;
- (e) demonstration of efforts made to select portions of the work for performance by LBE firms in order to increase the likelihood of achieving the stated goal;
- (f) documented efforts to negotiate with LBE firms for specific subcontracts, including at a minimum:
  - (i) The names, address and telephone numbers of LBE firms that are contacted;
  - (ii) A description of the information provided to LBE firms regarding the plans and specifications for portions of the work to be performed;
  - (iii) Documentation showing that no reasonable price can be obtained from LBE firms;
  - (iv) A statement of why agreements with LBE firms were not reached;
- (g) a statement of the reason for rejecting any LBE firm which the contractor deemed to be unqualified; and
- (h) documentation of efforts made to assist the LBE firms contacted that needed assistance in obtaining required insurance.

(E) Unless otherwise waived by the Commissioner with the approval of the Office of Economic and Financial Opportunity, failure of a proposed contractor to provide the information required by paragraphs (C) and (D) above may render the bid non-responsive and the Contract may not be awarded to the bidder. If the contractor states that it will subcontract a specific portion of the work, but can demonstrate despite good faith efforts it cannot achieve its required LBE percentage for subcontracted work until after award of Contract, the Contract may be awarded, subject to a letter of compliance from the contractor stating that it will comply with Administrative Code Section 6-108.1 and subject to approval by the Commissioner. If the contractor has not met its required LBE percentage prior to award, the contractor shall demonstrate that a good faith effort has been made subsequent to award to obtain LBEs on each subcontract until it meets the required percentage.

(F) When a bidder indicates prior to award that no work will be subcontracted, no work may be subcontracted without the prior written approval of the Commissioner, which shall be granted only if the contractor in good faith seeks LBE subcontractors at least six weeks prior to the start of work.

(G) The contractor may not substitute or change any LBE which was identified prior to award of the contract without the written permission of the Commissioner. The contractor shall make a written application to the Commissioner for permission to make such substitution or change, explaining why the contractor needs to change its LBE subcontractor and how the contractor will meet its LBE subcontracting requirement. Copies of such application must be served on the originally identified LBE by certified mail return receipt requested, as well as the proposed substitute LBE. The Commissioner shall determine whether or not to grant the contractor's request for substitution.

### 38. Bid Submission Requirements

The following forms, all of which are contained in the Bid Booklet, are to be completed and submitted with the bid:

- (1) Bid Schedule and Bid Form, including Affirmation
- (2) Bid Security (if required, see Attachment 1 on Page A-1)
- (3) M/WBE Subcontractor Utilization Plan (if participation goals have been established)

**FAILURE TO SUBMIT ITEMS (1), (2) AND (3)  
WILL RESULT IN THE DISQUALIFICATION OF THE BID.**

- (4) Safety Questionnaire
- (5) Construction Employment Report (if bid is \$1,000,000 or more)
- (6) Contract Certificate (if bid is less than \$1,000,000)
- (7) Confirmation of Vendex Compliance
- (8) Special Experience Requirements (if applicable to this contract)
- (9) Apprenticeship Program Questionnaire (if applicable)

**FAILURE TO SUBMIT ITEMS (4) THROUGH (9)  
MAY RESULT IN THE DISQUALIFICATION OF THE BID.**

39. Comptroller's Certificate

This Contract shall not be binding or of any force unless it is registered by the Comptroller in accordance with Section 328 of the City Charter and the Procurement Policy Board Rules. This Contract shall continue in force only after annual appropriation of funds by the City of New York and certification as hereinabove set forth.

40. Procurement Policy Board Rules

This Invitation For Bids is subject to the Rules of the Procurement Policy Board of the City of New York. In the event of a conflict between said Rules and a provision of this Invitation For Bids, the Rules shall take precedence.

41. DDC Safety Requirements

The DDC Safety Requirements apply to the work to be performed pursuant to the Contract. The DDC Safety Requirements are set forth on the following pages.

**CITY OF NEW YORK**  
**DEPARTMENT OF DESIGN AND CONSTRUCTION**  
**SAFETY REQUIREMENTS**

June 2015

---

*THE DDC SAFETY REQUIREMENTS INCLUDE THE FOLLOWING SECTIONS:*

- I. POLICY ON SITE SAFETY**
- II. PURPOSE**
- III. DEFINITIONS**
- IV. RESPONSIBILITIES**
- V. SAFETY QUESTIONNAIRE**
- VI. SAFETY PROGRAM AND SITE SAFETY PLAN**
- VII. KICK-OFF/PRE-CONSTRUCTION MEETINGS AND SAFETY REVIEW**
- VIII. EVALUATION DURING WORK IN PROGRESS**
- IX. SAFETY PERFORMANCE EVALUATION**

**City of New York Department of Design and Construction: Safety Requirements  
Safety and Site Support- Quality Assurance and Construction Safety**

**I. POLICY ON SITE SAFETY**

The City of New York Department of Design and Construction (DDC) is committed to a policy of injury and illness prevention and risk management for construction work that will ensure the safety and health of the workers engaged in the projects and the protection of the general public. Therefore, it is DDC's policy that work carried out by Contractors on DDC jobsites must, at a minimum, comply with applicable federal, state and city laws, rules and regulations, including without limitation:

- ❑ U. S. Department of Labor 29 Code of Federal Regulations (CFR) Part 1926 and applicable Sub-parts of Part 1910 – U.S. Occupational Safety and Health Administration (OSHA); New York State Department of Labor Industrial Code Rule 23 – Protection in Construction, Demolition and Excavation;
- ❑ New York City Construction Codes, Title 28
- ❑ NYC Department of Transportation Title 34 Chapter 2 – Highway Rules
- ❑ New York State Department of Labor Industrial Code Rule 16 NYCRR Part 753
- ❑ Title 15 of the Rules of the City of New York, Chapter 13 Citywide Construction Dust Mitigation
- ❑ Manual on Uniform Traffic Control Devices (MUTCD)
- ❑ Title 15 of the Rules of the City of New York, Chapter 28 Citywide Construction Noise Mitigation

**II. PURPOSE**

The purpose of this policy is to ensure that Contractors perform their work and supervise their employees in accordance with all applicable federal, state and city rules and regulations. Further, Contractors will be expected to minimize or eliminate jobsite and public hazards, through a planning, inspection, auditing and corrective action process. The goal is to control risks so that injuries, illnesses and accidents to contractors' employees, DDC employees and the general public, as well as damage to city-owned and private property, are reduced to the lowest level feasible.

**III. DEFINITIONS**

**Agency Chief Contracting Officer (ACCO):** The ACCO shall mean the person delegated authority by the Commissioner to organize and supervise the procurement activity of subordinate Agency staff in conjunction with the CCPO.

**Competent Person:** As defined by OSHA, an individual who is capable of identifying existing and predictable hazards in the surroundings or working conditions that are unsanitary, hazardous, or dangerous to employees or the general public, and who has authorization to take prompt corrective measures to eliminate them.

**Construction Safety Auditor:** A representative of the QA&CS Construction Safety Unit who provides inspection and assessment services to enhance health and safety on all DDC construction projects. The activities of the Construction Safety Auditor include performing site surveys, reviewing health and safety plans, reviewing construction permits, and rendering technical advice and assistance to DDC Resident Engineers and Project Managers.

**Construction Safety Unit:** A part of QA&CS within the Division of Program Management/ Safety & Site Support that assesses contractor safety on DDC jobsites and advises responsible parties of needed corrective actions.

**City of New York Department of Design and Construction: Safety Requirements  
Safety and Site Support- Quality Assurance and Construction Safety**

**Construction Superintendent:** A representative of the contractor responsible for overseeing performance of the required construction work. This individual must engage in sound construction practices, and is responsible to maintain a safe work site. In the case of a project involving the demolition, alteration or new construction of buildings, the Construction Superintendent must be licensed by the NYC Department of Buildings.

**Contractor:** For purposes of these Safety Requirements, the term "Contractor" shall mean any person or entity that enters into a contract for the performance of construction work on a DDC project. The term "Contractor" shall include any person or entity which enters into any of the following types of contracts: (1) a prime construction contract for a specific project, (2) a prime construction contract using the Job Order Contracting System ("JOCS Contract"), and (3) a subcontract with a CM/Builder ("First Tier Subcontract").

**Daily Safety Job Briefing:** Daily jobsite safety meetings, giving to all jobsite personnel by contractor, with the purpose of discussing project specific safety procedures for the scheduled construction work.

**Director - Quality Assurance and Construction Safety (QA&CS):** Responsible for the operations of the QACS Construction Safety Unit and the DDC Site Safety management programs.

**Job Hazard Analysis (JHA):** A process of identifying the major job steps and any potential site-specific hazards that may be present during construction and establishing the means and methods to eliminate or control those hazards.

**Qualified Person:** As defined by OSHA, an individual who, by possession of a recognized degree, certificate, license or professional standing; or who by extensive knowledge, training, and experience, has successfully demonstrated his or her ability to solve problems relating to the subject matter, the work, or the project. Qualified Persons are required under regulation to address issues pertaining, but without limit, to fall protection, scaffold design and trenching and shoring, among others.

**Project Site:** Those areas indicated in the Contract Documents where the Work is to be performed.

**Project Safety Representative:** The designated project safety representative shall have completed an authorized 30 hour OSHA Construction Safety Course and other safety training applicable to Contractor's/subcontractor's project work. Except in instances where a dedicated Project Safety Manager is required, a Project Safety Representative may also function as a superintendent, foreman or crew leader on the Project, but must have sufficient experience and authority to undertake corrective actions and must qualify to be a competent person. No work is to be performed on site when a Project Safety Representative is not present.

**Project Safety Manager:** A dedicated, full-time project safety manager may be a contractual requirement on large projects or projects deemed by DDC to be particularly high risk. This would be in addition or in lieu of a Contractor's Project Safety Representative. This individual shall not have any other assigned duties. This individual shall have received, at a minimum an authorized 30 hour OSHA Construction Safety Course. Other examples of acceptable training are OSHA Safety and Health Standards for the Construction Industry training program (OSHA 510), Certified Safety Professional (CSP), Certified Industrial Hygienist (CIH) or a degree/certificate in a safety and health from a college-level curriculum.

A Project Safety Manager shall possess the additional training, years of experience, and skills necessary to thoroughly understand the health and safety hazards and controls for large construction projects, including the full scope of the specific Work.

**QA&CS - Quality Assurance and Construction Safety of the New York City Department of Design and Construction.**

**City of New York Department of Design and Construction: Safety Requirements  
Safety and Site Support- Quality Assurance and Construction Safety**

**Resident Engineer (RE) / Construction Project Manager (CPM):** Representative of the Commissioner duly designated by the Commissioner to be his/her representative at the site of the work. (The RE/CPM may be a third-party consultant, including a Construction Management firm, retained by DDC)

**Safety Program:** Established by the Contractor that covers all operations of that Contractor and establishes the Contractor's overall safety policy, regulatory compliance plan and minimum safety standards. The Safety Program must be submitted prior to the commencement of work at the site and is subject to review and acceptance by the Construction Safety Unit.

**Safety Questionnaire:** Used by DDC to evaluate Contractor's current and past safety performance. It is required to be completed by all Contractors initially when submitting bids for Construction work, or when being pre-qualified and updated annually or as requested by the DDC.

**Site Safety Manager:** For certain projects, as defined in NYC Construction Codes - Title 28, the Contractor shall provide a Site Safety Manager with a Site Safety Manager License issued by the NYC Department of Building.

**Site Safety Plan:** A site-specific safety plan developed by the Contractor for a specific project. The Site Safety Plan must identify hazards associated with the project, and include specific safety procedures and training appropriate and necessary to complete the work. The Site Safety Plan must be submitted prior to the commencement of work at the site and is subject to review and acceptance by the Construction Safety Unit.

**Unsafe or Unhealthy Condition:** A condition that could be potentially hazardous to the health and safety of personnel or the public, and/or damaging to equipment, machinery, property or the environment.

**Weekly Safety Meetings:** Weekly documented jobsite safety meetings, given to all jobsite personnel by contractor, with the purpose of discussing general safety topics and job specific requirements encountered at the DDC work site.

**Work:** The construction required by the Contract Documents whether completed or partially completed, performed by the Contractor/ subcontractors. Work refers to the furnishing of labor, furnishing and incorporating materials and equipment into the construction and providing any service required by the Contract Documents to fulfill the Contractor's obligation to complete the Project.

#### **IV. RESPONSIBILITIES**

All persons who manage, perform, and provide support for construction projects shall conduct operations in compliance with the requirements identified in this Policy and all applicable governing regulatory agency requirements and guidelines pertaining to safety in construction.

##### **A. DDC or CM Resident Engineer / Construction Project Manager**

- Monitors the issuance of safety-related permits, approvals and drawings and maintains copies on site.
- Monitors construction-related work activities to confirm that they are conducted in accordance with DDC policies and all applicable regulations that pertain to construction safety.
- Maintains documentation and periodically attends weekly safety meetings and daily safety job briefings.
- Notifies the Construction Safety Unit and the ACCO's Insurance and Risk Management Unit of project-related accidents and emergencies, as per DDC's Construction Safety Emergency and Accident Notification and Response Protocol.
- Gathers facts related to all accidents and prepares DDC Construction Accident Report.

**City of New York Department of Design and Construction: Safety Requirements  
Safety and Site Support- Quality Assurance and Construction Safety**

- Notifies the Construction Safety Unit within two (2) hours of the start of an inspection by any outside regulatory agency personnel, including OSHA, NYC DOB or others and forwards a copy of the inspection report within three days of its receipt.
- Monitors the conditions at the site for conformance with the contractor's Site Safety Plan and DDC construction documents.
- Notifies the contractor and DDC in the event that any condition or activity exists that is not in compliance with the contractor's Site Safety Plan, applicable federal, state or local codes or any condition that presents a potential risk of injury to the public or workers or possible damage to property.
- Notifies DDC of any unsafe or unhealthy condition and directs the contractor to provide such labor, materials, equipment and supervision to abate such conditions.
- Escort and assist QA&CS Construction Safety Auditors during the field and record inspections.
- Reports emergency conditions to the Construction Safety Unit immediately.

**B. Contractors**

- Submit a completed Safety Questionnaire and other safety performance related documentation with its bid or as part of a pre-qualification package.
- Complete a written Job Hazard Analysis (JHA) that identifies safety hazards for project specific work tasks and hazard control methods. A written JHA shall be available at the site for reference and included in the Site Safety Plan submitted by the contractor.
- Submit a Site Safety Plan and Safety Program within 30 days from the Award Date or as otherwise directed. The Site Safety Plan and Safety Program are subject to review and acceptance by the Construction Safety Unit prior to the commencement of work at the site. The Site Safety Plan shall be revised and updated as necessary.
- Develop project specific safety procedures to protect general public during all construction activities for the duration of the project.
- Ensure that all employees are aware of the hazards associated with the project through documented formal and informal training and/or other communications. Conduct and document weekly safety meetings and daily job briefing sessions for the duration of the project. Documentation to be provided to the RE/CPM on a monthly basis.
- Name the Project Safety Representative and Project Safety Manager, if required. The Contractor will be required to identify the Project Safety Representative and Project Safety Manager in the Site Safety Plan. Resumes, outlining the qualification and experience for the Project Safety Representative and Project Safety Manager, shall be available upon request. DDC reserves the right to request that the Contractor replace any Project Safety Representative or Project Safety Manager for any reason at any time during the project.
- Name a Competent Person(s). The Contractor will be required to identify a Competent Person(s) in the Site Safety Plan.
- Comply with all mandated federal, state and local safety and health rules and regulations.
- Comply with all provisions of the Site Safety Plan.
- Conduct applicable safety training prior to the commencement of work at the site. All training records (OSHA 10-hour, flagger, scaffold, fall protection, confined space entry, etc.) shall be provided to the RE/CPM prior to mobilization, included in the Site Safety Plan, kept current during the course of the project, and available for review. Prior to performing any work on DDC project all employees shall have successfully completed, within the previous five calendar years, a 10 Hour OSHA construction safety course.
- As part of the Site Safety Plan, prepare a site specific programs and plans, such as MPT plan, steel erection plan, confined space program, fall protection plan, demolition plan, etc. (if not otherwise provided in the contract documents) and comply with all of its provisions.
- Conduct and document site-specific safety orientation for Contractor personnel to review the hazards associated with the project as identified in the Site Safety Plan and the specific safety procedures and

**City of New York Department of Design and Construction: Safety Requirements  
Safety and Site Support— Quality Assurance and Construction Safety**

controls that will be used to protect workers, the general public and property. The Project Safety Representative and/or Project Safety Manager will conduct this training prior to mobilization and provide documentation to the RE/CPM.

- Provide, replace and adequately maintain at or around the project site, suitable and sufficient signage, lights, barricades and enclosures (fences, sidewalk sheds, netting, bracing, etc.).
- Report unsafe or unhealthy conditions to the RE/CPM as soon as practical, but no more than 24 hours after discovery, and take prompt actions to remove or abate such conditions.
- Report any accidents involving injuries to workers or the general public, as well as property damage, to the RE/CPM within one (1) hour.
- Following an accident, the Contractor shall not remove or alter any equipment, structure, material, or evidence related to the accident. Exception: Immediate emergency procedures taken to secure structures, temporary construction, operations, or equipment that pose a continued imminent danger or facilitate assistance for persons who are trapped or who have sustained bodily injury.
- Notify the RE/CPM within one (1) hour of the start of an inspection by any outside regulatory agency personnel, including OSHA, NYC DOB or others.
- Maintain all records pertaining to all required compliance documents and accident and injury reports.
- Address DDC recommendations on safety, which shall in no way relieve the Contractor of its responsibilities for safety on the project. The Contractor has sole responsibility for safety.

**V. SAFETY QUESTIONNAIRE**

DDC requires that all Contractors provide information regarding their current and past safety performance and programs. This will be accomplished by the use of the DDC Safety Questionnaire. As a part of the bid submittal package, the contractor must submit a completed DDC Safety Questionnaire listing company workers' compensation experience modification rating and OSHA Incident Rates for the three (3) years prior to the date of the bid opening. DDC may request a Contractor to update its Questionnaire at any time or to provide more detailed information. The Contractor must provide the requested information within 15 days.

The following criteria will be used by DDC in reviewing the Contractor's responsibility, which will be based on the information provided on the questionnaire:

- Criteria 1: OSHA Injury and Illness Rates (I&IR) are no greater than the average for the industry (based on the most current Bureau of Labor Statistics data for the Contractors SIC code); and
- Criteria 2: Insurance workers compensation Experience Modification Rate (EMR) equal to or less than 1.0; and
- Criteria 3: Any willful violations issued by OSHA or NYC DOB within the last three (3) years; and
- Criteria 4: A fatality (worker or member of public) and injuries, requiring OSHA notification, experienced on or near Contractor's worksite within the last three (3) years; and
- Criteria 5: Past safety performance on DDC projects (accidents; status of safety program and site safety plan submittals; etc.)
- Criteria 6: OSHA violation history for the last three (3) years;
- Criteria 7: Contractor shall provide OSHA Injury and Illness Records (currently OSHA 300 and 300A Logs) for the last three (3) years.

If the Contractor fails to meet the basic criteria listed above, the Construction Safety Unit may request, through the ACCO, more details concerning the Contractor's safety experience. DDC may request the Contractor to provide copies of, among other things, accident investigation reports, OSHA records, OSHA and NYC DOB citations, EPA citations and written corrective action plan.



City of New York Department of Design and Construction: Safety Requirements  
Safety and Site Support- Quality Assurance and Construction Safety

**VI. SAFETY PROGRAM AND SITE SAFETY PLAN**

Within thirty (30) days from the Award Date, or as otherwise directed, the Contractor shall submit the following: (1) Safety Program, and (2) Site Safety Plan. The Safety Program shall set forth the Contractor's overall safety policy, regulatory compliance plan and minimum safety standards. The Site Safety Plan shall identify project work scope, safety hazards associated with the project tasks, and include specific safety procedures and training appropriate and necessary to complete the work. The Safety Program and the Site Safety Plan are subject to review and acceptance by the Construction Safety Unit prior to the commencement of work at the site. Failure by the Contractor to submit an acceptable Site Safety Plan and Safety Program shall be grounds for default.

**Safety Program:** Corporate Safety Program established by the Contractor that includes the Contractor's overall safety policy, regulatory compliance plan and basic safety procedures covering all aspects of construction operations, performed by the Contractor. The Safety Program shall be a written document with a separate section describing each element of the Safety Program. The Safety Program shall have at minimum the following elements applicable to the Contractor's operations:

- Responsibility and Organization – Contractor's company organization chart, including titles, names, contact information, roles and responsibilities for key personnel, etc.
- Safety Training Program – Contractor's corporate training program.
- Hazard Corrective Actions – Criteria for safety inspections, identification of safety non-compliances, implementation and verification of corrective actions, forms to document safety inspections results, etc.
- Accident/Exposure Investigation
- Recordkeeping and Reporting Injuries – Responsible staff; reporting and recording criteria; OSHA 300 and 300A form completion, etc.
- Fire Protection and Prevention Program
- Housekeeping
- Illumination
- Sanitation
- Personal Protective Equipment (PPE) – Company policy for the use of head protection, foot protection, hearing protection, eye and face protection, protective clothing, and any additional protective equipment based on work tasks; PPE inspection and replacement policy.
- Hazard Communication Program
- Employee Emergency Action Plan
- Protection of Underground Facilities and Utilities
- Ionizing/Nonionizing Radiation
- Material Handling, Storage, Use and Disposal
- Tools – Hand and Power
- Signs, Signals, and Barricades
- Scaffold – Local Law 52 requirements, installation, use, inspection, dismantling, training and general safety requirements.
- Welding and Cutting
- Electrical Safety
- Fall Protection
- Cranes, Derrick, Hoists, Elevators, Conveyors
- Excavation Safety
- Concrete and Masonry Construction
- Maintenance and Protection of Traffic
- Steel Erection
- Demolition
- Blasting and the Use of Explosives
- Stairways and Ladders

City of New York Department of Design and Construction: Safety Requirements  
Safety and Site Support- Quality Assurance and Construction Safety

- Toxic and Hazardous Substances
- Alcohol and Drug Abuse Policy
- Rodents and Vermin
- Occupational Noise Exposure
- Confined Space Program – General confined Space Program: training requirements, confined space hazard evaluation procedure, atmospheric testing procedure, confined space classification, permit-required procedure, communication procedure, rescue procedure, forms, etc.
- Construction Vehicles/Heavy Equipment
- Dust Control Procedures

**Site Safety Plan:** The Site Safety Plan shall be a written document and shall apply to all project specific Contractor and subcontractor operations, and shall have at a minimum, the following elements with each element described in a separate section (It may be necessary to modify the basic format for certain unique or high-risk projects, such as tunnels or high-rise construction):

- Project Work Scope – Detailed information regarding work tasks that will be performed by contractor and subcontractors under the project.
- Responsibility and Organization – Contractor's organization chart with responsible staff for the project, including titles, names, contact information, roles and responsibilities.
- Safety Training and Education – OSHA 10 Hours training, requirements for daily safety briefings and weekly safety meetings, any work task specific training, responsible staff for implementation of training program for the project.
- Job Hazard Analysis (JHA) – Project specific Job Hazard Analysis including work tasks, identified hazards, hazard control methods (administrative, engineering, PPE), contractor's name, project id, location, name and signature of a certifying person, hazard assessment date.
- Protection of Public
- Hazard Corrective Actions – Responsible staff, forms, frequency of safety inspections and implementation of corrective actions.
- Accident/Exposure Investigation – Accident/incident notification procedure of DDC project staff. Project specific procedures for accident investigation and implementation of corrective actions.
- First Aid and Medical Attention – Responsible staff, location and inspection of First Aid kit, directions to local hospitals; emergency telephone numbers.
- Project Specific Fire Protection and Prevention Program.
- Project Specific Illumination Procedure.
- Project Specific Sanitation Procedure.
- Personal Protective Equipment (PPE)
- Hazard Communication Program – Responsible staff, training; SDS records, project specific list of chemical; location of the program and SDS records.
- Means of Egress – Information regarding free and unobstructed egress from all parts of the building or structure; exit marking; maintenance of means of egress, etc.
- Employee Emergency Action Plan – Project specific: responsible staff, emergency alarm system, evacuation procedure, procedure to account for employees after evacuation, etc.
- Evacuation Plan – Project specific evacuation plan (drawing/scheme) with exists and evacuation routes.
- Protection of Underground Facilities and Utilities, including responsible staff.
- Ionizing/Nonionizing Radiation – Competent person, license and qualification requirements, type of radiation, employees exposure and protection, etc.
- Material Handling, Storage, Use and Disposal – Project specific information regarding material storage and disposal.
- Signs, Signals, and Barricades – Use of danger/warning signs, sidewalk closure, safety instruction signs, pedestrian fencing and barricades, etc.
- Scaffold – Project specific scaffold types, training, scaffold drawings, competent person, criteria for project specific scaffold, falling object protection.

City of New York Department of Design and Construction: Safety Requirements  
Safety and Site Support- Quality Assurance and Construction Safety

- Welding and Cutting - project specific procedure for welding and cutting, including all necessary safety requirements such as fire prevention, personal protective equipment, hot work permits, FDNY certificate requirements.
- Fall Protection - Project specific information regarding selected fall protection systems, fall protection plan.
- Cranes, Derrick, Hoists, Elevators, Conveyors - project specific equipment information including type, rated load capacity, manufacture specification requirements, competent person, exposure to falling load, inspection, recordkeeping, clearance requirements, communication procedure, ground lines, permits.
- Excavation Safety - Competent person, project specific protective system.
- Maintenance and Protection of Traffic Plan - Project specific MPT plan, flagmen training.
- Steel Erection - Site specific erection plan, requirements for applicable written notifications, competent person.
- Demolition - Engineering survey, including written evidence, disconnection of all effected utilities, identification of all hazardous chemicals, materials, gases, etc., floor openings, chutes, inspection and maintenance of all stairs/passageways, removal of materials/debris/structural elements, lock out/tag out, competent person.
- Blasting and the Use of Explosives - Project specific safety procedures, warning signs, training/qualification, transportation, storage and use of explosives, inspection.
- Toxic and Hazardous Substances - Safety procedures for substances to be used on project.
- Noise Mitigation Plan - Completed project specific Noise Mitigation Plan.
- Confined Space Program - Project specific Confined Space Program, responsible staff, training records, equipment information, rescue procedure, list of project specific confined spaces, forms.
- Construction Vehicles/Heavy Equipment - Type of construction vehicles/heavy equipment to be used on site.
- Dust Mitigation Plan - Completed project specific Dust Mitigation Plan.

The most critical component of the Site Safety Plan is the Job Hazard Analysis (JHA) section. The JHA form is a written document prepared by the contractor. The contractor must conduct a site and task assessment JHA to identify the major job steps and any potential safety or environmental hazards related to performance of the work, eliminate or implement controls for the potential hazards, and identify proper personal protective equipment for the task. The JHA shall be communicated to all contractor/subcontractor personnel on site.

The initial Job Hazard Assessment form shall be included in the contractor's Site Safety Plan and the current form shall be available at the construction site for reference.

Certain DDC programs, such as Job Order Contracting System (JOCS), may not necessarily require Site Safety Plans. The JOCS contractor shall submit a Safety Program. The Site Safety Plan requirement for the JOCS contractor will be determined by QA&CS based on a project work scope, construction activities and project location. In addition, certain DDC Operating Units may establish client-specific program or safety requirements. The contractor's Site Safety Plan must address such client-specific program or safety requirements.

## VII. KICK-OFF MEETINGS/PRE-CONSTRUCTION AND SAFETY REVIEW

RE/CPM shall invite QA&CS Construction Safety Unit to the construction kick-off meeting. A QA&CS representative will participate in this meeting with the Contractor and RE/CPM prior to the start of the project for the purpose of:

- A. Reviewing the safety issues detailed in the contract.
- B. Reviewing the Site Safety Plan.
- C. Reviewing any new issues or information that was not previously addressed.
- D. Discussing planned inspections and audits of the site by QA&CS personnel.

City of New York Department of Design and Construction: Safety Requirements  
Safety and Site Support- Quality Assurance and Construction Safety

**VIII. EVALUATION DURING WORK IN PROGRESS**

The Contractor's adherence to these Safety Requirements will be monitored throughout the project. This will be accomplished by the following:

- A. Use of a safety checklist by a representative of the Construction Safety Unit or other designated DDC representative or Consultant during regular, unannounced inspections of the job site. Field Exit Conferences will be held with the RE/CPM, Contractor Project Safety Representatives.
- B. The RE/CPM will continually monitor the safety and environmental performance of the contractor's employees and work methods. Deficiencies shall be brought to the attention of the contractor's representative on site for immediate correction. The DDC representative will maintain a written record of these deficiencies and have these records available upon request. Any critical deficiencies shall be immediately reported to QA&CS phone# (718) 391-1624 or (718) 391-1911.
- C. If the Contractor's safety performance during the project is not up to DDC standards (safety performance measure, accident/incident rate, etc.) the Director - QA&CS, or his/her designee will meet with the Contractor's Project Safety Representative and or Project Safety Manager, the DDC Project Manager, the RE/CPM, and the DDC Environmental Specialist (if environmental issues are involved). The purpose of this meeting is to 1) determine the level of non-compliance; 2) explain and clarify the safety/environmental provisions; 3) agree on a future course of action to correct the deficiencies.
- D. If the deficiencies continue to occur with inadequate attention by the contractor, this shall, among other remedies available, be grounds for default.
- E. The contractor shall within 1 hour inform the RE/CPM/CM of all accidents/incidents including all fatalities, any injuries to employees or members of the general public, and property damage (e.g., structural damage, equipment rollovers, utility damage, loads dropped from crane). The RE/CPM shall notify the Construction Safety Unit as per DDC's Construction Safety Emergency and Accident Notification and Response Protocol and shall maintain a record of all contractor accidents/incidents for the project.
- F. The Construction Safety Unit shall be notified within two (2) hours of the start of any NYS-DOL/ NYC-COSH/ OSHA/ EPA inspections.

**IX. SAFETY PERFORMANCE EVALUATION**

The contractor's safety record, including accident/incident history and DDC safety inspection results, will be considered as part of the Contractor's performance evaluation at the conclusion of the project. Poor safety performance during the course of the project shall be a reason to rate a Contractor unsatisfactory which may be reflected in the City's Vendex system and will be considered for future procurement actions as set forth in the City's Procurement Policy Board Rules.

**CITY OF NEW YORK**  
**STANDARD CONSTRUCTION CONTRACT**

**March 2017**

( NO TEXT ON THIS PAGE )

**CITY OF NEW YORK  
STANDARD CONSTRUCTION CONTRACT**

**TABLE OF CONTENTS**

CHAPTER I: THE CONTRACT AND DEFINITIONS .....	1
ARTICLE 1. THE CONTRACT .....	1
ARTICLE 2. DEFINITIONS .....	1
CHAPTER II: THE WORK AND ITS PERFORMANCE .....	4
ARTICLE 3. CHARACTER OF THE WORK .....	4
ARTICLE 4. MEANS AND METHODS OF CONSTRUCTION .....	4
ARTICLE 5. COMPLIANCE WITH LAWS .....	5
ARTICLE 6. INSPECTION .....	10
ARTICLE 7. PROTECTION OF WORK AND OF PERSONS AND PROPERTY; NOTICES AND INDEMNIFICATION .....	11
CHAPTER III: TIME PROVISIONS .....	12
ARTICLE 8. COMMENCEMENT AND PROSECUTION OF THE WORK .....	12
ARTICLE 9. PROGRESS SCHEDULES .....	13
ARTICLE 10. REQUESTS FOR INFORMATION OR APPROVAL .....	13
ARTICLE 11. NOTICE OF CONDITIONS CAUSING DELAY AND DOCUMENTATION OF DAMAGES CAUSED BY DELAY .....	14
ARTICLE 12. COORDINATION WITH OTHER CONTRACTORS .....	18
ARTICLE 13. EXTENSION OF TIME FOR PERFORMANCE .....	19
ARTICLE 14. COMPLETION AND FINAL ACCEPTANCE OF THE WORK .....	21
ARTICLE 15. LIQUIDATED DAMAGES .....	23
ARTICLE 16. OCCUPATION OR USE PRIOR TO COMPLETION .....	23
CHAPTER IV: SUBCONTRACTS AND ASSIGNMENTS .....	24
ARTICLE 17. SUBCONTRACTS .....	24
ARTICLE 18. ASSIGNMENTS .....	26
CHAPTER V: CONTRACTOR'S SECURITY AND GUARANTEE .....	26
ARTICLE 19. SECURITY DEPOSIT .....	26
ARTICLE 20. PAYMENT GUARANTEE .....	27
ARTICLE 21. RETAINED PERCENTAGE .....	29
ARTICLE 22. INSURANCE .....	30
ARTICLE 23. MONEY RETAINED AGAINST CLAIMS .....	36
ARTICLE 24. MAINTENANCE AND GUARANTY .....	37
CHAPTER VI: CHANGES, EXTRA WORK, AND DOCUMENTATION OF CLAIM .....	38
ARTICLE 25. CHANGES .....	38
ARTICLE 26. METHODS OF PAYMENT FOR OVERRUNS AND EXTRA WORK .....	38
ARTICLE 27. RESOLUTION OF DISPUTES .....	41
ARTICLE 28. RECORD KEEPING FOR EXTRA OR DISPUTED WORK OR WORK ON A TIME & MATERIALS BASIS .....	45
ARTICLE 29. OMITTED WORK .....	46
ARTICLE 30. NOTICE AND DOCUMENTATION OF COSTS AND DAMAGES; PRODUCTION OF FINANCIAL RECORDS .....	46
CHAPTER VII: POWERS OF THE RESIDENT ENGINEER, THE ENGINEER OR ARCHITECT AND THE COMMISSIONER .....	48
ARTICLE 31. THE RESIDENT ENGINEER .....	48
ARTICLE 32. THE ENGINEER OR ARCHITECT OR PROJECT MANAGER .....	48
ARTICLE 33. THE COMMISSIONER .....	48
ARTICLE 34. NO ESTOPPEL .....	49
CHAPTER VIII: LABOR PROVISIONS .....	49
ARTICLE 35. EMPLOYEES .....	49
ARTICLE 36. NO DISCRIMINATION .....	57
ARTICLE 37. LABOR LAW REQUIREMENTS .....	59

ARTICLE 38. PAYROLL REPORTS .....	64
ARTICLE 39. DUST HAZARDS .....	64
CHAPTER IX: PARTIAL AND FINAL PAYMENTS .....	65
ARTICLE 40. CONTRACT PRICE .....	65
ARTICLE 41. BID BREAKDOWN ON LUMP SUM.....	65
ARTICLE 42. PARTIAL PAYMENTS .....	65
ARTICLE 43. PROMPT PAYMENT.....	66
ARTICLE 44. SUBSTANTIAL COMPLETION PAYMENT.....	66
ARTICLE 45. FINAL PAYMENT.....	67
ARTICLE 46. ACCEPTANCE OF FINAL PAYMENT.....	68
ARTICLE 47. APPROVAL BY PUBLIC DESIGN COMMISSION.....	69
CHAPTER X: CONTRACTOR'S DEFAULT .....	69
ARTICLE 48. COMMISSIONER'S RIGHT TO DECLARE CONTRACTOR IN DEFAULT .....	69
ARTICLE 49. EXERCISE OF THE RIGHT TO DECLARE DEFAULT .....	71
ARTICLE 50. QUITTING THE SITE.....	71
ARTICLE 51. COMPLETION OF THE WORK.....	71
ARTICLE 52. PARTIAL DEFAULT .....	71
ARTICLE 53. PERFORMANCE OF UNCOMPLETED WORK.....	72
ARTICLE 54. OTHER REMEDIES .....	72
CHAPTER XI: MISCELLANEOUS PROVISIONS .....	72
ARTICLE 55. CONTRACTOR'S WARRANTIES.....	72
ARTICLE 56. CLAIMS AND ACTIONS THEREON.....	73
ARTICLE 57. INFRINGEMENT .....	73
ARTICLE 58. NO CLAIM AGAINST OFFICIALS, AGENTS OR EMPLOYEES.....	74
ARTICLE 59. SERVICE OF NOTICES .....	74
ARTICLE 60. UNLAWFUL PROVISIONS DEEMED STRICKEN FROM CONTRACT.....	74
ARTICLE 61. ALL LEGAL PROVISIONS DEEMED INCLUDED .....	74
ARTICLE 62. TAX EXEMPTION .....	74
ARTICLE 63. INVESTIGATION(S) CLAUSE.....	76
ARTICLE 64. TERMINATION BY THE CITY .....	78
ARTICLE 65. CHOICE OF LAW, CONSENT TO JURISDICTION AND VENUE .....	80
ARTICLE 66. PARTICIPATION IN AN INTERNATIONAL BOYCOTT .....	81
ARTICLE 67. LOCALLY BASED ENTERPRISE PROGRAM .....	82
ARTICLE 68. ANTITRUST .....	82
ARTICLE 69. MACBRIDE PRINCIPLES PROVISIONS .....	83
ARTICLE 70. ELECTRONIC FILING/NYC DEVELOPMENT HUB .....	85
ARTICLE 71. PROHIBITION OF TROPICAL HARDWOODS.....	85
ARTICLE 72. CONFLICTS OF INTEREST.....	85
ARTICLE 73. MERGER CLAUSE .....	85
ARTICLE 74. STATEMENT OF WORK.....	85
ARTICLE 75. COMPENSATION TO BE PAID TO CONTRACTOR .....	85
ARTICLE 76. ELECTRONIC FUNDS TRANSFER .....	85
ARTICLE 77. RECORDS RETENTION.....	86
ARTICLE 78. EXAMINATION AND VIEWING OF SITE, CONSIDERATION OF OTHER SOURCES OF INFORMATION AND CHANGED SITE CONDITIONS.....	86



<b>ARTICLE 79: PARTICIPATION BY MINORITY-OWNED AND WOMEN-OWNED BUSINESS ENTERPRISES IN CITY PROCUREMENT .....</b>	<b>87</b>
<b>SIGNATURES .....</b>	<b>95</b>
<b>ACKNOWLEDGMENT BY CORPORATION .....</b>	<b>96</b>
<b>ACKNOWLEDGMENT BY PARTNERSHIP.....</b>	<b>96</b>
<b>ACKNOWLEDGMENT BY INDIVIDUAL .....</b>	<b>96</b>
<b>ACKNOWLEDGMENT BY COMMISSIONER .....</b>	<b>97</b>
<b>AUTHORITY .....</b>	<b>98</b>
<b>COMPTROLLER'S CERTIFICATE .....</b>	<b>98</b>
<b>MAYOR'S CERTIFICATE .....</b>	<b>99</b>
<b>PERFORMANCE BOND #1 .....</b>	<b>100</b>
<b>PERFORMANCE BOND #2.....</b>	<b>104</b>
<b>PAYMENT BOND .....</b>	<b>108</b>

---

( NO TEXT ON THIS PAGE )

**WITNESSETH:**

The parties, in consideration of the mutual agreements contained herein, agree as follows:

**CHAPTER I: THE CONTRACT AND DEFINITIONS**

**ARTICLE 1. THE CONTRACT**

1.1 Except for titles, subtitles, headings, running headlines, tables of contents and indices (all of which are printed herein merely for convenience), the following, except for such portions thereof as may be specifically excluded, shall be deemed to be part of this Contract:

1.1.1 All provisions required by law to be inserted in this Contract, whether actually inserted or not;

1.1.2 The Contract Drawings and Specifications;

1.1.3 The General Conditions and Special Conditions, if any;

1.1.4 The Contract;

1.1.5 The Information for Bidders; Request for Proposals; Notice of Solicitation and Proposal For Bids; Bid or Proposal, and, if used, the Bid Booklet;

1.1.6 All Addenda issued prior to the receipt of the bids; the Notice of Award; Performance and Payment Bonds, if required; and the Notice to Proceed or the Order to Work.

1.2 Should any conflict occur in or between the Drawings and Specifications, the Contractor shall be deemed to have estimated the most expensive way of doing the Work, unless the Contractor shall have asked for and obtained a decision in writing from the Commissioner of the Agency that is entering into this Contract, before the submission of its bid, as to what shall govern.

**ARTICLE 2. DEFINITIONS**

2.1 The following words and expressions, or pronouns used in their stead, shall, wherever they appear in this Contract, be construed as follows, unless a different meaning is clear from the context:

2.1.1 "Addendum" or "Addenda" shall mean the additional Contract provisions and/or technical clarifications issued in writing by the Commissioner prior to the receipt of bids.

2.1.2 "Agency" shall mean a city, county, borough or other office, position, department, division, bureau, board or commission, or a corporation, institution or agency of government, the expenses of which are paid in whole or in part from the City treasury.

2.1.3 "Agency Chief Contracting Officer" (ACCO) shall mean a person delegated authority by the Commissioner to organize and supervise the procurement activity of subordinate Agency staff in conjunction with the CCPO, or his/her duly authorized representative.

2.1.4 **"Allowance"** shall mean a sum of money which the Agency may include in the total amount of the Contract for such specific contingencies as the Agency believes may be necessary to complete the Work, e.g., lead or asbestos remediation, and for which the Contractor will be paid on the basis of stipulated unit prices or a formula set forth in the Contract or negotiated between the parties provided, however, that if the Contractor is not directed to use the Allowance, the Contractor shall have no right to such money and it shall be deducted from the total amount of the Contract.

2.1.5 **"City"** shall mean the City of New York.

2.1.6 **"City Chief Procurement Officer" (CCPO)** shall mean a person delegated authority by the Mayor to coordinate and oversee the procurement activity of Mayoral agency staff, including the ACCO and any offices which have oversight responsibility for the procurement of construction, or his/her duly authorized representative.

2.1.7 **"Commissioner"** shall mean the head of the Agency that has entered into this Contract, or his/her duly authorized representative.

2.1.8 **"Comptroller"** shall mean the Comptroller of the City of New York.

2.1.9 **"Contract"** or **"Contract Documents"** shall mean each of the various parts of the contract referred to in Article 1 hereof, both as a whole and severally.

2.1.10 **"Contract Drawings"** shall mean only those drawings specifically entitled as such and listed in the Specifications or in any Addendum, or any drawings furnished by the Commissioner, pertaining or supplemental thereto.

2.1.11 **"Contract Work"** shall mean everything required to be furnished and done by the Contractor by any one or more of the parts of the Contract referred to in Article 1, except Extra Work as hereinafter defined.

2.1.12 **"Contractor"** shall mean the entity which executed this Contract, whether a corporation, firm, partnership, joint venture, individual, or any combination thereof, and its, their, his/her successors, personal representatives, executors, administrators, and assigns, and any person, firm, partnership, joint venture, individual, or corporation which shall at any time be substituted in the place of the Contractor under this Contract.

2.1.13 **"Days"** shall mean calendar days, except where otherwise specified.

2.1.14 **"Engineer"** or **"Architect"** or **"Project Manager"** shall mean the person so designated in writing by the Commissioner in the Notice to Proceed or the Order to Work to act as such in relation to this Contract, including a private Architect or Engineer or Project Manager, as the case may be. Subject to written approval by the Commissioner, the Engineer, Architect or Project Manager may designate an authorized representative.

2.1.15 **"Engineering Audit Officer" (EAO)** shall mean the person so designated by the Commissioner to perform responsible auditing functions hereunder.

2.1.16 **"Extra Work"** shall mean Work other than that required by the Contract at the time of award which is authorized by the Commissioner pursuant to Chapter VI of this Contract.

2.1.17 **"Federal-Aid Contract"** shall mean a contract in which the United States (federal) Government provides financial funding as so designated in the Information for Bidders.

2.1.18 **"Final Acceptance"** shall mean final written acceptance of all the Work by the Commissioner, a copy of which shall be sent to the Contractor.

2.1.19 **"Final Approved Punch List"** shall mean a list, approved pursuant to Article 14.2.2, specifying those items of Work to be completed by the Contractor after Substantial Completion and dates for the completion of each item of Work.

2.1.20 **"Law"** or **"Laws"** shall mean the Constitution of the State of New York, the New York City Charter, the New York City Administrative Code, a statute of the United States or of the State of New York, a local law of the City of New York, any ordinance, rule or regulation having the force of law, or common law.

2.1.21 **"Materialman"** shall mean any corporation, firm, partnership, joint venture, or individual, other than employees of the Contractor, who or which contracts with the Contractor or any Subcontractor, to fabricate or deliver, or who actually fabricates or delivers, plant, materials or equipment to be incorporated in the Work.

2.1.22 **"Means and Methods of Construction"** shall mean the labor, materials, temporary structures, tools, plant, and construction equipment, and the manner and time of their use, necessary to accomplish the result intended by this Contract.

2.1.23 **"Notice to Proceed"** or **"Order to Work"** shall mean the written notice issued by the Commissioner specifying the time for commencement of the Work and the Engineer, Architect or Project Manager.

2.1.24 **"Other Contractor(s)"** shall mean any contractor (other than the entity which executed this Contract or its Subcontractors) who or which has a contract with the City for work on or adjacent to the building or Site of the Work.

2.1.25 **"Payroll Taxes"** shall mean State Unemployment Insurance (SUI), Federal Unemployment Insurance (FUI), and payments pursuant to the Federal Insurance Contributions Act (FICA).

2.1.26 **"Project"** shall mean the public improvement to which this Contract relates.

2.1.27 **"Procurement Policy Board"** (PPB) shall mean the Agency of the City of New York whose function is to establish comprehensive and consistent procurement policies and rules which shall have broad application throughout the City.

2.1.28 **"Required Quantity"** in a unit price Contract shall mean the actual quantity of any item of Work or materials which is required to be performed or furnished in order to comply with the Contract.

2.1.29 **"Resident Engineer"** shall mean the representative of the Commissioner duly designated by the Commissioner to be his/her representative at the site of the Work.

2.1.30 **"Site"** shall mean the area upon or in which the Contractor's operations are carried on, and such other areas adjacent thereto as may be designated as such by the Engineer.

2.1.31 **"Small Tools"** shall mean items that are ordinarily required for a worker's job function, including but not limited to, equipment that ordinarily has no licensing, insurance or substantive storage costs associated with it; such as circular and chain saws, impact drills, threaders, benders, wrenches, socket tools, etc.

2.1.32 **"Specifications"** shall mean all of the directions, requirements, and standards of performance applying to the Work as hereinafter detailed and designated under the Specifications.

2.1.33 **"Subcontractor"** shall mean any person, firm or corporation, other than employees of the Contractor, who or which contracts with the Contractor or with its subcontractors to furnish, or actually furnishes labor, or labor and materials, or labor and equipment, or superintendence, supervision and/or management at the Site. Wherever the word Subcontractor appears, it shall also mean sub-Subcontractor.

2.1.34 **"Substantial Completion"** shall mean the written determination by the Engineer that the Work required under this Contract is substantially, but not entirely, complete and the approval of the **Final Approved Punch List**.

2.1.35 **"Work"** shall mean all services required to complete the Project in accordance with the Contract Documents, including without limitation, labor, material, superintendence, management, administration, equipment, and incidentals, and obtaining any and all permits, certifications and licenses as may be necessary and required to complete the Work, and shall include both Contract Work and Extra Work.

## **CHAPTER II: THE WORK AND ITS PERFORMANCE**

### **ARTICLE 3. CHARACTER OF THE WORK**

3.1 Unless otherwise expressly provided in the **Contract Drawings, Specifications, and Addenda**, the **Work** shall be performed in accordance with the best modern practice, utilizing, unless otherwise specified in writing, new and unused materials of standard first grade quality and workmanship and design of the highest quality, to the satisfaction of the **Commissioner**.

### **ARTICLE 4. MEANS AND METHODS OF CONSTRUCTION**

4.1 Unless otherwise expressly provided in the **Contract Drawings, Specifications, and Addenda**, the **Means and Methods of Construction** shall be such as the **Contractor** may choose; subject, however, to the **Engineer's** right to reject the **Means and Methods of Construction** proposed by the **Contractor** which in the opinion of the **Engineer**:

4.1.1 Will constitute or create a hazard to the **Work**, or to persons or property; or

4.1.2 Will not produce finished **Work** in accordance with the terms of the **Contract**; or

4.1.3 Will be detrimental to the overall progress of the **Project**.

4.2 The **Engineer's** approval of the **Contractor's Means and Methods of Construction**, or his/her failure to exercise his/her right to reject such means or methods, shall not relieve the **Contractor**

of its obligation to complete the Work as provided in this Contract; nor shall the exercise of such right to reject create a cause of action for damages.

#### **ARTICLE 5. COMPLIANCE WITH LAWS**

5.1 The Contractor shall comply with all Laws applicable to this Contract and to the Work to be done hereunder.

5.2 Procurement Policy Board Rules: This Contract is subject to the Rules of the PPB ("PPB Rules") in effect at the time of the bid opening for this Contract. In the event of a conflict between the PPB Rules and a provision of this Contract, the PPB Rules shall take precedence.

5.3 Noise Control Code provisions.

5.3.1 In accordance with the provisions of Section 24-216(b) of the Administrative Code of the City ("Administrative Code"), Noise Abatement Contract Compliance, devices and activities which will be operated, conducted, constructed or manufactured pursuant to this Contract and which are subject to the provisions of the City Noise Control Code shall be operated, conducted, constructed, or manufactured without causing a violation of the Administrative Code. Such devices and activities shall incorporate advances in the art of noise control development for the kind and level of noise emitted or produced by such devices and activities, in accordance with regulations issued by the Commissioner of the City Department of Environmental Protection.

5.3.2 The Contractor agrees to comply with Section 24-219 of the Administrative Code and implementing rules codified at 15 Rules of the City of New York ("RCNY") Section 28-100 *et seq.* In accordance with such provisions, the Contractor, if the Contractor is the responsible party under such regulations, shall prepare and post a Construction Noise Mitigation Plan at each Site, in which the Contractor shall certify that all construction tools and equipment have been maintained so that they operate at normal manufacturers operating specifications. If the Contractor cannot make this certification, it must have in place an Alternative Noise Mitigation Plan approved by the City Department of Environmental Protection. In addition, the Contractor's certified Construction Noise Mitigation Plan is subject inspection by the City Department of Environmental Protection in accordance with Section 28-101 of Title 15 of RCNY. No Contract Work may take place at a Site unless there is a Construction Noise Mitigation Plan or approved Alternative Noise Mitigation Plan in place. In addition, the Contractor shall create and implement a noise mitigation training program. Failure to comply with these requirements may result in fines and other penalties pursuant to the applicable provisions of the Administrative Code and RCNY.

5.4 Ultra Low Sulfur Diesel Fuel: In accordance with the provisions of Section 24-163.3 of the Administrative Code, the Contractor specifically agrees as follows:

5.4.1 Definitions. For purposes of this Article 5.4, the following definitions apply:

5.4.1(a) "Contractor" means any person or entity that enters into a Public Works Contract with a City Agency, or any person or entity that enters into an agreement with such person or entity, to perform work or provide labor or services related to such Public Works Contract.

5.4.1(b) "Motor Vehicle" means any self-propelled vehicle designed for transporting persons or property on a street or highway.

5.4.1(c) "Nonroad Engine" means an internal combustion engine (including the fuel system) that is not used in a Motor Vehicle or a vehicle used solely for competition, or that is not subject to standards promulgated under Section 7411 or Section 7521 of Title 42 of the United States Code, except that this term shall apply to internal combustion engines used to power generators, compressors or similar equipment used in any construction program or project.

5.4.1(d) "Nonroad Vehicle" means a vehicle that is powered by a Nonroad Engine, fifty (50) horsepower and greater, and that is not a Motor Vehicle or a vehicle used solely for competition, which shall include, but not be limited to, excavators, backhoes, cranes, compressors, generators, bulldozers, and similar equipment, except that this term shall not apply to horticultural maintenance vehicles used for landscaping purposes that are powered by a Nonroad Engine of sixty-five (65) horsepower or less and that are not used in any construction program or project.

5.4.1(e) "Public Works Contract" means a contract with a City Agency for a construction program or project involving the construction, demolition, restoration, rehabilitation, repair, renovation, or abatement of any building, structure, tunnel, excavation, roadway, park or bridge; a contract with a City Agency for the preparation for any construction program or project involving the construction, demolition, restoration, rehabilitation, repair, renovation, or abatement of any building, structure, tunnel, excavation, roadway, park or bridge; or a contract with a City Agency for any final work involved in the completion of any construction program or project involving the construction, demolition, restoration, rehabilitation, repair, renovation, or abatement of any building, structure, tunnel, excavation, roadway, park or bridge.

5.4.1(f) "Ultra Low Sulfur Diesel Fuel" means diesel fuel that has a sulfur content of no more than fifteen parts per million (15 ppm).

#### 5.4.2 Ultra Low Sulfur Diesel Fuel

5.4.2(a) All Contractors shall use Ultra Low Sulfur Diesel Fuel in diesel-powered Nonroad Vehicles in the performance of this Contract.

5.4.2(b) Notwithstanding the requirements of Article 5.4.2(a), Contractors may use diesel fuel that has a sulfur content of no more than thirty parts per million (30 ppm) to fulfill the requirements of this Article 5.4.2, where the Commissioner of the City Department of Environmental Protection ("DEP Commissioner") has issued a determination that a sufficient quantity of Ultra Low Sulfur Diesel Fuel is not available to meet the needs of Agencies and Contractors. Any such determination shall expire after six (6) months unless renewed.

5.4.2(c) Contractors shall not be required to comply with this Article 5.4.2 where the City Agency letting this Contract makes a written finding, which is approved, in writing, by the DEP Commissioner, that a sufficient quantity of Ultra Low Sulfur Diesel Fuel, or diesel fuel that has a sulfur content of no more than thirty parts per million (30 ppm) is not available to meet the requirements of Section 24-163.3 of the Administrative Code, provided that such Contractor in its fulfillment of the



requirements of this Contract, to the extent practicable, shall use whatever quantity of Ultra Low Sulfur Diesel Fuel or diesel fuel that has a sulfur content of no more than thirty parts per million (30 ppm) is available. Any finding made pursuant to this Article 5.4.2(c) shall expire after sixty (60) Days, at which time the requirements of this Article 5.4.2 shall be in full force and effect unless the City Agency renews the finding in writing and such renewal is approved by the DEP Commissioner.

5.4.2(d) Contractors may check on determinations and approvals issued by the DEP Commissioner pursuant to Section 24-163.3 of the Administrative Code, if any, at [www.dep.nyc.gov](http://www.dep.nyc.gov) or by contacting the City Agency letting this Contract.

5.4.2(e) The requirements of this Article 5.4.2 do not apply where they are precluded by federal or State funding requirements or where the Contract is an emergency procurement.

#### 5.4.3 Best Available Technology

5.4.3(a) All Contractors shall utilize the best available technology for reducing the emission of pollutants for diesel-powered Nonroad Vehicles in the performance of this Contract. For determinations of best available technology for each type of diesel-powered Nonroad Vehicle, Contractors shall comply with the regulations of the City Department of Environmental Protection, as and when adopted, Chapter 14 of Title 15 of the Rules of the City of New York (RCNY). The Contractor shall fully document all steps in the best available technology selection process and shall furnish such documentation to the City Agency or the DEP Commissioner upon request. The Contractor shall retain all documentation generated in the best available technology selection process for as long as the selected best available technology is in use.

5.4.3(b) No Contractor shall be required to replace best available technology for reducing the emission of pollutants or other authorized technology utilized for a diesel-powered Nonroad Vehicle in accordance with the provisions of this Article 5.4.3 within three (3) years of having first utilized such technology for such vehicle.

5.4.3(c) This Article 5.4.3 shall not apply to any vehicle used to satisfy the requirements of a specific Public Works Contract for fewer than twenty (20) Days.

5.4.3(d) The Contractor shall not be required to comply with this Article 5.4.3 with respect to a diesel-powered Nonroad Vehicle under the following circumstances:

5.4.3(d)(i) Where the City Agency makes a written finding, which is approved, in writing, by the DEP Commissioner, that the best available technology for reducing the emission of pollutants as required by this Article 5.4.3 is unavailable for such vehicle, the Contractor shall use whatever technology for reducing the emission of pollutants, if any, is available and appropriate for such vehicle.

5.4.3(d)(ii) Where the DEP Commissioner has issued a written waiver based upon the Contractor having demonstrated to the DEP Commissioner that the use of the best available technology for reducing the emission of pollutants might endanger the operator of such vehicle or those working near such vehicle, due to engine malfunction, the Contractor shall use whatever technology for

reducing the emission of pollutants, if any, is available and appropriate for such vehicle, which would not endanger the operator of such vehicle or those working near such vehicle.

5.4.3(d)(iii) In determining which technology to use for the purposes of Articles 5.4.3(d)(i) and 5.4.3(d)(ii) above, the Contractor shall primarily consider the reduction in emissions of particulate matter and secondarily consider the reduction in emissions of nitrogen oxides associated with the use of such technology, which shall in no event result in an increase in the emissions of either such pollutant.

5.4.3(d)(iv) The Contractor shall submit requests for a finding or a waiver pursuant to this Article 5.4.3(d) in writing to the DEP Commissioner, with a copy to the ACCO of the City Agency letting this Contract. Any finding or waiver made or issued pursuant to Articles 5.4.3(d)(i) and 5.4.3(d)(ii) above shall expire after one hundred eighty (180) Days, at which time the requirements of Article 5.4.3(a) shall be in full force and effect unless the City Agency renews the finding, in writing, and the DEP Commissioner approves such finding, in writing, or the DEP Commissioner renews the waiver, in writing.

5.4.3(e) The requirements of this Article 5.4.3 do not apply where they are precluded by federal or State funding requirements or where the Contract is an emergency procurement.

5.4.4 Section 24-163 of the Administrative Code. The Contractor shall comply with Section 24-163 of the Administrative Code related to the idling of the engines of motor vehicles while parking.

#### 5.4.5 Compliance

5.4.5(a) The Contractor's compliance with Article 5.4 may be independently monitored. If it is determined that the Contractor has failed to comply with any provision of Article 5.4, any costs associated with any independent monitoring incurred by the City shall be reimbursed by the Contractor.

5.4.5(b) Any Contractor who violates any provision of Article 5.4, except as provided in Article 5.4.5(c) below, shall be liable for a civil penalty between the amounts of one thousand (\$1,000) and ten thousand (\$10,000) dollars, in addition to twice the amount of money saved by such Contractor for failure to comply with Article 5.4.

5.4.5(c) No Contractor shall make a false claim with respect to the provisions of Article 5.4 to a City Agency. Where a Contractor has been found to have done so, such Contractor shall be liable for a civil penalty of twenty thousand (\$20,000) dollars, in addition to twice the amount of money saved by such Contractor in association with having made such false claim.

#### 5.4.6 Reporting

5.4.6(a) For all Public Works Contracts covered by this Article 5.4, the Contractor shall report to the City Agency the following information:

5.4.6(a)(i) The total number of diesel-powered Nonroad Vehicles used to fulfill the requirements of this Public Works Contract;

5.4.6(a)(ii) The number of such Nonroad Vehicles that were powered by Ultra Low Sulfur Diesel Fuel;

5.4.6(a)(iii) The number of such Nonroad Vehicles that utilized the best available technology for reducing the emission of pollutants, including a breakdown by vehicle model and the type of technology;

5.4.6(a)(iv) The number of such Nonroad Vehicles that utilized such other authorized technology in accordance with Article 5.4.3, including a breakdown by vehicle model and the type of technology used for each such vehicle;

5.4.6(a)(v) The locations where such Nonroad Vehicles were used; and

5.4.6(a)(vi) Where a determination is in effect pursuant to Article 5.4.2(b) or 5.4.2(c), detailed information concerning the Contractor's efforts to obtain Ultra Low Sulfur Diesel Fuel or diesel fuel that has a sulfur content of no more than thirty parts per million (30 ppm).

5.4.6(b) The Contractor shall submit the information required by Article 5.4.6(a) at the completion of Work under the Public Works Contract and on a yearly basis no later than August 1 throughout the term of the Public Works Contract. The yearly report shall cover Work performed during the preceding fiscal year (July 1 - June 30).

5.5 Ultra Low Sulfur Diesel Fuel. In accordance with the Coordinated Construction Act for Lower Manhattan, as amended:

5.5.1 Definitions. For purposes of this Article 5.5, the following definitions apply:

5.5.1(a) "Lower Manhattan" means the area to the south of and within the following lines: a line beginning at a point where the United States pierhead line in the Hudson River as it exists now or may be extended would intersect with the southerly line of West Houston Street in the Borough of Manhattan extended, thence easterly along the southerly side of West Houston Street to the southerly side of Houston Street, thence easterly along the southerly side of Houston Street to the southerly side of East Houston Street, thence northeasterly along the southerly side of East Houston Street to the point where it would intersect with the United States pierhead line in the East River as it exists now or may be extended, including tax lots within or immediately adjacent thereto.

5.5.1(b) "Lower Manhattan Redevelopment Project" means any project in Lower Manhattan that is funded in whole or in part with federal or State funding, or any project intended to improve transportation between Lower Manhattan and the two air terminals in the City known as LaGuardia Airport and John F. Kennedy International Airport, or between Lower Manhattan and the air terminal in Newark known as Newark Liberty International Airport, and that is funded in whole or in part with federal funding.

5.5.1(c) "Nonroad Engine" means an internal combustion engine (including the fuel system) that is not used in a Motor Vehicle or a vehicle used solely for competition, or that is not subject to standards promulgated under Section 7411 or Section 7521 of Title 42 of the United States Code, except that this term shall apply to internal combustion engines used to power generators, compressors or similar equipment used in any construction program or project.

5.5.1(d) "Nonroad Vehicle" means a vehicle that is powered by a Nonroad Engine, fifty (50) horsepower (HP) and greater, and that is not a Motor Vehicle or a vehicle used solely for competition, which shall include, but not be limited to, excavators, backhoes, cranes, compressors, generators, bulldozers, and similar equipment, except that this terms shall not apply to horticultural maintenance vehicles used for landscaping purposes that are powered by a Nonroad Engine of sixty-five (65) HP or less and that are not used in any construction program or project.

5.5.1(e) "Ultra Low Sulfur Diesel Fuel" means diesel fuel that has a sulfur content of no more than fifteen parts per million (15 ppm).

5.5.2 Requirements. Contractors and Subcontractors are required to use only Ultra Low Sulfur Diesel Fuel to power the diesel-powered Nonroad Vehicles with engine HP rating of fifty (50) HP and above used on a Lower Manhattan Redevelopment Project and, where practicable, to reduce the emission of pollutants by retrofitting such Nonroad Vehicles with oxidation catalysts, particulate filters, or technology that achieves lowest particulate matter emissions.

5.6 Pesticides. In accordance with Section 17-1209 of the Administrative Code, to the extent that the Contractor or any Subcontractor applies pesticides to any property owned or leased by the City, the Contractor, and any Subcontractor shall comply with Chapter 12 of the Administrative Code.

5.7 Waste Treatment, Storage, and Disposal Facilities and Transporters. In connection with the Work, the Contractor and any Subcontractor shall use only those waste treatment, storage, and disposal facilities and waste transporters that possess the requisite license, permit or other governmental approval necessary to treat, store, dispose, or transport the waste, materials or hazardous substances.

5.8 Environmentally Preferable Purchasing. The Contractor shall ensure that products purchased or leased by the Contractor or any Subcontractor for the Work that are not specified by the City or are submitted as equivalents to a product specified by the City comply with the requirements of the New York City Environmentally Preferable Purchasing Program contained in Chapter 11 of Title 43 of the RCNY, pursuant to Chapter 3 of Title 6 of the Administrative Code.

## **ARTICLE 6. INSPECTION**

6.1 During the progress of the Work and up to the date of Final Acceptance, the Contractor shall at all times afford the representatives of the City every reasonable, safe, and proper facility for inspecting all Work done or being done at the Site and also for inspecting the manufacture or preparation of materials and equipment at the place of such manufacture or preparation.

6.2 The Contractor's obligation hereunder shall include the uncovering or taking down of finished Work and its restoration thereafter; provided, however, that the order to uncover, take down and restore shall be in writing, and further provided that if Work thus exposed proves satisfactory, and if the Contractor has complied with Article 6.1, such uncovering or taking down and restoration shall be

considered an item of Extra Work to be paid for in accordance with the provisions of Article 26. If the Work thus exposed proves unsatisfactory, the City has no obligation to compensate the Contractor for the uncovering, taking down or restoration.

6.3 Inspection and approval by the Commissioner, the Engineer, Project Manager, or Resident Engineer, of finished Work or of Work being performed, or of materials and equipment at the place of manufacture or preparation, shall not relieve the Contractor of its obligation to perform the Work in strict accordance with the Contract. Finished or unfinished Work not found to be in strict accordance with the Contract shall be replaced as directed by the Engineer, even though such Work may have been previously approved and paid for. Such corrective Work is Contract Work and shall not be deemed Extra Work.

6.4 Rejected Work and materials shall be promptly taken down and removed from the Site, which must at all times be kept in a reasonably clean and neat condition.

#### **ARTICLE 7. PROTECTION OF WORK AND OF PERSONS AND PROPERTY; NOTICES AND INDEMNIFICATION**

7.1 During the performance of the Work and up to the date of Final Acceptance, the Contractor shall be under an absolute obligation to protect the finished and unfinished Work against any damage, loss, injury, theft and/or vandalism and in the event of such damage, loss, injury, theft and/or vandalism, it shall promptly replace and/or repair such Work at the Contractor's sole cost and expense, as directed by the Resident Engineer. The obligation to deliver finished Work in strict accordance with the Contract prior to Final Acceptance shall be absolute and shall not be affected by the Resident Engineer's approval of, or failure to prohibit, the Means and Methods of Construction used by the Contractor.

7.2 During the performance of the Work and up to the date of Final Acceptance, the Contractor shall take all reasonable precautions to protect all persons and the property of the City and of others from damage, loss or injury resulting from the Contractor's, and/or its Subcontractors' operations under this Contract. The Contractor's obligation to protect shall include the duty to provide, place or replace, and adequately maintain at or about the Site suitable and sufficient protection such as lights, barricades, and enclosures.

7.3 The Contractor shall comply with the notification requirements set forth below in the event of any loss, damage or injury to Work, persons or property, or any accidents arising out of the operations of the Contractor and/or its Subcontractors under this Contract.

7.3.1 The Contractor shall make a full and complete report in writing to the Resident Engineer within three (3) Days after the occurrence.

7.3.2 The Contractor shall also send written notice of any such event to all insurance carriers that issued potentially responsive policies (including commercial general liability insurance carriers for events relating to the Contractor's own employees) no later than twenty (20) days after such event and again no later than twenty (20) days after the initiation of any claim and/or action resulting therefrom. Such notice shall contain the following information: the number of the insurance policy, the name of the Named Insured, the date and location of the incident, and the identity of the persons injured or property damaged. For any policy on which the City and/or the Engineer, Architect, or Project Manager are Additional Insureds, such notice shall expressly specify that "this notice is

being given on behalf of the City of New York as Additional Insured, such other Additional Insureds, as well as the Named Insured.”

7.3.2(a) Whenever such notice is sent under a policy on which the City is an Additional Insured, the Contractor shall provide copies of the notice to the Comptroller, the Commissioner and the City Corporation Counsel. The copy to the Comptroller shall be sent to the Insurance Unit, NYC Comptroller’s Office, 1 Centre Street – Room 1222, New York, New York, 10007. The copy to the Commissioner shall be sent to the address set forth in Schedule A of the General Conditions. The copy to the City Corporation Counsel shall be sent to Insurance Claims Specialist, Affirmative Litigation Division, New York City Law Department, 100 Church Street, New York, New York 10007.

7.3.2(b) If the Contractor fails to provide any of the foregoing notices to any appropriate insurance carrier(s) in a timely and complete manner, the Contractor shall indemnify the City for all losses, judgments, settlements, and expenses, including reasonable attorneys’ fees, arising from an insurer’s disclaimer of coverage citing late notice by or on behalf of the City.

7.4 To the fullest extent permitted by law, the Contractor shall defend, indemnify, and hold the City, its employees, and officials (the “Indemnitees”) harmless against any and all claims (including but not limited to claims asserted by any employee of the Contractor and/or its Subcontractors) and costs and expenses of whatever kind (including but not limited to payment or reimbursement of attorneys’ fees and disbursements) allegedly arising out of or in any way related to the operations of the Contractor and/or its Subcontractors in the performance of this Contract or from the Contractor’s and/or its Subcontractors’ failure to comply with any of the provisions of this Contract or of the Law. Such costs and expenses shall include all those incurred in defending the underlying claim and those incurred in connection with the enforcement of this Article 7.4 by way of cross-claim, third-party claim, declaratory action or otherwise. The parties expressly agree that the indemnification obligation hereunder contemplates (1) full indemnity in the event of liability imposed against the Indemnitees without negligence and solely by reason of statute, operation of Law or otherwise; and (2) partial indemnity in the event of any actual negligence on the part of the Indemnitees either causing or contributing to the underlying claim (in which case, indemnification will be limited to any liability imposed over and above that percentage attributable to actual fault whether by statute, by operation of Law, or otherwise). Where partial indemnity is provided hereunder, all costs and expenses shall be indemnified on a pro rata basis.

7.4.1 Indemnification under Article 7.4 or any other provision of the Contract shall operate whether or not Contractor or its Subcontractors have placed and maintained the insurance specified under Article 22.

7.5 The provisions of this Article 7 shall not be deemed to create any new right of action in favor of third parties against the Contractor or the City.

### **CHAPTER III: TIME PROVISIONS**

#### **ARTICLE 8. COMMENCEMENT AND PROSECUTION OF THE WORK**

8.1 The Contractor shall commence the Work on the date specified in the Notice to Proceed or the Order to Work. The time for performance of the Work under the Contract shall be computed from

the date specified in the Notice to Proceed or the Order to Work. TIME BEING OF THE ESSENCE to the City, the Contractor shall thereafter prosecute the Work diligently, using such Means and Methods of Construction as are in accord with Article 4 herein and as will assure its completion not later than the date specified in this Contract, or on the date to which the time for completion may be extended.

#### **ARTICLE 9. PROGRESS SCHEDULES**

9.1 To enable the Work to be performed in an orderly and expeditious manner, the Contractor, within fifteen (15) Days after the Notice to Proceed or Order to Work, unless otherwise directed by the Engineer, shall submit to the Engineer a proposed progress schedule based on the Critical Path Method in the form of a bar graph or in such other form as specified by the Engineer, and monthly cash flow requirements, showing:

9.1.1 The anticipated time of commencement and completion of each of the various operations to be performed under this Contract; and

9.1.2 The sequence and interrelation of each of these operations with the others and with those of other related contracts; and

9.1.3 The estimated time required for fabrication or delivery, or both, of all materials and equipment required for the Work, including the anticipated time for obtaining required approvals pursuant to Article 10; and

9.1.4 The estimated amount in dollars the Contractor will claim on a monthly basis.

9.2 The proposed schedule shall be revised as directed by the Engineer, until finally approved by the Engineer, and after such approval, subject to the provisions of Article 11, shall be strictly adhered to by the Contractor.

9.3 If the Contractor shall fail to adhere to the approved progress schedule, or to the schedule as revised pursuant to Article 11, it shall promptly adopt such other or additional Means and Methods of Construction, at its sole cost and expense, as will make up for the time lost and will assure completion in accordance with the approved progress schedule. The approval by the City of a progress schedule which is shorter than the time allotted under the Contract shall not create any liability for the City if the approved progress schedule is not met.

9.4 The Contractor will not receive any payments until the proposed progress schedule is submitted.

#### **ARTICLE 10. REQUESTS FOR INFORMATION OR APPROVAL**

10.1 From time to time as the Work progresses and in the sequence indicated by the approved progress schedule, the Contractor shall submit to the Engineer a specific request in writing for each item of information or approval required by the Contractor. These requests shall state the latest date upon which the information or approval is actually required by the Contractor, and shall be submitted in a reasonable time in advance thereof to provide the Engineer a sufficient time to act upon such submissions, or any necessary re-submissions thereof.

10.2 The Contractor shall not have any right to an extension of time on account of delays due to the Contractor's failure to submit requests for the required information or the required approval in accordance with the above requirements.

**ARTICLE 11. NOTICE OF CONDITIONS CAUSING DELAY AND DOCUMENTATION OF DAMAGES CAUSED BY DELAY**

11.1 After the commencement of any condition which is causing or may cause a delay in completion of the Work, including conditions for which the Contractor may be entitled to an extension of time, the following notifications and submittals are required:

11.1.1 Within fifteen (15) Days after the Contractor becomes aware or reasonably should be aware of each such condition, the Contractor must notify the Resident Engineer or Engineer, as directed by the Commissioner, in writing of the existence, nature and effect of such condition upon the approved progress schedule and the Work, and must state why and in what respects, if any, the condition is causing or may cause a delay. Such notice shall include a description of the construction activities that are or could be affected by the condition and may include any recommendations the Contractor may have to address the delay condition and any activities the Contractor may take to avoid or minimize the delay.

11.1.2 If the Contractor shall claim to be sustaining damages for delay as provided for in this Article 11, within forty-five (45) Days from the time such damages are first incurred for each such condition, the Contractor shall submit to the Commissioner a verified written statement of the details and estimates of the amounts of such damages, including categories of expected damages and projected monthly costs, together with documentary evidence of such damages as the Contractor may have at the time of submission ("statement of delay damages"), as further detailed in Article 11.6. The Contractor may submit the above statement within such additional time as may be granted by the Commissioner in writing upon written request therefor.

11.1.3 Articles 11.1.1 and 11.1.2 do not relieve the Contractor of its obligation to comply with the provisions of Article 44.

11.2 Failure of the Contractor to strictly comply with the requirements of Article 11.1.1 may, in the discretion of the Commissioner, be deemed sufficient cause to deny any extension of time on account of delay arising out of such condition. Failure of the Contractor to strictly comply with the requirements of both Articles 11.1.1 and 11.1.2 shall be deemed a conclusive waiver by the Contractor of any and all claims for damages for delay arising from such condition and no right to recover on such claims shall exist.

11.3 When appropriate and directed by the Engineer, the progress schedule shall be revised by the Contractor until finally approved by the Engineer. The revised progress schedule must be strictly adhered to by the Contractor.

11.4 Compensable Delays

11.4.1 The Contractor agrees to make claim only for additional costs attributable to delay in the performance of this Contract necessarily extending the time for completion of the Work or resulting from acceleration directed by the Commissioner and required to maintain the progress schedule, occasioned solely by any act or omission to act of the City listed below. The Contractor also agrees that delay from any other cause shall be



compensated, if at all, solely by an extension of time to complete the performance of the Work.

- 11.4.1.1 The failure of the City to take reasonable measures to coordinate and progress the Work to the extent required by the Contract, except that the City shall not be responsible for the Contractor's obligation to coordinate and progress the Work of its Subcontractors.
- 11.4.1.2 Unreasonable delays attributable to the review of shop drawings, the issuance of change orders, or the cumulative impact of change orders that were not brought about by any act or omission of the Contractor.
- 11.4.1.3 The unavailability of the Site caused by acts or omissions of the City.
- 11.4.1.4 The issuance by the Engineer of a stop work order that was not brought about through any act or omission of the Contractor.
- 11.4.1.5 Differing site conditions or environmental hazards that were neither known nor reasonably ascertainable on a pre-bid inspection of the Site or review of the bid documents or other publicly available sources, and that are not ordinarily encountered in the Project's geographical area or neighborhood or in the type of Work to be performed.
- 11.4.1.6 Delays caused by the City's bad faith or its willful, malicious, or grossly negligent conduct;
- 11.4.1.7 Delays not contemplated by the parties;
- 11.4.1.8 Delays so unreasonable that they constitute an intentional abandonment of the Contract by the City; and
- 11.4.1.9 Delays resulting from the City's breach of a fundamental obligation of the Contract.

11.4.2 No claim may be made for any alleged delay in Substantial Completion of the Work if the Work will be or is substantially completed by the date of Substantial Completion provided for in Schedule A unless acceleration has been directed by the Commissioner to meet the date of Substantial Completion set forth in Schedule A, or unless there is a provision in the Contract providing for additional compensation for early completion.

11.4.3 The provisions of this Article 11 apply only to claims for additional costs attributable to delay and do not preclude determinations by the Commissioner allowing reimbursements for additional costs for Extra Work pursuant to Articles 25 and 26 of this Contract. To the extent that any cost attributable to delay is reimbursed as part of a change order, no additional claim for compensation under this Article 11 shall be allowed.

11.5 Non-Compensable Delays. The Contractor agrees to make no claim for, and is deemed to have included in its bid prices for the various items of the Contract, the extra/additional costs attributable to any delays caused by or attributable to the items set forth below. For such items, the Contractor shall be compensated, if at all, solely by an extension of time to complete the performance of the Work, in accordance with the provisions of Article 13. Such extensions of time will be granted, if at all, pursuant to the grounds set forth in Article 13.3.

11.5.1 The acts or omissions of any third parties, including but not limited to Other Contractors, public/ governmental bodies (other than City Agencies), utilities or private enterprises, who are disclosed in the Contract Documents or are ordinarily encountered or generally recognized as related to the Work;

11.5.2 Any situation which was within the contemplation of the parties at the time of entering into the Contract, including any delay indicated or disclosed in the Contract Documents or that would be generally recognized by a reasonably prudent contractor as related to the nature of the Work, and/or the existence of any facility or appurtenance owned, operated or maintained by any third party, as indicated or disclosed in the Contract Documents or ordinarily encountered or generally recognized as related to the nature of the Work;

11.5.3 Restraining orders, injunctions or judgments issued by a court which were caused by a Contractor's submission, action or inaction or by a Contractor's Means and Methods of Construction, or by third parties, unless such order, injunction or judgment was the result of an act or omission by the City;

11.5.4 Any labor boycott, strike, picketing, lockout or similar situation;

11.5.5 Any shortages of supplies or materials, or unavailability of equipment, required by the Contract Work;

11.5.6 Climatic conditions, storms, floods, droughts, tidal waves, fires, hurricanes, earthquakes, landslides or other catastrophes or acts of God, or acts of war or of the public enemy or terrorist acts, including the City's reasonable responses thereto; and

11.5.7 Extra Work which does not significantly affect the overall completion of the Contract, reasonable delays in the review or issuance of change orders or field orders and/or in shop drawing reviews or approvals.

#### 11.6 Required Content of Submission of Statement of Delay Damages

11.6.1 In the verified written statement of delay damages required by Article 11.1.2, the following information shall be provided by the Contractor:

11.6.1.1 For each delay, the start and end dates of the claimed periods of delay and, in addition, a description of the operations that were delayed, an explanation of how they were delayed, and the reasons for the delay, including identifying the applicable act or omission of the City listed in Article 11.4.

11.6.1.2 A detailed factual statement of the claim providing all necessary dates, locations and items of Work affected by the claim.

11.6.1.3 The estimated amount of additional compensation sought and a breakdown of that amount into categories as described in Article 11.7.

11.6.1.4 Any additional information requested by the Commissioner.

#### 11.7 Recoverable Costs

11.7.1 Delay damages may be recoverable for the following costs actually and necessarily incurred in the performance of the Work:

11.7.1.1 Direct labor, including payroll taxes (subject to statutory wage caps) and supplemental benefits, based on time and materials records;

11.7.1.2 Necessary materials (including transportation to the Site), based on time and material records;

- 11.7.1.3 Reasonable rental value of necessary plant and equipment other than small tools, plus fuel/energy costs according to the applicable formula set forth in Articles 26.2.4 and/or 26.2.8, based on time and material records;
- 11.7.1.4 Additional insurance and bond costs;
- 11.7.1.5 Extended Site overhead, field office rental, salaries of field office staff, on-site project managers and superintendents, field office staff vehicles, Project-specific storage, field office utilities and telephone, and field office consumables;
- 11.7.1.6 Labor escalation costs based on actual costs;
- 11.7.1.7 Materials and equipment escalation costs based on applicable industry indices unless documentation of actual increased cost is provided;
- 11.7.1.8 Additional material and equipment storage costs based on actual documented costs and additional costs necessitated by extended manufacturer warranty periods; and
- 11.7.1.9 Extended home office overhead calculated based on the following formula:
  - (1) Subtract from the original Contract amount the amount earned by original contractual Substantial Completion date (not including change orders);
  - (2) Remove 15% overhead and profit from the calculation in item (1) by dividing the results of item (1) by 1.15;
  - (3) Multiply the result of item (2) by 7.25% for the total home office overhead;
  - (4) Multiply the result of item (3) by 7.25% for the total profit; and
  - (5) The total extended home office overhead will be the total of items (3) and (4).

11.7.2 Recoverable Subcontractor Costs. When the Work is performed by a Subcontractor, the Contractor may be paid the actual and necessary costs of such subcontracted Work as outlined above in Articles 11.7.1.1 through 11.7.1.8, and an additional overhead of 5% of the costs outlined in Articles 11.7.1.1 through 11.7.1.3.

11.7.3 Non-Recoverable Costs. The parties agree that the City will have no liability for the following items and the Contractor agrees it shall make no claim for the following items:

- 11.7.3.1 Profit, or loss of anticipated or unanticipated profit, except as provided in Article 11.7.1.9;
- 11.7.3.2 Consequential damages, including, but not limited to, construction or bridge loans or interest paid on such loans, loss of bonding capacity, bidding opportunities, or interest in investment, or any resulting insolvency;
- 11.7.3.3 Indirect costs or expenses of any nature except those included in Article 11.7.1;
- 11.7.3.4 Direct or indirect costs attributable to performance of Work where the Contractor, because of situations or conditions within its control, has not progressed the Work in a satisfactory manner; and
- 11.7.3.5 Attorneys' fees and dispute and claims preparation expenses.

- 11.8 Any claims for delay under this Article 11 are not subject to the jurisdiction of the Contract Dispute Resolution Board pursuant to the dispute resolution process set forth in Article 27.
- 11.9 Any compensation provided to the Contractor in accordance with this Article 11 will be made pursuant to a claim filed with the Comptroller. Nothing in this Article 11 extends the time for the Contractor to file an action with respect to a claim within six months after Substantial Completion pursuant to Article 56.

#### **ARTICLE 12. COORDINATION WITH OTHER CONTRACTORS**

12.1 During the progress of the Work, Other Contractors may be engaged in performing other work or may be awarded other contracts for additional work on this Project. In that event, the Contractor shall coordinate the Work to be done hereunder with the work of such Other Contractors and the Contractor shall fully cooperate with such Other Contractors and carefully fit its own Work to that provided under other contracts as may be directed by the Engineer. The Contractor shall not commit or permit any act which will interfere with the performance of work by any Other Contractors.

12.2 If the Engineer determines that the Contractor is failing to coordinate its Work with the work of Other Contractors as the Engineer has directed, then the Commissioner shall have the right to withhold any payments otherwise due hereunder until the Contractor completely complies with the Engineer's directions.

12.3 The Contractor shall notify the Engineer in writing if any Other Contractor on this Project is failing to coordinate its work with the Work of this Contract. If the Engineer finds such charges to be true, the Engineer shall promptly issue such directions to the Other Contractor with respect thereto as the situation may require. The City shall not, however, be liable for any damages suffered by any Other Contractor's failure to coordinate its work with the Work of this Contract or by reason of the Other Contractor's failure to promptly comply with the directions so issued by the Engineer, or by reason of any Other Contractor's default in performance, it being understood that the City does not guarantee the responsibility or continued efficiency of any contractor. The Contractor agrees to make no claim against the City for any damages relating to or arising out of any directions issued by the Engineer pursuant to this Article 12 (including but not limited to the failure of any Other Contractor to comply or promptly comply with such directions), or the failure of any Other Contractor to coordinate its work, or the default in performance of any Other Contractor.

12.4 The Contractor shall indemnify and hold the City harmless from any and all claims or judgments for damages and from costs and expenses to which the City may be subjected or which it may suffer or incur by reason of the Contractor's failure to comply with the Engineer's directions promptly; and the Comptroller shall have the right to exercise the powers reserved in Article 23 with respect to any claims which may be made for damages due to the Contractor's failure to comply with the Engineer's directions promptly. Insofar as the facts and Law relating to any claim would preclude the City from being completely indemnified by the Contractor, the City shall be partially indemnified by the Contractor to the fullest extent provided by Law.

12.5 Should the Contractor sustain any damage through any act or omission of any Other Contractor having a contract with the City for the performance of work upon the Site or of work which may be necessary to be performed for the proper prosecution of the Work to be performed hereunder, or through any act or omission of a subcontractor of such Other Contractor, the Contractor shall have no claim against the City for such damage, but shall have a right to recover such damage from the Other

**Contractor** under the provision similar to the following provisions which apply to this **Contract** and have been or will be inserted in the contracts with such **Other Contractors**:

12.5.1 Should any **Other Contractor** having or who shall hereafter have a contract with the **City** for the performance of work upon the **Site** sustain any damage through any act or omission of the **Contractor** hereunder or through any act or omission of any **Subcontractor** of the **Contractor**, the **Contractor** agrees to reimburse such **Other Contractor** for all such damages and to defend at its own expense any action based upon such claim and if any judgment or claim (even if the allegations of the action are without merit) against the **City** shall be allowed the **Contractor** shall pay or satisfy such judgment or claim and pay all costs and expenses in connection therewith and agrees to indemnify and hold the **City** harmless from all such claims. Insofar as the facts and **Law** relating to any claim would preclude the **City** from being completely indemnified by the **Contractor**, the **City** shall be partially indemnified by the **Contractor** to the fullest extent provided by **Law**.

12.6 The **City's** right to indemnification hereunder shall in no way be diminished, waived or discharged by its recourse to assessment of liquidated damages as provided in Article 15, or by the exercise of any other remedy provided for by **Contract** or by **Law**.

#### **ARTICLE 13. EXTENSION OF TIME FOR PERFORMANCE**

13.1 If performance by the **Contractor** is delayed for a reason set forth in Article 13.3, the **Contractor** may be allowed a reasonable extension of time in conformance with this Article 13 and the **PPB Rules**.

13.2 Any extension of time may be granted only by the **ACCO** or by the Board for the Extension of Time (hereafter "**Board**") (as set forth below) upon written application by the **Contractor**.

13.3 Grounds for Extension: If such application is made, the **Contractor** shall be entitled to an extension of time for delay in completion of the **Work** caused solely:

13.3.1 By the acts or omissions of the **City**, its officials, agents or employees; or

13.3.2 By the act or omissions of **Other Contractors** on this **Project**; or

13.3.3 By supervening conditions entirely beyond the control of either party hereto (such as, but not limited to, acts of God or the public enemy, excessive inclement weather, war or other national emergency making performance temporarily impossible or illegal, or strikes or labor disputes not brought about by any act or omission of the **Contractor**).

13.3.4 The **Contractor** shall, however, be entitled to an extension of time for such causes only for the number of **Days** of delay which the **ACCO** or the **Board** may determine to be due solely to such causes, and then only if the **Contractor** shall have strictly complied with all of the requirements of Articles 9 and 10.

13.4 The **Contractor** shall not be entitled to receive a separate extension of time for each of several causes of delay operating concurrently, but, if at all, only for the actual period of delay in completion of the **Work** as determined by the **ACCO** or the **Board**, irrespective of the number of causes contributing to produce such delay. If one of several causes of delay operating concurrently results from any act, fault or omission of the **Contractor** or of its **Subcontractors** or **Materialmen**, and would of itself (irrespective

of the concurrent causes) have delayed the Work, no extension of time will be allowed for the period of delay resulting from such act, fault or omission.

13.5 The determination made by the ACCO or the Board on an application for an extension of time shall be binding and conclusive on the Contractor.

13.6 The ACCO or the Board acting entirely within their discretion may grant an application for an extension of time for causes of delay other than those herein referred.

13.7 Permitting the Contractor to continue with the Work after the time fixed for its completion has expired, or after the time to which such completion may have been extended has expired, or the making of any payment to the Contractor after such time, shall in no way operate as a waiver on the part of the City of any of its rights under this Contract.

**13.8 Application for Extension of Time:**

13.8.1 Before the Contractor's time extension request will be considered, the Contractor shall notify the ACCO of the condition which allegedly has caused or is causing the delay, and shall submit a written application to the ACCO identifying:

13.8.1(a) The Contractor; the registration number; and Project description;

13.8.1(b) Liquidated damage assessment rate, as specified in the Contract;

13.8.1(c) Original total bid price;

13.8.1(d) The original Contract start date and completion date;

13.8.1(e) Any previous time extensions granted (number and duration); and

13.8.1(f) The extension of time requested.

13.8.2 In addition, the application for extension of time shall set forth in detail:

13.8.2(a) The nature of each alleged cause of delay in completing the Work;

13.8.2(b) The date upon which each such cause of delay began and ended and the number of Days attributable to each such cause;

13.8.2(c) A statement that the Contractor waives all claims except for those delineated in the application, and the particulars of any claims which the Contractor does not agree to waive. For time extensions for Substantial Completion and final completion payments, the application shall include a detailed statement of the dollar amounts of each element of claim item reserved; and

13.8.2(d) A statement indicating the Contractor's understanding that the time extension is granted only for purposes of permitting continuation of Contract performance and payment for Work performed and that the City retains its right to conduct an investigation and assess liquidated damages as appropriate in the future.

**13.9 Analysis and Approval of Time Extensions:**

13.9.1 For time extensions for partial payments, a written determination shall be made by the ACCO who may, for good and sufficient cause, extend the time for the performance of the Contract as follows:

13.9.1(a) If the Work is to be completed within six (6) months, the time for performance may be extended for sixty (60) Days;

13.9.1(b) If the Work is to be completed within less than one (1) year but more than six (6) months, an extension of ninety (90) Days may be granted;

13.9.1(c) If the Contract period exceeds one (1) year, besides the extension granted in Article 13.9.1(b), an additional thirty (30) Days may be granted for each multiple of six (6) months involved beyond the one (1) year period; or

13.9.1(d) If exceptional circumstances exist, the ACCO may extend the time for performance beyond the extensions in Articles 13.9.1(a), 13.9.1(b), and 13.9.1(c). In that event, the ACCO shall file with the Mayor's Office of Contract Services a written explanation of the exceptional circumstances.

13.9.2 For extensions of time for Substantial Completion and final completion payments, the Engineer, in consultation with the ACCO, shall prepare a written analysis of the delay (including a preliminary determination of the causes of delay, the beginning and end dates for each such cause of delay, and whether the delays are excusable under the terms of this Contract). The report shall be subject to review by and approval of the Board, which shall have authority to question its analysis and determinations and request additional facts or documentation. The report as reviewed and made final by the Board shall be made a part of the Agency contract file. Neither the report itself nor anything contained therein shall operate as a waiver or release of any claim the City may have against the Contractor for either actual or liquidated damages.

13.9.3 Approval Mechanism for Time Extensions for Substantial Completion or Final Completion Payments: An extension shall be granted only with the approval of the Board which is comprised of the ACCO of the Agency, the City Corporation Counsel, and the Comptroller, or their authorized representatives.

13.9.4 Neither the granting of any application for an extension of time to the Contractor or any Other Contractor on this Project nor the papers, records or reports related to any application for or grant of an extension of time or determination related thereto shall be referred to or offered in evidence by the Contractor or its attorneys in any action or proceeding.

13.10 No Damage for Delay: The Contractor agrees to make no claim for damages for delay in the performance of this Contract occasioned by any act or omission to act of the City or any of its representatives, except as provided for in Article 11.

#### **ARTICLE 14. COMPLETION AND FINAL ACCEPTANCE OF THE WORK**

14.1 Date for Substantial Completion: The Contractor shall substantially complete the Work within the time fixed in Schedule A of the General Conditions, or within the time to which such Substantial Completion may be extended.

14.2 **Determining the Date of Substantial Completion:** The Work will be deemed to be substantially complete when the two conditions set forth below have been met.

14.2.1 **Inspection:** The **Engineer or Resident Engineer**, as applicable, has inspected the Work and has made a written determination that it is substantially complete.

14.2.2 **Approval of Final Approved Punch List and Date for Final Acceptance:** Following inspection of the Work, the **Engineer/Resident Engineer** shall furnish the Contractor with a final punch list, specifying all items of Work to be completed and proposing dates for the completion of each specified item of Work. The Contractor shall then submit in writing to the **Engineer/Resident Engineer** within ten (10) Days of the **Engineer/Resident Engineer** furnishing the final punch list either acceptance of the dates or proposed alternative dates for the completion of each specified item of Work. If the Contractor neither accepts the dates nor proposes alternative dates within ten (10) Days, the schedule proposed by the **Engineer/Resident Engineer** shall be deemed accepted. If the Contractor proposes alternative dates, then, within a reasonable time after receipt, the **Engineer/Resident Engineer**, in a written notification to the Contractor, shall approve the Contractor's completion dates or, if they are unable to agree, the **Engineer/Resident Engineer** shall establish dates for the completion of each item of Work. The latest completion date specified shall be the date for **Final Acceptance** of the Work.

14.3 **Date of Substantial Completion.** The date of approval of the **Final Approved Punch List**, shall be the date of **Substantial Completion**. The date of approval of the **Final Approved Punch List** shall be either (a) if the Contractor approves the final punch list and proposed dates for completion furnished by the **Engineer/Resident Engineer**, the date of the Contractor's approval; or (b) if the Contractor neither accepts the dates nor proposes alternative dates, ten (10) Days after the **Engineer/Resident Engineer** furnishes the Contractor with a final punch list and proposed dates for completion; or (c) if the Contractor proposes alternative dates, the date that the **Engineer/Resident Engineer** sends written notification to the Contractor either approving the Contractor's proposed alternative dates or establishing dates for the completion for each item of Work.

14.4 **Determining the Date of Final Acceptance:** The Work will be accepted as final and complete as of the date of the **Engineer's/Resident Engineer's** inspection if, upon such inspection, the **Engineer/Resident Engineer** finds that all items on the **Final Approved Punch List** are complete and no further Work remains to be done. The Commissioner will then issue a written determination of **Final Acceptance**.

14.5 **Request for Inspection:** Inspection of the Work by the **Engineer/Resident Engineer** for the purpose of **Substantial Completion** or **Final Acceptance** shall be made within fourteen (14) Days after receipt of the Contractor's written request therefor.

14.6 **Request for Re-inspection:** If upon inspection for the purpose of **Substantial Completion** or **Final Acceptance**, the **Engineer/Resident Engineer** determines that there are items of Work still to be performed, the Contractor shall promptly perform them and then request a re-inspection. If upon re-inspection, the **Engineer/Resident Engineer** determines that the Work is substantially complete or finally accepted, the date of such re-inspection shall be the date of **Substantial Completion** or **Final Acceptance**. Re-inspection by the **Engineer/Resident Engineer** shall be made within ten (10) Days after receipt of the Contractor's written request therefor.



14.7 **Initiation of Inspection by the Engineer/Resident Engineer:** If the Contractor does not request inspection or re-inspection of the Work for the purpose of Substantial Completion or Final Acceptance, the Engineer/Resident Engineer may initiate such inspection or re-inspection.

#### **ARTICLE 15. LIQUIDATED DAMAGES**

15.1 In the event the Contractor fails to substantially complete the Work within the time fixed for such Substantial Completion in Schedule A of the General Conditions, plus authorized time extensions, or if the Contractor, in the sole determination of the Commissioner, has abandoned the Work, the Contractor shall pay to the City the sum fixed in Schedule A of the General Conditions, for each and every Day that the time consumed in substantially completing the Work exceeds the time allowed therefor; which said sum, in view of the difficulty of accurately ascertaining the loss which the City will suffer by reason of delay in the Substantial Completion of the Work hereunder, is hereby fixed and agreed as the liquidated damages that the City will suffer by reason of such delay, and not as a penalty. This Article 15 shall also apply to the Contractor whether or not the Contractor is defaulted pursuant to Chapter X of this Contract. Neither the failure to assess liquidated damages nor the granting of any time extension shall operate as a waiver or release of any claim the City may have against the Contractor for either actual or liquidated damages.

15.2 Liquidated damages received hereunder are not intended to be nor shall they be treated as either a partial or full waiver or discharge of the City's right to indemnification, or the Contractor's obligation to indemnify the City, or to any other remedy provided for in this Contract or by Law.

15.3 The Commissioner may deduct and retain out of the monies which may become due hereunder, the amount of any such liquidated damages; and in case the amount which may become due hereunder shall be less than the amount of liquidated damages suffered by the City, the Contractor shall be liable to pay the difference.

#### **ARTICLE 16. OCCUPATION OR USE PRIOR TO COMPLETION**

16.1 Unless otherwise provided for in the Specifications, the Commissioner may take over, use, occupy or operate any part of the Work at any time prior to Final Acceptance, upon written notification to the Contractor. The Engineer or Resident Engineer, as applicable, shall inspect the part of the Work to be taken over, used, occupied, or operated, and will furnish the Contractor with a written statement of the Work, if any, which remains to be performed on such part. The Contractor shall not object to, nor interfere with, the Commissioner's decision to exercise the rights granted by Article 16. In the event the Commissioner takes over, uses, occupies, or operates any part of the Work:

16.1.1 the Engineer/Resident Engineer shall issue a written determination of Substantial Completion with respect to such part of the Work;

16.1.2 the Contractor shall be relieved of its absolute obligation to protect such part of the unfinished Work in accordance with Article 7;

16.1.3 the Contractor's guarantee on such part of the Work shall begin on the date of such use by the City; and;

16.1.4 the Contractor shall be entitled to a return of so much of the amount retained in accordance with Article 21 as it relates to such part of the Work, except so much thereof as may be retained under Articles 24 and 44.

## CHAPTER IV: SUBCONTRACTS AND ASSIGNMENTS

### ARTICLE 17. SUBCONTRACTS

17.1 The Contractor shall not make subcontracts totaling an amount more than the percentage of the total Contract price fixed in Schedule A of the General Conditions, without prior written permission from the Commissioner. All subcontracts made by the Contractor shall be in writing. No Work may be performed by a Subcontractor prior to the Contractor entering into a written subcontract with the Subcontractor and complying with the provisions of this Article 17.

17.2 Before making any subcontracts, the Contractor shall submit a written statement to the Commissioner giving the name and address of the proposed Subcontractor; the portion of the Work and materials which it is to perform and furnish; the cost of the subcontract; the VENDEX questionnaire if required; the proposed subcontract if requested by the Commissioner; and any other information tending to prove that the proposed Subcontractor has the necessary facilities, skill, integrity, past experience, and financial resources to perform the Work in accordance with the terms and conditions of this Contract.

17.3 In addition to the requirements in Article 17.2, Contractor is required to list the Subcontractor in the web based Subcontractor Reporting System through the City's Payee Information Portal (PIP), available at [www.nyc.gov/pip](http://www.nyc.gov/pip).<sup>1</sup> For each Subcontractor listed, Contractor is required to provide the following information: maximum contract value, description of Subcontractor's Work, start and end date of the subcontract and identification of the Subcontractor's industry. Thereafter, Contractor will be required to report in the system the payments made to each Subcontractor within 30 days of making the payment. If any of the required information changes throughout the Term of the Contract, Contractor will be required to revise the information in the system.

Failure of the Contractor to list a Subcontractor and/or to report Subcontractor payments in a timely fashion may result in the Commissioner declaring the Contractor in default of the Contract and will subject Contractor to liquidated damages in the amount of \$100 per day for each day that the Contractor fails to identify a Subcontractor along with the required information about the Subcontractor and/or fails to report payments to a Subcontractor, beyond the time frames set forth herein or in the notice from the City. Article 15 shall govern the issue of liquidated damages.

17.4 If an approved Subcontractor elects to subcontract any portion of its subcontract, the proposed sub-subcontract shall be submitted in the same manner as directed above.

17.5 The Commissioner will notify the Contractor in writing whether the proposed Subcontractor is approved. If the proposed Subcontractor is not approved, the Contractor may submit another proposed Subcontractor unless the Contractor decides to do the Work. No Subcontractor shall be permitted to enter or perform any work on the Site unless approved.

17.6 Before entering into any subcontract hereunder, the Contractor shall provide the proposed Subcontractor with a complete copy of this document and inform the proposed Subcontractor fully and completely of all provisions and requirements of this Contract relating either directly or indirectly to the Work to be performed and the materials to be furnished under such subcontract, and every such

<sup>1</sup> In order to use the new system, a PIP account will be required. Detailed instructions on creating a PIP account and using the new system are also available at [www.nyc.gov/pip](http://www.nyc.gov/pip). Additional assistance with PIP may be obtained by emailing the Financial Information Services Agency Help Desk at [pip@fisa.nyc.gov](mailto:pip@fisa.nyc.gov).

Subcontractor shall expressly stipulate that all labor performed and materials furnished by the Subcontractor shall strictly comply with the requirements of this Contract.

17.7 Documents given to a prospective Subcontractor for the purpose of soliciting the Subcontractor's bid shall include either a copy of the bid cover or a separate information sheet setting forth the Project name, the Contract number (if available), the Agency (as noted in Article 2.1.6), and the Project's location.

17.8 The Commissioner's approval of a Subcontractor shall not relieve the Contractor of any of its responsibilities, duties, and liabilities hereunder. The Contractor shall be solely responsible to the City for the acts or defaults of its Subcontractor and of such Subcontractor's officers, agents, and employees, each of whom shall, for this purpose, be deemed to be the agent or employee of the Contractor to the extent of its subcontract.

17.9 If the Subcontractor fails to maintain the necessary facilities, skill, integrity, past experience, and financial resources (other than due to the Contractor's failure to make payments where required) to perform the Work in accordance with the terms and conditions of this Contract, the Contractor shall promptly notify the Commissioner and replace such Subcontractor with a newly approved Subcontractor in accordance with this Article 17.

17.10 The Contractor shall be responsible for ensuring that all Subcontractors performing Work at the Site maintain all insurance required by Law.

17.11 The Contractor shall promptly, upon request, file with the Engineer a conformed copy of the subcontract and its cost. The subcontract shall provide the following:

17.11.1 Payment to Subcontractors: The agreement between the Contractor and its Subcontractor shall contain the same terms and conditions as to method of payment for Work, labor, and materials, and as to retained percentages, as are contained in this Contract.

17.11.2 Prevailing Rate of Wages: The agreement between the Contractor and its Subcontractor shall include the prevailing wage rates and supplemental benefits to be paid in accordance with Labor Law Section 220.

17.11.3 Section 6-123 of the Administrative Code: Pursuant to the requirements of Section 6-123 of the Administrative Code, every agreement between the Contractor and a Subcontractor in excess of fifty thousand (\$50,000) dollars shall include a provision that the Subcontractor shall not engage in any unlawful discriminatory practice as defined in Title VIII of the Administrative Code (Section 8-101 *et seq.*).

17.11.4 All requirements required pursuant to federal and/or state grant agreement(s), if applicable to the Work.

17.12 The Commissioner may deduct from the amounts certified under this Contract to be due to the Contractor, the sum or sums due and owing from the Contractor to the Subcontractors according to the terms of the said subcontracts, and in case of dispute between the Contractor and its Subcontractor, or Subcontractors, as to the amount due and owing, the Commissioner may deduct and withhold from the amounts certified under this Contract to be due to the Contractor such sum or sums as may be claimed by such Subcontractor, or Subcontractors, in a sworn affidavit, to be due and owing until such time as such claim or claims shall have been finally resolved.

17.13 On contracts where performance bonds and payment bonds are executed, the Contractor shall include on each requisition for payment the following data: Subcontractor's name, value of the subcontract, total amount previously paid to Subcontractor for Work previously requisitioned, and the amount, including retainage, to be paid to the Subcontractor for Work included in the requisition.

17.14 On Contracts where performance bonds and payment bonds are not executed, the Contractor shall include with each requisition for payment submitted hereunder, a signed statement from each and every Subcontractor and/or Materialman for whom payment is requested in such requisition. Such signed statement shall be on the letterhead of the Subcontractor and/or Materialman for whom payment is requested and shall (i) verify that such Subcontractor and/or Materialman has been paid in full for all Work performed and/or material supplied to date, exclusive of any amount retained and any amount included on the current requisition, and (ii) state the total amount of retainage to date, exclusive of any amount retained on the current requisition.

#### **ARTICLE 18. ASSIGNMENTS**

18.1 The Contractor shall not assign, transfer, convey or otherwise dispose of this Contract, or the right to execute it, or the right, title or interest in or to it or any part thereof, or assign, by power of attorney or otherwise any of the monies due or to become due under this Contract, unless the previous written consent of the Commissioner shall first be obtained thereto, and the giving of any such consent to a particular assignment shall not dispense with the necessity of such consent to any further or other assignments.

18.2 Such assignment, transfer, conveyance or other disposition of this Contract shall not be valid until filed in the office of the Commissioner and the Comptroller, with the written consent of the Commissioner endorsed thereon or attached thereto.

18.3 Failure to obtain the previous written consent of the Commissioner to such an assignment, transfer, conveyance or other disposition, may result in the revocation and annulment of this Contract. The City shall thereupon be relieved and discharged from any further liability to the Contractor, its assignees, transferees or sublessees, who shall forfeit and lose all monies therefor earned under the Contract, except so much as may be required to pay the Contractor's employees.

18.4 The provisions of this clause shall not hinder, prevent, or affect an assignment by the Contractor for the benefit of its creditors made pursuant to the Laws of the State of New York.

18.5 This Contract may be assigned by the City to any corporation, agency or instrumentality having authority to accept such assignment.

#### **CHAPTER V: CONTRACTOR'S SECURITY AND GUARANTEE**

#### **ARTICLE 19. SECURITY DEPOSIT**

19.1 If performance and payment bonds are required, the City shall retain the bid security to ensure that the successful bidder executes the Contract and furnishes the required payment and performance security within ten (10) Days after notice of the award of the Contract. If the successful bidder fails to execute the Contract and furnish the required payment and performance security, the City shall retain such bid security as set forth in the Information for Bidders. If the successful bidder executes the

Contract and furnishes the required payment and performance security, the City shall return the bid security within a reasonable time after the furnishing of such bonds and execution of the Contract by the City.

19.2 If performance and payment bonds are not required, the bid security shall be retained by the City as security for the Contractor's faithful performance of the Contract. If partial payments are provided, the bid security will be returned to the Contractor after the sum retained under Article 21 equals the amount of the bid security, subject to other provisions of this Contract. If partial payments are not provided, the bid security will be released when final payment is certified by the City for payment.

19.3 If the Contractor is declared in default under Article 48 prior to the return of the deposit, or if any claim is made such as referred to in Article 23, the amount of such deposit, or so much thereof as the Comptroller may deem necessary, may be retained and then applied by the Comptroller:

19.3.1 To compensate the City for any expense, loss or damage suffered or incurred by reason of or resulting from such default, including the cost of re-letting and liquidated damages; or

19.3.2 To indemnify the City against any and all claims.

#### **ARTICLE 20. PAYMENT GUARANTEE**

20.1 On Contracts where one hundred (100%) percent performance bonds and payment bonds are executed, this Article 20 does not apply.

20.2 In the event the terms of this Contract do not require the Contractor to provide a payment bond or where the Contract does not require a payment bond for one hundred (100%) percent of the Contract price, the City shall, in accordance with the terms of this Article 20, guarantee payment of all lawful claims for:

20.2.1 Wages and compensation for labor performed and/or services rendered; and

20.2.2 Materials, equipment, and supplies provided, whether incorporated into the Work or not, when demands have been filed with the City as provided hereinafter by any person, firm, or corporation which furnished labor, material, equipment, supplies, or any combination thereof, in connection with the Work performed hereunder (hereinafter referred to as the "beneficiary") at the direction of the City or the Contractor.

20.3 The provisions of Article 20.2 are subject to the following limitations and conditions:

20.3.1 If the Contractor provides a payment bond for a value that is less than one hundred (100%) percent of the value of the Contract Work, the payment bond provided by the Contractor shall be primary (and non-contributing) to the payment guarantee provided under this Article 20.

20.3.2 The guarantee is made for the benefit of all beneficiaries as defined in Article 20.2 provided that those beneficiaries strictly adhere to the terms and conditions of Article 20.3.4 and 20.3.5.

20.3.3 Nothing in this Article 20 shall prevent a beneficiary providing labor, services or material for the Work from suing the Contractor for any amounts due and owing the beneficiary by the Contractor.

20.3.4 Every person who has furnished labor or material, to the Contractor or to a Subcontractor of the Contractor, in the prosecution of the Work and who has not been paid in full therefor before the expiration of a period of ninety (90) Days after the date on which the last of the labor was performed or material was furnished by him/her for which the claim is made, shall have the right to sue on this payment guarantee in his/her own name for the amount, or the balance thereof, unpaid at the time of commencement of the action; provided, however, that a person having a direct contractual relationship with a Subcontractor of the Contractor but no contractual relationship express or implied with the Contractor shall not have a right of action upon the guarantee unless he/she shall have given written notice to the Contractor within one hundred twenty (120) Days from the date on which the last of the labor was performed or the last of the material was furnished, for which his/her claim is made, stating with substantial accuracy the amount claimed and the name of the party to whom the material was furnished or for whom the labor was performed. The notice shall be served by delivering the same personally to the Contractor or by mailing the same by registered mail, postage prepaid, in an envelope addressed to the Contractor at any place where it maintains an office or conducts its business; provided, however, that where such notice is actually received by the Contractor by other means, such notice shall be deemed sufficient.

20.3.5 Except as provided in Labor Law Section 220-g, no action on this payment guarantee shall be commenced after the expiration of the one-year limitations period set forth in Section 137(4)(b) of the State Finance Law.

20.3.6 The Contractor shall promptly forward to the City any notice or demand received pursuant to Article 20.3.4. The Contractor shall inform the City of any defenses to the notice or demand and shall forward to the City any documents the City requests concerning the notice or demand.

20.3.7 All demands made against the City by a beneficiary of this payment guarantee shall be presented to the Engineer along with all written documentation concerning the demand which the Engineer deems reasonably appropriate or necessary, which may include, but shall not be limited to: the subcontract; any invoices presented to the Contractor for payment; the notarized statement of the beneficiary that the demand is due and payable, that a request for payment has been made of the Contractor and that the demand has not been paid by the Contractor within the time allowed for such payment by the subcontract; and copies of any correspondence between the beneficiary and the Contractor concerning such demand. The City shall notify the Contractor that a demand has been made. The Contractor shall inform the City of any defenses to the demand and shall forward to the City any documents the City requests concerning the demand.

20.3.8 The City shall make payment only if, after considering all defenses presented by the Contractor, it determines that the payment is due and owing to the beneficiary making the demand.

20.3.9 No beneficiary shall be entitled to interest from the City, or to any other costs, including, but not limited to, attorneys' fees, except to the extent required by State Finance Law Section 137.

20.4 Upon the receipt by the City of a demand pursuant to this Article 20, the City may withhold from any payment otherwise due and owing to the Contractor under this Contract an amount sufficient to satisfy the demand.

20.4.1 In the event the City determines that the demand is valid, the City shall notify the Contractor of such determination and the amount thereof and direct the Contractor to immediately pay such amount to the beneficiary. In the event the Contractor, within seven (7) Days of receipt of such notification from the City, fails to pay the beneficiary, such failure shall constitute an automatic and irrevocable assignment of payment by the Contractor to the beneficiary for the amount of the demand determined by the City to be valid. The Contractor, without further notification or other process, hereby gives its unconditional consent to such assignment of payment to the beneficiary and authorizes the City, on its behalf, to take all necessary actions to implement such assignment of payment, including without limitation the execution of any instrument or documentation necessary to effectuate such assignment.

20.4.2 In the event that the amount otherwise due and owing to the Contractor by the City is insufficient to satisfy such demand, the City may, at its option, require payment from the Contractor of an amount sufficient to cover such demand and exercise any other right to require or recover payment which the City may have under Law or Contract.

20.4.3 In the event the City determines that the demand is invalid, any amount withheld pending the City's review of such demand shall be paid to the Contractor; provided, however, no lien has been filed. In the event a claim or an action has been filed, the terms and conditions set forth in Article 23 shall apply. In the event a lien has been filed, the parties will be governed by the provisions of the Lien Law of the State of New York.

20.5 The provisions of this Article 20 shall not prevent the City and the Contractor from resolving disputes in accordance with the PPB Rules, where applicable.

20.6 In the event the City determines that the beneficiary is entitled to payment pursuant to this Article 20, such determination and any defenses and counterclaims raised by the Contractor shall be taken into account in evaluating the Contractor's performance.

20.7 Nothing in this Article 20 shall relieve the Contractor of the obligation to pay the claims of all persons with valid and lawful claims against the Contractor relating to the Work.

20.8 The Contractor shall not require any performance, payment or other bonds of any Subcontractor if this Contract does not require such bonds of the Contractor.

20.9 The payment guarantee made pursuant to this Article 20 shall be construed in a manner consistent with Section 137 of the State Finance Law and shall afford to persons furnishing labor or materials to the Contractor or its Subcontractors in the prosecution of the Work under this Contract all of the rights and remedies afforded to such persons by such section, including but not limited to, the right to commence an action against the City on the payment guarantee provided by this Article 20 within the one-year limitations period set forth in Section 137(4)(b).

#### **ARTICLE 21. RETAINED PERCENTAGE**

21.1 If this Contract requires one hundred (100%) percent performance and payment security, then as further security for the faithful performance of this Contract, the Commissioner shall deduct, and

retain until the substantial completion of the Work, five (5%) percent of the value of Work certified for payment in each partial payment voucher.

21.2 If this Contract does not require one hundred (100%) percent performance and payment security and if the price for which this Contract was awarded does not exceed one million (\$1,000,000) dollars, then as further security for the faithful performance of this Contract, the Commissioner shall deduct, and retain until the substantial completion of the Work, five (5%) percent of the value of Work certified for payment in each partial payment voucher.

21.3 If this Contract does not require one hundred (100%) percent performance and payment security and if the price for which this Contract was awarded exceeds one million (\$1,000,000) dollars, then as further security for the faithful performance of this Contract, the Commissioner shall deduct, and retain until the substantial completion of the Work, up to ten (10%) percent of the value of Work certified for payment in each partial payment voucher. The percentage to be retained is set forth in Schedule A of the General Conditions.

## **ARTICLE 22. INSURANCE**

22.1 Types of Insurance: The Contractor shall procure and maintain the following types of insurance if, and as indicated, in Schedule A of the General Conditions (with the minimum limits and special conditions specified in Schedule A). Such insurance shall be maintained from the date the Contractor is required to provide Proof of Insurance pursuant to Article 22.3.1 through the date of completion of all required Work (including punch list work as certified in writing by the Resident Engineer), except for insurance required pursuant to Article 22.1.4, which may terminate upon Substantial Completion of the Contract. All insurance shall meet the requirements set forth in this Article 22. Wherever this Article requires that insurance coverage be "at least as broad" as a specified form (including all ISO forms), there is no obligation that the form itself be used, provided that the Contractor can demonstrate that the alternative form or endorsement contained in its policy provides coverage at least as broad as the specified form.

22.1.1 Commercial General Liability Insurance: The Contractor shall provide Commercial General Liability Insurance covering claims for property damage and/or bodily injury, including death, which may arise from any of the operations under this Contract. Coverage under this insurance shall be at least as broad as that provided by the latest edition of Insurance Services Office ("ISO") Form CG 0001. Such insurance shall be "occurrence" based rather than "claims-made" and include, without limitation, the following types of coverage: premises operations; products and completed operations; contractual liability (including the tort liability of another assumed in a contract); broad form property damage; independent contractors; explosion, collapse and underground (XCU); construction means and methods; and incidental malpractice. Such insurance shall contain a "per project" aggregate limit, as specified in Schedule A, that applies separately to operations under this Contract.

22.1.1(a) Such Commercial General Liability Insurance shall name the City as an Additional Insured. Coverage for the City shall specifically include the City's officials and employees, be at least as broad as the latest edition of ISO Form CG 20 10 and provide completed operations coverage at least as broad as the latest edition of ISO Form CG 20 37.

22.1.1(b) Such Commercial General Liability Insurance shall name all other entities designated as additional insureds in Schedule A but only for claims arising from the



**Contractor's operations under this Contract, with coverage at least as broad as the latest edition of ISO Form CG 20 26.**

**22.1.1(c) If the Work requires a permit from the Department of Buildings pursuant to 1 RCNY Section 101-08, the Contractor shall provide Commercial General Liability Insurance with limits of at least those required by 1 RCNY section 101-08 or greater limits required by the Agency in accordance with Schedule A. If the Work does not require such a permit, the minimum limits shall be those provided for in Schedule A.**

**22.1.1(d) If any of the Work includes repair of a waterborne vessel owned by or to be delivered to the City, such Commercial General Liability shall include, or be endorsed to include, Ship Repairer's Legal Liability Coverage to protect against, without limitation, liability arising from navigation of such vessels prior to delivery to and acceptance by the City.**

**22.1.2 Workers' Compensation Insurance, Employers' Liability Insurance, and Disability Benefits Insurance: The Contractor shall provide, and shall cause its Subcontractors to provide, Workers Compensation Insurance, Employers' Liability Insurance, and Disability Benefits Insurance in accordance with the Laws of the State of New York on behalf of all employees providing services under this Contract (except for those employees, if any, for which the Laws require insurance only pursuant to Article 22.1.3).**

**22.1.3 United States Longshoremen's and Harbor Workers Act and/or Jones Act Insurance: If specified in Schedule A of the General Conditions or if required by Law, the Contractor shall provide insurance in accordance with the United States Longshoremen's and Harbor Workers Act and/or the Jones Act, on behalf of all qualifying employees providing services under this Contract.**

**22.1.4 Builders Risk Insurance: If specified in Schedule A of the General Conditions, the Contractor shall provide Builders Risk Insurance on a completed value form for the total value of the Work through Substantial Completion of the Work in its entirety. Such insurance shall be provided on an All Risk basis and include coverage, without limitation, for windstorm (including named windstorm), storm surge, flood and earth movement. Unless waived by the Commissioner, it shall include coverage for ordinance and law, demolition and increased costs of construction, debris removal, pollutant clean up and removal, and expediting costs. Such insurance shall cover, without limitation, (a) all buildings and/or structures involved in the Work, as well as temporary structures at the Site, and (b) any property that is intended to become a permanent part of such building or structure, whether such property is on the Site, in transit or in temporary storage. Policies shall name the Contractor as Named Insured and list the City as both an Additional Insured and a Loss Payee as its interest may appear.**

**22.1.4(a) Policies of such insurance shall specify that, in the event a loss occurs at an occupied facility, occupancy of such facility is permitted without the consent of the issuing insurance company.**

**22.1.4(b) Such insurance may be provided through an Installation Floater, at the Contractor's option, if it otherwise conforms with the requirements of this Article 22.1.4.**

**22.1.5 Commercial Automobile Liability Insurance: The Contractor shall provide Commercial Automobile Liability Insurance for liability arising out of ownership,**

maintenance or use of any owned (if any), non-owned and hired vehicles to be used in connection with this Contract. Coverage shall be at least as broad as the latest edition of ISO Form CA0001. If vehicles are used for transporting hazardous materials, the Automobile Liability Insurance shall be endorsed to provide pollution liability broadened coverage for covered vehicles (endorsement CA 99 48) as well as proof of MCS 90.

**22.1.6 Contractors Pollution Liability Insurance:** If specified in Schedule A of the General Conditions, the Contractor shall maintain, or cause the Subcontractor doing such Work to maintain, Contractors Pollution Liability Insurance covering bodily injury and property damage. Such insurance shall provide coverage for actual, alleged or threatened emission, discharge, dispersal, seepage, release or escape of pollutants (including asbestos), including any loss, cost or expense incurred as a result of any cleanup of pollutants (including asbestos) or in the investigation, settlement or defense of any claim, action, or proceedings arising from the operations under this Contract. Such insurance shall be in the Contractor's name and list the City as an Additional Insured and any other entity specified in Schedule A. Coverage shall include, without limitation, (a) loss of use of damaged property or of property that has not been physically injured, (b) transportation, and (c) non-owned disposal sites.

**22.1.6(a) Coverage for the City as Additional Insured shall specifically include the City's officials and employees and be at least as broad as provided to the Contractor for this Project.**

**22.1.6(b) If such insurance is written on a claims-made policy, such policy shall have a retroactive date on or before the effective date of this Contract, and continuous coverage shall be maintained, or an extended discovery period exercised, for a period of not less than three (3) years from the time the Work under this Contract is completed.**

**22.1.7 Marine Insurance:**

**22.1.7(a) Marine Protection and Indemnity Insurance:** If specified in Schedule A of the General Conditions or if the Contractor engages in marine operations in the execution of any part of the Work, the Contractor shall maintain, or cause the Subcontractor doing such Work to maintain, Marine Protection and Indemnity Insurance with coverage at least as broad as Form SP-23. The insurance shall provide coverage for the Contractor or Subcontractor (whichever is doing this Work) and for the City (together with its officials and employees) and any other entity specified in Schedule A as an Additional Insured for bodily injury and property damage arising from marine operations under this Contract. Coverage shall include, without limitation, injury or death of crew members (if not fully provided through other insurance), removal of wreck, damage to piers, wharves and other fixed or floating objects and loss of or damage to any other vessel or craft, or to property on such other vessel or craft.

**22.1.7(b) Hull and Machinery Insurance:** If specified in Schedule A of the General Conditions or if the Contractor engages in marine operations in the execution of any part of the Work, the Contractor shall maintain, or cause the Subcontractor doing such Work to maintain, Hull and Machinery Insurance with coverage for the Contractor or Subcontractor (whichever is doing this Work) and for the City (together with its officials and employees) as Additional Insured at least as broad as the latest edition of American Institute Tug Form for all tugs used under this

**Contract and Collision Liability** at least as broad as the latest edition of American Institute Hull Clauses.

**22.1.7(c) Marine Pollution Liability Insurance:** If specified in Schedule A of the General Conditions or if the Contractor engages in marine operations in the execution of any part of the Work, the Contractor shall maintain, or cause the Subcontractor doing such Work to maintain, Marine Pollution Liability Insurance covering itself (or the Subcontractor doing such Work) as Named Insured and the City (together with its officials and employees) and any other entity specified in Schedule A as an Additional Insured. Coverage shall be at least as broad as that provided by the latest edition of Water Quality Insurance Syndicate Form and include, without limitation, liability arising from the discharge or substantial threat of a discharge of oil, or from the release or threatened release of a hazardous substance including injury to, or economic losses resulting from, the destruction of or damage to real property, personal property or natural resources.

**22.1.8** The Contractor shall provide such other types of insurance, at such minimum limits and with such conditions, as are specified in Schedule A of the General Conditions.

**22.2 General Requirements for Insurance Coverage and Policies:**

**22.2.1** All required insurance policies shall be maintained with companies that may lawfully issue the required policy and have an A.M. Best rating of at least A-/VII or a Standard and Poor's rating of at least A, unless prior written approval is obtained from the City Corporation Counsel.

**22.2.2** The Contractor shall be solely responsible for the payment of all premiums for all required policies and all deductibles and self-insured retentions to which such policies are subject, whether or not the City is an insured under the policy.

**22.2.3** In his/her sole discretion, the Commissioner may, subject to the approval of the Comptroller and the City Corporation Counsel, accept Letters of Credit and/or custodial accounts in lieu of required insurance.

**22.2.4** The City's limits of coverage for all types of insurance required pursuant to Schedule A of the General Conditions shall be the greater of (i) the minimum limits set forth in Schedule A or (ii) the limits provided to the Contractor as Named Insured under all primary, excess, and umbrella policies of that type of coverage.

**22.2.5** The Contractor may satisfy its insurance obligations under this Article 22 through primary policies or a combination of primary and excess/umbrella policies, so long as all policies provide the scope of coverage required herein.

**22.2.6** Policies of insurance provided pursuant to this Article 22 shall be primary and non-contributing to any insurance or self-insurance maintained by the City.

**22.3 Proof of Insurance:**

**22.3.1** For all types of insurance required by Article 22.1 and Schedule A, except for insurance required by Articles 22.1.4 and 22.1.7, the Contractor shall file proof of insurance in accordance with this Article 22.3 within ten (10) Days of award. For insurance

provided pursuant to Articles 22.1.4 and 22.1.7, proof shall be filed by a date specified by the **Commissioner** or ten (10) Days prior to the commencement of the portion of the **Work** covered by such policy, whichever is earlier.

22.3.2 For Workers' Compensation Insurance provided pursuant to Article 22.1.2, the **Contractor** shall submit one of the following forms: C-105.2 Certificate of Workers' Compensation Insurance; U-26.3 - State Insurance Fund Certificate of Workers' Compensation Insurance; Request for WC/DB Exemption (Form CE-200); equivalent or successor forms used by the New York State Workers' Compensation Board; or other proof of insurance in a form acceptable to the **Commissioner**. For Disability Benefits Insurance provided pursuant to Article 22.1.2, the **Contractor** shall submit DB-120.1 - Certificate Of Insurance Coverage Under The NYS Disability Benefits Law, Request for WC/DB Exemption (Form CE-200); equivalent or successor forms used by the New York State Workers' Compensation Board; or other proof of insurance in a form acceptable to the **Commissioner**. ACORD forms are not acceptable.

22.3.3 For policies provided pursuant to all of Article 22.1 other than Article 22.1.2, the **Contractor** shall submit one or more Certificates of Insurance on forms acceptable to the **Commissioner**. All such Certificates of Insurance shall certify (a) the issuance and effectiveness of such policies of insurance, each with the specified minimum limits (b) for insurance secured pursuant to Article 22.1.1 that the **City** and any other entity specified in Schedule A is an Additional Insured thereunder; (c) in the event insurance is required pursuant to Article 22.1.6 and/or Article 22.1.7, that the **City** is an Additional Insured thereunder; (d) the company code issued to the insurance company by the National Association of Insurance Commissioners (the NAIC number); and (e) the number assigned to the **Contract** by the **City**. All such Certificates of Insurance shall be accompanied by either a duly executed "Certification by Insurance Broker or Agent" in the form contained in Part III of Schedule A or copies of all policies referenced in such Certificate of Insurance as certified by an authorized representative of the issuing insurance carrier. If any policy is not available at the time of submission, certified binders may be submitted until such time as the policy is available, at which time a certified copy of the policy shall be submitted.

22.3.4 Documentation confirming renewals of insurance shall be submitted to the **Commissioner** prior to the expiration date of coverage of policies required under this **Contract**. Such proofs of insurance shall comply with the requirements of Articles 22.3.2 and 22.3.3.

22.3.5 The **Contractor** shall be obligated to provide the **City** with a copy of any policy of insurance provided pursuant to this Article 22 upon the demand for such policy by the **Commissioner** or the **City Corporation Counsel**.

#### 22.4 Operations of the **Contractor**:

22.4.1 The **Contractor** shall not commence the **Work** unless and until all required certificates have been submitted to and accepted by the **Commissioner**. Acceptance by the **Commissioner** of a certificate does not excuse the **Contractor** from securing insurance consistent with all provisions of this Article 22 or of any liability arising from its failure to do so.

22.4.2 The **Contractor** shall be responsible for providing continuous insurance coverage in the manner, form, and limits required by this **Contract** and shall be authorized to perform **Work** only during the effective period of all required coverage.

22.4.3 In the event that any of the required insurance policies lapse, are revoked, suspended or otherwise terminated, for whatever cause, the Contractor shall immediately stop all Work, and shall not recommence Work until authorized in writing to do so by the Commissioner. Upon quitting the Site, except as otherwise directed by the Commissioner, the Contractor shall leave all plant, materials, equipment, tools, and supplies on the Site. Contract time shall continue to run during such periods and no extensions of time will be granted. The Commissioner may also declare the Contractor in default for failure to maintain required insurance.

22.4.4 In the event the Contractor receives notice, from an insurance company or other person, that any insurance policy required under this Article 22 shall be cancelled or terminated (or has been cancelled or terminated) for any reason, the Contractor shall immediately forward a copy of such notice to both the Commissioner and the New York City Comptroller, attn: Office of Contract Administration, Municipal Building, One Centre Street, room 1005, New York, New York 10007. Notwithstanding the foregoing, the Contractor shall ensure that there is no interruption in any of the insurance coverage required under this Article 22.

22.4.5 Where notice of loss, damage, occurrence, accident, claim or suit is required under an insurance policy maintained in accordance with this Article 22, the Contractor shall notify in writing all insurance carriers that issued potentially responsive policies of any such event relating to any operations under this Contract (including notice to Commercial General Liability insurance carriers for events relating to the Contractor's own employees) no later than 20 days after such event. For any policy where the City is an Additional Insured, such notice shall expressly specify that "this notice is being given on behalf of the City of New York as Insured as well as the Named Insured." Such notice shall also contain the following information: the number of the insurance policy, the name of the named insured, the date and location of the damage, occurrence, or accident, and the identity of the persons or things injured, damaged or lost. The Contractor shall simultaneously send a copy of such notice to the City of New York c/o Insurance Claims Specialist, Affirmative Litigation Division, New York City Law Department, 100 Church Street, New York, New York 10007.

22.4.6 In the event of any loss, accident, claim, action, or other event that does or can give rise to a claim under any insurance policy required under this Article 22, the Contractor shall at all times fully cooperate with the City with regard to such potential or actual claim.

**22.5 Subcontractor Insurance:** In the event the Contractor requires any Subcontractor to procure insurance with regard to any operations under this Contract and requires such Subcontractor to name the Contractor as an Additional Insured thereunder, the Contractor shall ensure that the Subcontractor name the City, including its officials and employees, as an Additional Insured with coverage at least as broad as the most recent edition of ISO Form CG 20 26.

22.6 Wherever reference is made in Article 7 or this Article 22 to documents to be sent to the Commissioner (e.g., notices, filings, or submissions), such documents shall be sent to the address set forth in Schedule A of the General Conditions. In the event no address is set forth in Schedule A, such documents are to be sent to the Commissioner's address as provided elsewhere in this Contract.

22.7 Apart from damages or losses covered by insurance provided pursuant to Articles 22.1.2, 22.1.3, or 22.1.5, the Contractor waives all rights against the City, including its officials and employees, for any damages or losses that are covered under any insurance required under this Article 22 (whether or

not such insurance is actually procured or claims are paid thereunder) or any other insurance applicable to the operations of the **Contractor** and/or its employees, agents, or **Subcontractors**.

22.8 In the event the **Contractor** utilizes a self-insurance program to satisfy any of the requirements of this Article 22, the **Contractor** shall ensure that any such self-insurance program provides the City with all rights that would be provided by traditional insurance under this Article 22, including but not limited to the defense and indemnification obligations that insurers are required to undertake in liability policies.

22.9 **Materiality/Non-Waiver:** The **Contractor's** failure to secure policies in complete conformity with this Article 22, or to give an insurance company timely notice of any sort required in this **Contract** or to do anything else required by this Article 22 shall constitute a material breach of this **Contract**. Such breach shall not be waived or otherwise excused by any action or inaction by the City at any time.

22.10 Pursuant to General Municipal Law Section 108, this **Contract** shall be void and of no effect unless **Contractor** maintains Workers' Compensation Insurance for the term of this **Contract** to the extent required and in compliance with the New York State Workers' Compensation Law.

22.11 **Other Remedies:** Insurance coverage provided pursuant to this Article 22 or otherwise shall not relieve the **Contractor** of any liability under this **Contract**, nor shall it preclude the City from exercising any rights or taking such other actions available to it under any other provisions of this **Contract** or Law.

### **ARTICLE 23. MONEY RETAINED AGAINST CLAIMS**

23.1 If any claim shall be made by any person or entity (including **Other Contractors** with the City on this Project) against the City or against the **Contractor** and the City for any of the following:

- (a) An alleged loss, damage, injury, theft or vandalism of any of the kinds referred to in Articles 7 and 12, plus the reasonable costs of defending the City, which in the opinion of the **Comptroller** may not be paid by an insurance company (for any reason whatsoever); or
- (b) An infringement of copyrights, patents or use of patented articles, tools, etc., as referred to in Article 57; or
- (c) Damage claimed to have been caused directly or indirectly by the failure of the **Contractor** to perform the **Work** in strict accordance with this **Contract**,

the amount of such claim, or so much thereof as the **Comptroller** may deem necessary, may be withheld by the **Comptroller**, as security against such claim, from any money due hereunder. The **Comptroller**, in his/her discretion, may permit the **Contractor** to substitute other satisfactory security in lieu of the monies so withheld.

23.2 If an action on such claim is timely commenced and the liability of the City, or the **Contractor**, or both, shall have been established therein by a final judgment of a court of competent jurisdiction, or if such claim shall have been admitted by the **Contractor** to be valid, the **Comptroller** shall pay such judgment or admitted claim out of the monies retained by the **Comptroller** under the provisions of this Article 23, and return the balance, if any, without interest, to the **Contractor**.

## ARTICLE 24. MAINTENANCE AND GUARANTY

24.1 The Contractor shall promptly repair, replace, restore or rebuild, as the Commissioner may determine, any finished Work in which defects of materials or workmanship may appear or to which damage may occur because of such defects, during the one (1) year period subsequent to the date of Substantial Completion (or use and occupancy in accordance with Article 16), except where other periods of maintenance and guaranty are provided for in Schedule A.

24.2 As security for the faithful performance of its obligations hereunder, the Contractor, upon filing its requisition for payment on Substantial Completion, shall deposit with the Commissioner a sum equal to one (1%) percent of the price (or the amount fixed in Schedule A of the General Conditions) in cash or certified check upon a state or national bank and trust company or a check of such bank and trust company signed by a duly authorized officer thereof and drawn to the order of the Comptroller, or obligations of the City, which the Comptroller may approve as of equal value with the sum so required.

24.3 In lieu of the above, the Contractor may make such security payment to the City by authorizing the Commissioner in writing to deduct the amount from the Substantial Completion payment which shall be deemed the deposit required above.

24.4 If the Contractor has faithfully performed all of its obligations hereunder the Commissioner shall so certify to the Comptroller within five (5) Days after the expiration of one (1) year from the date of Substantial Completion and acceptance of the Work or within thirty (30) Days after the expiration of the guarantee period fixed in the Specifications. The security payment shall be repaid to the Contractor without interest within thirty (30) Days after certification by the Commissioner to the Comptroller that the Contractor has faithfully performed all of its obligations hereunder.

24.5 Notice by the Commissioner to the Contractor to repair, replace, rebuild or restore such defective or damaged Work shall be timely, pursuant to this article, if given not later than ten (10) Days subsequent to the expiration of the one (1) year period or other periods provided for herein.

24.6 If the Contractor shall fail to repair, replace, rebuild or restore such defective or damaged Work promptly after receiving such notice, the Commissioner shall have the right to have the Work done by others in the same manner as provided for in the completion of a defaulted Contract, under Article 51.

24.7 If the security payment so deposited is insufficient to cover the cost of such Work, the Contractor shall be liable to pay such deficiency on demand by the Commissioner.

24.8 The Engineer's certificate setting forth the fair and reasonable cost of repairing, replacing, rebuilding or restoring any damaged or defective Work when performed by one other than the Contractor, shall be binding and conclusive upon the Contractor as to the amount thereof.

24.9 The Contractor shall obtain all manufacturers' warranties and guaranties of all equipment and materials required by this Contract in the name of the City and shall deliver same to the Commissioner. All of the City's rights and title and interest in and to said manufacturers' warranties and guaranties may be assigned by the City to any subsequent purchasers of such equipment and materials or lessees of the premises into which the equipment and materials have been installed.

## CHAPTER VI: CHANGES, EXTRA WORK, AND DOCUMENTATION OF CLAIM

### ARTICLE 25. CHANGES

25.1 Changes may be made to this Contract only as duly authorized in writing by the Commissioner in accordance with the Law and this Contract. All such changes, modifications, and amendments will become a part of the Contract. Work so ordered shall be performed by the Contractor.

25.2 Contract changes will be made only for Work necessary to complete the Work included in the original scope of the Contract and/or for non-material changes to the scope of the Contract. Changes are not permitted for any material alteration in the scope of Work in the Contract.

25.3 The Contractor shall be entitled to a price adjustment for Extra Work performed pursuant to a written change order. Adjustments to price shall be computed in one or more of the following ways:

25.3.1 By applicable unit prices specified in the Contract; and/or

25.3.2 By agreement of a fixed price; and/or

25.3.3 By time and material records; and/or

25.3.4 In any other manner approved by the CCPO.

25.4 All payments for change orders are subject to pre-audit by the Engineering Audit Officer and may be post-audited by the Comptroller and/or the Agency.

### ARTICLE 26. METHODS OF PAYMENT FOR OVERRUNS AND EXTRA WORK

26.1 **Overrun of Unit Price Item:** An overrun is any quantity of a unit price item which the Contractor is directed to provide which is in excess of one hundred twenty-five (125%) percent of the estimated quantity for that item set forth in the bid schedule.

26.1.1 For any unit price item, the Contractor will be paid at the unit price bid for any quantity up to one hundred twenty-five (125%) percent of the estimated quantity for that item set forth in the bid schedule. If during the progress of the Work, the actual quantity of any unit price item required to complete the Work approaches the estimated quantity for that item, and for any reason it appears that the actual quantity of any unit price item necessary to complete the Work will exceed the estimated quantity for that item by twenty-five (25%) percent, the Contractor shall immediately notify the Engineer of such anticipated overrun. The Contractor shall not be compensated for any quantity of a unit price item provided which is in excess of one hundred twenty-five (125%) percent of the estimated quantity for that item set forth in the bid schedule without written authorization from the Engineer.

26.1.2 If the actual quantity of any unit price item necessary to complete the Work will exceed one hundred twenty five (125%) percent of the estimated quantity for that item set forth in the bid schedule, the City reserves the right and the Contractor agrees to negotiate a new unit price for such item. In no event shall such negotiated new unit price exceed the unit bid price. If the City and Contractor cannot agree on a new unit price, then the City shall order the Contractor and the Contractor agrees to provide additional quantities of



the item on the basis of time and material records for the actual and reasonable cost as determined under Article 26.2, but in no event at a unit price exceeding the unit price bid.

**26.2 Extra Work:** For **Extra Work** where payment is by agreement on a fixed price in accordance with Article 25.3.2, the price to be paid for such **Extra Work** shall be based on the fair and reasonable estimated cost of the items set forth below. For **Extra Work** where payment is based on time and material records in accordance with Article 25.3.3, the price to be paid for such **Extra Work** shall be the actual and reasonable cost of the items set forth below, calculated in accordance with the formula specified therein, if any.

26.2.1 Necessary materials (including transportation to the Site); plus

26.2.2 Necessary direct labor, including payroll taxes (subject to statutory wage caps) and supplemental benefits; plus

26.2.3 Sales and personal property taxes, if any, required to be paid on materials not incorporated into such **Extra Work**; plus

26.2.4 Reasonable rental value of **Contractor-owned** (or **Subcontractor-owned**, as applicable), necessary plant and equipment other than **Small Tools**, plus fuel/energy costs. Except for fuel costs for pick-up trucks which shall be reimbursed based on a consumption of five (5) gallons per shift, fuel costs shall be reimbursed based on actual costs or, in the absence of auditable documentation, the following fuel consumption formula per operating hour:  $(.035) \times (\text{HP rating}) \times (\text{Fuel cost/gallon})$ . Reasonable rental value is defined as the lower of either seventy-five percent of the monthly prorated rental rates established in "The AED Green Book, Rental Rates and Specifications for Construction Equipment" published by Equipment Watch (the "Green Book"), or seventy-five percent of the monthly prorated rental rates established in the "Rental Rate Blue Book for Construction Equipment" published by Equipment Watch (the "Blue Book") (the applicable Blue Book rate being for rental only without the addition of any operational costs listed in the Blue Book). The reasonable rental value is deemed to be inclusive of all operating costs except for fuel/energy consumption and equipment operator's wages/costs. For multiple shift utilization, reimbursement shall be calculated as follows: first shift shall be seventy-five (75%) percent of such rental rates; second shift shall be sixty (60%) percent of the first shift rate; and third shift shall be forty (40%) percent of the first shift rate. Equipment on standby shall be reimbursed at one-third (1/3) the prorated monthly rental rate. **Contractor-owned** (or **Subcontractor-owned**, as applicable) equipment includes equipment from rental companies affiliated with or controlled by the **Contractor** (or **Subcontractor**, as applicable), as determined by the **Commissioner**. In establishing cost reimbursement for non-operating **Contractor-owned** (or **Subcontractor-owned**, as applicable) equipment (scaffolding, sheeting systems, road plates, etc.), the **City** may restrict reimbursement to a purchase-salvage/life cycle basis if less than the computed rental costs; plus

26.2.5 Necessary installation and dismantling of such plant and equipment, including transportation to and from the **Site**, if any, provided that, in the case of non-**Contractor-owned** (or non-**Subcontractor-owned**, as applicable) equipment rented from a third party, the cost of installation and dismantling are not allowable if such costs are included in the rental rate; plus

26.2.6 Necessary fees charged by governmental entities; plus

26.2.7 Necessary construction-related service fees charged by non-governmental entities, such as landfill tipping fees; plus

26.2.8 Reasonable rental costs of non-Contractor-owned (or non-Subcontractor-owned, as applicable) necessary plant and equipment other than **Small Tools**, plus fuel/energy costs. Except for fuel costs for pick-up trucks which shall be reimbursed based on a consumption of five (5) gallons per shift, fuel costs shall be reimbursed based on actual costs or, in the absence of auditable documentation, the following fuel consumption formula per hour of operation:  $(.035) \times (\text{HP rating}) \times (\text{Fuel cost/gallon})$ . In lieu of renting, the City reserves the right to direct the purchase of non-operating equipment (scaffolding, sheeting systems, road plates, etc.), with payment on a purchase-salvage/life cycle basis, if less than the projected rental costs; plus

26.2.9 Workers' Compensation Insurance, and any insurance coverage expressly required by the City for the performance of the **Extra Work** which is different than the types of insurance required by Article 22 and Schedule A of the General Conditions. The cost of Workers' Compensation Insurance is subject to applicable payroll limitation caps and shall be based upon the carrier's Manual Rate for such insurance derived from the applicable class Loss Cost ("LC") and carrier's Lost Cost Multiplier ("LCM") approved by the New York State Department of Financial Services, and with the exception of experience rating, rate modifiers as promulgated by the New York Compensation Insurance Rating Board ("NYCIRB"); plus

26.2.10 Additional costs incurred as a result of the **Extra Work** for performance and payment bonds; plus

26.2.11 Twelve percent (12%) percent of the total of items in Articles 26.2.1 through 26.2.5 as compensation for overhead, except that no percentage for overhead will be allowed on **Payroll Taxes** or on the premium portion of overtime pay or on sales and personal property taxes. Overhead shall include without limitation, all costs and expenses in connection with administration, management superintendence, small tools, and insurance required by Schedule A of the General Conditions other than Workers' Compensation Insurance; plus

26.2.12 Ten (10%) percent of the total of items in Articles 26.2.1 through 26.2.5, plus the items in Article 26.2.11, as compensation for profit, except that no percentage for profit will be allowed on **Payroll Taxes** or on the premium portion of overtime pay or on sales and personal property taxes; plus

26.2.13 Five (5%) percent of the total of items in Articles 26.2.6 through 26.2.10 as compensation for overhead and profit.

26.3 Where the **Extra Work** is performed in whole or in part by other than the Contractor's own forces pursuant to Article 26.2, the Contractor shall be paid, subject to pre-audit by the **Engineering Audit Officer**, the cost of such Work computed in accordance with Article 26.2 above, plus an additional allowance of five (5%) percent to cover the Contractor's overhead and profit.

26.4 Where a change is ordered, involving both **Extra Work** and omitted or reduced **Contract Work**, the **Contract** price shall be adjusted, subject to pre-audit by the **EAO**, in an amount based on the difference between the cost of such **Extra Work** and of the omitted or reduced **Work**.

26.5 Where the Contractor and the Commissioner can agree upon a fixed price for **Extra Work** in accordance with Article 25.3.2 or another method of payment for **Extra Work** in accordance with

Article 25.3.4, or for Extra Work ordered in connection with omitted Work, such method, subject to pre-audit by the EAO, may, at the option of the Commissioner, be substituted for the cost plus a percentage method provided in Article 26.2; provided, however, that if the Extra Work is performed by a Subcontractor, the Contractor shall not be entitled to receive more than an additional allowance of five (5%) percent for overhead and profit over the cost of such Subcontractor's Work as computed in accordance with Article 26.2.

## **ARTICLE 27. RESOLUTION OF DISPUTES**

27.1 All disputes between the City and the Contractor of the kind delineated in this Article 27.1 that arise under, or by virtue of, this Contract shall be finally resolved in accordance with the provisions of this Article 27 and the PPB Rules. This procedure for resolving all disputes of the kind delineated herein shall be the exclusive means of resolving any such disputes.

27.1.1 This Article 27 shall not apply to disputes concerning matters dealt with in other sections of the PPB Rules, or to disputes involving patents, copyrights, trademarks, or trade secrets (as interpreted by the courts of New York State) relating to proprietary rights in computer software.

27.1.2 This Article 27 shall apply only to disputes about the scope of Work delineated by the Contract, the interpretation of Contract documents, the amount to be paid for Extra Work or disputed work performed in connection with the Contract, the conformity of the Contractor's Work to the Contract, and the acceptability and quality of the Contractor's Work; such disputes arise when the Engineer, Resident Engineer, Engineering Audit Officer, or other designee of the Commissioner makes a determination with which the Contractor disagrees.

27.2 All determinations required by this Article 27 shall be made in writing clearly stated, with a reasoned explanation for the determination based on the information and evidence presented to the party making the determination. Failure to make such determination within the time required by this Article 27 shall be deemed a non-determination without prejudice that will allow application to the next level.

27.3 During such time as any dispute is being presented, heard, and considered pursuant to this Article 27, the Contract terms shall remain in force and the Contractor shall continue to perform Work as directed by the ACCO or the Engineer. Failure of the Contractor to continue Work as directed shall constitute a waiver by the Contractor of its claim.

### **27.4 Presentation of Disputes to Commissioner.**

**Notice of Dispute and Agency Response.** The Contractor shall present its dispute in writing ("Notice of Dispute") to the Commissioner within thirty (30) Days of receiving written notice of the determination or action that is the subject of the dispute. This notice requirement shall not be read to replace any other notice requirements contained in the Contract. The Notice of Dispute shall include all the facts, evidence, documents, or other basis upon which the Contractor relies in support of its position, as well as a detailed computation demonstrating how any amount of money claimed by the Contractor in the dispute was arrived at. Within thirty (30) Days after receipt of the detailed written submission comprising the complete Notice of Dispute, the Engineer, Resident Engineer, Engineering Audit Officer, or other designee of the Commissioner shall submit to the Commissioner all materials he or she deems pertinent to the dispute. Following initial submissions to the Commissioner, either party may demand of the other the production of any document or other material the demanding party believes may be relevant to the dispute. The requested party shall produce all relevant materials that are not otherwise

protected by a legal privilege recognized by the courts of New York State. Any question of relevancy shall be determined by the **Commissioner** whose decision shall be final. Willful failure of the **Contractor** to produce any requested material whose relevancy the **Contractor** has not disputed, or whose relevancy has been affirmatively determined, shall constitute a waiver by the **Contractor** of its claim.

**27.4.1 Commissioner Inquiry.** The **Commissioner** shall examine the material and may, in his or her discretion, convene an informal conference with the **Contractor**, the **ACCO**, and the **Engineer, Resident Engineer, Engineering Audit Officer**, or other designee of the **Commissioner** to resolve the issue by mutual consent prior to reaching a determination. The **Commissioner** may seek such technical or other expertise as he or she shall deem appropriate, including the use of neutral mediators, and require any such additional material from either or both parties as he or she deems fit. The **Commissioner's** ability to render, and the effect of, a decision hereunder shall not be impaired by any negotiations in connection with the dispute presented, whether or not the **Commissioner** participated therein. The **Commissioner** may or, at the request of any party to the dispute, shall compel the participation of any **Other Contractor** with a contract related to the **Work** of this **Contract**, and that **Contractor** shall be bound by the decision of the **Commissioner**. Any **Other Contractor** thus brought into the dispute resolution proceeding shall have the same rights and obligations under this Article 27 as the **Contractor** initiating the dispute.

**27.4.2 Commissioner Determination.** Within thirty (30) **Days** after the receipt of all materials and information, or such longer time as may be agreed to by the parties, the **Commissioner** shall make his or her determination and shall deliver or send a copy of such determination to the **Contractor**, the **ACCO**, and **Engineer, Resident Engineer, Engineering Audit Officer**, or other designee of the **Commissioner**, as applicable, together with a statement concerning how the decision may be appealed.

**27.4.3 Finality of Commissioner's Decision.** The **Commissioner's** decision shall be final and binding on all parties, unless presented to the Contract Dispute Resolution Board pursuant to this Article 27. The **City** may not take a petition to the Contract Dispute Resolution Board. However, should the **Contractor** take such a petition, the **City** may seek, and the Contract Dispute Resolution Board may render, a determination less favorable to the **Contractor** and more favorable to the **City** than the decision of the **Commissioner**.

**27.5 Presentation of Dispute to the Comptroller.** Before any dispute may be brought by the **Contractor** to the Contract Dispute Resolution Board, the **Contractor** must first present its claim to the **Comptroller** for his or her review, investigation, and possible adjustment.

**27.5.1 Time, Form, and Content of Notice.** Within thirty (30) **Days** of its receipt of a decision by the **Commissioner**, the **Contractor** shall submit to the **Comptroller** and to the **Commissioner** a Notice of Claim regarding its dispute with the **Agency**. The Notice of Claim shall consist of (i) a brief written statement of the substance of the dispute, the amount of money, if any, claimed and the reason(s) the **Contractor** contends the dispute was wrongly decided by the **Commissioner**; (ii) a copy of the written decision of the **Commissioner**; and (iii) a copy of all materials submitted by the **Contractor** to the **Agency**, including the Notice of Dispute. The **Contractor** may not present to the **Comptroller** any material not presented to the **Commissioner**, except at the request of the **Comptroller**.

27.5.2 **Response.** Within thirty (30) Days of receipt of the Notice of Claim, the Agency shall make available to the Comptroller a copy of all material submitted by the Agency to the Commissioner in connection with the dispute. The Agency may not present to the Comptroller any material not presented to the Commissioner except at the request of the Comptroller.

27.5.3 **Comptroller Investigation.** The Comptroller may investigate the claim in dispute and, in the course of such investigation, may exercise all powers provided in Sections 7-201 and 7-203 of the Administrative Code. In addition, the Comptroller may demand of either party, and such party shall provide, whatever additional material the Comptroller deems pertinent to the claim, including original business records of the Contractor. Willful failure of the Contractor to produce within fifteen (15) Days any material requested by the Comptroller shall constitute a waiver by the Contractor of its claim. The Comptroller may also schedule an informal conference to be attended by the Contractor, Agency representatives, and any other personnel desired by the Comptroller.

27.5.4 **Opportunity of Comptroller to Compromise or Adjust Claim.** The Comptroller shall have forty-five (45) Days from his or her receipt of all materials referred to in Article 27.5.3 to investigate the disputed claim. The period for investigation and compromise may be further extended by agreement between the Contractor and the Comptroller, to a maximum of ninety (90) Days from the Comptroller's receipt of all materials. The Contractor may not present its petition to the Contract Dispute Resolution Board until the period for investigation and compromise delineated in this Article 27.5.4 has expired. In compromising or adjusting any claim hereunder, the Comptroller may not revise or disregard the terms of the Contract between the parties.

27.6 **Contract Dispute Resolution Board.** There shall be a Contract Dispute Resolution Board composed of:

27.6.1 The chief administrative law judge of the Office of Administrative Trials and Hearings (OATH) or his/her designated OATH administrative law judge, who shall act as chairperson, and may adopt operational procedures and issue such orders consistent with this Article 27 as may be necessary in the execution of the Contract Dispute Resolution Board's functions, including, but not limited to, granting extensions of time to present or respond to submissions;

27.6.2 The CCPO or his/her designee; any designee shall have the requisite background to consider and resolve the merits of the dispute and shall not have participated personally and substantially in the particular matter that is the subject of the dispute or report to anyone who so participated; and

27.6.3 A person with appropriate expertise who is not an employee of the City. This person shall be selected by the presiding administrative law judge from a prequalified panel of individuals, established and administered by OATH with appropriate background to act as decision-makers in a dispute. Such individual may not have a contract or dispute with the City or be an officer or employee of any company or organization that does, or regularly represents persons, companies, or organizations having disputes with the City.

27.7 **Petition to the Contract Dispute Resolution Board.** In the event the claim has not been settled or adjusted by the Comptroller within the period provided in this Article 27, the Contractor,

within thirty (30) Days thereafter, may petition the Contract Dispute Resolution Board to review the Commissioner's determination.

27.7.1 **Form and Content of Petition by Contractor.** The Contractor shall present its dispute to the Contract Dispute Resolution Board in the form of a petition, which shall include (i) a brief written statement of the substance of the dispute, the amount of money, if any, claimed, and the reason(s) the Contractor contends the dispute was wrongly decided by the Commissioner; (ii) a copy of the written Decision of the Commissioner, (iii) copies of all materials submitted by the Contractor to the Agency; (iv) a copy of the written decision of the Comptroller, if any, and (v) copies of all correspondence with, or written material submitted by the Contractor, to the Comptroller. The Contractor shall concurrently submit four (4) complete sets of the Petition: one set to the City Corporation Counsel (Attn: Commercial and Real Estate Litigation Division) and three (3) sets to the Contract Dispute Resolution Board at OATH's offices with proof of service on the City Corporation Counsel. In addition, the Contractor shall submit a copy of the written statement of the substance of the dispute, cited in (i) above, to both the Commissioner and the Comptroller.

27.7.2 **Agency Response.** Within thirty (30) Days of its receipt of the Petition by the City Corporation Counsel, the Agency shall respond to the brief written statement of the Contractor and make available to the Contract Dispute Resolution Board all material it submitted to the Commissioner and Comptroller. Three (3) complete copies of the Agency response shall be provided to the Contract Dispute Resolution Board and one to the Contractor. Extensions of time for submittal of the Agency response shall be given as necessary upon a showing of good cause or, upon consent of the parties, for an initial period of up to thirty (30) Days.

27.7.3 **Further Proceedings.** The Contract Dispute Resolution Board shall permit the Contractor to present its case by submission of memoranda, briefs, and oral argument. The Contract Dispute Resolution Board shall also permit the Agency to present its case in response to the Contractor by submission of memoranda, briefs, and oral argument. If requested by the City Corporation Counsel, the Comptroller shall provide reasonable assistance in the preparation of the Agency's case. Neither the Contractor nor the Agency may support its case with any documentation or other material that was not considered by the Comptroller, unless requested by the Contract Dispute Resolution Board. The Contract Dispute Resolution Board, in its discretion, may seek such technical or other expert advice as it shall deem appropriate and may seek, on its own or upon application of a party, any such additional material from any party as it deems fit. The Contract Dispute Resolution Board, in its discretion, may combine more than one dispute between the parties for concurrent resolution.

27.7.4 **Contract Dispute Resolution Board Determination.** Within forty-five (45) Days of the conclusion of all written submissions and oral arguments, the Contract Dispute Resolution Board shall render a written decision resolving the dispute. In an unusually complex case, the Contract Dispute Resolution Board may render its decision in a longer period, not to exceed ninety (90) Days, and shall so advise the parties at the commencement of this period. The Contract Dispute Resolution Board's decision must be consistent with the terms of the Contract. Decisions of the Contract Dispute Resolution Board shall only resolve matters before the Contract Dispute Resolution Board and shall not have precedential effect with respect to matters not before the Contract Dispute Resolution Board.

27.7.5 Notification of Contract Dispute Resolution Board Decision. The Contract Dispute Resolution Board shall send a copy of its decision to the Contractor, the ACCO, the Engineer, the Comptroller, the City Corporation Counsel, the CCPO, and the PPB. A decision in favor of the Contractor shall be subject to the prompt payment provisions of the PPB Rules. The Required Payment Date shall be thirty (30) Days after the date the parties are formally notified of the Contract Dispute Resolution Board's decision.

27.7.6 Finality of Contract Dispute Resolution Board Decision. The Contract Dispute Resolution Board's decision shall be final and binding on all parties. Any party may seek review of the Contract Dispute Resolution Board's decision solely in the form of a challenge, filed within four (4) months of the date of the Contract Dispute Resolution Board's decision, in a court of competent jurisdiction of the State of New York, County of New York pursuant to Article 78 of the Civil Practice Law and Rules. Such review by the court shall be limited to the question of whether or not the Contract Dispute Resolution Board's decision was made in violation of lawful procedure, was affected by an error of Law, or was arbitrary and capricious or an abuse of discretion. No evidence or information shall be introduced or relied upon in such proceeding that was not presented to the Contract Dispute Resolution Board in accordance with this Article 27.

27.8 Any termination, cancellation, or alleged breach of the Contract prior to or during the pendency of any proceedings pursuant to this Article 27 shall not affect or impair the ability of the Commissioner or Contract Dispute Resolution Board to make a binding and final decision pursuant to this Article 27.

#### **ARTICLE 28. RECORD KEEPING FOR EXTRA OR DISPUTED WORK OR WORK ON A TIME & MATERIALS BASIS**

28.1 While the Contractor or any of its Subcontractors is performing Work on a time and material basis or Extra Work on a time and material basis ordered by the Commissioner under Article 25, or where the Contractor believes that it or any of its Subcontractors is performing Extra Work but a final determination by Agency has not been made, or the Contractor or any of its Subcontractors is performing disputed Work (whether on or off the Site), or complying with a determination or order under protest in accordance with Articles 11, 27, and 30, in each such case the Contractor shall furnish the Resident Engineer daily with three (3) copies of written statements signed by the Contractor's representative at the Site showing:

28.1.1 The name, trade, and number of each worker employed on such Work or engaged in complying with such determination or order, the number of hours employed, and the character of the Work each is doing; and

28.1.2 The nature and quantity of any materials, plant and equipment furnished or used in connection with the performance of such Work or compliance with such determination or order, and from whom purchased or rented.

28.2 A copy of such statement will be countersigned by the Resident Engineer, noting thereon any items not agreed to or questioned, and will be returned to the Contractor within two (2) Days after submission.

28.3 The Contractor and its Subcontractors, when required by the Commissioner, or the Comptroller, shall also produce for inspection, at the office of the Contractor or Subcontractor, any and all of its books, bid documents, financial statements, vouchers, records, daily job diaries and reports,

and cancelled checks, and any other documents relating to showing the nature and quantity of the labor, materials, plant and equipment actually used in the performance of such Work, or in complying with such determination or order, and the amounts expended therefor, and shall permit the Commissioner and the Comptroller to make such extracts therefrom, or copies thereof, as they or either of them may desire.

28.4 In connection with the examination provided for herein, the Commissioner, upon demand therefor, will produce for inspection by the Contractor such records as the Agency may have with respect to such Extra Work or disputed Work performed under protest pursuant to order of the Commissioner, except those records and reports which may have been prepared for the purpose of determining the accuracy and validity of the Contractor's claim.

28.5 Failure to comply strictly with these requirements shall constitute a waiver of any claim for extra compensation or damages on account of the performance of such Work or compliance with such determination or order.

#### **ARTICLE 29. OMITTED WORK**

29.1 If any Contract Work in a lump sum Contract, or if any part of a lump sum item in a unit price, lump sum, or percentage-bid Contract is omitted by the Commissioner pursuant to Article 33, the Contract price, subject to audit by the EAO, shall be reduced by a pro rata portion of the lump sum bid amount based upon the percent of Work omitted subject to Article 29.4. For the purpose of determining the pro rata portion of the lump sum bid amount, the bid breakdown submitted in accordance with Article 41 shall be considered, but shall not be the determining factor.

29.2 If the whole of a lump sum item or units of any other item is so omitted by the Commissioner in a unit price, lump sum, or percentage-bid Contract, then no payment will be made therefor except as provided in Article 29.4.

29.3 For units that have been ordered but are only partially completed, the unit price shall be reduced by a pro rata portion of the unit price bid based upon the percentage of Work omitted subject to Article 29.4.

29.4 In the event the Contractor, with respect to any omitted Work, has purchased any non-cancelable material and/or equipment that is not capable of use except in the performance of this Contract and has been specifically fabricated for the sole purpose of this Contract, but not yet incorporated into the Work, the Contractor shall be paid for such material and/or equipment in accordance with Article 64.2.1(b); provided, however, such payment is contingent upon the Contractor's delivery of such material and/or equipment in acceptable condition to a location designated by the City.

29.5 The Contractor agrees to make no claim for damages or for loss of overhead and profit with regard to any omitted Work.

#### **ARTICLE 30. NOTICE AND DOCUMENTATION OF COSTS AND DAMAGES: PRODUCTION OF FINANCIAL RECORDS**

30.1 If the Contractor shall claim to be sustaining damages by reason of any act or omission of the City or its agents, it shall submit to the Commissioner within forty-five (45) Days from the time such damages are first incurred, and every thirty (30) Days thereafter to the extent additional damages are being incurred for the same condition, verified statements of the details and the amounts of such



damages, together with documentary evidence of such damages. The Contractor may submit any of the above statements within such additional time as may be granted by the Commissioner in writing upon written request therefor. Failure of the Commissioner to respond in writing to a written request for additional time within thirty (30) Days shall be deemed a denial of the request. On failure of the Contractor to strictly comply with the foregoing provisions, such claims shall be deemed waived and no right to recover on such claims shall exist. Damages that the Contractor may claim in any action or dispute resolution procedure arising under or by reason of this Contract shall not be different from or in excess of the statements and documentation made pursuant to this Article 30. This Article 30.1 does not apply to claims submitted to the Commissioner pursuant to Article 11 or to claims disputing a determination under Article 27.

30.2 In addition to the foregoing statements, the Contractor shall, upon notice from the Commissioner, produce for examination at the Contractor's office, by the Engineer, Architect or Project Manager, all of its books of account, bills, invoices, payrolls, subcontracts, time books, daily reports, bank deposit books, bank statements, check books, and cancelled checks, showing all of its acts and transactions in connection with or relating to or arising by reason of this Contract, and submit itself and persons in its employment, for examination under oath by any person designated by the Commissioner or Comptroller to investigate claims made or disputes against the City under this Contract. At such examination, a duly authorized representative of the Contractor may be present.

30.3 In addition to the statements required under Article 28 and this Article 30, the Contractor and/or its Subcontractor shall, within thirty (30) Days upon notice from the Commissioner or Comptroller, produce for examination at the Contractor's and/or Subcontractor's office, by a representative of either the Commissioner or Comptroller, all of its books of account, bid documents, financial statements, accountant workpapers, bills, invoices, payrolls, subcontracts, time books, daily reports, bank deposit books, bank statements, check books, and cancelled checks, showing all of its acts and transactions in connection with or relating to or arising by reason of this Contract. Further, the Contractor and/or its Subcontractor shall submit any person in its employment, for examination under oath by any person designated by the Commissioner or Comptroller to investigate claims made or disputes against the City under this Contract. At such examination, a duly authorized representative of the Contractor may be present.

30.4 Unless the information and examination required under Article 30.3 is provided by the Contractor and/or its Subcontractor upon thirty (30) Days' notice from the Commissioner or Comptroller, or upon the Commissioner's or Comptroller's written authorization to extend the time to comply, the City shall be released from all claims arising under, relating to or by reason of this Contract, except for sums certified by the Commissioner to be due under the provisions of this Contract. It is further stipulated and agreed that no person has the power to waive any of the foregoing provisions and that in any action or dispute resolution procedure against the City to recover any sum in excess of the sums certified by the Commissioner to be due under or by reason of this Contract, the Contractor must allege in its complaint and prove, at trial or during such dispute resolution procedure, compliance with the provisions of this Article 30.

30.5 In addition, after the commencement of any action or dispute resolution procedure by the Contractor arising under or by reason of this Contract, the City shall have the right to require the Contractor to produce for examination under oath, up until the trial of the action or hearing before the Contract Dispute Resolution Board, the books and documents described in Article 30.3 and submit itself and all persons in its employ for examination under oath. If this Article 30 is not complied with as required, then the Contractor hereby consents to the dismissal of the action or dispute resolution procedure.

**CHAPTER VII: POWERS OF THE RESIDENT ENGINEER, THE ENGINEER OR ARCHITECT AND THE COMMISSIONER**

**ARTICLE 31. THE RESIDENT ENGINEER**

31.1 The Resident Engineer shall have the power to inspect, supervise, and control the performance of the Work, subject to review by the Commissioner. The Resident Engineer shall not, however, have the power to issue an Extra Work order, except as specifically designated in writing by the Commissioner.

**ARTICLE 32. THE ENGINEER OR ARCHITECT OR PROJECT MANAGER**

32.1 The Engineer or Architect or Project Manager, in addition to those matters elsewhere herein delegated to the Engineer and expressly made subject to his/her determination, direction or approval, shall have the power, subject to review by the Commissioner:

32.1.1 To determine the amount, quality, and location of the Work to be paid for hereunder; and

32.1.2 To determine all questions in relation to the Work, to interpret the Contract Drawings, Specifications, and Addenda, and to resolve all patent inconsistencies or ambiguities therein; and

32.1.3 To determine how the Work of this Contract shall be coordinated with Work of Other Contractors engaged simultaneously on this Project, including the power to suspend any part of the Work, but not the whole thereof; and

32.1.4 To make minor changes in the Work as he/she deems necessary, provided such changes do not result in a net change in the cost to the City or to the Contractor of the Work to be done under the Contract; and

32.1.5 To amplify the Contract Drawings, add explanatory information and furnish additional Specifications and drawings, consistent with this Contract.

32.2 The foregoing enumeration shall not imply any limitation upon the power of the Engineer or Architect or Project Manager, for it is the intent of this Contract that all of the Work shall generally be subject to his/her determination, direction, and approval, except where the determination, direction or approval of someone other than the Engineer or Architect or Project Manager is expressly called for herein.

32.3 The Engineer or Architect or Project Manager shall not, however, have the power to issue an Extra Work order, except as specifically designated in writing by the Commissioner.

**ARTICLE 33. THE COMMISSIONER**

33.1 The Commissioner, in addition to those matters elsewhere herein expressly made subject to his/her determination, direction or approval, shall have the power:

33.1.1 To review and make determinations on any and all questions in relation to this Contract and its performance; and

33.1.2 To modify or change this Contract so as to require the performance of Extra Work (subject, however, to the limitations specified in Article 25) or the omission of Contract Work; and

33.1.3 To suspend the whole or any part of the Work whenever in his/her judgment such suspension is required:

33.1.3(a) In the interest of the City generally; or

33.1.3(b) To coordinate the Work of the various contractors engaged on this Project pursuant to the provisions of Article 12; or

33.1.3(c) To expedite the completion of the entire Project even though the completion of this particular Contract may thereby be delayed.

#### **ARTICLE 34. NO ESTOPPEL**

34.1 Neither the City nor any Agency, official, agent or employee thereof, shall be bound, precluded or estopped by any determination, decision, approval, order, letter, payment or certificate made or given under or in connection with this Contract by the City, the Commissioner, the Engineer, the Resident Engineer, or any other official, agent or employee of the City, either before or after the final completion and acceptance of the Work and payment therefor:

34.1.1 From showing the true and correct classification, amount, quality or character of the Work actually done; or that any such determination, decision, order, letter, payment or certificate was untrue, incorrect or improperly made in any particular; or that the Work, or any part thereof, does not in fact conform to the requirements of this Contract; and

34.1.2 From demanding and recovering from the Contractor any overpayment made to it, or such damages as the City may sustain by reason of the Contractor's failure to perform each and every part of its Contract.

### **CHAPTER VIII: LABOR PROVISIONS**

#### **ARTICLE 35. EMPLOYEES**

35.1 The Contractor and its Subcontractors shall not employ on the Work:

35.1.1 Anyone who is not competent, faithful and skilled in the Work for which he/she shall be employed; and whenever the Commissioner shall inform the Contractor, in writing, that any employee is, in his/her opinion, incompetent, unfaithful or disobedient, that employee shall be discharged from the Work forthwith, and shall not again be employed upon it; or

35.1.2 Any labor, materials or means whose employment, or utilization during the course of this Contract, may tend to or in any way cause or result in strikes, work stoppages, delays, suspension of Work or similar troubles by workers employed by the Contractor or its Subcontractors, or by any of the trades working in or about the buildings and premises where Work is being performed under this Contract, or by Other Contractors or their Subcontractors pursuant to other contracts, or on any other building or premises owned or operated by the City, its Agencies, departments, boards or authorities. Any violation by the Contractor of this requirement may, upon certification of the Commissioner, be considered as proper and sufficient cause for declaring the Contractor to be in default, and for the City to take action against it as set forth in Chapter X of this Contract, or such other article of this Contract as the Commissioner may deem proper; or

35.1.3 In accordance with Section 220.3-e of the Labor Law of the State of New York (hereinafter "Labor Law"), the Contractor and its Subcontractors shall not employ on the Work any apprentice, unless he/she is a registered individual, under a bona fide program registered with the New York State Department of Labor. The allowable ratio of apprentices to journey-level workers in any craft classification shall not be greater than the ratio permitted to the Contractor as to its work force on any job under the registered program. Any employee listed on a payroll at an apprentice wage rate, who is not registered as above, shall be paid the wage rate determined by the Comptroller of the City for the classification of Work actually performed. The Contractor or Subcontractor will be required to furnish written evidence of the registration of its program and apprentices as well as all the appropriate ratios and wage rates, for the area of the construction prior to using any apprentices on the Contract Work.

35.2 If the total cost of the Work under this Contract is at least two hundred fifty thousand (\$250,000) dollars, all laborers, workers, and mechanics employed in the performance of the Contract on the public work site, either by the Contractor, Subcontractor or other person doing or contracting to do the whole or a part of the Work contemplated by the Contract, shall be certified prior to performing any Work as having successfully completed a course in construction safety and health approved by the United States Department of Labor's Occupational Safety and Health Administration that is at least ten (10) hours in duration.

35.3 In accordance with Local Law Nos. 30-2012 and 33-2012, codified at sections 6-132 and 12-113 of the Administrative Code, respectively,

35.3.1 The Contractor shall not take an adverse personnel action with respect to an officer or employee in retaliation for such officer or employee making a report of information concerning conduct which such officer or employee knows or reasonably believes to involve corruption, criminal activity, conflict of interest, gross mismanagement or abuse of authority by any officer or employee relating to this Contract to (a) the Commissioner of the Department of Investigation, (b) a member of the New York City Council, the Public Advocate, or the Comptroller, or (c) the CCPO, ACCO, Agency head, or Commissioner.

35.3.2 If any of the Contractor's officers or employees believes that he or she has been the subject of an adverse personnel action in violation of Article 35.3.1, he or she shall be entitled to bring a cause of action against the Contractor to recover all relief necessary to make him or her whole. Such relief may include but is not limited to: (a) an injunction to restrain continued retaliation, (b) reinstatement to the position such employee would have had but for the retaliation or to an equivalent position, (c) reinstatement of full fringe benefits and seniority rights, (d) payment of two times back

pay, plus interest, and (e) compensation for any special damages sustained as a result of the retaliation, including litigation costs and reasonable attorney's fees.

35.3.3 The Contractor shall post a notice provided by the City in a prominent and accessible place on any site where work pursuant to the Contract is performed that contains information about:

35.3.3(a) how its employees can report to the New York City Department of Investigation allegations of fraud, false claims, criminality or corruption arising out of or in connection with the Contract; and

35.3.3(b) the rights and remedies afforded to its employees under Administrative Code sections 7-805 (the New York City False Claims Act) and 12-113 (the Whistleblower Protection Expansion Act) for lawful acts taken in connection with the reporting of allegations of fraud, false claims, criminality or corruption in connection with the Contract.

35.3.4 For the purposes of this Article 35.3, "adverse personnel action" includes dismissal, demotion, suspension, disciplinary action, negative performance evaluation, any action resulting in loss of staff, office space, equipment or other benefit, failure to appoint, failure to promote, or any transfer or assignment or failure to transfer or assign against the wishes of the affected officer or employee.

35.3.5 This Article 35.3 is applicable to all of the Contractor's Subcontractors having subcontracts with a value in excess of \$100,000; accordingly, the Contractor shall include this rider in all subcontracts with a value a value in excess of \$100,000.

35.4 Article 35.3 is not applicable to this Contract if it is valued at \$100,000 or less. Articles 35.3.1, 35.3.2, 35.3.4, and 35.3.5 are not applicable to this Contract if it was solicited pursuant to a finding of an emergency.

#### 35.5 Paid Sick Leave Law.

##### 35.5.1 Introduction and General Provisions.

35.5.1(a) The Earned Sick Time Act, also known as the Paid Sick Leave Law ("PSLL"), requires covered employees who annually perform more than 80 hours of work in New York City to be provided with paid sick time.<sup>2</sup> Contractors of the City or of other governmental entities may be required to provide sick time pursuant to the PSLL.

35.5.1(b) The PSLL became effective on April 1, 2014, and is codified at Title 20, Chapter 8, of the New York City Administrative Code. It is administered by the City's Department of Consumer Affairs ("DCA"); DCA's rules promulgated under the PSLL are codified at Chapter 7 of Title 6 of the Rules of the City of New York ("Rules").

<sup>2</sup> Pursuant to the PSLL, if fewer than five employees work for the same employer, as determined pursuant to New York City Administrative Code § 20-912(g), such employer has the option of providing such employees uncompensated sick time.

35.5.1(c) The Contractor agrees to comply in all respects with the PSL and the Rules, and as amended, if applicable, in the performance of this Contract. The Contractor further acknowledges that such compliance is a material term of this Contract and that failure to comply with the PSL in performance of this Contract may result in its termination.

35.5.1(d) The Contractor must notify the Agency Chief Contracting Officer of the Agency with whom it is contracting in writing within ten (10) days of receipt of a complaint (whether oral or written) regarding the PSL involving the performance of this Contract. Additionally, the Contractor must cooperate with DCA's education efforts and must comply with DCA's subpoenas and other document demands as set forth in the PSL and Rules.

35.5.1(e) The PSL is summarized below for the convenience of the Contractor. The Contractor is advised to review the PSL and Rules in their entirety. On the website [www.nyc.gov/PaidSickLeave](http://www.nyc.gov/PaidSickLeave) there are links to the PSL and the associated Rules as well as additional resources for employers, such as Frequently Asked Questions, timekeeping tools and model forms, and an event calendar of upcoming presentations and webinars at which the Contractor can get more information about how to comply with the PSL. The Contractor acknowledges that it is responsible for compliance with the PSL notwithstanding any inconsistent language contained herein.

#### 35.5.2 Pursuant to the PSL and the Rules: Applicability, Accrual, and Use.

35.5.2(a) An employee who works within the City of New York for more than eighty hours in any consecutive 12-month period designated by the employer as its "calendar year" pursuant to the PSL ("Year") must be provided sick time. Employers must provide a minimum of one hour of sick time for every 30 hours worked by an employee and compensation for such sick time must be provided at the greater of the employee's regular hourly rate or the minimum wage. Employers are not required to provide more than 40 hours of sick time to an employee in any Year.

35.5.2(b) An employee has the right to determine how much sick time he or she will use, provided that employers may set a reasonable minimum increment for the use of sick time not to exceed four hours per Day. In addition, an employee may carry over up to 40 hours of unused sick time to the following Year, provided that no employer is required to allow the use of more than forty hours of sick time in a Year or carry over unused paid sick time if the employee is paid for such unused sick time and the employer provides the employee with at least the legally required amount of paid sick time for such employee for the immediately subsequent Year on the first Day of such Year.

35.5.2(c) An employee entitled to sick time pursuant to the PSL may use sick time for any of the following:

- i. such employee's mental illness, physical illness, injury, or health condition or the care of such illness, injury, or condition or such employee's need for medical diagnosis or preventive medical care;
- ii. such employee's care of a family member (an employee's child, spouse, domestic partner, parent, sibling, grandchild or grandparent, or the child or parent of an employee's spouse or domestic partner) who has a mental

- illness, physical illness, injury or health condition or who has a need for medical diagnosis or preventive medical care;
- iii. closure of such employee's place of business by order of a public official due to a public health emergency; or
  - iv. such employee's need to care for a child whose school or childcare provider has been closed due to a public health emergency.

35.5.2(d) An employer must not require an employee, as a condition of taking sick time, to search for a replacement. However, an employer may require an employee to provide: reasonable notice of the need to use sick time; reasonable documentation that the use of sick time was needed for a reason above if for an absence of more than three consecutive work days; and/or written confirmation that an employee used sick time pursuant to the PSLL. However, an employer may not require documentation specifying the nature of a medical condition or otherwise require disclosure of the details of a medical condition as a condition of providing sick time and health information obtained solely due to an employee's use of sick time pursuant to the PSLL must be treated by the employer as confidential.

35.5.2(e) If an employer chooses to impose any permissible discretionary requirement as a condition of using sick time, it must provide to all employees a written policy containing those requirements, using a delivery method that reasonably ensures that employees receive the policy. If such employer has not provided its written policy, it may not deny sick time to an employee because of non-compliance with such a policy.

35.5.2(f) Sick time to which an employee is entitled must be paid no later than the payday for the next regular payroll period beginning after the sick time was used.

35.5.3 Exemptions and Exceptions. Notwithstanding the above, the PSLL does not apply to any of the following:

35.5.3(a) an independent contractor who does not meet the definition of employee under section 190(2) of the New York State Labor Law;

35.5.3(b) an employee covered by a valid collective bargaining agreement in effect on April 1, 2014, until the termination of such agreement;

35.5.3(c) an employee in the construction or grocery industry covered by a valid collective bargaining agreement if the provisions of the PSLL are expressly waived in such collective bargaining agreement;

35.5.3(d) an employee covered by another valid collective bargaining agreement if such provisions are expressly waived in such agreement and such agreement provides a benefit comparable to that provided by the PSLL for such employee;

35.5.3(e) an audiologist, occupational therapist, physical therapist, or speech language pathologist who is licensed by the New York State Department of Education and who calls in for work assignments at will, determines his or her own schedule, has the ability to reject or accept any assignment referred to him or her, and is paid an average hourly wage that is at least four times the federal minimum wage;

35.5.3(f) an employee in a work study program under Section 2753 of Chapter 42 of the United States Code;

35.5.3(g) an employee whose work is compensated by a qualified scholarship program as that term is defined in the Internal Revenue Code, Section 117 of Chapter 20 of the United States Code; or

35.5.3(h) a participant in a Work Experience Program (WEP) under section 336-c of the New York State Social Services Law.

**35.5.4 Retaliation Prohibited.** An employer may not threaten or engage in retaliation against an employee for exercising or attempting in good faith to exercise any right provided by the PSLL. In addition, an employer may not interfere with any investigation, proceeding, or hearing pursuant to the PSLL.

**35.5.5 Notice of Rights.**

35.5.5(a) An employer must provide its employees with written notice of their rights pursuant to the PSLL. Such notice must be in English and the primary language spoken by an employee, provided that DCA has made available a translation into such language. Downloadable notices are available on DCA's website at <http://www.nyc.gov/html/dca/html/law/PaidSickLeave.shtml>.

35.5.5(b) Any person or entity that willfully violates these notice requirements is subject to a civil penalty in an amount not to exceed fifty dollars for each employee who was not given appropriate notice.

**35.5.6 Records.** An employer must retain records documenting its compliance with the PSLL for a period of at least three years, and must allow DCA to access such records in furtherance of an investigation related to an alleged violation of the PSLL.

**35.5.7 Enforcement and Penalties.**

35.5.7(a) Upon receiving a complaint alleging a violation of the PSLL, DCA has the right to investigate such complaint and attempt to resolve it through mediation. Within 30 Days of written notification of a complaint by DCA, or sooner in certain circumstances, the employer must provide DCA with a written response and such other information as DCA may request. If DCA believes that a violation of the PSLL has occurred, it has the right to issue a notice of violation to the employer.

35.5.7(b) DCA has the power to grant an employee or former employee all appropriate relief as set forth in New York City Administrative Code § 20-924(d). Such relief may include, among other remedies, treble damages for the wages that should have been paid, damages for unlawful retaliation, and damages and reinstatement for unlawful discharge. In addition, DCA may impose on an employer found to have violated the PSLL civil penalties not to exceed \$500 for a first violation, \$750 for a second violation within two years of the first violation, and \$1,000 for each succeeding violation within two years of the previous violation.

**35.5.8 More Generous Policies and Other Legal Requirements.** Nothing in the PSLL is intended to discourage, prohibit, diminish, or impair the adoption or retention of a more generous sick time policy, or the obligation of an employer to comply with any contract,



collective bargaining agreement, employment benefit plan or other agreement providing more generous sick time. The PSLL provides minimum requirements pertaining to sick time and does not preempt, limit or otherwise affect the applicability of any other law, regulation, rule, requirement, policy or standard that provides for greater accrual or use by employees of sick leave or time, whether paid or unpaid, or that extends other protections to employees. The PSLL may not be construed as creating or imposing any requirement in conflict with any federal or state law, rule or regulation.

**35.6 HireNYC: Hiring and Reporting Requirements.** This Article 35.6 applies to construction contracts of \$1,000,000 or more. The Contractor shall comply with the requirements of Articles 35.6.1-35.6.5 for all non-trades jobs (e.g., for an administrative position arising out of Work ant located in New York City). The Contractor shall reasonably cooperate with SBS and the City on specific outreach events, including "Hire-on-the-Spot" events, for the hiring of trades workers in connection with the Work. If provided elsewhere in this Contract, this Contract is subject to a project labor agreement.

**35.6.1 Enrollment.** The Contractor shall enroll with the HireNYC system, found at [www.nyc.gov/sbs](http://www.nyc.gov/sbs), within thirty (30) days after the registration of this Contract pursuant to Section 328 of the New York City Charter. The Contractor shall provide information about the business, designate a primary contact and say whether it intends to hire for any entry to mid-level job opportunities arising from this Contract and located in New York City, and, if so, the approximate start date of the first hire.

**35.6.2 Job Posting Requirements.**

**35.6.2(a)** Once enrolled in HireNYC, the Contractor agrees to update the HireNYC portal with all entry to mid-level job opportunities arising from this Contract and located in New York City, if any, which shall be defined as jobs requiring no more than an associate degree, as provided by the New York State Department of Labor (see Column F of <https://labor.ny.gov/stats/2012-2022-NYS-Employment-Prospects.xls>). The information to be updated includes the types of entry and mid-level positions made available from the work arising from the Contract and located in New York City, the number of positions, the anticipated schedule of initiating the hiring process for these positions, and the contact information for the Contractor's representative charged with overseeing hiring. The Contractor must update the HireNYC portal with any hiring needs arising from the contract and located in New York City, and the requirements of the jobs to be filled, no less than three weeks prior to the intended first day of employment for each new position, except with the permission of SBS, not to be unreasonably withheld, and must also update the HireNYC portal as set forth below.

**35.6.2(b)** After enrollment through HireNYC and submission of relevant information, SBS will work with the Contractor to develop a recruitment plan which will outline the candidate screening process, and will provide clear instructions as to when, where, and how interviews will take place. HireNYC will screen applicants based on employer requirements and refer applicants whom it believes are qualified to the Contractor for interviews. The Contractor must interview referred applicants whom it believes are qualified.

**35.6.2(c)** After completing an interview of a candidate referred by HireNYC, the Contractor must provide feedback via the portal within twenty (20) business days to indicate which candidates were interviewed and hired, if any. In addition, the Contractor shall provide the start date of new hires, and additional information

reasonably related to such hires, within twenty (20) business days after the start date. In the event the Contractor does not have any job openings covered by this Rider in any given year, the Contractor shall be required to provide an annual update to HireNYC to that effect. For this purpose, the reporting year shall run from the date of the registration of the Contract pursuant to Charter section 328 and each anniversary date.

35.6.2(d) These requirements do not limit the Contractor's ability to assess the qualifications of prospective workers, and to make final hiring and retention decisions. No provision of this Article 35.6 shall be interpreted so as to require the Contractor to employ any particular worker.

35.6.2(e) In addition, the provisions of this Article 35.6 shall not apply to positions that the Contractor intends to fill with employees employed pursuant to the job retention provision of Section 22-505 of the Administrative Code of the City of New York. The Contractor shall not be required to report such openings with HireNYC. However, the Contractor shall enroll with the HireNYC system pursuant to Article 35.6.1, above, and, if such positions subsequently become open, then the remaining provisions of this Article 35.6 will apply.

35.6.3 Breach and Liquidated Damages. If the Contractor fails to comply with the terms of the Contract and this Article 35.6 (1) by not enrolling its business with HireNYC; (2) by not informing HireNYC, as required, of open positions; or (3) by failing to interview a qualified candidate, the Agency may assess liquidated damages in the amount of two-thousand five hundred dollars (\$2,500) per breach. For all other events of noncompliance with the terms of this Article 35.6, the Agency may assess liquidated damages in the amount of five hundred dollars (\$500) per breach. Furthermore, in the event the Contractor breaches the requirements of this Article 35.6 during the term of the Contract, the City may hold the Contractor in default of this Contract.

35.6.4 Audit Compliance. In addition to the auditing requirements set forth in other parts of the Contract, the Contractor shall permit SBS and the City to inspect any and all records concerning or relating to job openings or the hiring of individuals for work arising from the Contract and located in New York City. The Contractor shall permit an inspection within seven (7) business days of the request.

35.6.5 Other Reporting Requirements. The Contractor shall report to the City, on a monthly basis, all information reasonably requested by the City that is necessary for the City to comply with any reporting requirements imposed by Law, including any requirement that the City maintain a publicly accessible database. In addition, the Contractor agrees to comply with all reporting requirements imposed by Law, or as otherwise requested by the City.

35.6.6 Federal Hiring Requirements. If this Contract is federally funded (as indicated elsewhere in this Contract), the Contractor shall comply with all federal hiring requirements as may be set forth in this Contract, including, as applicable: (a) Section 3 of the HUD Act of 1968, which requires, to the greatest extent feasible, economic opportunities for 30 percent of new hires be given to low- and very low-income persons, particularly persons who are recipients of HUD assistance for housing and Executive Order 11246, which prohibits discrimination in employment due to race, color, religion, sex or national origin, and requires the implementation of goals for minority and female participation for work involving any construction trade.

**ARTICLE 36. NO DISCRIMINATION**

36.1 The Contractor specifically agrees, as required by Labor Law Section 220-e, as amended, that:

36.1.1 In the hiring of employees for the performance of Work under this Contract or any subcontract hereunder, neither the Contractor, Subcontractor, nor any person acting on behalf of such Contractor or Subcontractor, shall by reason of race, creed, color or national origin discriminate against any citizen of the State of New York who is qualified and available to perform the Work to which the employment relates;

36.1.2 Neither the Contractor, Subcontractor, nor any person on its behalf shall, in any manner, discriminate against or intimidate any employee hired for the performance of Work under this Contract on account of race, creed, color or national origin;

36.1.3 There may be deducted from the amount payable to the Contractor by the City under this Contract a penalty of fifty (\$50.00) dollars for each person for each Day during which such person was discriminated against or intimidated in violation of the provisions of this Contract; and

36.1.4 This Contract may be cancelled or terminated by the City and all moneys due or to become due hereunder may be forfeited, for a second or any subsequent violation of the terms or conditions of this Article 36.

36.1.5 This Article 36 covers all construction, alteration and repair of any public building or public work occurring in the State of New York and the manufacture, sale, and distribution of materials, equipment, and supplies to the extent that such operations are performed within the State of New York pursuant to this Contract.

36.2 The Contractor specifically agrees, as required by Section 6-108 of the Administrative Code, as amended, that:

36.2.1 It shall be unlawful for any person engaged in the construction, alteration or repair of buildings or engaged in the construction or repair of streets or highways pursuant to a Contract with the City or engaged in the manufacture, sale or distribution of materials, equipment or supplies pursuant to a Contract with the City to refuse to employ or to refuse to continue in any employment any person on account of the race, color or creed of such person.

36.2.2 It shall be unlawful for any person or any servant, agent or employee of any person, described in Article 36.1.2, to ask, indicate or transmit, orally or in writing, directly or indirectly, the race, color or creed or religious affiliation of any person employed or seeking employment from such person, firm or corporation.

36.2.3 Breach of the foregoing provisions shall be deemed a violation of a material provision of this Contract.

36.2.4 Any person, or the employee, manager or owner of or officer of such firm or corporation who shall violate any of the provisions of this Article 36.2 shall, upon

conviction thereof, be punished by a fine of not more than one hundred (\$100.00) dollars or by imprisonment for not more than thirty (30) Days, or both.

36.3 This Contract is subject to the requirements of Executive Order No. 50 (1980) ("E.O. 50"), as revised, and the rules and regulations promulgated thereunder. No contract will be awarded unless and until these requirements have been complied with in their entirety. By signing this Contract, the Contractor agrees that it:

36.3.1 Will not engage in any unlawful discrimination against any employee or applicant for employment because of race, creed, color, national origin, sex, age, disability, marital status or sexual orientation with respect to all employment decisions including, but not limited to, recruitment, hiring, upgrading, demotion, downgrading, transfer, training, rates of pay or other forms of compensation, layoff, termination, and all other terms and conditions of employment; and

36.3.2 Will not engage in any unlawful discrimination in the selection of Subcontractors on the basis of the owner's race, color, creed, national origin, sex, age, disability, marital status or sexual orientation; and

36.3.3 Will state in all solicitations or advertisements for employees placed by or on behalf of the Contractor that all qualified applicants will receive consideration for employment without unlawful discrimination based on race, creed, color, national origin, sex, age, citizens status, disability, marital status, sexual orientation, or that it is an equal employment opportunity employer; and

36.3.4 Will send to each labor organization or representative of workers with which it has a collective bargaining agreement or other contract or memorandum of understanding, written notification of its equal employment opportunity commitments under E.O. 50 and the rules and regulations promulgated thereunder; and

36.3.5 Will furnish, before the award of the Contract, all information and reports, including an employment report, that are required by E.O. 50, the rules and regulations promulgated thereunder, and orders of the City Department of Business Services, Division of Labor Services (DLS) and will permit access to its books, records, and accounts by the DLS for the purposes of investigation to ascertain compliance with such rules, regulations, and orders.

36.4 The Contractor understands that in the event of its noncompliance with the nondiscrimination clauses of this Contract or with any of such rules, regulations, or orders, such noncompliance shall constitute a material breach of this Contract and noncompliance with E.O. 50 and the rules and regulations promulgated thereunder. After a hearing held pursuant to the rules of the DLS, the Director of the DLS may direct the Commissioner to impose any or all of the following sanctions:

36.4.1 Disapproval of the Contractor; and/or

36.4.2 Suspension or termination of the Contract; and/or

36.4.3 Declaring the Contractor in default; and/or

36.4.4 In lieu of any of the foregoing sanctions, the Director of the DLS may impose an employment program.

In addition to any actions taken under this Contract, failure to comply with E.O. 50 and the rules and regulations promulgated thereunder, in one or more instances, may result in a City Agency declaring the Contractor to be non-responsible in future procurements. The Contractor further agrees that it will refrain from entering into any Contract or Contract modification subject to E.O. 50 and the rules and regulations promulgated thereunder with a Subcontractor who is not in compliance with the requirements of E.O. 50 and the rules and regulations promulgated thereunder.

36.5 The Contractor specifically agrees, as required by Section 6-123 of the Administrative Code, that:

36.5.1 The Contractor will not engage in any unlawful discriminatory practice in violation of Title 8 of the Administrative Code; and

36.5.2 Any failure to comply with this Article 36.5 may subject the Contractor to the remedies set forth in Section 6-123 of the Administrative Code, including, where appropriate, sanctions such as withholding of payment, imposition of an employment program, finding the Contractor to be in default, cancellation of the Contract, or any other sanction or remedy provided by Law or Contract.

#### ARTICLE 37. LABOR LAW REQUIREMENTS

37.1 The Contractor shall strictly comply with all applicable provisions of the Labor Law, as amended. Such compliance is a material term of this Contract.

37.2 The Contractor specifically agrees, as required by Labor Law Sections 220 and 220-d, as amended, that:

37.2.1 **Hours of Work:** No laborer, worker, or mechanic in the employ of the Contractor, Subcontractor or other person doing or contracting to do the whole or a part of the Work contemplated by this Contract shall be permitted or required to work more than eight (8) hours in any one (1) Day, or more than five (5) Days in any one (1) week, except as provided in the Labor Law and in cases of extraordinary emergency including fire, flood, or danger to life or property, or in the case of national emergency when so proclaimed by the President of the United States of America.

37.2.2 In situations in which there are not sufficient laborers, workers, and mechanics who may be employed to carry on expeditiously the Work contemplated by this Contract as a result of such restrictions upon the number of hours and Days of labor, and the immediate commencement or prosecution or completion without undue delay of the Work is necessary for the preservation of the Site and/or for the protection of the life and limb of the persons using the same, such laborers, workers, and mechanics shall be permitted or required to work more than eight (8) hours in any one (1) Day; or five (5) Days in any one (1) week; provided, however, that upon application of any Contractor, the Commissioner shall have first certified to the Commissioner of Labor of the State of New York (hereinafter "Commissioner of Labor") that such public Work is of an important nature and that a delay in carrying it to completion would result in serious disadvantage to the public; and provided, further, that such Commissioner of Labor shall have determined that such an emergency does in fact exist as provided in Labor Law Section 220.2.

37.2.3 Failure of the Commissioner to make such a certification to the Commissioner of Labor shall not entitle the Contractor to damages for delay or for any cause whatsoever.

37.2.4 **Prevailing Rate of Wages:** The wages to be paid for a legal day's Work to laborers, workers, or mechanics employed upon the Work contemplated by this Contract or upon any materials to be used thereon shall not be less than the "prevailing rate of wage" as defined in Labor Law Section 220, and as fixed by the Comptroller in the attached Schedule of Wage Rates and in updated schedules thereof. The prevailing wage rates and supplemental benefits to be paid are those in effect at the time the Work is being performed.

37.2.5 Requests for interpretation or correction in the Information for Bidders includes all requests for clarification of the classification of trades to be employed in the performance of the Work under this Contract. In the event that a trade not listed in the Contract is in fact employed during the performance of this Contract, the Contractor shall be required to obtain from the Agency the prevailing wage rates and supplementary benefits for the trades used and to complete the performance of this Contract at the price at which the Contract was awarded.

37.2.6 **Minimum Wages:** Except for employees whose wage is required to be fixed pursuant to Labor Law Section 220, all persons employed by the Contractor and any Subcontractor in the manufacture or furnishing of the supplies, materials, or equipment, or the furnishing of work, labor, or services, used in the performance of this Contract, shall be paid, without subsequent deduction or rebate unless expressly authorized by Law, not less than the sum mandated by Law.

37.3 **Working Conditions:** No part of the Work, labor or services shall be performed or rendered by the Contractor in any plants, factories, buildings or surroundings or under working conditions which are unsanitary or hazardous or dangerous to the health and safety of employees engaged in the performance of this Contract. Compliance with the safety, sanitary, and factory inspection Laws of the state in which the Work is to be performed shall be prima facie evidence of compliance with this Article 37.3.

37.4 **Prevailing Wage Enforcement:** The Contractor agrees to pay for all costs incurred by the City in enforcing prevailing wage requirements, including the cost of any investigation conducted by or on behalf of the Agency or the Comptroller, where the City discovers a failure to comply with any of the requirements of this Article 37 by the Contractor or its Subcontractor(s). The Contractor also agrees that, should it fail or refuse to pay for any such investigation, the Agency is hereby authorized to deduct from a Contractor's account an amount equal to the cost of such investigation.

37.4.1 The Labor Law Section 220 and Section 220-d, as amended, provide that this Contract shall be forfeited and no sum paid for any Work done hereunder on a second conviction for willfully paying less than:

37.4.1(a) The stipulated prevailing wage scale as provided in Labor Law section 220, as amended, or

37.4.1(b) The stipulated minimum hourly wage scale as provided in Labor Law section 220-d, as amended.

37.4.2 For any breach or violation of either working conditions (Article 37.3) or minimum wages (Article 37.2.6) provisions, the party responsible therefor shall be liable to the City for liquidated damages, which may be withheld from any amounts due on any contracts with the City of such party responsible, or may be recovered in actions brought by the City

Corporation Counsel in the name of the City, in addition to damages for any other breach of this Contract, for a sum equal to the amount of any underpayment of wages due to any employee engaged in the performance of this Contract. In addition, the Commissioner shall have the right to cancel contracts and enter into other contracts for the completion of the original contract, with or without public letting, and the original Contractor shall be liable for any additional cost. All sums withheld or recovered as deductions, rebates, refunds, or underpayment of wages hereunder, shall be held in a special deposit account and shall be paid without interest, on order of the Comptroller, directly to the employees who have been paid less than minimum rates of pay as set forth herein and on whose account such sums were withheld or recovered, provided that no claims by employees for such payments shall be entertained unless made within two (2) years from the date of actual notice to the Contractor of the withholding or recovery of such sums by the City.

37.4.3 A determination by the Comptroller that a Contractor and/or its Subcontractor willfully violated Labor Law Section 220 will be forwarded to the City's five District Attorneys for review.

37.4.4 The Contractor's or Subcontractor's noncompliance with this Article 37.4 and Labor Law Section 220 may result in an unsatisfactory performance evaluation and the Comptroller may also find and determine that the Contractor or Subcontractor willfully violated the New York Labor Law.

37.4.4(a) An unsatisfactory performance evaluation for noncompliance with this Article 37.4 may result in a determination that the Contractor is a non-responsible bidder on subsequent procurements with the City and thus a rejection of a future award of a contract with the City, as well as any other sanctions provided for by Law.

37.4.4(b) Labor Law Section 220-b, as amended, provides that when two (2) final determinations have been rendered against a Contractor or Subcontractor within any consecutive six (6) year period determining that such Contractor or Subcontractor has willfully failed to pay the prevailing rate of wages or to provide supplements in accordance with the Labor Law and this Article 37.4, whether such failures were concurrent or consecutive and whether or not such final determinations concerning separate public works projects are rendered simultaneously, such Contractor or Subcontractor shall be ineligible to submit a bid on or be awarded any public works contract with the City for a period of five (5) years from the second final determination. If the final determination involves the falsification of payroll records or the kickback of wages or supplements, the Contractor or Subcontractor shall be ineligible to submit a bid on or be awarded any public works contract with the City for a period of five (5) years from the first final determination.

37.4.4(c) Labor Law Section 220, as amended, provides that the Contractor or Subcontractor found to have violated this Article 37.4 may be directed to make payment of wages or supplements including interest found to be due, and the Contractor or Subcontractor may be directed to make payment of a further sum as a civil penalty in an amount not exceeding twenty-five (25%) percent of the total amount found to be due.

37.5 The Contractor and its Subcontractors shall within ten (10) Days after mailing of a Notice of Award or written order, post in prominent and conspicuous places in each and every plant, factory, building, and structure where employees of the Contractor and its Subcontractors engaged in the

performance of this Contract are employed, notices furnished by the City, in relation to prevailing wages and supplements, minimum wages, and other stipulations contained in Sections 220 and 220-h of the Labor Law, and the Contractor and its Subcontractors shall continue to keep such notices posted in such prominent and conspicuous places until Final Acceptance of the supplies, materials, equipment, or Work, labor, or services required to be furnished or rendered under this Contract.

37.6 The Contractor shall strictly comply with all of the provisions of Articles 37.6.1 through 37.6.5, and provide for all workers, laborers or mechanics in its employ, the following:

37.6.1 Notices Posted At Site: Post, in a location designated by the City, schedules of prevailing wages and supplements for this Project, a copy of all re-determinations of such schedules for the Project, the Workers' Compensation Law Section 51 notice, all other notices required by Law to be posted at the Site, the City notice that this Project is a public works project on which each worker is entitled to receive the prevailing wages and supplements for the occupation at which he or she is working, and all other notices which the City directs the Contractor to post. The Contractor shall provide a surface for such notices which is satisfactory to the City. The Contractor shall maintain and keep current such notices in a legible manner and shall replace any notice or schedule which is damaged, defaced, illegible or removed for any reason. The Contractor shall post such notices before commencing any Work on the Site and shall maintain such notices until all Work on the Site is complete; and

37.6.2 Daily Site Sign-in Sheets: Maintain daily Site sign-in sheets, and require that Subcontractors maintain daily Site sign-in sheets for its employees, which include blank spaces for an employee's name to be both printed and signed, job title, date started and Social Security number, the time the employee began work and the time the employee left work, until Final Acceptance of the supplies, materials, equipment, or Work, labor, or services to be furnished or rendered under this Contract unless exception is granted by the Comptroller upon application by the Agency. In the alternative, subject to the approval of the CCPO, the Contractor and Subcontractor may maintain an electronic or biometric sign-in system, which provides the information required by this Article 37.6.2; and

37.6.3 Individual Employee Information Notices: Distribute a notice to each worker, laborer or mechanic employed under this Contract, in a form provided by the Agency, that this Project is a public works project on which each worker, laborer or mechanic is entitled to receive the prevailing rate of wages and supplements for the occupation at which he or she is working. If the total cost of the Work under this Contract is at least two hundred fifty thousand (\$250,000) dollars, such notice shall also include a statement that each worker, laborer or mechanic must be certified prior to performing any Work as having successfully completed a course in construction safety and health approved by the United States Department of Labor's Occupational Safety and Health Administration that is at least ten (10) hours in duration. Such notice shall be distributed to each worker before he or she starts performing any Work of this Contract and with the first paycheck after July first of each year. "Worker, laborer or mechanic" includes employees of the Contractor and all Subcontractors and all employees of suppliers entering the Site. At the time of distribution, the Contractor shall have each worker, laborer or mechanic sign a statement, in a form provided by the Agency, certifying that the worker has received the notice required by this Article 37.6.3, which signed statement shall be maintained with the payroll records required by this Contract; and

37.6.3(a) The Contractor and each Subcontractor shall notify each worker, laborer or mechanic employed under this Contract in writing of the prevailing rate of



wages for their particular job classification. Such notification shall be given to every worker, laborer, and mechanic on their first pay stub and with every pay stub thereafter; and

**37.6.4 Site Laminated Identification Badges:** The Contractor shall provide laminated identification badges which include a photograph of the worker's, laborer's or mechanic's face and indicate the worker's, laborer's or mechanic's name, trade, employer's name, and employment starting date (month/day/year). Further, the Contractor shall require as a condition of employment on the Site, that each and every worker, laborer or mechanic wear the laminated identification badge at all times and that it may be seen by any representative of the City. The Commissioner may grant a written waiver from the requirement that the laminated identification badge include a photograph if the Contractor demonstrates that the identity of an individual wearing a laminated identification badge can be easily verified by another method; and

**37.6.5 Language Other Than English Used On Site:** Provide the ACCO notice when three (3) or more employees (worker and/or laborer and/or mechanic) on the Site, at any time, speak a language other than English. The ACCO will then provide the Contractor the notices described in Article 37.6.1 in that language or languages as may be required. The Contractor is responsible for all distributions under this Article 37; and

**37.6.6 Provision of Records:** The Contractor and Subcontractor(s) shall produce within five (5) Days on the Site of the Work and upon a written order of the Engineer, the Commissioner, the ACCO, the Agency EAO, or the Comptroller, such records as are required to be kept by this Article 37.6; and

**37.6.7 The Contractor and Subcontractor(s) shall pay employees by check or direct deposit.** If this Contract is for an amount greater than one million (\$1,000,000) dollars, checks issued by the Contractor to covered employees shall be generated by a payroll service or automated payroll system (an in-house system may be used if approved by the Agency). For any subcontract for an amount greater than seven hundred fifty thousand (\$750,000) dollars, checks issued by a Subcontractor to covered employees shall be generated by a payroll service or automated payroll system (an in-house system may be used if approved by the Agency); and

**37.6.8 The failure of the Contractor or Subcontractor(s) to comply with the provisions of Articles 37.6.1 through 37.6.7 may result in the Commissioner declaring the Contractor in default and/or the withholding of payments otherwise due under the Contract.**

**37.7 The Contractor and its Subcontractors shall keep such employment and payroll records as are required by Section 220 of the Labor Law. The failure of the Contractor or Subcontractor(s) to comply with the provisions of this Article 37.7 may result in the Commissioner declaring the Contractor in default and/or the withholding of payments otherwise due under the Contract.**

**37.8 At the time the Contractor makes application for each partial payment and for final payment, the Contractor shall submit to the Commissioner a written payroll certification, in the form provided by this Contract, of compliance with the prevailing wage, minimum wage, and other provisions and stipulations required by Labor Law Section 220 and of compliance with the training requirements of Labor Law Section 220-h set forth in Article 35.2. This certification of compliance shall be a condition precedent to payment and no payment shall be made to the Contractor unless and until each such certification shall have been submitted to and received by the Commissioner.**

37.9 This Contract is executed by the Contractor with the express warranty and representation that the Contractor is not disqualified under the provisions of Section 220 of the Labor Law from the award of the Contract.

37.10 Any breach or violation of any of the foregoing shall be deemed a breach or violation of a material provision of this Contract, and grounds for cancellation thereof by the City.

#### **ARTICLE 38. PAYROLL REPORTS**

38.1 The Contractor and its Subcontractor(s) shall maintain on the Site during the performance of the Work the original payrolls or transcripts thereof which the Contractor and its Subcontractor(s) are required to maintain and shall submit such original payrolls or transcripts, subscribed and affirmed by it as true, within thirty (30) Days after issuance of its first payroll, and every thirty (30) Days thereafter, pursuant to Labor Law Section 220(3-a)(a)(iii). The Contractor and Subcontractor(s) shall submit such original payrolls or transcripts along with each and every payment requisition. If payment requisitions are not submitted at least once a month, the Contractor and its Subcontractor(s) shall submit original payrolls and transcripts both along with its payment requisitions and independently of its payment requisitions.

38.2 The Contractor shall maintain payrolls or transcripts thereof for six (6) years from the date of completion of the Work on this Contract. If such payrolls and transcripts are maintained outside of New York City after the completion of the Work and their production is required pursuant to this Article 38, the Contractor shall produce such records in New York City upon request by the City.

38.3 The Contractor and Subcontractor(s) shall comply with any written order, direction, or request made by the Engineer, the Commissioner, the ACCO, the Agency EAO, the Agency Labor Law Investigator(s), or the Comptroller, to provide to the requesting party any of the following information and/or records within five (5) Days of such written order, direction, or request:

38.3.1 Such original payrolls or transcripts thereof subscribed and affirmed by it as true and the statements signed by each worker pursuant to this Chapter VIII; and/or

38.3.2 Attendance sheets for each Day on which any employee of the Contractor and/or any of the Subcontractor(s) performed Work on the Site, which attendance sheet shall be in a form acceptable to the Agency and shall provide information acceptable to the Agency to identify each such employee; and/or

38.3.3 Any other information to satisfy the Engineer, the Commissioner, the ACCO, the Agency EAO, the Agency Labor Law Investigator(s) or the Comptroller, that this Chapter VIII and the Labor Law, as to the hours of employment and prevailing rates of wages and/or supplemental benefits, are being observed.

38.4 The failure of the Contractor or Subcontractor(s) to comply with the provisions of Articles 38.1 and/or 38.2 may result in the Commissioner declaring the Contractor in default and/or the withholding of payments otherwise due under the Contract.

#### **ARTICLE 39. DUST HAZARDS**

39.1 Should a harmful dust hazard be created in performing the Work of this Contract, for the elimination of which appliances or methods have been approved by the Board of Standards and Appeals

of the City of New York, such appliances and methods shall be installed, maintained, and effectively operated during the continuance of such harmful dust hazard. Failure to comply with this provision after notice shall make this Contract voidable at the sole discretion of the City.

## **CHAPTER IX: PARTIAL AND FINAL PAYMENTS**

### **ARTICLE 40. CONTRACT PRICE**

40.1 The City shall pay, and the Contractor agrees to accept, in full consideration for the Contractor's performance of the Work subject to the terms and conditions hereof, the lump sum price or unit prices for which this Contract was awarded, plus the amount required to be paid for any Extra Work ordered by the Commissioner under Article 25, less credit for any Work omitted pursuant to Article 29.

### **ARTICLE 41. BID BREAKDOWN ON LUMP SUM**

41.1 Within fifteen (15) Days after the commencement date specified in the Notice to Proceed or Order to Work, unless otherwise directed by the Resident Engineer, the Contractor shall submit to the Resident Engineer a breakdown of its bid price, or of lump sums bid for items of the Contract, showing the various operations to be performed under the Contract, as directed in the progress schedule required under Article 9, and the value of each of such operations, the total of such items to equal the lump sum price bid. Said breakdown must be approved in writing by the Resident Engineer.

41.2 No partial payment will be approved until the Contractor submits a bid breakdown that is acceptable to the Resident Engineer.

41.3 The Contractor shall also submit such other information relating to the bid breakdown as directed by the Resident Engineer. Thereafter, the breakdown may be used only for checking the Contractor's applications for partial payments hereunder, but shall not be binding upon the City, the Commissioner, or the Engineer for any purpose whatsoever.

### **ARTICLE 42. PARTIAL PAYMENTS**

42.1 From time to time as the Work progresses satisfactorily, but not more often than once each calendar month (except where the Commissioner approves in writing the submission of invoices on a more frequent basis and for invoices relating to Work performed pursuant to a change order), the Contractor may submit to the Engineer a requisition for a partial payment in the prescribed form, which shall contain an estimate of the quantity and the fair value of the Work done during the payment period.

42.2 Partial payments may be made for materials, fixtures, and equipment in advance of their actual incorporation in the Work, as the Commissioner may approve, and upon the terms and conditions set forth in the General Conditions.

42.3 The Contractor shall also submit to the Commissioner in connection with every application for partial payment a verified statement in the form prescribed by the Comptroller setting forth the information required under Labor Law Section 220-a.

42.4 Within thirty (30) Days after receipt of a satisfactory payment application, and within sixty (60) Days after receipt of a satisfactory payment application in relation to Work performed pursuant to a change order, the Engineer will prepare and certify, and the Commissioner will approve, a voucher for a partial payment in the amount of such approved estimate, less any and all deductions authorized to be made by the Commissioner under the terms of this Contract or by Law.

#### **ARTICLE 43. PROMPT PAYMENT**

43.1 The Prompt Payment provisions of the PPB Rules in effect at the time of the bid will be applicable to payments made under this Contract. The provisions require the payment to the Contractor of interest on payments made after the required payment date, except as set forth in the PPB Rules.

43.2 The Contractor shall submit a proper invoice to receive payment, except where the Contract provides that the Contractor will be paid at predetermined intervals without having to submit an invoice for each scheduled payment.

43.3 Determination of interest due will be made in accordance with the PPB Rules.

43.4 If the Contractor is paid interest, the proportionate share(s) of that interest shall be forwarded by the Contractor to its Subcontractor(s).

43.5 The Contractor shall pay each Subcontractor or Materialman not later than seven (7) Days after receipt of payment out of amounts paid to the Contractor by the City for Work performed by the Subcontractor or Materialman under this Contract.

43.5.1 If Contractor fails to make any payment to any Subcontractor or Materialman within seven (7) Days after receipt of payment by the City pursuant to this Article 43.5, then the Contractor shall pay interest on amounts due to such Subcontractor or Materialman at the rate of interest in effect on the date such payment is made by the Contractor computed in accordance with Section 756-b (1)(b) of the New York General Business Law. Accrual of interest shall commence on the Day immediately following the expiration of the seventh Day following receipt of payment by the Contractor from the City and shall end on the date on which payment is made.

43.6 The Contractor shall include in each of its subcontracts a provision requiring each Subcontractor to make payment to each of its Subcontractors or Materialmen for Work performed under this Contract in the same manner and within the same time period set forth above.

#### **ARTICLE 44. SUBSTANTIAL COMPLETION PAYMENT**

44.1 The Contractor shall submit with the Substantial Completion requisition:

44.1.1 A final verified statement of any pending Article 27 disputes in accordance with the PPB Rules and this Contract and any and all alleged claims against the City, in any way connected with or arising out of this Contract (including those as to which details may have been furnished pursuant to Articles 11, 27, 28, and 30) setting forth with respect to each such claim the total amount thereof, the various items of labor and materials included therein, and the alleged value of each item; and if the alleged claim be one for delay, the alleged cause of each such delay, the period or periods of time, giving the dates when the

**Contractor** claims the performance of the **Work** or a particular part thereof was delayed, and an itemized statement and breakdown of the amount claimed for each such delay.

44.1.1(a) With respect to each such claim, the **Commissioner**, the **Comptroller** and, in the event of litigation, the **City Corporation Counsel** shall have the same right to inspect, and to make extracts or copies of, the **Contractor's** books, vouchers, records, etc., as is referred to in Articles 11, 27, 28, and 30. Nothing contained in this Article 44.1.1(a) is intended to or shall relieve the **Contractor** from the obligation of complying strictly with Articles 11, 27, 28, and 30. The **Contractor** is warned that unless such claims are completely set forth as herein required, the **Contractor** upon acceptance of the **Substantial Completion** payment pursuant to this Article 44, will have waived any such claims.

44.1.2 A **Final Approved Punch List**.

44.1.3 Where required, a request for an extension of time to achieve **Substantial Completion** or final extension of time.

44.2 The **Commissioner** shall issue a voucher calling for payment of any part or all of the balance due for **Work** performed under the **Contract**, including monies retained under Article 21, less any and all deductions authorized to be made by the **Commissioner**, under this **Contract** or by **Law**, and less twice the amount the **Commissioner** considers necessary to ensure the completion of the balance of the **Work** by the **Contractor**. Such a payment shall be considered a partial and not a final payment. No **Substantial Completion** payment shall be made under this Article 44 where the **Contractor** failed to complete the **Work** within the time fixed for such completion in the Schedule A of the General Conditions, or within the time to which completion may have been extended, until an extension or extensions of time for the completion of **Work** have been acted upon pursuant to Article 13.

44.3 No further partial payments shall be made to the **Contractor** after **Substantial Completion**, except the **Substantial Completion** payment and payment pursuant to any **Contractor's** requisition that were properly filed with the **Commissioner** prior to the date of **Substantial Completion**; however, the **Commissioner** may grant a waiver for further partial payments after the date of **Substantial Completion** to permit payments for change order **Work** and/or release of retainage and deposits pursuant to Articles 21 and 24. Such waiver shall be in writing.

44.4 The **Contractor** acknowledges that nothing contained in this Article 44 is intended to or shall in any way diminish the force and effect of Article 13.

#### **ARTICLE 45. FINAL PAYMENT**

45.1 After completion and **Final Acceptance** of the **Work**, the **Contractor** shall submit all required certificates and documents, together with a requisition for the balance claimed to be due under the **Contract**, less the amount authorized to be retained for maintenance under Article 24. Such submission shall be within 90 days of the date of the **Commissioner's** written determination of **Final Acceptance**, or within such additional time as may be granted by the **Commissioner** in writing. If the **Contractor** fails to submit all required certificates and documents within the time allowed, no payment of the balance claimed shall be made to the **Contractor** and the **Contractor** shall be deemed to have forfeited its right to payment of any balance claimed. A verified statement similar to that required in connection with applications for partial payments shall also be submitted to the **Commissioner**.

45.2 Amended Verified Statement of Claims: The Contractor shall also submit with the final requisition any amendments to the final verified statement of any pending dispute resolution procedures in accordance with the PPB Rules and this Contract and any and all alleged claims against the City, in any way connected with or arising out of this Contract (including those as to which details may have been furnished pursuant to Articles 11, 27, 28, and 30) that have occurred subsequent to Substantial Completion, setting forth with respect to each such claim the total amount thereof, the various items of labor and materials included therein, and the alleged value of each such item; and if the alleged claim be one for delay, the alleged cause of each such delay, the period or periods of time, giving the dates when the Contractor claims the performance of the Work or a particular part thereof was delayed, and an itemized statement and breakdown of the amount claimed for each such delay. With reference to each such claim, the Commissioner, the Comptroller and, in the event of litigation, the City Corporation Counsel shall have the same right to inspect, and to make extracts or copies of, the Contractor's books, vouchers, records, etc., as is referred to in Articles 11, 27, 28, and 30. Nothing contained in this Article 45.2, is intended to or shall relieve the Contractor from the obligation of complying strictly with Articles 11, 27, 28, and 30. The Contractor is warned that unless such claims are completely set forth as herein required, the Contractor, upon acceptance of the Final Payment pursuant to Article 46, will have waived any such claims.

45.3 Preparation of Final Voucher: Upon determining the balance due hereunder other than on account of claims, the Engineer will prepare and certify, for the Commissioner's approval, a voucher for final payment in that amount less any and all deductions authorized to be made by the Commissioner under this Contract or by Law. In the case of a lump sum Contract, the Commissioner shall certify the voucher for final payment within thirty (30) Days from the date of completion and acceptance of the Work, provided all requests for extensions of time have been acted upon.

45.3.1 All prior certificates and vouchers upon which partial payments were made, being merely estimates made to enable the Contractor to prosecute the Work more advantageously, shall be subject to correction in the final voucher, and the certification of the Engineer thereon and the approval of the Commissioner thereof, shall be conditions precedent to the right of the Contractor to receive any money hereunder. Such final voucher shall be binding and conclusive upon the Contractor.

45.3.2 Payment pursuant to such final voucher, less any deductions authorized to be made by the Commissioner under this Contract or by Law, shall constitute the final payment, and shall be made by the Comptroller within thirty (30) Days after the filing of such voucher in his/her office.

45.4 The Contractor acknowledges that nothing contained in this Article 45 is intended to or shall in any way diminish the force and effect of Article 13.

#### **ARTICLE 46. ACCEPTANCE OF FINAL PAYMENT**

46.1 The acceptance by the Contractor, or by anyone claiming by or through it, of the final payment, whether such payment be made pursuant to any judgment of any court, or otherwise, shall constitute and operate as a release of the City from any and all claims of and liability to the Contractor for anything heretofore done or furnished for the Contractor relating to or arising out of this Contract and the Work done hereunder, and for any prior act, neglect or default on the part of the City or any of its officials, agents or employees, excepting only a claim against the City for the amounts deducted or retained in accordance with the terms and provisions of this Contract or by Law, and excepting any claims, not otherwise waived, or any pending dispute resolution procedures which are contained in the

verified statement filed with the **Contractor's** substantial and final requisitions pursuant to Articles 44 and 45.

46.2 The **Contractor** is warned that the execution by it of a release, in connection with the acceptance of the final payment, containing language purporting to reserve claims other than those herein specifically excepted from the operation of this Article 46, or those for amounts deducted by the **Commissioner** from the final requisition or from the final payment as certified by the **Engineer** and approved by the **Commissioner**, shall not be effective to reserve such claims, anything stated to the **Contractor** orally or in writing by any official, agent or employee of the **City** to the contrary notwithstanding.

46.3 Should the **Contractor** refuse to accept the final payment as tendered by the **Comptroller**, it shall constitute a waiver of any right to interest thereon.

46.4 The **Contractor**, however, shall not be barred by this Article 46 from commencing an action for breach of **Contract** to the extent permitted by **Law** and by the terms of the **Contract** for any claims that are contained in the verified statement filed with the **Contractor's** substantial and final requisitions pursuant to Articles 44 and 45 or that arose after submission of the final payment requisition, provided that a detailed and verified statement of claim is served upon the contracting **Agency** and **Comptroller** not later than forty (40) **Days** after the making of such final payment by electronic funds transfer (EFT) or the mailing of such final payment. The statement shall specify the items upon which the claim will be based and any such claim shall be limited to such items.

#### **ARTICLE 47. APPROVAL BY PUBLIC DESIGN COMMISSION**

47.1 All works of art, including paintings, mural decorations, stained glass, statues, bas-reliefs, and other sculptures, monuments, fountains, arches, and other structures of a permanent character intended for ornament or commemoration, and every design of the same to be used in the performance of this **Contract**, and the design of all bridges, approaches, buildings, gates, fences, lamps, or structures to be erected, pursuant to the terms of this **Contract**, shall be submitted to the Art Commission, d/b/a the Public Design Commission of the **City of New York**, and shall be approved by the Public Design Commission prior to the erection or placing in position of the same. The final payment shall not become due or payable under this **Contract** unless and until the Public Design Commission shall certify that the design for the **Work** herein contracted for has been approved by the said Public Design Commission, and that the same has been executed in substantial accordance with the design so approved, pursuant to the provisions of Chapter 37, Section 854 of the **City Charter**, as amended.

### **CHAPTER X: CONTRACTOR'S DEFAULT**

#### **ARTICLE 48. COMMISSIONER'S RIGHT TO DECLARE CONTRACTOR IN DEFAULT**

48.1 In addition to those instances specifically referred to in other Articles herein, the **Commissioner** shall have the right to declare the **Contractor** in default of this **Contract** if:

48.1.1 The **Contractor** fails to commence **Work** when notified to do so by the **Commissioner**; or if

48.1.2 The **Contractor** shall abandon the **Work**; or if

48.1.3 The Contractor shall refuse to proceed with the Work when and as directed by the Commissioner; or if

48.1.4 The Contractor shall, without just cause, reduce its working force to a number which, if maintained, would be insufficient, in the opinion of the Commissioner, to complete the Work in accordance with the progress schedule; or if

48.1.5 The Contractor shall fail or refuse to increase sufficiently such working force when ordered to do so by the Commissioner; or if

48.1.6 The Contractor shall sublet, assign, transfer, convert or otherwise dispose of this Contract other than as herein specified; or sell or assign a majority interest in the Contractor; or if

48.1.7 The Contractor fails to secure and maintain all required insurance; or if

48.1.8 A receiver or receivers are appointed to take charge of the Contractor's property or affairs; or if

48.1.9 The Commissioner shall be of the opinion that the Contractor is or has been unnecessarily or unreasonably or willfully delaying the performance and completion of the Work, or the award of necessary subcontracts, or the placing of necessary material and equipment orders; or if

48.1.10 The Commissioner shall be of the opinion that the Contractor is or has been willfully or in bad faith violating any of the provisions of this Contract; or if

48.1.11 The Commissioner shall be of the opinion that the Work cannot be completed within the time herein provided therefor or within the time to which such completion may have been extended; provided, however, that the impossibility of timely completion is, in the Commissioner's opinion, attributable to conditions within the Contractor's control; or if

48.1.12 The Work is not completed within the time herein provided therefor or within the time to which the Contractor may be entitled to have such completion extended; or if

48.1.13 Any statement or representation of the Contractor in the Contract or in any document submitted by the Contractor with respect to the Work, the Project, or the Contract (or for purposes of securing the Contract) was untrue or incorrect when made; or if

48.1.14 The Contractor or any of its officers, directors, partners, five (5%) percent shareholders, principals, or other persons substantially involved in its activities, commits any of the acts or omissions specified as the grounds for debarment in the PPB Rules.

48.2 Before the Commissioner shall exercise his/her right to declare the Contractor in default, the Commissioner shall give the Contractor an opportunity to be heard, upon not less than two (2) Days' notice.



#### **ARTICLE 49. EXERCISE OF THE RIGHT TO DECLARE DEFAULT**

49.1 The right to declare the Contractor in default for any of the grounds specified or referred to in Article 48 shall be exercised by sending the Contractor a notice, signed by the Commissioner, setting forth the ground or grounds upon which such default is declared (hereinafter referred to as a "Notice of Default").

49.2 The Commissioner's determination that the Contractor is in default shall be conclusive, final, and binding on the parties and such a finding shall preclude the Contractor from commencing a plenary action for any damages relating to the Contract. If the Contractor protests the determination of the Commissioner, the Contractor may commence an action in a court of competent jurisdiction of the State of New York under Article 78 of the New York Civil Practice Law and Rules.

#### **ARTICLE 50. QUITTING THE SITE**

50.1 Upon receipt of such notice the Contractor shall immediately discontinue all further operations under this Contract and shall immediately quit the Site, leaving untouched all plant, materials, equipment, tools, and supplies then on the Site.

#### **ARTICLE 51. COMPLETION OF THE WORK**

51.1 The Commissioner, after declaring the Contractor in default, may then have the Work completed by such means and in such manner, by contract with or without public letting, or otherwise, as he/she may deem advisable, utilizing for such purpose such of the Contractor's plant, materials, equipment, tools, and supplies remaining on the Site, and also such Subcontractors, as he/she may deem advisable.

51.2 After such completion, the Commissioner shall make a certificate stating the expense incurred in such completion, which shall include the cost of re-letting and also the total amount of liquidated damages (at the rate provided for in the Contract) from the date when the Work should have been completed by the Contractor in accordance with the terms hereof to the date of actual completion of the Work. Such certificate shall be binding and conclusive upon the Contractor, its sureties, and any person claiming under the Contractor, as to the amount thereof.

51.3 The expense of such completion, including any and all related and incidental costs, as so certified by the Commissioner, and any liquidated damages assessed against the Contractor, shall be charged against and deducted out of monies which are earned by the Contractor prior to the date of default. Should the expense of such completion, as certified by the Commissioner, exceed the total sum which would have been payable under the Contract if it had been completed by the Contractor, any excess shall be paid by the Contractor.

#### **ARTICLE 52. PARTIAL DEFAULT**

52.1 In case the Commissioner shall declare the Contractor in default as to a part of the Work only, the Contractor shall discontinue such part, shall continue performing the remainder of the Work in strict conformity with the terms of this Contract, and shall in no way hinder or interfere with any Other Contractor(s) or persons whom the Commissioner may engage to complete the Work as to which the Contractor was declared in default.

52.2 The provisions of this Chapter relating to declaring the Contractor in default as to the entire Work shall be equally applicable to a declaration of partial default, except that the Commissioner shall be entitled to utilize for completion of the part of the Work as to which the Contractor was declared in default only such plant, materials, equipment, tools, and supplies as had been previously used by the Contractor on such part.

#### **ARTICLE 53. PERFORMANCE OF UNCOMPLETED WORK**

53.1 In completing the whole or any part of the Work under the provisions of this Chapter X, the Commissioner shall have the power to depart from or change or vary the terms and provisions of this Contract, provided, however, that such departure, change or variation is made for the purpose of reducing the time or expense of such completion. Such departure, change or variation, even to the extent of accepting a lesser or different performance, shall not affect the conclusiveness of the Commissioner's certificate of the cost of completion referred to in Article 51, nor shall it constitute a defense to an action to recover the amount by which such certificate exceeds the amount which would have been payable to the Contractor hereunder but for its default.

#### **ARTICLE 54. OTHER REMEDIES**

54.1 In addition to the right to declare the Contractor in default pursuant to this Chapter X, the Commissioner shall have the absolute right, in his/her sole discretion and without a hearing, to complete or cause to be completed in the same manner as described in Articles 51 and 53, any or all unsatisfactory or uncompleted punch list Work that remains after the completion date specified in the Final Approved Punch List. A written notice of the exercise of this right shall be sent to the Contractor who shall immediately quit the Site in accordance with the provisions of Article 50.

54.2 The expense of completion permitted under Article 54.1, including any and all related and incidental costs, as so certified by the Commissioner, shall be charged against and deducted out of monies which have been earned by the Contractor prior to the date of the exercise of the right set forth in Article 54.1; the balance of such monies, if any, subject to the other provisions of this Contract, to be paid to the Contractor without interest after such completion. Should the expense of such completion, as certified by the Commissioner, exceed the total sum which would have been payable under the Contract if it had been completed by the Contractor, any excess shall be paid by the Contractor.

54.3 The previous provisions of this Chapter X shall be in addition to any and all other remedies available under Law or in equity.

54.4 The exercise by the City of any remedy set forth herein shall not be deemed a waiver by the City of any other legal or equitable remedy contained in this Contract or provided under Law.

### **CHAPTER XI: MISCELLANEOUS PROVISIONS**

#### **ARTICLE 55. CONTRACTOR'S WARRANTIES**

55.1 In consideration of, and to induce, the award of this Contract to the Contractor, the Contractor represents and warrants:

55.1.1 That it is financially solvent, sufficiently experienced and competent to perform the Work; and

55.1.2 That the facts stated in its bid and the information given by it pursuant to the Information for Bidders is true and correct in all respects; and

55.1.3 That it has read and complied with all requirements set forth in the Contract.

#### **ARTICLE 56. CLAIMS AND ACTIONS THEREON**

56.1 Any claim, that is not subject to dispute resolution under the PPB Rules or this Contract, against the City for damages for breach of Contract shall not be made or asserted in any action, unless the Contractor shall have strictly complied with all requirements relating to the giving of notice and of information with respect to such claims, as herein before provided.

56.2 Nor shall any action be instituted or maintained on any such claims unless such action is commenced within six (6) months after Substantial Completion; except that:

56.2.1 Any claims arising out of events occurring after Substantial Completion and before Final Acceptance of the Work shall be asserted within six (6) months of Final Acceptance of the Work;

56.2.2 If the Commissioner exercises his/her right to complete or cause to complete any or all unsatisfactory or uncompleted punch list Work that remains after the completion date specified in the Final Approved Punch List pursuant to Article 54, any such action shall be commenced within six (6) months from the date the Commissioner notifies the Contractor in writing that he/she has exercised such right. Any claims for monies deducted, retained or withheld under the provisions of this Contract shall be asserted within six (6) months after the date when such monies otherwise become due and payable hereunder; and

56.2.3 If the Commissioner exercises his/her right to terminate the Contract pursuant to Article 64, any such action shall be commenced within six (6) months of the date the Commissioner exercises said right.

#### **ARTICLE 57. INFRINGEMENT**

57.1 The Contractor shall be solely responsible for and shall defend, indemnify, and hold the City harmless from any and all claims (even if the allegations of the lawsuit are without merit) and judgments for damages and from costs and expenses to which the City may be subject to or which it may suffer or incur allegedly arising out of or in connection with any infringement by the Contractor of any copyright, trade secrets, trademark or patent rights or any other property or personal right of any third party by the Contractor and/or its Subcontractors in the performance or completion of the Work. Insofar as the facts or Law relating to any claim would preclude the City from being completely indemnified by the Contractor, the City shall be partially indemnified by the Contractor to the fullest extent permitted by Law.

**ARTICLE 58. NO CLAIM AGAINST OFFICIALS, AGENTS OR EMPLOYEES**

58.1 No claim whatsoever shall be made by the Contractor against any official, agent or employee of the City for, or on account of, anything done or omitted to be done in connection with this Contract.

**ARTICLE 59. SERVICE OF NOTICES**

59.1 The Contractor hereby designates the business address, fax number, and email address specified in its bid, as the place where all notices, directions or other communications to the Contractor may be delivered, or to which they may be mailed. Any notice, direction, or communication from either party to the other shall be in writing and shall be deemed to have been given when (i) delivered personally; (ii) sent by certified mail, return receipt requested; (iii) delivered by overnight or same day courier service in a properly addressed envelope with confirmation; or (iv) sent by fax or email and, unless receipt of the fax or e-mail is acknowledged by the recipient by fax or e-mail, deposited in a post office box regularly maintained by the United States Postal Service in a properly addressed, postage pre-paid envelope.

59.2 Contractor's notice address, email address, or fax number may be changed at any time by an instrument in writing, executed and acknowledged by the Contractor, and delivered to the Commissioner.

59.3 Nothing herein contained shall, however, be deemed to preclude or render inoperative the service of any notice, direction or other communication upon the Contractor personally, or, if the Contractor is a corporation, upon any officer thereof.

**ARTICLE 60. UNLAWFUL PROVISIONS DEEMED STRICKEN FROM CONTRACT**

60.1 If this Contract contains any unlawful provision not an essential part of the Contract and which shall not appear to have been a controlling or material inducement to the making thereof, the same shall be deemed of no effect and shall, upon notice by either party, be deemed stricken from the Contract without affecting the binding force of the remainder.

**ARTICLE 61. ALL LEGAL PROVISIONS DEEMED INCLUDED**

61.1 It is the intent and understanding of the parties to this Contract that each and every provision of Law required to be inserted in this Contract shall be and is inserted herein. Furthermore, it is hereby stipulated that every such provision is to be deemed to be inserted herein, and if, through mistake or otherwise, any such provision is not inserted, or is not inserted in correct form, then this Contract shall forthwith upon the application of either party be amended by such insertion so as to comply strictly with the Law and without prejudice to the rights of either party hereunder.

**ARTICLE 62. TAX EXEMPTION**

62.1 The City is exempt from payment of Federal, State, and local taxes, including sales and compensating use taxes of the State of New York and its cities and counties on all tangible personal property sold to the City pursuant to the provisions of this Contract. These taxes are not to be included in bids. However, this exemption does not apply to tools, machinery, equipment or other property leased by or to the Contractor, Subcontractor or Materialman or to tangible personal property which, even

though it is consumed, is not incorporated into the completed **Work** (consumable supplies) and tangible personal property that the **Contractor** is required to remove from the **Site** during or upon completion of the **Work**. The **Contractor** and its **Subcontractors** and **Materialmen** shall be responsible for and pay any and all applicable taxes, including sales and compensating use taxes, on such leased tools, machinery, equipment or other property and upon all such consumable supplies and tangible personal property that the **Contractor** is required to remove from the **Site** during or upon completion of the **Work**.

62.2 The **Contractor** agrees to sell and the **City** agrees to purchase all tangible personal property, other than consumable supplies and other tangible personal property that the **Contractor** is required to remove from the **Site** during or upon completion of the **Work**, that is required, necessary or proper for or incidental to the construction of the **Project** covered by this **Contract**. The sum paid under this **Contract** for such tangible personal property shall be in full payment and consideration for the sale of such tangible personal property.

62.2.1 The **Contractor** agrees to construct the **Project** and to perform all **Work**, labor and services rendered, necessary, proper or incidental thereto for the sum shown in the bid for the performance of such **Work**, labor, and services, and the sum so paid pursuant to this **Contract** for such **Work**, labor, and services, shall be in full consideration for the performance by the **Contractor** of all its duties and obligations under this **Contract** in connection with said **Work**, labor, and services.

62.3 20 NYCRR Section 541.3(d) provides that a **Contractor's** purchases of tangible personal property that is either incorporated into real property owned by a governmental entity or purchased for and sold to a governmental entity are exempt from sales and use tax. The **City** shall not pay sales tax for any such tangible personal property that it purchases from the **Contractor** pursuant to the **Contract**. With respect to such tangible personal property, the **Contractor**, at the request of the **City**, shall furnish to the **City** such bills of sale and other instruments as may be required by the **City**, properly executed, acknowledged and delivered assuring to the **City** title to such tangible personal property, free of liens and/or encumbrances, and the **Contractor** shall mark or otherwise identify all such tangible personal property as the property of the **City**.

62.4 Title to all tangible personal property to be sold by the **Contractor** to the **City** pursuant to the provisions of the **Contract** shall immediately vest in and become the sole property of the **City** upon delivery of such tangible personal property to the **Site**. Notwithstanding such transfer of title, the **Contractor** shall have the full and continuing responsibility to install such tangible personal property in accordance with the provisions of this **Contract**, protect it, maintain it in a proper condition and forthwith repair, replace and make good any damage thereto, theft or disappearance thereof, and furnish additional tangible personal property in place of any that may be lost, stolen or rendered unusable, without cost to the **City**, until such time as the **Work** covered by the **Contract** is fully accepted by the **City**. Such transfer of title shall in no way affect any of the **Contractor's** obligations hereunder. In the event that, after title has passed to the **City**, any of the tangible personal property is rejected as being defective or otherwise unsatisfactory, title to all such tangible personal property shall be deemed to have been transferred back to the **Contractor**.

62.5 The purchase by **Subcontractors** or **Materialmen** of tangible personal property to be sold hereunder shall be a purchase or procurement for resale to the **Contractor** (either directly or through other **Subcontractors**) and therefore not subject to the aforesaid sales and compensating use taxes, provided that the subcontracts and purchase agreements provide for the resale of such tangible personal property and that such subcontracts and purchase agreements are in a form similar to this **Contract** with respect to the separation of the sale of consumable supplies and tangible personal property that the

Contractor is required to remove from the Site during or upon completion of the Work from the Work and labor, services, and any other matters to be provided, and provided further that the subcontracts and purchase agreements provide separate prices for tangible personal property and all other services and matters. Such separation shall actually be followed in practice, including the separation of payments for tangible personal property from the payments for other Work and labor and other things to be provided.

62.6 The Contractor and its Subcontractors and Materialmen shall furnish a Contractor Exempt Purchase Certificate to all persons, firms or corporations from which they purchase tangible personal property for the performance of the Work covered by this Contract.

62.7 In the event any of the provisions of this Article 62 shall be deemed to be in conflict with any other provisions of this Contract or create any ambiguity, then the provisions of this Article 62 shall control.

#### ARTICLE 63. INVESTIGATION(S) CLAUSE

63.1 The parties to this Contract agree to cooperate fully and faithfully with any investigation, audit or inquiry conducted by a United States, a State of New York (State) or a City governmental agency or authority that is empowered directly or by designation to compel the attendance of witnesses and to examine witnesses under oath, or conducted by the Inspector General of a governmental agency that is a party in interest to the transaction, submitted bid, submitted proposal, contract, lease, permit or license that is the subject of the investigation, audit or inquiry.

63.2 If any person who has been advised that his/her statement, and any information from such statement, will not be used against him/her in any subsequent criminal proceeding refuses to testify before a grand jury or other governmental agency or authority empowered directly or by designation to compel the attendance of witnesses and to examine witnesses under oath concerning the award of or performance under any transaction, agreement, lease, permit, contract, or license entered into with the City, the State, or any political subdivision or public authority thereof, or the Port Authority of New York and New Jersey, or any local development corporation within the City, or any public benefit corporation organized under the Laws of the State of New York, or;

63.3 If any person refuses to testify for a reason other than the assertion of his/her privilege against self incrimination in an investigation, audit or inquiry conducted by a City or State governmental agency or authority empowered directly or by designation to compel the attendance of witnesses and to take testimony under oath, or by the Inspector General of the governmental agency that is a party in interest in, and is seeking testimony concerning the award of, or performance under any transaction, agreement, lease, permit, contract, or license entered into with the City, the State, or any political subdivision thereof or any local development corporation within the City, then;

63.4 The Commissioner whose Agency is a party in interest to the transaction, submitted bid, submitted proposal, contract, lease, permit, or license shall convene a hearing, upon not less than five (5) Days' written notice to the parties involved to determine if any penalties should attach for the failure of a person to testify.

63.5 If any non-governmental party to the hearing requests an adjournment, the Commissioner who convened the hearing may, upon granting the adjournment, suspend any contract, lease, permit, or license, pending the final determination pursuant to Article 63.7 without the City incurring any penalty or damages for delay or otherwise.

63.6 The penalties which may attach after a final determination by the Commissioner may include but shall not exceed:

63.6.1 The disqualification for a period not to exceed five (5) years from the date of an adverse determination for any person, or any entity of which such person was a member at the time the testimony was sought, from submitting bids for, or transacting business with, or entering into or obtaining any contract, lease, permit or license with or from the City; and/or

63.6.2 The cancellation or termination of any and all such existing City contracts, leases, permits or licenses that the refusal to testify concerns and that have not been assigned as permitted under this Contract, nor the proceeds of which pledged, to an unaffiliated and unrelated institutional lender for fair value prior to the issuance of the notice scheduling the hearing, without the City incurring any penalty or damages on account of such cancellation or termination; monies lawfully due for goods delivered, work done, rentals, or fees accrued prior to the cancellation or termination shall be paid by the City.

63.7 The Commissioner shall consider and address in reaching his/her determination and in assessing an appropriate penalty the factors in Articles 63.7.1 and 63.7.2. The Commissioner may also consider, if relevant and appropriate, the criteria established in Articles 63.7.3 and 63.7.4, in addition to any other information which may be relevant and appropriate:

63.7.1 The party's good faith endeavors or lack thereof to cooperate fully and faithfully with any governmental investigation or audit, including but not limited to the discipline, discharge, or disassociation of any person failing to testify, the production of accurate and complete books and records, and the forthcoming testimony of all other members, agents, assignees or fiduciaries whose testimony is sought.

63.7.2 The relationship of the person who refused to testify to any entity that is a party to the hearing, including but not limited to, whether the person whose testimony is sought has an ownership interest in the entity and/or the degree of authority and responsibility the person has within the entity.

63.7.3 The nexus of the testimony sought to the subject entity and its contracts, leases, permits or licenses with the City.

63.7.4 The effect a penalty may have on an unaffiliated and unrelated party or entity that has a significant interest in an entity subject to penalties under Article 63.6, provided that the party or entity has given actual notice to the Commissioner upon the acquisition of the interest, or at the hearing called for in Article 63.4, gives notice and proves that such interest was previously acquired. Under either circumstance the party or entity shall present evidence at the hearing demonstrating the potential adverse impact a penalty will have on such person or entity.

63.8 Definitions:

63.8.1 The term "license" or "permit" as used in this Article 63 shall be defined as a license, permit, franchise or concession not granted as a matter of right.

63.8.2 The term "person" as used in this Article 63 shall be defined as any natural person doing business alone or associated with another person or entity as a partner, director, officer, principal or employee.

63.8.3 The term "entity" as used in this Article 63 shall be defined as any firm, partnership, corporation, association, joint venture, or person that receives monies, benefits, licenses, leases, or permits from or through the City or otherwise transacts business with the City.

63.8.4 The term "member" as used in this Article 63 shall be defined as any person associated with another person or entity as a partner, director, officer, principal or employee.

63.9 In addition to and notwithstanding any other provision of this Contract, the Commissioner may in his/her sole discretion terminate this Contract upon not less than three (3) Days' written notice in the event the Contractor fails to promptly report in writing to the Commissioner of the Department of Investigations ("DOI") of the City any solicitation of money, goods, requests for future employment or other benefit or thing of value, by or on behalf of any employee of the City or other person, firm, corporation or entity for any purpose which may be related to the procurement or obtaining of this Contract by the Contractor, or affecting the performance of this Contract.

#### **ARTICLE 64. TERMINATION BY THE CITY**

64.1 In addition to termination pursuant to any other article of this Contract, the Commissioner may, at any time, terminate this Contract by written notice to the Contractor. In the event of termination, the Contractor shall, upon receipt of such notice, unless otherwise directed by the Commissioner:

64.1.1 Stop Work on the date specified in the notice;

64.1.2 Take such action as may be necessary for the protection and preservation of the City's materials and property;

64.1.3 Cancel all cancelable orders for material and equipment;

64.1.4 Assign to the City and deliver to the Site or another location designated by the Commissioner, any non-cancelable orders for material and equipment that is not capable of use except in the performance of this Contract and has been specifically fabricated for the sole purpose of this Contract and not incorporated in the Work;

64.1.5 Take no action which will increase the amounts payable by the City under this Contract.

64.2 In the event of termination by the City pursuant to this Article 64, payment to the Contractor shall be in accordance with Articles 64.2.1, 64.2.2 or 64.2.3, to the extent that each respective article applies.

64.2.1 Lump Sum Contracts or Items: On all lump sum Contracts, or on lump sum items in a Contract, the City will pay the Contractor the sum of the amounts described in Articles 64.2.1(a) and 64.2.1(b), less all payments previously made pursuant to this Contract. On lump sum Contracts only, the City will also pay the Contractor an additional sum as provided in Article 64.2.1(c).

64.2.1(a) For Work completed prior to the notice of termination, the Contractor shall be paid a pro rata portion of the lump sum bid amount, plus approved change orders, based upon the percent completion of the Work, as determined by the



**Commissioner.** For the purpose of determining the pro rata portion of the lump sum bid amount to which the Contractor is entitled, the bid breakdown submitted in accordance with Article 41 shall be considered, but shall not be dispositive. The Commissioner's determination hereunder shall be final, binding, and conclusive.

64.2.1(b) For non-cancelable material and equipment that is not capable of use except in the performance of this Contract and has been specifically fabricated for the sole purpose of this Contract, but not yet incorporated in the Work, the Contractor shall be paid the lesser of the following, less salvage value:

64.2.1(b)(i) The Direct Cost, as defined in Article 64.2.4; or

64.2.1(b)(ii) The fair and reasonable value, if less than Direct Cost, of such material and equipment, plus necessary and reasonable delivery costs.

64.2.1(b)(iii) In addition, the Contractor shall be paid five (5%) percent of the amount described in Article 64.2.1(b)(i) or Article 64.2.1(b)(ii), whichever applies.

64.2.1(c) Except as otherwise provided in Article 64.2.1(d), on all lump sum Contracts, the Contractor shall be paid the percentage indicated below applied to the difference between the total lump sum bid amount and the total of all payments made prior to the notice of termination plus all payments allowed pursuant to Articles 64.2.1(a) and 64.2.1(b):

64.2.1(c)(i) Five (5%) percent of the first five million (\$5,000,000) dollars; and

64.2.1(c)(ii) Three (3%) percent of any amount between five million (\$5,000,000) dollars and fifteen million (\$15,000,000) dollars; plus

64.2.1(c)(iii) One (1%) percent of any amount over fifteen million (\$15,000,000) dollars.

64.2.1(d) In the event the City terminates a lump sum Contract pursuant to this Article 64 within ninety (90) Days after registration of the Contract with the Comptroller, the Contractor shall be paid one (1%) percent of the difference between the lump sum bid amount and the total of all payments made pursuant to this Article 64.2.

64.2.2 Unit Price Contracts or Items: On all unit price Contracts, or on unit price items in a Contract, the City will pay the Contractor the sum of the amounts described in Articles 64.2.2(a) and 64.2.2(b), less all payments previously made pursuant to this Contract:

64.2.2(a) For all completed units, the unit price stated in the Contract, and

64.2.2(b) For units that have been ordered but are only partially completed, the Contractor will be paid:

64.2.2(b)(i) A pro rata portion of the unit price stated in the Contract based upon the percent completion of the unit and

64.2.2(b)(ii) For non-cancelable material and equipment, payment will be made pursuant to Article 64.2.1(b).

64.2.3 Time and Materials Contracts or Items Based on Time and Material Records: On all Contracts or items in a Contract where payment for the Work is based on time and material records, the Contractor shall be paid in accordance with Article 26, less all payments previously made pursuant to this Contract.

64.2.4 Direct Costs: Direct Costs as used in this Article 64.2 shall mean:

64.2.4(a) The actual purchase price of material and equipment, plus necessary and reasonable delivery costs,

64.2.4(b) The actual cost of labor involved in construction and installation at the Site, and

64.2.4(c) The actual cost of necessary bonds and insurance purchased pursuant to requirements of this Contract less any amounts that have been or should be refunded by the Contractor's sureties or insurance carriers.

64.2.4(d) Direct Costs shall not include overhead.

64.3 In no event shall any payments under this Article 64 exceed the Contract price for such items.

64.4 All payments pursuant to Article 64 shall be in the nature of liquidated damages and shall be accepted by the Contractor in full satisfaction of all claims against the City.

64.5 The City may deduct or set off against any sums due and payable pursuant to this Article 64, any deductions authorized by this Contract or by Law (including but not limited to liquidated damages) and any claims it may have against the Contractor. The City's exercise of the right to terminate the Contract pursuant to this Article 64 shall not impair or otherwise effect the City's right to assert any claims it may have against the Contractor in a plenary action.

64.6 Where the Work covered by the Contract has been substantially completed, as determined in writing by the Commissioner, termination of the Work shall be handled as an omission of Work pursuant to Articles 29 and 33, in which case a change order will be issued to reflect an appropriate reduction in the Contract sum, or if the amount is determined after final payment, such amount shall be paid by the Contractor.

#### **ARTICLE 65. CHOICE OF LAW, CONSENT TO JURISDICTION AND VENUE**

65.1 This Contract shall be deemed to be executed in the City regardless of the domicile of the Contractor, and shall be governed by and construed in accordance with the Laws of the State of New York and the Laws of the United States, where applicable.

65.2 The parties agree that any and all claims asserted against the City arising under this Contract or related thereto shall be heard and determined in the courts of the State of New York ("New York State Courts") located in the City and County of New York. To effect this Contract and intent, the Contractor agrees:

65.2.1 If the City initiates any action against the Contractor in Federal court or in a New York State Court, service of process may be made on the Contractor either in person, wherever such Contractor may be found, or by registered mail addressed to the Contractor at its address as set forth in this Contract, or to such other address as the Contractor may provide to the City in writing; and

65.2.2 With respect to any action between the City and the Contractor in a New York State Court, the Contractor hereby expressly waives and relinquishes any rights it might otherwise have:

65.2.2(a) To move to dismiss on grounds of forum non conveniens;

65.2.2(b) To remove to Federal Court; and

65.2.2(c) To move for a change of venue to a New York State Court outside New York County.

65.2.3 With respect to any action brought by the City against the Contractor in a Federal Court located in the City, the Contractor expressly waives and relinquishes any right it might otherwise have to move to transfer the action to a Federal Court outside the City.

65.2.4 If the Contractor commences any action against the City in a court located other than in the City and County of New York, upon request of the City, the Contractor shall either consent to a transfer of the action to a New York State Court of competent jurisdiction located in the City and County of New York or, if the Court where the action is initially brought will not or cannot transfer the action, the Contractor shall consent to dismiss such action without prejudice and may thereafter reinstate the action in a New York State Court of competent jurisdiction in New York County.

65.3 If any provision(s) of this Article 65 is held unenforceable for any reason, each and all other provision(s) shall nevertheless remain in full force and effect.

#### **ARTICLE 66. PARTICIPATION IN AN INTERNATIONAL BOYCOTT**

66.1 The Contractor agrees that neither the Contractor nor any substantially owned affiliated company is participating or shall participate in an international boycott in violation of the provisions of the Federal Export Administration Act of 1979, as amended, or the regulations of the United States Department of Commerce (Commerce Department) promulgated thereunder.

66.2 Upon the final determination by the Commerce Department or any other agency of the United States as to, or conviction of the Contractor or a substantially-owned affiliated company thereof for participation in an international boycott in violation of the provisions of the Export Administration Act of 1979, as amended, or the regulations promulgated thereunder, the Comptroller may, at his/her option, render forfeit and void this Contract.

66.3 The Contractor shall comply in all respects, with the provisions of Section 6-114 of the Administrative Code and the rules and regulations issued by the Comptroller thereunder.

## **ARTICLE 67. LOCALLY BASED ENTERPRISE PROGRAM**

67.1 This Contract is subject to the requirements of Section 6-108.1 of the Administrative Code and regulations promulgated thereunder. No construction contract shall be awarded unless and until these requirements have been complied with in their entirety; however, compliance with this Article 67 is not required if the Agency sets Subcontractor Participation Goals for Minority- and Women-Owned Business Enterprises (M/WBEs).

67.2 Unless specifically waived by the Commissioner with the approval of the Division of Economic and Financial Opportunity of the City Department of Business Services, if any portion of the Contract is subcontracted, not less than ten (10%) percent of the total dollar amount of the Contract shall be awarded to locally based enterprises (LBEs); except that where less than ten (10%) percent of the total dollar amount of the Contract is subcontracted, such lesser percentage shall be so awarded.

67.3 The Contractor shall not require performance and payment bonds from LBE Subcontractors.

67.4 If the Contractor has indicated prior to award that no Work will be subcontracted, no Work shall be subcontracted without the prior approval of the Commissioner, which shall be granted only if the Contractor makes a good faith effort beginning at least six (6) weeks before the Work is to be performed to obtain LBE Subcontractors to perform the Work.

67.5 If the Contractor has not identified sufficient LBE Subcontractors prior to award, it shall sign a letter of compliance stating that it complies with Section 6-108.1 of the Administrative Code, recognizes that achieving the LBE requirement is a condition of its Contract, and shall submit documentation demonstrating its good faith efforts to obtain LBEs. After award, the Contractor shall begin to solicit LBE's to perform subcontracted Work at least six (6) weeks before the date such Work is to be performed and shall demonstrate that a good faith effort has been made to obtain LBEs on each subcontract until it meets the required percentage.

67.6 Failure of the Contractor to comply with the requirements of Section 6-108.1 of the Administrative Code and the regulations promulgated thereunder shall constitute a material breach of this Contract. Remedy for such breach may include the imposition of any or all of the following sanctions:

67.6.1 Reducing the Contractor's compensation by an amount equal to the dollar value of the percentage of the LBE subcontracting requirement not complied with;

67.6.2 Declaring the Contractor in default;

67.6.3 If the Contractor is an LBE, de-certifying and declaring the Contractor ineligible to participate in the LBE program for a period of up to three (3) years.

## **ARTICLE 68. ANTITRUST**

68.1 The Contractor hereby assigns, sells, and transfers to the City all right, title, and interest in and to any claims and causes of action arising under the antitrust Laws of New York State or of the United States relating to the particular goods or services purchased or procured by the City under this Contract.

## ARTICLE 69. MacBRIDE PRINCIPLES PROVISIONS

### 69.1 Notice To All Prospective Contractors:

69.1.1 Local Law No. 34 of 1991 became effective on September 10, 1991 and added Section 6-115.1 of the Administrative Code. The local Law provides for certain restrictions on City Contracts to express the opposition of the people of the City to employment discrimination practices in Northern Ireland to promote freedom of work-place opportunity.

69.1.2 Pursuant to Section 6-115.1, prospective Contractors for Contracts to provide goods or services involving an expenditure of an amount greater than ten thousand (\$10,000.) dollars, or for construction involving an amount greater than fifteen thousand (\$15,000.) dollars, are asked to sign a rider in which they covenant and represent, as a material condition of their Contract, that any business operations in Northern Ireland conducted by the Contractor and any individual or legal entity in which the Contractor holds a ten (10%) percent or greater ownership interest in the Contractor will be conducted in accordance with the MacBride Principles of nondiscrimination in employment.

69.1.3 Prospective Contractors are not required to agree to these conditions. However, in the case of Contracts let by competitive sealed bidding, whenever the lowest responsible bidder has not agreed to stipulate to the conditions set forth in this notice and another bidder who has agreed to stipulate to such conditions has submitted a bid within five (5%) percent of the lowest responsible bid for a Contract to supply goods, services or construction of comparable quality, the Agency shall refer such bids to the Mayor, the Speaker or other officials, as appropriate, who may determine, in accordance with applicable Law, that it is in the best interest of the City that the Contract be awarded to other than the lowest responsible pursuant to Section 313(b)(2) of the City Charter.

69.1.4 In the case of Contracts let by other than competitive sealed bidding, if a prospective Contractor does not agree to these conditions, no Agency, elected official or the City Council shall award the Contract to that bidder unless the Agency seeking to use the goods, services or construction certifies in writing that the Contract is necessary for the Agency to perform its functions and there is no other responsible Contractor who will supply goods, services or construction of comparable quality at a comparable price.

69.2 In accordance with Section 6-115.1 of the Administrative Code, the Contractor stipulates that such Contractor and any individual or legal entity in which the Contractor holds a ten (10%) percent or greater ownership interest in the Contractor either:

69.2.1 Have no business operations in Northern Ireland, or

69.2.2 Shall take lawful steps in good faith to conduct any business operations they have in Northern Ireland in accordance with the MacBride Principles, and shall permit independent monitoring of their compliance with such principles.

69.3 For purposes of this Article, the following terms shall have the following meanings:

69.3.1 "MacBride Principles" shall mean those principles relating to nondiscrimination in employment and freedom of work-place opportunity which require employers doing business in Northern Ireland to:

69.3.1(a) increase the representation of individuals from under-represented religious groups in the workforce, including managerial, supervisory, administrative, clerical and technical jobs;

69.3.1(b) take steps to promote adequate security for the protection of employees from under-represented religious groups both at the work-place and while traveling to and from Work;

69.3.1(c) ban provocative religious or political emblems from the workplace;

69.3.1(d) publicly advertise all job openings and make special recruitment efforts to attract applicants from under-represented religious groups;

69.3.1(e) establish layoff, recall, and termination procedures which do not in practice favor a particular religious group;

69.3.1(f) abolish all job reservations, apprenticeship restrictions and different employment criteria which discriminate on the basis of religion;

69.3.1(g) develop training programs that will prepare substantial numbers of current employees from under-represented religious groups for skilled jobs, including the expansion of existing programs and the creation of new programs to train, upgrade, and improve the skills of workers from under-represented religious groups;

69.3.1(h) establish procedures to assess, identify, and actively recruit employees from under-represented religious groups with potential for further advancement; and

69.3.1(i) appoint a senior management staff member to oversee affirmative action efforts and develop a timetable to ensure their full implementation.

69.4 The Contractor agrees that the covenants and representations in Article 69.2 are material conditions to this Contract. In the event the Agency receives information that the Contractor who made the stipulation required by this Article 69 is in violation thereof, the Agency shall review such information and give the Contractor an opportunity to respond. If the Agency finds that a violation has occurred, the Agency shall have the right to declare the Contractor in default and/or terminate this Contract for cause and procure supplies, services or Work from another source in the manner the Agency deems proper. In the event of such termination, the Contractor shall pay to the Agency, or the Agency in its sole discretion may withhold from any amounts otherwise payable to the Contractor, the difference between the Contract price for the uncompleted portion of this Contract and the cost to the Agency of completing performance of this Contract either itself or by engaging another Contractor or Contractors. In the case of a requirement Contract, the Contractor shall be liable for such difference in price for the entire amount of supplies required by the Agency for the uncompleted term of Contractor's Contract. In the case of a construction Contract, the Agency shall also have the right to hold the Contractor in partial or total default in accordance with the default provisions of this Contract, and/or may seek debarment or suspension of the Contractor. The rights and remedies of the Agency hereunder shall be in addition to, and not in lieu of, any rights and remedies the Agency has pursuant to this Contract or by operation of Law.

#### **ARTICLE 70. ELECTRONIC FILING/NYC DEVELOPMENT HUB**

70.1 The Contractor shall electronically file all alteration type-2 and alteration type-3 applications via the New York City Development Hub Web site, except applications for the following types of minor alterations: enlargements, curb cuts, legalizations, fire alarms, builders pavement plans, and jobs filed on Landmark Preservation Commission calendared properties. All such filings must be professionally certified. Information about electronic filing via the New York City Development Hub is available on the City Department of Buildings Web site at [www.nyc.gov/buildings](http://www.nyc.gov/buildings).

#### **ARTICLE 71. PROHIBITION OF TROPICAL HARDWOODS**

71.1 Tropical hardwoods, as defined in Section 165 of the New York State Finance Law (Finance Law), shall not be utilized in the performance of this Contract except as expressly permitted by Section 165 of the Finance Law.

#### **ARTICLE 72. CONFLICTS OF INTEREST**

72.1 Section 2604 of the City Charter and other related provisions of the City Charter, the Administrative Code, and the Penal Law are applicable under the terms of this Contract in relation to conflicts of interest and shall be extended to Subcontractors authorized to perform Work, labor and services pursuant to this Contract and further, it shall be the duty and responsibility of the Contractor to so inform its respective Subcontractors. Notice is hereby given that, under certain circumstances, penalties may be invoked against the donor as well as the recipient of any form of valuable gift.

#### **ARTICLE 73. MERGER CLAUSE**

73.1 The written Contract herein, contains all the terms and conditions agreed upon by the parties hereto, and no other agreement, oral or otherwise, regarding the subject matter of this Contract shall be deemed to exist or to bind any of the parties hereto, or to vary any of the terms contained herein.

#### **ARTICLE 74. STATEMENT OF WORK**

74.1 The Contractor shall furnish all labor and materials and perform all Work in strict accordance with the Specifications and Addenda thereto, numbered as shown in Schedule A.

#### **ARTICLE 75. COMPENSATION TO BE PAID TO CONTRACTOR**

75.1 The City will pay and the Contractor will accept in full consideration for the performance of the Contract, subject to additions and deductions as provided herein, the total sum shown in Schedule A, this said sum being the amount at which the Contract was awarded to the Contractor at a public letting thereof, based upon the Contractor's bid for the Contract.

#### **ARTICLE 76. ELECTRONIC FUNDS TRANSFER**

76.1 In accordance with Section 6-107.1 of the Administrative Code, the Contractor agrees to accept payments under this Contract from the City by electronic funds transfer (EFT). An EFT is any

transfer of funds, other than a transaction originated by check, draft or similar paper instrument, which is initiated through an electronic terminal, telephonic instrument or computer or magnetic tape so as to order, instruct or authorize a financial institution to debit or credit an account. Prior to the first payment made under this Contract, the Contractor shall designate one financial institution or other authorized payment agent and shall complete the attached "EFT Vendor Payment Enrollment Form" in order to provide the Commissioner of the City Department of Finance with information necessary for the Contractor to receive electronic funds transfer payments through a designated financial institution or authorized payment agent. The crediting of the amount of a payment to the appropriate account on the books of a financial institution or other authorized payment agent designated by the Contractor shall constitute full satisfaction by the City for the amount of the payment under this Contract. The account information supplied by the Contractor to facilitate the electronic funds transfer shall remain confidential to the fullest extent provided by Law.

76.2 The Commissioner may waive the application of the requirements of this Article 76 to payments on contracts entered into pursuant to Section 315 of the City Charter. In addition, the Commissioner of the Department of Finance and the Comptroller may jointly issue standards pursuant to which the Agency may waive the requirements of this Article 76 for payments in the following circumstances: (i) for individuals or classes of individuals for whom compliance imposes a hardship; (ii) for classifications or types of checks; or (iii) in other circumstances as may be necessary in the interest of the City.

#### **ARTICLE 77. RECORDS RETENTION**

77.1 The Contractor agrees to retain all books, records, and other documents relevant to this Contract for six years after the final payment or termination of this Contract, whichever is later. City, state, and federal auditors and any other persons duly authorized by the City shall have full access to and the right to examine any such books, records, and other documents during the retention period.

#### **ARTICLE 78. EXAMINATION AND VIEWING OF SITE, CONSIDERATION OF OTHER SOURCES OF INFORMATION AND CHANGED SITE CONDITIONS**

78.1 Pre-Bidding (Investigation) Viewing of Site – Bidders must carefully view and examine the Site of the proposed Work, as well as its adjacent area, and seek other usual sources of information, for they will be conclusively presumed to have full knowledge of any and all conditions and hazards on, about or above the Site relating to or affecting in any way the performance of the Work to be done under the Contract that were or should have been known by a reasonably prudent bidder. To arrange a date for visiting the Site, bidders are to contact the Agency contact person specified in the bid documents.

78.2 Should the Contractor encounter during the progress of the Work site conditions or environmental hazards at the Site materially differing from any shown on the Contract Drawings or indicated in the Specifications or such conditions or environmental hazards as could not reasonably have been anticipated by the Contractor, which conditions or hazards will materially affect the cost of the Work to be done under the Contract, the attention of the Commissioner must be called immediately to such conditions or hazards before they are disturbed. The Commissioner shall thereupon promptly investigate the conditions or hazards. If the Commissioner finds that they do so materially differ, and that they could not have been reasonably anticipated by the Contractor, the Contract may be modified with the Commissioner's written approval.



**ARTICLE 79. PARTICIPATION BY MINORITY-OWNED AND WOMEN-OWNED  
BUSINESS ENTERPRISES IN CITY PROCUREMENT**

**NOTICE TO ALL PROSPECTIVE CONTRACTORS**

**ARTICLE I. M/WBE PROGRAM**

Local Law No. 129 of 2005 added and Local Law 1 of 2013 amended Section 6-129 of the Administrative Code of the City of New York (hereinafter "Section 6-129"). Section 6-129 establishes the program for participation in City procurement ("M/WBE Program") by minority-owned business enterprises ("MBEs") and women-owned business enterprises ("WBEs"), certified in accordance with Section 1304 of the New York City Charter. As stated in Section 6-129, the intent of the program is to address the impact of discrimination on the City's procurement process, and to promote the public interest in avoiding fraud and favoritism in the procurement process, increasing competition for City business, and lowering contract costs. The contract provisions contained herein are pursuant to Section 6-129, and the rules of the Department of Small Business Services ("DSBS") promulgated thereunder.

**If this Contract is subject to the M/WBE Program established by Section 6-129, the specific requirements of MBE and/or WBE participation for this Contract are set forth in Schedule B of the Contract (entitled the "M/WBE Utilization Plan"), and are detailed below. The Contractor must comply with all applicable MBE and WBE requirements for this Contract.**

All provisions of Section 6-129 are hereby incorporated in the Contract by reference and all terms used herein that are not defined herein shall have the meanings given such terms in Section 6-129. Article I, Part A, below, sets forth provisions related to the participation goals for construction, standard and professional services contracts. Article I, Part B, below, sets forth miscellaneous provisions related to the M/WBE Program.

**PART A**

**PARTICIPATION GOALS FOR CONSTRUCTION, STANDARD  
AND PROFESSIONAL SERVICES CONTRACTS OR TASK ORDERS**

1. The MBE and/or WBE Participation Goals established for this Contract or Task Orders issued pursuant to this Contract, ("Participation Goals"), as applicable, are set forth on Schedule B, Part I to this Contract (see Page 1, line 1 Total Participation Goals) or will be set forth on Schedule B, Part I to Task Orders issued pursuant to this Contract, as applicable.

The **Participation Goals** represent a percentage of the total dollar value of the Contract or Task Order, as applicable, that may be achieved by awarding subcontracts to firms certified with New York City Department of Small Business Services as MBEs and/or WBEs, and/or by crediting the participation of prime contractors and/or qualified joint ventures as provided in Section 3 below, unless the goals have been waived or modified by Agency in accordance with Section 6-129 and Part A, Sections 10 and 11 below, respectively.

2. If **Participation Goals** have been established for this Contract or Task Orders issued pursuant to this Contract, Contractor agrees or shall agree as a material term of the Contract that Contractor shall be subject to the **Participation Goals**, unless the goals are waived or modified by Agency in accordance with Section 6-129 and Part A, Sections 10 and 11 below, respectively.

3. If **Participation Goals** have been established for this Contract or Task Order issued pursuant to this Contract, a Contractor that is an MBE and/or WBE shall be permitted to count its own participation toward fulfillment of the relevant **Participation Goal**, provided that in accordance with Section 6-129 the value of Contractor's participation shall be determined by subtracting from the total value of the Contract or Task Order, as applicable, any amounts that the Contractor pays to direct subcontractors (as defined in Section 6-129(c)(13)), and provided further that a Contractor that is certified as both an MBE and a WBE may count its own participation either toward the goal for MBEs or the goal for WBEs, but not both.

A Contractor that is a qualified joint venture (as defined in Section 6-129(c)(30)) shall be permitted to count a percentage of its own participation toward fulfillment of the relevant **Participation Goal**. In accordance with Section 6-129, the value of Contractor's participation shall be determined by subtracting from the total value of the Contract or Task Order, as applicable, any amounts that Contractor pays to direct subcontractors, and then multiplying the remainder by the percentage to be applied to total profit to determine the amount to which an MBE or WBE is entitled pursuant to the joint venture agreement, provided that where a participant in a joint venture is certified as both an MBE and a WBE, such amount shall be counted either toward the goal for MBEs or the goal for WBEs, but not both.

4. A. If **Participation Goals** have been established for this Contract, a prospective contractor shall be required to submit with its bid or proposal, as applicable, a completed Schedule B, M/WBE Utilization Plan, Part II (see Pages 2-4) indicating: (a) whether the contractor is an MBE or WBE, or qualified joint venture; (b) the percentage of work it intends to award to direct subcontractors; and (c) in cases where the contractor intends to award direct subcontracts, a description of the type and dollar value of work designated for participation by MBEs and/or WBEs, and the time frames in which such work is scheduled to begin and end. In the event that this M/WBE Utilization Plan indicates that the bidder or proposer, as applicable, does not intend to meet the **Participation Goals**, the bid or proposal, as applicable, shall be deemed non-responsive, unless Agency has granted the bidder or proposer, as applicable, a pre-award waiver of the Participation Goals in accordance with Section 6-129 and Part A, Section 10 below.

B. (i) If this Contract is for a master services agreement or other requirements type contract that will result in the issuance of Task Orders that will be individually registered ("Master Services Agreement") and is subject to M/WBE **Participation Goals**, a prospective contractor shall be required to submit with its bid or proposal, as applicable, a completed Schedule B, M/WBE Participation Requirements for Master Services Agreements That Will Require Individually Registered Task Orders, Part II (page 2) indicating the prospective contractor's certification and required affirmations to make all reasonable good faith efforts to meet participation goals established on each individual Task Order issued pursuant to this Contract, or if a partial waiver is obtained or such goals are modified by the Agency, to meet the modified **Participation Goals** by soliciting and obtaining the participation of certified MBE and/or WBE firms. In the event that the Schedule B indicates that the bidder or proposer, as applicable, does not intend to meet the **Participation Goals** that may be established on Task Orders issued pursuant to this Contract, the bid or proposal, as applicable, shall be deemed nonresponsive.

(ii) **Participation Goals** on a Master Services Agreement will be established for individual Task Orders issued after the Master Services Agreement is awarded. If **Participation Goals** have been established on a Task Order, a contractor shall be required to submit a Schedule B – M/WBE Utilization Plan For Independently Registered Task Orders That Are Issued Pursuant to Master Services Agreements, Part II (see Pages 2-4) indicating: (a) whether the contractor is an MBE or WBE, or qualified joint venture; (b) the percentage of work it intends to award to direct subcontractors; and (c) in cases where the contractor intends to award direct subcontracts, a description of the type and dollar value of work designated for participation by MBEs and/or WBEs, and the time frames in which such work is scheduled to begin and end. The contractor must engage in good faith efforts to meet the **Participation Goals** as established for the Task Order unless Agency has granted the contractor a pre-award waiver of the **Participation Goals** in accordance with Section 6-129 and Part A, Section 10 below.

**C. THE BIDDER/PROPOSER MUST COMPLETE THE SCHEDULE B INCLUDED HEREIN (SCHEDULE B, PART II). A SCHEDULE B SUBMITTED BY THE BIDDER/PROPOSER WHICH DOES NOT INCLUDE THE VENDOR CERTIFICATION AND REQUIRED AFFIRMATIONS (SEE SECTION V OF PART II) WILL BE DEEMED TO BE NON-RESPONSIVE, UNLESS A FULL WAIVER OF THE PARTICIPATION GOALS IS GRANTED (SCHEDULE B, PART III). IN THE EVENT THAT THE CITY DETERMINES THAT THE BIDDER/PROPOSER HAS SUBMITTED A SCHEDULE B WHERE THE VENDOR CERTIFICATION AND REQUIRED AFFIRMATIONS ARE COMPLETED BUT OTHER ASPECTS OF THE SCHEDULE B ARE NOT COMPLETE, OR CONTAIN A COPY OR COMPUTATION ERROR THAT IS AT ODDS WITH THE VENDOR CERTIFICATION AND AFFIRMATIONS, THE BIDDER/PROPOSER WILL BE NOTIFIED BY THE AGENCY AND WILL BE GIVEN FOUR (4) CALENDAR DAYS FROM RECEIPT OF NOTIFICATION TO CURE THE SPECIFIED DEFICIENCIES AND RETURN A COMPLETED SCHEDULE B TO THE AGENCY. FAILURE TO DO SO WILL RESULT IN A DETERMINATION THAT THE BID/PROPOSAL IS NON-RESPONSIVE. RECEIPT OF NOTIFICATION IS DEFINED AS THE DATE NOTICE IS E-MAILED OR FAXED (IF THE BIDDER/PROPOSER HAS PROVIDED AN E-MAIL ADDRESS OR FAX NUMBER), OR NO LATER THAN FIVE (5) CALENDAR DAYS FROM THE DATE OF MAILING OR UPON DELIVERY, IF DELIVERED.**

5. Where an M/WBE Utilization Plan has been submitted, the Contractor shall, within 30 days of issuance by Agency of a notice to proceed, submit a list of proposed persons or entities to which it intends to award subcontracts within the subsequent 12 months. In the case of multiyear contracts, such list shall also be submitted every year thereafter. The Agency may also require the Contractor to report periodically about the contracts awarded by its direct subcontractors to indirect subcontractors (as defined in Section 6-129(c)(22)). **PLEASE NOTE: If this Contract is a public works project subject to GML §101(5) (i.e., a contract valued at or below \$3M for projects in New York City) or if the Contract is subject to a project labor agreement in accordance with Labor Law §222, and the bidder is required to identify at the time of bid submission its intended subcontractors for the Wicks trades (plumbing and gas fitting; steam heating, hot water heating, ventilating and air conditioning (HVAC); and electric wiring), the Contractor must identify all those to which it intends to award construction subcontracts for any portion of the Wicks trade work at the time of bid submission, regardless of what point in the life of the contract such subcontracts will occur. In identifying intended subcontractors in the bid submission, bidders may satisfy any Participation Goals established for this Contract by proposing one or more subcontractors that are MBEs and/or WBEs for any portion of the Wicks trade work. In the event that the Contractor's selection of a subcontractor is disapproved, the Contractor shall have a reasonable time to propose alternate subcontractors.**

6. MBE and WBE firms must be certified by DSBS in order for the Contractor to credit such firms' participation toward the attainment of the **Participation Goals**. Such certification must occur prior to the

firms' commencement of work. A list of MBE and WBE firms may be obtained from the DSBS website at [www.nyc.gov/buycertified](http://www.nyc.gov/buycertified), by emailing DSBS at [buyer@sbs.nyc.gov](mailto:buyer@sbs.nyc.gov), by calling (212) 513-6356, or by visiting or writing DSBS at 110 William St., New York, New York, 10038, 7th floor. Eligible firms that have not yet been certified may contact DSBS in order to seek certification by visiting [www.nyc.gov/getcertified](http://www.nyc.gov/getcertified), emailing [MWBE@sbs.nyc.gov](mailto:MWBE@sbs.nyc.gov), or calling the DSBS certification helpline at (212) 513-6311. A firm that is certified as both an MBE and a WBE may be counted either toward the goal for MBEs or the goal for WBEs, but not both. No credit shall be given for participation by a graduate MBE or graduate WBE, as defined in Section 6-129(c)(20).

7. Where an M/WBE Utilization Plan has been submitted, the Contractor shall, with each voucher for payment, and/or periodically as Agency may require, submit statements, certified under penalty of perjury, which shall include, but not be limited to, the total amount the Contractor paid to its direct subcontractors, and, where applicable pursuant to Section 6-129(j), the total amount direct subcontractors paid to indirect subcontractors; the names, addresses and contact numbers of each MBE or WBE hired as a subcontractor by the Contractor, and, where applicable, hired by any of the Contractor's direct subcontractors; and the dates and amounts paid to each MBE or WBE. The Contractor shall also submit, along with its voucher for final payment: the total amount it paid to subcontractors, and, where applicable pursuant to Section 6-129(j), the total amount its direct subcontractors paid directly to their indirect subcontractors; and a final list, certified under penalty of perjury, which shall include the name, address and contact information of each subcontractor that is an MBE or WBE, the work performed by, and the dates and amounts paid to each.

8. If payments made to, or work performed by, MBEs or WBEs are less than the amount specified in the Contractor's M/WBE Utilization Plan, Agency shall take appropriate action, in accordance with Section 6-129 and Article II below, unless the Contractor has obtained a modification of its M/WBE Utilization Plan in accordance with Section 6-129 and Part A, Section 11 below.

9. Where an M/WBE Utilization Plan has been submitted, and the Contractor requests a change order the value of which exceeds the greater of 10 percent of the Contract or Task Order, as applicable, or \$500,000, Agency shall review the scope of work for the Contract or Task Order, as applicable, and the scale and types of work involved in the change order, and determine whether the **Participation Goals** should be modified.

10. Pre-award waiver of the **Participation Goals**. (a) A bidder or proposer, or contractor with respect to a Task Order, may seek a pre-award full or partial waiver of the **Participation Goals** in accordance with Section 6-129, which requests that Agency change one or more **Participation Goals** on the grounds that the **Participation Goals** are unreasonable in light of the availability of certified firms to perform the services required, or by demonstrating that it has legitimate business reasons for proposing a lower level of subcontracting in its M/WBE Utilization Plan.

(b) To apply for a full or partial waiver of the **Participation Goals**, a bidder, proposer, or contractor, as applicable, must complete Part III (Page 5) of Schedule B and submit such request no later than seven (7) calendar days prior to the date and time the bids, proposals, or Task Orders are due, in writing to the Agency by email at [poped@ddc.nyc.gov](mailto:poped@ddc.nyc.gov) or via facsimile at (718) 391-1886. Bidders, proposers, or contractors, as applicable, who have submitted requests will receive an Agency response by no later than two (2) calendar days prior to the due date for bids, proposals, or Task Orders; provided, however, that if that date would fall on a weekend or holiday, an Agency response will be provided by close-of-business on the business day before such weekend or holiday date.

(c) If the Agency determines that the **Participation Goals** are unreasonable in light of the availability of certified firms to perform the services required, it shall revise the solicitation and extend the deadline for bids and proposals, or revise the Task Order, as applicable.

(d) Agency may grant a full or partial waiver of the **Participation Goals** to a bidder, proposer or contractor, as applicable, who demonstrates—before submission of the bid, proposal or Task Order, as applicable—that it has legitimate business reasons for proposing the level of subcontracting in its M/WBE Utilization Plan. In making its determination, Agency shall consider factors that shall include, but not be limited to, whether the bidder, proposer or contractor, as applicable, has the capacity and the bona fide intention to perform the Contract without any subcontracting, or to perform the Contract without awarding the amount of subcontracts represented by the **Participation Goals**. In making such determination, Agency may consider whether the M/WBE Utilization Plan is consistent with past subcontracting practices of the bidder, proposer or contractor, as applicable, whether the bidder, proposer or contractor, as applicable, has made efforts to form a joint venture with a certified firm, and whether the bidder, proposer, or contractor, as applicable, has made good faith efforts to identify other portions of the Contract that it intends to subcontract.

11. **Modification of M/WBE Utilization Plan.** (a) A Contractor may request a modification of its M/WBE Utilization Plan after award of this Contract. **PLEASE NOTE: If this Contract is a public works project subject to GML §101(5) (i.e., a contract valued at or below \$3M for projects in New York City) or if the Contract is subject to a project labor agreement in accordance with Labor Law §222, and the bidder is required to identify at the time of bid submission its intended subcontractors for the Wicks trades (plumbing and gas fitting; steam heating, hot water heating, ventilating and air conditioning (HVAC); and electric wiring), the Contractor may request a Modification of its M/WBE Utilization Plan as part of its bid submission.** The Agency may grant a request for Modification of a Contractor's M/WBE Utilization Plan if it determines that the Contractor has established, with appropriate documentary and other evidence, that it made reasonable, good faith efforts to meet the **Participation Goals**. In making such determination, Agency shall consider evidence of the following efforts, as applicable, along with any other relevant factors:

- (i) The Contractor advertised opportunities to participate in the Contract, where appropriate, in general circulation media, trade and professional association publications and small business media, and publications of minority and women's business organizations;
- (ii) The Contractor provided notice of specific opportunities to participate in the Contract, in a timely manner, to minority and women's business organizations;
- (iii) The Contractor sent written notices, by certified mail or facsimile, in a timely manner, to advise MBEs or WBEs that their interest in the Contract was solicited;
- (iv) The Contractor made efforts to identify portions of the work that could be substituted for portions originally designated for participation by MBEs and/or WBEs in the M/WBE Utilization Plan, and for which the Contractor claims an inability to retain MBEs or WBEs;
- (v) The Contractor held meetings with MBEs and/or WBEs prior to the date their bids or proposals were due, for the purpose of explaining in detail the scope and requirements of the work for which their bids or proposals were solicited;
- (vi) The Contractor made efforts to negotiate with MBEs and/or WBEs as relevant to perform specific subcontracts, or act as suppliers or service providers;
- (vii) Timely written requests for assistance made by the Contractor to Agency's M/WBE liaison officer and to DSBS;
- (viii) Description of how recommendations made by DSBS and Agency were acted upon and an explanation of why action upon such recommendations did not lead to the desired level of participation of MBEs and/or WBEs.

Agency's M/WBE officer shall provide written notice to the Contractor of the determination.

(b) The Agency may modify the **Participation Goals** when the scope of the work has been changed by the Agency in a manner that affects the scale and types of work that the Contractor indicated in its M/WBE Utilization Plan would be awarded to subcontractors.

12. If this Contract is for an indefinite quantity of construction, standard or professional services or is a requirements type contract and the Contractor has submitted an M/WBE Utilization Plan and has committed to subcontract work to MBEs and/or WBEs in order to meet the **Participation Goals**, the Contractor will not be deemed in violation of the M/WBE Program requirements for this Contract with regard to any work which was intended to be subcontracted to an MBE and/or WBE to the extent that the Agency has determined that such work is not needed.

13. If **Participation Goals** have been established for this Contract or a Task Order issued pursuant to this Contract, at least once annually during the term of the Contract or Task Order, as applicable, Agency shall review the Contractor's progress toward attainment of its M/WBE Utilization Plan, including but not limited to, by reviewing the percentage of work the Contractor has actually awarded to MBE and/or WBE subcontractors and the payments the Contractor made to such subcontractors.

14. If **Participation Goals** have been established for this Contract or a Task Order issued pursuant to this Contract, Agency shall evaluate and assess the Contractor's performance in meeting those goals, and such evaluation and assessment shall become part of the Contractor's overall contract performance evaluation.

#### **PART B: MISCELLANEOUS**

1. The Contractor shall take notice that, if this solicitation requires the establishment of an M/WBE Utilization Plan, the resulting contract may be audited by DSBS to determine compliance with Section 6-129. See §6-129(e)(10). Furthermore, such resulting contract may also be examined by the City's Comptroller to assess compliance with the M/WBE Utilization Plan.

2. Pursuant to DSBS rules, construction contracts that include a requirement for an M/WBE Utilization Plan shall not be subject to the law governing Locally Based Enterprises set forth in Section 6-108.1 of the Administrative Code of the City of New York.

3. DSBS is available to assist contractors and potential contractors in determining the availability of MBEs and/or WBEs to participate as subcontractors, and in identifying opportunities that are appropriate for participation by MBEs and/or WBEs in contracts.

4. Prospective contractors are encouraged to enter into qualified joint venture agreements with MBEs and/or WBEs as defined by Section 6-129(c)(30).

5. By submitting a bid or proposal the Contractor hereby acknowledges its understanding of the M/WBE Program requirements set forth herein and the pertinent provisions of Section 6-129, and any rules promulgated thereunder, and if awarded this Contract, the Contractor hereby agrees to comply with the M/WBE Program requirements of this Contract and pertinent provisions of Section 6-129, and any rules promulgated thereunder, all of which shall be deemed to be material terms of this Contract. The Contractor hereby agrees to make all reasonable, good faith efforts to solicit and obtain the participation of MBEs and/or WBEs to meet the required **Participation Goals**.

#### **ARTICLE II. ENFORCEMENT**

1. If Agency determines that a bidder or proposer, as applicable, has, in relation to this procurement, violated Section 6-129 or the DSBS rules promulgated pursuant to Section 6-129, Agency may disqualify such bidder or proposer, as applicable, from competing for this Contract and the Agency may revoke such bidder's or proposer's prequalification status, if applicable.

2. Whenever Agency believes that the Contractor or a subcontractor is not in compliance with Section 6-129 or the DSBS rules promulgated pursuant to Section 6-129, or any provision of this Contract that implements Section 6-129, including, but not limited to any M/WBE Utilization Plan, Agency shall send a written notice to the Contractor describing the alleged noncompliance and offering the Contractor an opportunity to be heard. Agency shall then conduct an investigation to determine whether such Contractor or subcontractor is in compliance.

3. In the event that the Contractor has been found to have violated Section 6-129, the DSBS rules promulgated pursuant to Section 6-129, or any provision of this Contract that implements Section 6-129, including, but not limited to, any M/WBE Utilization Plan, Agency may determine that one of the following actions should be taken:

- (a) entering into an agreement with the Contractor allowing the Contractor to cure the violation;
- (b) revoking the Contractor's pre-qualification to bid or make proposals for future contracts;
- (c) making a finding that the Contractor is in default of the Contract;
- (d) terminating the Contract;
- (e) declaring the Contractor to be in breach of Contract;
- (f) withholding payment or reimbursement;
- (g) determining not to renew the Contract;
- (h) assessing actual and consequential damages;
- (i) assessing liquidated damages or reducing fees, provided that liquidated damages may be based on amounts representing costs of delays in carrying out the purposes of the M/WBE Program, or in meeting the purposes of the Contract, the costs of meeting utilization goals through additional procurements, the administrative costs of investigation and enforcement, or other factors set forth in the Contract;
- (j) exercising rights under the Contract to procure goods, services or construction from another contractor and charge the cost of such contract to the Contractor that has been found to be in noncompliance; or
- (k) taking any other appropriate remedy.

4. If an M/WBE Utilization Plan has been submitted, and pursuant to this Article II, Section 3, the Contractor has been found to have failed to fulfill its **Participation Goals** contained in its M/WBE Utilization Plan or the **Participation Goals** as modified by Agency pursuant to Article I, Part A, Section 11, Agency may assess liquidated damages in the amount of ten percent (10%) of the difference between the dollar amount of work required to be awarded to MBE and/or WBE firms to meet the **Participation Goals** and the dollar amount the Contractor actually awarded and paid, and/or credited, to MBE and/or WBE firms. In view of the difficulty of accurately ascertaining the loss which the City will suffer by reason of Contractor's failure to meet the **Participation Goals**, the foregoing amount is hereby fixed and agreed as the liquidated damages that the City will suffer by reason of such failure, and not as a penalty. Agency may deduct and retain out of any monies which may become due under this Contract the amount of any such liquidated damages; and in case the amount which may become due under this Contract shall be less than the amount of liquidated damages suffered by the City, the Contractor shall be liable to pay the difference.

5. Whenever Agency has reason to believe that an MBE and/or WBE is not qualified for certification, or is participating in a contract in a manner that does not serve a commercially useful function (as defined in Section 6-129(c)(8)), or has violated any provision of Section 6-129, Agency shall notify the Commissioner of DSBS who shall determine whether the certification of such business enterprise should be revoked.

6. Statements made in any instrument submitted to Agency pursuant to Section 6-129 shall be submitted under penalty of perjury and any false or misleading statement or omission shall be grounds for the application of any applicable criminal and/or civil penalties for perjury. The making of a false or fraudulent statement by an MBE and/or WBE in any instrument submitted pursuant to Section 6-129 shall, in addition, be grounds for revocation of its certification.

7. The Contractor's record in implementing its M/WBE Utilization Plan shall be a factor in the evaluation of its performance. Whenever Agency determines that a Contractor's compliance with an M/WBE Utilization Plan has been unsatisfactory, Agency shall, after consultation with the City Chief Procurement Officer, file an advice of caution form for inclusion in VENDEX as caution data.



IN WITNESS WHEREOF, the Commissioner, on behalf of the City of New York, and the Contractor, have executed this agreement in quadruplicate, two parts of which are to remain with the Commissioner, another to be filed with the Comptroller of the City, and the fourth to be delivered to the Contractor.

THE CITY OF NEW YORK

By: \_\_\_\_\_  
Commissioner

CONTRACTOR:

By: \_\_\_\_\_  
(Member of Firm or Officer of Corporation)

Title: \_\_\_\_\_

(Where Contractor is a Corporation, add):  
Attest:

\_\_\_\_\_  
Secretary

(Seal)

ACKNOWLEDGEMENT OF PRINCIPAL, IF A CORPORATION

State of \_\_\_\_\_ County of \_\_\_\_\_ ss:

On this \_\_\_\_\_ day of \_\_\_\_\_, \_\_\_\_\_, before me personally came \_\_\_\_\_ to me known who, being by me duly sworn did depose and say that he resides at \_\_\_\_\_ that he is the \_\_\_\_\_ of the corporation described in and which executed the foregoing instrument; that he knows the seal of said corporation; that one of the seals affixed to said instrument is such seal; that it was so affixed by order of the directors of said corporation, and that he signed his name thereto by like order.

\_\_\_\_\_  
Notary Public or Commissioner of Deeds

ACKNOWLEDGEMENT OF PRINCIPAL, IF A PARTNERSHIP

State of \_\_\_\_\_ County of \_\_\_\_\_ ss:

On this \_\_\_\_\_ day of \_\_\_\_\_, \_\_\_\_\_, before me personally appeared \_\_\_\_\_ to me known, and known to me to be one of the members of the firm of \_\_\_\_\_ described in and who executed the foregoing instrument; and he acknowledged to me that he executed the same as and for the act and deed of said firm.

\_\_\_\_\_  
Notary Public or Commissioner of Deeds

ACKNOWLEDGEMENT OF PRINCIPAL, IF AN INDIVIDUAL

State of \_\_\_\_\_ County of \_\_\_\_\_ ss:

On this \_\_\_\_\_ day of \_\_\_\_\_, \_\_\_\_\_, before me personally appeared \_\_\_\_\_ to me known, and known to me to be the person described in and who executed the foregoing instrument; and acknowledged that he executed the same.

\_\_\_\_\_  
Notary Public or Commissioner of Deeds

ACKNOWLEDGEMENT BY COMMISSIONER

State of \_\_\_\_\_ County of \_\_\_\_\_ ss:

On this \_\_\_\_\_ day of \_\_\_\_\_, \_\_\_\_\_, before me personally came \_\_\_\_\_ to me known, and known to be the Deputy Commissioner of the Department of Design and Construction of The City of New York, the person described as such in and who as such executed the foregoing instrument and acknowledged to me that he executed the same as Deputy Commissioner for the purposes therein mentioned.

\_\_\_\_\_  
Notary Public or Commissioner of Deeds

AUTHORITY

MAYOR'S CERTIFICATE NO. CBX  
BUDGET DIRECTOR'S CERTIFICATE NO.

DATED  
DATED

APPROPRIATION  
COMMISSIONER'S CERTIFICATE

In conformity with the provisions of Section 6-101 of the Administrative Code of the City of New York, it is hereby certified that the estimated cost of the work, materials and supplies required by the within Contract, amounting to

\_\_\_\_\_  
\_\_\_\_\_

Dollars (\$ \_\_\_\_\_)

is chargeable to the fund of the Department of Design and Construction entitled Code

\_\_\_\_\_  
\_\_\_\_\_  
\_\_\_\_\_

Department of Design and Construction

I hereby certify that the specifications contained herein comply with the terms and conditions of the BUDGET.

\_\_\_\_\_

Commissioner

COMPTROLLER'S CERTIFICATE

The City of New York \_\_\_\_\_

Pursuant to the provisions of Section 6-101 of the Administrative Code of the City of New York, I hereby certify that there remains unapplied and unexpended a balance of the above mentioned fund applicable to this Contract sufficient to pay the estimated expense of executing the same viz:

\$ \_\_\_\_\_

\_\_\_\_\_

Comptroller

MAYOR'S CERTIFICATE OR  
CERTIFICATE OF THE DIRECTOR  
OF THE BUDGET

**Performance Bond #1 (Pages 100 to 103): Use if the total contract price is \$5 Million Or Less. Performance Bond #1 has been approved by the U.S. Small Business Administration ("SBA") for participation in its Bond Guarantee Program.**

PERFORMANCE BOND #1 (Page 1)

**PERFORMANCE BOND #1**

**KNOW ALL PERSONS BY THESE PRESENTS,;**

That we, \_\_\_\_\_

\_\_\_\_\_

\_\_\_\_\_

hereinafter referred to as the "Principal,"

and, \_\_\_\_\_

\_\_\_\_\_

\_\_\_\_\_

hereinafter referred to as the "Surety" ("Sureties") are held and firmly bound to THE CITY OF NEW YORK, hereinafter referred to as the "City" or to its successors and assigns in the penal sum of \_\_\_\_\_

\_\_\_\_\_

\_\_\_\_\_

(\$ \_\_\_\_\_) Dollars, lawful money of the United States for the payment of which said sum of money well and truly to be made, we, and each of us, bind ourselves, our heirs, executors, administrators, successors and assigns, jointly and severally, firmly by these presents.

**WHEREAS,** the Principal is about to enter, or has entered, into a Contract in writing with the City for

\_\_\_\_\_

\_\_\_\_\_

a copy of which Contract is annexed to and hereby made a part of this bond as though herein set forth in full;

**NOW, THEREFORE,** the conditions of this obligation are such that if the Principal, his or its representatives or assigns, shall well and faithfully perform the said Contract and all modifications, amendments, additions and alterations thereto that may hereafter be made, according to its terms and its true intent and meaning, including repair and or replacement of defective work and guarantees of maintenance for the periods stated in the Contract, and shall fully indemnify and save harmless the City from all cost and damage which it may suffer by reason of the Principal's default of the Contract, and shall fully reimburse and repay the City for all outlay and expense which the City may incur in making

**Performance Bond #1 (Pages 100 to 103): Use if the total contract price is \$5 Million Or Less. Performance Bond #1 has been approved by the U.S. Small Business Administration ("SBA") for participation in its Bond Guarantee Program.**

PERFORMANCE BOND #1 (Page 2)

good any such default and shall protect the said City of New York against, and pay any and all amounts, damages, cost and judgments which may or shall be recovered against said City or its officers or agents or which the said City of New York may be called upon to pay any person or corporation by reason of any damages arising or growing out of the Principal's default of the Contract, then this obligation shall be null and void, otherwise to remain in full force and effect.

The Surety (Sureties), for value received, hereby stipulates and agrees, upon written notice from the City that the City has determined that the Principal is in default of the Contract, to (1) pay the City the cost to complete the contract as determined by the City in excess of the balance of the Contract held by the City, plus any damages or costs to which the City is entitled, up to the full amount of the above penal sum, (2) fully perform and complete the Work to be performed under the Contract, pursuant to the terms, conditions, and covenants thereof, or (3) tender a completion Contractor that is acceptable to the City. The Surety (Sureties) further agrees, at its option, either to notify the City that it elects to pay the city the cost of completion plus any applicable damages and costs under option (1) above, or to commence and diligently perform the Work specified in the Contract, including physical site work, within twenty-five (25) business days after written notice thereof from the City and, if the Surety elects to fully perform and complete the Work, then to complete all Work within the time set forth in the Contract or such other time as agreed to between the City and Surety in accordance with the Contract. If the Surety elects to tender payment pursuant to (1) above, then the Surety shall tender such amount within fifteen (15) business days notification from the City of the cost of completion. The Surety and the City reserve all rights and defenses each may have against the other; provided, however, that the Surety expressly agrees that its reservation of rights shall not provide a basis for non-performance of its obligation to pay the City the cost of completion, to commence and complete all Work as provided herein, or to tender a completion contractor.

The Surety (Sureties), for value received, for itself and its successors and assigns, hereby stipulates and agrees that the obligation of said Surety (Sureties) and its bond shall be in no way impaired or affected by any extension of time, modification, omission, addition, or change in or to the said Contract or the Work to be performed thereunder, or by any payment thereunder before the time required therein, or by any waiver of any provisions thereof, or any moneys due or to become due thereunder; and said Surety (Sureties) does hereby waive notice of any and all of such extensions, modifications, omissions, additions, changes, payments, and waivers, and hereby expressly stipulates and agrees that any and all things done and omitted to be done by and in relation to subcontractors shall have the same effect as to said Surety (Sureties) as though done or omitted to be done by or in relation to said Principal. Notwithstanding the above, if the City makes payments to the Principal before the time required by the contract that in the aggregate exceed \$100,000 or 10% of the Contract price, whichever is less, and that have not become earned prior to the Principal being found to be in default, then all payments made to the Principal before the time required by the Contract shall be added to the remaining contract value available to be paid for the completion of the Contract as if such sums had not been paid to the Principal, but shall not provide a basis for non-performance of its obligation to pay the City the cost of completion, to commence and to complete all Work as provided herein, or to tender a completion contractor.

**Performance Bond #1 (Pages 100 to 103): Use if the total contract price is \$5 Million Or Less. Performance Bond #1 has been approved by the U.S. Small Business Administration ("SBA") for participation in its Bond Guarantee Program.**

PERFORMANCE BOND #1 (Page 3)

IN WITNESS WHEREOF, The Principal and the Surety (Sureties) have hereunto set their hands and seals, and such of them as are corporations have caused their corporate seals to be hereunto affixed and these presents to be signed by their proper officers, this

\_\_\_\_\_ day of \_\_\_\_\_, 20\_\_\_\_.  
(Seal)

\_\_\_\_\_  
Principal (L.S.)

By: \_\_\_\_\_  
(Seal) Surety

By: \_\_\_\_\_  
(Seal) Surety

By: \_\_\_\_\_  
(Seal) Surety

By: \_\_\_\_\_  
(Seal) Surety

By: \_\_\_\_\_  
(Seal) Surety

By: \_\_\_\_\_

Bond Premium Rate \_\_\_\_\_

Bond Premium Cost \_\_\_\_\_

If the Contractor (Principal) is a partnership, the bond should be signed by each of the individuals who are partners.

If the Contractor (Principal) is a corporation, the bond should be signed in its correct corporate name by a duly authorized officer, agent, or attorney-in-fact.

There should be executed an appropriate number of counterparts of the bond corresponding to the number of counterparts of the Contract.



**Performance Bond #1 (Pages 100 to 103): Use if the total contract price is \$5 Million Or Less. Performance Bond #1 has been approved by the U.S. Small Business Administration ("SBA") for participation in its Bond Guarantee Program.m.**

PERFORMANCE BOND #1 (Page 4)

**ACKNOWLEDGMENT OF PRINCIPAL IF A CORPORATION**

State of \_\_\_\_\_ County of \_\_\_\_\_ ss:

On this \_\_\_\_\_ day of \_\_\_\_\_, 20\_\_\_\_\_ before me personally came \_\_\_\_\_ to me known, who, being by me duly sworn did depose and say that he/she resides at \_\_\_\_\_

\_\_\_\_\_ ; that he/she is the \_\_\_\_\_ of the corporation described in and which executed the foregoing instrument; and that he/she signed his/her name to the foregoing instrument by order of the directors of said corporation as the duly authorized and binding act thereof.

\_\_\_\_\_  
Notary Public or Commissioner of Deeds.

**ACKNOWLEDGMENT OF PRINCIPAL IF A PARTNERSHIP**

State of \_\_\_\_\_ County of \_\_\_\_\_ ss:

On this \_\_\_\_\_ day of \_\_\_\_\_, 20\_\_\_\_\_ before me personally came \_\_\_\_\_ to me known, who, being by me duly sworn did dispose and say that he/she resides at \_\_\_\_\_

\_\_\_\_\_ ; that he/she is \_\_\_\_\_ partner of \_\_\_\_\_, a limited/general partnership existing under the laws of the State of \_\_\_\_\_, the partnership described in and which executed the foregoing instrument; and that he/she signed his/her name to the foregoing instrument as the duly authorized and binding act of said partnership.

\_\_\_\_\_  
Notary Public or Commissioner of Deeds.

**ACKNOWLEDGMENT OF PRINCIPAL IF AN INDIVIDUAL**

State of \_\_\_\_\_ County of \_\_\_\_\_ ss:

On this \_\_\_\_\_ day of \_\_\_\_\_, 20\_\_\_\_\_ before me personally came \_\_\_\_\_ to me known, who, being by me duly sworn did depose and say that he/she resides at \_\_\_\_\_

\_\_\_\_\_ , and that he/she is the individual whose name is subscribed to the within instrument and acknowledged to me that by his/her signature on the instrument, said individual executed the instrument.

\_\_\_\_\_  
Notary Public or Commissioner of Deeds

Each executed bond should be accompanied by: (a) appropriate acknowledgments of the respective parties; (b) appropriate duly certified copy of Power of Attorney or other certificate of authority where bond is executed by agent, officer or other representative of Principal or Surety; (c) a duly certified extract from By-Laws or resolutions of Surety under which Power of Attorney or other certificate of authority of its agent, officer or representative was issued, and (d) certified copy of latest published financial statement of assets and liabilities of Surety.

\*\*\*\*\*

Affix Acknowledgments and Justification of Sureties.

**Performance Bond #2 (Pages 104 to 107): Use if the total contract price is more than \$5 Million.**

PERFORMANCE BOND #2 (Page 1)

**PERFORMANCE BOND #2**

**KNOW ALL PERSONS BY THESE PRESENTS:**

That we, \_\_\_\_\_

\_\_\_\_\_

hereinafter referred to as the "Principal,"

and, \_\_\_\_\_

\_\_\_\_\_

hereinafter referred to as the "Surety" ("Sureties") are held and firmly bound to THE CITY OF NEW YORK, hereinafter referred to as the "City" or to its successors and assigns in the penal sum of \_\_\_\_\_

\_\_\_\_\_

(\$ \_\_\_\_\_) Dollars, lawful money of the United States for the payment of which said sum of money well and truly to be made, we, and each of us, bind ourselves, our heirs, executors, administrators, successors and assigns, jointly and severally, firmly by these presents.

**WHEREAS**, the Principal is about to enter, or has entered, into a Contract in writing with the City for \_\_\_\_\_

\_\_\_\_\_

a copy of which Contract is annexed to and hereby made a part of this bond as though herein set forth in full;

**NOW, THEREFORE**, the conditions of this obligation are such that if the Principal, his or its representatives or assigns, shall well and faithfully perform the said Contract and all modifications, amendments, additions and alterations thereto that may hereafter be made, according to its terms and its true intent and meaning, including repair and or replacement of defective work and guarantees of maintenance for the periods stated in the Contract, and shall fully indemnify and save harmless the City from all cost and damage which it may suffer by reason of the Principal's default of the Contract, and shall fully reimburse and repay the City for all outlay and expense which the City may incur in making

**Performance Bond #2 (Pages 104 to 107): Use if the total contract price is more than \$5 Million.**

PERFORMANCE BOND #2 (Page 2)

good any such default and shall protect the said City of New York against, and pay any and all amounts, damages, cost and judgments which may or shall be recovered against said City or its officers or agents or which the said City of New York may be called upon to pay any person or corporation by reason of any damages arising or growing out of the Principal's default of the Contract, then this obligation shall be null and void, otherwise to remain in full force and effect.

The Surety (Sureties), for value received, hereby stipulates and agrees, upon written notice from the City that the City has determined that the Principal is in default of the Contract, to either (1) pay the full amount of the above penal sum in complete discharge and exoneration of this bond and of all the liabilities of the Surety relating to this bond, or (2) fully perform and complete the Work to be performed under the Contract, pursuant to the terms, conditions, and covenants thereof. The Surety (Sureties) further agrees, at its option, either to tender the penal sum or to commence and diligently perform the Work specified in the Contract, including physical site work, within twenty-five (25) business days after written notice thereof from the City and to complete all Work within the time set forth in the Contract or such other time as agreed to between the City and Surety in accordance with the Contract. The Surety and the City reserve all rights and defenses each may have against the other; provided, however, that the Surety expressly agrees that its reservation of rights shall not provide a basis for non-performance of its obligation to commence and to complete all Work as provided herein.

The Surety (Sureties), for value received, for itself and its successors and assigns, hereby stipulates and agrees that the obligation of said Surety (Sureties) and its bond shall be in no way impaired or affected by any extension of time, modification, omission, addition, or change in or to the said Contract or the Work to be performed thereunder, or by any payment thereunder before the time required therein, or by any waiver of any provisions thereof, or by any assignment, subletting or other transfer thereof or of any Work to be performed or any moneys due or to become due thereunder; and said Surety (Sureties) does hereby waive notice of any and all of such extensions, modifications, omissions, additions, changes, payments, waivers, assignments, subcontracts and transfers, and hereby expressly stipulates and agrees that any and all things done and omitted to be done by and in relation to assignees, subcontractors, and other transferees shall have the same effect as to said Surety (Sureties) as though done or omitted to be done by or in relation to said Principal.

**Performance Bond #2 (Pages 104 to 107): Use if the total contract price is more than \$5 Million.**

PERFORMANCE BOND #2 (Page 3)

**IN WITNESS WHEREOF**, The Principal and the Surety (Sureties) have hereunto set their hands and seals, and such of them as are corporations have caused their corporate seals to be hereunto affixed and these presents to be signed by their proper officers, this

\_\_\_\_\_ day of \_\_\_\_\_ 20 \_\_\_\_\_  
(Seal)

\_\_\_\_\_  
Principal (L.S.)

(Seal) By: \_\_\_\_\_

Surety

(Seal) By: \_\_\_\_\_

Surety

(Seal) By: \_\_\_\_\_

Surety

(Seal) By: \_\_\_\_\_

Surety

(Seal) By: \_\_\_\_\_

Surety

By: \_\_\_\_\_

Bond Premium Rate \_\_\_\_\_

Bond Premium Cost \_\_\_\_\_

If the Contractor (Principal) is a partnership, the bond should be signed by each of the individuals who are partners.

If the Contractor (Principal) is a corporation, the bond should be signed in its correct corporate name by a duly authorized officer, agent, or attorney-in-fact.

There should be executed an appropriate number of counterparts of the bond corresponding to the number of counterparts of the Contract.

**Performance Bond #2 (Pages 104 to 107): Use if the total contract price is more than \$5 Million.**

PERFORMANCE BOND #2 (Page 4)

**ACKNOWLEDGMENT OF PRINCIPAL IF A CORPORATION**

State of \_\_\_\_\_ County of \_\_\_\_\_ ss:

On this \_\_\_\_\_ day of \_\_\_\_\_, 20 \_\_\_\_\_ before me personally  
came \_\_\_\_\_,  
to me known, who, being by me duly sworn did depose and say that he resides  
at \_\_\_\_\_

\_\_\_\_\_ ; that he/she is the \_\_\_\_\_  
of the corporation described in and which executed the foregoing instrument; that he/she signed his/her name to the  
foregoing instrument by order of the directors of said corporation as the duly authorized and binding act thereof.

\_\_\_\_\_  
Notary Public or Commissioner of Deeds.

**ACKNOWLEDGMENT OF PRINCIPAL IF A PARTNERSHIP**

State of \_\_\_\_\_ County of \_\_\_\_\_ ss:

On this \_\_\_\_\_ day of \_\_\_\_\_, 20 \_\_\_\_\_ before me personally  
came \_\_\_\_\_,  
to me known, who, being by me duly sworn did depose and say that he/she resides  
at \_\_\_\_\_

\_\_\_\_\_ ; that he/she is \_\_\_\_\_ partner of  
\_\_\_\_\_, a limited/general partnership existing under the laws of the State of  
\_\_\_\_\_, the partnership described in and which executed the foregoing instrument;  
and that he/she signed his/her name to the foregoing instrument as the duly authorized and binding act of  
said partnership.

\_\_\_\_\_  
Notary Public or Commissioner of Deeds

**ACKNOWLEDGMENT OF PRINCIPAL IF AN INDIVIDUAL**

State of \_\_\_\_\_ County of \_\_\_\_\_ ss:

On this \_\_\_\_\_ day of \_\_\_\_\_, 20 \_\_\_\_\_ before me personally  
came \_\_\_\_\_,  
to me known, who, being by me duly sworn did depose and say that he/she resides  
at \_\_\_\_\_

\_\_\_\_\_, and that he/she is the individual whose name is  
subscribed to the within instrument and acknowledged to me that by his/her signature on the  
instrument, said individual executed the instrument.

\_\_\_\_\_  
Notary Public or Commissioner of Deeds

Each executed bond should be accompanied by: (a) appropriate acknowledgments of the respective parties; (b) appropriate  
duly certified copy of Power of Attorney or other certificate of authority where bond is executed by agent, officer or other  
representative of Principal or Surety; (c) a duly certified extract from By-Laws or resolutions of Surety under which Power  
of Attorney or other certificate of authority of its agent, officer or representative was issued, and (d) certified copy of latest  
published financial statement of assets and liabilities of Surety.

\*\*\*\*\*

Affix Acknowledgments and Justification of Sureties.

**Payment Bond (Pages 108 to 111): Use for any contract for which a Payment Bond is required.**

PAYMENT BOND (Page 1)

PAYMENT BOND

KNOW ALL PERSONS BY THESE PRESENTS, That we, \_\_\_\_\_

\_\_\_\_\_  
\_\_\_\_\_  
\_\_\_\_\_

hereinafter referred to as the "Principal", and \_\_\_\_\_

\_\_\_\_\_  
\_\_\_\_\_  
\_\_\_\_\_

hereinafter referred to as the "Surety" ("Sureties") are held and firmly bound to THE CITY OF NEW YORK, hereinafter referred to as the "City" or to its successors and assigns, in the penal sum of

\_\_\_\_\_  
\_\_\_\_\_  
\_\_\_\_\_

(\$ \_\_\_\_\_) Dollars, lawful money of the United States, for the payment of which said sum of money well and truly to be made, we, and each of us, bind ourselves, our heirs, executors, administrators, successors and assigns, jointly and severally, firmly by these presents.

WHEREAS, the Principal is about to enter, or has entered, into a Contract in writing with the City for

\_\_\_\_\_  
\_\_\_\_\_  
\_\_\_\_\_

a copy of which Contract is annexed to and hereby made a part of this bond as though herein set forth in full;

NOW, THEREFORE, the conditions of this obligation are such that if the Principal, his or its representatives or assigns and other Subcontractors to whom Work under this Contract is sublet and his or their successors and assigns shall promptly pay or cause to be paid all lawful claims for

(a) Wages and compensation for labor performed and services rendered by all persons engaged in the prosecution of the Work under said Contract, and any amendment or extension thereof or addition thereto, whether such persons be agents servants or employees of the Principal or any such Subcontractor, including all persons so engaged who perform the work of laborers or mechanics at or in the vicinity of the site

**Payment Bond (Pages 108 to 111): Use for any contract for which a Payment Bond is required.**

PAYMENT BOND (Page 2)

of the Project regardless of any contractual relationship between the Principal or such Subcontractors, or his or their successors or assigns, on the one hand and such laborers or mechanics on the other, but not including office employees not regularly stationed at the site of the project; and

(b) Materials and supplies (whether incorporated in the permanent structure or not), as well as teams, fuels, oils, implements or machinery furnished, used or consumed by said Principal or any subcontractor at or in the vicinity of the site of the Project in the prosecution of the Work under said Contract and any amendment or extension thereof or addition thereto; then this obligation shall be void, otherwise to remain in full force and effect.

This bond is subject to the following additional conditions, limitations and agreements:

(a) The Principal and Surety (Sureties) agree that this bond shall be for the benefit of any materialmen or laborer having a just claim, as well as the City itself.

(b) All persons who have performed labor, rendered services or furnished materials and supplies, as aforesaid, shall have a direct right of action against the Principal and his, its or their successors and assigns, and the Surety (Sureties) herein, or against either or both or any of them and their successors and assigns. Such persons may sue in their own name, and may prosecute the suit to judgment and execution without the necessity of joining with any other persons as party plaintiff.

(c) The Principal and Surety (Sureties) agree that neither of them will hold the City liable for any judgment for costs of otherwise, obtained by either or both of them against a laborer or materialman in a suit brought by either a laborer or materialman under this bond for moneys allegedly due for performing work or furnishing material.

(d) The Surety (Sureties) or its successors and assigns shall not be liable for any compensation recoverable by an employee or laborer under the Workmen's Compensation Law.

(e) In no event shall the Surety (Sureties), or its successors or assigns, be liable for a greater sum than the penalty of this bond or be subject to any suit, action or proceeding hereon that is instituted by any person, firm, or corporation hereunder later than two years after the complete performance of said Contract and final settlement thereof.

The Principal, for himself and his successors and assigns, and the Surety (Sureties), for itself and its successors and assigns, do hereby expressly waive any objection that might be interposed as to the right of the City to require a bond containing the foregoing provisions, and they do hereby further expressly waive any defense which they or either of them might interpose to an action brought hereon by any person, firm or corporation, including subcontractors, materialmen and third persons, for work, labor, services, supplies or material performed rendered, or furnished as aforesaid upon the ground that there is no law authorizing the City to require the foregoing provisions to be placed in this bond.

And the Surety (Sureties), for value received, for itself and its successors and assigns, hereby stipulates and agrees that the obligation of said Surety (Sureties), and its bonds shall be in no way impaired or affected by any extension of time, modification, omission, addition, or change in or of the said Contract or the work to be performed thereunder, or by any payment thereunder before the time required therein, or by any waiver of any provisions thereof, or by any assignment, subletting or other transfer thereof or of any part thereof, or of any Work to be performed, or any moneys due to become due thereunder and said Surety (Sureties) does hereby waive notice of any and all of such extensions, modifications, omissions, additions, changes, payments, waivers, assignments, subcontracts and transfers, and hereby expressly stipulates and agrees that any and all things done and omitted to be done by and in relation to assignees, Subcontractors, and other transferees shall have the same effect as to said Surety (Sureties) as though done or omitted to be done or in relation to said Principal.

**Payment Bond (Pages 108 to 111): Use for any contract for which a Payment Bond is required.**

PAYMENT BOND (Page 3)

IN WITNESS WHEREOF, the Principal and the Surety (Sureties) have hereunto set their hands and seals, and such of them as are corporations have caused their corporate seals to be hereunto affixed and these presents to be signed by their proper officers, this \_\_\_\_\_ day of \_\_\_\_\_, \_\_\_\_\_.

(Seal) \_\_\_\_\_ (L.S.)  
Principal

By: \_\_\_\_\_

(Seal) \_\_\_\_\_  
Surety

By: \_\_\_\_\_

(Seal) \_\_\_\_\_  
Surety

By: \_\_\_\_\_

(Seal) \_\_\_\_\_  
Surety

By: \_\_\_\_\_

(Seal) \_\_\_\_\_  
Surety

By: \_\_\_\_\_

If the Contractor (Principal) is a partnership, the bond should be signed by each of the individuals who are partners.

If the Contractor (Principal) is a corporation, the bond should be signed in its correct corporate name by a duly authorized officer, agent, or attorney-in-fact.

There should be executed an appropriate number of counterparts of the bond corresponding to the number of counterparts of the Contract.



**Payment Bond (Pages 108 to 111): Use for any contract for which a Payment Bond is required.**

PAYMENT BOND (Page 4)

**ACKNOWLEDGMENT OF PRINCIPAL, IF A CORPORATION**

State of \_\_\_\_\_ County of \_\_\_\_\_ ss:

On this \_\_\_\_ day of \_\_\_\_\_, \_\_\_\_\_, before me personally came \_\_\_\_\_ to me known, who, being by me duly sworn did depose and say that he resides at \_\_\_\_\_ that he is the \_\_\_\_\_ of the corporation described in and which executed the foregoing instrument; that he knows the seal of said corporation; that one of the seals affixed to said instrument is such seal; that it was so affixed by order of the directors of said corporation, and that he signed his name thereto by like order.

\_\_\_\_\_  
Notary Public or Commissioner of Deeds

**ACKNOWLEDGMENT OF PRINCIPAL, IF A PARTNERSHIP**

State of \_\_\_\_\_ County of \_\_\_\_\_ ss:

On this \_\_\_\_ day of \_\_\_\_\_, \_\_\_\_\_, before me personally appeared \_\_\_\_\_ to me known, and known to me to be one of the members of the firm of \_\_\_\_\_ described in and who executed the foregoing instrument; and he acknowledged to me that he executed the same as and for the act and deed of said firm.

\_\_\_\_\_  
Notary Public or Commissioner of Deeds

**ACKNOWLEDGMENT OF PRINCIPAL, IF AN INDIVIDUAL**

State of \_\_\_\_\_ County of \_\_\_\_\_ ss:

On this \_\_\_\_ day of \_\_\_\_\_, \_\_\_\_\_, before me personally appeared \_\_\_\_\_ to me known, and known to me to be the person described in and who executed the foregoing instrument; and acknowledged that he executed the same.

\_\_\_\_\_  
Notary Public or Commissioner of Deeds

Each executed bond should be accompanied by: (a) appropriate acknowledgments of the respective parties; (b) appropriate duly certified copy of Power of Attorney or other certificate of authority where bond is executed by agent, officer or other representative of Principal or Surety; (c) a duly certified extract from By-Laws or resolutions of Surety under which Power of Attorney or other certificate of authority of its agent, officer or representative was issued, and (d) certified copy of latest published financial statement of assets and liabilities of Surety.

\*\*\*\*\*

Affix Acknowledgments and Justification of Sureties.

(NO TEXT ON THIS PAGE)

OFFICE OF THE COMPTROLLER, CITY OF NEW YORK  
§220 PREVAILING WAGE SCHEDULE

LABOR LAW §220 PREVAILING WAGE SCHEDULE

Workers, Laborers and Mechanics employed on a public work project must receive not less than the prevailing rate of wage and benefits for the classification of work performed by each upon such public work. Pursuant to Labor Law §220 the Comptroller of the City of New York has promulgated this schedule solely for Workers, Laborers and Mechanics engaged by private contractors on New York City public work contracts.

This schedule is a compilation of separate determinations of the prevailing rate of wage and supplements made by the Comptroller for each trade classification listed herein pursuant to New York State Labor Law section 220 (5). The source of the wage and supplement rates, whether a collective bargaining agreement, survey data or other, is listed at the end of each classification.

Agency Chief Contracting Officers should contact the Bureau of Labor Law's Classification Unit with any questions concerning trade classifications, prevailing rates or prevailing practices with respect to procurement on New York City public works contracts. Contractors are advised to review the Comptroller's Prevailing Wage Schedule before bidding on public works contracts. Contractors with questions concerning trade classifications, prevailing rates or prevailing practices with respect to public works contracts in the procurement stage must contact the contracting agency responsible for the procurement.

Any error as to compensation under the prevailing wage law or other information as to trade classification, made by the contracting agency in the contract documents or in any other communication, will not preclude a finding against the contractor of prevailing wage violation.

Any questions concerning trade classifications, prevailing rates or prevailing practices on New York City public works contracts that have already been awarded may be directed to the Bureau of Labor Law's Classification Unit by calling (212) 669-7974. All callers must have the agency name and contract registration number available when calling with questions on public works contracts. Please direct all other compliance issues to: Bureau of Labor Law, Attn: Wasyl Kinach, P.E., Office of the Comptroller, 1 Centre Street, Room 1122, New York, N.Y. 10007; Fax (212) 669-4002.

The appropriate schedule of prevailing wages and benefits must be posted at all public work sites pursuant to Labor Law §220 (3-a) (a).

This schedule is applicable to work performed during the effective period, unless otherwise noted. Changes to this schedule are published on our web site [www.comptroller.nyc.gov](http://www.comptroller.nyc.gov). Contractors must pay the wages and supplements in effect when the worker, laborer, mechanic performs the work. Preliminary schedules for future one-year periods appear in the City Record on or about June 1 each succeeding year. Final schedules appear on or about July 1 in the City Record and on our web site [www.comptroller.nyc.gov](http://www.comptroller.nyc.gov).

The Comptroller's Office has attempted to include all overtime, shift and night differential, Holiday, Saturday, Sunday or other premium time work. However, this schedule does not set forth every prevailing practice with respect to such rates with which employers must comply. All such practices are nevertheless part of the employer's prevailing wage obligation and contained in the collective bargaining agreements of the prevailing wage unions. These collective bargaining agreements are available for inspection by appointment. Requests for appointments may be made by calling (212) 669-4443, Monday through Friday between the hours of 9 a.m. and 5 p.m.

OFFICE OF THE COMPTROLLER, CITY OF NEW YORK  
§220 PREVAILING WAGE SCHEDULE

Prevailing rates and ratios for apprentices are attached to this schedule in the Appendix. Pursuant to Labor Law §220 (3-e), only apprentices who are individually registered in a bona fide program to which the employer contractor is a participant, registered with the New York State Department of Labor, may be employed on a public work project. Workers who are not journey persons or not registered apprentices pursuant to Labor Law §220 (3-e) may not be substituted for apprentices and must be paid as journey persons.

Public Work construction, reconstruction, demolition, excavation, rehabilitation, repair, renovation, alteration, or improvement contracts awarded pursuant to a Project Labor Agreement ("PLA") in accordance with Labor Law section 222 may have different labor standards for shift, premium and overtime work. Please refer to the PLA's pre-negotiated labor agreements for wage and benefit rates applicable to work performed outside of the regular workday. More information is available at the Mayor's Office of Contract Services (MOCS) web page at <http://www.nyc.gov/html/mocs/html/vendors/pla.shtml>.

All the provisions of Labor Law section 220 remain applicable to PLA work including, but not limited to, the enforcement of prevailing wage requirements by the Comptroller; however, we will enforce shift, premium, overtime and other non-standard rates as they appear in a project's pre-negotiated labor agreement.

In order to meet their obligation to provide prevailing supplemental benefits to each covered employee, employers must either:

- 1) Provide bona-fide benefits which cost the employer no less than the prevailing supplemental benefits rate; or
- 2) Supplement the employee's hourly wage by an amount no less than the prevailing supplemental benefits rate; or
- 3) Provide a combination of bona-fide benefits and wage supplements which cost the employer no less than the prevailing supplemental benefits rate in total.

Particular attention should be given to the supplemental benefits requirement. Although in most instances the payment or provision for supplemental benefits is for each hour worked, some classifications require the payment or provision of supplemental benefits for each hour paid. Consequently, some prevailing practices require benefits to be purchased at the overtime, shift differential, Holiday, Saturday, Sunday or other premium time rate.

Benefits are paid for **EACH HOUR WORKED** unless otherwise noted.

Wasył Kinach, P.E.  
Director of Classifications  
Bureau of Labor Law

OFFICE OF THE COMPTROLLER, CITY OF NEW YORK  
§220 PREVAILING WAGE SCHEDULE

**TABLE OF CONTENTS**

<b><u>CLASSIFICATION</u></b>	<b><u>PAGE</u></b>
ASBESTOS HANDLER .....	5
BLASTER.....	5
BOILERMAKER.....	7
BRICKLAYER.....	8
CARPENTER - BUILDING COMMERCIAL .....	9
CARPENTER - HEAVY CONSTRUCTION WORK .....	10
CARPENTER - SIDEWALK SHED, SCAFFOLD AND HOIST.....	11
CEMENT & CONCRETE WORKER .....	12
CEMENT MASON .....	13
CORE DRILLER.....	14
DERRICKPERSON AND RIGGER.....	15
DIVER.....	16
DOCKBUILDER - PILE DRIVER.....	17
DRIVER: TRUCK (TEAMSTER).....	17
ELECTRICIAN .....	20
ELECTRICIAN - ALARM TECHNICIAN .....	23
ELECTRICIAN-STREET LIGHTING WORKER.....	24
ELEVATOR CONSTRUCTOR .....	26
ELEVATOR REPAIR & MAINTENANCE .....	27
ENGINEER.....	28
ENGINEER - CITY SURVEYOR AND CONSULTANT.....	32
ENGINEER - FIELD (BUILDING CONSTRUCTION).....	33
ENGINEER - FIELD (HEAVY CONSTRUCTION).....	34
ENGINEER - FIELD (STEEL ERECTION).....	35
ENGINEER - OPERATING .....	36
FLOOR COVERER .....	44
GLAZIER.....	45
GLAZIER - REPAIR & MAINTENANCE.....	46
HEAT AND FROST INSULATOR.....	47
HOUSE WRECKER .....	48
IRON WORKER - ORNAMENTAL .....	49
IRON WORKER - STRUCTURAL .....	50
LABORER.....	50

OFFICE OF THE COMPTROLLER, CITY OF NEW YORK  
§220 PREVAILING WAGE SCHEDULE

LANDSCAPING .....	51
MARBLE MECHANIC.....	53
MASON TENDER .....	54
MASON TENDER (INTERIOR DEMOLITION WORKER).....	55
METALLIC LATHER.....	56
MILLWRIGHT.....	57
MOSAIC MECHANIC .....	58
PAINTER.....	59
PAINTER - METAL POLISHER.....	60
PAINTER - STRIPER.....	61
PAINTER - STRUCTURAL STEEL .....	62
PAPERHANGER.....	63
PAVER AND ROADBUILDER.....	64
PLASTERER.....	65
PLASTERER - TENDER.....	66
PLUMBER.....	67
PLUMBER (MECHNICAL EQUIPMENT AND SERVICE).....	68
PLUMBER (RESIDENTIAL RATES FOR 1, 2 AND 3 FAMILY HOME CONSTRUCTION).....	69
PLUMBER: PUMP & TANK.....	70
POINTER, WATERPROOFER, CAULKER, SANDBLASTER, STEAMBLASTER .....	70
ROOFER.....	71
SHEET METAL WORKER.....	72
SHEET METAL WORKER - SPECIALTY .....	73
SHIPYARD WORKER.....	74
SIGN ERECTOR .....	75
STEAMFITTER .....	76
STEAMFITTER - REFRIGERATION AND AIR CONDITIONER .....	78
STONE MASON - SETTER .....	80
TAPER .....	81
TELECOMMUNICATION WORKER.....	81
TILE FINISHER .....	83
TILE LAYER - SETTER .....	83
TIMBERPERSON.....	84
TUNNEL WORKER.....	85
WELDER.....	87

OFFICE OF THE COMPTROLLER, CITY OF NEW YORK  
§220 PREVAILING WAGE SCHEDULE

**ASBESTOS HANDLER**

(Hazardous Material; Disturbs, removes, encapsulates, repairs, or encloses friable asbestos material)

**Asbestos Handler**

Effective Period: 7/1/2016 - 6/30/2017

Wage Rate per Hour: \$36.00

Supplemental Benefit Rate per Hour: \$16.45

**Overtime**

Time and one half the regular rate after an 8 hour day.

Time and one half the regular rate for Sunday.

Time and one half the regular hourly rate after 40 hours in any work week.

**Overtime Holidays**

Time and one half the regular rate for work on the following holiday(s).

New Year's Day

Good Friday

Memorial Day

Independence Day

Labor Day

Thanksgiving Day

Christmas Day

Easter

**Paid Holidays**

None

(Local #78 and Local #12A)

---

**BLASTER**

**Blaster**

Effective Period: 7/1/2016 - 6/30/2017

Wage Rate per Hour: \$44.93

Supplemental Benefit Rate per Hour: \$46.24

**Blaster (Hydraulic)**

Effective Period: 7/1/2016 - 6/30/2017

OFFICE OF THE COMPTROLLER, CITY OF NEW YORK  
§220 PREVAILING WAGE SCHEDULE

Wage Rate per Hour: \$45.78  
Supplemental Benefit Rate per Hour: \$46.24

**Blaster - Trac Drill Hydraulic**

Effective Period: 7/1/2016 - 6/30/2017  
Wage Rate per Hour: \$40.12  
Supplemental Benefit Rate per Hour: \$46.24

**Blaster - Wagon: Air Trac: Quarry Bar: Drillrunners**

Effective Period: 7/1/2016 - 6/30/2017  
Wage Rate per Hour: \$39.31  
Supplemental Benefit Rate per Hour: \$46.24

**Blaster - Operators of Jack Hammers**

Chippers: Spaders: Concrete Breakers: and all other pneumatic tools of like usage: Walk Behind Self Propelled Hydraulic Asphalt and Concrete Breakers: Hydro (Water) Demolition

Effective Period: 7/1/2016 - 6/30/2017  
Wage Rate per Hour: \$38.23  
Supplemental Benefit Rate per Hour: \$46.24

**Blaster - Powder Carriers**

Effective Period: 7/1/2016 - 6/30/2017  
Wage Rate per Hour: \$34.20  
Supplemental Benefit Rate per Hour: \$46.24

**Blaster - Hydraulic Trac Drill Chuck Tender**

Effective Period: 7/1/2016 - 6/30/2017  
Wage Rate per Hour: \$32.88  
Supplemental Benefit Rate per Hour: \$46.24

**Blaster - Chuck Tender & Nipper**

Effective Period: 7/1/2016 - 6/30/2017  
Wage Rate per Hour: \$32.10  
Supplemental Benefit Rate per Hour: \$46.24

**Blaster - Magazine Keepers: (Watch Person)**

Effective Period: 7/1/2016 - 6/30/2017  
Wage Rate per Hour: \$17.80  
Supplemental Benefit Rate per Hour: \$46.24



OFFICE OF THE COMPTROLLER, CITY OF NEW YORK  
\$220 PREVAILING WAGE SCHEDULE

**Overtime Description**

**Magazine Keepers:**

Time and one half for work performed in excess of forty (40) hours per week and for work performed on Saturdays, Sundays and Holidays.

**All Other Employees:**

Time and one-half for the first two hours of overtime Monday through Friday, the first ten hours, the first ten hours of work on Saturday and for Make-up Time. Double time for all hours over ten Monday through Saturday (except make-up hours) and for all hours worked on Sunday and Holidays.

**Overtime Holidays**

Double time the regular rate for work on the following holiday(s).

New Year's Day  
Memorial Day  
Independence Day  
Labor Day  
Columbus Day  
Presidential Election Day  
Thanksgiving Day  
Christmas Day

**Paid Holidays**

None

**Shift Rates**

A single shift shall be 8 hours plus an unpaid lunch, starting at 8:00 A.M (or between 6:00 A.M. and 10:00 A.M. on weekdays). When two (2) shifts are employed, each shift shall be 8 hours plus ½ hour unpaid lunch. When three (3) shifts are employed, each shift will work seven and one-half (7 ½) hours, but will be paid for eight (8) hours, since only one-half (½) hour is allowed for mealtime. When two (2) or more shifts are employed, single time will be paid for each shift. The first 8 hours of any and all work performed Monday through Friday inclusive of any off-shift shall be at the single time rate.

(Local #29)

---

---

**BOILERMAKER**

**Boilermaker**

Effective Period: 7/1/2016 - 12/31/2016

Wage Rate per Hour: \$53.36

Supplemental Benefit Rate per Hour: \$42.33

Supplemental Note: For time and one half overtime - \$62.88 For double overtime - \$83.42

Effective Period: 1/1/2017 - 6/30/2017

Wage Rate per Hour: \$55.23

Supplemental Benefit Rate per Hour: \$42.96

Supplemental Note: For time and one half overtime - \$63.82 For double overtime - \$84.68

OFFICE OF THE COMPTROLLER, CITY OF NEW YORK  
§220 PREVAILING WAGE SCHEDULE

**Overtime Description**

For Repair and Maintenance work:

Time and one half the regular rate after an 8 hour day.

Time and one half the regular rate for Saturday.

Double time the regular rate for Sunday.

For New Construction work:

Double time the regular rate after an 8 hour day.

Double time the regular time rate for Saturday.

Double time the regular rate for Sunday.

**Overtime Holidays**

Double time the regular rate for work on the following holiday(s).

New Year's Day

President's Day

Memorial Day

Independence Day

Columbus Day

Election Day

Veteran's Day

Thanksgiving Day

Christmas Day

Quadruple time the regular rate for work on the following holiday(s).

Labor Day

**Paid Holidays**

Good Friday

Day after Thanksgiving

Day before Christmas

Day before New Year's Day

**Shift Rates**

When shifts are required, the first shift shall work eight (8) hours at the regular straight-time hourly rate. The second shift shall work seven and one-half (7 ½) hours and receive eight hours at the regular straight time hourly rate plus twenty-five cents (\$0.25) per hour. The third shift shall work seven (7) hours and receive eight hours at the regular straight time hourly rate plus fifty cents (\$0.50) per hour. A thirty (30) minute lunch period shall not be considered as time worked. Work in excess of the above shall be paid overtime at the appropriate new construction work or repair work overtime wage and supplemental benefit hourly rate.

(Local #5)

---

---

**BRICKLAYER**

**Bricklayer**

Effective Period: 7/1/2016 - 6/30/2017

Wage Rate per Hour: \$52.59

OFFICE OF THE COMPTROLLER, CITY OF NEW YORK  
§220 PREVAILING WAGE SCHEDULE

Supplemental Benefit Rate per Hour: \$30.00

**Overtime**

Time and one half the regular rate after a 7 hour day.

Time and one half the regular rate for Saturday.

Double time the regular rate for Sunday.

Saturday may be used as a make-up day at straight time when a day is lost during that week to inclement weather.

**Overtime Holidays**

Double time the regular rate for work on the following holiday(s).

New Year's Day

President's Day

Memorial Day

Independence Day

Labor Day

Thanksgiving Day

Christmas Day

**Paid Holidays**

None

**Shift Rates**

Overtime rates to be paid outside the regular scheduled work day.

(Bricklayer District Council)

---

**CARPENTER - BUILDING COMMERCIAL**

**Building Commercial**

Effective Period: 7/1/2016 - 6/30/2017

Wage Rate per Hour: \$52.50

Supplemental Benefit Rate per Hour: \$46.28

**Overtime**

Time and one half the regular rate after an 8 hour day.

Time and one half the regular rate for Saturday.

Double time the regular rate for Sunday.

Saturday may be used as a make-up day at straight time when a day is lost during that week to inclement weather.

**Overtime Holidays**

Double time the regular rate for work on the following holiday(s).

New Year's Day

Washington's Birthday

OFFICE OF THE COMPTROLLER, CITY OF NEW YORK  
§220 PREVAILING WAGE SCHEDULE

Memorial Day  
Independence Day  
Labor Day  
Columbus Day  
Presidential Election Day  
Thanksgiving Day  
Day after Thanksgiving  
Christmas Day

**Paid Holidays**

None

**Shift Rates**

The second shift will receive one hour at the double time rate of pay for the last hour of the shift; eight hours pay for seven hours of work, nine hours pay for eight hours of work. There must be a first shift in order to work a second shift.

(Carpenters District Council)

---

---

**CARPENTER - HEAVY CONSTRUCTION WORK**  
(Construction of Engineering Structures and Building Foundations)

**Heavy Construction Work**

Effective Period: 7/1/2016 - 6/30/2017

Wage Rate per Hour: \$51.63

Supplemental Benefit Rate per Hour: \$48.65

**Overtime**

Time and one half the regular rate after an 8 hour day.

Time and one half the regular rate for Saturday.

Double time the regular rate for Sunday.

Saturday may be used as a make-up day at straight time when a day is lost during that week to inclement weather.

**Overtime Holidays**

Double time the regular rate for work on the following holiday(s).

New Year's Day

President's Day

Memorial Day

Independence Day

Labor Day

Columbus Day

Presidential Election Day

Thanksgiving Day

Christmas Day

OFFICE OF THE COMPTROLLER, CITY OF NEW YORK  
§220 PREVAILING WAGE SCHEDULE

**Paid Holidays**

None

**Shift Rates**

Off shift work commencing between 5:00 P.M. and 11:00 P.M. shall work eight and one half hours allowing for one half hour for lunch. The wage rate shall be 113% of the straight time hourly wage rate.

(Carpenters District Council)

---

---

**CARPENTER - SIDEWALK SHED, SCAFFOLD AND HOIST**

**Carpenter - Hod Hoist**

(Assisted by Mason Tender)

Effective Period: 7/1/2016 - 6/30/2017

Wage Rate per Hour: \$50.50

Supplemental Benefit Rate per Hour: \$44.80

**Overtime**

Time and one half the regular rate after an 8 hour day.

Time and one half the regular rate for Saturday.

Double time the regular rate for Sunday.

Saturday may be used as a make-up day at straight time when a day is lost during that week to inclement weather.

**Overtime Holidays**

Double time the regular rate for work on the following holiday(s).

New Year's Day

President's Day

Memorial Day

Independence Day

Labor Day

Columbus Day

Presidential Election Day

Thanksgiving Day

Day after Thanksgiving

Christmas Day

**Paid Holidays**

None

**Shift Rates**

OFFICE OF THE COMPTROLLER, CITY OF NEW YORK  
\$220 PREVAILING WAGE SCHEDULE

The second shift will receive one hour at the double time rate of pay for the last hour of the shift; eight hours pay for seven hours of work, nine hours pay for eight hours of work. There must be a first shift in order to work a second shift.

(Carpenters District Council)

---

---

## **CEMENT & CONCRETE WORKER**

### **Cement & Concrete Worker**

Effective Period: 7/1/2016 - 6/30/2017

Wage Rate per Hour: **\$42.48**

Supplemental Benefit Rate per Hour: **\$23.00**

Supplemental Note: **\$25.75 on Saturdays; \$28.50 on Sundays & Holidays**

### **Cement & Concrete Worker - (Hired after 2/6/2016)**

Effective Period: 7/1/2016 - 6/30/2017

Wage Rate per Hour: **\$32.00**

Supplemental Benefit Rate per Hour: **\$16.00**

Supplemental Note: **\$17.25 on Saturdays; \$18.50 on Sundays & Holidays**

### **Overtime Description**

Time and one half the regular rate after 7 hour day (time and one half the regular rate after an 8 hour day when working with Dockbuilders on pile cap forms and for work below street level to the top of the foundation wall, not to exceed 2 feet or 3 feet above the sidewalk-brick shelf, when working on the foundation and structure.)

### **Overtime**

Time and one half the regular rate for Saturday.

Double time the regular rate for Sunday.

### **Overtime Holidays**

Double time the regular rate for work on the following holiday(s).

New Year's Day

President's Day

Good Friday

Memorial Day

Independence Day

Labor Day

Columbus Day

Presidential Election Day

Thanksgiving Day

Christmas Day

### **Paid Holidays**

1/2 day before Christmas Day

OFFICE OF THE COMPTROLLER, CITY OF NEW YORK  
§220 PREVAILING WAGE SCHEDULE

1/2 day before New Year's Day

### Shift Rates

On shift work extending over a twenty-four hour period, all shifts are paid at straight time.

(Cement Concrete Workers District Council)

---

## CEMENT MASON

### Cement Mason

Effective Period: 7/1/2016 - 6/30/2017

Wage Rate per Hour: \$40.72

Supplemental Benefit Rate per Hour: \$38.96

Supplemental Note: For time and one half overtime - \$48.21; For double overtime - \$57.46

### Overtime Description

Time and one-half the regular rate after an 8 hour day, double time the regular rate after 10 hours. Time and one-half the regular rate on Saturday, double time the regular rate after 10 hours. Double time the regular rate on Sunday.

### Overtime Holidays

Double time the regular rate for work on the following holiday(s).

New Year's Day

President's Day

Good Friday

Memorial Day

Independence Day

Labor Day

Columbus Day

Presidential Election Day

Thanksgiving Day

Christmas Day

### Paid Holidays

Any worker who reports to work on Christmas Eve or New Year's Eve pursuant to his employer's instruction shall be entitled to three (3) hours afternoon pay without working.

### Shift Rates

For an off shift day, (work at times other than the regular 7:00 A.M. to 3:30 P.M. work day) a cement mason shall be paid at the regular hourly rate plus a 25% per hour differential. Four Days a week at Ten (10)hour day.

(Local #780) (BCA)

---

OFFICE OF THE COMPTROLLER, CITY OF NEW YORK  
\$220 PREVAILING WAGE SCHEDULE

---

## **CORE DRILLER**

### **Core Driller**

Effective Period: 7/1/2016 - 6/30/2017

Wage Rate per Hour: \$37.82

Supplemental Benefit Rate per Hour: \$24.00

### **Core Driller Helper**

Effective Period: 7/1/2016 - 6/30/2017

Wage Rate per Hour: \$30.17

Supplemental Benefit Rate per Hour: \$24.00

### **Core Driller Helper (Third year in the industry)**

Effective Period: 7/1/2016 - 6/30/2017

Wage Rate per Hour: \$27.15

Supplemental Benefit Rate per Hour: \$24.00

### **Core Driller Helper (Second year in the industry)**

Effective Period: 7/1/2016 - 6/30/2017

Wage Rate per Hour: \$24.14

Supplemental Benefit Rate per Hour: \$24.00

### **Core Driller Helper (First year in the industry)**

Effective Period: 7/1/2016 - 6/30/2017

Wage Rate per Hour: \$21.12

Supplemental Benefit Rate per Hour: \$24.00

### **Overtime Description**

Time and one half the regular rate for work on a holiday plus Holiday pay when worked.

### **Overtime**

Time and one half the regular rate after an 8 hour day.

Time and one half the regular rate for Saturday.

Double time the regular rate for Sunday.

Time and one half the regular rate for work on the following holiday(s).

### **Paid Holidays**

New Year's Day

Memorial Day

Independence Day

Labor Day



OFFICE OF THE COMPTROLLER, CITY OF NEW YORK  
§220 PREVAILING WAGE SCHEDULE

Thanksgiving Day  
Christmas Day

### Shift Rates

The shift day shall be the continuous eight and one-half (8½) hours from 6:00 A.M. to 2:30 P.M. and from 2:30 P.M. to 11:00 P.M., including one-half (½) hour of employees regular rate of pay for lunch. When two (2) or more shifts are employed, single time shall be paid for each shift, but those employees employed on a shift other than from 8:00 A.M. to 5:00 P.M. shall, in addition, receive seventy-five cents (\$0.75) per hour differential for each hour worked. When three (3) shifts are needed, each shift shall work seven and one-half (7 ½) hours paid for eight (8) hours of labor and be permitted one-half (½) hour for mealtime.

(Carpenters District Council)

---

---

## DERRICKPERSON AND RIGGER

### Derrick Person & Rigger

Effective Period: 7/1/2016 - 6/30/2017

Wage Rate per Hour: \$45.48

Supplemental Benefit Rate per Hour: \$50.00

Supplemental Note: The above supplemental rate applies for work performed in Manhattan, Bronx, Brooklyn and Queens. \$51.42 - For work performed in Staten Island.

### Overtime Description

The first two hours of overtime on weekdays and the first seven hours of work on Saturdays are paid at time and one half for wages and supplemental benefits. All additional overtimes is paid at double time for wages and supplemental benefits. Deduct \$1.42 from the Staten Island hourly benefits rate before computing overtime.

### Overtime

Double time the regular rate for Sunday.

### Overtime Holidays

Double time the regular rate for work on the following holiday(s).

New Year's Day  
Washington's Birthday  
Good Friday  
Memorial Day  
Independence Day  
Labor Day  
Thanksgiving Day  
Christmas Day

### Paid Holidays

1/2 day on Christmas Eve if work is performed in the A.M.

(Local #197)

OFFICE OF THE COMPTROLLER, CITY OF NEW YORK  
§220 PREVAILING WAGE SCHEDULE

---

---

## **DIVER**

### **Diver (Marine)**

Effective Period: 7/1/2016 - 6/30/2017

Wage Rate per Hour: \$65.38

Supplemental Benefit Rate per Hour: \$48.65

### **Diver Tender (Marine)**

Effective Period: 7/1/2016 - 6/30/2017

Wage Rate per Hour: \$46.44

Supplemental Benefit Rate per Hour: \$48.65

### **Overtime**

Time and one half the regular rate after an 8 hour day.

Time and one half the regular rate for Saturday.

Double time the regular rate for Sunday.

Saturday may be used as a make-up day at straight time when a day is lost during that week to inclement weather.

### **Overtime Holidays**

Double time the regular rate for work on the following holiday(s).

New Year's Day

President's Day

Memorial Day

Independence Day

Labor Day

Columbus Day

Presidential Election Day

Thanksgiving Day

Christmas Day

### **Paid Holidays**

None

### **Shift Rates**

When three shifts are utilized each shift shall work seven and one half-hours (7 1/2 hours) and paid for 8 hours, allowing for one half hour for lunch.

(Carpenters District Council)

---

---

OFFICE OF THE COMPTROLLER, CITY OF NEW YORK  
\$220 PREVAILING WAGE SCHEDULE

## **DOCKBUILDER - PILE DRIVER**

### **Dockbuilder - Pile Driver**

Effective Period: 7/1/2016 - 6/30/2017

Wage Rate per Hour: **\$51.63**

Supplemental Benefit Rate per Hour: **\$48.65**

### **Overtime**

Time and one half the regular rate after an 8 hour day.

Time and one half the regular rate for Saturday.

Double time the regular rate for Sunday.

Saturday may be used as a make-up day at straight time when a day is lost during that week to inclement weather.

### **Overtime Holidays**

Double time the regular rate for work on the following holiday(s).

New Year's Day

President's Day

Memorial Day

Independence Day

Labor Day

Columbus Day

Presidential Election Day

Thanksgiving Day

Christmas Day

### **Paid Holidays**

None

### **Shift Rates**

Off shift work commencing between 5:00 P.M. and 11:00 P.M. shall work eight and one half hours allowing for one half hour for lunch. The wage rate shall be 113% of the straight time hourly wage rate.

(Carpenters District Council)

---

---

## **DRIVER: TRUCK (TEAMSTER)**

### **Driver - Dump Truck**

Effective Period: 7/1/2016 - 6/30/2017

Wage Rate per Hour: **\$40.15**

Supplemental Benefit Rate per Hour: **\$43.39**

Supplemental Note: Over 40 hours worked: at time and one half rate - \$18.44; at double time rate - \$24.58

OFFICE OF THE COMPTROLLER, CITY OF NEW YORK  
\$220 PREVAILING WAGE SCHEDULE

**Driver - Tractor Trailer**

Effective Period: 7/1/2016 - 6/30/2017

Wage Rate per Hour: \$41.46

Supplemental Benefit Rate per Hour: \$43.65

Supplemental Note: Over 40 hours worked: at time and one half rate - \$16.65; at double time rate - \$22.20

**Driver - Euclid & Turnapull Operator**

Effective Period: 7/1/2016 - 6/30/2017

Wage Rate per Hour: \$42.03

Supplemental Benefit Rate per Hour: \$43.65

Supplemental Note: Over 40 hours worked: at time and one half rate - \$16.65; at double time rate - \$22.20

**Overtime Description**

For Paid Holidays: Holiday pay for all holidays shall be prorated based two hours per day for each day worked in the holiday week, not to exceed 8 hours of holiday pay. For Thanksgiving week, the prorated share shall be 5 1/3 hours of holiday pay for each day worked in Thanksgiving week.

**Overtime**

Time and one half the regular rate after an 8 hour day.

Time and one half the regular rate for Saturday.

Double time the regular rate for Sunday.

**Overtime Holidays**

Double time the regular rate for work on the following holiday(s).

New Year's Day

President's Day

Memorial Day

Independence Day

Labor Day

Columbus Day

Veteran's Day

Thanksgiving Day

Day after Thanksgiving

Christmas Day

**Paid Holidays**

New Year's Day

President's Day

Memorial Day

Independence Day

Labor Day

Columbus Day

Veteran's Day

Thanksgiving Day

Day after Thanksgiving

Christmas Day

**Shift Rates**

Off single shift work commencing between 6:00 P.M. and 5:00 A.M. shall work eight and one half hours allowing for one half hour for lunch and receive 9 hours pay for 8 hours of work.

OFFICE OF THE COMPTROLLER, CITY OF NEW YORK  
\$220 PREVAILING WAGE SCHEDULE

---

**Driver Redi-Mix (Sand & Gravel)**

Effective Period: 7/1/2016 - 6/30/2017

Wage Rate per Hour: **\$36.30**

Supplemental Benefit Rate per Hour: **\$40.02**

Supplemental Note: Over 40 hours worked: time and one half rate \$13.90, double time rate \$18.53

**Overtime Description**

For Paid Holidays: Employees working two (2) days in the calendar week in which the holiday falls are to paid for these holidays, provided they shape each remaining workday during that calendar week.

**Overtime**

Time and one half the regular rate after an 8 hour day.

Time and one half the regular rate for Saturday.

Double time the regular rate for Sunday.

**Overtime Holidays**

Double time the regular rate for work on the following holiday(s).

President's Day

Columbus Day

Veteran's Day

Triple time the regular rate for work on the following holiday(s).

New Year's Day

Memorial Day

Independence Day

Labor Day

Thanksgiving Day

Christmas Day

**Paid Holidays**

New Year's Day

President's Day

Memorial Day

Independence Day

Labor Day

Columbus Day

Election Day

Thanksgiving Day

Christmas Day

(Local #282)

---

---

OFFICE OF THE COMPTROLLER, CITY OF NEW YORK  
\$220 PREVAILING WAGE SCHEDULE

**ELECTRICIAN**

(Including all low voltage cabling carrying data; video; and voice in combination with data and or video.)

**Electrician "A" (Regular Day)**

Effective Period: 7/1/2016 - 5/10/2017

Wage Rate per Hour: **\$54.00**

Supplemental Benefit Rate per Hour: **\$51.86**

Effective Period: 5/11/2017 - 6/30/2017

Wage Rate per Hour: **\$56.00**

Supplemental Benefit Rate per Hour: **\$54.35**

**Electrician "A" (Regular Day Overtime)**

Effective Period: 7/1/2016 - 5/10/2017

Wage Rate per Hour: **\$81.00**

Supplemental Benefit Rate per Hour: **\$55.24**

Effective Period: 5/11/2017 - 6/30/2017

Wage Rate per Hour: **\$84.00**

Supplemental Benefit Rate per Hour: **\$57.86**

**Electrician "A" (Day Shift)**

Effective Period: 7/1/2016 - 5/10/2017

Wage Rate per Hour: **\$54.00**

Supplemental Benefit Rate per Hour: **\$51.86**

Effective Period: 5/11/2017 - 6/30/2017

Wage Rate per Hour: **\$56.00**

Supplemental Benefit Rate per Hour: **\$54.35**

**Electrician "A" (Day Shift Overtime After 8 hours)**

Effective Period: 7/1/2016 - 5/10/2017

Wage Rate per Hour: **\$81.00**

Supplemental Benefit Rate per Hour: **\$55.24**

Effective Period: 5/11/2017 - 6/30/2017

Wage Rate per Hour: **\$84.00**

Supplemental Benefit Rate per Hour: **\$57.86**

**Electrician "A" (Swing Shift)**

Effective Period: 7/1/2016 - 5/10/2017

OFFICE OF THE COMPTROLLER, CITY OF NEW YORK  
§220 PREVAILING WAGE SCHEDULE

Wage Rate per Hour: \$63.36  
Supplemental Benefit Rate per Hour: \$59.01

Effective Period: 5/11/2017 - 6/30/2017  
Wage Rate per Hour: \$65.71  
Supplemental Benefit Rate per Hour: \$61.94

**Electrician "A" (Swing Shift Overtime After 7.5 hours)**

Effective Period: 7/1/2016 - 5/10/2017  
Wage Rate per Hour: \$95.04  
Supplemental Benefit Rate per Hour: \$62.98

Effective Period: 5/11/2017 - 6/30/2017  
Wage Rate per Hour: \$98.57  
Supplemental Benefit Rate per Hour: \$66.05

**Electrician "A" (Graveyard Shift)**

Effective Period: 7/1/2016 - 5/10/2017  
Wage Rate per Hour: \$70.97  
Supplemental Benefit Rate per Hour: \$65.05

Effective Period: 5/11/2017 - 6/30/2017  
Wage Rate per Hour: \$73.60  
Supplemental Benefit Rate per Hour: \$68.33

**Electrician "A" (Graveyard Shift Overtime After 7 hours)**

Effective Period: 7/1/2016 - 5/10/2017  
Wage Rate per Hour: \$106.46  
Supplemental Benefit Rate per Hour: \$69.50

Effective Period: 5/11/2017 - 6/30/2017  
Wage Rate per Hour: \$110.40  
Supplemental Benefit Rate per Hour: \$72.95

**Overtime**

Time and one half the regular rate after a 7 hour day.  
Time and one half the regular rate for Saturday.  
Time and one half the regular rate for Sunday.

**Overtime Holidays**

Time and one half the regular rate for work on a holiday.  
New Year's Day  
Martin Luther King Jr. Day  
President's Day  
Memorial Day  
Independence Day  
Labor Day

OFFICE OF THE COMPTROLLER, CITY OF NEW YORK  
\$220 PREVAILING WAGE SCHEDULE

Columbus Day  
Veteran's Day  
Thanksgiving Day  
Day after Thanksgiving  
Christmas Day

**Paid Holidays**

None

**Shift Rates**

When so elected by the Employer, one or more shifts of at least five days duration may be scheduled as follows:  
Day Shift: 8:00 am to 4:30 pm, Swing Shift 4:30 pm to 12:30 am, Graveyard Shift: 12:30 am to 8:00 am.

For multiple shifts of temporary light and/or power, the temporary light and/or power employee shall be paid for 8 hours at the straight time rate. For three or less workers performing 8 hours temporary light and/or power the supplemental benefit rate is \$25.14 and effective 5/11/17 \$25.67.

---

**Electrician "M" (First 8 hours)**

"M" rated work shall be defined as jobbing: electrical work of limited duration and scope, also consisting of repairs and/or replacement of electrical and tele-data equipment. Includes all work necessary to retrofit, service, maintain and repair all kinds of lighting fixtures and local lighting controls and washing and cleaning of foregoing fixtures.

Effective Period: 7/1/2016 - 5/10/2017

Wage Rate per Hour: \$28.00

Supplemental Benefit Rate per Hour: \$21.85

First and Second Year "M" Wage Rate Per Hour: \$23.50

First and Second Year "M" Supplemental Rate: \$19.54

Effective Period: 5/11/2017 - 6/30/2017

Wage Rate per Hour: \$28.50

Supplemental Benefit Rate per Hour: \$22.10

First and Second Year "M" Wage Rate Per Hour: \$24.00

First and Second Year "M" Supplemental Rate: \$19.80

**Electrician "M" (Overtime After First 8 hours)**

"M" rated work shall be defined as jobbing: electrical work of limited duration and scope, also consisting of repairs and/or replacement of electrical and tele-data equipment. Includes all work necessary to retrofit, service, maintain and repair all kinds of lighting fixtures and local lighting controls and washing and cleaning of foregoing fixtures.

Effective Period: 7/1/2016 - 5/10/2017

Wage Rate per Hour: \$42.00

Supplemental Benefit Rate per Hour: \$23.60

First and Second Year "M" Wage Rate Per Hour: \$35.25

First and Second Year "M" Supplemental Rate: \$21.01



OFFICE OF THE COMPTROLLER, CITY OF NEW YORK  
§220 PREVAILING WAGE SCHEDULE

Effective Period: 5/11/2017 - 6/30/2017

Wage Rate per Hour: \$42.75

Supplemental Benefit Rate per Hour: \$23.89

First and Second Year "M" Wage Rate Per Hour: \$36.00

First and Second Year "M" Supplemental Rate: \$21.30

**Overtime**

Time and one half the regular rate after an 8 hour day.

Time and one half the regular rate for Saturday.

Time and one half the regular rate for Sunday.

**Overtime Holidays**

Time and one half the regular rate for work on the following holiday(s).

New Year's Day

Martin Luther King Jr. Day

President's Day

Memorial Day

Independence Day

Labor Day

Columbus Day

Veteran's Day

Thanksgiving Day

Day after Thanksgiving

Christmas Day

**Paid Holidays**

None

(Local #3)

---

**ELECTRICIAN - ALARM TECHNICIAN**

(Scope of Work - Inspect, test, repair, and replace defective, malfunctioning, or broken devices, components and controls of Fire, Burglar and Security Systems)

**Alarm Technician**

Effective Period: 7/1/2016 - 3/9/2017

Wage Rate per Hour: \$32.00

Supplemental Benefit Rate per Hour: \$15.47

Supplemental Note: \$13.97 only after 8 hours worked in a day

Effective Period: 3/10/2017 - 6/30/2017

Wage Rate per Hour: \$32.40

Supplemental Benefit Rate per Hour: \$16.10

OFFICE OF THE COMPTROLLER, CITY OF NEW YORK  
§220 PREVAILING WAGE SCHEDULE

Supplemental Note: \$14.60 only after 8 hours worked in a day

**Overtime Description**

Time and one half the regular rate for work on the following holidays: Columbus Day, Veterans Day, Day after Thanksgiving.

Double time the regular rate for work on the following holidays: New Year's day, Martin Luther King Jr. Day, President's Day, Memorial Day, Independence Day, Labor Day, Thanksgiving Day, Christmas Day.

**Overtime**

Time and one half the regular rate after an 8 hour day.

Time and one half the regular rate for Saturday.

Double time the regular rate for Sunday.

**Paid Holidays**

- New Year's Day
- Martin Luther King Jr. Day
- President's Day
- Memorial Day
- Independence Day
- Labor Day
- Columbus Day
- Veteran's Day
- Thanksgiving Day
- Day after Thanksgiving
- Christmas Day

**Shift Rates**

Night Differential is based upon a ten percent (10%) differential between the hours of 4:00 P.M. and 12:30 A.M. and a fifteen percent (15%) differential for the hours 12:00 A.M. to 8:00 A.M.

**Vacation**

- At least 1 year of employment.....ten (10) days
- 5 years or more of employment.....fifteen (15) days
- 10 years of employment.....twenty (20) days
- Plus one Personal Day per year

**Sick Days:**

One day per Year. Up to 4 vacation days may be used as sick days.

(Local #3)

---

---

**ELECTRICIAN-STREET LIGHTING WORKER**

**Electrician - Electro Pole Electrician**

Effective Period: 7/1/2016 - 5/17/2017

Wage Rate per Hour: \$54.00

Supplemental Benefit Rate per Hour: \$53.69

OFFICE OF THE COMPTROLLER, CITY OF NEW YORK  
§220 PREVAILING WAGE SCHEDULE

Effective Period: 5/18/2017 - 6/30/2017  
Wage Rate per Hour: \$56.00  
Supplemental Benefit Rate per Hour: \$56.26

**Electrician - Electro Pole Foundation Installer**

Effective Period: 7/1/2016 - 5/17/2017  
Wage Rate per Hour: \$40.93  
Supplemental Benefit Rate per Hour: \$40.12

Effective Period: 5/18/2017 - 6/30/2017  
Wage Rate per Hour: \$41.54  
Supplemental Benefit Rate per Hour: \$41.02

**Electrician - Electro Pole Maintainer**

Effective Period: 7/1/2016 - 5/17/2017  
Wage Rate per Hour: \$35.05  
Supplemental Benefit Rate per Hour: \$36.11

Effective Period: 5/18/2017 - 6/30/2017  
Wage Rate per Hour: \$35.58  
Supplemental Benefit Rate per Hour: \$36.89

**Overtime Description**

Electrician - Electro Pole Electrician: Time and one half the regular rate after a 7 hour day and after 5 consecutive days worked per week.

Electrician - Electro Pole Foundation Installer: Time and one half the regular rate after 8 hours within a 24 hour period and Saturday and Sunday.

Electrician - Electro Pole Maintainer: Time and one half the regular rate after a 7 hour day and after 5 consecutive days worked per week. Saturdays and Sundays may be used as a make-up day at straight time when a day is lost during the week to inclement weather.

**Overtime Holidays**

Time and one half the regular rate for work on the following holiday(s).

New Year's Day  
Martin Luther King Jr. Day  
President's Day  
Memorial Day  
Independence Day  
Labor Day  
Columbus Day  
Veteran's Day  
Thanksgiving Day  
Day after Thanksgiving  
Christmas Day

**Paid Holidays**

None

OFFICE OF THE COMPTROLLER, CITY OF NEW YORK  
\$220 PREVAILING WAGE SCHEDULE

(Local #3)

---

---

## **ELEVATOR CONSTRUCTOR**

### **Elevator Constructor**

Effective Period: 7/1/2016 - 3/16/2017

Wage Rate per Hour: **\$60.96**

Supplemental Benefit Rate per Hour: **\$32.65**

Effective Period: 3/17/2017 - 6/30/2017

Wage Rate per Hour: **\$62.64**

Supplemental Benefit Rate per Hour: **\$34.25**

### **Overtime Description**

For New Construction: work performed after 7 or 8 hour day, Saturday, Sunday or between 4:30pm and 7:00am shall be paid at double time rate.

Existing buildings: work performed after an 8 hour day, Saturday, Sunday or between 5:30pm and 7:00 am shall be paid time and one half.

### **Overtime**

Double time the regular rate for work on the following holiday(s).

### **Paid Holidays**

New Year's Day

President's Day

Good Friday

Memorial Day

Independence Day

Labor Day

Columbus Day

Veteran's Day

Thanksgiving Day

Day after Thanksgiving

Christmas Day

### **Vacation**

Employer contributes 8% of regular basic hourly rate as vacation pay for employees with more than 15 years of service, and 6% for employees with 5 to 15 years of service, and 4% for employees with less than 5 years of service.

(Local #1)

---

---

OFFICE OF THE COMPTROLLER, CITY OF NEW YORK  
§220 PREVAILING WAGE SCHEDULE

## ELEVATOR REPAIR & MAINTENANCE

### Elevator Service/Modernization Mechanic

Effective Period: 7/1/2016 - 3/16/2017

Wage Rate per Hour: \$47.91

Supplemental Benefit Rate per Hour: \$32.51

Effective Period: 3/17/2017 - 6/30/2017

Wage Rate per Hour: \$49.14

Supplemental Benefit Rate per Hour: \$34.11

### Overtime Description

For Scheduled Service Work: Double time - work scheduled in advance by two or more workers performed on Sundays, Holidays, and between midnight and 7:00am.

### Overtime

Time and one half the regular rate after an 8-hour day.

Time and one half the regular rate for Saturday.

Time and one half the regular rate for Sunday.

Time and one half the regular rate for work on a holiday plus the day's pay.

### Paid Holidays

New Year's Day

President's Day

Good Friday

Memorial Day

Independence Day

Labor Day

Columbus Day

Veteran's Day

Thanksgiving Day

Day after Thanksgiving

Christmas Day

### Shift Rates

Afternoon shift - regularly hourly rate plus a (15%) fifteen percent differential. Graveyard shift - time and one half the regular rate.

### Vacation

Employer contributes 8% of regular basic hourly rate as vacation pay for employees with more than 15 years of service, and 6% for employees with 5 to 15 years of service, and 4% for employees with less than 5 years of service.

(Local #1)

OFFICE OF THE COMPTROLLER, CITY OF NEW YORK  
§220 PREVAILING WAGE SCHEDULE

## **ENGINEER**

### **Engineer - Heavy Construction Operating Engineer I**

Cherry-pickers 20 tons and over and Loaders (rubber tired and/or tractor type with a manufacturer's minimum rated capacity of six cubic yards and over).

Effective Period: 7/1/2016 - 6/30/2017

Wage Rate per Hour: \$65.94

Supplemental Benefit Rate per Hour: \$35.41

Supplemental Note: \$63.67 on overtime

Shift Wage Rate: \$105.50

### **Engineer - Heavy Construction Operating Engineer II**

Backhoes, Basin Machines, Groover, Mechanical Sweepers, Bobcat, Boom Truck, Barrier Transport (Barrier Mover) & machines of similar nature. Operation of Churn Drills and machines of a similar nature, Stetco Silent Hoist and machines of similar nature, Vac-Alls, Meyers Machines, John Beam and machines of a similar nature, Ross Carriers and Travel Lifts and machines of a similar nature, Bulldozers, Scrapers and Turn-a-Pulls: Tugger Hoists (Used exclusively for handling excavated material); Tractors with attachments, Hyster and Roustabout Cranes, Cherry-pickers. Austin Western, Grove and machines of a similar nature, Scoopmobiles, Monorails, Conveyors, Trenchers: Loaders-Rubber Tired and Tractor: Barber Greene and Eimco Loaders and Eimco Backhoes; Mighty Midget and similar breakers and Tampers, Curb and Gutter Pavers and Motor Patrol, Motor Graders and all machines of a similar nature. Locomotives 10 Tons or under. Mini-Max, Break-Tech and machines of a similar nature; Milling machines, robotic and demolition machines and machines of a similar nature, shot blaster, skid steer machines and machines of a similar nature including bobcat, pile rig rubber-tired excavator (37,000 lbs. and under), 2 man auger.

Effective Period: 7/1/2016 - 6/30/2017

Wage Rate per Hour: \$63.98

Supplemental Benefit Rate per Hour: \$35.41

Supplemental Note: \$63.67 on overtime

Shift Wage Rate: \$102.37

### **Engineer - Heavy Construction Operating Engineer III**

Minor Equipment such as Tractors, Post Hole Diggers, Ditch Witch (Walk Behind), Road Finishing Machines, Rollers five tons and under, Tugger Hoists, Dual Purpose Trucks, Fork Lifts, and Dempsey Dumpers, Fireperson.

Effective Period: 7/1/2016 - 6/30/2017

Wage Rate per Hour: \$60.69

Supplemental Benefit Rate per Hour: \$35.41

Supplemental Note: \$63.67 on overtime

Shift Wage Rate: \$97.10

### **Engineer - Heavy Construction Maintenance Engineer I**

Installing, Repairing, Maintaining, Dismantling and Manning of all equipment including Steel Cutting, Bending and Heat Sealing Machines, Mechanical Heaters, Grout Pumps, Bentonite Pumps & Plants, Screening Machines, Fusion Coupling Machines, Tunnel Boring Machines Moles and Machines of a similar nature, Power Packs, Mechanical Hydraulic Jacks; all drill rigs including but not limited to Churn, Rotary Caisson, Raised Bore & Drills

OFFICE OF THE COMPTROLLER, CITY OF NEW YORK  
§220 PREVAILING WAGE SCHEDULE

of a similar nature; Personnel, Inspection & Safety Boats or any boats used to perform functions of same, Mine Hoists, Whirlies, all Climbing Cranes, all Tower Cranes, including but not limited to Truck Mounted and Crawler Type and machines of similar nature; Maintaining Hydraulic Drills and machines of a similar nature; Well Point System-Installation and dismantling; Burning, Welding, all Pumps regardless of size and/or motor power, except River Cofferdam Pumps and Wells Point Pumps; Motorized Buggies (three or more); equipment used in the cleaning and televising of sewers, but not limited to jet-rodder/vacuum truck, vacall/vactor, closed circuit television inspection equipment; high powered water pumps, jet pumps; screed machines and concrete finishing machines of a similar nature; vermeers.

Effective Period: 7/1/2016 - 6/30/2017  
Wage Rate per Hour: \$63.68  
Supplemental Benefit Rate per Hour: \$35.41  
Supplemental Note: \$63.67 on overtime  
Shift Wage Rate: \$101.89

**Engineer - Heavy Construction Maintenance Engineer II**

On Base Mounted Tower Cranes

Effective Period: 7/1/2016 - 6/30/2017  
Wage Rate per Hour: \$83.66  
Supplemental Benefit Rate per Hour: \$35.41  
Supplemental Note: \$63.67 on overtime  
Shift Wage Rate: \$133.86

**Engineer - Heavy Construction Maintenance Engineer III**

On Generators, Light Towers

Effective Period: 7/1/2016 - 6/30/2017  
Wage Rate per Hour: \$42.01  
Supplemental Benefit Rate per Hour: \$35.41  
Supplemental Note: \$63.67 on overtime  
Shift Wage Rate: \$67.22

**Engineer - Heavy Construction Maintenance Engineer IV**

On Pumps and Mixers including mud sucking

Effective Period: 7/1/2016 - 6/30/2017  
Wage Rate per Hour: \$43.11  
Supplemental Benefit Rate per Hour: \$35.41  
Supplemental Note: \$63.67 on overtime  
Shift Wage Rate: \$68.98

**Engineer - Heavy Construction Oilers I**

Gradalls, Cold Planer Grader, Concrete Pumps, Driving Truck Cranes, Driving and Operating Fuel and Grease Trucks.

Effective Period: 7/1/2016 - 6/30/2017

OFFICE OF THE COMPTROLLER, CITY OF NEW YORK  
\$220 PREVAILING WAGE SCHEDULE

Wage Rate per Hour: \$57.42  
Supplemental Benefit Rate per Hour: \$35.41  
Supplemental Note: \$63.67 on overtime  
Shift Wage Rate: \$91.87

**Engineer - Heavy Construction Oilers II**

All gasoline, electric, diesel or air operated Shovels, Draglines, Backhoes, Keystones, Pavers, Gunite Machines, Battery of Compressors, Crawler Cranes, two-person Trenching Machines.

Effective Period: 7/1/2016 - 6/30/2017  
Wage Rate per Hour: \$39.70  
Supplemental Benefit Rate per Hour: \$35.41  
Supplemental Note: \$63.67 on overtime  
Shift Wage Rate: \$63.52

**Engineer - Steel Erection Maintenance Engineers**

Derrick, Travelers, Tower, Crawler Tower and Climbing Cranes

Effective Period: 7/1/2016 - 6/30/2017  
Wage Rate per Hour: \$61.13  
Supplemental Benefit Rate per Hour: \$35.41  
Supplemental Note: \$63.67 on overtime  
Shift Wage Rate: \$97.81

**Engineer - Steel Erection Oiler I**

On a Truck Crane

Effective Period: 7/1/2016 - 6/30/2017  
Wage Rate per Hour: \$57.21  
Supplemental Benefit Rate per Hour: \$35.41  
Supplemental Note: \$63.67 on overtime  
Shift Wage Rate: \$91.54

**Engineer - Steel Erection Oiler II**

On a Crawler Crane

Effective Period: 7/1/2016 - 6/30/2017  
Wage Rate per Hour: \$43.54  
Supplemental Benefit Rate per Hour: \$35.41  
Supplemental Note: \$63.67 on overtime  
Shift Wage Rate: \$69.66

**Overtime Description**

On jobs of more than one shift, if the next shift employee fails to report for work through any cause over which the employer has no control, the employee on duty who works the next shift continues to work at the single time rate.



OFFICE OF THE COMPTROLLER, CITY OF NEW YORK  
§220 PREVAILING WAGE SCHEDULE

**Overtime**

Double time the regular rate after an 8 hour day.  
Double time the regular time rate for Saturday.  
Double time the regular rate for Sunday.  
Double time the regular rate for work on the following holiday(s).

**Paid Holidays**

New Year's Day  
Lincoln's Birthday  
President's Day  
Memorial Day  
Independence Day  
Labor Day  
Columbus Day  
Veteran's Day  
Thanksgiving Day  
Day after Thanksgiving  
Christmas Day

Employees must work at least one day in the payroll week in which the holiday occurs to receive the paid holiday

---

**Engineer - Building Work Maintenance Engineers I**

Installing, repairing, maintaining, dismantling (of all equipment including: Steel Cutting and Bending Machines, Mechanical Heaters, Mine Hoists, Climbing Cranes, Tower Cranes, Linden Peine, Lorain, Liebherr, Mannes, or machines of a similar nature, Well Point Systems, Deep Well Pumps, Concrete Mixers with loading Device, Concrete Plants, Motor Generators when used for temporary power and lights), skid steer machines of a similar nature including bobcat.

Effective Period: 7/1/2016 - 6/30/2017

Wage Rate per Hour: \$58.30

Supplemental Benefit Rate per Hour: \$35.41

Supplemental Note: \$63.67 on overtime

**Engineer - Building Work Maintenance Engineers II**

On Pumps, Generators, Mixers and Heaters

Effective Period: 7/1/2016 - 6/30/2017

Wage Rate per Hour: \$45.28

Supplemental Benefit Rate per Hour: \$35.41

Supplemental Note: \$63.67 on overtime

**Engineer - Building Work Oilers I**

All gasoline, electric, diesel or air operated Gradealls: Concrete Pumps, Overhead Cranes in Power Houses: Their duties shall be to assist the Engineer in oiling, greasing and repairing of all machines; Driving Truck Cranes: Driving and Operating Fuel and Grease Trucks, Cherrypickers (hydraulic cranes) over 70,000 GVW, and machines of a similar nature.

OFFICE OF THE COMPTROLLER, CITY OF NEW YORK  
§220 PREVAILING WAGE SCHEDULE

Effective Period: 7/1/2016 - 6/30/2017

Wage Rate per Hour: \$55.42

Supplemental Benefit Rate per Hour: \$35.41

Supplemental Note: \$63.67 on overtime

**Engineer - Building Work Oilers II**

Oilers on Crawler Cranes, Backhoes, Trenching Machines, Guniting Machines, Compressors (three or more in Battery).

Effective Period: 7/1/2016 - 6/30/2017

Wage Rate per Hour: \$41.16

Supplemental Benefit Rate per Hour: \$35.41

Supplemental Note: \$63.67 on overtime

**Overtime Description**

On jobs of more than one shift, if an Employee fails to report for work through any cause over which the Employer has no control, the Employee on duty will continue to work at the rate of single time.

**Overtime**

Double time the regular rate after an 8 hour day.

Double time the regular time rate for Saturday.

Double time the regular rate for Sunday.

Double time the regular rate for work on the following holiday(s).

**Paid Holidays**

New Year's Day

Lincoln's Birthday

President's Day

Memorial Day

Independence Day

Labor Day

Columbus Day

Veteran's Day

Thanksgiving Day

Christmas Day

Employees must work at least one day in the payroll week in which the holiday occurs to receive the paid holiday

**Shift Rates**

Off Shift: double time the regular hourly rate.

(Local #15)

---

---

**ENGINEER - CITY SURVEYOR AND CONSULTANT**

OFFICE OF THE COMPTROLLER, CITY OF NEW YORK  
§220 PREVAILING WAGE SCHEDULE

**Party Chief**

Effective Period: 7/1/2016 - 6/30/2017

Wage Rate per Hour: \$38.18

Supplemental Benefit Rate per Hour: \$20.15

Supplemental Note: Overtime Benefit Rate - \$27.65 per hour (time & one half) \$35.15 per hour (double time).

**Instrument Person**

Effective Period: 7/1/2016 - 6/30/2017

Wage Rate per Hour: \$31.47

Supplemental Benefit Rate per Hour: \$20.15

Supplemental Note: Overtime Benefit Rate - \$27.65 per hour (time & one half) \$35.15 per hour (double time).

**Rodperson**

Effective Period: 7/1/2016 - 6/30/2017

Wage Rate per Hour: \$27.24

Supplemental Benefit Rate per Hour: \$20.15

Supplemental Note: Overtime Benefit Rate - \$27.65 per hour (time & one half) \$35.15 per hour (double time).

**Overtime Description**

Time and one half the regular rate after an 8 hour day. Time and one half the regular rate for Saturday for the first eight hours worked, Double time the regular time rate for Saturday for work performed in excess of eight hours, Double time the regular rate for Sunday and Double time the regular rate for work on a holiday.

**Paid Holidays**

New Year's Day

Lincoln's Birthday

President's Day

Memorial Day

Independence Day

Labor Day

Columbus Day

Veteran's Day

Thanksgiving Day

Day after Thanksgiving

Christmas Day

Employees must work at least one day in the payroll week in which the holiday occurs to receive the paid holiday

(Operating Engineer Local #15-D)

---

**ENGINEER - FIELD (BUILDING CONSTRUCTION)**  
**(Construction of Building Projects, Concrete Superstructures, etc.)**

OFFICE OF THE COMPTROLLER, CITY OF NEW YORK  
\$220 PREVAILING WAGE SCHEDULE

**Field Engineer - BC Party Chief**

Effective Period: 7/1/2016 - 6/30/2017

Wage Rate per Hour: \$60.10

Supplemental Benefit Rate per Hour: \$32.15

Supplemental Note: Overtime Benefit Rate - \$44.90 per hour (time & one half) \$57.65 per hour (double time).

**Field Engineer - BC Instrument Person**

Effective Period: 7/1/2016 - 6/30/2017

Wage Rate per Hour: \$46.69

Supplemental Benefit Rate per Hour: \$32.15

Supplemental Note: Overtime Benefit Rate - \$44.90 per hour (time & one half) \$57.65 per hour (double time).

**Field Engineer - BC Rodperson**

Effective Period: 7/1/2016 - 6/30/2017

Wage Rate per Hour: \$30.20

Supplemental Benefit Rate per Hour: \$32.15

Supplemental Note: Overtime Benefit Rate - \$44.90 per hour (time & one half) \$57.65 per hour (double time).

**Overtime Description**

Time and one half the regular rate after a 7 hour work and time and one half the regular rate for Saturday for the first seven hours worked, Double time the regular time rate for Saturday for work performed in excess of seven hours, Double time the regular rate for Sunday and Double time the regular rate for work on a holiday.

**Paid Holidays**

New Year's Day

President's Day

Good Friday

Memorial Day

Independence Day

Labor Day

Columbus Day

Veteran's Day

Thanksgiving Day

Christmas Day

Employees must work at least one day in the payroll week in which the holiday occurs to receive the paid holiday

(Operating Engineer Local #15-D)

---

**ENGINEER - FIELD (HEAVY CONSTRUCTION)**  
(Construction of Roads, Tunnels, Bridges, Sewers, Building Foundations,  
Engineering Structures etc.)

OFFICE OF THE COMPTROLLER, CITY OF NEW YORK  
§220 PREVAILING WAGE SCHEDULE

**Field Engineer - HC Party Chief**

Effective Period: 7/1/2016 - 6/30/2017

Wage Rate per Hour: \$68.09

Supplemental Benefit Rate per Hour: \$33.54

Supplemental Note: Overtime benefit rate - \$46.86 per hour (time & one half), \$60.18 per hour (double time).

**Field Engineer - HC Instrument Person**

Effective Period: 7/1/2016 - 6/30/2017

Wage Rate per Hour: \$49.98

Supplemental Benefit Rate per Hour: \$33.54

Supplemental Note: Overtime benefit rate - \$46.86 per hour (time & one half), \$60.18 per hour (double time).

**Field Engineer - HC Rodperson**

Effective Period: 7/1/2016 - 6/30/2017

Wage Rate per Hour: \$41.93

Supplemental Benefit Rate per Hour: \$33.54

Supplemental Note: Overtime benefit rate - \$46.86 per hour (time & one half), \$60.18 per hour (double time).

**Overtime Description**

Time and one half the regular rate after an 8 hour day, Time and one half the regular rate for Saturday for the first eight hours worked, Double time the regular time rate for Saturday for work performed in excess of eight hours, Double time the regular rate for Sunday and Double time the regular rate for work on a holiday.

**Paid Holidays**

New Year's Day

Lincoln's Birthday

President's Day

Memorial Day

Independence Day

Labor Day

Columbus Day

Veteran's Day

Thanksgiving Day

Christmas Day

Employees must work at least one day in the payroll week in which the holiday occurs to receive the paid holiday

(Operating Engineer Local #15-D)

---

**ENGINEER - FIELD (STEEL ERECTION)**

**Field Engineer - Steel Erection Party Chief**

OFFICE OF THE COMPTROLLER, CITY OF NEW YORK  
§220 PREVAILING WAGE SCHEDULE

Effective Period: 7/1/2016 - 6/30/2017

Wage Rate per Hour: \$63.64

Supplemental Benefit Rate per Hour: \$33.04

Supplemental Note: Overtime benefit rate - \$46.11 per hour (time & one half), \$59.18 per hour (double time).

**Field Engineer - Steel Erection Instrument Person**

Effective Period: 7/1/2016 - 6/30/2017

Wage Rate per Hour: \$49.59

Supplemental Benefit Rate per Hour: \$33.04

Supplemental Note: Overtime benefit rate - \$46.11 per hour (time & one half), \$59.18 per hour (double time).

**Field Engineer - Steel Erection Rodperson**

Effective Period: 7/1/2016 - 6/30/2017

Wage Rate per Hour: \$33.20

Supplemental Benefit Rate per Hour: \$33.04

Supplemental Note: Overtime benefit rate - \$46.11 per hour (time & one half), \$59.18 per hour (double time).

**Overtime Description**

Time and one half the regular rate for Saturday for the first eight hours worked.

Double time the regular rate for Saturday for work performed in excess of eight hours.

**Overtime**

Time and one half the regular rate after an 8 hour day.

Double time the regular rate for Sunday.

Double time the regular rate for work on the following holiday(s).

**Paid Holidays**

New Year's Day

Lincoln's Birthday

President's Day

Memorial Day

Independence Day

Labor Day

Columbus Day

Veteran's Day

Thanksgiving Day

Christmas Day

Employees must work at least one day in the payroll week in which the holiday occurs to receive the paid holiday

(Operating Engineer Local #15-D)

---

**ENGINEER - OPERATING**

**Operating Engineer - Road & Heavy Construction I**

OFFICE OF THE COMPTROLLER, CITY OF NEW YORK  
§220 PREVAILING WAGE SCHEDULE

Back Filling Machines, Cranes, Mucking Machines and Dual Drum Paver.

Effective Period: 7/1/2016 - 6/30/2017  
Wage Rate per Hour: \$73.90  
Supplemental Benefit Rate per Hour: \$31.10  
Supplemental Note: \$56.50 overtime hours  
Shift Wage Rate: \$118.24

**Operating Engineer - Road & Heavy Construction II**

Backhoes, Power Shovels, Hydraulic Clam Shells, Steel Erection, Moles and machines of a similar nature.

Effective Period: 7/1/2016 - 6/30/2017  
Wage Rate per Hour: \$76.51  
Supplemental Benefit Rate per Hour: \$31.10  
Supplemental Note: \$56.50 overtime hours  
Shift Wage Rate: \$122.42

**Operating Engineer - Road & Heavy Construction III**

Mine Hoists, Cranes, etc. (Used as Mine Hoists)

Effective Period: 7/1/2016 - 6/30/2017  
Wage Rate per Hour: \$78.96  
Supplemental Benefit Rate per Hour: \$31.10  
Supplemental Note: \$56.50 overtime hours  
Shift Wage Rate: \$126.34

**Operating Engineer - Road & Heavy Construction IV**

Gradealls, Keystones, Cranes on land or water (with digging buckets), Bridge Cranes, Vermeer Cutter and machines of a similar nature, Trenching Machines.

Effective Period: 7/1/2016 - 6/30/2017  
Wage Rate per Hour: \$77.07  
Supplemental Benefit Rate per Hour: \$31.10  
Supplemental Note: \$56.50 overtime hours  
Shift Wage Rate: \$123.31

**Operating Engineer - Road & Heavy Construction V**

Pile Drivers & Rigs (employing Dock Builder foreperson): Derrick Boats, Tunnel Shovels.

Effective Period: 7/1/2016 - 6/30/2017  
Wage Rate per Hour: \$75.55  
Supplemental Benefit Rate per Hour: \$31.10  
Supplemental Note: \$56.50 overtime hours  
Shift Wage Rate: \$120.88

OFFICE OF THE COMPTROLLER, CITY OF NEW YORK  
\$220 PREVAILING WAGE SCHEDULE

**Operating Engineer - Road & Heavy Construction VI**

Mixers (Concrete with loading attachment), Concrete Pavers, Cableways, Land Derricks, Power Houses (Low Air Pressure Units).

Effective Period: 7/1/2016 - 6/30/2017

Wage Rate per Hour: \$71.78

Supplemental Benefit Rate per Hour: \$31.10

Supplemental Note: \$56.50 overtime hours

Shift Wage Rate: \$114.85

**Operating Engineer - Road & Heavy Construction VII**

Barrier Movers , Barrier Transport and Machines of a Similar Nature.

Effective Period: 7/1/2016 - 6/30/2017

Wage Rate per Hour: \$57.96

Supplemental Benefit Rate per Hour: \$31.10

Supplemental Note: \$56.50 overtime hours

Shift Wage Rate: \$92.74

**Operating Engineer - Road & Heavy Construction VIII**

Utility Compressors

Effective Period: 7/1/2016 - 6/30/2017

Wage Rate per Hour: \$44.98

Supplemental Benefit Rate per Hour: \$31.10

Supplemental Note: \$56.50 overtime hours

Shift Wage Rate: \$56.70

**Operating Engineer - Road & Heavy Construction IX**

Horizontal Boring Rig

Effective Period: 7/1/2016 - 6/30/2017

Wage Rate per Hour: \$68.25

Supplemental Benefit Rate per Hour: \$31.10

Supplemental Note: \$56.50 overtime hours

Shift Wage Rate: \$109.20

**Operating Engineer - Road & Heavy Construction X**

Elevators (manually operated as personnel hoist).

Effective Period: 7/1/2016 - 6/30/2017

Wage Rate per Hour: \$62.73

Supplemental Benefit Rate per Hour: \$31.10

Supplemental Note: \$56.50 overtime hours

Shift Wage Rate: \$100.37



OFFICE OF THE COMPTROLLER, CITY OF NEW YORK  
§220 PREVAILING WAGE SCHEDULE

**Operating Engineer - Road & Heavy Construction XI**

Compressors (Portable 3 or more in battery), Driving of Truck Mounted Compressors, Well-point Pumps, Tugger Machines Well Point Pumps, Churn Drill.

Effective Period: 7/1/2016 - 6/30/2017

Wage Rate per Hour: **\$48.73**

Supplemental Benefit Rate per Hour: **\$31.10**

Supplemental Note: **\$56.50** overtime hours

Shift Wage Rate: **\$77.97**

**Operating Engineer - Road & Heavy Construction XII**

All Drills and Machines of a similar nature.

Effective Period: 7/1/2016 - 6/30/2017

Wage Rate per Hour: **\$72.53**

Supplemental Benefit Rate per Hour: **\$31.10**

Supplemental Note: **\$56.50** overtime hours

Shift Wage Rate: **\$116.05**

**Operating Engineer - Road & Heavy Construction XIII**

Concrete Pumps, Concrete Plant, Stone Crushers, Double Drum Hoist, Power Houses (other than above).

Effective Period: 7/1/2016 - 6/30/2017

Wage Rate per Hour: **\$70.24**

Supplemental Benefit Rate per Hour: **\$31.10**

Supplemental Note: **\$56.50** overtime hours

Shift Wage Rate: **\$112.38**

**Operating Engineer - Road & Heavy Construction XIV**

Concrete Mixer

Effective Period: 7/1/2016 - 6/30/2017

Wage Rate per Hour: **\$67.16**

Supplemental Benefit Rate per Hour: **\$31.10**

Supplemental Note: **\$56.50** overtime hours

Shift Wage Rate: **\$107.46**

**Operating Engineer - Road & Heavy Construction XV**

Compressors (Portable Single or two in Battery, not over 100 feet apart), Pumps (River Cofferdam) and Welding Machines, Push Button Machines, All Engines Irrespective of Power (Power-Pac) used to drive auxiliary equipment, Air, Hydraulic, etc.

Effective Period: 7/1/2016 - 6/30/2017

Wage Rate per Hour: **\$45.27**

OFFICE OF THE COMPTROLLER, CITY OF NEW YORK  
\$220 PREVAILING WAGE SCHEDULE

Supplemental Benefit Rate per Hour: \$31.10  
Supplemental Note: \$56.50 overtime hours  
Shift Wage Rate: \$72.43

**Operating Engineer - Road & Heavy Construction XVI**

Concrete Breaking Machines, Hoists (Single Drum), Load Masters, Locomotives (over ten tons) and Dinkies over ten tons, Hydraulic Crane-Second Engineer.

Effective Period: 7/1/2016 - 6/30/2017  
Wage Rate per Hour: \$64.13  
Supplemental Benefit Rate per Hour: \$31.10  
Supplemental Note: \$56.50 overtime hours  
Shift Wage Rate: \$102.61

**Operating Engineer - Road & Heavy Construction XVII**

On-Site concrete plant engineer, On-site Asphalt Plant Engineer, and Vibratory console.

Effective Period: 7/1/2016 - 6/30/2017  
Wage Rate per Hour: \$64.63  
Supplemental Benefit Rate per Hour: \$31.10  
Supplemental Note: \$56.50 overtime hours  
Shift Wage Rate: \$103.41

**Operating Engineer - Road & Heavy Construction XVIII**

Tower Crane

Effective Period: 7/1/2016 - 6/30/2017  
Wage Rate per Hour: \$92.76  
Supplemental Benefit Rate per Hour: \$31.10  
Supplemental Note: \$56.50 overtime hours  
Shift Wage Rate: \$148.42

**Operating Engineer - Paving I**

Asphalt Spreaders, Autogrades (C.M.I.), Roto/Mil

Effective Period: 7/1/2016 - 6/30/2017  
Wage Rate per Hour: \$71.78  
Supplemental Benefit Rate per Hour: \$31.10  
Supplemental Note: \$56.50 overtime hours  
Shift Wage Rate: \$114.85

**Operating Engineer - Paving II**

Asphalt Roller

Effective Period: 7/1/2016 - 6/30/2017

OFFICE OF THE COMPTROLLER, CITY OF NEW YORK  
§220 PREVAILING WAGE SCHEDULE

Wage Rate per Hour: \$69.91  
Supplemental Benefit Rate per Hour: \$31.10  
Supplemental Note: \$56.50 overtime hours  
Shift Wage Rate: \$111.86

**Operating Engineer - Paving III**

Asphalt Plants

Effective Period: 7/1/2016 - 6/30/2017  
Wage Rate per Hour: \$59.14  
Supplemental Benefit Rate per Hour: \$31.10  
Supplemental Note: \$56.50 overtime hours  
Shift Wage Rate: \$94.62

**Operating Engineer - Concrete I**

Cranes

Effective Period: 7/1/2016 - 6/30/2017  
Wage Rate per Hour: \$76.73  
Supplemental Benefit Rate per Hour: \$31.10  
Supplemental Note: \$56.50 overtime hours

**Operating Engineer - Concrete II**

Compressors

Effective Period: 7/1/2016 - 6/30/2017  
Wage Rate per Hour: \$45.62  
Supplemental Benefit Rate per Hour: \$31.10  
Supplemental Note: \$56.50 overtime hours

**Operating Engineer - Concrete III**

Micro-traps (Negative Air Machines), Vac-All Remediation System.

Effective Period: 7/1/2016 - 6/30/2017  
Wage Rate per Hour: \$61.31  
Supplemental Benefit Rate per Hour: \$31.10  
Supplemental Note: \$56.50 overtime hours

**Operating Engineer - Steel Erection I**

Three Drum Derricks

Effective Period: 7/1/2016 - 6/30/2017  
Wage Rate per Hour: \$79.54  
Supplemental Benefit Rate per Hour: \$31.10  
Supplemental Note: \$56.50 overtime hours

OFFICE OF THE COMPTROLLER, CITY OF NEW YORK  
§220 PREVAILING WAGE SCHEDULE

Shift Wage Rate: \$127.26

**Operating Engineer - Steel Erection II**

Cranes, 2 Drum Derricks, Hydraulic Cranes, Fork Lifts and Boom Trucks.

Effective Period: 7/1/2016 - 6/30/2017

Wage Rate per Hour: \$76.43

Supplemental Benefit Rate per Hour: \$31.10

Supplemental Note: \$56.50 overtime hours

Shift Wage Rate: \$122.29

**Operating Engineer - Steel Erection III**

Compressors, Welding Machines.

Effective Period: 7/1/2016 - 6/30/2017

Wage Rate per Hour: \$45.34

Supplemental Benefit Rate per Hour: \$31.10

Supplemental Note: \$56.50 overtime hours

Shift Wage Rate: \$72.54

**Operating Engineer - Steel Erection IV**

Compressors - Not Combined with Welding Machine.

Effective Period: 7/1/2016 - 6/30/2017

Wage Rate per Hour: \$43.17

Supplemental Benefit Rate per Hour: \$31.10

Supplemental Note: \$56.50 overtime hours

Shift Wage Rate: \$69.07

**Operating Engineer - Building Work I**

Forklifts, Plaster (Platform machine), Plaster Bucket, Concrete Pump and all other equipment used for hoisting material.

Effective Period: 7/1/2016 - 6/30/2017

Wage Rate per Hour: \$63.12

Supplemental Benefit Rate per Hour: \$31.10

Supplemental Note: \$56.50 overtime hours

**Operating Engineer - Building Work II**

Compressors, Welding Machines (Cutting Concrete-Tank Work), Paint Spraying, Sandblasting, Pumps (with the exclusion of Concrete Pumps), All Engines irrespective of Power (Power-Pac) used to drive Auxiliary Equipment, Air, Hydraulic, Jacking System, etc.

Effective Period: 7/1/2016 - 6/30/2017

Wage Rate per Hour: \$47.26

OFFICE OF THE COMPTROLLER, CITY OF NEW YORK  
§220 PREVAILING WAGE SCHEDULE

Supplemental Benefit Rate per Hour: \$31.10  
Supplemental Note: \$56.50 overtime hours

**Operating Engineer - Building Work III**

Double Drum

Effective Period: 7/1/2016 - 6/30/2017  
Wage Rate per Hour: \$71.85  
Supplemental Benefit Rate per Hour: \$31.10  
Supplemental Note: \$56.50 overtime hours

**Operating Engineer - Building Work IV**

Stone Derrick, Cranes, Hydraulic Cranes Boom Trucks.

Effective Period: 7/1/2016 - 6/30/2017  
Wage Rate per Hour: \$76.12  
Supplemental Benefit Rate per Hour: \$31.10  
Supplemental Note: \$56.50 overtime hours

**Operating Engineer - Building Work V**

Dismantling and Erection of Cranes, Relief Engineer.

Effective Period: 7/1/2016 - 6/30/2017  
Wage Rate per Hour: \$70.13  
Supplemental Benefit Rate per Hour: \$31.10  
Supplemental Note: \$56.50 overtime hours

**Operating Engineer - Building Work VI**

4 Pole Hoist, Single Drum Hoists.

Effective Period: 7/1/2016 - 6/30/2017  
Wage Rate per Hour: \$69.39  
Supplemental Benefit Rate per Hour: \$31.10  
Supplemental Note: \$56.50 overtime hours

**Operating Engineer - Building Work VII**

Rack & Pinion and House Cars

Effective Period: 7/1/2016 - 6/30/2017  
Wage Rate per Hour: \$55.17  
Supplemental Benefit Rate per Hour: \$31.10  
Supplemental Note: \$56.50 overtime hours  
For New House Car projects Wage Rate per Hour \$44.02

**Overtime Description**

OFFICE OF THE COMPTROLLER, CITY OF NEW YORK  
\$220 PREVAILING WAGE SCHEDULE

On jobs of more than one shift, if an Employee fails to report for work through any cause over which the Employer has no control, the Employee on duty will continue to work at the rate of single time.

For House Cars and Rack & Pinion only: Overtime paid at time and one-half for all hours in excess of eight hours in a day, Saturday, Sunday and Holidays worked.

### Overtime

Double time the regular rate after an 8 hour day.

Double time the regular time rate for Saturday.

Double time the regular rate for Sunday.

Double time the regular rate for work on the following holiday(s).

### Paid Holidays

New Year's Day

Lincoln's Birthday

President's Day

Memorial Day

Independence Day

Labor Day

Columbus Day

Veteran's Day

Thanksgiving Day

Day after Thanksgiving

Christmas Day

Employees must work at least one day in the payroll week in which the holiday occurs to receive the paid holiday

### Shift Rates

For Steel Erection Only: Shifts may be worked at the single time rate at other than the regular working hours (8:00 A.M. to 4:30 P.M.) on the following work ONLY: Heavy construction jobs on work below the street level, over railroad tracks and on building jobs.

(Operating Engineer Local #14)

---

## FLOOR COVERER

(Interior vinyl composition tile, sheath vinyl linoleum and wood parquet tile including site preparation and synthetic turf not including site preparation)

### Floor Coverer

Effective Period: 7/1/2016 - 6/30/2017

Wage Rate per Hour: \$50.50

Supplemental Benefit Rate per Hour: \$45.88

### Overtime

Time and one half the regular rate after an 8 hour day.

OFFICE OF THE COMPTROLLER, CITY OF NEW YORK  
§220 PREVAILING WAGE SCHEDULE

Time and one half the regular rate for Saturday.  
Double time the regular rate for Sunday.

**Overtime Holidays**

Double time the regular rate for work on the following holiday(s).

New Year's Day  
President's Day  
Memorial Day  
Independence Day  
Labor Day  
Columbus Day  
Presidential Election Day  
Thanksgiving Day  
Day after Thanksgiving  
Christmas Day

**Paid Holidays**

1/2 day on Christmas Eve if work is performed in the A.M.  
1/2 day on New Year's Eve if work is performed in the A.M.

**Shift Rates**

Two shifts may be utilized with the first shift working 8:00 A.M. to the end of the shift at the straight time of pay. The second shift will receive one hour at double time rate for the last hour of the shift. (eight for seven, nine for eight).

(Carpenters District Council)

---

---

**GLAZIER**

(New Construction, Remodeling, and Alteration)

Glazier

Effective Period: 7/1/2016 - 6/30/2017

Wage Rate per Hour: \$44.45

Supplemental Benefit Rate per Hour: \$37.84

Supplemental Note: Supplemental Benefit Overtime Rate: \$46.84

**Overtime Description**

An optional 8th hour can be worked at straight time rate. If 9th hour is worked, then both hours or more (8th & 9th or more) will be at the double time rate of pay.

**Overtime**

Double time the regular rate after a 7 hour day.

Double time the regular time rate for Saturday.

Double time the regular rate for Sunday.

OFFICE OF THE COMPTROLLER, CITY OF NEW YORK  
\$220 PREVAILING WAGE SCHEDULE

**Overtime Holidays**

Double time the regular rate for work on the following holiday(s).

New Year's Day  
President's Day  
Memorial Day  
Independence Day  
Labor Day  
Thanksgiving Day  
Day after Thanksgiving  
Christmas Day

**Paid Holidays**

None

**Shift Rates**

Shifts shall be any 7 hours beyond 4:00 P.M. for which the glazier shall receive 8 hours pay for 7 hours worked.

(Local #1281)

---

**GLAZIER - REPAIR & MAINTENANCE**

(For the installation of Glass - All repair and maintenance work on a particular building, whenever performed, where the total cumulative contract value is under \$127,628. Except where enumerated (i.e. plate glass windows) does not apply to non-residential buildings.)

**Craft Jurisdiction for repair, maintenance and fabrication**

Plate glass replacement, Residential glass replacement, Residential mirrors and shower doors, Storm windows and storm doors, Residential replacement windows, Herculite door repairs, Door closer repairs, Retrofit apartment house (non commercial buildings), Glass tinting.

Effective Period: 7/1/2016 - 6/30/2017

Wage Rate per Hour: \$23.78

Supplemental Benefit Rate per Hour: \$20.14

**Overtime**

Time and one half the regular rate after an 8 hour day.

Double time the regular rate for Sunday.

Time and one half the regular hourly rate after 40 hours in any work week.

**Paid Holidays**

New Year's Day  
President's Day



OFFICE OF THE COMPTROLLER, CITY OF NEW YORK  
§220 PREVAILING WAGE SCHEDULE

Memorial Day  
Independence Day  
Labor Day  
Thanksgiving Day  
Day after Thanksgiving  
Christmas Day

(Local #1281)

---

---

## HEAT AND FROST INSULATOR

### Heat & Frost Insulator

Effective Period: 7/1/2016 - 6/30/2017

Wage Rate per Hour: \$57.78

Supplemental Benefit Rate per Hour: \$38.96

### Overtime Description

Double time shall be paid for supplemental benefits during overtime work.  
8th hour paid at time and one half.

### Overtime

Double time the regular rate after an 8 hour day.

Double time the regular time rate for Saturday.

Double time the regular rate for Sunday.

### Overtime Holidays

Double time the regular rate for work on the following holiday(s).

New Year's Day

Martin Luther King Jr. Day

President's Day

Memorial Day

Independence Day

Columbus Day

Veteran's Day

Thanksgiving Day

Day after Thanksgiving

Christmas Day

Triple time the regular rate for work on the following holiday(s).

Labor Day

### Paid Holidays

None

### Shift Rates

OFFICE OF THE COMPTROLLER, CITY OF NEW YORK  
\$220 PREVAILING WAGE SCHEDULE

The first shift shall work seven hours at the regular straight time rate. The second and third shift shall work seven hours the regular straight time hourly rate plus a fourteen percent wage and benefit premium. Off hour work in occupied or retail buildings may be worked on weekdays with an increment of \$1.00 per hour and eight hours pay for seven (7) hours worked. Double time will apply for over seven (7) hours worked on weekdays, weekends or holidays.

(Local #12) (BCA)

---

---

## **HOUSE WRECKER (TOTAL DEMOLITION)**

### **House Wrecker - Tier A**

On all work sites the first, second, eleventh and every third House Wrecker thereafter will be Tier A House Wreckers (i.e. 1st, 2nd, 11th, 14th etc). Other House Wreckers may be Tier B House Wreckers.

Effective Period: 7/1/2016 - 6/30/2017

Wage Rate per Hour: \$36.33

Supplemental Benefit Rate per Hour: \$27.77

### **House Wrecker - Tier B**

Effective Period: 7/1/2016 - 6/30/2017

Wage Rate per Hour: \$25.56

Supplemental Benefit Rate per Hour: \$20.45

### **Overtime**

Time and one half the regular rate after an 8 hour day.

Time and one half the regular rate for Saturday.

Double time the regular rate for Sunday.

### **Overtime Holidays**

Double time the regular rate for work on the following holiday(s).

New Year's Day

President's Day

Memorial Day

Independence Day

Labor Day

Thanksgiving Day

Christmas Day

### **Paid Holidays**

None

OFFICE OF THE COMPTROLLER, CITY OF NEW YORK  
§220 PREVAILING WAGE SCHEDULE

(Mason Tenders District Council)

---

---

## **IRON WORKER - ORNAMENTAL**

### **Iron Worker - Ornamental**

Effective Period: 7/1/2016 - 6/30/2017

Wage Rate per Hour: **\$43.75**

Supplemental Benefit Rate per Hour: **\$49.57**

Supplemental Note: Supplemental benefits are to be paid at the applicable overtime rate when overtime is in effect.

### **Overtime Description**

Time and one half the regular rate after a 7 hour day for a maximum of two hours on any regular work day (the 8th and 9th hour) and double time shall be paid for all work on a regular work day thereafter, time and one half the regular rate for Saturday for the first seven hours of work and double time shall be paid for all work on a Saturday thereafter.

### **Overtime**

Double time the regular rate for Sunday.

### **Overtime Holidays**

Double time the regular rate for work on the following holiday(s).

New Year's Day

President's Day

Memorial Day

Independence Day

Labor Day

Thanksgiving Day

Christmas Day

### **Paid Holidays**

None

### **Shift Rates**

For off shift work - 8 hours pay for 7 hours of work. When two or three shifts are employed on a job, Monday through Friday, the workday for each shift shall be seven hours and paid for ten and one-half hours at the single time rate. When two or three shifts are worked on Saturday, Sunday or holidays, each shift shall be seven hours and paid fifteen and three-quarters hours.

(Local #580)

---

---

OFFICE OF THE COMPTROLLER, CITY OF NEW YORK  
§220 PREVAILING WAGE SCHEDULE

## IRON WORKER - STRUCTURAL

### Iron Worker - Structural

Effective Period: 7/1/2016 - 6/30/2017

Wage Rate per Hour: \$49.50

Supplemental Benefit Rate per Hour: \$69.74

Supplemental Note: Supplemental benefits are to be paid at the applicable overtime rate when overtime is in effect.

### Overtime Description

Monday through Friday- the first eight hours are paid at straight time, the 9th and 10th hours are paid at time and one-half the regular rate, all additional weekday overtime is paid at double the regular rate. Saturdays- the first eight hours are paid at time and one-half the regular rate, double time thereafter. Sunday-all shifts are paid at double time.

### Overtime

Time and one half the regular rate after an 8 hour day.

Time and one half the regular rate for Saturday.

Double time the regular rate for Sunday.

### Overtime Holidays

Double time the regular rate for work on the following holiday(s).

New Year's Day

President's Day

Memorial Day

Independence Day

Labor Day

Thanksgiving Day

Christmas Day

### Paid Holidays

1/2 day on Christmas Eve if work is performed in the A.M.

1/2 day on New Year's Eve if work is performed in the A.M.

### Shift Rates

Monday through Friday - First Shift: First eight hours are paid at straight time, the 9th & 10th hours are paid at time and a half, double time paid thereafter. Second and third Shifts: First eight hours are paid at time and one-half, double time thereafter. Saturdays: All shifts, first eight hours paid at time and one-half, double time thereafter. Sunday all shifts are paid at double time.

(Local #40 & #361)

---

## LABORER

(Foundation, Concrete, Excavating, Street Pipe Layer and Common)

OFFICE OF THE COMPTROLLER, CITY OF NEW YORK  
§220 PREVAILING WAGE SCHEDULE

**Laborer**

Excavation and foundation work for buildings, heavy construction, engineering work, and hazardous waste removal in connection with the above work. Landscaping tasks in connection with heavy construction work, engineering work and building projects. Projects include, but are not limited to pollution plants, sewers, parks, subways, bridges, highways, etc.

Effective Period: 7/1/2016 - 6/30/2017

Wage Rate per Hour: \$41.00

Supplemental Benefit Rate per Hour: \$38.63

**Overtime**

Time and one half the regular rate after an 8 hour day.

Time and one half the regular rate for Saturday.

Double time the regular rate for Sunday.

**Overtime Holidays**

Double time the regular rate for work on the following holiday(s).

New Year's Day

Memorial Day

Independence Day

Labor Day

Columbus Day

Thanksgiving Day

Christmas Day

**Paid Holidays**

Labor Day

Thanksgiving Day

**Shift Rates**

When two shifts are employed, single time rate shall be paid for each shift. When three shifts are found necessary, each shift shall work seven and one half hours (7 ½), but shall be paid for eight (8) hours of labor, and be permitted one half hour for lunch.

(Local #731)

---

**LANDSCAPING**

(Landscaping tasks, as well as tree pruning, tree removing, spraying and maintenance in connection with the planting of street trees and the planting of trees in city parks but not when such activities are performed as part of, or in connection with, other construction or reconstruction projects.)

OFFICE OF THE COMPTROLLER, CITY OF NEW YORK  
\$220 PREVAILING WAGE SCHEDULE

**Landscaper (Above 6 years experience)**

Effective Period: 7/1/2016 - 6/30/2017

Wage Rate per Hour: \$27.00

Supplemental Benefit Rate per Hour: \$14.55

**Landscaper (3 - 6 years experience)**

Effective Period: 7/1/2016 - 6/30/2017

Wage Rate per Hour: \$26.00

Supplemental Benefit Rate per Hour: \$14.55

**Landscaper (up to 3 years experience)**

Effective Period: 7/1/2016 - 6/30/2017

Wage Rate per Hour: \$23.50

Supplemental Benefit Rate per Hour: \$14.55

**Groundperson**

Effective Period: 7/1/2016 - 6/30/2017

Wage Rate per Hour: \$23.50

Supplemental Benefit Rate per Hour: \$14.55

**Tree Remover / Pruner**

Effective Period: 7/1/2016 - 6/30/2017

Wage Rate per Hour: \$32.00

Supplemental Benefit Rate per Hour: \$14.55

**Landscaper Sprayer (Pesticide Applicator)**

Effective Period: 7/1/2016 - 6/30/2017

Wage Rate per Hour: \$22.00

Supplemental Benefit Rate per Hour: \$14.55

**Watering - Plant Maintainer**

Effective Period: 7/1/2016 - 6/30/2017

Wage Rate per Hour: \$17.00

Supplemental Benefit Rate per Hour: \$14.55

**Overtime Description**

For all overtime work performed, supplemental benefits shall include an additional seventy-five (\$0.75) cents per hour.

**Overtime**

Time and one half the regular rate after an 8 hour day.

OFFICE OF THE COMPTROLLER, CITY OF NEW YORK  
\$220 PREVAILING WAGE SCHEDULE

Time and one half the regular rate for Saturday.  
Double time the regular rate for Sunday.  
Time and one half the regular rate for work on a holiday plus the day's pay.

**Paid Holidays**

New Year's Day  
Memorial Day  
Independence Day  
Labor Day  
Thanksgiving Day  
Christmas Day

**Shift Rates**

Work performed on a 4pm to 12am shift has a 15% differential. Work performed on a 12am to 8am shift has a 20% differential.

(Local #175)

---

---

**MARBLE MECHANIC**

**Marble Setter**

Effective Period: 7/1/2016 - 12/31/2016  
Wage Rate per Hour: **\$52.32**  
Supplemental Benefit Rate per Hour: **\$37.64**

Effective Period: 1/1/2017 - 6/30/2017  
Wage Rate per Hour: **\$52.74**  
Supplemental Benefit Rate per Hour: **\$38.67**

**Marble Finisher**

Effective Period: 7/1/2016 - 12/31/2016  
Wage Rate per Hour: **\$41.11**  
Supplemental Benefit Rate per Hour: **\$35.91**

Effective Period: 1/1/2017 - 6/30/2017  
Wage Rate per Hour: **\$41.46**  
Supplemental Benefit Rate per Hour: **\$36.64**

**Marble Polisher**

Effective Period: 7/1/2016 - 12/31/2016  
Wage Rate per Hour: **\$37.49**  
Supplemental Benefit Rate per Hour: **\$27.80**

OFFICE OF THE COMPTROLLER, CITY OF NEW YORK  
\$220 PREVAILING WAGE SCHEDULE

Effective Period: 1/1/2017 - 6/30/2017

Wage Rate per Hour: \$37.93

Supplemental Benefit Rate per Hour: \$28.33

### Overtime Description

Supplemental Benefit contributions are to be made at the applicable overtime rates. Time and one half the regular rate after a 7 hour day or time and one half the regular rate after an 8 hour day - chosen by Employer at the start of the project and then would last for the full duration of the project.

### Overtime

Time and one half the regular rate for Saturday.

Double time the regular rate for Sunday.

### Overtime Holidays

Double time the regular rate for work on the following holiday(s).

New Year's Day

President's Day

Good Friday

Memorial Day

Independence Day

Labor Day

Columbus Day

Veteran's Day

Thanksgiving Day

Day after Thanksgiving

Christmas Day

### Paid Holidays

None

(Local #7)

---

## MASON TENDER

### Mason Tender

Effective Period: 7/1/2016 - 6/30/2017

Wage Rate per Hour: \$37.55

Supplemental Benefit Rate per Hour: \$29.04

### Overtime

Time and one half the regular rate after an 8 hour day.

Time and one half the regular rate for Saturday.

Double time the regular rate for Sunday.



OFFICE OF THE COMPTROLLER, CITY OF NEW YORK  
§220 PREVAILING WAGE SCHEDULE

Saturday may be used as a make-up day at straight time when a day is lost during that week to inclement weather.

**Overtime Holidays**

Double time the regular rate for work on the following holiday(s).

New Year's Day  
President's Day  
Memorial Day  
Independence Day  
Labor Day  
Thanksgiving Day  
Christmas Day

**Paid Holidays**

None

**Shift Rates**

The Employer may work two (2) shifts with the first shift at the straight time wage rate and the second shift receiving eight (8) hours paid for seven (7) hours work at the straight time wage rate.

(Local #79)

---

---

**MASON TENDER (INTERIOR DEMOLITION WORKER)**

(The erection, building, moving, servicing and dismantling of enclosures, scaffolding, barricades, protection and site safety structures etc., on Interior Demolition jobs.)

**Mason Tender Tier A**

Effective Period: 7/1/2016 - 6/30/2017

Wage Rate per Hour: \$36.19

Supplemental Benefit Rate per Hour: \$22.95

**Mason Tender Tier B**

On Interior Demolition job sites 33 1/3 % of the employees shall be classified as Tier A Interior Demolition Workers and 66 2/3 % shall be classified as Tier B Interior Demolition Workers; provided that the employer may employ more than 33 1/3 % Tier A Interior Demolition Workers on the job site. Where the number of employees on a job site is not divisible by 3, the first additional employee (above the number of employees divisible by three) shall be a Tier B Interior Demolition Worker, and the second additional employee shall be a Tier A Interior Demolition Worker.

Effective Period: 7/1/2016 - 6/30/2017

Wage Rate per Hour: \$25.38

OFFICE OF THE COMPTROLLER, CITY OF NEW YORK  
\$220 PREVAILING WAGE SCHEDULE

Supplemental Benefit Rate per Hour: **\$17.27**

**Overtime**

Time and one half the regular rate after an 8 hour day.  
Time and one half the regular rate for Sunday.

**Overtime Holidays**

Double time the regular rate for work on the following holiday(s).

New Year's Day  
President's Day  
Memorial Day  
Independence Day  
Labor Day  
Thanksgiving Day  
Christmas Day

**Paid Holidays**

None

(Local #79)

---

**METALLIC LATHER**

**Metallic Lather**

Effective Period: 7/1/2016 - 6/30/2017

Wage Rate per Hour: **\$44.53**

Supplemental Benefit Rate per Hour: **\$42.67**

Supplemental Note: Supplemental benefits for overtime are paid at the appropriate overtime rate.

**Overtime Description**

Overtime would be time and one half the regular rate after a seven (7) or eight (8) hours workday, which would be set at the start of the job.

**Overtime**

Time and one half the regular rate for Saturday.  
Double time the regular rate for Sunday.

**Overtime Holidays**

Double time the regular rate for work on the following holiday(s).

New Year's Day  
Washington's Birthday  
Memorial Day  
Independence Day  
Labor Day  
Columbus Day

OFFICE OF THE COMPTROLLER, CITY OF NEW YORK  
§220 PREVAILING WAGE SCHEDULE

Thanksgiving Day  
Christmas Day

### **Paid Holidays**

1/2 day on Christmas Eve if work is performed in the A.M.  
1/2 day on New Year's Eve if work is performed in the A.M.

### **Shift Rates**

There will be no shift differential paid on the first shift if more than one shift is employed. The shift differential will remain \$12/hour on the second and third shift for the first eight (8) hours if worked. There will be no pyramiding on overtime worked on second and third shifts. The time and one half (1.5x) rate will be against the base wage rate, not the shift differential

(Local #46)

---

## **MILLWRIGHT**

### **Millwright**

Effective Period: 7/1/2016 - 6/30/2017

Wage Rate per Hour: **\$51.50**

Supplemental Benefit Rate per Hour: **\$52.41**

### **Overtime**

Time and one half the regular rate after an 8-hour day.

Time and one half the regular rate for Saturday.

Double time the regular rate for Sunday.

Saturday may be used as a make-up day at straight time when a day is lost during that week to inclement weather.

### **Overtime Holidays**

Double time the regular rate for work on the following holiday(s).

New Year's Day

President's Day

Good Friday

Memorial Day

Independence Day

Labor Day

Columbus Day

Presidential Election Day

Thanksgiving Day

Christmas Day

### **Paid Holidays**

1/2 day on Christmas Eve if work is performed in the A.M.

1/2 day on New Year's Eve if work is performed in the A.M.

OFFICE OF THE COMPTROLLER, CITY OF NEW YORK  
\$220 PREVAILING WAGE SCHEDULE

### Shift Rates

The first shift shall receive the straight time rate of pay. The second shift receives the straight time rate of pay plus fifteen (15%) per cent. Members of the second shift shall be allowed one half hour to eat, with this time being included in the hours of the workday established. There must be a first shift to work a second shift. All additional hours worked shall be paid at the time and one-half rate of pay plus fifteen (15%) per cent for weekday hours.

(Local #740)

---

---

## MOSAIC MECHANIC

### Mosaic Mechanic - Mosaic & Terrazzo Mechanic

Effective Period: 7/1/2016 - 6/30/2017

Wage Rate per Hour: **\$46.52**

Supplemental Benefit Rate per Hour: **\$39.84**

Supplemental Note: Supplemental benefits for overtime to be paid at the rate of \$50.86 per hour.

### Mosaic Mechanic - Mosaic & Terrazzo Finisher

Effective Period: 7/1/2016 - 6/30/2017

Wage Rate per Hour: **\$44.91**

Supplemental Benefit Rate per Hour: **\$39.83**

Supplemental Note: Supplemental benefits for overtime to be paid at the rate of \$50.85 per hour.

### Mosaic Mechanic - Machine Operator Grinder

Effective Period: 7/1/2016 - 6/30/2017

Wage Rate per Hour: **\$44.91**

Supplemental Benefit Rate per Hour: **\$39.83**

Supplemental Note: Supplemental benefits for overtime to be paid at the rate of \$50.85 per hour.

### Overtime

Time and one half the regular rate after a 7 hour day.

Time and one half the regular rate for Saturday.

Double time the regular rate for Sunday.

### Overtime Holidays

Double time the regular rate for work on the following holiday(s).

New Year's Day

Washington's Birthday

Good Friday

Independence Day

Labor Day

Columbus Day

OFFICE OF THE COMPTROLLER, CITY OF NEW YORK  
\$220 PREVAILING WAGE SCHEDULE

Veteran's Day  
Thanksgiving Day  
Day after Thanksgiving  
Christmas Day

**Paid Holidays**

None

(Local #7)

---

---

**PAINTER**

**Painter - Brush & Roller**

Effective Period: 7/1/2016 - 4/30/2017  
Wage Rate per Hour: \$42.50  
Supplemental Benefit Rate per Hour: \$26.62  
Supplemental Note: \$31.25 on overtime

Effective Period: 5/1/2017 - 6/30/2017  
Wage Rate per Hour: \$44.10  
Supplemental Benefit Rate per Hour: \$27.02  
Supplemental Note: \$ 31.65 on overtime

**Spray & Scaffold / Decorative / Sandblast**

Effective Period: 7/1/2016 - 4/30/2017  
Wage Rate per Hour: \$45.50  
Supplemental Benefit Rate per Hour: \$26.62  
Supplemental Note: \$ 31.25 on overtime

Effective Period: 5/1/2017 - 6/30/2017  
Wage Rate per Hour: \$47.10  
Supplemental Benefit Rate per Hour: \$27.02  
Supplemental Note: \$ 31.65 on overtime

**Overtime**

Time and one half the regular rate after a 7 hour day.  
Time and one half the regular rate for Saturday.  
Time and one half the regular rate for Sunday.

**Overtime Holidays**

Time and one half the regular rate for work on the following holiday(s).

New Year's Day  
President's Day  
Memorial Day

OFFICE OF THE COMPTROLLER, CITY OF NEW YORK  
§220 PREVAILING WAGE SCHEDULE

Independence Day  
Labor Day  
Columbus Day  
Thanksgiving Day  
Christmas Day

**Paid Holidays**  
None

(District Council of Painters #9)

---

---

## **PAINTER - METAL POLISHER**

### **METAL POLISHER**

Effective Period: 7/1/2016 - 6/30/2017  
Wage Rate per Hour: **\$28.88**  
Supplemental Benefit Rate per Hour: **\$6.96**

### **METAL POLISHER - NEW CONSTRUCTION**

Effective Period: 7/1/2016 - 6/30/2017  
Wage Rate per Hour: **\$29.83**  
Supplemental Benefit Rate per Hour: **\$6.96**

### **METAL POLISHER - SCAFFOLD OVER 34 FEET**

Effective Period: 7/1/2016 - 6/30/2017  
Wage Rate per Hour: **\$32.38**  
Supplemental Benefit Rate per Hour: **\$6.96**

### **Overtime Description**

All work performed on Saturdays shall be paid at time-in-a half. The exception being; for suspended scaffold work and work deemed as a construction project; an eight (8) hour shift lost during the week due to circumstances beyond the control of the employer, up to a maximum of eight (8) hours per week, may be worked on Saturday at the straight time rate.

### **Overtime**

Time and one half the regular rate after an 8 hour day.  
Time and one half the regular rate for Saturday.  
Double time the regular rate for Sunday.  
Saturday may be used as a make-up day at straight time when a day is lost during that week to inclement weather.  
Triple time the regular rate for work on the following holiday(s).

OFFICE OF THE COMPTROLLER, CITY OF NEW YORK  
§220 PREVAILING WAGE SCHEDULE

**Paid Holidays**

New Year's Day  
Martin Luther King Jr. Day  
President's Day  
Memorial Day  
Independence Day  
Labor Day  
Columbus Day  
Veteran's Day  
Thanksgiving Day  
Day after Thanksgiving  
Christmas Day

**Shift Rates**

Four Days a week at Ten (10) hours straight a day.

Local 8A-28A

---

**PAINTER - STRIPER**

**Striper (paint)**

Effective Period: 7/1/2016 - 6/30/2017

Wage Rate per Hour: \$35.00

Supplemental Benefit Rate per Hour: \$12.32

Supplemental Note: Overtime Supplemental Benefit rate - \$8.02; New Hire Rate (0-3 months) - \$0.00

**Lineperson (thermoplastic)**

Effective Period: 7/1/2016 - 6/30/2017

Wage Rate per Hour: \$39.00

Supplemental Benefit Rate per Hour: \$12.32

Supplemental Note: Overtime Supplemental Benefit rate - \$8.02; New Hire Rate (0-3 months) - \$0.00

**Overtime**

Time and one half the regular rate after an 8 hour day.

Time and one half the regular rate for Saturday.

Double time the regular rate for Sunday.

Time and one half the regular rate for work on the following holiday(s).

**Paid Holidays**

New Year's Day  
Good Friday  
Memorial Day  
Independence Day  
Labor Day

OFFICE OF THE COMPTROLLER, CITY OF NEW YORK  
§220 PREVAILING WAGE SCHEDULE

Columbus Day  
Presidential Election Day  
Thanksgiving Day  
Day after Thanksgiving  
Christmas Day

### Shift Rates

Employees hired before April 1, 2003: 15% night shift premium differential for work commenced at 9:00 PM or later.

### Vacation

Employees with one to two years service shall accrue vacation based on hours worked: 250 hours worked - 1 day vacation; 500 hours worked - 2 days vacation; 750 hours worked - 3 days vacation; 900 hours worked - 4 days vacation; 1,000 hours worked - 5 days vacation. Employees with two to five years service receive two weeks vacation. Employees with five to twenty years service receive three weeks vacation. Employees with twenty to twenty-five years service receive four weeks vacation. Employees with 25 or more years service receive five weeks vacation. Vacation must be taken during winter months. 2 Personal Days except employees hired after 4/1/12 who do not have 2 years of service.

(Local #917)

---

---

## PAINTER - STRUCTURAL STEEL

### Painters on Structural Steel

Effective Period: 7/1/2016 - 6/30/2017

Wage Rate per Hour: \$49.00

Supplemental Benefit Rate per Hour: \$36.08

### Painter - Power Tool

Effective Period: 7/1/2016 - 6/30/2017

Wage Rate per Hour: \$55.00

Supplemental Benefit Rate per Hour: \$36.08

### Overtime Description

Supplemental Benefits shall be paid for each hour worked, up to forty (40) hours per week for the period of May 1st to November 15th or up to fifty (50) hours per week for the period of November 16th to April 30th.

### Overtime

Time and one half the regular rate after a 7 hour day.

Time and one half the regular rate for Saturday.

Time and one half the regular rate for Sunday.

### Overtime Holidays

Double time the regular rate for work on the following holiday(s).

New Year's Day



OFFICE OF THE COMPTROLLER, CITY OF NEW YORK  
\$220 PREVAILING WAGE SCHEDULE

Memorial Day  
Independence Day  
Labor Day  
Thanksgiving Day  
Christmas Day

**Paid Holidays**

None

**Shift Rates**

Regular hourly rates plus a ten per cent (10%) differential .

(Local #806)

---

**PAPERHANGER**

**Paperhanger**

Effective Period: 7/1/2016 - 6/30/2017

Wage Rate per Hour: \$43.58

Supplemental Benefit Rate per Hour: \$30.73

Supplemental Note: Supplemental benefits are to be paid at the appropriate straight time and overtime rate.

**Overtime**

Time and one half the regular rate after a 7 hour day.

Time and one half the regular rate for Saturday.

Time and one half the regular rate for Sunday.

**Overtime Holidays**

Time and one half the regular rate for work on the following holiday(s).

New Year's Day

President's Day

Memorial Day

Independence Day

Labor Day

Thanksgiving Day

Day after Thanksgiving

Christmas Day

**Paid Holidays**

None

**Shift Rates**

Evening shift - 4:30 P.M. to 12:00 Midnight (regular rate of pay); any work performed before 7:00 A.M. shall be at time and one half the regular base rate of pay.

OFFICE OF THE COMPTROLLER, CITY OF NEW YORK  
\$220 PREVAILING WAGE SCHEDULE

(District Council of Painters #9)

---

---

## **PAVER AND ROADBUILDER**

### **Paver & Roadbuilder - Formsetter**

Effective Period: 7/1/2016 - 6/30/2017

Wage Rate per Hour: \$45.35

Supplemental Benefit Rate per Hour: \$38.95

### **Paver & Roadbuilder - Laborer**

Paving and road construction work, regardless of material used, including but not limited to preparation of job sites, removal of old surfaces, asphalt and/or concrete, by whatever method, including but not limited to milling; laying of concrete; laying of asphalt for temporary, patchwork, and utility paving (but not production paving); site preparation and incidental work before the installation of rubberized materials and similar surfaces; installation and repair of temporary construction fencing; slurry seal coating, maintenance of safety surfaces; play equipment installation, and other related work.

Effective Period: 7/1/2016 - 6/30/2017

Wage Rate per Hour: \$41.48

Supplemental Benefit Rate per Hour: \$38.95

### **Production Paver & Roadbuilder - Screed Person**

(Production paving is asphalt paving when using a paving machine or on a project where a paving machine is traditionally used)

Adjustment of paving machinery on production paving jobs.

Effective Period: 7/1/2016 - 6/30/2017

Wage Rate per Hour: \$45.95

Supplemental Benefit Rate per Hour: \$38.95

### **Production Paver & Roadbuilder - Raker**

Effective Period: 7/1/2016 - 6/30/2017

Wage Rate per Hour: \$45.35

Supplemental Benefit Rate per Hour: \$38.95

### **Production Paver & Roadbuilder - Shoveler**

General laborer (except removal of surfaces - see Paver and Roadbuilder-Laborer) including but not limited to tamper, AC paint and liquid tar work.

Effective Period: 7/1/2016 - 6/30/2017

OFFICE OF THE COMPTROLLER, CITY OF NEW YORK  
§220 PREVAILING WAGE SCHEDULE

Wage Rate per Hour: \$42.06

Supplemental Benefit Rate per Hour: \$38.95

### Overtime Description

If an employee works New Year's Day or Christmas Day, they receive the single time rate plus 25%.

### Overtime

Time and one half the regular rate after an 8 hour day.

Time and one half the regular rate for Saturday.

Double time the regular rate for Sunday.

### Overtime Holidays

Double time the regular rate for work on the following holiday(s).

Memorial Day

Independence Day

Labor Day

Columbus Day

Thanksgiving Day

### Shift Rates

When two shifts are employed, the work period for each shift shall be a continuous eight (8) hours. When three shifts are employed, each shift will work seven and one half (7 ½) hours but will be paid for eight (8) hours since only one half (1/2) hour is allowed for meal time.

When two or more shifts are employed, single time will be paid for each shift.

Night Work - On night work, the first eight (8) hours of work will be paid for at the single time rate, except that production paving work shall be paid at 10% over the single time rate for the screed person, rakers and shovelers directly involved only. This differential is to be paid when there is only one shift and the shift works at night. All other workers will be exempt. Hours worked over eight (8) hours during said shift shall be paid for at the time and one-half rate.

(Local #1010)

---

---

## PLASTERER

### Plasterer

Effective Period: 7/1/2016 - 6/30/2017

Wage Rate per Hour: \$43.93

Supplemental Benefit Rate per Hour: \$28.10

### Overtime

Time and one half the regular rate after a 7 hour day.

Time and one half the regular rate for Saturday.

Double time the regular rate for Sunday.

OFFICE OF THE COMPTROLLER, CITY OF NEW YORK  
§220 PREVAILING WAGE SCHEDULE

Saturday may be used as a make-up day at straight time when a day is lost during that week to inclement weather.

**Overtime Holidays**

Double time the regular rate for work on the following holiday(s).

New Year's Day  
Martin Luther King Jr. Day  
President's Day  
Good Friday  
Memorial Day  
Independence Day  
Labor Day  
Columbus Day  
Presidential Election Day  
Thanksgiving Day  
Christmas Day

**Paid Holidays**

None

**Shift Rates**

When it is not possible to conduct alteration work during regular work hours, in a building occupied by tenants, said work shall proceed on a shift basis; however work over seven (7) hours in any twenty four (24) hour period, the time after seven (7) hours shall be considered overtime.

The second shift shall start at a time between 3:30 p.m. and 7:00 p.m. and shall consist of seven (7) working hours and shall receive eight (8) hours of wages and benefits at the straight time rate. The workers on the second shift shall be allowed one-half (½) hour to eat with this time being included in the seven (7) hours of work.

(Local #262)

---

---

**PLASTERER - TENDER**

**Plasterer - Tender**

Effective Period: 7/1/2016 - 6/30/2017

Wage Rate per Hour: \$37.55

Supplemental Benefit Rate per Hour: \$29.04

**Overtime**

Time and one half the regular rate after an 8 hour day.

Time and one half the regular rate for Saturday.

Double time the regular rate for Sunday.

Saturday may be used as a make-up day at straight time when a day is lost during that week to inclement weather.

**Overtime Holidays**

OFFICE OF THE COMPTROLLER, CITY OF NEW YORK  
§220 PREVAILING WAGE SCHEDULE

Double time the regular rate for work on the following holiday(s).

New Year's Day  
Washington's Birthday  
Memorial Day  
Independence Day  
Labor Day  
Presidential Election Day  
Thanksgiving Day  
Christmas Day

### **Paid Holidays**

None

### **Shift Rates**

When work commences outside regular work hours, workers receive an hour additional (differential) wage and supplement payment. Eight hours pay for seven hours work or nine hours pay for eight hours work.

(Mason Tenders District Council)

---

---

## **PLUMBER**

### **Plumber**

Effective Period: 7/1/2016 - 6/30/2017

Wage Rate per Hour: **\$65.67**

Supplemental Benefit Rate per Hour: **\$29.28**

Supplemental Note: Overtime supplemental benefit rate per hour: **\$58.28**

### **Plumber - Temporary Services**

Temporary Services - When there are no Plumbers on the job site, there may be three shifts designed to cover the entire twenty-four hour period, including weekends if necessary, at the following rate straight time.

Effective Period: 7/1/2016 - 6/30/2017

Wage Rate per Hour: **\$52.56**

Supplemental Benefit Rate per Hour: **\$23.40**

### **Overtime Description**

Double time the regular rate after a 7 hour day - unless for new construction site work where the plumbing contract price is \$1.5 million or less, the hours of labor can be 8 hours per day at the employers' option. On Alteration jobs when other mechanical trades at the site are working an eighth hour at straight time, then the plumber shall also work an eighth hour at straight time.

### **Overtime**

Double time the regular time rate for Saturday.

Double time the regular rate for Sunday.

OFFICE OF THE COMPTROLLER, CITY OF NEW YORK  
§220 PREVAILING WAGE SCHEDULE

**Overtime Holidays**

Double time the regular rate for work on the following holiday(s).

New Year's Day  
President's Day  
Memorial Day  
Independence Day  
Labor Day  
Columbus Day  
Veteran's Day  
Thanksgiving Day  
Day after Thanksgiving  
Christmas Day

**Shift Rates**

Shift work, when directly specified in public agency or authority documents where plumbing contract is \$8 million or less, will be permitted. 30% shift premium shall be paid for wages and fringe benefits for 4:00 pm and midnight shifts Monday to Friday. 50% shift premium shall be paid for wages and fringe benefits for 4:00 pm and midnight shift work performed on weekends. For shift work on holidays, double time wages and fringe benefits shall be paid.

(Plumbers Local #1)

---

---

**PLUMBER (MECHANICAL EQUIPMENT AND SERVICE)**  
(Mechanical Equipment and Service work shall include any repair and/or replacement of the present plumbing system.)

**Plumber**

Effective Period: 7/1/2016 - 6/30/2017

Wage Rate per Hour: \$39.42

Supplemental Benefit Rate per Hour: \$14.19

**Overtime**

Time and one half the regular rate after an 8 hour day.

Time and one half the regular rate for Saturday.

Time and one half the regular rate for Sunday.

**Overtime Holidays**

Time and one half the regular rate for work on the following holiday(s).

New Year's Day  
President's Day  
Memorial Day  
Independence Day  
Thanksgiving Day

OFFICE OF THE COMPTROLLER, CITY OF NEW YORK  
\$220 PREVAILING WAGE SCHEDULE

Day after Thanksgiving  
Christmas Day

**Paid Holidays**  
None

(Plumbers Local # 1)

---

---

**PLUMBER (RESIDENTIAL RATES FOR 1, 2 AND 3 FAMILY HOME CONSTRUCTION)**

Effective Period: 7/1/2016 - 6/30/2017

Wage Rate per Hour: \$45.47

Supplemental Benefit Rate per Hour: \$21.26

**Overtime**

Double time the regular rate after an 8 hour day.  
Double time the regular time rate for Saturday.  
Double time the regular rate for Sunday.

**Overtime Holidays**

Double time the regular rate for work on the following holiday(s).

New Year's Day  
President's Day  
Memorial Day  
Independence Day  
Labor Day  
Columbus Day  
Veteran's Day  
Thanksgiving Day  
Day after Thanksgiving  
Christmas Day

**Paid Holidays**

None

**Shift Rates**

30% shift premium shall be paid for wages and fringe benefits for 4:00 pm and midnight shifts Monday to Friday.  
50% shift premium shall be paid for wages and fringe benefits for 4:00 pm and midnight shift work performed on weekends. For shift work on holidays, double time wages and fringe benefits shall be paid.

(Plumbers Local #1)

---

---

OFFICE OF THE COMPTROLLER, CITY OF NEW YORK  
§220 PREVAILING WAGE SCHEDULE

**PLUMBER: PUMP & TANK**  
**Oil Trades (Installation and Maintenance)**

**Plumber - Pump & Tank**

Effective Period: 7/1/2016 - 6/30/2017

Wage Rate per Hour: **\$63.52**

Supplemental Benefit Rate per Hour: **\$22.91**

**Overtime**

Time and one half the regular rate after an 8 hour day.

Time and one half the regular rate for Saturday.

Time and one half the regular rate for Sunday.

**Overtime Holidays**

Time and one half the regular rate for work on the following holiday(s).

New Year's Day

President's Day

Memorial Day

Independence Day

Labor Day

Columbus Day

Veteran's Day

Thanksgiving Day

Day after Thanksgiving

Christmas Day

**Paid Holidays**

None

**Shift Rates**

All work outside the regular workday (8:00 A.M. to 3:30 P.M.) is to be paid at time and one half the regular hourly rate

(Plumbers Local #1)

---

---

**POINTER, WATERPROOFER, CAULKER, SANDBLASTER,  
STEAMBLASTER**  
**(Exterior Building Renovation)**

**Journey person**



OFFICE OF THE COMPTROLLER, CITY OF NEW YORK  
§220 PREVAILING WAGE SCHEDULE

Effective Period: 7/1/2016 - 6/30/2017

Wage Rate per Hour: \$50.04

Supplemental Benefit Rate per Hour: \$26.15

**Overtime**

Time and one half the regular rate after an 8 hour day.

Time and one half the regular rate for Saturday.

Time and one half the regular rate for Sunday.

Saturday may be used as a make-up day at straight time when a day is lost during that week to inclement weather.

**Overtime Holidays**

Time and one half the regular rate for work on the following holiday(s).

New Year's Day

Martin Luther King Jr. Day

President's Day

Memorial Day

Independence Day

Labor Day

Thanksgiving Day

Christmas Day

**Paid Holidays**

None

**Shift Rates**

All work outside the regular work day (an eight hour workday between the hours of 6:00 A.M. and 4:30 P.M.) is to be paid at time and one half the regular rate.

(Bricklayer District Council)

---

---

**ROOFER**

**Roofer**

Effective Period: 7/1/2016 - 6/30/2017

Wage Rate per Hour: \$40.70

Supplemental Benefit Rate per Hour: \$30.17

**Overtime**

Time and one half the regular rate after an 8 hour day.

Time and one half the regular rate for Saturday.

Time and one half the regular rate for Sunday.

**Overtime Holidays**

OFFICE OF THE COMPTROLLER, CITY OF NEW YORK  
§220 PREVAILING WAGE SCHEDULE

Time and one half the regular rate for work on the following holiday(s).

New Year's Day  
President's Day  
Memorial Day  
Independence Day  
Labor Day  
Presidential Election Day  
Thanksgiving Day  
Christmas Day

**Paid Holidays**

None

**Shift Rates**

Second shift - Regular hourly rate plus a 10% differential. Third shift - Regular hourly rate plus a 15% differential.

(Local #8)

---

---

**SHEET METAL WORKER**

**Sheet Metal Worker**

Effective Period: 7/1/2016 - 6/30/2017

Wage Rate per Hour: **\$47.70**

Supplemental Benefit Rate per Hour: **\$46.45**

Supplemental Note: Supplemental benefit contributions are to be made at the applicable overtime rates.

**Sheet Metal Worker - Fan Maintenance**

(The temporary operation of fans or blowers in new or existing buildings for heating and/or ventilation, and/or air conditioning prior to the completion of the project.)

Effective Period: 7/1/2016 - 6/30/2017

Wage Rate per Hour: **\$38.16**

Supplemental Benefit Rate per Hour: **\$46.45**

**Sheet Metal Worker - Duct Cleaner**

Effective Period: 7/1/2016 - 6/30/2017

Wage Rate per Hour: **\$12.90**

Supplemental Benefit Rate per Hour: **\$8.07**

**Overtime**

Time and one half the regular rate after an 8 hour day.

Time and one half the regular rate for Saturday.

Double time the regular rate for Sunday.

OFFICE OF THE COMPTROLLER, CITY OF NEW YORK  
§220 PREVAILING WAGE SCHEDULE

**Overtime Holidays**

Double time the regular rate for work on the following holiday(s).

New Year's Day  
Martin Luther King Jr. Day  
President's Day  
Memorial Day  
Independence Day  
Labor Day  
Columbus Day  
Veteran's Day  
Thanksgiving Day  
Day after Thanksgiving  
Christmas Day

**Paid Holidays**

None

**Shift Rates**

Work that can only be performed outside regular working hours (eight hours of work between 7:30 A.M. and 3:30 P.M.) - First shift (work between 3:30 P.M. and 11:30 P.M.) - 10% differential above the established hourly rate.  
Second shift (work between 11:30 P.M. and 7:30 A.M.) - 15% differential above the established hourly rate.

For Fan Maintenance: On all full shifts of fan maintenance work the straight time hourly rate of pay will be paid for each shift, including nights, Saturdays, Sundays, and holidays.

(Local #28)

---

**SHEET METAL WORKER - SPECIALTY  
(Decking & Siding)**

**Sheet Metal Specialty Worker**

The first worker to perform this work must be paid at the rate of the Sheet Metal Worker. The second and third workers shall be paid the Specialty Worker Rate. The ratio of One Sheet Metal Worker, then Two Specialty Workers shall be utilized thereafter.

Effective Period: 7/1/2016 - 6/30/2017

Wage Rate per Hour: \$43.25

Supplemental Benefit Rate per Hour: \$24.41

Supplemental Note: Supplemental benefit contributions are to be made at the applicable overtime rates.

**Overtime**

Time and one half the regular rate after an 8 hour day.

Time and one half the regular rate for Saturday.

Double time the regular rate for Sunday.

OFFICE OF THE COMPTROLLER, CITY OF NEW YORK  
\$220 PREVAILING WAGE SCHEDULE

**Overtime Holidays**

Double time the regular rate for work on the following holiday(s).

New Year's Day  
Martin Luther King Jr. Day  
President's Day  
Memorial Day  
Independence Day  
Labor Day  
Columbus Day  
Veteran's Day  
Thanksgiving Day  
Christmas Day

**Paid Holidays**

None

(Local #28)

---

---

**SHIPYARD WORKER**

**Shipyard Mechanic - First Class**

Effective Period: 7/1/2016 - 6/30/2017

Wage Rate per Hour: \$28.33

Supplemental Benefit Rate per Hour: \$3.04

**Shipyard Mechanic - Second Class**

Effective Period: 7/1/2016 - 6/30/2017

Wage Rate per Hour: \$22.18

Supplemental Benefit Rate per Hour: \$2.80

**Shipyard Laborer - First Class**

Effective Period: 7/1/2016 - 6/30/2017

Wage Rate per Hour: \$20.45

Supplemental Benefit Rate per Hour: \$2.74

**Shipyard Laborer - Second Class**

Effective Period: 7/1/2016 - 6/30/2017

Wage Rate per Hour: \$14.36

Supplemental Benefit Rate per Hour: \$2.50

OFFICE OF THE COMPTROLLER, CITY OF NEW YORK  
\$220 PREVAILING WAGE SCHEDULE

**Shipyard Dockhand - First Class**

Effective Period: 7/1/2016 - 6/30/2017

Wage Rate per Hour: **\$22.70**

Supplemental Benefit Rate per Hour: **\$2.82**

**Shipyard Dockhand - Second Class**

Effective Period: 7/1/2016 - 6/30/2017

Wage Rate per Hour: **\$16.01**

Supplemental Benefit Rate per Hour: **\$2.57**

**Overtime Description**

Work performed on holiday is paid double time the regular hourly wage rate plus holiday pay.

**Overtime**

Time and one half the regular rate after an 8 hour day.

Time and one half the regular rate for Saturday.

Double time the regular rate for Sunday.

Time and one half the regular hourly rate after 40 hours in any work week.

**Paid Holidays**

New Year's Day

Martin Luther King Jr. Day

President's Day

Good Friday

Memorial Day

Independence Day

Labor Day

Thanksgiving Day

Day after Thanksgiving

Christmas Day

Based on Survey Data

---

**SIGN ERECTOR**  
**(Sheet Metal, Plastic, Electric, and Neon)**

**Sign Erector**

Effective Period: 7/1/2016 - 6/30/2017

Wage Rate per Hour: **\$46.85**

Supplemental Benefit Rate per Hour: **\$48.57**

OFFICE OF THE COMPTROLLER, CITY OF NEW YORK  
§220 PREVAILING WAGE SCHEDULE

**Overtime**

Time and one half the regular rate after a 7 hour day.  
Time and one half the regular rate for Saturday.  
Time and one half the regular rate for Sunday.  
Time and one half the regular rate for work on the following holiday(s).

**Paid Holidays**

New Year's Day  
Washington's Birthday  
Memorial Day  
Independence Day  
Labor Day  
Columbus Day  
Election Day  
Thanksgiving Day  
Day after Thanksgiving  
Christmas Day

**Shift Rates**

Time and one half the regular hourly rate is to be paid for all hours worked outside the regular workday either (7:00 A.M. through 2:30 P.M.) or (8:00 A.M. through 3:30 P.M.)

(Local #137)

---

---

**STEAMFITTER**

**Steamfitter I**

Effective Period: 7/1/2016 - 6/30/2017  
Wage Rate per Hour: **\$55.50**  
Supplemental Benefit Rate per Hour: **\$54.29**  
Supplemental Note: Overtime supplemental benefit rate: **\$107.84**

**Steamfitter -Temporary Services**

The steamfitters shall not do any other work and shall not be permitted to work more than one shift in a twenty-four hour day. When steamfitters are present during the regular working day, no temporary services steamfitter will be required

Effective Period: 7/1/2016 - 6/30/2017  
Wage Rate per Hour: **\$42.18**  
Supplemental Benefit Rate per Hour: **\$44.08**

**Overtime**

Double time the regular rate after a 7 hour day.  
Double time the regular time rate for Saturday.

OFFICE OF THE COMPTROLLER, CITY OF NEW YORK  
§220 PREVAILING WAGE SCHEDULE

Double time the regular rate for Sunday.

### **Overtime Holidays**

Double time the regular rate for work on the following holiday(s).

New Year's Day  
President's Day  
Memorial Day  
Independence Day  
Labor Day  
Columbus Day  
Veteran's Day  
Thanksgiving Day  
Day after Thanksgiving  
Christmas Day

### **Paid Holidays**

None

### **Shift Rates**

Work performed between 3:30 P.M. and 7:00 A.M. and on Saturdays, Sundays and Holidays shall be at double time the regular hourly rate and paid at the overtime supplemental benefit rate above.

---

### **Steamfitter II**

For heating, ventilation, air conditioning and mechanical public works contracts with a dollar value not to exceed \$15,000,000 and for fire protection/sprinkler public works contracts not to exceed \$1,500,000.

Effective Period: 7/1/2016 - 6/30/2017

Wage Rate per Hour: \$55.50

Supplemental Benefit Rate per Hour: \$54.29

Supplemental Note: Overtime supplemental benefit rate: \$107.84

### **Steamfitter -Temporary Services**

The steamfitters shall not do any other work and shall not be permitted to work more than one shift in a twenty-four hour day. When steamfitters are present during the regular working day, no temporary services steamfitter will be required.

Effective Period: 7/1/2016 - 6/30/2017

Wage Rate per Hour: \$42.18

Supplemental Benefit Rate per Hour: \$44.08

### **Overtime**

Double time the regular rate after an 8 hour day.

Double time the regular time rate for Saturday.

Double time the regular rate for Sunday.

### **Overtime Holidays**

OFFICE OF THE COMPTROLLER, CITY OF NEW YORK  
§220 PREVAILING WAGE SCHEDULE

Double time the regular rate for work on the following holiday(s).

New Year's Day  
President's Day  
Memorial Day  
Independence Day  
Labor Day  
Columbus Day  
Veteran's Day  
Thanksgiving Day  
Day after Thanksgiving  
Christmas Day

**Paid Holidays**

None

**Shift Rates**

May be performed outside of the regular workday except Saturday, Sunday and Holidays. A shift shall consist of eight working hours. All work performed in excess of eight hours shall be paid at double time. No shift shall commence after 7:00 P.M. on Friday or 7:00 P.M. the day before holidays. All work performed after 12:01 A.M. Saturday or 12:01 A.M. the day before a Holiday will be paid at double time. When shift work is performed the wage rate for regular time worked is a thirty percent premium together with fringe benefits.

On Transit Authority projects, where work is performed in the vicinity of tracks all shift work on weekends and holidays may be performed at the regular shift rates.

Local #638

---

---

**STEAMFITTER - REFRIGERATION AND AIR CONDITIONER  
(Maintenance and Installation Service Person)**

**Refrigeration and Air Conditioner Mechanic**

Effective Period: 7/1/2016 - 6/30/2017

Wage Rate per Hour: \$39.50

Supplemental Benefit Rate per Hour: \$15.06

**Refrigeration and Air Conditioner Service Person V**

Effective Period: 7/1/2016 - 6/30/2017

Wage Rate per Hour: \$32.46

Supplemental Benefit Rate per Hour: \$13.53

**Refrigeration and Air Conditioner Service Person IV**

Effective Period: 7/1/2016 - 6/30/2017



OFFICE OF THE COMPTROLLER, CITY OF NEW YORK  
§220 PREVAILING WAGE SCHEDULE

Wage Rate per Hour: \$26.89

Supplemental Benefit Rate per Hour: \$12.26

**Refrigeration and Air Conditioner Service Person III**

Filter changing and maintenance thereof, oil and greasing, tower and coil cleaning, scraping and painting, general housekeeping, taking of water samples.

Effective Period: 7/1/2016 - 6/30/2017

Wage Rate per Hour: \$23.08

Supplemental Benefit Rate per Hour: \$11.31

**Refrigeration and Air Conditioner Service Person II**

Filter changing and maintenance thereof, oil and greasing, tower and coil cleaning, scraping and painting, general housekeeping, taking of water samples.

Effective Period: 7/1/2016 - 6/30/2017

Wage Rate per Hour: \$19.14

Supplemental Benefit Rate per Hour: \$10.43

**Refrigeration and Air Conditioner Service Person I**

Filter changing and maintenance thereof, oil and greasing, tower and coil cleaning, scraping and painting, general housekeeping, taking of water samples.

Effective Period: 7/1/2016 - 6/30/2017

Wage Rate per Hour: \$14.00

Supplemental Benefit Rate per Hour: \$9.46

**Overtime**

Time and one half the regular rate after an 8 hour day.

Time and one half the regular rate for Saturday.

Double time the regular rate for Sunday.

**Overtime Holidays**

Double time the regular rate for work on the following holiday(s).

New Year's Day

Independence Day

Labor Day

Veteran's Day

Thanksgiving Day

Christmas Day

Double time and one half the regular rate for work on the following holiday(s).

Martin Luther King Jr. Day

President's Day

Memorial Day

Columbus Day

**Paid Holidays**

OFFICE OF THE COMPTROLLER, CITY OF NEW YORK  
§220 PREVAILING WAGE SCHEDULE

New Year's Day  
Martin Luther King Jr. Day  
President's Day  
Memorial Day  
Independence Day  
Labor Day  
Columbus Day  
Veteran's Day  
Thanksgiving Day  
Christmas Day

(Local #638B)

---

---

## **STONE MASON - SETTER**

### **Stone Mason - Setters**

Effective Period: 7/1/2016 - 6/30/2017

Wage Rate per Hour: **\$51.08**

Supplemental Benefit Rate per Hour: **\$38.10**

### **Overtime**

Time and one half the regular rate after a 7 hour day.

Time and one half the regular rate for Saturday.

Double time the regular rate for Sunday.

### **Overtime Holidays**

Double time the regular rate for work on the following holiday(s).

New Year's Day

Washington's Birthday

Good Friday

Memorial Day

Independence Day

Labor Day

Thanksgiving Day

Christmas Day

### **Paid Holidays**

1/2 day on Christmas Eve if work is performed in the A.M.

### **Shift Rates**

For all work outside the regular workday (8:00 A.M. to 3:30 P.M. Monday through Friday), the pay shall be straight time plus a ten percent (10%) differential.

(Bricklayers District Council)

---

OFFICE OF THE COMPTROLLER, CITY OF NEW YORK  
§220 PREVAILING WAGE SCHEDULE

---

## **TAPER**

### **Drywall Taper**

Effective Period: 7/1/2016 - 12/27/2016

Wage Rate per Hour: **\$47.32**

Supplemental Benefit Rate per Hour: **\$22.68**

Effective Period: 12/28/2016 - 6/30/2017

Wage Rate per Hour: **\$47.82**

Supplemental Benefit Rate per Hour: **\$22.68**

### **Overtime**

Time and one half the regular rate after a 7 hour day.

Time and one half the regular rate for Saturday.

Time and one half the regular rate for Sunday.

### **Overtime Holidays**

Time and one half the regular rate for work on the following holiday(s).

New Year's Day

Martin Luther King Jr. Day

President's Day

Good Friday

Memorial Day

Independence Day

Labor Day

Columbus Day

Thanksgiving Day

Christmas Day

### **Paid Holidays**

Any worker who reports to work on Christmas Eve or New Year's Eve pursuant to his employer's instruction shall be entitled to three (3) hours afternoon pay without working.

### **Shift Rates**

Time and one half the regular rate outside the regular work hours (8:00 A.M. through 3:30 P.M.)

(Local #1974)

---

## **TELECOMMUNICATION WORKER (Voice Installation Only)**

OFFICE OF THE COMPTROLLER, CITY OF NEW YORK  
\$220 PREVAILING WAGE SCHEDULE

**Telecommunication Worker**

Effective Period: 7/1/2016 - 6/30/2017

Wage Rate per Hour: \$40.35

Supplemental Benefit Rate per Hour: \$13.19

Supplemental Note: The above rate applies for Manhattan, Bronx, Brooklyn, Queens. \$12.64 for Staten Island only.

**Overtime**

Time and one half the regular rate after a 7 hour day.

Time and one half the regular rate for Saturday.

Time and one half the regular rate for Sunday.

**Overtime Holidays**

Time and one half the regular rate for work on the following holiday(s).

- New Year's Day
- Lincoln's Birthday
- Washington's Birthday
- Memorial Day
- Independence Day
- Labor Day
- Columbus Day
- Election Day
- Veteran's Day
- Thanksgiving Day
- Christmas Day

**Paid Holidays**

- New Year's Day
- Lincoln's Birthday
- Washington's Birthday
- Memorial Day
- Independence Day
- Labor Day
- Columbus Day
- Election Day
- Veteran's Day
- Thanksgiving Day
- Christmas Day

Employees have the option of observing either Martin Luther King's Birthday or the day after Thanksgiving instead of Lincoln's Birthday

**Shift Rates**

For any workday that starts before 8A.M. or ends after 6P.M. there is a 10% differential for the applicable worker's hourly rate.

**Vacation**

- After 6 months.....one week.
- After 12 months but less than 7 years.....two weeks.
- After 7 or more but less than 15 years.....three weeks.
- After 15 years or more but less than 25 years.....four weeks.

OFFICE OF THE COMPTROLLER, CITY OF NEW YORK  
§220 PREVAILING WAGE SCHEDULE

(C.W.A.)

---

---

## TILE FINISHER

### Tile Finisher

Effective Period: 7/1/2016 - 6/30/2017

Wage Rate per Hour: \$40.69

Supplemental Benefit Rate per Hour: \$30.58

### Overtime

Time and one half the regular rate after a 7 hour day.

Time and one half the regular rate for Saturday.

Double time the regular rate for Sunday.

### Overtime Holidays

Double time the regular rate for work on the following holiday(s).

New Year's Day

President's Day

Good Friday

Memorial Day

Independence Day

Labor Day

Columbus Day

Veteran's Day

Thanksgiving Day

Day after Thanksgiving

Christmas Day

### Paid Holidays

None

### Shift Rates

Off shift work day (work performed outside the regular 8:00 A.M. to 3:30 P.M. workday): shift differential of one and one quarter (1¼) times the regular straight time rate of pay for the seven hours of actual off-shift work.

(Local #7)

---

---

## TILE LAYER - SETTER

### Tile Layer - Setter

OFFICE OF THE COMPTROLLER, CITY OF NEW YORK  
\$220 PREVAILING WAGE SCHEDULE

Effective Period: 7/1/2016 - 6/30/2017

Wage Rate per Hour: \$52.68

Supplemental Benefit Rate per Hour: \$34.48

**Overtime**

Time and one half the regular rate after a 7 hour day.

Time and one half the regular rate for Saturday.

Double time the regular rate for Sunday.

**Overtime Holidays**

Double time the regular rate for work on the following holiday(s).

New Year's Day

President's Day

Good Friday

Memorial Day

Independence Day

Labor Day

Columbus Day

Veteran's Day

Thanksgiving Day

Day after Thanksgiving

Christmas Day

**Shift Rates**

Off shift work day (work performed outside the regular 8:00 A.M. to 3:30 P.M. workday): shift differential of one and one quarter (1¼) times the regular straight time rate of pay for the seven hours of actual off-shift work.

(Local #7)

---

---

**TIMBERPERSON**

**Timberperson**

Effective Period: 7/1/2016 - 6/30/2017

Wage Rate per Hour: \$46.99

Supplemental Benefit Rate per Hour: \$48.26

**Overtime**

Time and one half the regular rate after an 8 hour day.

Time and one half the regular rate for Saturday.

Double time the regular rate for Sunday.

Saturday may be used as a make-up day at straight time when a day is lost during that week to inclement weather.

Time and one half the regular hourly rate after 40 hours in any work week.

OFFICE OF THE COMPTROLLER, CITY OF NEW YORK  
§220 PREVAILING WAGE SCHEDULE

**Overtime Holidays**

Double time the regular rate for work on the following holiday(s).

New Year's Day  
President's Day  
Memorial Day  
Independence Day  
Labor Day  
Columbus Day  
Presidential Election Day  
Thanksgiving Day  
Christmas Day

**Paid Holidays**

None

**Shift Rates**

Off shift work commencing between 5:00 P.M. and 11:00 P.M. shall work eight and one half hours allowing for one half hour for lunch. The wage rate shall be 113% of the straight time hourly wage rate.

(Local #1536)

---

---

**TUNNEL WORKER**

**Blasters, Mucking Machine Operators (Compressed Air Rates)**

Effective Period: 7/1/2016 - 6/30/2017

Wage Rate per Hour: \$60.97

Supplemental Benefit Rate per Hour: \$50.72

**Tunnel Workers (Compressed Air Rates)**

Effective Period: 7/1/2016 - 6/30/2017

Wage Rate per Hour: \$58.86

Supplemental Benefit Rate per Hour: \$49.03

**Top Nipper (Compressed Air Rates)**

Effective Period: 7/1/2016 - 6/30/2017

Wage Rate per Hour: \$57.78

Supplemental Benefit Rate per Hour: \$48.16

**Outside Lock Tender, Outside Gauge Tender, Muck Lock Tender (Compressed Air Rates)**

Effective Period: 7/1/2016 - 6/30/2017

OFFICE OF THE COMPTROLLER, CITY OF NEW YORK  
§220 PREVAILING WAGE SCHEDULE

Wage Rate per Hour: \$56.74

Supplemental Benefit Rate per Hour: \$47.25

**Bottom Bell & Top Bell Signal Person: Shaft Person (Compressed Air Rates)**

Effective Period: 7/1/2016 - 6/30/2017

Wage Rate per Hour: \$56.74

Supplemental Benefit Rate per Hour: \$47.25

**Changehouse Attendant: Powder Watchperson (Compressed Air Rates)**

Effective Period: 7/1/2016 - 6/30/2017

Wage Rate per Hour: \$49.69

Supplemental Benefit Rate per Hour: \$44.69

**Blasters (Free Air Rates)**

Effective Period: 7/1/2016 - 6/30/2017

Wage Rate per Hour: \$58.19

Supplemental Benefit Rate per Hour: \$48.68

**Tunnel Workers (Free Air Rates)**

Effective Period: 7/1/2016 - 6/30/2017

Wage Rate per Hour: \$55.69

Supplemental Benefit Rate per Hour: \$46.61

**All Others (Free Air Rates)**

Effective Period: 7/1/2016 - 6/30/2017

Wage Rate per Hour: \$51.45

Supplemental Benefit Rate per Hour: \$43.13

**Microtunneling (Free Air Rates)**

Effective Period: 7/1/2016 - 6/30/2017

Wage Rate per Hour: \$44.55

Supplemental Benefit Rate per Hour: \$37.29

**Overtime Description**

For Repair-Maintenance Work on Existing Equipment and Facilities - Time and one half the regular rate after a 7 hour day, or for Saturday, or for Sunday. Double time the regular rate for work on a holiday.

For Small-Bore Micro Tunneling Machines - Time and one-half the regular rate shall be paid for all overtime.

**Overtime**

Double time the regular rate after an 8 hour day.

Double time the regular time rate for Saturday.

Double time the regular rate for Sunday.

Double time the regular rate for work on the following holiday(s).



OFFICE OF THE COMPTROLLER, CITY OF NEW YORK  
§220 PREVAILING WAGE SCHEDULE

**Paid Holidays**

New Year's Day  
Lincoln's Birthday  
President's Day  
Memorial Day  
Independence Day  
Labor Day  
Columbus Day  
Election Day  
Veteran's Day  
Thanksgiving Day  
Christmas Day

(Local #147)

---

---

**WELDER**

**TO BE PAID AT THE RATE OF THE JOURNEYPERSON IN THE TRADE  
PERFORMING THE WORK.**

**(NO TEXT THIS PAGE)**

**OFFICE OF THE COMPTROLLER**

**CITY OF NEW YORK**

**220 APPRENTICESHIP PREVAILING WAGE SCHEDULE**

**APPENDIX**

**Pursuant to Labor Law §220 (3-e), only apprentices who are individually registered in a bona fide program to which the employer contractor is a participant and registered with the New York State Department of Labor, may be employed on a public work project.**

**Any employee listed on a payroll at an apprentice wage rate, who is not registered as above, shall be paid the journey person wage rate for the classification of work he actually performed.**

**Apprentice ratios are established to ensure the proper safety, training and supervision of apprentices. A ratio establishes the number of journey workers required for each apprentice in a program and on a job site. Ratios are interpreted as follows: in the case of a 1:1, 1:4 ratio, there must be one journey worker for the first apprentice, and four additional journey workers for each subsequent apprentice.**

OFFICE OF THE COMPTROLLER, CITY OF NEW YORK  
 §220 APPRENTICESHIP PREVAILING WAGE SCHEDULE

**TABLE OF CONTENTS**

<b><u>CLASSIFICATION</u></b>	<b><u>PAGE</u></b>
ASBESTOS HANDLER .....	3
BOILERMAKER.....	3
BRICKLAYER.....	4
CARPENTER .....	5
CEMENT MASON.....	6
CEMENT AND CONCRETE WORKER.....	7
DERRICKPERSON & RIGGER (STONE) .....	8
DOCKBUILDER/PILE DRIVER .....	8
ELECTRICIAN .....	9
ELEVATOR CONSTRUCTOR.....	12
ELEVATOR REPAIR & MAINTENANCE .....	13
ENGINEER.....	14
ENGINEER - OPERATING .....	14
FLOOR COVERER .....	15
GLAZIER.....	16
HEAT & FROST INSULATOR .....	16
HOUSE WRECKER .....	17
IRON WORKER - ORNAMENTAL .....	18
IRON WORKER - STRUCTURAL .....	18
LABORER (FOUNDATION, CONCRETE, EXCAVATING, STREET PIPE LAYER & COMMON).....	19
MARBLE MECHANICS .....	20
MASON TENDER .....	21
METALLIC LATHER.....	22
MILLWRIGHT.....	22
PAVER AND ROADBUILDER.....	23
PAINTER.....	24
PAINTER - METAL POLISHER.....	25
PAINTER - STRUCTURAL STEEL .....	25
PLASTERER.....	26
PLASTERER - TENDER.....	27
PLUMBER.....	27
POINTER, WATERPROOFER, CAULKER, SANDBLASTER, STEAMBLASTER .....	29
ROOFER.....	29
SHEET METAL WORKER.....	30
SIGN ERECTOR .....	31
STEAMFITTER .....	32
STONE MASON - SETTER .....	33
TAPER .....	34
TILE LAYER - SETTER .....	35
TIMBERPERSON.....	35

OFFICE OF THE COMPTROLLER, CITY OF NEW YORK  
§220 APPRENTICESHIP PREVAILING WAGE SCHEDULE

**ASBESTOS HANDLER**

(Ratio of Apprentice Journeyperson: 1 to 1, 1 to 3)

**Asbestos Handler (First 1000 Hours)**

Effective Period: 7/1/2016 - 6/30/2017  
Wage Rate Per Hour: 78% of Journeyperson's rate  
Supplemental Benefit Rate Per Hour: \$16.45

**Asbestos Handler (Second 1000 Hours)**

Effective Period: 7/1/2016 - 6/30/2017  
Wage Rate Per Hour: 80% of Journeyperson's rate  
Supplemental Benefit Rate Per Hour: \$16.45

**Asbestos Handler (Third 1000 Hours)**

Effective Period: 7/1/2016 - 6/30/2017  
Wage Rate Per Hour: 83% of Journeyperson's rate  
Supplemental Benefit Rate Per Hour: \$16.45

**Asbestos Handler (Fourth 1000 Hours)**

Effective Period: 7/1/2016 - 6/30/2017  
Wage Rate Per Hour: 89% of Journeyperson's rate  
Supplemental Benefit Rate Per Hour: \$16.45

(Local #78)

---

---

**BOILERMAKER**

(Ratio of Apprentice to Journeyperson: 1 to 1, 1 to 3)

**Boilermaker (First Year)**

Effective Period: 7/1/2016 - 6/30/2017  
Wage Rate Per Hour: 65% of Journeyperson's rate  
Supplemental Benefit Rate Per Hour: \$30.43  
Effective 1/1/2017 - Supplemental Benefit Rate Per Hour: \$30.84

**Boilermaker (Second Year: 1st Six Months)**

Effective Period: 7/1/2016 - 6/30/2017

OFFICE OF THE COMPTROLLER, CITY OF NEW YORK  
§220 APPRENTICESHIP PREVAILING WAGE SCHEDULE

Wage Rate Per Hour: 70% of Journeyperson's rate  
Supplemental Benefit Rate Per Hour: \$32.13  
Effective 1/1/2017 - Supplemental Benefit Rate Per Hour: \$32.57

**Boilermaker (Second Year: 2nd Six Months)**

Effective Period: 7/1/2016 - 6/30/2017  
Wage Rate Per Hour: 75% of Journeyperson's rate  
Supplemental Benefit Rate Per Hour: \$33.82  
Effective 1/1/2017 - Supplemental Benefit Rate Per Hour: \$34.29

**Boilermaker (Third Year: 1st Six Months)**

Effective Period: 7/1/2016 - 6/30/2017  
Wage Rate Per Hour: 80% of Journeyperson's rate  
Supplemental Benefit Rate Per Hour: \$35.53  
Effective 1/1/2017 - Supplemental Benefit Rate Per Hour: \$36.03

**Boilermaker (Third Year: 2nd Six Months)**

Effective Period: 7/1/2016 - 6/30/2017  
Wage Rate Per Hour: 85% of Journeyperson's rate  
Supplemental Benefit Rate Per Hour: \$37.23  
Effective 1/1/2017 - Supplemental Benefit Rate Per Hour: \$37.76

**Boilermaker (Fourth Year: 1st Six Months)**

Effective Period: 7/1/2016 - 6/30/2017  
Wage Rate Per Hour: 90% of Journeyperson's rate  
Supplemental Benefit Rate Per Hour: \$38.93  
Effective 1/1/2017 - Supplemental Benefit Rate Per Hour: \$39.51

**Boilermaker (Fourth Year: 2nd Six Months)**

Effective Period: 7/1/2016 - 6/30/2017  
Wage Rate Per Hour: 95% of Journeyperson's rate  
Supplemental Benefit Rate Per Hour: \$40.63  
Effective 1/1/2017 - Supplemental Benefit Rate Per Hour: \$41.22

(Local #5)

---

---

**BRICKLAYER**

(Ratio of Apprentice to Journeyperson: 1 to 1, 1 to 4)

**Bricklayer (First 750 Hours)**

OFFICE OF THE COMPTROLLER, CITY OF NEW YORK  
§220 APPRENTICESHIP PREVAILING WAGE SCHEDULE

Effective Period: 7/1/2016 - 6/30/2017  
Wage Rate Per Hour: 50% of Journeyperson's rate  
Supplemental Benefit Rate Per Hour: \$18.35

**Bricklayer (Second 750 Hours)**

Effective Period: 7/1/2016 - 6/30/2017  
Wage Rate Per Hour: 60% of Journeyperson's rate  
Supplemental Benefit Rate Per Hour: \$18.35

**Bricklayer (Third 750 Hours)**

Effective Period: 7/1/2016 - 6/30/2017  
Wage Rate Per Hour: 70% of Journeyperson's rate  
Supplemental Benefit Rate Per Hour: \$18.35

**Bricklayer (Fourth 750 Hours)**

Effective Period: 7/1/2016 - 6/30/2017  
Wage Rate Per Hour: 80% of Journeyperson's rate  
Supplemental Benefit Rate Per Hour: \$18.35

**Bricklayer (Fifth 750 Hours)**

Effective Period: 7/1/2016 - 6/30/2017  
Wage Rate Per Hour: 90% of Journeyperson's rate  
Supplemental Benefit Rate Per Hour: \$18.35

**Bricklayer (Sixth 750 Hours)**

Effective Period: 7/1/2016 - 6/30/2017  
Wage Rate Per Hour: 95% of Journeyperson's rate  
Supplemental Benefit Rate Per Hour: \$18.35

(Bricklayer District Council)

---

---

**CARPENTER**

(Ratio of Apprentice to Journeyperson: 1 to 1, 1 to 4)

**Carpenter (First Year)**

Effective Period: 7/1/2016 - 6/30/2017  
Wage Rate Per Hour: 40% of Journeyperson's rate  
Supplemental Benefit Rate Per Hour For Building Apprentice: \$31.34

OFFICE OF THE COMPTROLLER, CITY OF NEW YORK  
\$220 APPRENTICESHIP PREVAILING WAGE SCHEDULE

Supplemental Benefit Rate Per Hour For Heavy Apprentice: \$32.52

**Carpenter (Second Year)**

Effective Period: 7/1/2016 - 6/30/2017

Wage Rate Per Hour: 50% of Journeyman's rate

Supplemental Benefit Rate Per Hour For Building Apprentice: \$31.34

Supplemental Benefit Rate Per Hour For Heavy Apprentice: \$32.52

**Carpenter (Third Year)**

Effective Period: 7/1/2016 - 6/30/2017

Wage Rate Per Hour: 65% of Journeyman's rate

Supplemental Benefit Rate Per Hour For Building Apprentice: \$31.34

Supplemental Benefit Rate Per Hour For Heavy Apprentice: \$32.52

**Carpenter (Fourth Year)**

Effective Period: 7/1/2016 - 6/30/2017

Wage Rate Per Hour: 80% of Journeyman's rate

Supplemental Benefit Rate Per Hour For Building Apprentice: \$31.34

Supplemental Benefit Rate Per Hour For Heavy Apprentice: \$32.52

(Carpenters District Council)

---

---

**CEMENT MASON**

**(Ratio of Apprentice to Journeyman: 1 to 1, 1 to 4)**

**Cement Mason (First Year)**

Effective Period: 7/1/2016 - 6/30/2017

Wage and Supplemental Rate Per Hour: 50% of Journeyman's Rate

**Cement Mason (Second Year)**

Effective Period: 7/1/2016 - 6/30/2017

Wage and Supplemental Rate Per Hour: 60% of Journeyman's Rate

**Cement Mason (Third Year)**

Effective Period: 7/1/2016 - 6/30/2017

Wage and Supplemental Rate Per Hour: 70% of Journeyman's Rate

(Local #780)



**CEMENT AND CONCRETE WORKER**  
**(Ratio of Apprentice to Journeyman: 1 to 1, 1 to 3)**

**Cement & Concrete Worker (First 1333 hours)**

Effective Period: 7/1/2016 - 6/30/2017  
Wage Rate Per Hour: 50% of Journeyman's rate  
Supplemental Benefit Rate Per Hour: \$16.25

**Cement & Concrete Worker (Second 1333 hours)**

Effective Period: 7/1/2016 - 6/30/2017  
Wage Rate Per Hour: 65% of Journeyman's rate  
Supplemental Benefit Rate Per Hour: \$21.08

**Cement & Concrete Worker (Last 1334 hours)**

Effective Period: 7/1/2016 - 6/30/2017  
Wage Rate Per Hour: 80% of Journeyman's rate  
Supplemental Benefit Rate Per Hour: \$21.90

**Cement & Concrete Worker (Hired after 2/6/2016 - First 1334 hours)**

Effective Period: 7/1/2016 - 6/30/2017  
Wage Rate Per Hour: \$17.00  
Supplemental Benefit Rate Per Hour: \$10.75

**Cement & Concrete Worker (Hired after 2/6/2016 - Second 1334 hours)**

Effective Period: 7/1/2016 - 6/30/2017  
Wage Rate Per Hour: \$22.10  
Supplemental Benefit Rate Per Hour: \$15.13

**Cement & Concrete Worker (Hired after 2/6/2016 - Last 1334 hours)**

Effective Period: 7/1/2016 - 6/30/2017  
Wage Rate Per Hour: \$27.20  
Supplemental Benefit Rate Per Hour: \$15.63

(Cement Concrete Workers District Council)

---

---

OFFICE OF THE COMPTROLLER, CITY OF NEW YORK  
§220 APPRENTICESHIP PREVAILING WAGE SCHEDULE

**DERRICKPERSON & RIGGER (STONE)**  
(Ratio of Apprentice to Journeyman: 1 to 1, 1 to 4)

**Derrickperson & Rigger (stone) - First Year**

Effective Period: 7/1/2016 - 6/30/2017  
Wage Rate Per Hour: 50% of Journeyman's rate  
Supplemental Benefit Rate Per Hour: 50% of Journeyman's rate

**Derrickperson & Rigger (stone) - Second Year: 1st Six Months**

Effective Period: 7/1/2016 - 6/30/2017  
Wage Rate Per Hour: 70% of Journeyman's rate  
Supplemental Benefit Rate Per Hour: 75% of Journeyman's rate

**Derrickperson & Rigger (stone) - Second Year: 2nd Six Months**

Effective Period: 7/1/2016 - 6/30/2017  
Wage Rate Per Hour: 80% of Journeyman's rate  
Supplemental Benefit Rate Per Hour: 75% of Journeyman's rate

**Derrickperson & Rigger (stone) - Third Year**

Effective Period: 7/1/2016 - 6/30/2017  
Wage Rate Per Hour: 90% of Journeyman's rate  
Supplemental Benefit Rate Per Hour: 75% of Journeyman's rate

(Local #197)

---

---

**DOCKBUILDER/PILE DRIVER**  
(Ratio of Apprentice to Journeyman: 1 to 1, 1 to 6)

**Dockbuilder/Pile Driver (First Year)**

Effective Period: 7/1/2016 - 6/30/2017  
Wage Rate Per Hour: 40% of Journeyman's rate  
Supplemental Benefit Rate Per Hour: \$32.52

**Dockbuilder/Pile Driver (Second Year)**

Effective Period: 7/1/2016 - 6/30/2017  
Wage Rate Per Hour: 50% of Journeyman's rate

OFFICE OF THE COMPTROLLER, CITY OF NEW YORK  
\$220 APPRENTICESHIP PREVAILING WAGE SCHEDULE

Supplemental Benefit Rate Per Hour: \$32.52

**Dockbuilder/Pile Driver (Third Year)**

Effective Period: 7/1/2016 - 6/30/2017

Wage Rate Per Hour: 65% of Journeyperson's rate

Supplemental Benefit Rate Per Hour: \$32.52

**Dockbuilder/Pile Driver (Fourth Year)**

Effective Period: 7/1/2016 - 6/30/2017

Wage Rate Per Hour: 80% of Journeyperson's rate

Supplemental Benefit Rate Per Hour: \$32.52

(Carpenters District Council)

---

---

**ELECTRICIAN**

(Ratio of Apprentice to Journeyperson: 1 to 1, 1 to 3)

**Electrician (First Term: 0-6 Months)**

Effective Period: 7/1/2016 - 5/10/2017

Wage Rate per Hour: \$13.50

Supplemental Benefit Rate per Hour: \$12.12

Overtime Supplemental Rate Per Hour: \$13.01

Effective Period: 5/11/2017 - 6/30/2017

Wage Rate per Hour: \$14.00

Supplemental Benefit Rate per Hour: \$12.37

Overtime Supplemental Rate Per Hour: \$13.29

**Electrician (First Term: 7-12 Months)**

Effective Period: 7/1/2016 - 5/10/2017

Wage Rate per Hour: \$14.50

Supplemental Benefit Rate per Hour: \$12.63

Overtime Supplemental Rate Per Hour: \$13.58

Effective Period: 5/11/2017 - 6/30/2017

Wage Rate per Hour: \$15.00

Supplemental Benefit Rate per Hour: \$12.88

Overtime Supplemental Rate Per Hour: \$13.87

**Electrician (Second Term: 0-6 Months)**

OFFICE OF THE COMPTROLLER, CITY OF NEW YORK  
§220 APPRENTICESHIP PREVAILING WAGE SCHEDULE

Effective Period: 7/1/2016 - 5/10/2017  
Wage Rate per Hour: **\$15.50**  
Supplemental Benefit Rate per Hour: **\$13.14**  
Overtime Supplemental Rate Per Hour: **\$14.16**

Effective Period: 5/11/2017 - 6/30/2017  
Wage Rate per Hour: **\$16.00**  
Supplemental Benefit Rate per Hour: **\$13.39**  
Overtime Supplemental Rate Per Hour: **\$14.44**

**Electrician (Second Term: 7-12 Months)**

Effective Period: 7/1/2016 - 5/10/2017  
Wage Rate per Hour: **\$16.50**  
Supplemental Benefit Rate per Hour: **\$13.64**  
Overtime Supplemental Rate Per Hour: **\$14.73**

Effective Period: 5/11/2017 - 6/30/2017  
Wage Rate per Hour: **\$17.00**  
Supplemental Benefit Rate per Hour: **\$13.90**  
Overtime Supplemental Rate Per Hour: **\$15.02**

**Electrician (Third Term: 0-6 Months)**

Effective Period: 7/1/2016 - 5/10/2017  
Wage Rate per Hour: **\$17.50**  
Supplemental Benefit Rate per Hour: **\$14.15**  
Overtime Supplemental Rate Per Hour: **\$15.31**

Effective Period: 5/11/2017 - 6/30/2017  
Wage Rate per Hour: **\$18.00**  
Supplemental Benefit Rate per Hour: **\$14.41**  
Overtime Supplemental Rate Per Hour: **\$15.59**

**Electrician (Third Term: 7-12 Months)**

Effective Period: 7/1/2016 - 5/10/2017  
Wage Rate per Hour: **\$18.50**  
Supplemental Benefit Rate per Hour: **\$14.66**  
Overtime Supplemental Rate Per Hour: **\$15.88**

Effective Period: 5/11/2017 - 6/30/2017  
Wage Rate per Hour: **\$19.00**  
Supplemental Benefit Rate per Hour: **\$14.92**  
Overtime Supplemental Rate Per Hour: **\$16.17**

**Electrician (Fourth Term: 0-6 Months)**

Effective Period: 7/1/2016 - 5/10/2017

OFFICE OF THE COMPTROLLER, CITY OF NEW YORK  
§220 APPRENTICESHIP PREVAILING WAGE SCHEDULE

Wage Rate per Hour: \$19.50  
Supplemental Benefit Rate per Hour: \$15.17  
Overtime Supplemental Rate Per Hour: \$16.45

Effective Period: 5/11/2017 - 6/30/2017  
Wage Rate per Hour: \$20.00  
Supplemental Benefit Rate per Hour: \$15.43  
Overtime Supplemental Rate Per Hour: \$16.75

**Electrician (Fourth Term: 7-12 Months)**

Effective Period: 7/1/2016 - 5/10/2017  
Wage Rate per Hour: \$21.50  
Supplemental Benefit Rate per Hour: \$16.19  
Overtime Supplemental Rate Per Hour: \$17.60

Effective Period: 5/11/2017 - 6/30/2017  
Wage Rate per Hour: \$22.00  
Supplemental Benefit Rate per Hour: \$16.44  
Overtime Supplemental Rate Per Hour: \$17.89

**Electrician (Fifth Term: 0-12 Months)**

Effective Period: 7/1/2016 - 5/10/2017  
Wage Rate per Hour: \$23.50  
Supplemental Benefit Rate per Hour: \$19.54  
Overtime Supplemental Rate Per Hour: \$21.01

Effective Period: 5/11/2017 - 6/30/2017  
Wage Rate per Hour: \$24.00  
Supplemental Benefit Rate per Hour: \$19.80  
Overtime Supplemental Rate Per Hour: \$21.30

**Electrician (Fifth Term: 13-18 Months)**

Effective Period: 7/1/2016 - 5/10/2017  
Wage Rate per Hour: \$28.00  
Supplemental Benefit Rate per Hour: \$21.85  
Overtime Supplemental Rate Per Hour: \$23.60

Effective Period: 5/11/2017 - 6/30/2017  
Wage Rate per Hour: \$28.50  
Supplemental Benefit Rate per Hour: \$22.10  
Overtime Supplemental Rate Per Hour: \$23.89

**Overtime Description**

Overtime Wage paid at time and one half the regular rate

(Local #3)

OFFICE OF THE COMPTROLLER, CITY OF NEW YORK  
§220 APPRENTICESHIP PREVAILING WAGE SCHEDULE

---

---

**ELEVATOR CONSTRUCTOR**  
(Ratio of Apprentice to Journeyman: 1 to 1, 1 to 2)

**Elevator (Constructor) - First Year**

Effective Period: 7/1/2016 - 3/16/2017  
Wage Rate Per Hour: 50% of Journeyman's rate  
Supplemental Rate Per Hour: \$28.24

Effective Period: 3/17/2017 - 6/30/2017  
Wage Rate Per Hour: 50% of Journeyman's rate  
Supplemental Rate Per Hour: \$29.72

**Elevator (Constructor) - Second Year**

Effective Period: 7/1/2016 - 3/16/2017  
Wage Rate Per Hour: 55% of Journeyman's rate  
Supplemental Rate Per Hour: \$28.67

Effective Period: 3/17/2017 - 6/30/2017  
Wage Rate Per Hour: 55% of Journeyman's rate  
Supplemental Rate Per Hour: \$30.15

**Elevator (Constructor) - Third Year**

Effective Period: 7/1/2016 - 3/16/2017  
Wage Rate Per Hour: 65% of Journeyman's rate  
Supplemental Rate Per Hour: \$29.52

Effective Period: 3/17/2017 - 6/30/2017  
Wage Rate Per Hour: 65% of Journeyman's rate  
Supplemental Rate Per Hour: \$31.03

**Elevator (Constructor) - Fourth Year**

Effective Period: 7/1/2016 - 3/16/2017  
Wage Rate Per Hour: 75% of Journeyman's rate  
Supplemental Rate Per Hour: \$30.37

Effective Period: 3/17/2017 - 6/30/2017  
Wage Rate Per Hour: 75% of Journeyman's rate  
Supplemental Rate Per Hour: \$31.91

(Local #1)

**ELEVATOR REPAIR & MAINTENANCE**  
**(Ratio of Apprentice to Journeyman: 1 to 1, 1 to 2)**

**Elevator Service/Modernization Mechanic (First Year)**

Effective Period: 7/1/2016 - 3/16/2017  
Wage Rate Per Hour: 50% of Journeyman's rate  
Supplemental Benefit Per Hour: \$28.33

Effective Period: 3/17/2017 - 6/30/2017  
Wage Rate Per Hour: 50% of Journeyman's rate  
Supplemental Benefit Per Hour: \$29.80

**Elevator Service/Modernization Mechanic (Second Year)**

Effective Period: 7/1/2016 - 3/16/2017  
Wage Rate Per Hour: 55% of Journeyman's rate  
Supplemental Benefit Per Hour: \$28.74

Effective Period: 3/17/2017 - 6/30/2017  
Wage Rate Per Hour: 55% of Journeyman's rate  
Supplemental Benefit Per Hour: \$30.23

**Elevator Service/Modernization Mechanic (Third Year)**

Effective Period: 7/1/2016 - 3/16/2017  
Wage Rate Per Hour: 65% of Journeyman's rate  
Supplemental Benefit Per Hour: \$29.58

Effective Period: 3/17/2017 - 6/30/2017  
Wage Rate Per Hour: 65% of Journeyman's rate  
Supplemental Benefit Per Hour: \$31.09

**Elevator Service/Modernization Mechanic (Fourth Year)**

Effective Period: 7/1/2016 - 3/16/2017  
Wage Rate Per Hour: 75% of Journeyman's rate  
Supplemental Benefit Per Hour: \$30.42

Effective Period: 3/17/2017 - 6/30/2017  
Wage Rate Per Hour: 75% of Journeyman's rate  
Supplemental Benefit Per Hour: \$31.95

(Local #1)

---

OFFICE OF THE COMPTROLLER, CITY OF NEW YORK  
§220 APPRENTICESHIP PREVAILING WAGE SCHEDULE

---

**ENGINEER**

(Ratio of Apprentice to Journeyman: 1 to 1, 1 to 5)

**Engineer - First Year**

Effective Period: 7/1/2016 - 6/30/2017

Wage Rate per Hour: \$24.28

Supplemental Benefit Rate per Hour: \$23.41

**Engineer - Second Year**

Effective Period: 7/1/2016 - 6/30/2017

Wage Rate per Hour: \$30.35

Supplemental Benefit Rate per Hour: \$23.41

**Engineer - Third Year**

Effective Period: 7/1/2016 - 6/30/2017

Wage Rate per Hour: \$33.38

Supplemental Benefit Rate per Hour: \$23.41

**Engineer - Fourth Year**

Effective Period: 7/1/2016 - 6/30/2017

Wage Rate per Hour: \$36.41

Supplemental Benefit Rate per Hour: \$23.41

(Local #15)

---

**ENGINEER - OPERATING**

(Ratio of Apprentice to Journeyman: 1 to 1, 1 to 5)

**Operating Engineer - First Year**

Effective Period: 7/1/2016 - 6/30/2017

Wage Rate Per Hour 40% of Journeyman's Rate

Supplemental Benefit Per Hour: \$20.85

**Operating Engineer - Second Year**



OFFICE OF THE COMPTROLLER, CITY OF NEW YORK  
§220 APPRENTICESHIP PREVAILING WAGE SCHEDULE

Effective Period: 7/1/2016 - 6/30/2017  
Wage Rate Per Hour: 50% of Journeyperson's Rate  
Supplemental Benefit Per Hour: \$20.85

**Operating Engineer - Third Year**

Effective Period: 7/1/2016 - 6/30/2017  
Wage Rate Per Hour: 60% of Journeyperson's Rate  
Supplemental Benefit Per Hour: \$20.85

(Local #14)

---

---

**FLOOR COVERER**  
(Ratio of Apprentice to Journeyperson: 1 to 1, 1 to 4)

**Floor Coverer (First Year)**

Effective Period: 7/1/2016 - 6/30/2017  
Wage Rate Per Hour: 40% of Journeyperson's rate  
Supplemental Rate Per Hour: \$31.14

**Floor Coverer (Second Year)**

Effective Period: 7/1/2016 - 6/30/2017  
Wage Rate Per Hour: 50% of Journeyperson's rate  
Supplemental Rate Per Hour: \$31.14

**Floor Coverer (Third Year)**

Effective Period: 7/1/2016 - 6/30/2017  
Wage Rate Per Hour: 65% of Journeyperson's rate  
Supplemental Rate Per Hour: \$31.14

**Floor Coverer (Fourth Year)**

Effective Period: 7/1/2016 - 6/30/2017  
Wage Rate Per Hour: 80% of Journeyperson's rate  
Supplemental Rate Per Hour: \$31.14

(Carpenters District Council)

---

---

OFFICE OF THE COMPTROLLER, CITY OF NEW YORK  
\$220 APPRENTICESHIP PREVAILING WAGE SCHEDULE

**GLAZIER**

(Ratio of Apprentice to Journeyman: 1 to 1, 1 to 3)

**Glazier (First Year)**

Effective Period: 7/1/2016 - 6/30/2017  
Wage Rate Per Hour: 40% of Journeyman's rate  
Supplemental Rate Per Hour: \$14.14

**Glazier (Second Year)**

Effective Period: 7/1/2016 - 6/30/2017  
Wage Rate Per Hour: 50% of Journeyman's rate  
Supplemental Rate Per Hour: \$23.77

**Glazier (Third Year)**

Effective Period: 7/1/2016 - 6/30/2017  
Wage Rate Per Hour: 60% of Journeyman's rate  
Supplemental Rate Per Hour: \$26.73

**Glazier (Fourth Year)**

Effective Period: 7/1/2016 - 6/30/2017  
Wage Rate Per Hour: 80% of Journeyman's rate  
Supplemental Rate Per Hour: \$32.14

(Local #1281)

---

---

**HEAT & FROST INSULATOR**

(Ratio of Apprentice to Journeyman: 1 to 1, 1 to 4)

**Heat & Frost Insulator (First Year)**

Effective Period: 7/1/2016 - 6/30/2017  
Wage and Supplemental Rate Per Hour: 40% of Journeyman's rate

**Heat & Frost Insulator (Second Year)**

Effective Period: 7/1/2016 - 6/30/2017  
Wage and Supplemental Rate Per Hour: 60% of Journeyman's rate

OFFICE OF THE COMPTROLLER, CITY OF NEW YORK  
§220 APPRENTICESHIP PREVAILING WAGE SCHEDULE

**Heat & Frost Insulator (Third Year)**

Effective Period: 7/1/2016 - 6/30/2017

Wage and Supplemental Rate Per Hour: 70% of Journeyman's rate

**Heat & Frost Insulator (Fourth Year)**

Effective Period: 7/1/2016 - 6/30/2017

Wage and Supplemental Rate Per Hour: 80% of Journeyman's rate

(Local #12)

---

**HOUSE WRECKER  
(TOTAL DEMOLITION)**

**(Ratio of Apprentice to Journeyman: 1 to 1, 1 to 3)**

**House Wrecker - First Year**

Effective Period: 7/1/2016 - 6/30/2017

Wage Rate per Hour: \$21.17

Supplemental Benefit Rate per Hour: \$17.99

**House Wrecker - Second Year**

Effective Period: 7/1/2016 - 6/30/2017

Wage Rate per Hour: \$22.32

Supplemental Benefit Rate per Hour: \$17.99

**House Wrecker - Third Year**

Effective Period: 7/1/2016 - 6/30/2017

Wage Rate per Hour: \$23.97

Supplemental Benefit Rate per Hour: \$17.99

**House Wrecker - Fourth Year**

Effective Period: 7/1/2016 - 6/30/2017

Wage Rate per Hour: \$26.53

Supplemental Benefit Rate per Hour: \$17.99

(Mason Tenders District Council)

---

OFFICE OF THE COMPTROLLER, CITY OF NEW YORK  
§220 APPRENTICESHIP PREVAILING WAGE SCHEDULE

---

**IRON WORKER - ORNAMENTAL**

(Ratio of Apprentice to Journeyman: 1 to 1, 1 to 4)

**Iron Worker (Ornamental) - 1st Ten Months**

Effective Period: 7/1/2016 - 6/30/2017  
Wage Rate Per Hour: 50% of Journeyman's rate  
Supplemental Rate Per Hour: \$37.90

**Iron Worker (Ornamental) - 11 -16 Months**

Effective Period: 7/1/2016 - 6/30/2017  
Wage Rate Per Hour: 55% of Journeyman's rate  
Supplemental Rate Per Hour: \$39.06

**Iron Worker (Ornamental) - 17 - 22 Months**

Effective Period: 7/1/2016 - 6/30/2017  
Wage Rate Per Hour: 60% of Journeyman's rate  
Supplemental Rate Per Hour: \$40.23

**Iron Worker (Ornamental) - 23 - 28 Months**

Effective Period: 7/1/2016 - 6/30/2017  
Wage Rate Per Hour: 70% of Journeyman's rate  
Supplemental Rate Per Hour: \$42.57

**Iron Worker (Ornamental) - 29 - 36 Months**

Effective Period: 7/1/2016 - 6/30/2017  
Wage Rate Per Hour: 80% of Journeyman's rate  
Supplemental Rate Per Hour: \$44.90

(Local #580)

---

**IRON WORKER - STRUCTURAL**

(Ratio of Apprentice to Journeyman: 1 to 1, 1 to 6)

**Iron Worker (Structural) - 1st Six Months**

OFFICE OF THE COMPTROLLER, CITY OF NEW YORK  
\$220 APPRENTICESHIP PREVAILING WAGE SCHEDULE

Effective Period: 7/1/2016 - 6/30/2017  
Wage Rate per Hour: \$25.85  
Supplemental Benefit Rate per Hour: \$48.35

**Iron Worker (Structural) - 7- 18 Months**

Effective Period: 7/1/2016 - 6/30/2017  
Wage Rate per Hour: \$26.45  
Supplemental Benefit Rate per Hour: \$48.35

**Iron Worker (Structural) - 19 - 36 months**

Effective Period: 7/1/2016 - 6/30/2017  
Wage Rate per Hour: \$27.05  
Supplemental Benefit Rate per Hour: \$48.35

(Local #40 and #361)

---

**LABORER (FOUNDATION, CONCRETE, EXCAVATING, STREET PIPE  
LAYER & COMMON)  
(Ratio Apprentice to Journeyman: 1 to 1, 1 to 3)**

**Laborer (Foundation, Concrete, Excavating, Street Pipe Layer & Common) - First  
1000 hours**

Effective Period: 7/1/2016 - 6/30/2017  
Wage Rate Per Hour: 50% of Journeyman's rate  
Supplemental Rate Per Hour: \$38.63

**Laborer (Foundation, Concrete, Excavating, Street Pipe Layer & Common) -  
Second 1000 hours**

Effective Period: 7/1/2016 - 6/30/2017  
Wage Rate Per Hour: 60% of Journeyman's rate  
Supplemental Rate Per Hour: \$38.63

**Laborer (Foundation, Concrete, Excavating, Street Pipe Layer & Common) -  
Third 1000 hours**

Effective Period: 7/1/2016 - 6/30/2017  
Wage Rate Per Hour: 75% of Journeyman's rate  
Supplemental Rate Per Hour: \$38.63

OFFICE OF THE COMPTROLLER, CITY OF NEW YORK  
§220 APPRENTICESHIP PREVAILING WAGE SCHEDULE

**Laborer (Foundation, Concrete, Excavating, Street Pipe Layer & Common) -  
Fourth 1000 hours**

Effective Period: 7/1/2016 - 6/30/2017  
Wage Rate Per Hour: 90% of Journeyman's rate  
Supplemental Rate Per Hour: \$38.63

(Local #731)

---

---

**MARBLE MECHANICS  
(Ratio of Apprentice to Journeyman: 1 to 1, 1 to 4)**

**Cutters & Setters - First 750 Hours**

Effective Period: 7/1/2016 - 6/30/2017  
Wage and Supplemental Rate Per Hour: 50% of Journeyman's rate

NO BENEFITS PAID DURING THE FIRST TWO MONTHS (PROBATIONARY PERIOD)

**Cutters & Setters - Second 750 Hours**

Effective Period: 7/1/2016 - 6/30/2017  
Wage and Supplemental Rate Per Hour: 55% of Journeyman's rate

**Cutters & Setters - Third 750 Hours**

Effective Period: 7/1/2016 - 6/30/2017  
Wage and Supplemental Rate Per Hour: 65% of Journeyman's rate

**Cutters & Setters - Fourth 750 Hours**

Effective Period: 7/1/2016 - 6/30/2017  
Wage and Supplemental Rate Per Hour: 75% of Journeyman's rate

**Cutters & Setters - Fifth 750 Hours**

Effective Period: 7/1/2016 - 6/30/2017  
Wage and Supplemental Rate Per Hour: 85% of Journeyman's rate

**Cutters & Setters - Sixth 750 Hours**

Effective Period: 7/1/2016 - 6/30/2017  
Wage and Supplemental Rate Per Hour: 95% of Journeyman's rate

OFFICE OF THE COMPTROLLER, CITY OF NEW YORK  
§220 APPRENTICESHIP PREVAILING WAGE SCHEDULE

**Polishers & Finishers - First 750 Hours**

Effective Period: 7/1/2016 - 6/30/2017

Wage and Supplemental Rate Per Hour: 50% of Journeyperson's rate

NO BENEFITS PAID DURING THE FIRST TWO MONTHS (PROBATIONARY PERIOD)

**Polishers & Finishers - Second 750 Hours**

Effective Period: 7/1/2016 - 6/30/2017

Wage and Supplemental Rate Per Hour: 60% of Journeyperson's rate

**Polishers & Finishers - Third 750 Hours**

Effective Period: 7/1/2016 - 6/30/2017

Wage and Supplemental Rate Per Hour: 75% of Journeyperson's rate

**Polishers & Finishers - Fourth 750 Hours**

Effective Period: 7/1/2016 - 6/30/2017

Wage and Supplemental Rate Per Hour: 90% of Journeyperson's rate

(Local #7)

---

---

**MASON TENDER**

(Ratio of Apprentice to Journeyperson: 1 to 1, 1 to 3)

**Mason Tender - First Year**

Effective Period: 7/1/2016 - 6/30/2017

Wage Rate per Hour: \$21.39

Supplemental Benefit Rate per Hour: \$19.10

**Mason Tender - Second Year**

Effective Period: 7/1/2016 - 6/30/2017

Wage Rate per Hour: \$22.54

Supplemental Benefit Rate per Hour: \$19.10

**Mason Tender - Third Year**

Effective Period: 7/1/2016 - 6/30/2017

Wage Rate per Hour: \$24.29

Supplemental Benefit Rate per Hour: \$19.15

OFFICE OF THE COMPTROLLER, CITY OF NEW YORK  
§220 APPRENTICESHIP PREVAILING WAGE SCHEDULE

**Mason Tender - Fourth Year**

Effective Period: 7/1/2016 - 6/30/2017

Wage Rate per Hour: **\$26.95**

Supplemental Benefit Rate per Hour: **\$19.15**

(Local #79)

---

---

**METALLIC LATHER**

(Ratio of Apprentice to Journeyman: 1 to 1, 1 to 3)

**Metallic Lather (First Year)**

Effective Period: 7/1/2016 - 6/30/2017

Wage Rate per Hour: **\$23.01**

Supplemental Benefit Rate per Hour: **\$17.95**

**Metallic Lather (Second Year)**

Effective Period: 7/1/2016 - 6/30/2017

Wage Rate per Hour: **\$28.11**

Supplemental Benefit Rate per Hour: **\$17.95**

**Metallic Lather (Third Year)**

Effective Period: 7/1/2016 - 6/30/2017

Wage Rate per Hour: **\$33.21**

Supplemental Benefit Rate per Hour: **\$17.95**

(Local #46)

---

---

**MILLWRIGHT**

(Ratio of Apprentice to Journeyman: 1 to 1, 1 to 4)

**Millwright (First Year)**



OFFICE OF THE COMPTROLLER, CITY OF NEW YORK  
\$220 APPRENTICESHIP PREVAILING WAGE SCHEDULE

Effective Period: 7/1/2016 - 6/30/2017  
Wage Rate per Hour: **\$28.33**  
Supplemental Benefit Rate per Hour: **\$34.28**

**Millwright (Second Year)**

Effective Period: 7/1/2016 - 6/30/2017  
Wage Rate per Hour: **\$33.48**  
Supplemental Benefit Rate per Hour: **\$37.88**

**Millwright (Third Year)**

Effective Period: 7/1/2016 - 6/30/2017  
Wage Rate per Hour: **\$38.63**  
Supplemental Benefit Rate per Hour: **\$42.13**

**Millwright (Fourth Year)**

Effective Period: 7/1/2016 - 6/30/2017  
Wage Rate per Hour: **\$48.93**  
Supplemental Benefit Rate per Hour: **\$48.69**

(Local #740)

---

**PAVER AND ROADBUILDER**  
(Ratio of Apprentice to Journeyperson: 1 to 1, 1 to 3)

**Paver and Roadbuilder - First Year (Minimum 1000 hours)**

Effective Period: 7/1/2016 - 6/30/2017  
Wage Rate per Hour: **\$27.55**  
Supplemental Benefit Rate per Hour: **\$18.20**

**Paver and Roadbuilder - Second Year (Minimum 1000 hours)**

Effective Period: 7/1/2016 - 6/30/2017  
Wage Rate per Hour: **\$29.19**  
Supplemental Benefit Rate per Hour: **\$18.20**

(Local #1010)

---

## **PAINTER**

**(Ratio of Apprentice to Journeyman: 1 to 1, 1 to 3)**

### **Painter - Brush & Roller - First Year**

Effective Period: 7/1/2016 - 4/30/2017

Wage Rate per Hour: **\$17.00**

Supplemental Benefit Rate per Hour: **\$12.38**

Effective Period: 5/1/2017 - 6/30/2017

Wage Rate per Hour: **\$17.64**

Supplemental Benefit Rate per Hour: **\$12.78**

### **Painter - Brush & Roller - Second Year**

Effective Period: 7/1/2016 - 4/30/2017

Wage Rate per Hour: **\$21.25**

Supplemental Benefit Rate per Hour: **\$16.23**

Effective Period: 5/1/2017 - 6/30/2017

Wage Rate per Hour: **\$22.05**

Supplemental Benefit Rate per Hour: **\$16.63**

### **Painter - Brush & Roller - Third Year**

Effective Period: 7/1/2016 - 4/30/2017

Wage Rate per Hour: **\$25.50**

Supplemental Benefit Rate per Hour: **\$19.14**

Effective Period: 5/1/2017 - 6/30/2017

Wage Rate per Hour: **\$26.46**

Supplemental Benefit Rate per Hour: **\$19.54**

### **Painter - Brush & Roller - Fourth Year**

Effective Period: 7/1/2016 - 4/30/2017

Wage Rate per Hour: **\$34.00**

Supplemental Benefit Rate per Hour: **\$24.52**

Effective Period: 5/1/2017 - 6/30/2017

Wage Rate per Hour: **\$35.28**

Supplemental Benefit Rate per Hour: **\$24.92**

(District Council of Painters)

**PAINTER - METAL POLISHER**

(Ratio of Apprentice to Journeyman: 1 to 1, 1 to 3)

**Metal Polisher (First Year)**

Effective Period: 7/1/2016 - 6/30/2017

Wage Rate per Hour: \$11.75

Supplemental Benefit Rate per Hour: \$5.13

**Metal Polisher (Second Year)**

Effective Period: 7/1/2016 - 6/30/2017

Wage Rate per Hour: \$13.00

Supplemental Benefit Rate per Hour: \$5.13

**Metal Polisher (Third Year)**

Effective Period: 7/1/2016 - 6/30/2017

Wage Rate per Hour: \$15.75

Supplemental Benefit Rate per Hour: \$5.13

(Local 8A-28)

---

---

**PAINTER - STRUCTURAL STEEL**

(Ratio of Apprentice to Journeyman: 1 to 1, 1 to 3)

**Painters - Structural Steel (First Year)**

Effective Period: 7/1/2016 - 6/30/2017

Wage and Supplemental Rate Per Hour: 40% of Journeyman's rate

**Painters - Structural Steel (Second Year)**

Effective Period: 7/1/2016 - 6/30/2017

Wage and Supplemental Rate Per Hour: 60% of Journeyman's rate

**Painters - Structural Steel (Third Year)**

OFFICE OF THE COMPTROLLER, CITY OF NEW YORK  
§220 APPRENTICESHIP PREVAILING WAGE SCHEDULE

Effective Period: 7/1/2016 - 6/30/2017

Wage and Supplemental Rate Per Hour: 80% of Journeyman's rate

(Local #806)

---

---

## **PLASTERER**

(Ratio of Apprentice to Journeyman: 1 to 1, 1 to 3)

### **Plasterer - First Year: 1st Six Months**

Effective Period: 7/1/2016 - 6/30/2017

Wage Rate Per Hour: 40% of Journeyman's rate

Supplemental Rate Per Hour: \$15.91

### **Plasterer - First Year: 2nd Six Months**

Effective Period: 7/1/2016 - 6/30/2017

Wage Rate Per Hour: 45% of Journeyman's rate

Supplemental Rate Per Hour: \$16.39

### **Plasterer - Second Year: 1st Six Months**

Effective Period: 7/1/2016 - 6/30/2017

Wage Rate Per Hour: 55% of Journeyman's rate

Supplemental Rate Per Hour: \$18.36

### **Plasterer - Second Year: 2nd Six Months**

Effective Period: 7/1/2016 - 6/30/2017

Wage Rate Per Hour: 60% of Journeyman's rate

Supplemental Rate Per Hour: \$19.44

### **Plasterer - Third Year: 1st Six Months**

Effective Period: 7/1/2016 - 6/30/2017

Wage Rate Per Hour: 70% of Journeyman's rate

Supplemental Rate Per Hour: \$21.61

### **Plasterer - Third Year: 2nd Six Months**

Effective Period: 7/1/2016 - 6/30/2017

Wage Rate Per Hour: 75% of Journeyman's rate

Supplemental Rate Per Hour: \$22.69

OFFICE OF THE COMPTROLLER, CITY OF NEW YORK  
\$220 APPRENTICESHIP PREVAILING WAGE SCHEDULE

(Local #530)

---

---

**PLASTERER - TENDER**

**(Ratio of Apprentice to Journeyman: 1 to 1, 1 to 3)**

**Plasterer Tender - First Year**

Effective Period: 7/1/2016 - 6/30/2017

Wage Rate per Hour: \$21.39

Supplemental Benefit Rate per Hour: \$19.10

**Plasterer Tender - Second Year**

Effective Period: 7/1/2016 - 6/30/2017

Wage Rate per Hour: \$22.54

Supplemental Benefit Rate per Hour: \$19.10

**Plasterer Tender - Third Year**

Effective Period: 7/1/2016 - 6/30/2017

Wage Rate per Hour: \$24.29

Supplemental Benefit Rate per Hour: \$19.15

**Plasterer Tender - Fourth Year**

Effective Period: 7/1/2016 - 6/30/2017

Wage Rate per Hour: \$26.95

Supplemental Benefit Rate per Hour: \$19.15

(Local #79)

---

---

**PLUMBER**

**(Ratio of Apprentice to Journeyman: 1 to 1, 1 to 3)**

**Plumber - First Year: 1st Six Months**

Effective Period: 7/1/2016 - 6/30/2017

OFFICE OF THE COMPTROLLER, CITY OF NEW YORK  
\$220 APPRENTICESHIP PREVAILING WAGE SCHEDULE

Wage Rate per Hour: \$14.00  
Supplemental Benefit Rate per Hour: \$0.71

**Plumber - First Year: 2nd Six Months**

Effective Period: 7/1/2016 - 6/30/2017  
Wage Rate per Hour: \$14.00  
Supplemental Benefit Rate per Hour: \$2.96

**Plumber - Second Year**

Effective Period: 7/1/2016 - 6/30/2017  
Wage Rate per Hour: \$24.07  
Supplemental Benefit Rate per Hour: \$13.21

**Plumber - Third Year**

Effective Period: 7/1/2016 - 6/30/2017  
Wage Rate per Hour: \$26.17  
Supplemental Benefit Rate per Hour: \$13.21

**Plumber - Fourth Year**

Effective Period: 7/1/2016 - 6/30/2017  
Wage Rate per Hour: \$29.02  
Supplemental Benefit Rate per Hour: \$13.21

**Plumber - Fifth Year: 1st Six Months**

Effective Period: 7/1/2016 - 6/30/2017  
Wage Rate per Hour: \$30.42  
Supplemental Benefit Rate per Hour: \$13.21

**Plumber - Fifth Year: 2nd Six Months**

Effective Period: 7/1/2016 - 6/30/2017  
Wage Rate per Hour: \$42.49  
Supplemental Benefit Rate per Hour: \$13.21

(Plumbers Local #1)

---

---

OFFICE OF THE COMPTROLLER, CITY OF NEW YORK  
§220 APPRENTICESHIP PREVAILING WAGE SCHEDULE

**POINTER, WATERPROOFER, CAULKER, SANDBLASTER,  
STEAMBLASTER**

(Exterior Building Renovation)

(Ratio of Apprentice to Journeyperson: 1 to 1, 1 to 4)

**Pointer, Waterproofer, Caulker, Sandblaster, Steamblaster - First Year**

Effective Period: 7/1/2016 - 6/30/2017

Wage Rate per Hour: \$26.52

Supplemental Benefit Rate per Hour: \$12.10

**Pointer, Waterproofer, Caulker, Sandblaster, Steamblaster - Second Year**

Effective Period: 7/1/2016 - 6/30/2017

Wage Rate per Hour: \$27.89

Supplemental Benefit Rate per Hour: \$16.75

**Pointer, Waterproofer, Caulker, Sandblaster, Steamblaster - Third Year**

Effective Period: 7/1/2016 - 6/30/2017

Wage Rate per Hour: \$33.98

Supplemental Benefit Rate per Hour: \$19.50

**Pointer, Waterproofer, Caulker, Sandblaster, Steamblaster - Fourth Year**

Effective Period: 7/1/2016 - 6/30/2017

Wage Rate per Hour: \$40.80

Supplemental Benefit Rate per Hour: \$20.35

(Bricklayer District Council)

---

---

**ROOFER**

(Ratio of Apprentice to Journeyperson: 1 to 1, 1 to 2)

**Roofers - First Year**

Effective Period: 7/1/2016 - 6/30/2017

Wage and Supplemental Rate Per Hour: 35% of Journeyperson's Rate

**Roofers - Second Year**

OFFICE OF THE COMPTROLLER, CITY OF NEW YORK  
\$220 APPRENTICESHIP PREVAILING WAGE SCHEDULE

Effective Period: 7/1/2016 - 6/30/2017

Wage and Supplemental Rate Per Hour: 50% of Journeyman's Rate

**Roofer - Third Year**

Effective Period: 7/1/2016 - 6/30/2017

Wage and Supplemental Rate Per Hour: 60% of Journeyman's Rate

**Roofer - Fourth Year**

Effective Period: 7/1/2016 - 6/30/2017

Wage and Supplemental Rate Per Hour: 75% of Journeyman's Rate

(Local #8)

---

---

**SHEET METAL WORKER**

(Ratio of Apprentice to Journeyman: 1 to 1, 1 to 3)

**Sheet Metal Worker (0-6 Months)**

Effective Period: 7/1/2016 - 6/30/2017

Wage Rate Per Hour: 25% of Journeyman's rate

Supplemental Rate Per Hour: \$6.35

**Sheet Metal Worker (7-18 Months)**

Effective Period: 7/1/2016 - 6/30/2017

Wage Rate Per Hour: 35% of Journeyman's rate

Supplemental Rate Per Hour: \$17.12

**Sheet Metal Worker (19-30 Months)**

Effective Period: 7/1/2016 - 6/30/2017

Wage Rate Per Hour: 45% of Journeyman's rate

Supplemental Rate Per Hour: \$23.54

**Sheet Metal Worker (31-36 Months)**

Effective Period: 7/1/2016 - 6/30/2017

Wage Rate Per Hour: 55% of Journeyman's rate

Supplemental Rate Per Hour: \$27.70

**Sheet Metal Worker (37-42 Months)**

Effective Period: 7/1/2016 - 6/30/2017



OFFICE OF THE COMPTROLLER, CITY OF NEW YORK  
§220 APPRENTICESHIP PREVAILING WAGE SCHEDULE

Wage Rate Per Hour: 60% of Journeyperson's rate  
Supplemental Rate Per Hour: \$29.11

**Sheet Metal Worker (43-48 Months)**

Effective Period: 7/1/2016 - 6/30/2017  
Wage Rate Per Hour: 70% of Journeyperson's rate  
Supplemental Rate Per Hour: \$33.96

**Sheet Metal Worker (49-54 Months)**

Effective Period: 7/1/2016 - 6/30/2017  
Wage Rate Per Hour: 75% of Journeyperson's rate  
Supplemental Rate Per Hour: \$36.07

**Sheet Metal Worker (55-60 Months)**

Effective Period: 7/1/2016 - 6/30/2017  
Wage Rate Per Hour: 80% of Journeyperson's rate  
Supplemental Rate Per Hour: \$38.15

(Local #28)

---

---

**SIGN ERECTOR**

(Ratio of Apprentice to Journeyperson: 1 to 1, 1 to 4)

**Sign Erector - First Year: 1st Six Months**

Effective Period: 7/1/2016 - 6/30/2017  
Wage Rate Per Hour: 35% of Journeyperson's rate  
Supplemental Rate Per Hour: \$13.95

**Sign Erector - First Year: 2nd Six Months**

Effective Period: 7/1/2016 - 6/30/2017  
Wage Rate Per Hour: 40% of Journeyperson's rate  
Supplemental Rate Per Hour: \$15.83

**Sign Erector - Second Year: 1st Six Months**

Effective Period: 7/1/2016 - 6/30/2017  
Wage Rate Per Hour: 45% of Journeyperson's rate  
Supplemental Rate Per Hour: \$17.72

**Sign Erector - Second Year: 2nd Six Months**

OFFICE OF THE COMPTROLLER, CITY OF NEW YORK  
§220 APPRENTICESHIP PREVAILING WAGE SCHEDULE

Effective Period: 7/1/2016 - 6/30/2017  
Wage Rate Per Hour: 50% of Journeyman's rate  
Supplemental Rate Per Hour: \$19.60

**Sign Erector - Third Year: 1st Six Months**

Effective Period: 7/1/2016 - 6/30/2017  
Wage Rate Per Hour: 55% of Journeyman's rate  
Supplemental Rate Per Hour: \$26.23

**Sign Erector - Third Year: 2nd Six Months**

Effective Period: 7/1/2016 - 6/30/2017  
Wage Rate Per Hour: 60% of Journeyman's rate  
Supplemental Rate Per Hour: \$28.24

**Sign Erector - Fourth Year: 1st Six Months**

Effective Period: 7/1/2016 - 6/30/2017  
Wage Rate Per Hour: 65% of Journeyman's rate  
Supplemental Rate Per Hour: \$30.98

**Sign Erector - Fourth Year: 2nd Six Months**

Effective Period: 7/1/2016 - 6/30/2017  
Wage Rate Per Hour: 70% of Journeyman's rate  
Supplemental Rate Per Hour: \$33.06

**Sign Erector - Fifth Year**

Effective Period: 7/1/2016 - 6/30/2017  
Wage Rate Per Hour: 75% of Journeyman's rate  
Supplemental Rate Per Hour: \$35.15

**Sign Erector - Sixth Year**

Effective Period: 7/1/2016 - 6/30/2017  
Wage Rate Per Hour: 80% of Journeyman's rate  
Supplemental Rate Per Hour: \$37.22

(Local #137)

---

---

**STEAMFITTER**

**(Ratio of Apprentice to Journeyman: 1 to 1, 1 to 3)**

OFFICE OF THE COMPTROLLER, CITY OF NEW YORK  
§220 APPRENTICESHIP PREVAILING WAGE SCHEDULE

**Steamfitter - First Year**

Effective Period: 7/1/2016 - 6/30/2017

Wage Rate and Supplemental Per Hour: 40% of Journeyperson's rate.

**Steamfitter - Second Year**

Effective Period: 7/1/2016 - 6/30/2017

Wage Rate and Supplemental Rate Per Hour: 50% of Journeyperson's rate.

**Steamfitter - Third Year**

Effective Period: 7/1/2016 - 6/30/2017

Wage Rate and Supplemental Rate per Hour: 65% of Journeyperson's rate.

**Steamfitter - Fourth Year**

Effective Period: 7/1/2016 - 6/30/2017

Wage Rate and Supplemental Rate Per Hour: 80% of Journeyperson's rate.

**Steamfitter - Fifth Year**

Effective Period: 7/1/2016 - 6/30/2017

Wage Rate and Supplemental Rate Per Hour: 85% of Journeyperson's rate.

(Local #638)

---

---

**STONE MASON - SETTER**

(Ratio Apprentice of Journeyperson: 1 to 1, 1 to 2)

**Stone Mason - Setters - First 750 Hours**

Effective Period: 7/1/2016 - 6/30/2017

Wage and Supplemental Rate Per Hour: 50% of Journeyperson's rate

**Stone Mason - Setters - Second 750 Hours**

Effective Period: 7/1/2016 - 6/30/2017

Wage Rate Per Hour: 60% of Journeyperson's rate

Supplemental Rate Per Hour: 50% of Journeyperson's rate

**Stone Mason - Setters - Third 750 Hours**

OFFICE OF THE COMPTROLLER, CITY OF NEW YORK  
§220 APPRENTICESHIP PREVAILING WAGE SCHEDULE

Effective Period: 7/1/2016 - 6/30/2017

Wage Rate Per Hour: 70% of Journeyman's rate

Supplemental Rate Per Hour: 50% of Journeyman's rate

**Stone Mason - Setters - Fourth 750 Hours**

Effective Period: 7/1/2016 - 6/30/2017

Wage Rate Per Hour: 80% of Journeyman's rate

Supplemental Rate Per Hour: 50% of Journeyman's rate

**Stone Mason - Setters - Fifth 750 Hours**

Effective Period: 7/1/2016 - 6/30/2017

Wage Rate Per Hour: 90% of Journeyman's rate

Supplemental Rate Per Hour: 50% of Journeyman's rate

**Stone Mason - Setters - Sixth 750 Hours**

Effective Period: 7/1/2016 - 6/30/2017

Wage Rate Per Hour: 100% of Journeyman's rate

Supplemental Rate Per Hour: 50% of Journeyman's rate

(Bricklayers District Council)

---

---

**TAPER**

(Ratio of Apprentice to Journeyman: 1 to 1, 1 to 4)

**Drywall Taper - First Year**

Effective Period: 7/1/2016 - 6/30/2017

Wage and Supplemental Rate Per Hour: 40% of Journeyman's rate

**Drywall Taper - Second Year**

Effective Period: 7/1/2016 - 6/30/2017

Wage and Supplemental Rate Per Hour: 60% of Journeyman's rate

**Drywall Taper - Third Year**

Effective Period: 7/1/2016 - 6/30/2017

Wage and Supplemental Rate Per Hour: 80% of Journeyman's rate

(Local #1974)

---

OFFICE OF THE COMPTROLLER, CITY OF NEW YORK  
§220 APPRENTICESHIP PREVAILING WAGE SCHEDULE

---

**TILE LAYER - SETTER**

(Ratio of Apprentice to Journeyman: 1 to 1, 1 to 4)

**Tile Layer - Setter - First 750 Hours**

Effective Period: 7/1/2016 - 6/30/2017

Wage and Supplemental Rate Per Hour: 50% of Journeyman's rate

**Tile Layer - Setter - Second 750 Hours**

Effective Period: 7/1/2016 - 6/30/2017

Wage and Supplemental Rate Per Hour: 55% of Journeyman's rate

**Tile Layer - Setter - Third 750 Hours**

Effective Period: 7/1/2016 - 6/30/2017

Wage and Supplemental Rate Per Hour: 65% of Journeyman's rate

**Tile Layer - Setter - Fourth 750 Hours**

Effective Period: 7/1/2016 - 6/30/2017

Wage and Supplemental Rate Per Hour: 75% of Journeyman's rate

**Tile Layer - Setter - Fifth 750 Hours**

Effective Period: 7/1/2016 - 6/30/2017

Wage and Supplemental Rate Per Hour: 85% of Journeyman's rate

**Tile Layer - Setter - Sixth 750 Hours**

Effective Period: 7/1/2016 - 6/30/2017

Wage and Supplemental Rate Per Hour: 95% of Journeyman's rate

(Local #7)

---

---

**TIMBERPERSON**

(Ratio of Apprentice to Journeyman: 1 to 1, 1 to 6)

**Timberperson - First Year**

**OFFICE OF THE COMPTROLLER, CITY OF NEW YORK  
§220 APPRENTICESHIP PREVAILING WAGE SCHEDULE**

**Effective Period: 7/1/2016 - 6/30/2017  
Wage Rate Per Hour: 40% of Journeyperson's rate  
Supplemental Rate Per Hour: \$32.33**

**Timberperson - Second Year**

**Effective Period: 7/1/2016 - 6/30/2017  
Wage Rate Per Hour: 50% of Journeyperson's rate  
Supplemental Rate Per Hour: \$32.33**

**Timberperson - Third Year**

**Effective Period: 7/1/2016 - 6/30/2017  
Wage Rate Per Hour: 65% of Journeyperson's rate  
Supplemental Rate Per Hour: \$32.33**

**Timberperson - Fourth Year**

**Effective Period: 7/1/2016 - 6/30/2017  
Wage Rate Per Hour: 80% of Journeyperson's rate  
Supplemental Rate Per Hour: \$32.33**

**(Local #1536)**

OFFICE OF THE COMPTROLLER, CITY OF NEW YORK  
§6-109 PREVAILING WAGE SCHEDULE

---

**NYC ADMINISTRATIVE CODE § 6-109 SCHEDULE OF "LIVING WAGES"**

Contractors who provide the following services to the City of New York must post a copy of this Living Wage Schedule at their work site(s) as required by New York City Administrative Code § 6-109:

- Building Services,
- Day Care Services,
- Food Services,
- Head Start Services,
- Homecare Services,
- Services to Persons with Cerebral Palsy, and
- Temporary Services.

In accordance with NYC Administrative Code § 6-109, the Comptroller of the City of New York promulgated this schedule of living wages for the above services on contracts for non-emergency work in excess of the small purchase limit set by the Procurement Policy Board; contracting agencies must annex this schedule to such contracts.

This schedule is a compilation of separate determinations of the prevailing rate of wage and supplements made by the Comptroller for each trade classification listed herein pursuant to New York City Administrative Code section 6-109. The source of the wage and supplement rates, whether a collective bargaining agreement, survey data or other, is listed at the end of each classification.

A city service contractor or subcontractor that provides homecare services, day care services, head start services or services to persons with cerebral palsy must pay its covered employees that directly render such services in performance of the city service contract or subcontract no less than the living wage and must provide its employees health benefits (supplemental benefits) or must supplement their hourly wage rate by an amount no less than the health benefits supplement rate. This requirement applies for each hour that the employee works performing the city service contract or subcontract.

A city service contractor or subcontractor that provides building services, food services or temporary services must pay its employees that are engaged in performing the city service contract or subcontract no less than the living wage or the prevailing wage, whichever is greater. Where the living wage is greater than the prevailing wage, the city service contractor or subcontractor must either provide its employees health benefits or must supplement their hourly wage rate by an amount no less than the health benefits supplement rate. Where the prevailing wage is greater than the living wage, the city service contractor or subcontractor must provide its employees the prevailing wage and supplements. These requirements apply for each hour that the employee works performing the city service contract or subcontract.

The appropriate schedule of living wages must be posted at all work sites pursuant to NYC Administrative Code 6-109.

The schedule is applicable for work performed during the effective period, unless otherwise noted. You will be notified of any changes to this schedule by addenda published on our web site [www.comptroller.nyc.gov](http://www.comptroller.nyc.gov). Schedules for future one-year periods will be published annually in the City Record on or about July 1<sup>st</sup> of each succeeding year and on our web site [www.comptroller.nyc.gov](http://www.comptroller.nyc.gov).

OFFICE OF THE COMPTROLLER, CITY OF NEW YORK  
§6-109 PREVAILING WAGE SCHEDULE

The living wage rate and the health benefit supplement rate are known through June 30 of each year and those rates are listed in this schedule.

The living wage rates listed in this schedule may not include all hourly wage calculations for overtime, shift differential, Holiday, Saturday, Sunday or other premium time work. Similarly, this schedule does not set forth every living wage practice with which employers must comply.

Some of the rates in this schedule are based on collective bargaining agreements. These agreements are available for inspection by appointment. Requests for appointments may be made by calling (212) 669-4443, Monday through Friday between the hours of 9 a.m. and 5 p.m.

Answers to questions concerning prevailing wage practices may be obtained from the Classification Unit by calling (212) 669-7974. Please direct all other compliance issues to; Bureau of Labor Law, Attn: Wasyl Kinach, P.E., Office of the Comptroller, 1 Centre Street, Room 1122, New York, N.Y. 10007; Fax (212) 669-4002.

Contractors are solely responsible for maintaining original payroll records, which delineate, among other things, the hours each employee worked within a given classification. Contractors using rates and/or classifications not promulgated by the Comptroller do so at their own risk. Additionally, prior to bid, an agency's chief contracting officer must contact the Bureau of Labor Law to obtain a wage determination for a work classification not published in this schedule.

The information listed below is intended to assist you in meeting your living wage and prevailing wage obligation. Contractors are advised to review the Comptroller's Living Wage Schedule prior to submitting a bid for City work. Any wage rate error made by the contracting agency in the contract documents will not preclude a finding against the contractor for an underpayment of the applicable living wage or the applicable prevailing wage.

This schedule sets forth the living wage and benefit rates required to be annexed to and form part of the contract specifications for work covered by New York City Administrative Code § 6-109. Contractors performing such work are required to pay not less than the rates specified in this schedule for the applicable trade or occupation.

**Benefits are paid for EACH HOUR WORKED unless otherwise noted.**

Wasyl Kinach, P.E.  
Director of Classifications  
Bureau of Labor Law



OFFICE OF THE COMPTROLLER, CITY OF NEW YORK  
§6-109 PREVAILING WAGE SCHEDULE

**TABLE OF CONTENTS**

<b><u>CLASSIFICATION</u></b>	<b><u>PAGE</u></b>
BUILDING CLEANER AND MAINTAINER (OFFICE).....	4
BUILDING CLEANER AND MAINTAINER (RESIDENTIAL).....	4
CLEANER (PARKING GARAGE) .....	4
DAY CARE SERVICES.....	4
FOOD SERVICE EMPLOYEES.....	4
HEAD START SERVICES .....	5
HOMECARE SERVICES .....	6
LANDSCAPING AND GROUNDSKEEPING WORKER.....	6
SECURITY GUARD (ARMED).....	6
SECURITY GUARD (UNARMED) .....	6
SERVICES TO PERSONS WITH CEREBRAL PALSY.....	7
TEMPORARY OFFICE SERVICES .....	7
WINDOW CLEANER .....	8

OFFICE OF THE COMPTROLLER, CITY OF NEW YORK  
§6-109 PREVAILING WAGE SCHEDULE

**BUILDING CLEANER AND MAINTAINER (OFFICE)**

For the above building service classification, see the Labor Law Section 230 Schedule.

---

---

**BUILDING CLEANER AND MAINTAINER (RESIDENTIAL)**

For the above building service classification, see the Labor Law Section 230 Schedule.

---

---

**CLEANER (PARKING GARAGE)**

For the above building service classification, see the Labor Law Section 230 Schedule.

---

---

**DAY CARE SERVICES**

**Day Care Services**

'Day Care Services' means provision of day care services through the city's center-based day care program administered under contract with the city's Administration for Children's Services. No other day care programs shall be covered, including family-based day care programs administered by city-contracted day care centers.

Effective Period: 7/1/2016 - 6/30/2017

Wage Rate per Hour: \$10.00

Supplemental Benefit Rate per Hour: \$1.50

(NYC Administrative Code §6-109)

---

---

**FOOD SERVICE EMPLOYEES**

**Cook**

OFFICE OF THE COMPTROLLER, CITY OF NEW YORK  
§6-109 PREVAILING WAGE SCHEDULE

Effective Period: 7/1/2016 - 6/30/2017  
Wage Rate per Hour: \$16.81  
Supplemental Benefit Rate per Hour: \$1.75

**Cafeteria Attendant**

Effective Period: 7/1/2016 - 6/30/2017  
Wage Rate per Hour: \$12.81  
Supplemental Benefit Rate per Hour: \$1.75

**Counter Attendant**

Effective Period: 7/1/2016 - 6/30/2017  
Wage Rate per Hour: \$12.24  
Supplemental Benefit Rate per Hour: \$1.75

**Kitchen Helper / Dishwasher**

Effective Period: 7/1/2016 - 6/30/2017  
Wage Rate per Hour: \$11.94  
Supplemental Benefit Rate per Hour: \$1.75

**Overtime**

Time and one half the regular hourly rate after 40 hours in any work week.

(Based on data from NYS Department of Labor Occupational Employment Statistics and US Department of Labor Bureau of Labor Statistics)

---

**HEAD START SERVICES**

**Head Start Services**

'Head Start Services' means provision of head start services through the city's center-based head start program administered under contract with the city's Administration for Children's Services. No other head start programs shall be covered.

Effective Period: 7/1/2016 - 6/30/2017  
Wage Rate per Hour: \$10.00  
Supplemental Benefit Rate per Hour: \$1.50

(NYC Administrative Code §6-109)

---

OFFICE OF THE COMPTROLLER, CITY OF NEW YORK  
§6-109 PREVAILING WAGE SCHEDULE

---

## **HEMOCARE SERVICES**

### **Home Care Services**

'Homecare Services' means the provision of homecare services under the city's Medicaid Personal Care/Home Attendant or Housekeeping Programs, including but not limited to the In-Home Services for the Elderly Programs administered by the Department for the Aging.

For homecare services provided under the Personal Care Services program, the wage and supplemental benefit rate above shall apply only as long as the state and federal government maintain their combined aggregate proportionate share of funding and approved rates for homecare services in effect as of the date of the enactment of this section.

For contractors or subcontractors providing homecare services, the supplemental benefit rate may be waived by the terms of a bona fide collective bargaining agreement with respect to employees who have never worked a minimum of eighty (80) hours per month for two consecutive months for that covered employer, but such provision may not be waived for any employee once a minimum of eighty (80) hours for two consecutive months has been achieved.

Effective Period: 7/1/2016 - 6/30/2017

Wage Rate per Hour: \$10.00

Supplemental Benefit Rate per Hour: \$1.50

(NYC Administrative Code §6-109)

---

## **LANDSCAPING AND GROUNDSKEEPING WORKER**

For the above building service classification, see the Labor Law Section 230 Schedule.

---

## **SECURITY GUARD (ARMED)**

For the above building service classification, see the Labor Law Section 230 Schedule.

---

## **SECURITY GUARD (UNARMED)**

For the above building service classification, see the Labor Law Section 230 Schedule.

OFFICE OF THE COMPTROLLER, CITY OF NEW YORK  
§6-109 PREVAILING WAGE SCHEDULE

---

---

## SERVICES TO PERSONS WITH CEREBRAL PALSY

### Services To Person With Cerebral Palsy

'Services to Persons with Cerebral Palsy' means provision of services which enable persons with cerebral palsy and related disabilities to lead independent and productive lives through an agency that provides health care, education, employment, housing and technology resources to such persons under contract with the city or the department of education.

Effective Period: 7/1/2016 - 6/30/2017

Wage Rate per Hour: \$10.00

Supplemental Benefit Rate per Hour: \$1.50

(NYC Administrative Code §6-109)

---

---

## TEMPORARY OFFICE SERVICES

### Administrative Assistant

Effective Period: 7/1/2016 - 6/30/2017

Wage Rate per Hour: \$34.97

Supplemental Benefit Rate per Hour: None

### Cashier

Effective Period: 7/1/2016 - 6/30/2017

Wage Rate per Hour: \$11.50

Supplemental Benefit Rate per Hour: None

### Clerk (various)

Effective Period: 7/1/2016 - 6/30/2017

Wage Rate per Hour: \$16.07

Supplemental Benefit Rate per Hour: None

### Computer Assistant

Effective Period: 7/1/2016 - 6/30/2017

Wage Rate per Hour: \$19.07

Supplemental Benefit Rate per Hour: None

OFFICE OF THE COMPTROLLER, CITY OF NEW YORK  
§6-109 PREVAILING WAGE SCHEDULE

**Data Entry Operator**

Effective Period: 7/1/2016 - 6/30/2017  
Wage Rate per Hour: **\$16.70**  
Supplemental Benefit Rate per Hour: None

**Receptionist**

Effective Period: 7/1/2016 - 6/30/2017  
Wage Rate per Hour: **\$15.78**  
Supplemental Benefit Rate per Hour: None

**Secretary (various)**

Effective Period: 7/1/2016 - 6/30/2017  
Wage Rate per Hour: **\$20.22**  
Supplemental Benefit Rate per Hour: None

**Word Processor**

Effective Period: 7/1/2016 - 6/30/2017  
Wage Rate per Hour: **\$20.32**  
Supplemental Benefit Rate per Hour: None

**Overtime**

Time and one half the regular hourly rate after 40 hours in any work week.

(Based on data from NYS Department of Labor Occupational Employment Statistics and US Department of Labor Bureau of Labor Statistics or NYC Administrative Code §6-109)

---

**WINDOW CLEANER**

For the above building service classification, see the Labor Law Section 230 Schedule.



Leonard A. Mancusi  
SENIOR ASSISTANT COMPTROLLER

THE CITY OF NEW YORK  
OFFICE OF THE COMPTROLLER  
1 CENTRE STREET ROOM 1120  
NEW YORK, N.Y. 10007-2341

TELEPHONE: (212) 669-3622  
FAX NUMBER: (212) 669-8499

ALAN G. HEVESI  
COMPTROLLER

**MEMORANDUM**

November 6, 2000

To Agency Chief Contracting Officers

From: Leonard A. Mancusi

Re: Security at Construction Sites

Prior to the enactment of Administrative Code §6-109, security guards on construction sites were not subject to prevailing wages. Security guards under the New York State labor law are covered under §230 which provides that prevailing wages are to be paid for security guards in existing buildings. §6-109 of the Administrative Code which was enacted in 1996 closed this loophole by including all security guards working pursuant to a city contract as a prevailing wage trade.

Although some construction contract boilerplate language has been amended to include §6-109, sub-contractors performing security services have advised us that they were not aware of this provision and, since traditionally, security guards were not a covered trade on construction sites, and they were not advised by a prime contractor that they would have to pay prevailing wages, they have not been doing so.

To avoid the possibility of issuing stop payments against prime contractors for the failure of their security service sub-contractors to pay

*prevailing wages, we suggest that you write to all your existing security guard sub-contractors and their primes and in the future, upon approval of a security guard sub-contractor, advise the contractors of their obligation to pay prevailing wages under §6-109 of the Administrative Code.*

*As always, your cooperation is appreciated.*

**LAM:er**  
**ACCO.SECURITY AT SITES**





**SCHEDULE A****(GENERAL CONDITIONS TO CONSTRUCTION CONTRACT  
(INCLUDING GENERAL CONDITIONS RELATED TO ARTICLE 22 – INSURANCE)****PART I. REQUIRED INFORMATION**

<p align="center"><b><u>INFORMATION FOR BIDDERS SECTION 26 BID SECURITY</u></b></p> <p>The <b>Contractor</b> shall obtain a bid security in the amount indicated to the right.</p>	<p>Required provided the TOTAL BID PRICE set forth on the Bid Form is \$1,000,000. or more.</p> <p>Certified Check: 5% of Bid Amount or Bond: 10% of Bid Amount</p>
<p align="center"><b><u>INFORMATION FOR BIDDERS SECTION 26 PERFORMANCE AND PAYMENT BONDS</u></b></p> <p>The <b>Contractor</b> shall obtain performance and payment bonds in the amount indicated to the right.</p>	<p>Required for contracts in the amount of \$1,000,000 or more.</p> <p>Performance Security and Payment Security shall each be in an amount equal to 100% of the Contract Price.</p>
<p align="center"><b><u>INFORMATION FOR BIDDERS DEPARTMENT OF DESIGN AND CONSTRUCTION SAFETY REQUIREMENTS</u></b></p> <p>The <b>Contractor</b> shall provide the safety personnel as indicated to the right.</p>	<p><input checked="" type="checkbox"/> Project Safety Representative</p> <p><input type="checkbox"/> Dedicated, full-time Project Safety Manager</p>
<p align="center"><b><u>CONTRACT ARTICLE 14 DATE FOR SUBSTANTIAL COMPLETION</u></b></p> <p>The <b>Contractor</b> shall substantially complete the <b>Work</b> in the number of calendar days indicated to the right.</p>	<p>See Page SA-4</p>
<p align="center"><b><u>CONTRACT ARTICLE 15 LIQUIDATED DAMAGES</u></b></p> <p>If the <b>Contractor</b> fails to substantially complete the <b>Work</b> within the time fixed for substantial completion plus authorized time extensions or if the <b>Contractor</b>, in the sole determination of the <b>Commissioner</b>, has abandoned the <b>Work</b>, the <b>Contractor</b> shall pay to the <b>City</b> the amount indicated to the right.</p>	<p>\$4,000.00 for each consecutive calendar day over substantial completion time</p>
<p align="center"><b><u>CONTRACT ARTICLE 17. SUB-CONTRACTOR</u></b></p> <p>The <b>Contractor</b> shall not make subcontracts totaling an amount more than the percentage of the total <b>Contract</b> price indicated to the right.</p>	<p>Not to exceed <u>49</u> % of the <b>Contract</b> price</p>

<p align="center"><b><u>CONTRACT ARTICLE 21.</u></b> <b><u>RETAINAGE</u></b></p> <p>The <b>Commissioner</b> shall deduct and retain until the substantial completion of the <b>Work</b> the percent value of the <b>Work</b> indicated to the right.</p>	<p><u>0 %</u> of the value of the <b>Work</b></p>
<p align="center"><b><u>CONTRACT ARTICLE 22.</u></b> <b><u>(Per Directions Below)</u></b></p>	<p>See pages SA-5 through SA-13</p>
<p align="center"><b><u>CONTRACT ARTICLE 24.</u></b> <b><u>DEPOSIT GUARANTEE</u></b></p> <p>As security for the faithful performance of its obligations, the <b>Contractor</b>, upon filing its requisition for payment on <b>Substantial Completion</b>, shall deposit with the <b>Commissioner</b> a sum equal to the percentage of the <b>Contract</b> price indicated to the right.</p>	<p>1% of <b>Contract</b> price</p>
<p align="center"><b><u>CONTRACT ARTICLE 24.</u></b> <b><u>PERIOD OF GUARANTEE</u></b></p> <p>Periods of maintenance and guarantee other than the period set forth in Article 24.1 are indicated to the right.</p>	<p>Twenty-four (24) Months for Tree Planting</p>
<p align="center"><b><u>CONTRACT ARTICLE 74.</u></b> <b><u>STATEMENT OF WORK</u></b></p> <p>The <b>Contractor</b> shall furnish all labor and materials and perform all <b>Work</b> in strict accordance with the <b>Contract Drawings, Specifications</b>, and all <b>Addenda</b> thereto, as shown in the column to the right.</p>	<p><b>Addenda</b>, numbered:</p> <hr/>
<p align="center"><b><u>CONTRACT ARTICLE 75.</u></b> <b><u>COMPENSATION TO BE PAID TO CONTRACTOR</u></b></p> <p>The <b>City</b> shall pay and the <b>Contractor</b> shall accept in full consideration for the performance of the <b>Contract</b>, subject to additions and deductions as provided herein, the total sum shown in the column to the right, being the amount at which the <b>Contract</b> was awarded to the <b>Contractor</b> at a public letting thereof, based upon the <b>Contractor's</b> bid for the <b>Contract</b>.</p>	<p>Amount for which the <b>Contract</b> was Awarded:</p> <hr/> <p>_____ Dollars</p> <p>(\$ _____ )</p>
<p align="center"><b><u>CONTRACT ARTICLE 79.</u></b> <b><u>PARTICIPATION BY MINORITY-OWNED AND WOMEN-OWNED BUSINESS ENTERPRISES IN CITY PROCUREMENT</u></b></p>	<p>FHWA DBE goal of 13%, see page TF-D1, herein this book Volume 3 of 3</p>

<p style="text-align: center;"><b><u>STANDARD HIGHWAY SPECIFICATIONS</u></b> <b><u>SECTION 6.40</u></b> <b><u>LIQUIDATED DAMAGES FOR ENGINEER'S FIELD OFFICE</u></b></p> <p>If the Contractor fails to satisfactorily provide the field office and all equipment specified in <b>Section 6.40 - Engineer's Field Office</b>, and/or if a cited deficiency exceed seventy two (72) hours after notice from the Engineer in writing, or is permitted to recur, liquidated damages will be assessed in the amount specified herein for each subsequent calendar day or part thereof that a cited deficiency resulting in nonpayment, as described in <b>Section 6.40.5</b>, is not corrected.</p>	<p>\$ <u>500.00</u> for each calendar day of deficiency</p>
<p style="text-align: center;"><b><u>STANDARD HIGHWAY SPECIFICATIONS</u></b> <b><u>SECTION 6.70</u></b> <b><u>LIQUIDATED DAMAGES FOR MAINTENANCE AND PROTECTION OF TRAFFIC</u></b></p>	<p>\$ <u>250.00</u> for each instance of failure to comply with the Maintenance and Protection of Traffic requirements within three (3) hours after written notice from the Engineer.</p> <p>\$ <u>500.00</u> for each and every hour of failing to open the entire width of roadway to traffic the morning following a night/weekend work operation.</p>
<p style="text-align: center;"><b><u>STANDARD HIGHWAY SPECIFICATIONS</u></b> <b><u>SECTION 7.13</u></b> <b><u>LIQUIDATED DAMAGES FOR MAINTENANCE OF SITE</u></b></p> <p>If the Contractor fails to comply, within three (3) consecutive hours after written notice from the Engineer, with the requirements of <b>Section 7.13 - Maintenance of Site</b>, the Contractor shall pay to the City of New York, until such notice has been complied with or rescinded, the sum specified above per calendar day, for each instance of such failure, as liquidated damages and not as a penalty, for such default.</p>	<p>\$ <u>800.00</u> for each calendar day, for each occurrence</p>

**Date for Substantial Completion (Reference: Article 14)**

The Contractor shall substantially complete the Work within the Final Contract Duration determined in accordance with the terms and conditions set forth herein.

The Base Contract Duration for this project is 730 consecutive calendar days ("ccds").

The Final Contract Duration shall be the Base Contract Duration when a check mark is indicated before the word "NO", below, and shall be the Base Contract Duration adjusted by the table set forth below when a check mark is indicated before the word "YES", below.

YES                       NO

When the Final Contract Duration is indicated above to be adjusted by the table below, the table may increase the Base Contract Duration depending on the date of scheduled substantial completion to avoid a scheduled substantial completion of the Work during the winter months. The date of scheduled substantial completion shall be determined by adding the Base Contract Duration to the date specified to commence work in the written Notice to Proceed. The Final Contract Duration shall then be determined as follows:

- (a) Find the row that corresponds to the month of substantial completion based on the Base Contract Duration added to the date specified to commence work in the written Notice to Proceed.
- (b) Find the number of days to be added to the Base Contract Duration in the table below. Add that number of days to the Base Contract Duration to obtain the Final Contract Duration in consecutive calendar days.

<b>Month of Substantial Completion based on the Base Contract Duration</b>	<b>Number of Days of adjustment</b>
January	150
February	120
March	90
April	60
May	30
June	0
July	0
August	0
September	0
October	0
November –December 15	0
December 16 – December 31	180

In addition, should Item No. 9.30, "Storm Water Pollution Prevention," exist in the Contract and the required Storm Water Pollution Prevention Plan (SWPPP) does not conform to NYSDEC's recommended Standards, an additional 60 ccd shall be added to the above Final Contract Duration.

**(GENERAL CONDITIONS RELATING TO ARTICLE 22 – INSURANCE)**

**PART II. TYPES OF INSURANCE, MINIMUM LIMITS AND SPECIAL CONDITIONS**

**Note:** All certificate(s) of insurance submitted pursuant to Contract Article 22.3. 3 must be accompanied by a Certification by Broker consistent with Part III below and include the following information:

- For each insurance policy, the name and NAIC number of issuing company, number of policy, and effective dates;
- Policy limits consistent with the requirements listed below;
- Additional insureds or loss payees consistent with the requirements listed below; and
- The number assigned to the Contract by the City (in the “Description of Operations” field).

Insurance indicated by a blackened box (■) or by X in a □ to left will be required under this contract

Types of Insurance (per Article 22 in its entirety, including listed paragraph)	Minimum Limits and Special Conditions
<p>■ Commercial General Liability Art. 22.1.1</p>	<p>The minimum limits shall be \$ <u>3,000,000</u> per occurrence and \$ <u>6,000,000</u> per project aggregate applicable to this Contract.</p> <p>Additional Insureds:</p> <ol style="list-style-type: none"> <li>1. City of New York, including its officials and employees, with coverage at least as broad as ISO Form CG 20 10 and CG 20 37,</li> <li>2. All person(s) or organization(s), if any, that Article 22.1.1(b) of the Contract requires to be named as Additional Insured(s), with coverage at least as broad as ISO Form CG 20 26. The Additional Insured endorsement shall either specify the entity’s name, if known, or the entity’s title (e.g., Project Manager),</li> <li>3. All person(s) or organization(s) serving in the functions defined in Article 2, such as: Engineer, Architect, Project Manager, Resident Engineer, etc.</li> <li>4. New York State, including its officials and employees,</li> <li>5. Federal Highway Administration (FHWA), its officials and employees.</li> <li>6. National Grid</li> </ol>

<ul style="list-style-type: none"> <li><input checked="" type="checkbox"/> Workers' Compensation                      Art. 22.1.2</li> <li><input checked="" type="checkbox"/> Disability Benefits Insurance              Art. 22.1.2</li> <li><input checked="" type="checkbox"/> Employers' Liability                              Art. 22.1.2</li> <li><input type="checkbox"/> Jones Act    Art. 22.1.3</li> <li><input type="checkbox"/> U.S. Longshoremen's and Harbor Workers Compensation Act              Art. 22.1.3</li> </ul>	<p>Workers' Compensation, Employers' Liability, and Disability Benefits Insurance: Statutory per New York State law without regard to jurisdiction.</p> <p>Note: The following forms are acceptable: (1) New York State Workers' Compensation Board Form No. C-105.2, (2) State Insurance Fund Form No. U-26.3, (3) New York State Workers' Compensation Board Form No. DB-120.1 and (4) Request for WC/DB Exemption Form No. CE-200. The City will not accept an ACORD form as proof of Workers' Compensation or Disability Insurance.</p> <p>Jones Act and U.S. Longshoremen's and Harbor Workers' Compensation Act: Statutory per U.S. Law.</p> <ul style="list-style-type: none"> <li>■ Additional Requirements:</li> </ul> <p>(1) NYCT "OUTSIDE CONTRACT" INSURANCE REQUIREMENTS: Workers' Compensation Insurance (including Employer's Liability Insurance) with limits of not less than \$2,000,000, which limit may be met by a combination of primary and excess insurance meeting the statutory limits of New York State.</p> <p>(2) Two (2) certificates of such insurance shall be furnished to the Director, Risk Management, MTA Risk and Insurance Management Standards, Enforcement and Claims Unit, 2 Broadway, 21st Floor, New York, NY 10004.</p>
---	--

<p><input type="checkbox"/> Builders' Risk</p> <p>Art. 22.1.4</p>	<p><input type="checkbox"/> Required: 100% of total bid amount</p> <p><input type="checkbox"/> Required: 100 % of total bid amount for Item(s):</p> <p><b>Contractor</b> the Named Insured; the <b>City</b> both an Additional Insured and one of the loss payees as its interests may appear.</p> <p>If the <b>Work</b> does not involve construction of a new building or gut renovation work, the <b>Contractor</b> may provide an installation floater in lieu of Builders Risk insurance.</p> <p>Note: Builders Risk Insurance may terminate upon <b>Substantial Completion</b> of the <b>Work</b> in its entirety.</p>
<p><input checked="" type="checkbox"/> Commercial Auto Liability</p> <p>Art. 22.1.5</p>	<p>\$ <u>2,000,000</u> per accident combined single limit</p> <p>If vehicles are used for transporting hazardous materials, the <b>Contractor</b> shall provide pollution liability broadened coverage for covered vehicles (endorsement CA 99 48) as well as proof of MCS 90</p> <p>Additional Insureds:</p> <ul style="list-style-type: none"> <li>(1) City of New York, including its officials and employees, and</li> <li>(2) New York State, including its officials and employees, and,</li> <li>(3) FHWA, including its officials and employees.</li> </ul>



<input type="checkbox"/> Contractors Pollution Liability Art. 22.1.6	<p>\$ <u>5,000,000</u> per occurrence          \$ <u>5,000,000</u> aggregate</p> <p>Additional Insureds:          1. City of New York, including its officials and employees, and          2. _____          3. _____</p>
<input type="checkbox"/> Marine Protection and Indemnity Art. 22.1.7(a)	<p>\$ _____ each occurrence          \$ _____ aggregate</p> <p>Additional Insureds:          1. City of New York, including its officials and employees, and          2. _____          3. _____</p>
<input type="checkbox"/> Hull and Machinery Insurance Art. 22.1.7(b)	<p>\$ _____ per occurrence          \$ _____ aggregate</p> <p>Additional Insureds:          1. City of New York, including its officials and employees, and          2. _____          3. _____</p>
<input type="checkbox"/> Marine Pollution Liability Art. 22.1.7(c)	<p>\$ <u>1,000,000</u> per occurrence          \$ <u>1,000,000</u> aggregate</p> <p>Additional Insureds:          1. City of New York, including its officials and employees, and          2. _____          3. _____</p>

<p>[OTHER] Art. 22.1.8</p> <p>■ Railroad Protection Liability Policy</p> <p>(ISO-RIMA or equivalent form) approved by Permittor covering the work to be performed at the designated site and affording protection for damages arising out of bodily injury or death, physical damage to or destruction of property, including damage to the Insured's own property and conforming to the following:</p> <ul style="list-style-type: none"> <li>• Policy Endorsement CG 28 31 - Pollution Exclusion Amendment is required to be endorsed onto the policy when environmental-related work and/or exposures exist.</li> <li>• Indicate the Name and address of the Contractor to perform the work, the Contract # and the name of the railroad property where the work is being performed and the Agency Permit.</li> <li>• Evidence of Railroad Protective Liability Insurance, must be provided in the form of the <u>Original Policy</u>. <u>A detailed Insurance Binder (ACORD or Manuscript Form) will be accepted pending issuance of the Original Policy, which must be provided within 30 days of the Binder Approval.</u></li> </ul>	<p>\$ <u>2,000,000</u> per occurrence</p> <p>\$ <u>6,000,000</u> annual aggregate</p> <p>Named Insureds:</p> <ol style="list-style-type: none"> <li>1. New York City Transit Authority (NYCTA), the Manhattan and Bronx Surface Transit Operation Authority (MaBSTOA), the Staten Island Rapid Transit Operation Authority (SIRTOA), MTA Capital Construction Co., the Metropolitan Transportation Authority (MTA) including its subsidiaries and affiliates, and the City of New York (as Owner) and all other indemnified parties.</li> </ol>
--	---

<p>[OTHER]</p> <p><input type="checkbox"/> Professional Liability</p> <p>A. The Contractor's Professional Engineer shall maintain and submit evidence of Professional Liability Insurance in the minimum amount of \$1,000,000 per claim. The policy or policies shall include an endorsement to cover the liability assumed by the Contractor under this Contract arising out of the negligent performance of professional services or caused by an error, omission or negligent act of the Contractor's Professional Engineer or anyone employed by the Contractor's Professional Engineer.</p> <p>B. Claims-made policies will be accepted for Professional Liability Insurance. All such policies shall have an extended reporting period option or automatic coverage of not less than two (2) years. If available as an option, the Contractor's Professional Engineer shall purchase extended reporting period coverage effective on cancellation or termination of such insurance unless a new policy is secured with a retroactive date, including at least the last policy year.</p>	<p>Art. 22.1.8</p>	<p>Art. 22.1.8</p>
<p>[OTHER]</p> <p><input checked="" type="checkbox"/> Engineer's Field Office</p> <p><b>Section 6.40, Standard Highway Specifications</b></p>	<p>Art. 22.1.8</p>	<p>Fire insurance, extended coverage and vandalism, malicious mischief and burglary, and theft insurance coverage in the amount of <u>\$40,000</u></p>
<p>[OTHER]</p> <p><input type="checkbox"/> The Following Additional Insurance Must Be Provided:</p> <p><b>Umbrella/Excess Liability Insurance</b> - The Contractor shall provide Umbrella/Excess Liability Insurance in the minimum amount of \$10,000,000 per Occurrence and \$10,000,000 in Aggregate. The policy terms and condition should be at least as broad as the underlying policies. The underlying policies should comply with the insurance provision as outlined by the contract. Defense cost should be in addition to the limit of liability. The City of New York, including its officials and employees, should be included as additional insured as respects to the noted project.</p>	<p>Art. 22.1.8</p>	

**SCHEDULE A**  
**(GENERAL CONDITIONS TO CONSTRUCTION CONTRACT)**  
**(GENERAL CONDITIONS RELATING TO ARTICLE 22 – INSURANCE)**

**PART III. CERTIFICATES OF INSURANCE**

All certificates of insurance (except certificates of insurance solely evidencing Workers' Compensation Insurance, Employer's Liability Insurance, and/or Disability Benefits Insurance) must be accompanied by one of the following:

- (1) the Certification by Insurance Broker or Agent on the following page setting forth the required information and signatures;

-- OR --

- (2) copies of all policies as certified by an authorized representative of the issuing insurance carrier that are referenced in such certificate of insurance. If any policy is not available at the time of submission, certified binders may be submitted until such time as the policy is available, at which time a certified copy of the policy shall be submitted.



**SCHEDULE A**

**GENERAL CONDITIONS TO CONSTRUCTION CONTRACT**

**PART IV. ADDRESS OF COMMISSIONER**

Wherever reference is made in Article 7 or Article 22 to documents to be sent to the **Commissioner** (e.g., notices, filings, or submissions), such documents shall be sent to the address set forth below or, in the absence of such address, to the **Commissioner's** address as provided elsewhere in this **Contract**.

\_\_\_\_\_  
DDC Director, Insurance Risk Manager

\_\_\_\_\_  
30 – 30 Thomson Avenue, 4th Floor (IDCNY Building)

\_\_\_\_\_  
Long Island City, NY 11101

\_\_\_\_\_

(NO FURTHER TEXT ON THIS PAGE)

**(NO TEXT ON THIS PAGE)**



**Department of  
Design and  
Construction**

---

**INFRASTRUCTURE DIVISION  
BUREAU OF DESIGN**

---

**VOLUME 3 OF 3**

**PROJECT ID: SANDHW11**

**RECONSTRUCTION OF**

**BEACH CHANNEL DRIVE  
BETWEEN BEACH 116TH STREET AND BEACH 124TH STREET**

**INCLUDING SEWER, WATER MAIN, TRAFFIC SIGNAL  
AND STREET LIGHTING WORK**

**Together With All Work Incidental Thereto**

**BOROUGH OF QUEENS  
CITY OF NEW YORK**

---

*Contractor.*

---

**Dated** \_\_\_\_\_, 20\_\_\_\_

---