



**Department of
Design and
Construction**

**CITY OF NEW YORK
DEPARTMENT OF DESIGN AND CONSTRUCTION
DIVISION OF INFRASTRUCTURE
VOLUME 1 – BID BOOKLET**

TABLE OF CONTENTS

Introduction 2

Bid Submission Requirements..... 3

Notices to Bidders 4

 Pre Bid Questions (PBQs) 4

 NYC Contract Financing Loan Fund 4

M/WBE Notice to Prospective Contractors 5

Affirmation 13

Bid Schedule 15

Pre-Award Process 17

Project References 19

 A. Contracts completed by the bidder 19

 B. Contracts currently under construction by the bidder 20

 C. Pending contracts not yet started by the bidder 21

Introduction

This Bid Booklet is intended to provide general information necessary for bidding on a DDC public works project and is part of the Contract Documents, as per Article 1.1 of the Standard Construction Contract.

As this contract is solicited via the PASSPort system, the bidder will be required to complete all of the PASSPort forms and questionnaires. These forms and questionnaires, along with the bidder's responses, will become part of the Bid Booklet.

Additional information on the PASSPort system can be found at the following website:

<https://www1.nyc.gov/site/mocs/systems/passport-user-materials.page>

Bid Submission Requirements

THE FOLLOWING MUST BE COMPLETED AND SUBMITTED FOR THE BID TO BE CONSIDERED RESPONSIVE:

1. Completed electronic bid submission in PASSPort;
 - a. All required fields in PASSPort must be completed.
2. One-page signed Bid Submission Form delivered in person to DDC before the bid due date; and
3. Bid security, if required.
 - a. If Bid security is in a form of a bid bond, bidders must include it with their electronic PASSPort submission.
 - b. If Bid security is in a form of a certified check, bidders must deliver the certified check with the signed Bid Submission Form.

BIDDERS ARE ADVISED THAT PAPER BID SUBMISSIONS WILL BE DEEMED NON-RESPONSIVE. BIDDERS MUST SUBMIT THEIR BIDS ELECTRONICALLY IN PASSPORT, PROVIDE THE BID SECURITY, AND DELIVER TO DDC THE ONE-PAGE SIGNED BID SUBMISSION FOR THE BID TO BE CONSIDERED RESPONSIVE.

THE FOLLOWING MAY RESULT IN THE BID BEING FOUND NON-RESPONSIVE:

1. Any discrepancy between the total bid price listed on the Bid Submission Form and the bid information submitted in PASSPort.
2. Failure to upload required files or documents as part of a mandatory PASSPort Questionnaire response.
3. Uploading an incorrect file as part of a mandatory PASSPort Questionnaire response.

Notices to Bidders

Pre Bid Questions (PBQs)

Please be advised that PBQs should be submitted to the Agency Contact Person (CSB_projectinquiries@ddc.nyc.gov) at least five (5) business days (by 5:00 PM EST) prior to the bid opening date as indicated in the PASSPort procurement.

All PBQs must reference the Project ID. If a bidder has multiple PBQs for the same Project ID, the PBQs must be numbered sequentially, even if they are submitted separately.

While the PASSPort system has a facility for submitting inquiries, bidders are directed to send PBQs as directed above instead of using the PASSPort inquiry system.

Inquiries sent using the PASSPort inquiry system will not be considered PBQs.

NYC Contract Financing Loan Fund

If your business is working as a prime or subcontractor on a project with a City agency or City-funded entity, you may be eligible for a Contract Financing Loan from a participating lender coordinated with the NYC Department of Small Business Services (SBS). Loan repayment terms align with the contract payment schedule.

For more information: Call 311 or visit <https://www1.nyc.gov/nycbusiness/article/contract-financing-loan-fund>

M/WBE Notice to Prospective Contractors

PARTICIPATION BY MINORITY-OWNED AND WOMEN-OWNED BUSINESS ENTERPRISES IN CITY PROCUREMENT (9/2020 version)

ARTICLE I. M/WBE PROGRAM

Section 6-129 of the Administrative Code of the City of New York (“Section 6-129”) establishes the program for participation in City procurement (“M/WBE Program”) by minority-owned business enterprises (“MBEs”) and women-owned business enterprises (“WBEs”), certified in accordance with Section 1304 of the New York City Charter. As stated in Section 6-129, the intent of the program is to address the impact of discrimination on the City’s procurement process, and to promote the public interest in avoiding fraud and favoritism in the procurement process, increasing competition for City business, and lowering contract costs. The contract provisions contained herein are pursuant to Section 6-129, and the rules of the Department of Small Business Services (“DSBS”) promulgated thereunder.

If this Contract is subject to the M/WBE Program established by Section 6-129, the specific requirements of MBE and/or WBE participation for this Contract are set forth in Schedule B of the Contract (entitled the “M/WBE Utilization Plan”) and are detailed below. Contracts solicited through the Procurement and Sourcing Solutions Portal (PASSPort) will contain a Schedule B in the format outlined in the Schedule B – M/WBE Utilization Plan & PASSPort rider. The provisions of this notice will apply to contracts subject to the M/WBE Program established by Section 6-129 regardless of solicitation source.

The Contractor must comply with all applicable MBE and WBE requirements for this Contract.

All provisions of Section 6-129 are hereby incorporated in the Contract by reference and all terms used herein that are not defined herein shall have the meanings given such terms in Section 6-129.

References to MBEs or WBEs shall also include such businesses certified pursuant to the executive law where credit is required by section 311 of the New York City Charter or other provision of law.

Article I, Part A, below, sets forth provisions related to the participation goals for construction, standard and professional services contracts.

Article I, Part B, below, sets forth miscellaneous provisions related to the M/WBE Program.

PART A

PARTICIPATION GOALS FOR CONSTRUCTION, STANDARD

AND PROFESSIONAL SERVICES CONTRACTS OR TASK ORDERS

1. The **MBE and/or WBE Participation Goals** established for this Contract or Task Orders issued pursuant to this Contract, (“**Participation Goals**”), as applicable, are set forth on Schedule B, Part 1 to this Contract (see Page 1, Line 1 Total Participation Goals) or will be set forth on Schedule B, Part 1 to Task Orders issued pursuant to this Contract, as applicable.

The **Participation Goals** represent a percentage of the total dollar value of the Contract or Task Order, as applicable, that may be achieved by awarding subcontracts to firms certified with DSBS as MBEs and/or WBEs, and/or by crediting the participation of prime contractors and/or qualified joint ventures as provided in Section 3 below, unless the goals have been waived or modified by Agency in accordance with Section 6-129 and Part A, Sections 10 and 11 below, respectively.

2. If **Participation Goals** have been established for this Contract or Task Orders issued pursuant to this Contract, Contractor agrees or shall agree as a material term of the Contract that Contractor shall be subject to the **Participation Goals**, unless the goals are waived or modified by Agency in accordance with Section 6-129 and Part A, Sections 10 and 11 below, respectively.

3. If **Participation Goals** have been established for this Contract or Task Order issued pursuant to this Contract, a Contractor that is an MBE and/or WBE shall be permitted to count its own participation toward fulfillment of the relevant **Participation Goal**, provided that in accordance with Section 6-129 the value of Contractor's participation shall be determined by subtracting from the total value of the Contract or Task Order, as applicable, any amounts that the Contractor pays to direct subcontractors (as defined in Section 6-129(c)(13)), and provided further that a Contractor that is certified as both an MBE and a WBE may count its own participation either toward the goal for MBEs or the goal for WBEs, but not both.

A Contractor that is a qualified joint venture (as defined in Section 6-129(c)(30)) shall be permitted to count a percentage of its own participation toward fulfillment of the relevant **Participation Goal**. In accordance with Section 6-129, the value of Contractor's participation shall be determined by subtracting from the total value of the Contract or Task Order, as applicable, any amounts that Contractor pays to direct subcontractors, and then multiplying the remainder by the percentage to be applied to total profit to determine the amount to which an MBE or WBE is entitled pursuant to the joint venture agreement, provided that where a participant in a joint venture is certified as both an MBE and a WBE, such amount shall be counted either toward the goal for MBEs or the goal for WBEs, but not both.

4. A. If **Participation Goals** have been established for this Contract, a prospective contractor shall be required to submit with its bid or proposal, as applicable, a completed Schedule B, M/WBE Utilization Plan, Part 2 (see Pages 1-2) indicating: (a) whether the contractor is an MBE or WBE, or qualified joint venture; (b) the percentage of work it intends to award to direct subcontractors; (c) in cases where the contractor intends to award direct subcontracts, a description of the type and dollar value of work designated for participation by MBEs and/or WBEs, and the time frames in which such work is scheduled to begin and end; as well as the name, addresses, and telephone numbers of the M/WBE subcontractors if required by the solicitation; and (d) the prospective contractor's required certification and affirmations. In the event that this M/WBE Utilization Plan indicates that the bidder or proposer, as applicable, does not intend to meet the **Participation Goals**, the bid or proposal, as applicable, shall be deemed non-responsive, unless Agency has granted the bidder or proposer, as applicable, a pre-award waiver of the **Participation Goals** in accordance with Section 6-129 and Part A, Section 10 below.

B. (i) If this Contract is for a master services agreement or other requirements type contract that will result in the issuance of Task Orders that will be individually registered ("Master Services Agreement") and is subject to M/WBE **Participation Goals**, a prospective contractor shall be required to submit with its bid or proposal, as applicable, a completed Schedule B, M/WBE Participation Requirements for Master Services Agreements That Will Require Individually Registered Task Orders, Part 2 (page 2) indicating the prospective contractor's certification and required affirmations to make all reasonable good faith efforts to meet participation goals established on each individual Task Order issued pursuant to this Contract, or if a partial waiver is obtained or such goals are modified by the Agency, to meet the modified **Participation Goals** by soliciting and obtaining the participation of certified MBE and/or WBE firms. In the event that the Schedule B indicates that the bidder or proposer, as applicable, does not intend to meet the **Participation Goals** that may be established on Task Orders issued pursuant to this Contract, the bid or proposal, as applicable, shall be deemed non-responsive.

(ii) **Participation Goals** on a Master Services Agreement will be established for individual Task Orders issued after the Master Services Agreement is awarded. If **Participation Goals** have been established on a Task Order, a contractor shall be required to submit a Schedule B – M/WBE Utilization Plan For Independently Registered Task Orders That Are Issued Pursuant to Master Services Agreements, Part 2 (see Pages 1-2) indicating: (a) whether the contractor is an MBE or WBE, or qualified joint venture; (b) the percentage of work it intends to award to direct subcontractors; (c) in cases where the contractor intends to award direct subcontracts, a description of the type and dollar value of work designated for participation by MBEs and/or WBEs, and the time frames in which such work is scheduled to begin and end; as well as the name, addresses, and telephone numbers of the M/WBE subcontractors if required by the solicitation; and (d) the prospective contractor’s required certification and affirmations. The contractor must engage in good faith efforts to meet the **Participation Goals** as established for the Task Order unless Agency has granted the contractor a pre-award waiver of the **Participation Goals** in accordance with Section 6-129 and Part A, Section 10 below.

C. THE BIDDER/PROPOSER MUST COMPLETE THE SCHEDULE B INCLUDED HEREIN (SCHEDULE B, PART 2). A SCHEDULE B SUBMITTED BY THE BIDDER/PROPOSER WHICH DOES NOT INCLUDE THE VENDOR CERTIFICATION AND REQUIRED AFFIRMATIONS WILL BE DEEMED TO BE NON-RESPONSIVE, UNLESS A FULL WAIVER OF THE PARTICIPATION GOALS IS GRANTED (SCHEDULE B, PART 3). IN THE EVENT THAT THE CITY DETERMINES THAT THE BIDDER/PROPOSER HAS SUBMITTED A SCHEDULE B WHERE THE VENDOR CERTIFICATION AND REQUIRED AFFIRMATIONS ARE COMPLETED BUT OTHER ASPECTS OF THE SCHEDULE B ARE NOT COMPLETE, OR CONTAIN A COPY OR COMPUTATION ERROR THAT IS AT ODDS WITH THE VENDOR CERTIFICATION AND AFFIRMATIONS, THE BIDDER/PROPOSER WILL BE NOTIFIED BY THE AGENCY AND WILL BE GIVEN FOUR (4) CALENDAR DAYS FROM RECEIPT OF NOTIFICATION TO CURE THE SPECIFIED DEFICIENCIES AND RETURN A COMPLETED SCHEDULE B TO THE AGENCY. FAILURE TO DO SO WILL RESULT IN A DETERMINATION THAT THE BID/PROPOSAL IS NON-RESPONSIVE. RECEIPT OF NOTIFICATION IS DEFINED AS THE DATE NOTICE IS E-MAILED OR FAXED (IF THE BIDDER/PROPOSER HAS PROVIDED AN E-MAIL ADDRESS OR FAX NUMBER), OR NO LATER THAN FIVE (5) CALENDAR DAYS FROM THE DATE OF MAILING OR UPON DELIVERY, IF DELIVERED.

5. Where an **M/WBE** Utilization Plan has been submitted, the Contractor shall, within 30 days of issuance by Agency of a notice to proceed, submit a list of proposed persons or entities to which it intends to award subcontracts within the subsequent 12 months. In the case of multi-year contracts, such list shall also be submitted every year thereafter. The Agency may also require the Contractor to report periodically about the contracts awarded by its direct subcontractors to indirect subcontractors (as defined in Section 6-129(c)(22)). **PLEASE NOTE: If this Contract is a public works project subject to GML §101(5) (i.e., a contract valued at or below \$3M for projects in New York City) or if the Contract is subject to a project labor agreement in accordance with Labor Law §222, and the bidder is required to identify at the time of bid submission its intended subcontractors for the Wicks trades (plumbing and gas fitting; steam heating, hot water heating, ventilating and air conditioning (HVAC); and electric wiring), the Contractor must identify all those to which it intends to award construction subcontracts for any portion of the Wicks trade work at the time of bid submission, regardless of what point in the life of the contract such subcontracts will occur. In identifying intended subcontractors in the bid submission, bidders may satisfy any Participation Goals established for this Contract by proposing one or more subcontractors that are MBEs and/or WBEs for any portion of the Wicks trade work.** In the event that the Contractor’s selection of a subcontractor is disapproved, the Contractor shall have a reasonable time to propose alternate subcontractors.

6. MBE and WBE firms must be certified by DSBS in order for the Contractor to credit such firms’ participation toward the attainment of the **Participation Goals**. Such certification must occur prior to the firms’ commencement of work. A list of city-certified MBE and WBE firms may be obtained from the DSBS

website at www.nyc.gov/buycertified, by emailing DSBS at buyer@sbs.nyc.gov, by calling (212) 513-6451, or by visiting or writing DSBS at One Liberty Plaza, New York, New York, 10006, 11th floor. Eligible firms that have not yet been certified may contact DSBS in order to seek certification by visiting www.nyc.gov/getcertified, emailing MWBE@sbs.nyc.gov, or calling the DSBS certification helpline at (212) 513-6311. A firm that is certified as both an MBE and a WBE may be counted either toward the goal for MBEs or the goal for WBEs, but not both. No credit shall be given for participation by a graduate MBE or graduate WBE, as defined in Section 6-129(c)(20).

7. Where an **M/WBE** Utilization Plan has been submitted, the Contractor shall, with each voucher for payment, and/or periodically as Agency may require, submit statements, certified under penalty of perjury, which shall include, but not be limited to, the total amount the Contractor paid to its direct subcontractors, and, where applicable pursuant to Section 6-129(j), the total amount direct subcontractors paid to indirect subcontractors; the names, addresses and contact numbers of each MBE or WBE hired as a subcontractor by the Contractor, and, where applicable, hired by any of the Contractor's direct subcontractors; and the dates and amounts paid to each MBE or WBE. The Contractor shall also submit, along with its voucher for final payment: the total amount it paid to subcontractors, and, where applicable pursuant to Section 6-129(j), the total amount its direct subcontractors paid directly to their indirect subcontractors; and a final list, certified under penalty of perjury, which shall include the name, address and contact information of each subcontractor that is an MBE or WBE, the work performed by, and the dates and amounts paid to each.

8. If payments made to, or work performed by, MBEs or WBEs are less than the amount specified in the Contractor's **M/WBE** Utilization Plan, Agency shall take appropriate action, in accordance with Section 6-129 and Article II below, unless the Contractor has obtained a modification of its **M/WBE** Utilization Plan in accordance with Section 6-129 and Part A, Section 11 below.

9. Where an **M/WBE** Utilization Plan has been submitted, and the Contractor requests a change order the value of which exceeds the greater of 10 percent of the Contract or Task Order, as applicable, or \$500,000, Agency shall review the scope of work for the Contract or Task Order, as applicable, and the scale and types of work involved in the change order, and determine whether the **Participation Goals** should be modified.

10. Pre-award waiver of the **Participation Goals**.

(a) A bidder or proposer, or contractor with respect to a Task Order, may seek a pre-award full or partial waiver of the Participation Goals in accordance with Section 6-129, which requests that Agency change one or more **Participation Goals** on the grounds that the **Participation Goals** are unreasonable in light of the availability of certified firms to perform the services required, or by demonstrating that it has legitimate business reasons for proposing a lower level of subcontracting in its M/WBE Utilization Plan.

(b) To apply for a full or partial waiver of the **Participation Goals**, a bidder, proposer, or contractor, as applicable, must complete Part 3 of Schedule B and submit such request no later than seven (7) calendar days prior to the date and time the bids, proposals, or Task Orders are due, in writing to the Agency by email at MWBEModification@ddc.nyc.gov. Full or partial waiver requests that are received later than seven (7) calendar days prior to the date and time the bids, proposals, or Task Orders are due may be rejected as untimely. Bidders, proposers, or contractors, as applicable, who have submitted timely requests will receive an Agency response by no later than two (2) calendar days prior to the due date for bids, proposals, or Task Orders; provided, however, that if that date would fall on a weekend or holiday, an Agency response will be provided by close-of-business on the business day before such weekend or holiday date.

(c) If the Agency determines that the **Participation Goals** are unreasonable in light of the availability of certified firms to perform the services required, it shall revise the solicitation and extend the deadline for bids and proposals, or revise the Task Order, as applicable.

(d) Agency may grant a full or partial waiver of the **Participation Goals** to a bidder, proposer or contractor, as applicable, who demonstrates—before submission of the bid, proposal or Task Order, as applicable—that it has legitimate business reasons for proposing the level of

subcontracting in its **M/WBE** Utilization Plan. In making its determination, Agency shall consider factors that shall include, but not be limited to, whether the bidder, proposer or contractor, as applicable, has the capacity and the bona fide intention to perform the Contract without any subcontracting, or to perform the Contract without awarding the amount of subcontracts represented by the **Participation Goals**. In making such determination, Agency may consider whether the **M/WBE** Utilization Plan is consistent with past subcontracting practices of the bidder, proposer or contractor, as applicable, whether the bidder, proposer or contractor, as applicable, has made efforts to form a joint venture with a certified firm, and whether the bidder, proposer, or contractor, as applicable, has made good faith efforts to identify other portions of the Contract that it intends to subcontract.

11. Modification of **M/WBE** Utilization Plan. (a) A Contractor may request a modification of its **M/WBE** Utilization Plan after award of this Contract. **PLEASE NOTE: If this Contract is a public works project subject to GML §101(5) (i.e., a contract valued at or below \$3M for projects in New York City) or if the Contract is subject to a project labor agreement in accordance with Labor Law §222, and the bidder is required to identify at the time of bid submission its intended subcontractors for the Wicks trades (plumbing and gas fitting; steam heating, hot water heating, ventilating and air conditioning (HVAC); and electric wiring), the Contractor may request a Modification of its M/WBE Utilization Plan as part of its bid submission.** The Agency may grant a request for Modification of a Contractor's **M/WBE** Utilization Plan if it determines that the Contractor has established, with appropriate documentary and other evidence, that it made reasonable, good faith efforts to meet the **Participation Goals**. In making such determination, Agency shall consider evidence of the following efforts, as applicable, along with any other relevant factors:

(i) The Contractor advertised opportunities to participate in the Contract, where appropriate, in general circulation media, trade and professional association publications and small business media, and publications of minority and women's business organizations;

(ii) The Contractor provided notice of specific opportunities to participate in the Contract, in a timely manner, to minority and women's business organizations;

(iii) The Contractor sent written notices, by certified mail or facsimile, in a timely manner, to advise MBEs or WBEs that their interest in the Contract was solicited;

(iv) The Contractor made efforts to identify portions of the work that could be substituted for portions originally designated for participation by MBEs and/or WBEs in the **M/WBE** Utilization Plan, and for which the Contractor claims an inability to retain MBEs or WBEs;

(v) The Contractor held meetings with MBEs and/or WBEs prior to the date their bids or proposals were due, for the purpose of explaining in detail the scope and requirements of the work for which their bids or proposals were solicited;

(vi) The Contractor made efforts to negotiate with MBEs and/or WBEs as relevant to perform specific subcontracts, or act as suppliers or service providers;

(vii) Timely written requests for assistance made by the Contractor to Agency's M/WBE liaison officer and to DSBS;

(viii) Description of how recommendations made by DSBS and Agency were acted upon and an explanation of why action upon such recommendations did not lead to the desired level of participation of MBEs and/or WBEs.

Agency's M/WBE officer shall provide written notice to the Contractor of the determination.

(b) The Agency may modify the **Participation Goals** when the scope of the work has been changed by the Agency in a manner that affects the scale and types of work that the Contractor indicated in its **M/WBE Utilization Plan** would be awarded to subcontractors.

12. If the Contractor was required to identify in its bid or proposal the MBEs and/or WBEs they intended to use in connection with the performance of the Contract or Task Order, substitutions to the identified firms may only be made with the approval of the Agency, which shall only be given when the Contractor has proposed to use a firm that would satisfy the **Participation Goals** to the same extent as the firm previously identified, unless the Agency determines that the Contractor has established, with appropriate documentary and other evidence, that it made reasonable, good faith efforts. In making such determination, the Agency shall require evidence of the efforts listed in Section 11(a) above, as applicable, along with any other relevant factors.

13. If this Contract is for an indefinite quantity of construction, standard or professional services or is a requirements type contract and the Contractor has submitted an **M/WBE Utilization Plan** and has committed to subcontract work to MBEs and/or WBEs in order to meet the **Participation Goals**, the Contractor will not be deemed in violation of the M/WBE Program requirements for this Contract with regard to any work which was intended to be subcontracted to an MBE and/or WBE to the extent that the Agency has determined that such work is not needed.

14. If **Participation Goals** have been established for this Contract or a Task Order issued pursuant to this Contract, at least once annually during the term of the Contract or Task Order, as applicable, Agency shall review the Contractor's progress toward attainment of its **M/WBE Utilization Plan**, including but not limited to, by reviewing the percentage of work the Contractor has actually awarded to MBE and/or WBE subcontractors and the payments the Contractor made to such subcontractors.

15. If **Participation Goals** have been established for this Contract or a Task Order issued pursuant to this Contract, Agency shall evaluate and assess the Contractor's performance in meeting those goals, and such evaluation and assessment shall become part of the Contractor's overall contract performance evaluation.

PART B

MISCELLANEOUS

1. The Contractor shall take notice that, if this solicitation requires the establishment of a **M/WBE Utilization Plan**, the resulting contract may be audited by DSBS to determine compliance with Section 6-129. See §6-129(e)(10). Furthermore, such resulting contract may also be examined by the City's Comptroller to assess compliance with the **M/WBE Utilization Plan**.

2. Pursuant to DSBS rules, construction contracts that include a requirement for a **M/WBE Utilization Plan** shall not be subject to the law governing Locally Based Enterprises set forth in Section 6-108.1 of the Administrative Code of the City of New York.

3. DSBS is available to assist contractors and potential contractors in determining the availability of MBEs and/or WBEs to participate as subcontractors, and in identifying opportunities that are appropriate for participation by MBEs and/or WBEs in contracts.

4. Prospective contractors are encouraged to enter into qualified joint venture agreements with MBEs and/or WBEs as defined by Section 6-129(c)(30).

5. By submitting a bid or proposal the Contractor hereby acknowledges its understanding of the M/WBE Program requirements set forth herein and the pertinent provisions of Section 6-129, and any rules promulgated thereunder, and if awarded this Contract, the Contractor hereby agrees to comply with the M/WBE Program requirements of this Contract and pertinent provisions of Section 6-129, and any rules promulgated thereunder, all of which shall be deemed to be material terms of this Contract. The Contractor hereby agrees to make all reasonable, good faith efforts to solicit and obtain the participation of MBEs and/or WBEs to meet the required **Participation Goals**.

ARTICLE II. ENFORCEMENT

1. If Agency determines that a bidder or proposer, as applicable, has, in relation to this procurement, violated Section 6-129 or the DSBS rules promulgated pursuant to Section 6-129, Agency may disqualify such bidder or proposer, as applicable, from competing for this Contract and the Agency may revoke such bidder's or proposer's prequalification status, if applicable.

2. Whenever Agency believes that the Contractor or a subcontractor is not in compliance with Section 6-129 or the DSBS rules promulgated pursuant to Section 6-129, or any provision of this Contract that implements Section 6-129, including, but not limited to any **M/WBE** Utilization Plan, Agency shall send a written notice to the Contractor describing the alleged noncompliance and offering the Contractor an opportunity to be heard. Agency shall then conduct an investigation to determine whether such Contractor or subcontractor is in compliance.

3. In the event that the Contractor has been found to have violated Section 6-129, the DSBS rules promulgated pursuant to Section 6-129, or any provision of this Contract that implements Section 6-129, including, but not limited to, any **M/WBE** Utilization Plan, Agency may determine that one of the following actions should be taken:

- (a) entering into an agreement with the Contractor allowing the Contractor to cure the violation;
- (b) revoking the Contractor's pre-qualification to bid or make proposals for future contracts;
- (c) making a finding that the Contractor is in default of the Contract;
- (d) terminating the Contract;
- (e) declaring the Contractor to be in breach of Contract;
- (f) withholding payment or reimbursement;
- (g) determining not to renew the Contract;
- (h) assessing actual and consequential damages;
- (i) assessing liquidated damages or reducing fees, provided that liquidated damages may be based on amounts representing costs of delays in carrying out the purposes of the M/WBE Program, or in meeting the purposes of the Contract, the costs of meeting utilization goals through additional

procurements, the administrative costs of investigation and enforcement, or other factors set forth in the Contract;

(j) exercising rights under the Contract to procure goods, services or construction from another contractor and charge the cost of such contract to the Contractor that has been found to be in noncompliance; or

(k) taking any other appropriate remedy.

4. If an **M/WBE** Utilization Plan has been submitted, and pursuant to this Article II, Section 3, the Contractor has been found to have failed to fulfill its **Participation Goals** contained in its **M/WBE** Utilization Plan or the **Participation Goals** as modified by Agency pursuant to Article I, Part A, Section 11, Agency may assess liquidated damages in the amount of ten percent (10%) of the difference between the dollar amount of work required to be awarded to MBE and/or WBE firms to meet the **Participation Goals** and the dollar amount the Contractor actually awarded and paid, and/or credited, to MBE and/or WBE firms. In view of the difficulty of accurately ascertaining the loss which the City will suffer by reason of Contractor's failure to meet the **Participation Goals**, the foregoing amount is hereby fixed and agreed as the liquidated damages that the City will suffer by reason of such failure, and not as a penalty. Agency may deduct and retain out of any monies which may become due under this Contract the amount of any such liquidated damages; and in case the amount which may become due under this Contract shall be less than the amount of liquidated damages suffered by the City, the Contractor shall be liable to pay the difference.

5. Whenever Agency has reason to believe that an MBE and/or WBE is not qualified for certification, or is participating in a contract in a manner that does not serve a commercially useful function (as defined in Section 6-129(c)(8)), or has violated any provision of Section 6-129, Agency shall notify the Commissioner of DSBS who shall determine whether the certification of such business enterprise should be revoked.

6. Statements made in any instrument submitted to Agency pursuant to Section 6-129 shall be submitted under penalty of perjury and any false or misleading statement or omission shall be grounds for the application of any applicable criminal and/or civil penalties for perjury. The making of a false or fraudulent statement by an MBE and/or WBE in any instrument submitted pursuant to Section 6-129 shall, in addition, be grounds for revocation of its certification.

7. The Contractor's record in implementing its **M/WBE** Utilization Plan shall be a factor in the evaluation of its performance. Whenever Agency determines that a Contractor's compliance with an **M/WBE** Utilization Plan has been unsatisfactory, Agency shall, after consultation with the City Chief Procurement Officer, file an advice of caution form for inclusion in PASSPort as caution data.

Affirmation

The Bidder affirms and declares:

1. The said bidder is of lawful age and the only one interested in this bid; and no person, firm or corporation other than hereinbefore named has any interest in this bid, or in the Contract proposed to be taken.
2. By submission of this bid, each bidder and each person signing on behalf of any bidder certifies, and in the case of a joint bid each party thereto certifies as to its own organization, under penalty of perjury, that to the best of its knowledge and belief: (1) the prices in this bid have been arrived at independently without collusion, consultation, communication or agreement, for the purpose of restricting competition, as to any matter relating to such prices with any other bidder or with any competitor; (2) unless otherwise required by law, the prices quoted in this bid have not been knowingly disclosed by the bidder and will not knowingly be disclosed by the bidder prior to opening, directly or indirectly, to any other bidder or to any competitor; and (3) no attempt has been made or will be made by the bidder to induce any other person, partnership or corporation to submit or not to submit a bid for the purpose of restricting competition.
3. No councilman or other officer or employee or person whose salary is payable in whole or in part from the City Treasury is directly or indirectly interested in this bid, or in the supplies, materials, equipment, work or labor to which it relates, or in any of the profits thereof.
4. The bidder is not in arrears to the City of New York upon debt or contract or taxes, and is not a defaulter, as surety or otherwise, upon any obligation of the City of New York, and has not been declared not responsible, or disqualified, by any agency of the City of New York or State of New York, nor is there any proceeding pending relating to the responsibility or qualification of the bidder to receive public contracts except as set forth on the Affirmation included as disclosed in PASSPort.
5. The bidder hereby affirms that it has paid all applicable City income, excise and other taxes for all it has conducted business activities in New York City.
6. The bidder, as an individual, or as a member, partner, director or officer of the bidder, if the same be a firm, partnership or corporation, executes this document expressly warranting and representing that should this bid be accepted by the City and the Contract awarded to him, he and his subcontractors engaged in the performance:

(1) will comply with the provisions of Section 6-108 of the Administrative Code of the City of New York and the non-discrimination provisions of Section 220a of the New York State Labor Law, as more expressly and in detail set forth in the Agreement; (2) will comply with Section 6-109 of the Administrative Code of the City of New York in relation to minimum wages and other stipulations as more expressly and in detail set forth in the Agreement; (3) have complied with the provisions of the aforesaid laws since their respective effective dates, and (4) will post notices to be furnished by the City, setting forth the requirements of the aforesaid laws in prominent and conspicuous places in each and every plant, factory, building and structure where employees engaged in the performance of the Contract can readily view it, and will continue to keep such notices posted until the supplies, materials and equipment, or work labor and services required to be furnished or rendered by the Contractor have been finally accepted by the City. In the event of any breach or violation of the foregoing, the Contractor may be subject to damages, liquidated or otherwise, cancellation of the Contract and suspension as a

bidder for a period of three years. (The words, "the bidder", "he", "his", and "him" where used shall mean the individual bidder, firm, partnership or corporation executing this bid).

7. Compliance Report

The bidder, as an individual, or as a member, partner, director, or officer of the bidder, if the same be a firm, partnership, or corporation, (1) represents that his attention has been specifically drawn to Executive Order No. 50, dated April 25, 1980, on Equal Employment Compliance of the contract, and (2) warrants that he will comply with the provisions of Executive Order No. 50. The Employment Report must be submitted as part of the bid.

8. The bidder, as an individual, or as a member, partner, director, or officer of the bidder, if the same be a firm, partnership, or corporation, executes this document expressly warranting that he will comply with: (1) the provision of the contract on providing records, Chapter 8.
9. By submission of this bid, the bidder certifies that it now has and will continue to have the financial capability to fully perform the work required for this contract. Any award of this contract will be made in reliance upon such certification. Upon request therefor, the bidder will submit written verification of such financial capability in a form that is acceptable to the department.
10. In accordance with Section 165 of the State Finance Law, the bidder agrees that tropical hardwoods, as defined in Section 165 of the State Finance Law, shall not be utilized in the performance of this Contract, except as the same are permitted by the foregoing provision of law.
11. The bidder has visited and examined the site of the work and has carefully examined the Contract in the form approved by the Corporation Counsel, and will execute the Contract and perform all its items, covenants and conditions, and will provide, furnish and deliver all the work, materials, supplies, tools and appliances for all labor and materials necessary or required for the hereinafter named work, all in strict conformity with the Contract, for the prices set forth in the Bid Schedule.
12. M/WBE UTILIZATION PLAN: By signing its bid, the bidder agrees to the M/WBE Vendor Certification and Required Affirmations set forth below, unless a full waiver of the Participation Goals is granted.

I hereby:

- 1) acknowledge my understanding of the M/WBE participation requirements as set forth in this Contract and the pertinent provisions of Section 6-129 of the Administrative Code of the City of New York and the rules promulgated thereunder;
- 2) affirm that the information supplied in support of the M/WBE Utilization Plan is true and correct;
- 3) agree, if awarded this Contract, to comply with the M/WBE participation requirements of this Contract, the pertinent provisions of Section 6-129, and the rules promulgated thereunder, all of which shall be deemed to be material terms of this Contract;
- 4) agree and affirm that it is a material term of this Contract that the Vendor will award the total dollar value of the M/WBE Participation Goals to certified MBEs and/or WBEs, unless a full waiver is obtained or such goals are modified by the Agency; and

agree and affirm, if awarded this Contract, to make all reasonable, good faith efforts to meet the M/WBE Participation Goals, or If a partial waiver is obtained or such goals are modified by the Agency, to meet the modified Participation Goals by soliciting and obtaining the participation of certified MBE and/or WBE firms.

Bid Schedule

The Questionnaire in the PASSPort system contains the Bid Schedule. Items listed in the Bid Schedule shall comply with the requirements of the corresponding sections of the specifications detailed in the table below. All references to the Standard Specifications, Details, Standards and Drawings shall be to the version in effect at the time of bid.

NOTES:

- “XXX” in the table below signifies any possible combination of characters and spaces.
- The table below may contain item formats which are not included in the Bid Schedule.
Please refer to the Bid Schedule to determine which specifications apply.

Item Number Format	Applicable Specifications
4.XXX 6.XXX 7.XXX 8.XXX <i>(Except 8.01 XXX; see below)</i> 9.XXX HW-XXX	NYC Department of Transportation (“DOT”) Standard Highway Specifications, as amended in the R-Pages, located in Volume 3 of 3 herein; <p style="text-align: center;">AND</p> NYC DOT Standard Details of Construction; <p style="text-align: center;">OR,</p> <i>if the item is not contained within the Standard Specifications,</i> then see the applicable New Sections in the I-Pages, located in Volume 3 of 3 herein.
1.XXX 50.XXX through 55.XXX 60.XXX through 66.XXX 70.XXX through 79.XXX <i>(Except 79.11XXX; see below)</i> DSS XXX DSW XXX	NYC Department of Environmental Protection (“DEP”) Standard Sewer and Water Main Specifications, as amended in the R-Pages and SW-Pages, located in Volume 3 of 3 herein; <p style="text-align: center;">AND</p> NYC DEP Specifications for Trunk Main Work; <p style="text-align: center;">AND</p> NYC DEP Sewer Design Standards; <p style="text-align: center;">AND</p> NYC DEP Water Main Standard Drawings; <p style="text-align: center;">OR,</p> <i>if the item is not contained within the Standard Specifications,</i> then see the Amendments to the Standard Sewer and Water Main Specifications in the SW-Pages, located in Volume 3 of 3 herein.
GI-XXX PM-XXX ROW XXX	New Sections in the I-Pages, located in Volume 3 of 3 herein <p style="text-align: center;">AND</p> NYC DEP Standards for Green Infrastructure.

Item Number Format	Applicable Specifications
UTL-XXX	Gas Cost Sharing Standard Specifications in the EP7-Pages, located in Volume 3 of 3 herein.
83X.XXX MX.XXX MP XXX NYC-XXX NYCT-XXX NYPD-XXX P XXX PK-XXX	New Sections in the I-Pages, located in Volume 3 of 3 herein.
BMP-XXX	Specifications for Construction of Best Management Practice (BMP) and Mitigation Area in the BMP-Pages, located in Volume 3 of 3 herein.
E XXX ME XXX	Specifications for the Specialty Electrical Works in the EL-Pages, located in Volume 3 of 3 herein.
SL-XXX	NYC DOT Division of Street Lighting Specifications AND NYC Division of Street Lighting Standard Drawings.
T-XXX	NYC DOT Specifications for Traffic Signals and Intelligent Transportation Systems AND NYC DOT Traffic Signal Standard Drawings.
JB XXX	Joint Bid Specifications in the JB-Pages, located in Volume 3 of 3 herein.
8.01 XXX	Specifications for Handling, Transportation and Disposal of Nonhazardous and Potentially Hazardous Contaminated Materials in the HAZ-Pages, located in Volume 3 of 3 herein.
67.XXX	Specifications for Abatement of Coal Tar Wrap Asbestos Containing Materials in the ASB-Pages, located in Volume 3 of 3 herein.
79.11XXX	Specifications for Abatement of Transit Authority Duct Insulation Asbestos Containing Materials in the ASB-Pages, located in Volume 3 of 3 herein.

Pre-Award Process

The bidder is advised that as part of the pre-award review of its bid, it may be required to submit the information described in Sections (A) through (D) below. If required, the bidder must submit such information within five (5) business days following receipt of notification from DDC that it is among the low bidders. Such notification from DDC will be by email and will specify the types of information which must be submitted directly to DDC.

In the event the bidder fails to submit the required information within the specified time frame, its bid may be rejected as nonresponsive.

- (A) **Project Reference Form:** If required, the bidder must complete and submit the Project Reference Form set forth in this Bid Booklet. The Project Reference Form consists of 3 parts: (1) Contracts Completed by the Bidder, (2) Contracts Currently Under Construction by the Bidder, and (3) Pending Contracts Not Yet Started by the Bidder.
- (B) **Copy of License:** If required, the bidder must submit a copy of the license under which the bidder will be performing the work. Such license must clearly show the following: (1) Name of the Licensee, (2) License Number, and (3) Expiration date of the License. A copy of the license will be required from bidders for the following contracts: Plumbing Work, Electrical Work and Asbestos Abatement.
- (C) **Financial Information:** If required, the bidder must submit the financial information described below:
 - (1) **Audited Financial Statements:** Financial statements (Balance Sheet and Income Statement) of the entity submitting the bid, as audited by an independent auditor licensed to practice as a certified public accountant (CPA). Audited financial statements for the three most recent fiscal years must be submitted. Each such financial statement must include the auditor's standard report.

If the bidder does not have audited financial statements, it must submit an affidavit attesting to the fact that the bidder does not have such statements. In addition, the bidder must submit the following documentation covering the three most recent fiscal years: signed federal tax returns, unaudited financial statements, and a "certified review letter" from a certified public accountant (CPA) verifying the unaudited financial statements.

Unless the most recent audited or unaudited financial statement was issued within ninety (90) days, the bidder must submit interim financial information that includes data on financial position and results of operation (income data) for the current fiscal year. Such information may be summarized on a monthly or quarterly basis or at other intervals.

- (2) **Schedule of Aged Accounts Receivable,** including portion due within ninety (90) days.

(D) **Project Specific Information:** If required, the bidder must submit the project specific information described below:

- (1) Statement indicating the number of years of experience the bidder has had and in what type of construction.
- (2) Resumes of all key personnel to be involved in the project, including the proposed project superintendent.
- (3) List of significant pieces of equipment expected to be used for the contract, and whether such equipment is owned or leased.
- (4) Description of work expected to be subcontracted, and to what firms, if known.
- (5) List of key material suppliers.
- (6) Preliminary bar chart time schedule
- (7) Contractor's expected means of financing the project. This should be based on the assumption that the contractor is required to finance 2X average monthly billings throughout the contract period.
- (8) Any other issues the contractor sees as impacting his ability to complete the project according to the contract.

In addition to the information described in Sections (A) through (D) above, the bidder shall submit such additional information as the Commissioner may require, including without limitation, an explanation or justification for specific unit price items.

The bidder is further advised that it may be required to attend a pre-award meeting with DDC representatives. If such a meeting is convened, the bidder will be advised as to any additional material to be provided.

BID SUBMISSION FORM

Bidder Name: RE-EARTH OF STROUDSBURG INC.
Procurement Title: 85024B0021-HWS2023R - INSTALLATION OF
SIDEWALKS, ADJACENT CURBS AND
PEDESTRIAN RAMPS AS NECESSARY IN
VARIOUS LOCATIONS, STATEN ISLAND
RFx Name: 85024B0021- HWS2023R - INSTALLATION OF
SIDEWALKS, ADJACENT CURBS AND
PEDESTRIAN RAMPS AS NECESSARY IN
VARIOUS LOCATIONS, STATEN ISLAND

The above-named bidder affirms and declares:

1. The bidder has completed and submitted all required information for the above procurement in the PASSPort system;
2. Any discrepancy between the bid price listed on this Bid Submission Form and the bid information submitted in PASSPort may result in the agency finding the bid non-responsive; and
3. This bid is being submitted in accordance with New York State General Municipal Law § 103.

Total Bid Price: \$ 2,695,191.30
(a/k/a Total Amount)

Bidder Signature

EIN (if applicable): 81-4263393

(EIN must match the EIN of the entity that submitted bid information in PASSPort)

Bidder Name: RE-EARTH OF STROUDSBURG INC.

By: MAHYLA ESPINOZA

(Name of Partner of Corporate Officer)

Signature: *Mahyla Espinoza*

(Signature of Partner of Corporate Officer)

**NEW YORK CITY DEPARTMENT OF DESIGN AND CONSTRUCTION
DIVISION OF INFRASTRUCTURE - BUREAU OF DESIGN
BID SCHEDULE**

Project ID: HWS2023R
ePIN: 85024B0021

TOTAL BID PRICE: \$2,695,191.30

Col. 1	Col. 2	Col. 3	Col. 4	Col. 5	Col. 6	Col. 7	Col. 8
Seq. No	Item Number	Item Description	Engineer's Estimate of Quantity	Unit	Unit Price	Extended Amount	Price Criteria
1	4.02 AB-R	ASPHALTIC CONCRETE WEARING COURSE, 1-1/2" THICK	1,410.00	S.Y.	\$20.00	\$28,200.00	
2	4.02 CB	ASPHALTIC CONCRETE MIXTURE	190.00	TONS	\$25.00	\$4,750.00	
3	4.04 H	CONCRETE BASE FOR PAVEMENT, VARIABLE THICKNESS FOR TRENCH RESTORATION, (HIGH-EARLY STRENGTH)	190.00	C.Y.	\$25.00	\$4,750.00	
4	4.07 CB	NEW GRANITE CURB, STRAIGHT	50.00	L.F.	\$150.00	\$7,500.00	
5	4.08 BA	CONCRETE CURB (21" DEEP)	3,150.00	L.F.	\$50.00	\$157,500.00	
6	4.08 RC-AA	RETURNED CONCRETE CURB (16" DEEP)	80.00	L.F.	\$50.00	\$4,000.00	
7	4.09 AE	STRAIGHT STEEL FACED CONCRETE CURB (21" DEEP)	1,850.00	L.F.	\$75.00	\$138,750.00	
8	4.09 BE	DEPRESSED STEEL FACED CONCRETE CURB (21" DEEP)	300.00	L.F.	\$75.00	\$22,500.00	
9	4.09 CE	CORNER STEEL FACED CONCRETE CURB (21" DEEP)	800.00	L.F.	\$75.00	\$60,000.00	
10	4.11 CA	FILL, PLACE MEASUREMENT	50.00	C.Y.	\$1.00	\$50.00	
11	4.13 AAS	4" CONCRETE SIDEWALK (UNPIGMENTED)	26,000.00	S.F.	\$20.50	\$533,000.00	
12	4.13 AAX	4" CONCRETE SIDEWALK WITH SPECIAL SCORING (UNPIGMENTED)	700.00	S.F.	\$8.00	\$5,600.00	
13	4.13 ABS	4" CONCRETE SIDEWALK (PIGMENTED)	2,100.00	S.F.	\$8.00	\$16,800.00	
14	4.13 BAS	7" CONCRETE SIDEWALK (UNPIGMENTED)	19,300.00	S.F.	\$22.00	\$424,600.00	
15	4.13 BBS	7" CONCRETE SIDEWALK (PIGMENTED)	3,650.00	S.F.	\$8.00	\$29,200.00	
16	4.13 CABS	4" CONCRETE SIDEWALK (PIGMENTED) (SAW CUT TYPE JOINTS)	370.00	S.F.	\$8.00	\$2,960.00	
17	4.13 CBBS	7" CONCRETE SIDEWALK (PIGMENTED) (SAW CUT TYPE JOINTS)	550.00	S.F.	\$8.00	\$4,400.00	
18	4.13 DE	EMBEDDED PREFORMED DETECTABLE WARNING UNITS	800.00	S.F.	\$25.00	\$20,000.00	
19	4.13 DSA	SURFACE APPLIED DETECTABLE WARNING UNITS	80.00	S.F.	\$2.00	\$160.00	
20	4.13 HWE-S	ALLOWANCE FOR CONCRETE SIDEWALK REPAIR UNDER THE CITY'S EXPEDITED/45 DAY REPAIR PREMIUM PLAN	1.00	F.S.	\$120,000.00	\$120,000.00	PRICE BID SHALL BE FOR THE FIXED SUM OF \$ 120,000.00
21	4.13 HW-S	ALLOWANCE FOR CONCRETE SIDEWALK OF LESS THAN 100 SQUARE FEET PER PROPERTY	1.00	F.S.	\$20,000.00	\$20,000.00	PRICE BID SHALL BE FOR THE FIXED SUM OF \$ 20,000.00
22	4.14 W	WELDED STEEL WIRE FABRIC	2,050.00	LBS.	\$0.50	\$1,025.00	
23	4.15	TOPSOIL	35.00	C.Y.	\$5.00	\$175.00	
24	4.16 AA	TREES REMOVED (4" TO UNDER 12" CALIPER)	5.00	EACH	\$5.00	\$25.00	
25	4.16 AB	TREES REMOVED (12" TO UNDER 18" CALIPER)	4.00	EACH	\$5.00	\$20.00	
26	4.16 AC	TREES REMOVED (18" TO UNDER 24" CALIPER)	2.00	EACH	\$5.00	\$10.00	
27	4.16 AD	TREES REMOVED (24" CALIPER AND OVER)	1.00	EACH	\$5.00	\$5.00	
28	4.16 BA510	TREES PLANTED, 2-1/2" TO 3" CALIPER, ALL TYPES, IN 5' X 10' TREE PITS	10.00	EACH	\$5.00	\$50.00	
29	4.16 STUMP	STUMP REMOVAL	8.00	EACH	\$5.00	\$40.00	
30	4.18 A	MAINTENANCE TREE PRUNING (UNDER 12" CAL.)	20.00	EACH	\$5.00	\$100.00	
31	4.18 B	MAINTENANCE TREE PRUNING (12" TO UNDER 18" CAL.)	7.00	EACH	\$5.00	\$35.00	
32	4.18 C	MAINTENANCE TREE PRUNING (18" TO UNDER 24" CAL.)	6.00	EACH	\$5.00	\$30.00	
33	4.18 D	MAINTENANCE TREE PRUNING (24" CAL. AND OVER)	4.00	EACH	\$5.00	\$20.00	
34	4.19	SODDING	35.00	S.Y.	\$5.00	\$175.00	
35	4.21	TREE CONSULTANT	600.00	P/HR	\$65.00	\$39,000.00	
36	51.41S001	STANDARD CATCH BASIN, TYPE 1	4.00	EACH	\$250.00	\$1,000.00	
37	52.11D12	12" DUCTILE IRON PIPE BASIN CONNECTION	120.00	L.F.	\$5.00	\$600.00	
38	55.11AB	ABANDONING BASINS AND INLETS	4.00	EACH	\$25.00	\$100.00	
39	6.02 AAN	UNCLASSIFIED EXCAVATION	255.00	C.Y.	\$25.00	\$6,375.00	
40	6.03 AA	STRIPPING PAVEMENT SURFACE (ASPHALTIC CONCRETE)	710.00	S.Y.	\$25.00	\$17,750.00	

**NEW YORK CITY DEPARTMENT OF DESIGN AND CONSTRUCTION
DIVISION OF INFRASTRUCTURE - BUREAU OF DESIGN
BID SCHEDULE**

Project ID: HWS2023R
ePIN: 85024B0021

TOTAL BID PRICE: \$2,695,191.30

Col. 1	Col. 2	Col. 3	Col. 4	Col. 5	Col. 6	Col. 7	Col. 8
Seq. No	Item Number	Item Description	Engineer's Estimate of Quantity	Unit	Unit Price	Extended Amount	Price Criteria
41	6.03 CA	STRIPPING PAVEMENT SURFACE (GRANITE BLOCK) (DISPOSAL OF BLOCK)	33.00	S.Y.	\$10.00	\$330.00	
42	6.04 BC	INSTALL GRANITE BLOCK PAVEMENT (NEW OR CLEANED EXISTING)	35.00	S.Y.	\$10.00	\$350.00	
43	6.06 AB	GRANITE BLOCK SIDEWALK (GROUTED JOINTS) (FURNISH BLOCK)	35.00	S.Y.	\$10.00	\$350.00	
44	6.07 AA	EXISTING BLUESTONE FLAGS RELAID	30.00	S.F.	\$10.00	\$300.00	
45	6.07 AB	NEW BLUESTONE FLAGS, FURNISHED AND LAID	30.00	S.F.	\$10.00	\$300.00	
46	6.22 F	ADDITIONAL HARDWARE	600.00	LBS.	\$1.00	\$600.00	
47	6.33 A	STEEL FACED MALL NOSING, 1' TO UNDER 3' RADIUS	2.00	EACH	\$150.00	\$300.00	
48	6.33 B	STEEL FACED MALL NOSING, 3' TO UNDER 6' RADIUS	2.00	EACH	\$150.00	\$300.00	
49	6.36 DR	STRUCTURAL REPAIR AND ADJUSTMENT OF UTILITY STRUCTURES	15.00	C.Y.	\$50.00	\$750.00	
50	6.40 B	ENGINEER'S FIELD OFFICE (TYPE B)	24.00	MONTH	\$8,000.00	\$192,000.00	
51	6.43 D	DIGITAL PHOTOGRAPHS	490.00	SETS	\$35.00	\$17,150.00	
52	6.44	THERMOPLASTIC REFLECTORIZED PAVEMENT MARKINGS (4" WIDE)	6,600.00	L.F.	\$0.50	\$3,300.00	
53	6.44 CST	COLOR SURFACE TREATMENT FOR PAVEMENTS (CST)	3,900.00	S.F.	\$2.00	\$7,800.00	
54	6.51 BD-P	PAVEMENT KEY AT PEDESTRIAN RAMP	30.00	C.Y.	\$50.00	\$1,500.00	
55	6.52 CG	CROSSING GUARD	650.00	P/HR	\$45.00	\$29,250.00	
56	6.55	SAWCUTTING EXISTING PAVEMENT	6,900.00	L.F.	\$1.00	\$6,900.00	
57	6.70	MAINTENANCE AND PROTECTION OF TRAFFIC	1.00	L.S.	\$150,000.00	\$150,000.00	Unit price bid shall not be less than: \$ 150,000.00
58	6.82 A	REMOVING EXISTING TRAFFIC AND STREET NAME SIGNS	55.00	S.F.	\$1.00	\$55.00	
59	6.82 B	REMOVING EXISTING TRAFFIC AND STREET NAME SIGN POSTS	84.00	L.F.	\$1.00	\$84.00	
60	6.83 AA	FURNISHING NEW NON-REFLECTORIZED TRAFFIC SIGNS	35.00	S.F.	\$1.00	\$35.00	
61	6.83 AB	FURNISHING NEW TRAFFIC SIGN POSTS	96.00	L.F.	\$1.00	\$96.00	
62	6.83 AR	FURNISHING NEW REFLECTORIZED TRAFFIC SIGNS	25.00	S.F.	\$1.00	\$25.00	
63	6.83 BA	INSTALLING TRAFFIC SIGNS	60.00	S.F.	\$1.00	\$60.00	
64	6.83 BB	INSTALLING TRAFFIC SIGN POSTS	96.00	L.F.	\$1.00	\$96.00	
65	6.86 AA	FURNISHING NEW STREET NAME SIGNS	12.00	S.F.	\$1.00	\$12.00	
66	6.86 AB	FURNISHING NEW STREET NAME SIGN POSTS	70.00	L.F.	\$1.00	\$70.00	
67	6.86 BA	INSTALLING STREET NAME SIGNS	12.00	S.F.	\$1.00	\$12.00	
68	6.86 BB	INSTALLING STREET NAME SIGN POSTS	70.00	L.F.	\$1.00	\$70.00	
69	6.91	REFLECTIVE CRACKING MEMBRANE (18" WIDE)	6,300.00	L.F.	\$1.00	\$6,300.00	
70	62.14FS	FURNISHING, DELIVERING AND INSTALLING HYDRANT FENDERS	35.00	EACH	\$250.00	\$8,750.00	
71	7.13 A	MAINTENANCE OF SITE	1.00	L.S.	\$99,000.00	\$99,000.00	Unit price bid shall not be less than: \$ 99,000.00
72	7.20	RESET BASEMENT ACCESS	110.00	L.F.	\$15.00	\$1,650.00	
73	7.88 AA	RODENT INFESTATION SURVEY AND MONITORING	1.00	L.S.	\$7,000.00	\$7,000.00	Unit price bid shall not be less than: \$ 7,000.00
74	7.88 AB	RODENT BAIT STATIONS	360.00	EACH	\$65.00	\$23,400.00	Unit price bid shall not be less than: \$ 65.00
75	7.88 AC	BAITING OF RODENT BAIT STATIONS	360.00	EACH	\$11.00	\$3,960.00	Unit price bid shall not be less than: \$ 11.00
76	7.88 AD	WATERBUG BAIT APPLICATIONS	75.00	BLOCK	\$75.00	\$5,625.00	Unit price bid shall not be less than: \$ 75.00
77	72.11HF	HYDRAULIC FILL FOR ABANDONED SEWERS AND WATER MAINS	10.00	C.Y.	\$1.00	\$10.00	
78	8.01 C1	HANDLING, TRANSPORTING AND DISPOSAL OF NON-HAZARDOUS CONTAMINATED SOIL	890.00	TONS	\$85.00	\$75,650.00	Unit price bid shall not be less than: \$ 85.00
79	8.01 C2	SAMPLING AND TESTING OF CONTAMINATED/POTENTIALLY HAZARDOUS SOIL FOR DISPOSAL PURPOSES	3.00	SETS	\$2,000.00	\$6,000.00	Unit price bid shall not be less than: \$ 2,000.00
80	8.01 H	HANDLING, TRANSPORTING AND DISPOSAL OF HAZARDOUS SOIL	136.00	TONS	\$400.00	\$54,400.00	Unit price bid shall not be less than: \$ 400.00
81	8.01 S	HEALTH AND SAFETY	1.00	L.S.	\$20,000.00	\$20,000.00	Unit price bid shall not be less than: \$ 20,000.00

**NEW YORK CITY DEPARTMENT OF DESIGN AND CONSTRUCTION
DIVISION OF INFRASTRUCTURE - BUREAU OF DESIGN
BID SCHEDULE**

Project ID: HWS2023R
ePIN: 85024B0021

TOTAL BID PRICE: \$2,695,191.30

Col. 1	Col. 2	Col. 3	Col. 4	Col. 5	Col. 6	Col. 7	Col. 8
Seq. No	Item Number	Item Description	Engineer's Estimate of Quantity	Unit	Unit Price	Extended Amount	Price Criteria
82	8.01 W1	REMOVAL, TREATMENT, AND DISCHARGE/DISPOSAL OF CONTAMINATED WATER	2.00	DAY	\$1,700.00	\$3,400.00	Unit price bid shall not be less than: \$ 1,700.00
83	8.01 W2	SAMPLING AND TESTING OF CONTAMINATED WATER	3.00	SETS	\$1,400.00	\$4,200.00	Unit price bid shall not be less than: \$ 1,400.00
84	8.02 AB-S	SPECIAL CARE EXCAVATION AND RESTORATION FOR CURB AND SIDEWALK WORK	12,850.00	S.F.	\$0.05	\$642.50	
85	8.32	BARK CHIP MULCH	10.00	S.Y.	\$1.00	\$10.00	
86	9.00 C	EXPLORATORY TEST PITS	40.00	C.F.	\$5.00	\$200.00	
87	9.29	ALLOWANCE FOR RAILROAD FACILITIES INCLUDING INSURANCE AND FORCE ACCOUNT (ALL TYPES)	1.00	F.S.	\$32,000.00	\$32,000.00	PRICE BID SHALL BE FOR THE FIXED SUM OF \$ 32,000.00
88	HW-900H	ALLOWANCE FOR CITY WORK ACCELERATION	1.00	F.S.	\$60,000.00	\$60,000.00	PRICE BID SHALL BE FOR THE FIXED SUM OF \$ 60,000.00
		Total				\$2,495,547.50	
89	6.39 B	MOBILIZATION	1.00	L.S.	\$199,643.80	\$199,643.80	BID PRICE OF MOBILIZATION SHALL NOT EXCEED 8% OF THE ABOVE SUB-TOTAL PRICE.

FORM OF BID BOND

KNOW ALL MEN BY THESE PRESENTS. That we, Re-Earth of Stroudsburg Inc
899 Bank Street, Brooklyn, NY 11236

hereinafter referred to as the "Principal", and American Southern Insurance Company
3715 Northside Parkway, Building 400 - Suite 800, Atlanta, GA 30327

hereinafter referred to as the "Surety" are held and firmly bound to THE CITY OF NEW YORK,
hereinafter referred to as the "CITY", or to its successors and assigns in the penal sum of _____

Ten Percent of Bid Amount (--10%--)

(\$ ---10%---), Dollars lawful money of the United States, for the payment of which said
sum of money well and truly to be made, we, and each of us, bind ourselves, our heirs, executors,
administrators, successors and assigns, jointly and severally, firmly by these presents.

Whereas, the Principal is about to submit (or has submitted) to the City the accompanying
proposal, hereby made a part hereof, to enter into a contract in writing for Installation of

Sidewalks, Curbs, & Ped Ramps in Staten Island, Contract#HWS2023R

NOW, THEREFORE, the conditions of this obligation are such that if the Principal shall
not withdraw said Proposal without the consent of the City for a period of forty-five (45) days after
the opening of bids and in the event of acceptance of the Principal's Proposal by the City, if the
Principal shall:

(a) Within ten (10) days after notification by the City, execute in quadruplicate and
deliver to the City all the executed counterparts of the Contract in the form set forth in the Contract
Documents, in accordance with the proposal as accepted, and

(b) Furnish a performance bond and separate payment bond, as may be required by
the City, for the faithful performance and proper fulfillment of such Contract, which bonds shall be
satisfactory in all respects to the City and shall be executed by good and sufficient sureties, and

(c) In all respects perform the agreement created by the acceptance of said Proposal
as provided in the Information for Bidders, bound herewith and made a part hereof, or if the City
shall reject the aforesaid Proposal, then this obligation shall be null and void; otherwise to remain
in full force and effect.

In the event that the Proposal of the Principal shall be accepted and the Contract be awarded to the Principal the Surety hereunder agrees subject only to the payment by the Principal of the premium therefore, if requested by the City, to write the aforementioned performance and payment bonds in the form set forth in the Contract Documents.

It is expressly understood and agreed that the liability of the Surety for any and all claims hereunder shall in no event exceed the penal amount of this obligation as herein stated.

There shall be no liability under this bond if, in the event of the acceptance of the Principal's Proposal by the City, either a performance bond or payment bond, or both, shall not be required by the City on or before the 30th day after the date on which the City signs the Contract.

The surety, for the value received, hereby stipulates and agrees that the obligations of the Surety and its bond shall in no way be impaired or affected by any postponements of the date upon which the City will receive or open bids, or by any extensions of the time within which the City may accept the Principal's Proposal, or by any waiver by the City of any of the requirements of the Information for Bidders, and the Surety hereby waives notice of any such postponements, extensions, or waivers.

IN WITNESS WHEREOF, the Principal and the Surety have hereunto set their hands and seals and such of them as are corporations have caused their corporate seals to be hereto affixed and these presents to be signed by their proper officers the 16th day of January, 2024.



(Seal)

RE-EARTH OF STROUDSBURG INC (L.S.)
Principal

By: Mahyla Espinoza

(Seal)

American Southern Insurance Company
Surety

By: [Signature]
Scott Adams, Attorney-in-Fact

ACKNOWLEDGMENT OF PRINCIPAL, IF A CORPORATION

State of New York County of Kings ss:
On this 16th day of January, 2024, before me personally came
Mahyla Espinoza to me known, who, being by me duly sworn, did
depose and say that he/she/they resides at
7 mansion Drive, Old westbury NY 11568
that he/she/they is the Resident of
Re-Earth of Stratsburg Inc
the corporation described in and which executed the foregoing instrument; that he/she/they knows
the seal of said corporation; that one of the seals affixed to said instrument is such seal; that it
was so affixed by order of the directors of said corporation, and that he/she/they signed his name
thereto by like order.

Fran Longo

FRAN LONGO
Notary Public, State of New York
Registration #01LO6108018
Qualified In Kings County
Commission Expires April 12, 2024

Notary Public

ACKNOWLEDGMENT OF PRINCIPAL, IF A PARTNERSHIP

State of _____ County of _____ ss:
On this _____ day of _____, _____, before me personally
appeared _____ to me known and known to me to be one of
the members of the firm of _____ described in and
who executed the foregoing instrument, and he/she/they acknowledged to me that he/she/they
executed the same as and for the act and deed of said firm.

Notary Public

ACKNOWLEDGMENT OF PRINCIPAL, IF AN INDIVIDUAL

State of _____ County of _____ ss:
On this _____ day of _____, _____, before me personally
appeared _____ to me known and known to me to be the
person described in and who executed the foregoing instrument and acknowledged that
he/she/they executed the same.

Notary Public

AFFIX ACKNOWLEDGMENTS AND JUSTIFICATION OF SURETIES

AMERICAN SOUTHERN INSURANCE COMPANY

Domicile: 200 S.W. 30th Street
Topeka, Kansas 66611

Mailing Address: 3715 Northside Pkwy, NW, STE 4-800
Atlanta, Georgia 30327

GENERAL POWER OF ATTORNEY

Know all men by these Presents, that the American Southern Insurance Company had made, constituted and appointed, and by these presents does make, constitute and appoint Scott Adams of Cedar Knolls, New Jersey as its true and lawful attorney for it and its name, place and stead to execute on behalf of the said company, as surety, bonds, undertakings and contracts of suretyship to include execution of consents for the release of retained percentages and/or final estimates on engineering and construction contracts, or similar authority to be given to all obligees provided that no bond or undertaking or contract of suretyship executed under this authority shall exceed in amount of the sum of \$2,500,000 (Two Million Five Hundred Fifty Thousand U.S. Dollars).

This Power of Attorney is granted and is signed and sealed by facsimile under and by the authority of the following Resolution adopted pursuant to due authorization by the Executive Committee of the Board of Directors of the American Southern Insurance Company on the 26th day of May, 1998:

RESOLVED, that the Chairman, President or any Vice President of the Company be, and that each or any of them hereby is, authorized to execute Powers of Attorney qualifying the attorney named in the given Power of Attorney to execute in behalf of the American Southern Insurance Company bonds, undertakings and all contracts of suretyship; and that any Secretary or any Assistant Secretary be, and that each or any of them hereby is, authorized to attest the execution of any such Power of Attorney, and to attach thereto the seal of the Company.

FURTHER RESOLVED, that the signature of such officers and the seal of the Company may be affixed to any such Power of Attorney or to any certificate relating thereto by facsimile, and any such Power of Attorney or certificate bearing such facsimile signatures or facsimile seal shall be valid and binding upon the Company when so affixed and in the future, with respect to any bond undertaking or contract of suretyship to which it is attached.

In Witness Whereof, the American Southern Insurance Company has caused its official seal to be hereto affixed, and these presents to be signed by its President and attested by its Secretary this 15th day of December, 2021.

Attest: 
Melonie A. Coppola, Corporate Secretary
STATE OF GEORGIA
COUNTY OF FULTON

American Southern Insurance Company
By: 
Scott G. Thompson, President

On this 7th day of April, 2017, before me personally came Scott G. Thompson, to me known, who being by me duly sworn, did depose and say that he resides in Atlanta, in the County of Fulton, State of Georgia, at 421 Hollydale Court; that he is the President of American Southern Insurance Company, the corporation described in and which executed the above instrument; that he knows the seal of the said corporation; that the seal affixed to the said instrument is such corporate seal; that it was so affixed and that he signed his name thereto pursuant to due authorization.

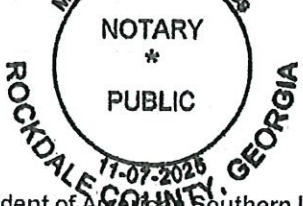
STATE OF GEORGIA NOTARY SEAL: 

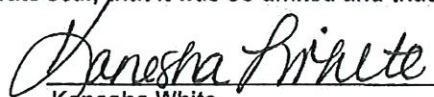
Kanesha White
Notary Public, State of Georgia
My Commission Expires November 7, 2025

I, the undersigned, a Vice President of American Southern Insurance Company, a corporation domiciled in Kansas, DO HEREBY CERTIFY that the foregoing and attached Power of Attorney remains in full force and has not been revoked; and, furthermore, that the Resolution of the Executive Committee of the Board of Directors set forth in the Power of Attorney is now in force.

Signed and sealed at the City of Atlanta, Dated the 16th day of January, 2021.

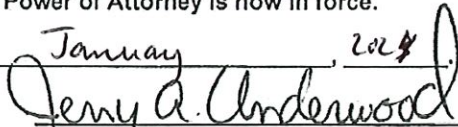
Jerry A. Underwood
Vice President - Surety

POA NUMBER: 10408

STATE OF New Jersey

COUNTY OF Morris

On this 16th day of January, 2024 before me, a Notary Public within and for said County and State, personally appeared Scott Adams to me personally known, who being duly sworn, upon oath, did say that he is the authorized signatory for the American Southern Insurance Company, a corporation created, organized and existing under and by the virtue of the laws of the State of Kansas that the Corporate seal affixed to the foregoing instrument is the seal of said Corporation; that the seal was affixed; and the said Scott Adams did acknowledge that he executed the said instrument as the free and deed of said Corporation.



Notary Public

VIVIANE LOPRETE
Notary Public, State of New Jersey
My Commission Expires 09/09/2026



American Southern Insurance Company
 NAIC Company Code 10235
 NAIC Group Code 587

Statutory Financial Statement

As of December 31, 2022

ASSETS		LIABILITIES	
Bonds	\$94,493,205	Reserve for Losses and Loss Expense	\$54,545,500
Stocks	16,560,329	Reserve for Unearned Premiums	25,534,247
Cash & Cash Equivalents	16,937,413	Reserve for Expenses, Taxes, Licenses and Fees	8,379,501
Agents Balances	11,191,552	Payable to Parents, Subsidiaries and Affiliates	273,203
Other Assets	5,104,759	Other Liabilities	2,531,551
		Total Liabilities	\$91,264,002
		POLICYHOLDERS'S SUPLUS	
		Capital Stock	3,000,000
		Surplus	50,023,256
		Total Policy holders' Surplus	53,023,256
Total Assets	\$144,287,258	Total Liabilities and Policyholders' Surplus	\$144,287,258

Bonds and stocks are valued in accordance with the basis adopted by the National Association of Insurance Commissioners (NAIC).

CERTIFICATE

The officers of this reporting entity being duly sworn, each depose and say that they are the described officers of said reporting entity, and that on the reporting period stated above, all of the herein described assets were the absolute property of the said reporting entity, free and clear from any liens or claims thereon, except as herein stated, and that this statement, together with related exhibits, schedules and explanations therein contained, annexed or referred to, is a full and true statement of all the assets and liabilities and of the condition and affairs of the said reporting entity as of the reporting period stated above, and of its income and deductions therefrom for the period ended, and have been completed in accordance with the NAIC Annual Statement Instructions and Accounting Practices and Procedures manual except to the extent that: (1) state law may differ; or, (2) that state rules or regulations require differences in reporting not related to accounting practices and procedures, according to the best of their information, knowledge and belief, respectively.



 President



 Chief Financial Officer

State of Georgia
 County of Fulton

On the 21st day of February 2023, before me came the above named officers of the American Southern Insurance Company to me personally know to be the individuals and officers described herein, and acknowledge that they executed the foregoing instrument and affixed the seal of said company thereto by authority of their office.



 Melonie Coppola, Notary Public
 My Commission Expires, May 17, 2026

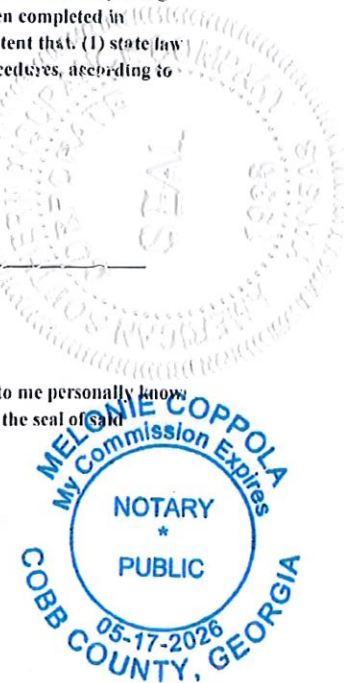

Project References

A. Contracts completed by the bidder

List all contracts substantially completed within the last 4 years, up to a maximum of 10 projects, in descending order of date of substantial completion.

Project & Location	Contract Type	Contract Amount (\$000)	Date Completed	Owner Reference & Tel. No.	Architect/Engineer Reference & Tel. No. (if different from owner)
HWPR19K1	INSTALLATIONS OF PED. RAMPS	\$3,178,276.13	11/30/2021	NYC DDC	KIRAM PATEL 212-313-3539
HWS2016K2	INSTALLATIONS OF SIDEWALKS	\$2,281,331.74	11/30/2021	NYC DDC	FLORE BRUNEAU 718-391-1299
HWPR20K3	INSTALLATIONS OF PED. RAMPS	\$3,555,650.00	11/30/2021	NYC DDC	HOWARD JIANG 212-313-3519
HWS2016R1	INSTALLATIONS OF SIDEWALKS	\$1,529,937.98	11/30/2021	NYC DDC	ARTHUR VALCIN 646-284-7345
HWS2016R2	INSTALLATIONS OF SIDEWALKS	\$1,375,227.87	11/30/2021	NYC DDC	ARTHUR VALCIN 646-284-7345
HWS2019X	INSTALLATIONS OF SIDEWALKS	\$247,235.77	09/20/2021	NYC DDC	HOWARD JIANG 212-313-3519
BG-1018M	INSTALLATIONS OF SIDEWALKS	\$402,661.30	11/16/2021	NYC DPR	AMANDA DIAMOND 718-361-8352
CNYG-1518M	INSTALLATIONS OF SIDEWALKS	\$309,418.45	09/08/2021	NYC DPR	ANDRES SILDARRIAGA 718-361-8352
HWS2019Q2	INSTALLATIONS OF SIDEWALKS	\$584,000.00	05/31/2020	NYC DDC	JIN LIN 347-578-1947

B. Contracts currently under construction by the bidder

List all contracts currently under construction even if they are not similar to the contract being awarded.

Project & Location	Contract Type	Contract Amount (\$000)	Subcontracted to Others (\$000)	Uncompleted Portion (\$000)	Date Scheduled to Complete	Owner Reference & Tel. No.	Architect/ Engineer Reference & Tel. No. (if different from owner)
HWS2021X	Installation of Sidewalks	\$1,580,969.64	\$130,000.00	\$855,969.64	1/11/2025	NYC DDC	Patricia Teja (646) 276-1295
CONISPH3A	Concrete sidewalk restoration	\$3,712,541.00	N/A	\$3,712,541.00	11/27/2024	NYC DDC	

C. Pending contracts not yet started by the bidder

List all contracts awarded to or won by the bidder but not yet started.

Project & Location	Contract Type	Contract Amount (\$000)	Date Scheduled to Start	Owner Reference & Tel. No.	Architect/Engineer Reference & Tel. No. (if different from owner)
NO WORK					
CURRENTLY PENDING					



**Department of
Design and
Construction**

**THE CITY OF NEW YORK
DEPARTMENT OF DESIGN AND
CONSTRUCTION
DIVISION OF INFRASTRUCTURE**

30-30 THOMSON AVENUE
LONG ISLAND CITY, NY, 11101
TEL: 718.391.1000
WEB: www.nyc.gov/ddc

TO BE FILLED IN BY THE BIDDER:

BIDDER'S NAME:

BID SECURITY (CIRCLE ONE):

BID BOND / CERTIFIED CHECK

NUMBER OF ADDENDUMS RECEIVED
AND ATTACHED TO BID:

_____ ADDENDUMS

DDC CLIENT AGENCY:

DEPARTMENT OF TRANSPORTATION

PREPARED BY:

IN HOUSE

DATE PREPARED:

11/01/2023

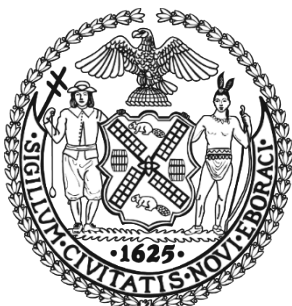

VOLUME 2 OF 3

FOR FURNISHING ALL LABOR AND MATERIALS
NECESSARY AND REQUIRED FOR:

PROJECT ID: HWS2023R

INFORMATION FOR BIDDERS CONTRACT

PERFORMANCE AND PAYMENT BONDS PREVAILING WAGE SCHEDULE

INSTALLATION OF SIDEWALKS, ADJACENT CURBS AND PEDESTRIAN RAMPS AS NECESSARY IN VARIOUS LOCATIONS

TOGETHER WITH ALL WORK INCIDENTAL THERETO

BOROUGH OF STATEN ISLAND CITY OF NEW YORK

CITY OF NEW YORK
DEPARTMENT OF DESIGN AND CONSTRUCTION
INFORMATION FOR BIDDERS
December 2021

THIS PAGE INTENTIONALLY LEFT BLANK

CITY OF NEW YORK
DEPARTMENT OF DESIGN AND CONSTRUCTION
INFORMATION FOR BIDDERS

TABLE OF CONTENTS

1.	Description and Location of Work	1
2.	Time and Place for Receipt of Bids	1
3.	Definitions	1
4.	Invitation For Bids and Contract Documents	1
5.	Pre-Bid Conference	1
6.	Agency Contact	1
7.	Bidder's Oath	1
8.	Examination and Viewing of Site, Consideration of Other Sources of Information and Changed Conditions	2
9.	Examination of Proposed Contract	2
10.	Form of Bid	2
11.	Irrevocability of Bid	3
12.	Acknowledgment of Amendments	3
13.	Bid Samples and Descriptive Literature	3
14.	Proprietary Information/Trade Secrets	3
15.	Pre-Opening Modification or Withdrawal of Bids	3
16.	Bid Evaluation and Award	3
17.	Late Bids, Late Withdrawals and Late Modifications	3
18.	Withdrawal of Bids.	3
19.	Mistake in Bids	4
20.	Low Tie Bids	4
21.	Rejection of Bids	5
22.	Right to Appeal Determinations of Non-Responsiveness or Non-Responsibility and Right to Protest Solicitations and Award	5
23.	Affirmative Action and Equal Employment Opportunity	5
25.	Complaints About the Bid Process	6
26.	Bid, Performance and Payment Security	6
27.	Failure to Execute Contract	7
28.	Bidder Responsibilities and Qualifications	7
29.	Employment Report	7
30.	Labor Law Requirements	8
31.	Insurance	8
32.	Lump Sum Contracts	8
33.	Unit Price Contracts	8

34.	Excise Tax	9
35.	Licenses and Permits	9
36.	Multiple Prime Contractors	9
37.	Locally Based Enterprise Requirements (LBE)	9
38.	Bid Submission Requirements	11
39.	Comptroller's Certificate	11
40.	Procurement Policy Board Rules	11
41.	DDC Safety Requirements	11

1. Description and Location of Work

The description and location of the work for which bids are requested are specified in the PASSPort RFX field "Description".

2. Time and Place for Receipt of Bids

Sealed bids shall be received on or before the date and hour specified in the PASSPort RFX, at which time they will be publicly opened and read aloud in the presence of the Commissioner or the Commissioner's or her representative, and any bidders who may desire to be present.

3. Definitions

The definitions set forth in the Procurement Policy Board Rules shall apply to this Invitation For Bids.

4. Invitation For Bids and Contract Documents

(A) Except for titles, sub-titles, headings, running headlines, tables of contents and indices (all of which are printed herein merely for convenience) the following, except for such portions thereof as may be specifically excluded, shall be deemed to be part of the Contract and the Invitation for Bids.

- (1) All provisions required by law to be inserted in this Contract, whether actually inserted or not
- (2) The Contract Drawings and Specifications
- (3) The General Conditions, the General Requirements and the Special Conditions, if any
- (4) The Contract
- (5) The Information for Bidders; Request for Proposals; Notice of Solicitation and Proposal For Bids; Bid or Proposal, and the Bid Booklet
- (6) The Budget Director's Certificate; all Addenda issued prior to the receipt of the bids; the Notice of Award; Performance and Payment Bonds, if required; and the Notice to Proceed with the Work.

(B) For particulars as to this procurement, including quantity and quality of the purchase, extent of the work or labor to be performed, delivery and performance schedule, and any other special instructions, prospective bidders are referred to the Invitation For Bids Documents. A copy of such documents can be obtained in the PASSPort RFX.

5. Pre-Bid Conference

A pre-bid conference shall be held as set forth in the PASSPort RFX. Nothing stated at the pre-bid conference shall change the terms or conditions of the Invitation For Bids Documents, unless a change is made by written amendment as provided in Section 9 below. Failure to attend a mandatory pre-bid conference shall constitute grounds for the rejection of the bid.

6. Agency Contact

Any questions or correspondence relating to this bid solicitation shall be addressed to the Agency Contact person specified in the PASSPort RFX.

7. Bidder's Oath

- (A) The bid shall be properly signed by an authorized representative of the bidder and the bid shall be verified by the written oath of the authorized representative who signed the bid, that the several matters stated and information furnished therein are in all aspects true.
- (B) A materially false statement willfully or fraudulently made in connection with the bid or any of the forms completed and submitted with the bid may result in the termination of any Contract between the City and the Bidder. As a result, the Bidder may be barred from participating in future City contracts as well as be subject to possible criminal prosecution.

8. Examination and Viewing of Site, Consideration of Other Sources of Information and Changed Conditions

- (A) Pre-Bidding (Investigation) Viewing of Site - Bidders must carefully view and examine the site of the proposed work, as well as its adjacent area, and seek other usual sources of information, for they will be conclusively presumed to have full knowledge of any and all conditions on, about or above the site relating to or affecting in any way the performance of the work to be done under the Contract which were or should have been indicated to a reasonably prudent bidder. To arrange a date for visiting the work site, bidders are to contact the Agency Contact person specified in The PASSPort RFx.
- (B) Should the contractor encounter during the progress of the work subsurface conditions at the site materially differing from any shown on the Contract Drawings or indicated in the Specifications or such subsurface conditions as could not reasonably have been anticipated by the contractor and were not anticipated by the City, which conditions will materially affect the cost of the work to be done under the Contract, the attention of the Commissioner must be called immediately to such conditions before they are disturbed. The Commissioner shall thereupon promptly investigate the conditions. If the Commissioner finds that they do so materially differ, or that they could not reasonably have been anticipated by the contractor and were not anticipated by the City, the Contract may be modified with the Commissioner's written approval.

9. Examination of Proposed Contract

- (A) Request for Interpretation or Correction: Prospective bidders must examine the Contract Documents carefully and before bidding must request the Commissioner in writing for an interpretation or correction of every patent ambiguity, inconsistency or error therein which should have been discovered by a reasonably prudent bidder. Such interpretation or correction, as well as any additional contract provisions the Commissioner may decide to include, will be issued in writing by the Commissioner as an addendum to the Contract, which will be transmitted to each person recorded as having received a copy of the Contract Documents from the Department. Transmission of such addendum will be by mail, e-mail, facsimile or hand delivery. Such addendum will also be posted at the place where the Contract Documents are available for the inspection of prospective bidders. Upon transmission as provided for herein, such addendum shall become a part of the Contract Documents, and binding on all bidders, whether or not actual notice of such addendum is shown.
- (B) Only Commissioner's Interpretation or Correction Binding: Only the written interpretation or correction so given by the Commissioner shall be binding, and prospective bidders are warned that no other officer, agent or employee of the City is authorized to give information concerning, or to explain or interpret, the Contract.
- (C) Documents given to a subcontractor for the purpose of soliciting the subcontractor's bid shall include either a copy of the bid cover sheet or a separate information sheet setting forth the project name, the Contract number (if available), the contracting agency and the Project's location.

10. Form of Bid

Each bid must be submitted upon the prescribed form and must contain: a) the name, residence and place of business of the person or persons making the same; b) the names of all persons interested therein, and if no other person is so interested, such fact must be distinctly stated; c) a statement to the effect that it is made without any connection with any other person making a bid for the same purpose and that it is in all respects fair and without collusion or fraud; d) a statement that no Council member or other officer or employee or person whose salary is payable in whole or part from the City Treasury is directly or indirectly interested therein or in the supplies, materials or equipment and work or labor to which it relates, or in any portion of the profits thereof; e) a statement that the bidder is not in arrears to the City or to any agency upon a debt or contract or taxes, and is not a defaulter as surety or otherwise upon any obligation to the City to any agency thereof, except as set forth in the bid.

THE BID SHALL BE TYPEWRITTEN OR WRITTEN LEGIBLY IN INK. THE BID SHALL BE SIGNED IN INK. ERASURES OR ALTERATIONS SHALL BE INITIALED BY THE SIGNER IN INK. FAILURE TO CONFORM TO THE REQUIREMENTS OF THIS SECTION 10 SHALL RESULT IN THE REJECTION OF THE BID.

11. Irrevocability of Bid

The prices set forth in the bid cannot be revoked and shall be effective until the award of the Contract, unless the bid is withdrawn as provided for in Sections 15 and 18 below.

12. Acknowledgment of Amendments

The receipt of any amendment to the Contract Documents shall be acknowledged by the bidder in its bid submission.

13. Bid Samples and Descriptive Literature

Bid samples and descriptive literature shall not be submitted by the bidder, unless expressly requested elsewhere in the Contract or Contract Documents. Any unsolicited bid samples or descriptive literature which are submitted shall not be examined or tested and shall not be deemed to vary any of the provisions of this Contract.

14. Proprietary Information/Trade Secrets

- (A) The bidder shall identify those portions of the bid which it deems to be confidential, proprietary information or trade secrets, and provide justification why such materials shall not be disclosed by the City. All such materials shall be clearly indicated by stamping the pages on which such information appears, at the top and bottom thereof with the word "Confidential". Such materials stamped "Confidential" must be easily separable from the non-confidential sections of the bid.
- (B) All such materials so indicated shall be reviewed by the Agency and any decision not to honor a request for confidentiality shall be communicated in writing to the bidder. For those bids which are unsuccessful, all such confidential materials shall be returned to the bidder. Prices, makes and model or catalog numbers of the items offered, deliveries, and terms of payment shall be publicly available after bid opening, regardless of any designation of confidentiality made by the bidder.

15. Pre-Opening Modification or Withdrawal of Bids

Bids may be modified or withdrawn by written notice received in the office designated in the PASSPort RFx, before the time and date set for the bid opening. If a bid is withdrawn in accordance with this Section, the bid security, if any, shall be returned to the bidder.

16. Bid Evaluation and Award

In accordance with the New York City Charter, the Procurement Policy Board Rules and the terms and conditions of this Invitation For Bids, this Contract shall be awarded, if at all, to the responsible bidder whose bid meets the requirements and evaluation criteria set forth in the Invitation For Bids, and whose bid price is either the most favorable bid price or, if the Invitation For Bids so states, the most favorable evaluated bid price. A bid may not be evaluated for any requirement or criterion that is not disclosed in the Invitation For Bids.

Restriction: No negotiations with any bidder shall be allowed to take place except under the circumstances and in the manner set forth in Section 21. Nothing in this Section shall be deemed to permit a contract award to a bidder submitting a higher quality item than that designated in the Invitation For Bids, if that bid is not also the most favorable bid.

17. Late Bids, Late Withdrawals and Late Modifications

Any bid received at the place designated in the solicitation after the time and date set for receipt of bids is late and shall not be considered. Any request for withdrawal or modification received at the place designated in the solicitation after the time and date set for receipt of bids is late and shall not be considered. The exception to this provision is that a late modification of a successful bid that makes the bid terms more favorable to the City shall be considered at any time it is received.

18. Withdrawal of Bids.

Except as provided for in Section 15, above, a bidder may not withdraw its bid before the expiration of forty-five (45) days after the date of the opening of bids; thereafter, a bidder may withdraw its bid only in writing and in advance of an actual award. If within sixty (60) days after the execution of the Contract, the Commissioner fails to fix the date

for commencement of work by written notice to the bidder, the bidder at the bidder's option, may ask to be relieved of the bidder's obligation to perform the work called for by written notice to the Commissioner. If such notice is given to the Commissioner, and the request to withdraw is granted, the bidder waives all claims in connection with this Contract.

19. Mistake in Bids

(A) Mistake Discovered Before Bid Opening: A bidder may correct mistakes discovered before the time and date set for bid opening by withdrawing or correcting the bid as provided in Section 15 above.

(B) Mistakes Discovered Before Award

(1) In accordance with General Municipal Law (Section 103, subdivision 11), where a unilateral error or mistake is discovered in a bid, such bid may be withdrawn upon written approval of the Agency Chief Contracting Officer if the following conditions are met:

(a) The mistake is known or made known to the agency prior to the awarding of the Contract or within 3 days after the opening of the bid, whichever period is shorter; and

(b) The price bid was based upon an error of such magnitude that enforcement would be unconscionable; and

(c) The bid was submitted in good faith and the bidder submits credible evidence that the mistake was a clerical error as opposed to a judgment error; and

(d) The error in the bid is actually due to an unintentional and substantial arithmetic error or an unintentional omission of a substantial quantity of work, labor, material or services made directly in the compilation of the bid, which unintentional arithmetic error or unintentional omission can be clearly shown by objective evidence drawn from inspection of the original work paper, documents, or materials used in the preparation of the bid sought to be withdrawn; and

(e) It is possible to place the agency in the same position as existed prior to the bid.

(2) Unless otherwise required by law, the sole remedy for a bid mistake in accordance with this Article shall be withdrawal of the bid, and the return of the bid bond or other security, if any, to the bidder. Thereafter, the agency may, in its discretion, award the Contract to the next lowest bidder or rebid the Contract. Any amendment to or reformation of a bid or a Contract to rectify such an error or mistake therein is strictly prohibited.

(3) If the mistake and the intended correct bid are clearly evident on the face of the bid document, the bid shall be corrected to the intended correct bid and may not be withdrawn. Examples of mistakes that may be corrected are typographical errors, errors in extending unit prices, transposition errors and arithmetical errors.

20. Low Tie Bids

(A) When two or more low responsive bids from responsible bidders are identical in price, meeting all the requirements and criteria set forth in the Invitation For Bids, the Agency Chief Contracting Officer will break the tie in the following manner and order of priority:

(1) Award to a certified New York City small, minority or woman-owned business entity bidder;

(2) Award to a New York City bidder;

(3) Award to a certified New York State small, minority or woman-owned business bidder;

(4) Award to a New York State bidder.

(B) If two or more bidders still remain equally eligible after application of paragraph (A) above, award shall be made by a drawing by lot limited to those bidders. The bidders involved shall be invited to attend the drawing. A witness shall be present to verify the drawing and shall certify the results on the bid tabulation sheet.

21. Rejection of Bids

- (A) **Rejection of Individual Bids**: The Agency may reject a bid if:
- (1) The bidder fails to furnish any of the information required pursuant to Section 24 or 28 hereof; or if
 - (2) The bidder is determined to be not responsible pursuant to the Procurement Policy Board Rules; or if
 - (3) The bid is determined to be non-responsive pursuant to the Procurement Policy Board Rules; or if
 - (4) The bid, in the opinion of the Agency Chief Contracting Officer, contains unbalanced bid prices and is thus non-responsive, unless the bidder can show that the prices are not unbalanced for the probable required quantity of items, or if the imbalance is corrected pursuant to Section 15.
- (B) **Rejection of All Bids**: The Agency, upon written approval by the Agency Chief Contracting Officer, may reject all bids and may elect to resolicit bids if in its sole opinion it shall deem it in the best interest of the City so to do.
- (C) **Rejection of All Bids and Negotiation With All Responsible Bidders**: The Agency Head may determine that it is appropriate to cancel the Invitation For Bids after bid opening and before award and to complete the acquisition by negotiation. This determination shall be based on one of the following reasons:
- (1) All otherwise acceptable bids received are at unreasonable prices, or only one bid is received and the Agency Chief Contracting Officer cannot determine the reasonableness of the bid price, or no responsive bid has been received from a responsible bidder; or
 - (2) In the judgment of the Agency Chief Contracting Officer, the bids were not independently arrived at in open competition, were collusive, or were submitted in bad faith.
- (B) When the Agency has determined that the Invitation for Bids is to be canceled and that use of negotiation is appropriate to complete the acquisition, the contracting officer may negotiate and award the Contract without issuing a new solicitation, subject to the following conditions:
- (1) prior notice of the intention to negotiate and a reasonable opportunity to negotiate have been given by the contracting officer to each responsible bidder that submitted a bid in response to the Invitation for Bids;
 - (2) the negotiated price is the lowest negotiated price offered by a responsible bidder; and
 - (3) the negotiated price is lower than the lowest rejected bid price of a responsible bidder that submitted a bid in response to the Invitation for Bids.

22. Right to Appeal Determinations of Non-Responsiveness or Non-Responsibility and Right to Protest Solicitations and Award

The bidder has the right to appeal a determination of non-responsiveness or non-responsibility and has the right to protest a solicitation and award. For further information concerning these rights, the bidder is directed to the Procurement Policy Board Rules.

23. Affirmative Action and Equal Employment Opportunity

This Invitation For Bids is subject to applicable provisions of Federal, State and Local Laws and executive orders requiring affirmative action and equal employment opportunity.

24. PASSPort COMPLIANCE

All vendors that intend to do business with the City of New York must complete a disclosure process in order to be considered for a contract. This disclosure process was formerly completed using Vendor Information Exchange System (VENDEX) paper-based forms. The City of New York has moved collection of vendor disclosure information online. In early August 2017, the New York City Mayor's Office of Contract Services (MOCS) launched the Procurement and Sourcing Solutions Portal (PASSPort), a new online procurement system that replaced the paper-VENDEX process. In anticipation of awards, all bidders must create online accounts in the new PASSPort system, and

file all disclosure information using PASSPort. Paper submissions, including certifications of no changes to existing VENDEX packages, will not be accepted in lieu of complete online filings using PASSPort.

All vendors that intend to do business with the City, but specifically those that fall into any of the following categories, are required to enroll:

- Have a pending award with a City Agency; or
- Hold a current contract with a City Agency and have either an expiring VENDEX or expiring Certificate of No Change.

The Department of Design and Construction (DDC) and MOCS hereby notifies all proposers that the PASSPort system is available, and that disclosure filing completion is required prior to any award through this competitive bid.

To enroll in PASSPort and to access the PASSPort website (including online training), please visit www.nyc.gov/passport. Contact MOCS at passport@mocs.nyc.gov for additional information and technical support.

25. Complaints About the Bid Process

The New York City Comptroller is charged with the audit of contracts in New York City. Any vendor who believes that there has been unfairness, favoritism or impropriety in the bid process should inform the Comptroller, Office of Contract Administration, One Centre Street, Room 835, New York, New York; telephone number (212)669-2323.

26. Bid, Performance and Payment Security

(A) Bid Security: Each bid must be accompanied by bid security in an amount and type specified in the PASSPort RFX questionnaire. The bid security shall assure the City of New York of the adherence of the bidder to its proposal, the execution of the Contract, and the furnishing of Performance and Payment Bonds by the bidder, if required in the PASSPort RFX. Bid security shall be returned to the bidder as follows:

- (1) Within ten (10) days after the bid opening, the Comptroller will be notified to return the deposits of all but the three (3) lowest bidders. Within five (5) days after the award, the Comptroller will be notified to return the deposits of the remaining two unsuccessful bidders.
- (2) Within five (5) days after the execution of the Contract and acceptance of the Contractor's bonds, the Comptroller will be notified to return the bid security of the successful bidder or, if performance and payment bonds are not required, only after the sum retained under Article 21 of the Contract equals the amount of the bid security.
- (3) Where all bids are rejected, the Comptroller will be notified to return the deposit of the three (3) lowest bidders at the time of rejection.

(B) Performance and Payment Security: Performance and Payment Security must be provided in an amount and type specified in the PASSPort RFX. The performance and payment security shall be delivered by the contractor prior to or at the time of execution of the Contract. If a contractor fails to deliver the required performance and payment security, its bid security shall be enforced, and an award of Contract may be made to the next lowest responsible and responsive bidder, or the contract may be rebid.

(C) Acceptable Types of Security: Acceptable types of security for bids, performance, and payment shall be limited to the following:

- (1) a one-time bond in a form satisfactory to the City;
- (2) a bank certified check or money order;
- (3) obligations of the City of New York; or
- (4) other financial instruments as determined by the Office of Construction in consultation with the Comptroller.

Whenever the successful bidder deposits obligations of the City of New York as performance and payment security, the Comptroller may sell and use the proceeds thereof for any purpose for which the principal or

surety on such bond would be liable under the terms of the Contract. If the money is deposited with the Comptroller, the successful bidder shall not be entitled to receive interest on such money from the City.

- (D) Form of Bonds: Security provided in the form of bonds must be prepared on the form of bonds authorized by the City of New York. Forms for bid, performance, and payment bonds are included in the Invitation for Bids Documents. Such bonds must have as surety thereunder such surety company or companies as are: (1) approved by the City of New York; (2) authorized to do business in the State of New York, and (3) approved by the Department of the Treasury of the United States. Premiums for any required bonds must be included in the base bid.

The bidder is advised that submission of a bid bond where the surety on such bond fails to meet the criteria set forth herein, shall result in the rejection of the bid as non-responsive.

The Department of the Treasury of the United States advises that information concerning approved surety companies may be obtained as follows: (1) from the Government Printing Office at 215-364-6465; (2) through the Internet at <https://www.fiscal.treasury.gov/surety-bonds/>.

- (E) Power of Attorney: Attorneys in fact who sign bid, performance, or payment bonds must file with each bond a certified copy of their power of attorney to sign said bonds.

27. Failure to Execute Contract

In the event of failure of the successful bidder to execute the Contract and furnish the required security within ten (10) days after notice of the award of the Contract, the deposit of the successful bidder or so much thereof as shall be applicable to the amount of the award made shall be retained by the City, and the successful bidder shall be liable for and hereby agrees to pay on demand the difference between the price bid and the price for which such Contract shall be subsequently awarded, including the cost of any required reletting and less the amount of such deposit. No plea of mistake in such accepted bid shall be available to the bidder for the recovery of the deposit or as a defense to any action based upon such accepted bid. Further, should the bidder's failure to comply with this Section cause any funding agency, body or group (Federal, State, City, Public, Private, etc.) to terminate, cancel or reduce the funding on this project, the bidder in such event shall be liable also to the City for the amount of actual funding withdrawn by such agency on this project, less the amount of the forfeited deposit.

28. Bidder Responsibilities and Qualifications

- (A) Bidders must include with their bids all information necessary for a determination of bidder responsibility, as set forth in the Specifications.
- (B) The Agency may require any bidder or prospective bidder to furnish all books of account, records, vouchers, statements or other information concerning the bidder's financial status for examination as may be required by the Agency to ascertain the bidder's responsibility and capability to perform the Contract. If required, a bidder must also submit a sworn statement setting forth such information as the Agency may require concerning present and proposed plant and equipment, the personnel and qualifications of the bidder's working organizations, prior experience and performance record.
- (C) Oral Examination on Qualifications: In addition thereto, and when directed by the Agency, the bidder, or a responsible officer, agent or employee of the bidder, must submit to an oral examination to be conducted by the Agency in relation to the bidder's proposed tentative plan and schedule of operations, and such other matters as the Agency may deem necessary in order to determine the bidder's ability and responsibility to perform the work in accordance with the Contract. Each person so examined must sign and verify a stenographic transcript of such examination noting thereon such corrections as such person may desire to make.
- (D) If the bidder fails or refuses to supply any of the documents or information set forth in paragraph (B) hereof or fails to comply with any of the requirements thereof, the Agency may reject the bid.

29. Employment Report

In accordance with Executive Order No. 50 (1980) as modified by Executive Order 108 (1986), the filing of a

completed Employment Report (ER) is a requirement of doing business with the City of New York for construction contractors with contracts of \$1,000,000 or more and subcontractors with construction subcontracts of \$750,000 or more. The required forms and information are included in the PASSPort Vendor Profile.

30. Labor Law Requirements

- (A) General: The successful bidder will be required to comply strictly with all Federal, State and local labor laws and regulations.
- (B) New York State Labor Law: This Contract is subject to New York State Labor Law Section 220, which requires that construction workers on the site be paid prevailing wages and supplements. The Contractor is reminded that all wage provisions of this Contract will be enforced strictly and failure to comply will be considered when evaluating performance. Noncompliance may result in the contractor being debarred by the City from future contracts. Complaints filed with the Comptroller may result in decisions which may debar a contractor from bidding contracts with any state governmental entity and other political subdivisions.
- (C) Records: The Contractor is expected to submit accurate payroll reports and other required documents and verify attendance and job classifications being utilized in compliance with the law, Contract provisions and agency procedures.

31. Insurance

- (A) Bidders are advised that the insurance requirements contained herein are regarded as material terms of the Contract. As required by Article 22 of the Contract, the contractor must effect and maintain with companies licensed and authorized to do business in the State of New York, the types of insurance set forth therein, when required by and in the amounts set forth in Schedule A of the General Conditions. Such required insurance must be provided from the date the contractor is ordered to commence work and up to the date of final acceptance of all required work.
- (B) The contractor must, within ten days of receipt of the notice of award, submit the following insurance documentation: (a) original certificate of insurance for general liability in the amount required by Schedule A of the General Conditions, and (b) original certificates of insurance or other proof of coverage for workers' compensation and disability benefits, as required by Section 57 of the New York State Workers' Compensation Law and Section 220 of the Disability Benefits Law.

32. Lump Sum Contracts

- (A) Comparison of Bids: Bids on Lump Sum Contracts will be compared on the basis of the lump sum price bid, adjusted for alternate prices bid, if any.
- (B) Lump Sum Bids for "General Construction Work" which include excavation shall include all necessary excavation work defined in the Specifications as being included in the lump sum bid. The bidder shall also bid a unit price for the additional cost of excavating material which is defined in the Specifications as excavation for which additional payment will be made. The total estimated additional cost of removing such material will be taken as the quantity set forth in the Engineer's Estimate multiplied by the unit price bid. This total estimated cost of additional excavation shall be added to the lump sum bid for the General Construction Work for the purpose of comparing bids to determine the low bidder.
- (C) Variations from Engineer's Estimate: The Engineer's Estimate of the quantity of excavation for which additional payment will be made is approximate only and is given solely to be used as a uniform basis for the comparison of bids and such estimate is not to be considered as part of this contract. The quantities actually required to complete the contract work may be more or less than the quantities in the Engineer's Estimate and, if so, no action for damages or for loss of profits shall accrue to the contractor by reason thereof.

33. Unit Price Contracts

- (A) Comparison of Bids: Bids on Unit Price Contracts will be compared on the basis of a total estimated price,

arrived at by taking the sum of the estimated quantities of such items, in accordance with the Engineer's Estimate of Quantities set forth in the Bid Schedule, multiplied by the corresponding unit prices, and including any lump sum bids on individual items.

(B) Variations from Engineer's Estimate: Bidders are warned that the Engineer's Estimate of Quantities on the various items of work and materials is approximate only, given solely to be used as a uniform basis for the comparison of bids, and is not be considered part of this contract. The quantities actually required to complete the contract work may be less or more than so estimated, and if so, no action for damages or for loss of profits shall accrue to the contractor by reason thereof.

(C) Overruns: The terms and conditions applicable to overruns of unit price items are set forth in Article 26 of the Contract.

34. Excise Tax

Bidders are referred to the Specifications for information on Federal Excise Tax exemptions.

35. Licenses and Permits

The successful bidder will be required to obtain all necessary licenses and permits necessary to perform the work.

36. Multiple Prime Contractors

If more than one prime contractor will be involved on this project, all contractors are required to examine the Invitation for Bid packages for all other parts of the project.

37. Locally Based Enterprise Requirements (LBE)

This Contract is subject to the requirements of Administrative Code, Section 6-108.1, and the regulations promulgated thereunder. No construction contract will be awarded unless and until these requirements have been complied with in their entirety. The bidder is advised of the provisions set forth below, as well as the provisions with respect to the Locally Based Enterprise Program contained in Article 67 of the Contract. The contractor is advised that:

(A) If any portion of the Contract is subcontracted, not less than ten percent of the total dollar amount of the contract shall be awarded to locally based enterprises ("LBEs"); except, where less than ten percent of the total dollar amount of the Contract is subcontracted, such lesser percentage shall be so awarded.

(B) No contractor shall require performance and payment bonds from LBE subcontractors.

(C) No Contract shall be awarded unless the contractor first identifies in its bid:

(1) the percentage, dollar amount and type of work to be subcontracted; and

(2) the percentage, dollar amount and type of work to be subcontracted to LBEs.

(D) Within ten calendar days after notification of low bid, the apparent low bidder shall submit an "LBE Participation Schedule" to the contracting agency. If such schedule does not identify sufficient LBE subcontractors to meet the requirements of Administrative Code Section 6-108.1, the apparent low bidder shall submit documentation of its good faith efforts to meet such requirements.

(1) The "LBE Participation Schedule" shall include:

(a) the name and address of each LBE that will be given a subcontract,

(b) the percentage, dollar amount and type of work to be subcontracted to the LBE, and

(c) the dates when the LBE subcontract work will commence and end.

(2) The following documents shall be attached to the "LBE Participation Schedule":

(a) verification letters from each subcontractor listed in the "LBE Participation Schedule" stating that the LBE will enter into a formal agreement for work,

- (b) certification documents of any proposed LBE subcontractor which is not on the LBE certified list, and
 - (c) copies of the certification letter of any proposed subcontractor which is an LBE.
- (3) Documentation of good faith efforts to achieve the required LBE percentage shall include as appropriate but not limited to the following:
- (a) attendance at prebid meetings, when scheduled by the agency, to advise bidders of contract requirements;
 - (b) advertisement where appropriate in general circulation media, trade association publications and small business media of the specific subcontracts that would be at least equal to the percentage goal for LBE utilization specified by the contractor;
 - (c) written notification to association of small, minority and women contractors soliciting specific subcontractors;
 - (d) written notification by certified mail to LBE firms that their interest in the contract is solicited for specific work items and their estimated values;
 - (e) demonstration of efforts made to select portions of the work for performance by LBE firms in order to increase the likelihood of achieving the stated goal;
 - (f) documented efforts to negotiate with LBE firms for specific subcontracts, including at a minimum:
 - (i) The names, address and telephone numbers of LBE firms that are contacted;
 - (ii) A description of the information provided to LBE firms regarding the plans and specifications for portions of the work to be performed;
 - (iii) Documentation showing that no reasonable price can be obtained from LBE firms;
 - (iv) A statement of why agreements with LBE firms were not reached;
 - (g) a statement of the reason for rejecting any LBE firm which the contractor deemed to be unqualified; and
 - (h) documentation of efforts made to assist the LBE firms contacted that needed assistance in obtaining required insurance.
- (E) Unless otherwise waived by the Commissioner with the approval of the Office of Economic and Financial Opportunity, failure of a proposed contractor to provide the information required by paragraphs (C) and (D) above may render the bid non-responsive and the Contract may not be awarded to the bidder. If the contractor states that it will subcontract a specific portion of the work, but can demonstrate despite good faith efforts it cannot achieve its required LBE percentage for subcontracted work until after award of Contract, the Contract may be awarded, subject to a letter of compliance from the contractor stating that it will comply with Administrative Code Section 6-108.1 and subject to approval by the Commissioner. If the contractor has not met its required LBE percentage prior to award, the contractor shall demonstrate that a good faith effort has been made subsequent to award to obtain LBEs on each subcontract until it meets the required percentage.
- (F) When a bidder indicates prior to award that no work will be subcontracted, no work may be subcontracted without the prior written approval of the Commissioner, which shall be granted only if the contractor in good faith seeks LBE subcontractors at least six weeks prior to the start of work.
- (G) The contractor may not substitute or change any LBE which was identified prior to award of the contract without the written permission of the Commissioner. The contractor shall make a written application to the Commissioner for permission to make such substitution or change, explaining why the contractor needs to change its LBE subcontractor and how the contractor will meet its LBE subcontracting requirement. Copies of such application must be served on the originally identified LBE by certified mail return receipt requested,

as well as the proposed substitute LBE. The Commissioner shall determine whether or not to grant the contractor's request for substitution.

38. Bid Submission Requirements

The Bid Submission Requirements are set forth in the PASSPort RFx.

39. Comptroller's Certificate

This Contract shall not be binding or of any force unless it is registered by the Comptroller in accordance with Section 328 of the City Charter and the Procurement Policy Board Rules. This Contract shall continue in force only after annual appropriation of funds by the City of New York and certification as hereinabove set forth.

40. Procurement Policy Board Rules

This Invitation For Bids is subject to the Rules of the Procurement Policy Board of the City of New York. In the event of a conflict between said Rules and a provision of this Invitation For Bids, the Rules shall take precedence.

41. DDC Safety Requirements

The DDC Safety Requirements apply to the work to be performed pursuant to the Contract. The DDC Safety Requirements are set forth on the following pages.

THIS PAGE INTENTIONALLY LEFT BLANK

CITY OF NEW YORK
DEPARTMENT OF DESIGN AND CONSTRUCTION
SAFETY REQUIREMENTS FOR CONSTRUCTION
CONTRACTS

January 2020

THE DDC SAFETY REQUIREMENTS FOR CONSTRUCTION CONTRACTS INCLUDE THE FOLLOWING SECTIONS:

- I. POLICY ON SITE SAFETY**
- II. PURPOSE**
- III. DEFINITIONS**
- IV. RESPONSIBILITIES**
- V. SAFETY QUESTIONNAIRE**
- VI. SITE SAFETY PLAN**
- VII. KICK-OFF/PRE-CONSTRUCTION MEETINGS AND SAFETY REVIEW**
- VIII. EVALUATION DURING WORK IN PROGRESS**
- IX. SAFETY PERFORMANCE EVALUATION**

I. POLICY ON SITE SAFETY

The City of New York Department of Design and Construction (DDC) is committed to a policy of injury and illness prevention and risk management for construction work that will ensure the safety and health of the workers engaged in the projects and the protection of the general public. Therefore, it is DDC's policy that work carried out by Contractors on DDC contracts must, at a minimum, comply with the most current versions of all applicable federal, state and city laws, rules, and regulations, including without limitation:

- ❑ Code of Federal Regulations, Title 29, Part 1926 (29 CFR 1926) and applicable Sub-parts of Part 1910 – U.S. Occupational Safety and Health Administration (OSHA);
- ❑ Federal Highway Administration – Manual on Uniform Traffic Control Devices (MUTCD);
- ❑ New York Codes, Rules and Regulations (NYCRR), Title 12, Part 23 – Protection in Construction, Demolition and Excavation Operations;
- ❑ New York Codes, Rules and Regulations (NYCRR), Title 16, Part 753 – Protection of Underground Facilities;
- ❑ New York City Administrative Code, Title 28 – New York City Construction Codes;
- ❑ Rules of the City of New York, Title 15, Chapter 13 – Rules Pertaining To the Prevention of the Emission of Dust from Construction Related Activities;
- ❑ Rules of the City of New York, Title 15, Chapter 28 – Citywide Construction Noise Mitigation;
- ❑ Rules of the City of New York, Title 34 Chapter 2 – NYCDOT Highway Rules.

The Contractor will be required to comply with all new and/or revised federal, state and city laws, rules, and regulations, issued during the course of the project, at the expense of the Contractor without any additional costs to the DDC.

II. PURPOSE

The purpose of this policy is to ensure that Contractors perform their work and supervise their employees in accordance with all applicable federal, state and city rules and regulations. Further, Contractors will be expected to minimize or eliminate jobsite and public hazards, through a planning, inspection, auditing and corrective action process. The goal is to control risks so that injuries, illnesses, and accidents to contractors' employees, DDC employees and the general public, as well as damage to city-owned and private property, are reduced to the lowest level feasible.

III. DEFINITIONS

Agency Chief Contracting Officer (ACCO): The ACCO will mean the person delegated authority by the Commissioner to organize and supervise the procurement activity of subordinate Agency staff in conjunction with the City Chief Procurement Officer (CCPO).

Competent Person: As defined by OSHA, an individual who is capable of identifying existing and predictable hazards in the surroundings or working conditions that are unsanitary, hazardous, or dangerous to employees or the general public, and who has authorization to take prompt corrective measures to eliminate them. This individual will have completed, at a minimum an authorized 30-hour OSHA Construction Safety Course. The Contractor may be required to provide more than one competent person due to construction operations and based on the number of active work sites.

Construction Safety Auditor: A representative of the Office of Construction Safety who provides inspection and assessment services to enhance health and safety on all DDC construction projects. The activities of the Construction Safety Auditor include performing site audits, reviewing safety plans, reviewing construction permits, drawings, verifying Contractor's compliance with applicable federal, state and city laws, rules, regulations, and DDC Contract Safety Requirements, etc. and rendering technical advice and assistance to DDC Resident Engineers and Project Managers.

Office of Construction Safety: A unit of DDC Safety and Site Support that assesses contractor’s safety on DDC jobsites and advises responsible parties of needed corrective actions.

Registered Construction Superintendent: For certain projects, as defined in New York City Construction Codes – Title 28, the contractor will provide a Construction Superintendent registered with the NYC Department of Buildings and responsible for all duties as defined in Chapter 33 of Title 1 of the Rules of the City of New York.

Contractor: For purposes of these Safety Requirements, the term “Contractor” will mean any person or entity that enters into a contract for the performance of construction work on a DDC project. The term “Contractor” will include any person or entity which enters into any of the following types of contracts: (1) a prime construction contract for a specific project, (2) a prime construction contract using the Job Order Contracting System (“JOCS Contract”), and (3) a subcontract with a CM/Builder (“First Tier Subcontract”).

Daily Safety Job Briefing: Daily jobsite safety briefings, given to all jobsite personnel at project site by the Contractor before work begins and/or if hazards or potential hazards are discovered while working, with the purpose of discussing the scheduled activities for the day, the hazards related to these activities, activity specific safety procedures, and Job Hazard Analysis associated with the scheduled construction work. Daily jobsite briefings will be documented, available at the jobsite, and will include at a minimum, topics, name and signature of the person conducting the briefing session, names and signatures of attendants, name of the designated competent person, contractor’s name, DDC Project ID, date, time, and location.

Director – Office of Construction Safety: Responsible for the operations of the Office of Construction Safety and the DDC Site Safety management programs.

Job Hazard Analysis (JHA): A process of identifying the major job tasks and any potential site-specific hazards that may be present during construction and establishing the means and methods to eliminate or control those hazards. A JHA will be documented, available at the jobsite and will include at a minimum work tasks, being performed, identified hazards, control methods for the identified hazards, contractor’s name, DDC Project ID, location, date, name and signature of certifying person. A JHA is a living document that will be re-evaluated and revised to address new hazards and tasks that may develop and will be present at the worksite and produced upon request.

Qualified Person: As defined by OSHA, an individual who, by possession of a recognized degree, certificate, license, or professional standing, or who by extensive knowledge, training, and experience, has successfully demonstrated his or her ability to solve problems relating to the subject matter, the work, or the project. Qualified Persons are required under regulation to address issues pertaining, but without limit, to fall protection, scaffold design, maintenance and protection of traffic, and excavation protective system, among others.

Project Site: Those areas indicated in the Contract Documents where the Work is to be performed.

Project Safety Representative: The designated Project Safety Representative will have at a minimum an OSHA 30-hour Construction Safety Course and other safety training applicable to Contractor’s/subcontractor’s project work. This individual will be responsible to oversee safety performance of the required construction work, conduct documented daily safety inspections, and implement corrective actions to maintain a safe work site. The Project Safety Representative must have sufficient experience and skills necessary to thoroughly understand the health and safety hazards and controls and must have authority to undertake corrective actions. A dedicated full-time Project Safety Representative may be required on large projects and projects deemed by DDC to be particularly high risk. DDC reserves the right to request a dedicated full-time Project Safety Representative for any reason at any time during the course of the project at the expense of the Contractor without any additional costs to the DDC. The full-time Project Safety Representative will be present at the site during all work activities.

Resident Engineer (“RE”): Representative of the Commissioner duly designated by the Commissioner to be his/her representative at the site of the work. The RE may be a consultant retained by DDC, including a Construction Management (CM) or Resident Engineer Inspection (REI) firm. If DDC has retained a CM, REI or other consultant firm to perform management and oversight for the Project (e.g., CM-Builder, CM-Design-Builder, Project Manager, Program Manager), that CM, REI or other consultant is the Resident Engineer for purposes of these Safety Requirements.

Safety Questionnaire: Used by DDC to evaluate Contractor’s current and past safety performance. It is required to be completed by all Contractors initially when submitting bids for Construction work, or when being pre-qualified and updated annually or as requested by the DDC.

Site Safety Manager: For certain projects, as defined in New York City Construction Codes – Title 28, the Contractor will provide a Site Safety Manager with a Site Safety Manager License issued by the New York City Department of Building.

Site Safety Plan: A site-specific safety plan developed by the Contractor for a DDC project. The Site Safety Plan will identify the project work scope, identify hazards associated with the project work and include project specific safety procedures and training appropriate and necessary to complete the work. The Site Safety Plan will be submitted within 30 days from the Award Date or as otherwise directed and is subject to review and acceptance by the Office of Construction Safety prior to the commencement of work at the site.

Unsafe or Unhealthy Condition: A condition that could be potentially hazardous to the health and safety of personnel or the public, and/or damaging to equipment, machinery, property, or the environment.

Weekly Safety Meetings: Weekly jobsite safety meetings, given to all jobsite personnel by Contractor, with the purpose of discussing general safety topics and job specific requirements encountered at the DDC work site. Weekly safety meetings will be documented and will include at a minimum, topics, name and signature of the person conducting the meeting, names and signatures of attendees, contractor’s name, DDC Project ID, date, and location.

Work: The construction required by the Contractor’s Contract Documents whether completed or partially completed, performed by the Contractor/ subcontractors. Work refers to the furnishing of labor, furnishing and incorporating materials and equipment into the construction and providing any service required by the Contract Documents to fulfill the Contractor’s obligation to complete the Project. For the purposes of these Safety Requirements, the term “Work” includes all Utility Interference work (commonly referred to as “Section U”, “EP-7”, and “Joint Bid” work) performed in association with this Contract.

IV. RESPONSIBILITIES

All persons who manage, perform, and provide support for construction projects will conduct operations in compliance with the requirements identified in this Policy and all applicable governing regulatory agency requirements and guidelines pertaining to safety in construction.

A. Resident Engineer

1. Review and facilitate Contractor(s) Site Safety Plan submittals to DDC for acceptability.
2. Notify the Office of Construction Safety of the commencement of construction work.
3. Develop and implement a training verification process to ensure that all CM/REI, consultant, Contractor, and subcontractor employees are properly trained. Maintain all applicable initial and refresher training records and assures documentation availability on site.
4. Maintain documentation of and attend weekly safety meetings and daily safety job briefings.
5. Assure that Contractor(s) JHA’s are current to reflect the work tasks being performed, hazards, and control methods to mitigate the identified hazards. Verify that all employees at the job site are trained on the JHAs and maintain supporting documentation on site.
6. Assure adequate planning for all critical construction activities (crane operation, excavation, confined space entry, etc.) including coordination between Contractor(s) /DDC/ other Agencies as required.
7. Maintain custody of all construction related permits, plans, approvals, drawings, etc., related to the project and assure their availability on site.
8. Recognize, minimize, or eliminate jobsite and public hazards, through required planning, inspection, verification, and corrective action process.
9. Monitor the conditions at the site for conformance with the Contractor’s Site Safety Plan, DDC policies, permits, and all applicable regulations and documentation that pertain to construction safety.
10. Notify the Contractor and DDC immediately upon determination of any condition or activity existing which is not in compliance with the Contractor’s Site Safety Plan, applicable federal, state or local codes or any

condition that presents a potential risk of injury to the public or workers or possible damage to property. Direct the Contractor to provide such labor, materials, equipment, and supervision to remedy such conditions.

11. Notify the Office of Construction Safety and the ACCO's Insurance and Risk Management Unit of project-related accidents, incidents, and near misses as per DDC's Construction Safety Emergency and Accident Notification and Response Procedure within two (2) hours.
12. In case of an accident, incident, or near miss, RE is responsible to protect the integrity of the accident site including but not limited to: the safeguarding of all evidence, documentation of all personnel on site at the time of the accident, gather facts related to all accidents, incidents, or near miss, and prepare required DDC Construction Accident Report as per DDC's Construction Safety Emergency and Accident Notification and Response Procedure. Maintain all records pertaining to accidents, incidents, and near miss and have them available upon request.
13. Notify the Office of Construction Safety within two (2) hours of the start of an inspection by any outside/regulatory agency personnel, including NYS, OSHA, NYC DOB or any other City/State/Federal oversight entity and forward a copy of the inspection report within one business day of its receipt.
14. Escort and assist Construction Safety Auditors during all field and record audits.
15. Report any emergency conditions to the Office of Construction Safety immediately.

Note: In addition to the responsibilities listed above, if the Resident Engineer is a CM/REI or other non-City party hired by the City to manage the Project, the Resident Engineer is also required to do the following:

16. Provide personnel who are certified and or trained appropriately for the requirements of the project.
17. Perform an investigation for any project-related accidents, incidents, and near misses. Within 24-hours of the time of the accident, incident, or near miss, the CM/REI will submit an investigation report to the Office of Construction Safety. Such report will include proposed remedial measures and implementation of corrective actions to prevent recurrence.

DDC reserves the right to request that the CM/REI replace any CM/REI personnel for any reason at any time during the project.

B. Construction Contractors

Note: For CM-Build and CM-Design-Build Projects, the CM will meet all requirements listed in this section, as well as the Resident Engineer section above.

1. Submit a completed Safety Questionnaire and other safety performance related documentation with its bid or as part of a pre-qualification package.
2. Submit a Site Safety Plan within 30 days from the Award Date or as otherwise directed. The Site Safety Plan is subject to review and acceptance by the Office of Construction Safety prior to the commencement of work at the site. The Site Safety Plan will be revised and updated as necessary during the course of the project. If requested by the Office of Construction Safety, the Site Safety Plan must be developed and submitted for approval using a web-based system, the Site Safety Plan Application (SSP App).
3. Designate and identify a Project Safety Representative in the Site Safety Plan. The Contractor will immediately notify the Office of Construction Safety, in a form and manner acceptable to the Office of Construction Safety, of any permanent change to the designated Project Safety Representative. In the event the primary designated Project Safety Representative is temporary unable to perform his or her duties, an alternate Project Safety Representative will be provided. Resumes, outlining the qualification and experience for the Project Safety Representative (s) will be included in the Site Safety Plan and available upon request. DDC reserves the right to request the Contractor to replace a Project Safety Representative for any reason at any time during the course of the project.
4. Designate and identify a Competent Person(s) in the Site Safety Plan. Contractor/subcontractor may be required to provide more than one competent person due to construction operations and based on a number of work tasks/areas. DDC reserves the right to request the Contractor to replace a Competent Person or provide additional Competent Person(s) for any reason at any time during the course of the project. The Competent Person will be present at the site during all work activities.
5. For certain projects, as defined in New York City Construction Codes – Title 28, designate and identify the Licensed Site Safety Manager or Registered Construction Superintendent. Resumes, outlining the qualification and experience for the Licensed Site Safety Manager or Registered Construction Superintendent will be included in the Site Safety Plan and available upon request. The Contractor will immediately notify the Office

of Construction Safety, in a form and manner acceptable to the Office of Construction Safety, of any permanent change to the designated Site Safety Manager and/or Construction Superintendent. In the event the primary designated Site Safety Manager or Construction Superintendent is temporarily unable to perform his or her duties, an alternate Licensed Site Safety Manager and/or Registered Construction Superintendent will be provided. The Office of Construction Safety must be informed of such change. DDC reserves the right to request the Contractor to replace Site Safety Manager or Construction Superintendent for any reason at any time during the course of the project.

6. Develop a written Job Hazard Analysis (JHA) that identifies safety hazards and control methods for project specific work tasks. A preliminary JHA will be included in the Site Safety Plan submitted by the Contractor. A JHA is a living document that will be re-evaluated and revised to address new hazards and tasks that may develop during the course of the project and will be present at the worksite and produced upon request.
7. Develop project specific safety procedures to protect employees, general public, and property during all construction activities for the duration of the project.
8. Ensure that all employees are aware of the hazards associated with the project through documented formal and informal training and/or other communications. Conduct and document new employee and site-specific safety orientation for all Contractor and subcontractor personnel to review the hazards associated with the project as identified in the Site Safety Plan and the specific safety procedures and controls that will be used to protect workers, the general public and property. The Project Safety Representative will conduct this training prior to mobilization and if necessary during the course of the project. Documentation will be provided to the RE.
9. Prior to performing any work on DDC projects all Contractor's and subcontractor's employees will, at a minimum, have successfully completed, within the previous five calendar years, an OSHA 10-hour construction safety course.
All training records (OSHA 10-hour, flagger, scaffold, fall protection, confined space, etc.) will be provided to the RE prior to mobilization, included in the Site Safety Plan, kept current during the course of the project, and available for review.
10. Conduct and document weekly safety meetings and daily job briefing sessions for the duration of the project. Attendance at weekly safety meetings and daily job briefing sessions is mandatory. A written record of weekly safety meetings will be available upon request and job briefing sessions will be available at the worksite.
11. As part of the Site Safety Plan, prepare site specific procedures, such as maintenance and protection of traffic plan, steel erection plan, confined space program, fall protection plan, demolition plan, site specific emergency evacuation plan, etc. (if not otherwise provided in the contract documents) and comply with all of its provisions.
12. Have immediately available for review at the project site where actual construction activities are being performed all applicable documentation, including but not limited to: JHAs for work tasks being performed, all required training records, MPT plan (where applicable), Noise and Dust Mitigation Plans, excavation protective system drawings (where applicable), Emergency Evacuation plan, fall protection program (where applicable), confined space program (where applicable), all required permits, daily job briefing records, all required documentation for crane operation (where applicable), daily inspection checklist, scaffold and sidewalk drawings (when applicable), safety data sheets for chemicals in use.
13. Comply with all federal, state and local safety and health rules, laws, and regulations.
14. Comply with all provisions of the Site Safety Plan.
15. Provide, replace, and adequately maintain at or around the project site, suitable and sufficient signage, lights, barricades and enclosures (fences, sidewalk sheds, netting, bracing, etc.). The project specific MPT plan will be developed, implemented, and reviewed during the course of the project.
16. The Project Safety Representative will conduct daily safety inspections, document the inspection results, implement corrective actions for the identified hazards. Maintain the inspection records and have them available upon request.
17. **Report unsafe or unhealthy conditions to the RE as soon as practical, but no more than 24 hours after discovery, and take prompt actions to remove or abate such conditions. Should an imminent dangerous condition be discovered, Contractor will stop all work in the area of danger until corrections are made.**
18. Report all accidents, incidents and near misses involving injuries to workers or the general public, as well as property damage, to the RE within one (1) hour.
19. Following an accident or incident, unless otherwise directed, the Contractor will not remove or alter any equipment, structure, material, or evidence related to the accident or incident. Exception: Immediate emergency procedures taken to secure structures, temporary construction, operations, or equipment that pose a continued imminent danger or facilitate assistance for persons who are trapped or who have sustained bodily injury. Take

additional measures as necessary to secure the accident or incident site and to protect against any further injury or property damage.

20. The Contractor will perform an investigation into the root cause of the accident, incident, or near miss. Within 24 hours of an accident, incident, or near miss, the Contractor will prepare and submit to the RE a written investigation report detailing findings, corrective actions, and hazard mitigation implementation to prevent recurrence.
21. Notify the RE within two (2) hours of the start of an inspection by any outside regulatory agency personnel, including OSHA, NYC DOB, or others.
22. Maintain all records pertaining to all required safety compliance documents, accidents and incidents reports. DDC reserves the right to request copy of any records pertaining to the safety of the project and required by DDC and other federal, state, and city agencies, including but not limited to permits, training records, safety inspection records, drawings, equipment records, etc.
23. Cooperate with DDC Office of Construction Safety/ RE and address DDC recommendations on safety, which will in no way relieve the Contractor of its responsibilities for safety on the project. The Contractor has sole responsibility for safety.

V. SAFETY QUESTIONNAIRE

DDC requires that all Contractors provide information regarding their current and past safety performance and programs. This will be accomplished by the use of the DDC Safety Questionnaire. As a part of the bid submittal package, the contractor will submit a completed DDC Safety Questionnaire listing company workers' compensation experience modification rating and OSHA Incident Rates for the three (3) years prior to the date of the bid opening. DDC may request a Contractor to update its Questionnaire at any time or to provide more detailed information. The Contractor will provide the requested information within 15 days.

The following criteria will be used by DDC in reviewing the Contractor's responsibility, which will be based on the information provided on the questionnaire:

- Criteria 1: OSHA Injury and Illness Rates (I&IR) are no greater than the average for the industry (based on the most current Bureau of Labor Statistics data for the Contractors SIC code); and
- Criteria 2: Insurance workers compensation Experience Modification Rate (EMR) equal to or less than 1.0; and
- Criteria 3: Any willful violations issued by OSHA or NYC DOB within the last three (3) years; and
- Criteria 4: A fatality (worker or member of public) and injuries, requiring OSHA notification, experienced on or near Contractor's worksite within the last three (3) years; and
- Criteria 5: Past safety performance on DDC projects (accidents; status of site safety plan submittals; etc.)
- Criteria 6: OSHA violation history for the last three (3) years;
- Criteria 7: Contractor will provide OSHA Injury and Illness Records (currently OSHA 300 and 300A Logs) for the last three (3) years.

If the Contractor fails to meet the basic criteria listed above, the Office of Construction Safety may request, through the ACCO, more details concerning the Contractor's safety experience. DDC may request the Contractor to provide copies of, among other things, accident investigation reports, OSHA records, OSHA and NYC DOB citations, EPA citations and written corrective action plan.

VI. SITE SAFETY PLAN

Within thirty (30) days from the Award Date or as otherwise directed, the Contractor will submit the Site Safety Plan. The Site Safety Plan will identify project work scope, safety hazards associated with the project tasks, and include specific safety procedures and training appropriate and necessary to complete the work. The Site Safety Plan is subject to review and acceptance by the Office of Construction Safety prior to the commencement of work at the site. Due to the project work scope and project duration, the Office of Construction Safety may grant a conditional acceptance for a Site Safety Plan without all sections being complete. In a case of a "Conditional Acceptance" of a Site Safety Plan,

the Contractor will provide the remaining sections previously incomplete and/or not submitted for review and acceptance by the Office of Construction Safety prior to the commencement of the construction activities. The Office of Construction Safety reserves the right to withdraw the initial “Conditional Acceptance” if the Contractor fails to provide the remaining sections of a Site Safety Plan. Failure by the Contractor to submit an acceptable Site Safety Plan will be grounds for default.

Site Safety Plan requirements: The Site Safety Plan will be a written document and will apply to all project specific Contractor and subcontractor operations, and will have at a minimum, the following elements with each described in a separate section (It may be necessary to modify the basic format for certain unique or high-risk projects, such as tunnels or high-rise construction). All Site Safety Plan sections will be numbered in the order listed below. For sections, which are not applicable for the type of the work being performed by the Contractor on DDC project, the Contractor will in writing indicate “Not applicable based on the project work scope.” The Site Safety Plan will include Contractor’s name, DDC project ID, project location (s), and development and revision dates. The Site Safety Plan will include the sections, attachments, and appendixes provided in the Site Safety Plan. All pages of the Site Safety Plan will be numbered. If requested by the Office of Construction Safety, the Site Safety Plan must be developed and submitted for approval using a web-based system, the Site Safety Plan Application (SSP App).

1. Project Work Scope – Detailed information regarding work tasks that will be performed by Contractor and subcontractors under the project.
2. Responsibility and Organization – Contractor’s organization chart with responsible personnel for the project, including titles, names, contact information, roles, and responsibilities. All Contractor’s personnel required by the DDC Safety Requirements will be identified.
3. Safety Training and Education – OSHA 10 Hours training, requirements for daily safety briefings and weekly safety meetings, any work task specific training, responsible staff for implementation of training program for the project.
4. Job Hazard Analysis (JHA) – Project specific Job Hazard Analysis including work tasks, identified hazards, hazard control methods (administrative, engineering, PPE) to protect workers, property and general public, Contractor’s name, project id, location, name and signature of a certifying person, hazard assessment date.
5. Protection of Public – Project specific procedures covering safety of the general public during all project construction activities.
6. Hazard Corrective Actions - Procedures for hazard identification, including responsible person(s), frequency of safety inspections, implementation of corrective actions, safety inspection checklist.
7. Accident/Exposure Investigation – Project specific procedures for accident/incident/near miss investigation and implementation of corrective actions. Accident/incident/near miss notification procedure of DDC project staff (timer frame and responsible personnel).
8. Recording and Reporting Injuries – Procedures to meet 29 CFR 1904 requirements.
9. First Aid and Medical Attention – Responsible staff, location and inspection of First Aid kit, directions to local hospitals; emergency telephone numbers.
10. Project Specific Fire Protection and Prevention Program – Project specific procedures, including responsible staff, fire alarm system/methods, hot work procedures, etc.
11. Housekeeping Procedure.
12. Project Specific Illumination Procedure.
13. Project Specific Sanitation Procedure.
14. Personal Protective Equipment (PPE), including Respiratory Protection Program and Hearing Conservation Program, if required.
15. Hazard Communication Program – Contractor’s Hazard Communication Program, responsible staff; training; SDS records, project specific list of chemicals; location of the program and SDS records.
16. Means of Egress – Information regarding free and unobstructed egress from all parts of the building or structure; exit marking; maintenance of means of egress, etc.
17. Employee Emergency Action Plan – Project specific: responsible staff, emergency alarm system/devices, evacuation procedure, procedure to account for employees after evacuation, etc.
18. Evacuation Plan – Project specific evacuation plan (drawing/scheme) with exists and evacuation routes.
19. Ionizing/Nonionizing Radiation – Competent person, license and qualification requirements, type of radiation, employee’s exposure and protection, safety procedures, etc.

20. Material Handling, Storage, Use and Disposal – Project specific information regarding material storage, disposal, and handling: procedures, plan/drawings, etc.
21. Signs, Signals, and Barricades – Use of danger/warning signs, safety instruction signs, sidewalk closure and pedestrian fencing and barricades (if not included in the MPT plan), etc.
22. Tools – Hand and Power – Safety procedures for the type of tools to be used.
23. Scaffold – Project specific scaffold types, procedures, training requirements, scaffold drawings, designed, sealed, and signed by NYS Licensed Professional Engineer, or as otherwise directed; competent person, criteria for project specific scaffold, falling object protection, procedures for aerial lifts/scissor lifts.
24. Welding and Cutting – Project specific procedure for welding and cutting, including all necessary safety requirements such as fire prevention, personal protective equipment, hot work permits (if not covered by Contractor’s Fire Prevention and Protection program, FDNY certificate requirements).
25. Electrical Safety – Project specific procedures, including lock out-tag out.
26. Fall Protection – Project specific information regarding selected fall protection systems, fall protection plan, responsible staff.
27. Cranes, Derrick, Hoists, Elevators, Conveyors – project specific equipment information including type, rated load capacity, manufacture specification requirements, competent person, exposure to falling load, inspection, recordkeeping, clearance requirements, communication procedure, ground lines, permits.
28. Excavation Safety – Competent person; excavation procedures; project specific protective system, including drawings, designed, sealed, and signed by NYS Licensed Professional Engineer, or as otherwise directed.
29. Protection of Underground Facilities and Utilities Procedure, including responsible staff and responsibilities.
30. Concrete and Masonry Construction Procedures
31. Maintenance and Protection of Traffic Plan – Project specific MPT plan, designed, sealed, and signed by NYS Licensed Professional Engineer, or as otherwise directed; flagmen training, public safety, etc.
32. Steel Erection – Site specific erection plan, requirements for applicable written notifications, competent person, fall protection plan, training requirements, etc.
33. Demolition – Engineering survey, including written evidence, disconnection of all effected utilities, identification of all hazardous chemicals, materials, gases, etc., floor openings, chutes, inspection and maintenance of all stairs/passageways, removal of materials/debris/structural elements, lock out/tag out, competent person.
34. Blasting and the Use of Explosives – Project specific safety procedures, warning signs, training/qualification, transportation, storage and use of explosives, inspection.
35. Stairways and Ladders – Types of stairs and ladders, safety procedures, training requirements.
36. Alcohol and Drug Abuse Policy
37. Rodents and Vermin Controls
38. Toxic and Hazardous Substances – Safety procedures for substances that Contractor’s and subcontractor’s employees can be exposed on project.
39. Noise Mitigation Plan – Completed project specific Noise Mitigation Plan, and noise mitigation procedures.
40. Confined Space Program – Project specific Confined Space Program, responsible staff, training records, equipment information, rescue procedure, list of project specific confined spaces, forms.
41. Construction Vehicles/Heavy Equipment – Type of construction vehicles/heavy equipment to be used on site, procedures
42. Dust Mitigation Plan – Completed project specific Dust Mitigation Plan, and dust mitigation procedures.
43. Working Over and Near Water. Diving Operations – safety procedures including personal protective equipment, fall protection, rescue services, etc.

The most critical component of the Site Safety Plan is the Job Hazard Analysis (JHA) section. The JHA form is a written document prepared by the Contractor. The Contractor will conduct a site and task assessment to identify the tasks and any potential safety or environmental hazards related to performance of the work, eliminate or implement controls for the potential hazards, and identify proper personal protective equipment for the task. The JHA will be communicated to all Contractor/subcontractor personnel on site. The JHA will include safety hazard identification and controls to protect employees, general public, and property.

The initial JHA will be included in the Contractor’s Site Safety Plan and the current JHA form will be available at the construction site for reference. A JHA is a living document that will be re-evaluated and revised to address new hazards and tasks that may develop and will be present at the worksite and produced upon request.

VII. KICK-OFF MEETINGS/PRE-CONSTRUCTION AND SAFETY REVIEW

Prior to the start of construction activities on all DDC projects, RE will invite the Office of Construction Safety to the construction kick-off meeting. The Office of Construction Safety representative(s) will participate in this meeting with the Contractor and RE for the purpose of:

- A. Reviewing DDC Contract Safety Requirements
- B. Reviewing site-specific safety issues based on a project work scope, location, and any other factors which may impact safety of workers and general public.
- C. Reviewing the Site Safety Plan and JHA requirements.
- D. Reviewing Accident/Incident reporting and investigation procedures.
- E. Reviewing designated safety contacts, roles, and responsibilities.
- F. Discussing planned inspections and audits of the site by the Office of Construction Safety personnel.

VIII. EVALUATION DURING WORK IN PROGRESS

The Contractor's adherence to these Safety Requirements will be monitored throughout the project. This will be accomplished by the following:

- A. Use of a safety checklist by a representative of the Office of Construction Safety (or other designated DDC representative) and the RE during regular inspections and comprehensive audits of the job site. Field Exit Conferences will be held with the RE and Contractor Project Safety Representatives.
- B. The RE will continually monitor the safety and environmental performance of the Contractor's employees and work methods. Deficiencies will be brought to the attention of the Contractor's Project Safety Representative on site for immediate correction. The RE will maintain a written record of these deficiencies and have these records available upon request. Any critical deficiencies will be immediately reported to the Office of Construction Safety via telephone (718)391-1911.
- C. If the Contractor's safety performance during the project is not up to DDC standards (safety performance measure, accident/incident rate, etc.) the Director – Office of Construction Safety, or his/her designee will meet with the Contractor's Project Safety Representative and other representatives, the RE, and the DDC Environmental Specialist (if environmental issues are involved). The purpose of this meeting is to 1) determine the level of non-compliance; 2) explain and clarify the safety/environmental provisions; 3) agree on a future course of action to correct the deficiencies.
- D. If the deficiencies continue, the Commissioner may, without limitation, declare the Contractor in default.
- E. The Contractor will within 1 hour inform the RE of all accidents/incidents/near misses including all fatalities, any injuries to employees or members of the general public, and property damage (e.g., structural damage, equipment rollovers, utility damage, loads dropped from crane). The RE will notify the Office of Construction Safety as per DDC's Construction Safety Emergency and Accident Notification and Response Procedure and will maintain a record of all Contractor accidents/incidents for the project.
- F. The Contractor and the RE will notify the Office of Construction Safety within two (2) hours of the start of any NYS-DOL/ NYC-COSH/ OSHA/ EPA inspections.

IX. SAFETY PERFORMANCE EVALUATION

The Contractor's safety record, including accident/incident history and DDC safety inspection results, will be considered as part of the Contractor's performance evaluation at the conclusion of the project. Poor safety performance during the course of the project will be a reason to rate a Contractor unsatisfactory which may be reflected in the City's PASSPort system and will be considered for future procurement actions as set forth in the City's Procurement Policy Board Rules.

NOTICE TO BIDDERS

Please be advised that the following Riders to the March 2017 New York City Standard Construction Contract have been attached and incorporated in this Invitation for Bid:

- Rider regarding Non-Compensable Delays and Grounds for Extension;
- Rider regarding NYC Earned Safe and Sick Time Act.

Other than provisions specifically delineated in the Riders, all other terms of the March 2017 New York City Standard Construction Contract continue to apply in full force and effect.

**RIDER TO NEW YORK CITY STANDARD CONSTRUCTION CONTRACT (MARCH
2017) REGARDING NON-COMPENSABLE DELAYS AND GROUNDS FOR
EXTENSION**

The following provisions supersede the corresponding provisions in the March 2017 version of the New York City Standard Construction Contract:

1. Section **11.5.1** provides as follows:

11.5.1 The acts or omissions of public or government bodies (other than **City** agencies) or of any third parties who are disclosed in the **Contract Documents**, or those third parties who are ordinarily encountered or who are generally recognized as related to the **Work**, including but not limited to, **Other Contractors**, utilities or private enterprises;

2. Section **11.5.6** provides as follows:

11.5.6 Climatic conditions, storms, floods, droughts, tidal waves, fires, hurricanes, earthquakes, landslides or other catastrophes or acts of God; acts of war or of the public enemy or terrorist acts; disruption, outage or power failure caused by a utility's inability or failure to provide service, pandemics, epidemics, outbreaks of infectious disease or any other public health emergency; other states of emergency declared by the City, State or Federal government, quarantine restrictions, and freight embargoes; including the **City's** reasonable responses to any of the above; and

3. Section **13.3** provides as follows:

13.3 Grounds for Extension: If such application is made, the **Contractor** shall be entitled to an extension of time for delay in completion of the **Work** caused solely:

13.3.1 By any of the acts or omissions of the **City**, its officials, agents or employees set forth in Articles **11.4.1.1** through **11.4.1.9**; or

13.3.2 By or attributable to any of the items set forth in Articles **11.5.1** through **11.5.7**.

13.3.3 The **Contractor** shall, however, be entitled to an extension of time for such causes only for the number of **Days** of delay which the **ACCO** or the Board may determine to be due solely to such causes, and then only if the **Contractor** shall have strictly complied with all of the requirements of Articles 9 and 10.

NYC EARNED SAFE AND SICK TIME ACT CONTRACT RIDER

(To supersede Section 4.06 of the January 2018 Appendix A and Section 35.5 of the March 2017 Standard Construction Contract and to be attached to other City contracts and solicitations)

A. Introduction and General Provisions.

1. The Earned Safe and Sick Time Act (“ESSTA”), codified at Title 20, Chapter 8 of the New York City Administrative Code, also known as the “Paid Safe and Sick Leave Law,” requires covered employees (as defined in Admin. Code § 20-912) in New York City (“City”) to be provided with paid safe and sick time. Contractors of the City or of other governmental entities may be required to provide safe and sick time pursuant to the ESSTA. The ESSTA is enforced by the City’s Department of Consumer and Worker Protection (“DCWP”), which has promulgated 6 RCNY §§ 7-101 and 201 *et seq.* (“DCWP Rules”).

2. The Contractor agrees to comply in all respects with the ESSTA and the DCWP Rules, and as amended, if applicable, in the performance of this agreement. The Contractor further acknowledges that such compliance is a material term of this agreement and that failure to comply with the ESSTA in performance of this agreement may result in its termination.

3. The Contractor must notify (with a copy to DCWP at ComplianceMonitoring@dcwp.nyc.gov) the Agency Chief Contracting Officer of the City Agency or other entity with whom it is contracting in writing within 10 days of receipt of a complaint (whether oral or written) or notice of investigation regarding the ESSTA involving the performance of this agreement. Additionally, the Contractor must cooperate with DCWP’s guidance and must comply with DCWP’s subpoenas, requests for information, and other document demands as set forth in the ESSTA and the DCWP Rules. More information is available at <https://www1.nyc.gov/site/dca/about/paid-sick-leave-what-employers-need-to-know.page>.

4. Upon conclusion of a DCWP investigation, Contractor will receive a findings letter detailing any employee relief and civil penalties owed. Pursuant to the findings, Contractor will have the opportunity to settle any violations and cure the breach of this agreement caused by failure to comply with the ESSTA either i) without a trial by entering into a consent order or ii) appearing before an impartial judge at the City’s administrative tribunal. In addition to and notwithstanding any other rights and remedies available to the City, non-payment of relief and penalties owed pursuant to a consent order or final adjudication within 30 days of such consent order or final adjudication may result in the termination of this agreement without further opportunity to settle or cure the violations.

5. The ESSTA is briefly summarized below for the convenience of the Contractor. The Contractor is advised to review the ESSTA and the DCWP Rules in their entirety. The Contractor may go to www.nyc.gov/PaidSickLeave for resources for employers, such as Frequently Asked Questions, timekeeping tools and model forms, and an event calendar of upcoming presentations and webinars at which the Contractor can get more information about how to comply with the ESSTA and the DCWP Rules. The Contractor acknowledges that it is responsible for compliance with the ESSTA and the DCWP Rules notwithstanding any inconsistent language contained herein.

B. *Pursuant to the ESSTA and DCWP Rules: Applicability, Accrual, and Use.*

1. An employee who works within the City must be provided paid safe and sick time.¹ Employers with one hundred or more employees are required to provide 56 hours of safe and sick time for an employee each calendar year. Employers with fewer than one hundred employees are required to provide 40 hours of sick leave each calendar year. Employers must provide a minimum of one hour of safe and sick time for every 30 hours worked by an employee and compensation for such safe and sick time must be provided at the greater of the employee's regular hourly rate or the minimum wage at the time the paid safe or sick time is taken. Employers are not discouraged or prohibited from providing more generous safe and sick time policies than what the ESSTA requires.

2. Employees have the right to determine how much safe and sick time they will use, provided that an employer may set a reasonable minimum increment for the use of safe and sick time not to exceed four hours per day. For the use of safe time or sick time beyond the set minimum increment, an employer may set fixed periods of up to thirty minutes beyond the minimum increment. In addition, an employee may carry over up to 40 or 56 hours of unused safe and sick time to the following calendar year, provided that no employer is required to carry over unused paid safe and sick time if the employee is paid for such unused safe and sick time and the employer provides the employee with at least the legally required amount of paid safe and sick time for such employee for the immediately subsequent calendar year on the first day of such calendar year.

3. An employee entitled to safe and sick time pursuant to the ESSTA may use safe and sick time for any of the following:

a. such employee's mental illness, physical illness, injury, or health condition or the care of such illness, injury, or condition or such employee's need for medical diagnosis or preventive medical care;

b. such employee's care of a family member (an employee's child, spouse, domestic partner, parent, sibling, grandchild, or grandparent, the child or parent of an employee's spouse or domestic partner, any other individual related by blood to the employee, and any other individual whose close association with the employee is the equivalent of a family relationship) who has a mental illness, physical illness, injury or health condition or who has a need for medical diagnosis or preventive medical care;

¹ Pursuant to the ESSTA, if fewer than five employees work for the same employer, and the employer had a net income of less than one million dollars during the previous tax year, such employer has the option of providing such employees uncompensated safe and sick time.

c. closure of such employee's place of business by order of a public official due to a public health emergency;

d. such employee's need to care for a child whose school or childcare provider has been closed due to a public health emergency; or

e. when the employee or a family member has been the victim of a family offense matter, sexual offense, stalking, or human trafficking:

1. to obtain services from a domestic violence shelter, rape crisis center, or other shelter or services program for relief from a family offense matter, sexual offense, stalking, or human trafficking;
2. to participate in safety planning, temporarily or permanently relocate, or take other actions to increase the safety of the employee or employee's family members from future family offense matters, sexual offenses, stalking, or human trafficking;
3. to meet with a civil attorney or other social service provider to obtain information and advice on, and prepare for or participate in any criminal or civil proceeding, including but not limited to, matters related to a family offense matter, sexual offense, stalking, human trafficking, custody, visitation, matrimonial issues, orders of protection, immigration, housing, discrimination in employment, housing or consumer credit;
4. to file a complaint or domestic incident report with law enforcement;
5. to meet with a district attorney's office;
6. to enroll children in a new school; or
7. to take other actions necessary to maintain, improve, or restore the physical, psychological, or economic, health or safety of the employee or the employee's family member or to protect those who associate or work with the employee.

4. An employer must not require an employee, as a condition of taking safe and sick time, to search for a replacement. However, where the employee's need for safe and sick time is foreseeable, an employer may require an employee to provide reasonable notice of the need to use safe and sick time. For an absence of more than three consecutive work days, an employer may require reasonable documentation that the use of safe and sick time was needed for a reason listed in Admin. Code § 20-914; and/or written confirmation that an employee used safe and sick time pursuant to the ESSTA. However, an employer may not require documentation specifying the nature of a medical condition, require disclosure of the details of a medical condition, or require disclosure of the details of a family offense matter, sexual offense, stalking, or human trafficking, as a condition of providing safe and sick time. Health information and information concerning family offenses, sexual offenses, stalking or human trafficking obtained solely due to an

employee's use of safe and sick time pursuant to the ESSTA must be treated by the employer as confidential. An employer must reimburse an employee for all reasonable costs or expenses incurred in obtaining such documentation for the employer.

5. An employer must provide to all employees a written policy explaining its method of calculating sick time, policies regarding the use of safe and sick time (including any permissible discretionary conditions on use), and policies regarding carry-over of unused time at the end of the year, among other topics. It must provide the policy to employees using a delivery method that reasonably ensures that employees receive the policy. If such employer has not provided its written policy, it may not deny safe and sick time to an employee because of non-compliance with such a policy.

6. An employer must provide a pay statement or other form of written documentation that informs the employee of the amount of safe/sick time accrued and used during the relevant pay period and the total balance of the employee's accrued safe/sick time available for use.

7. Safe and sick time to which an employee is entitled must be paid no later than the payday for the next regular payroll period beginning after the safe and sick time was used.

C. *Exemptions and Exceptions.* Notwithstanding the above, the ESSTA does not apply to any of the following:

1. an independent contractor who does not meet the definition of employee under N.Y. Labor Law § 190(2);

2. an employee covered by a valid collective bargaining agreement, if the provisions of the ESSTA are expressly waived in such agreement and such agreement provides a benefit comparable to that provided by the ESSTA for such employee;

3. an audiologist, occupational therapist, physical therapist, or speech language pathologist who is licensed by the New York State Department of Education and who calls in for work assignments at will, determines their own schedule, has the ability to reject or accept any assignment referred to them, and is paid an average hourly wage that is at least four times the federal minimum wage;

4. an employee in a work study program under Section 2753 of Chapter 42 of the United States Code;

5. an employee whose work is compensated by a qualified scholarship program as that term is defined in the Internal Revenue Code, Section 117 of Chapter 20 of the United States Code; or

6. a participant in a Work Experience Program (WEP) under N.Y. Social Services Law § 336-c.

D. *Retaliation Prohibited.* An employer shall not take any adverse action against an employee that penalizes the employee for, or is reasonably likely to deter the employee from or interfere with the employee exercising or attempting in good faith to exercise any right provided by the ESSTA. In addition, an employer shall not interfere with any investigation, proceeding, or hearing pursuant to the ESSTA.

E. *Notice of Rights.*

1. An employer must provide its employees with written notice of their rights pursuant to the ESSTA. Such notice must be in English and the primary language spoken by an employee, provided that DCWP has made available a translation into such language. Downloadable notices are available on DCWP's website at <https://www1.nyc.gov/site/dca/about/Paid-Safe-Sick-Leave-Notice-of-Employee-Rights.page>. The notice must be provided to the employees by a method that reasonably ensures personal receipt by the employee.

2. Any person or entity that willfully violates these notice requirements is subject to a civil penalty in an amount not to exceed \$50.00 for each employee who was not given appropriate notice.

F. *Records.* An employer must retain records documenting its compliance with the ESSTA for a period of at least three years, and must allow DCWP to access such records in furtherance of an investigation related to an alleged violation of the ESSTA.

G. *Enforcement and Penalties.*

1. Upon receiving a complaint alleging a violation of the ESSTA, DCWP must investigate such complaint. DCWP may also open an investigation to determine compliance with the ESSTA on its own initiative. Upon notification of a complaint or an investigation by DCWP, the employer must provide DCWP with a written response and any such other information as DCWP may request. If DCWP believes that a violation of the ESSTA has occurred, it has the right to issue a notice of violation to the employer.

2. DCWP has the power to grant an employee or former employee all appropriate relief as set forth in Admin. Code § 20-924(d). Such relief may include, but is not limited to, treble damages for the wages that should have been paid; statutory damages for unlawful retaliation; and damages, including statutory damages, full compensation for wages and benefits lost, and reinstatement, for unlawful discharge. In addition, DCWP may impose on an employer found to have violated the ESSTA civil penalties not to exceed \$500.00 for a first violation, \$750.00 for a second violation within two years of the first violation, and \$1,000.00 for each succeeding violation within two years of the previous violation. When an employer has a policy or practice of not providing or refusing to allow the use of safe and sick time to its employees, DCWP may seek penalties and relief on a per employee basis.

3. Pursuant to Admin. Code § 20-924.2, (a) where reasonable cause exists to believe that an employer is engaged in a pattern or practice of violations of the ESSTA, the Corporation Counsel may commence a civil action on behalf of the City in a court of competent jurisdiction by filing a complaint setting forth facts relating to such pattern or practice and requesting relief, which may include injunctive relief, civil penalties and any other appropriate relief. Nothing in § 20-924.2 prohibits DCWP from exercising its authority under section 20-924 or the Charter, provided that a civil action pursuant to § 20-924.2 shall not have previously been commenced.

H. *More Generous Policies and Other Legal Requirements.* Nothing in the ESSTA is intended to discourage, prohibit, diminish, or impair the adoption or retention of a more generous safe and sick time policy, or the obligation of an employer to comply with any contract, collective bargaining agreement, employment benefit plan or other agreement providing more generous safe and sick time. The ESSTA provides minimum requirements pertaining to safe and sick time and does not preempt, limit, or otherwise affect the applicability of any other law, regulation, rule, requirement, policy or standard that provides for greater accrual or use by employees of safe and sick leave or time, whether paid or unpaid, or that extends other protections to employees. The ESSTA may not be construed as creating or imposing any requirement in conflict with any federal or state law, rule or regulation.

CITY OF NEW YORK

STANDARD CONSTRUCTION CONTRACT

March 2017

(NO TEXT ON THIS PAGE)

CITY OF NEW YORK STANDARD CONSTRUCTION CONTRACT

TABLE OF CONTENTS

(NO TEXT ON THIS PAGE) 6

CHAPTER I: THE CONTRACT AND DEFINITIONS 7

ARTICLE 1. THE CONTRACT.....7

ARTICLE 2. DEFINITIONS.....7

CHAPTER II: THE WORK AND ITS PERFORMANCE 10

ARTICLE 3. CHARACTER OF THE WORK10

ARTICLE 4. MEANS AND METHODS OF CONSTRUCTION.....10

ARTICLE 5. COMPLIANCE WITH LAWS11

ARTICLE 6. INSPECTION16

ARTICLE 7. PROTECTION OF WORK AND OF PERSONS AND PROPERTY; NOTICES AND INDEMNIFICATION.....17

CHAPTER III: TIME PROVISIONS 18

ARTICLE 8. COMMENCEMENT AND PROSECUTION OF THE WORK.....18

ARTICLE 9. PROGRESS SCHEDULES18

ARTICLE 10. REQUESTS FOR INFORMATION OR APPROVAL.....19

ARTICLE 11. NOTICE OF CONDITIONS CAUSING DELAY AND DOCUMENTATION OF DAMAGES CAUSED BY DELAY19

ARTICLE 12. COORDINATION WITH OTHER CONTRACTORS23

ARTICLE 13. EXTENSION OF TIME FOR PERFORMANCE24

ARTICLE 14. COMPLETION AND FINAL ACCEPTANCE OF THE WORK.....27

ARTICLE 15. LIQUIDATED DAMAGES28

ARTICLE 16. OCCUPATION OR USE PRIOR TO COMPLETION.....29

CHAPTER IV: SUBCONTRACTS AND ASSIGNMENTS 29

ARTICLE 17. SUBCONTRACTS29

ARTICLE 18. ASSIGNMENTS31

CHAPTER V: CONTRACTOR'S SECURITY AND GUARANTEE 32

ARTICLE 19. SECURITY DEPOSIT.....32

ARTICLE 20. PAYMENT GUARANTEE.....32

ARTICLE 21. RETAINED PERCENTAGE35

ARTICLE 22. INSURANCE.....35

ARTICLE 23. MONEY RETAINED AGAINST CLAIMS.....41

ARTICLE 24. MAINTENANCE AND GUARANTY42

CHAPTER VI: CHANGES, EXTRA WORK, AND DOCUMENTATION OF CLAIM 43

ARTICLE 25. CHANGES43

ARTICLE 26. METHODS OF PAYMENT FOR OVERRUNS AND EXTRA WORK.....43

ARTICLE 27. RESOLUTION OF DISPUTES46

ARTICLE 28. RECORD KEEPING FOR EXTRA OR DISPUTED WORK OR WORK ON A TIME & MATERIALS BASIS50

ARTICLE 29. OMITTED WORK.....51

ARTICLE 30. NOTICE AND DOCUMENTATION OF COSTS AND DAMAGES; PRODUCTION OF FINANCIAL RECORDS51

CHAPTER VII: POWERS OF THE RESIDENT ENGINEER, THE ENGINEER OR ARCHITECT

AND THE COMMISSIONER	52
ARTICLE 31. THE RESIDENT ENGINEER	52
ARTICLE 32. THE ENGINEER OR ARCHITECT OR PROJECT MANAGER.....	53
ARTICLE 33. THE COMMISSIONER.....	53
ARTICLE 34. NO ESTOPPEL	54
CHAPTER VIII: LABOR PROVISIONS	54
ARTICLE 35. EMPLOYEES.....	54
ARTICLE 36. NO DISCRIMINATION.....	61
ARTICLE 37. LABOR LAW REQUIREMENTS.....	63
ARTICLE 38. PAYROLL REPORTS.....	68
ARTICLE 39. DUST HAZARDS	69
CHAPTER IX: PARTIAL AND FINAL PAYMENTS	69
ARTICLE 40. CONTRACT PRICE.....	69
ARTICLE 41. BID BREAKDOWN ON LUMP SUM	69
ARTICLE 42. PARTIAL PAYMENTS.....	70
ARTICLE 43. PROMPT PAYMENT.....	70
ARTICLE 44. SUBSTANTIAL COMPLETION PAYMENT	71
ARTICLE 45. FINAL PAYMENT.....	72
ARTICLE 46. ACCEPTANCE OF FINAL PAYMENT	73
ARTICLE 47. APPROVAL BY PUBLIC DESIGN COMMISSION.....	73
CHAPTER X: CONTRACTOR'S DEFAULT.....	74
ARTICLE 48. COMMISSIONER'S RIGHT TO DECLARE CONTRACTOR IN DEFAULT	74
ARTICLE 49. EXERCISE OF THE RIGHT TO DECLARE DEFAULT	75
ARTICLE 50. QUITTING THE SITE	75
ARTICLE 51. COMPLETION OF THE WORK	75
ARTICLE 52. PARTIAL DEFAULT	76
ARTICLE 53. PERFORMANCE OF UNCOMPLETED WORK.....	76
ARTICLE 54. OTHER REMEDIES	76
CHAPTER XI: MISCELLANEOUS PROVISIONS	77
ARTICLE 55. CONTRACTOR'S WARRANTIES	77
ARTICLE 56. CLAIMS AND ACTIONS THEREON	77
ARTICLE 57. INFRINGEMENT	78
ARTICLE 58. NO CLAIM AGAINST OFFICIALS, AGENTS OR EMPLOYEES	78
ARTICLE 59. SERVICE OF NOTICES.....	78
ARTICLE 60. UNLAWFUL PROVISIONS DEEMED STRICKEN FROM CONTRACT.....	78
ARTICLE 61. ALL LEGAL PROVISIONS DEEMED INCLUDED.....	79
ARTICLE 62. TAX EXEMPTION.....	79
ARTICLE 63. INVESTIGATION(S) CLAUSE.....	80
ARTICLE 64. TERMINATION BY THE CITY.....	82
ARTICLE 65. CHOICE OF LAW, CONSENT TO JURISDICTION AND VENUE	85
ARTICLE 66. PARTICIPATION IN AN INTERNATIONAL BOYCOTT.....	85
ARTICLE 67. LOCALLY BASED ENTERPRISE PROGRAM.....	86
ARTICLE 68. ANTITRUST	87
ARTICLE 69. MacBRIDE PRINCIPLES PROVISIONS.....	87
ARTICLE 70. ELECTRONIC FILING/NYC DEVELOPMENT HUB.....	89
ARTICLE 71. PROHIBITION OF TROPICAL HARDWOODS.....	89
ARTICLE 72. CONFLICTS OF INTEREST	89

ARTICLE 73. MERGER CLAUSE89

ARTICLE 74. STATEMENT OF WORK89

ARTICLE 75. COMPENSATION TO BE PAID TO CONTRACTOR.....90

ARTICLE 76. ELECTRONIC FUNDS TRANSFER.....90

ARTICLE 77. RECORDS RETENTION.....90

**ARTICLE 78. EXAMINATION AND VIEWING OF SITE, CONSIDERATION OF OTHER
SOURCES OF INFORMATION AND CHANGED SITE CONDITIONS90**

**ARTICLE 79. PARTICIPATION BY MINORITY-OWNED AND WOMEN-OWNED BUSINESS
ENTERPRISES IN CITY PROCUREMENT91**

PERFORMANCE BOND #199

PERFORMANCE BOND #2.....103

PAYMENT BOND107

(NO TEXT ON THIS PAGE)

WITNESSETH:

The parties, in consideration of the mutual agreements contained herein, agree as follows:

CHAPTER I: THE CONTRACT AND DEFINITIONS

ARTICLE 1. THE CONTRACT

1.1 Except for titles, subtitles, headings, running headlines, tables of contents and indices (all of which are printed herein merely for convenience), the following, except for such portions thereof as maybe specifically excluded, shall be deemed to be part of this **Contract**:

1.1.1 All provisions required by law to be inserted in this **Contract**, whether actually inserted or not;

1.1.2 The Contract Drawings and Specifications;

1.1.3 The General Conditions and Special Conditions, if any;

1.1.4 The **Contract**;

1.1.5 The Information for Bidders; Request for Proposals; Notice of Solicitation and Proposal For Bids; Bid or Proposal, and, if used, the Bid Booklet;

1.1.6 All Addenda issued prior to the receipt of the bids; the Notice of Award; Performance and Payment Bonds, if required; and the Notice to Proceed or the Order to Work.

1.2 Should any conflict occur in or between the Drawings and Specifications, the **Contractor** shall be deemed to have estimated the most expensive way of doing the **Work**, unless the **Contractor** shall have asked for and obtained a decision in writing from the **Commissioner** of the **Agency** that is entering into this **Contract**, before the submission of its bid, as to what shall govern.

ARTICLE 2. DEFINITIONS

2.1 The following words and expressions, or pronouns used in their stead, shall, wherever they appear in this Contract, be construed as follows, unless a different meaning is clear from the context:

2.1.1 “**Addendum**” or “**Addenda**” shall mean the additional Contract provisions and/or technical clarifications issued in writing by the Commissioner prior to the receipt of bids.

2.1.2 “**Agency**” shall mean a city, county, borough or other office, position, department, division, bureau, board or commission, or a corporation, institution or agency of government, the expenses of which are paid in whole or in part from the City treasury.

2.1.3 “**Agency Chief Contracting Officer**” (**ACCO**) shall mean a person delegated authority by the Commissioner to organize and supervise the procurement activity of subordinate Agency staff in conjunction with the CCPO, or his/her duly authorized representative.

2.1.4 **“Allowance”** shall mean a sum of money which the Agency may include in the total amount of the Contract for such specific contingencies as the Agency believes may be necessary to complete the Work, *e.g.*, lead or asbestos remediation, and for which the Contractor will be paid on the basis of stipulated unit prices or a formula set forth in the Contract or negotiated between the parties provided, however, that if the Contractor is not directed to use the Allowance, the Contractor shall have no right to such money and it shall be deducted from the total amount of the Contract.

2.1.5 **“City”** shall mean the City of New York.

2.1.6 **“City Chief Procurement Officer” (CCPO)** shall mean a person delegated authority by the Mayor to coordinate and oversee the procurement activity of Mayoral agency staff, including the ACCO and any offices which have oversight responsibility for the procurement of construction, or his/her duly authorized representative.

2.1.7 **“Commissioner”** shall mean the head of the Agency that has entered into this Contract, or his/her duly authorized representative.

2.1.8 **“Comptroller”** shall mean the Comptroller of the City of New York.

2.1.9 **“Contract”** or **“Contract Documents”** shall mean each of the various parts of the contract referred to in Article 1 hereof, both as a whole and severally.

2.1.10 **“Contract Drawings”** shall mean only those drawings specifically entitled as such and listed in the Specifications or in any Addendum, or any drawings furnished by the Commissioner, pertaining or supplemental thereto.

2.1.11 **“Contract Work”** shall mean everything required to be furnished and done by the Contractor by any one or more of the parts of the Contract referred to in Article 1, except Extra Work as hereinafter defined.

2.1.12 **“Contractor”** shall mean the entity which executed this Contract, whether a corporation, firm, partnership, joint venture, individual, or any combination thereof, and its, their, his/her successors, personal representatives, executors, administrators, and assigns, and any person, firm, partnership, joint venture, individual, or corporation which shall at any time be substituted in the place of the Contractor under this Contract.

2.1.13 **“Days”** shall mean calendar days, except where otherwise specified.

2.1.14 **“Engineer”** or **“Architect”** or **“Project Manager”** shall mean the person so designated in writing by the Commissioner in the Notice to Proceed or the Order to Work to act as such in relation to this Contract, including a private Architect or Engineer or Project Manager, as the case may be. Subject to written approval by the Commissioner, the Engineer, Architect or Project Manager may designate an authorized representative.

2.1.15 **“Engineering Audit Officer” (EAO)** shall mean the person so designated by the Commissioner to perform responsible auditing functions hereunder.

2.1.16 **“Extra Work”** shall mean Work other than that required by the Contract at the time of award which is authorized by the Commissioner pursuant to Chapter VI of this Contract.

- 2.1.17 **“Federal-Aid Contract”** shall mean a contract in which the United States (federal) Government provides financial funding as so designated in the Information for Bidders.
- 2.1.18 **“Final Acceptance”** shall mean final written acceptance of all the Work by the Commissioner, a copy of which shall be sent to the Contractor.
- 2.1.19 **“Final Approved Punch List”** shall mean a list, approved pursuant to Article 14.2.2, specifying those items of Work to be completed by the Contractor after Substantial Completion and dates for the completion of each item of Work.
- 2.1.20 **“Law” or “Laws”** shall mean the Constitution of the State of New York, the New York City Charter, the New York City Administrative Code, a statute of the United States or of the State of New York, a local law of the City of New York, any ordinance, rule or regulation having the force of law, or common law.
- 2.1.21 **“Materialman”** shall mean any corporation, firm, partnership, joint venture, or individual, other than employees of the Contractor, who or which contracts with the Contractor or any Subcontractor, to fabricate or deliver, or who actually fabricates or delivers, plant, materials or equipment to be incorporated in the Work.
- 2.1.22 **“Means and Methods of Construction”** shall mean the labor, materials, temporary structures, tools, plant, and construction equipment, and the manner and time of their use, necessary to accomplish the result intended by this Contract.
- 2.1.23 **“Notice to Proceed” or “Order to Work”** shall mean the written notice issued by the Commissioner specifying the time for commencement of the Work and the Engineer, Architect or Project Manager.
- 2.1.24 **“Other Contractor(s)”** shall mean any contractor (other than the entity which executed this Contract or its Subcontractors) who or which has a contract with the City for work on or adjacent to the building or Site of the Work.
- 2.1.25 **“Payroll Taxes”** shall mean State Unemployment Insurance (SUI), Federal Unemployment Insurance (FUI), and payments pursuant to the Federal Insurance Contributions Act (FICA).
- 2.1.26 **“Project”** shall mean the public improvement to which this Contract relates.
- 2.1.27 **“Procurement Policy Board” (PPB)** shall mean the Agency of the City of New York whose function is to establish comprehensive and consistent procurement policies and rules which shall have broad application throughout the City.
- 2.1.28 **“Required Quantity”** in a unit price Contract shall mean the actual quantity of any item of Work or materials which is required to be performed or furnished in order to comply with the Contract.
- 2.1.29 **“Resident Engineer”** shall mean the representative of the Commissioner duly designated by the Commissioner to be his/her representative at the site of the Work.
- 2.1.30 **“Site”** shall mean the area upon or in which the Contractor’s operations are carried on, and such other areas adjacent thereto as may be designated as such by the Engineer.
- 2.1.31 **“Small Tools”** shall mean items that are ordinarily required for a worker’s job

function, including but not limited to, equipment that ordinarily has no licensing, insurance or substantive storage costs associated with it; such as circular and chain saws, impact drills, threaders, benders, wrenches, socket tools, etc.

2.1.32 “**Specifications**” shall mean all of the directions, requirements, and standards of performance applying to the Work as hereinafter detailed and designated under the Specifications.

2.1.33 “**Subcontractor**” shall mean any person, firm or corporation, other than employees of the Contractor, who or which contracts with the Contractor or with its subcontractors to furnish, or actually furnishes labor, or labor and materials, or labor and equipment, or superintendence, supervision and/or management at the Site. Wherever the word Subcontractor appears, it shall also mean sub-Subcontractor.

2.1.34 “**Substantial Completion**” shall mean the written determination by the Engineer that the Work required under this Contract is substantially, but not entirely, complete and the approval of the **Final Approved Punch List**.

2.1.35 “**Work**” shall mean all services required to complete the Project in accordance with the Contract Documents, including without limitation, labor, material, superintendence, management, administration, equipment, and incidentals, and obtaining any and all permits, certifications and licenses as may be necessary and required to complete the Work, and shall include both Contract Work and Extra Work.

CHAPTER II: THE WORK AND ITS PERFORMANCE

ARTICLE 3. CHARACTER OF THE WORK

3.1 Unless otherwise expressly provided in the **Contract Drawings, Specifications, and Addenda**, the **Work** shall be performed in accordance with the best modern practice, utilizing, unless otherwise specified in writing, new and unused materials of standard first grade quality and workmanship and design of the highest quality, to the satisfaction of the **Commissioner**.

ARTICLE 4. MEANS AND METHODS OF CONSTRUCTION

4.1 Unless otherwise expressly provided in the **Contract Drawings, Specifications, and Addenda**, the **Means and Methods of Construction** shall be such as the **Contractor** may choose; subject, however, to the **Engineer’s** right to reject the **Means and Methods of Construction** proposed by the **Contractor** which in the opinion of the **Engineer**:

4.1.1 Will constitute or create a hazard to the **Work**, or to persons or property; or

4.1.2 Will not produce finished **Work** in accordance with the terms of the **Contract**; or

4.1.3 Will be detrimental to the overall progress of the **Project**.

4.2 The **Engineer’s** approval of the **Contractor’s Means and Methods of Construction**, or his/her failure to exercise his/her right to reject such means or methods, shall not relieve the **Contractor** of its obligation to complete the **Work** as provided in this **Contract**; nor shall the exercise of such right to reject

create a cause of action for damages.

ARTICLE 5. COMPLIANCE WITH LAWS

5.1 The **Contractor** shall comply with all **Laws** applicable to this **Contract** and to the **Work** to be done hereunder.

5.2 Procurement Policy Board Rules: This **Contract** is subject to the Rules of the **PPB** (“**PPB Rules**”) in effect at the time of the bid opening for this **Contract**. In the event of a conflict between the **PPB Rules** and a provision of this **Contract**, the **PPB Rules** shall take precedence.

5.3 Noise Control Code provisions.

5.3.1 In accordance with the provisions of Section 24-216(b) of the Administrative Code of the **City** (“Administrative Code”), Noise Abatement Contract Compliance, devices and activities which will be operated, conducted, constructed or manufactured pursuant to this **Contract** and which are subject to the provisions of the **City** Noise Control Code shall be operated, conducted, constructed, or manufactured without causing a violation of the Administrative Code. Such devices and activities shall incorporate advances in the art of noise control development for the kind and level of noise emitted or produced by such devices and activities, in accordance with regulations issued by the **Commissioner** of the **City** Department of Environmental Protection.

5.3.2 The **Contractor** agrees to comply with Section 24-219 of the Administrative Code and implementing rules codified at 15 Rules of the City of New York (“RCNY”) Section 28-100 *et seq.* In accordance with such provisions, the **Contractor**, if the **Contractor** is the responsible party under such regulations, shall prepare and post a Construction Noise Mitigation Plan at each **Site**, in which the **Contractor** shall certify that all construction tools and equipment have been maintained so that they operate at normal manufacturers operating specifications. If the **Contractor** cannot make this certification, it must have in place an Alternative Noise Mitigation Plan approved by the **City** Department of Environmental Protection. In addition, the **Contractor**’s certified Construction Noise Mitigation Plan is subject inspection by the **City** Department of Environmental Protection in accordance with Section 28-101 of Title 15 of RCNY. No **Contract Work** may take place at a **Site** unless there is a Construction Noise Mitigation Plan or approved Alternative Noise Mitigation Plan in place. In addition, the **Contractor** shall create and implement a noise mitigation training program. Failure to comply with these requirements may result in fines and other penalties pursuant to the applicable provisions of the Administrative Code and RCNY.

5.4 Ultra Low Sulfur Diesel Fuel: In accordance with the provisions of Section 24-163.3 of the Administrative Code, the **Contractor** specifically agrees as follows:

5.4.1 Definitions. For purposes of this Article 5.4, the following definitions apply:

5.4.1(a) “Contractor” means any person or entity that enters into a Public Works Contract with a **City Agency**, or any person or entity that enters into an agreement with such person or entity, to perform work or provide labor or services related to such Public Works Contract.

5.4.1(b) “Motor Vehicle” means any self-propelled vehicle designed for transporting

persons or property on a street or highway.

5.4.1(c) “Nonroad Engine” means an internal combustion engine (including the fuel system) that is not used in a Motor Vehicle or a vehicle used solely for competition, or that is not subject to standards promulgated under Section 7411 or Section 7521 of Title 42 of the United States Code, except that this term shall apply to internal combustion engines used to power generators, compressors or similar equipment used in any construction program or project.

5.4.1(d) “Nonroad Vehicle” means a vehicle that is powered by a Nonroad Engine, fifty (50) horsepower and greater, and that is not a Motor Vehicle or a vehicle used solely for competition, which shall include, but not be limited to, excavators, backhoes, cranes, compressors, generators, bulldozers, and similar equipment, except that this term shall not apply to horticultural maintenance vehicles used for landscaping purposes that are powered by a Nonroad Engine of sixty-five (65) horsepower or less and that are not used in any construction program or project.

5.4.1(e) “Public Works Contract” means a contract with a **City Agency** for a construction program or project involving the construction, demolition, restoration, rehabilitation, repair, renovation, or abatement of any building, structure, tunnel, excavation, roadway, park or bridge; a contract with a **City Agency** for the preparation for any construction program or project involving the construction, demolition, restoration, rehabilitation, repair, renovation, or abatement of any building, structure, tunnel, excavation, roadway, park or bridge; or a contract with a **City Agency** for any final work involved in the completion of any construction program or project involving the construction, demolition, restoration, rehabilitation, repair, renovation, or abatement of any building, structure, tunnel, excavation, roadway, park or bridge.

5.4.1(f) “Ultra Low Sulfur Diesel Fuel” means diesel fuel that has a sulfur content of no more than fifteen parts per million (15 ppm).

5.4.2 Ultra Low Sulfur Diesel Fuel

5.4.2(a) All **Contractors** shall use Ultra Low Sulfur Diesel Fuel in diesel-powered Nonroad Vehicles in the performance of this **Contract**.

5.4.2(b) Notwithstanding the requirements of Article 5.4.2(a), **Contractors** may use diesel fuel that has a sulfur content of no more than thirty parts per million (30 ppm) to fulfill the requirements of this Article 5.4.2, where the Commissioner of the **City Department of Environmental Protection** (“DEP Commissioner”) has issued a determination that a sufficient quantity of Ultra Low Sulfur Diesel Fuel is not available to meet the needs of **Agencies** and **Contractors**. Any such determination shall expire after six (6) months unless renewed.

5.4.2(c) **Contractors** shall not be required to comply with this Article 5.4.2 where the **City Agency** letting this **Contract** makes a written finding, which is approved, in writing, by the DEP Commissioner, that a sufficient quantity of Ultra Low Sulfur Diesel Fuel, or diesel fuel that has a sulfur content of no more than thirty parts per million (30 ppm) is not available to meet the requirements of Section 24-163.3 of the Administrative Code, provided that such **Contractor** in its fulfillment of the requirements of this **Contract**, to the extent practicable, shall use whatever quantity of Ultra Low Sulfur Diesel Fuel or diesel fuel that has a sulfur content of no more than thirty parts per

million (30 ppm) is available. Any finding made pursuant to this Article 5.4.2(c) shall expire after sixty (60) **Days**, at which time the requirements of this Article 5.4.2 shall be in full force and effect unless the **City Agency** renews the finding in writing and such renewal is approved by the DEP Commissioner.

5.4.2(d) **Contractors** may check on determinations and approvals issued by the DEP Commissioner pursuant to Section 24-163.3 of the Administrative Code, if any, at www.dep.nyc.gov or by contacting the **City Agency** letting this **Contract**.

5.4.2(e) The requirements of this Article 5.4.2 do not apply where they are precluded by federal or State funding requirements or where the **Contract** is an emergency procurement.

5.4.3 Best Available Technology

5.4.3(a) All **Contractors** shall utilize the best available technology for reducing the emission of pollutants for diesel-powered Nonroad Vehicles in the performance of this **Contract**. For determinations of best available technology for each type of diesel-powered Nonroad Vehicle, **Contractors** shall comply with the regulations of the **City Department of Environmental Protection**, as and when adopted, Chapter 14 of Title 15 of the Rules of the City of New York (RCNY). The **Contractor** shall fully document all steps in the best available technology selection process and shall furnish such documentation to the **City Agency** or the DEP Commissioner upon request. The **Contractor** shall retain all documentation generated in the best available technology selection process for as long as the selected best available technology is in use.

5.4.3(b) No **Contractor** shall be required to replace best available technology for reducing the emission of pollutants or other authorized technology utilized for a diesel-powered Nonroad Vehicle in accordance with the provisions of this Article 5.4.3 within three (3) years of having first utilized such technology for such vehicle.

5.4.3(c) This Article 5.4.3 shall not apply to any vehicle used to satisfy the requirements of a specific Public Works Contract for fewer than twenty (20) **Days**.

5.4.3(d) The **Contractor** shall not be required to comply with this Article 5.4.3 with respect to a diesel-powered Nonroad Vehicle under the following circumstances:

5.4.3(d)(i) Where the **City Agency** makes a written finding, which is approved, in writing, by the DEP Commissioner, that the best available technology for reducing the emission of pollutants as required by this Article 5.4.3 is unavailable for such vehicle, the **Contractor** shall use whatever technology for reducing the emission of pollutants, if any, is available and appropriate for such vehicle.

5.4.3(d)(ii) Where the DEP Commissioner has issued a written waiver based upon the Contractor having demonstrated to the DEP Commissioner that the use of the best available technology for reducing the emission of pollutants might endanger the operator of such vehicle or those working near such vehicle, due to engine malfunction, the **Contractor** shall use whatever technology for reducing the emission of pollutants, if any, is available and appropriate for such vehicle, which would not endanger the operator of such vehicle or those working near such vehicle.

5.4.3(d)(iii) In determining which technology to use for the purposes of Articles 5.4.3(d)(i) and 5.4.3(d)(ii) above, the **Contractor** shall primarily consider the reduction in emissions of particulate matter and secondarily consider the reduction in emissions of nitrogen oxides associated with the use of such technology, which shall in no event result in an increase in the emissions of either such pollutant.

5.4.3(d)(iv) The **Contractor** shall submit requests for a finding or a waiver pursuant to this Article 5.4.3(d) in writing to the DEP Commissioner, with a copy to the **ACCO** of the **City Agency** letting this **Contract**. Any finding or waiver made or issued pursuant to Articles 5.4.3(d)(i) and 5.4.3(d)(ii) above shall expire after one hundred eighty (180) **Days**, at which time the requirements of Article 5.4.3(a) shall be in full force and effect unless the **City Agency** renews the finding, in writing, and the DEP Commissioner approves such finding, in writing, or the DEP Commissioner renews the waiver, in writing.

5.4.3(e) The requirements of this Article 5.4.3 do not apply where they are precluded by federal or State funding requirements or where the **Contract** is an emergency procurement.

5.4.4 Section 24-163 of the Administrative Code. The **Contractor** shall comply with Section 24-163 of the Administrative Code related to the idling of the engines of motor vehicles while parking.

5.4.5 Compliance

5.4.5(a) The **Contractor's** compliance with Article 5.4 may be independently monitored. If it is determined that the **Contractor** has failed to comply with any provision of Article 5.4, any costs associated with any independent monitoring incurred by the **City** shall be reimbursed by the **Contractor**.

5.4.5(b) Any **Contractor** who violates any provision of Article 5.4, except as provided in Article 5.4.5(c) below, shall be liable for a civil penalty between the amounts of one thousand (\$1,000) and ten thousand (\$10,000) dollars, in addition to twice the amount of money saved by such **Contractor** for failure to comply with Article 5.4.

5.4.5(c) No **Contractor** shall make a false claim with respect to the provisions of Article 5.4 to a **City Agency**. Where a **Contractor** has been found to have done so, such **Contractor** shall be liable for a civil penalty of twenty thousand (\$20,000) dollars, in addition to twice the amount of money saved by such **Contractor** in association with having made such false claim.

5.4.6 Reporting

5.4.6(a) For all Public Works Contracts covered by this Article 5.4, the **Contractor** shall report to the **City Agency** the following information:

5.4.6(a)(i) The total number of diesel-powered Nonroad Vehicles used to fulfill the requirements of this Public Works Contract;

5.4.6(a)(ii) The number of such Nonroad Vehicles that were powered by Ultra Low Sulfur Diesel Fuel;

5.4.6(a)(iii) The number of such Nonroad Vehicles that utilized the best available technology for reducing the emission of pollutants, including a breakdown by vehicle model and the type of technology;

5.4.6(a)(iv) The number of such Nonroad Vehicles that utilized such other authorized technology in accordance with Article 5.4.3, including a breakdown by vehicle model and the type of technology used for each such vehicle;

5.4.6(a)(v) The locations where such Nonroad Vehicles were used; and

5.4.6(a)(vi) Where a determination is in effect pursuant to Article 5.4.2(b) or 5.4.2(c), detailed information concerning the **Contractor's** efforts to obtain Ultra Low Sulfur Diesel Fuel or diesel fuel that has a sulfur content of no more than thirty parts per million (30 ppm).

5.4.6(b) The **Contractor** shall submit the information required by Article 5.4.6(a) at the completion of **Work** under the Public Works Contract and on a yearly basis no later than August 1 throughout the term of the Public Works Contract. The yearly report shall cover **Work** performed during the preceding fiscal year (July 1 - June 30).

5.5 Ultra Low Sulfur Diesel Fuel. In accordance with the Coordinated Construction Act for Lower Manhattan, as amended:

5.5.1 Definitions. For purposes of this Article 5.5, the following definitions apply:

5.5.1(a) "Lower Manhattan" means the area to the south of and within the following lines: a line beginning at a point where the United States pierhead line in the Hudson River as it exists now or may be extended would intersect with the southerly line of West Houston Street in the Borough of Manhattan extended, thence easterly along the southerly side of West Houston Street to the southerly side of Houston Street, thence easterly along the southerly side of Houston Street to the southerly side of East Houston Street, thence northeasterly along the southerly side of East Houston Street to the point where it would intersect with the United States pierhead line in the East River as it exists now or may be extended, including tax lots within or immediately adjacent thereto.

5.5.1(b) "Lower Manhattan Redevelopment Project" means any project in Lower Manhattan that is funded in whole or in part with federal or State funding, or any project intended to improve transportation between Lower Manhattan and the two air terminals in the **City** known as LaGuardia Airport and John F. Kennedy International Airport, or between Lower Manhattan and the air terminal in Newark known as Newark Liberty International Airport, and that is funded in whole or in part with federal funding.

5.5.1(c) "Nonroad Engine" means an internal combustion engine (including the fuel system) that is not used in a Motor Vehicle or a vehicle used solely for competition, or that is not subject to standards promulgated under Section 7411 or Section 7521 of Title 42 of the United States Code, except that this term shall apply to internal combustion engines used to power generators, compressors or similar equipment used in any construction program or project.

5.5.1(d) "Nonroad Vehicle" means a vehicle that is powered by a Nonroad Engine, fifty (50) horsepower (HP) and greater, and that is not a Motor Vehicle or a vehicle used

solely for competition, which shall include, but not be limited to, excavators, backhoes, cranes, compressors, generators, bulldozers, and similar equipment, except that this terms shall not apply to horticultural maintenance vehicles used for landscaping purposes that are powered by a Nonroad Engine of sixty-five (65) HP or less and that are not used in any construction program or project.

5.5.1(e) "Ultra Low Sulfur Diesel Fuel" means diesel fuel that has a sulfur content of no more than fifteen parts per million (15 ppm).

5.5.2 Requirements. **Contractors** and **Subcontractors** are required to use only Ultra Low Sulfur Diesel Fuel to power the diesel-powered Nonroad Vehicles with engine HP rating of fifty (50) HP and above used on a Lower Manhattan Redevelopment Project and, where practicable, to reduce the emission of pollutants by retrofitting such Nonroad Vehicles with oxidation catalysts, particulate filters, or technology that achieves lowest particulate matter emissions.

5.6 Pesticides. In accordance with Section 17-1209 of the Administrative Code, to the extent that the **Contractor** or any **Subcontractor** applies pesticides to any property owned or leased by the **City**, the **Contractor**, and any **Subcontractor** shall comply with Chapter 12 of the Administrative Code.

5.7 Waste Treatment, Storage, and Disposal Facilities and Transporters. In connection with the **Work**, the **Contractor** and any **Subcontractor** shall use only those waste treatment, storage, and disposal facilities and waste transporters that possess the requisite license, permit or other governmental approval necessary to treat, store, dispose, or transport the waste, materials or hazardous substances.

5.8 Environmentally Preferable Purchasing. The **Contractor** shall ensure that products purchased or leased by the **Contractor** or any **Subcontractor** for the **Work** that are not specified by the **City** or are submitted as equivalents to a product specified by the **City** comply with the requirements of the New York City Environmentally Preferable Purchasing Program contained in Chapter 11 of Title 43 of the RCNY, pursuant to Chapter 3 of Title 6 of the Administrative Code.

ARTICLE 6. INSPECTION

6.1 During the progress of the **Work** and up to the date of **Final Acceptance**, the **Contractor** shall at all times afford the representatives of the **City** every reasonable, safe, and proper facility for inspecting all **Work** done or being done at the **Site** and also for inspecting the manufacture or preparation of materials and equipment at the place of such manufacture or preparation.

6.2 The **Contractor's** obligation hereunder shall include the uncovering or taking down of finished **Work** and its restoration thereafter; provided, however, that the order to uncover, take down and restore shall be in writing, and further provided that if **Work** thus exposed proves satisfactory, and if the **Contractor** has complied with Article 6.1, such uncovering or taking down and restoration shall be considered an item of **Extra Work** to be paid for in accordance with the provisions of Article 26. If the **Work** thus exposed proves unsatisfactory, the **City** has no obligation to compensate the **Contractor** for the uncovering, taking down or restoration.

6.3 Inspection and approval by the **Commissioner**, the **Engineer**, **Project Manager**, or **Resident Engineer**, of finished **Work** or of **Work** being performed, or of materials and equipment at the place of manufacture or preparation, shall not relieve the **Contractor** of its obligation to perform the **Work** in strict accordance with the **Contract**. Finished or unfinished **Work** not found to be in strict accordance with the

Contract shall be replaced as directed by the **Engineer**, even though such **Work** may have been previously approved and paid for. Such corrective **Work** is **Contract Work** and shall not be deemed **Extra Work**.

6.4 Rejected **Work** and materials shall be promptly taken down and removed from the **Site**, which must at all times be kept in a reasonably clean and neat condition.

ARTICLE 7. PROTECTION OF WORK AND OF PERSONS AND PROPERTY; NOTICES AND INDEMNIFICATION

7.1 During the performance of the **Work** and up to the date of **Final Acceptance**, the **Contractor** shall be under an absolute obligation to protect the finished and unfinished **Work** against any damage, loss, injury, theft and/or vandalism and in the event of such damage, loss, injury, theft and/or vandalism, it shall promptly replace and/or repair such **Work** at the **Contractor's** sole cost and expense, as directed by the **Resident Engineer**. The obligation to deliver finished **Work** in strict accordance with the **Contract** prior to **Final Acceptance** shall be absolute and shall not be affected by the **Resident Engineer's** approval of, or failure to prohibit, the **Means and Methods of Construction** used by the **Contractor**.

7.2 During the performance of the **Work** and up to the date of **Final Acceptance**, the **Contractor** shall take all reasonable precautions to protect all persons and the property of the **City** and of others from damage, loss or injury resulting from the **Contractor's**, and/or its **Subcontractors'** operations under this **Contract**. The **Contractor's** obligation to protect shall include the duty to provide, place or replace, and adequately maintain at or about the **Site** suitable and sufficient protection such as lights, barricades, and enclosures.

7.3 The **Contractor** shall comply with the notification requirements set forth below in the event of any loss, damage or injury to **Work**, persons or property, or any accidents arising out of the operations of the **Contractor** and/or its **Subcontractors** under this **Contract**.

7.3.1 The **Contractor** shall make a full and complete report in writing to the **Resident Engineer** within three (3) **Days** after the occurrence.

7.3.2 The **Contractor** shall also send written notice of any such event to all insurance carriers that issued potentially responsive policies (including commercial general liability insurance carriers for events relating to the **Contractor's** own employees) no later than twenty (20) days after such event and again no later than twenty (20) days after the initiation of any claim and/or action resulting therefrom. Such notice shall contain the following information: the number of the insurance policy, the name of the Named Insured, the date and location of the incident, and the identity of the persons injured or property damaged. For any policy on which the **City** and/or the **Engineer, Architect, or Project Manager** are Additional Insureds, such notice shall expressly specify that "this notice is being given on behalf of the City of New York as Additional Insured, such other Additional Insureds, as well as the Named Insured."

7.3.2(a) Whenever such notice is sent under a policy on which the **City** is an Additional Insured, the **Contractor** shall provide copies of the notice to the **Comptroller, the Commissioner** and the **City Corporation Counsel**. The copy to the **Comptroller** shall be sent to the Insurance Unit, NYC Comptroller's Office, 1 Centre Street – Room 1222, New York, New York, 10007. The copy to the **Commissioner** shall be sent to the address set forth in Schedule A of the General Conditions. The copy to the **City Corporation Counsel** shall be sent to Insurance Claims Specialist, Affirmative Litigation

Division, New York City Law Department, 100 Church Street, New York, New York 10007.

7.3.2(b) If the **Contractor** fails to provide any of the foregoing notices to any appropriate insurance carrier(s) in a timely and complete manner, the **Contractor** shall indemnify the **City** for all losses, judgments, settlements, and expenses, including reasonable attorneys' fees, arising from an insurer's disclaimer of coverage citing late notice by or on behalf of the **City**.

7.4 To the fullest extent permitted by law, the **Contractor** shall defend, indemnify, and hold the **City**, its employees, and officials (the "Indemnitees") harmless against any and all claims (including but not limited to claims asserted by any employee of the **Contractor** and/or its **Subcontractors**) and costs and expenses of whatever kind (including but not limited to payment or reimbursement of attorneys' fees and disbursements) allegedly arising out of or in any way related to the operations of the **Contractor** and/or its **Subcontractors** in the performance of this **Contract** or from the **Contractor's** and/or its **Subcontractors'** failure to comply with any of the provisions of this **Contract** or of the **Law**. Such costs and expenses shall include all those incurred in defending the underlying claim and those incurred in connection with the enforcement of this Article 7.4 by way of cross-claim, third-party claim, declaratory action or otherwise. The parties expressly agree that the indemnification obligation hereunder contemplates (1) full indemnity in the event of liability imposed against the Indemnitees without negligence and solely by reason of statute, operation of **Law** or otherwise; and (2) partial indemnity in the event of any actual negligence on the part of the Indemnitees either causing or contributing to the underlying claim (in which case, indemnification will be limited to any liability imposed over and above that percentage attributable to actual fault whether by statute, by operation of **Law**, or otherwise). Where partial indemnity is provided hereunder, all costs and expenses shall be indemnified on a pro rata basis.

7.4.1 Indemnification under Article 7.4 or any other provision of the **Contract** shall operate whether or not **Contractor** or its **Subcontractors** have placed and maintained the insurance specified under Article 22.

7.5 The provisions of this Article 7 shall not be deemed to create any new right of action in favor of third parties against the **Contractor** or the **City**.

CHAPTER III: TIME PROVISIONS

ARTICLE 8. COMMENCEMENT AND PROSECUTION OF THE WORK

8.1 The **Contractor** shall commence the **Work** on the date specified in the **Notice to Proceed** or the **Order to Work**. The time for performance of the **Work** under the **Contract** shall be computed from the date specified in the **Notice to Proceed** or the **Order to Work**. **TIME BEING OF THE ESSENCE** to the **City**, the **Contractor** shall thereafter prosecute the **Work** diligently, using such **Means and Methods of Construction** as are in accord with Article 4 herein and as will assure its completion not later than the date specified in this **Contract**, or on the date to which the time for completion may be extended.

ARTICLE 9. PROGRESS SCHEDULES

9.1 To enable the **Work** to be performed in an orderly and expeditious manner, the **Contractor**, within fifteen (15) **Days** after the **Notice to Proceed** or **Order to Work**, unless otherwise directed by the **Engineer**, shall submit to the **Engineer** a proposed progress schedule based on the Critical Path Method in the form of

a bar graph or in such other form as specified by the **Engineer**, and monthly cash flow requirements, showing:

9.1.1 The anticipated time of commencement and completion of each of the various operations to be performed under this **Contract**; and

9.1.2 The sequence and interrelation of each of these operations with the others and with those of other related contracts; and

9.1.3 The estimated time required for fabrication or delivery, or both, of all materials and equipment required for the **Work**, including the anticipated time for obtaining required approvals pursuant to Article 10; and

9.1.4 The estimated amount in dollars the **Contractor** will claim on a monthly basis.

9.2 The proposed schedule shall be revised as directed by the **Engineer**, until finally approved by the **Engineer**, and after such approval, subject to the provisions of Article 11, shall be strictly adhered to by the **Contractor**.

9.3 If the **Contractor** shall fail to adhere to the approved progress schedule, or to the schedule as revised pursuant to Article 11, it shall promptly adopt such other or additional **Means and Methods of Construction**, at its sole cost and expense, as will make up for the time lost and will assure completion in accordance with the approved progress schedule. The approval by the **City** of a progress schedule which is shorter than the time allotted under the **Contract** shall not create any liability for the **City** if the approved progress schedule is not met.

9.4 The **Contractor** will not receive any payments until the proposed progress schedule is submitted.

ARTICLE 10. REQUESTS FOR INFORMATION OR APPROVAL

10.1 From time to time as the **Work** progresses and in the sequence indicated by the approved progress schedule, the **Contractor** shall submit to the **Engineer** a specific request in writing for each item of information or approval required by the **Contractor**. These requests shall state the latest date upon which the information or approval is actually required by the **Contractor**, and shall be submitted in a reasonable time in advance thereof to provide the **Engineer** a sufficient time to act upon such submissions, or any necessary re-submissions thereof.

10.2 The **Contractor** shall not have any right to an extension of time on account of delays due to the **Contractor's** failure to submit requests for the required information or the required approval in accordance with the above requirements.

ARTICLE 11. NOTICE OF CONDITIONS CAUSING DELAY AND DOCUMENTATION OF DAMAGES CAUSED BY DELAY

11.1 After the commencement of any condition which is causing or may cause a delay in completion of the **Work**, including conditions for which the **Contractor** may be entitled to an extension of time, the following notifications and submittals are required:

11.1.1 Within fifteen (15) **Days** after the **Contractor** becomes aware or reasonably should be

aware of each such condition, the **Contractor** must notify the **Resident Engineer** or **Engineer**, as directed by the **Commissioner**, in writing of the existence, nature and effect of such condition upon the approved progress schedule and the **Work**, and must state why and in what respects, if any, the condition is causing or may cause a delay. Such notice shall include a description of the construction activities that are or could be affected by the condition and may include any recommendations the **Contractor** may have to address the delay condition and any activities the **Contractor** may take to avoid or minimize the delay.

11.1.2 If the **Contractor** shall claim to be sustaining damages for delay as provided for in this Article 11, within forty-five (45) **Days** from the time such damages are first incurred for each such condition, the **Contractor** shall submit to the **Commissioner** a verified written statement of the details and estimates of the amounts of such damages, including categories of expected damages and projected monthly costs, together with documentary evidence of such damages as the **Contractor** may have at the time of submission (“statement of delay damages”), as further detailed in Article 11.6. The **Contractor** may submit the above statement within such additional time as may be granted by the **Commissioner** in writing upon written request therefor.

11.1.3 Articles 11.1.1 and 11.1.2 do not relieve the **Contractor** of its obligation to comply with the provisions of Article 44.

11.2 Failure of the **Contractor** to strictly comply with the requirements of Article 11.1.1 may, in the discretion of the **Commissioner**, be deemed sufficient cause to deny any extension of time on account of delay arising out of such condition. Failure of the **Contractor** to strictly comply with the requirements of both Articles 11.1.1 and 11.1.2 shall be deemed a conclusive waiver by the **Contractor** of any and all claims for damages for delay arising from such condition and no right to recover on such claims shall exist.

11.3 When appropriate and directed by the **Engineer**, the progress schedule shall be revised by the **Contractor** until finally approved by the **Engineer**. The revised progress schedule must be strictly adhered to by the **Contractor**.

11.4 Compensable Delays

11.4.1 The **Contractor** agrees to make claim only for additional costs attributable to delay in the performance of this **Contract** necessarily extending the time for completion of the **Work** or resulting from acceleration directed by the **Commissioner** and required to maintain the progress schedule, occasioned solely by any act or omission to act of the **City** listed below. The **Contractor** also agrees that delay from any other cause shall be compensated, if at all, solely by an extension of time to complete the performance of the **Work**.

11.4.1.1 The failure of the **City** to take reasonable measures to coordinate and progress the **Work** to the extent required by the **Contract**, except that the **City** shall not be responsible for the **Contractor’s** obligation to coordinate and progress the **Work** of its **Subcontractors**.

11.4.1.2 Unreasonable delays attributable to the review of shop drawings, the issuance of change orders, or the cumulative impact of change orders that were not brought about by any act or omission of the **Contractor**.

11.4.1.3 The unavailability of the **Site** caused by acts or omissions of the **City**.

11.4.1.4 The issuance by the **Engineer** of a stop work order that was not brought about through any act or omission of the **Contractor**.

11.4.1.5 Differing site conditions or environmental hazards that were neither known nor reasonably ascertainable on a pre-bid inspection of the **Site** or review

of the bid documents or other publicly available sources, and that are not ordinarily encountered in the **Project's** geographical area or neighborhood or in the type of **Work** to be performed.

11.4.1.6 Delays caused by the **City's** bad faith or its willful, malicious, or grossly negligent conduct;

11.4.1.7 Delays not contemplated by the parties;

11.4.1.8 Delays so unreasonable that they constitute an intentional abandonment of the **Contract** by the **City**; and

11.4.1.9 Delays resulting from the **City's** breach of a fundamental obligation of the **Contract**.

11.4.2 No claim may be made for any alleged delay in **Substantial Completion** of the **Work** if the **Work** will be or is substantially completed by the date of **Substantial Completion** provided for in Schedule A unless acceleration has been directed by the **Commissioner** to meet the date of **Substantial Completion** set forth in Schedule A, or unless there is a provision in the **Contract** providing for additional compensation for early completion.

11.4.3 The provisions of this Article 11 apply only to claims for additional costs attributable to delay and do not preclude determinations by the **Commissioner** allowing reimbursements for additional costs for **Extra Work** pursuant to Articles 25 and 26 of this **Contract**. To the extent that any cost attributable to delay is reimbursed as part of a change order, no additional claim for compensation under this Article 11 shall be allowed.

11.5 Non-Compensable Delays. The **Contractor** agrees to make no claim for, and is deemed to have included in its bid prices for the various items of the **Contract**, the extra/additional costs attributable to any delays caused by or attributable to the items set forth below. For such items, the **Contractor** shall be compensated, if at all, solely by an extension of time to complete the performance of the **Work**, in accordance with the provisions of Article 13. Such extensions of time will be granted, if at all, pursuant to the grounds set forth in Article 13.3.

11.5.1 The acts or omissions of any third parties, including but not limited to **Other Contractors**, public/ governmental bodies (other than **City Agencies**), utilities or private enterprises, who are disclosed in the **Contract Documents** or are ordinarily encountered or generally recognized as related to the **Work**;

11.5.2 Any situation which was within the contemplation of the parties at the time of entering into the **Contract**, including any delay indicated or disclosed in the **Contract Documents** or that would be generally recognized by a reasonably prudent contractor as related to the nature of the **Work**, and/or the existence of any facility or appurtenance owned, operated or maintained by any third party, as indicated or disclosed in the **Contract Documents** or ordinarily encountered or generally recognized as related to the nature of the **Work**;

11.5.3 Restraining orders, injunctions or judgments issued by a court which were caused by a Contractor's submission, action or inaction or by a Contractor's **Means and Methods of Construction**, or by third parties, unless such order, injunction or judgment was the result of an act or omission by the **City**;

11.5.4 Any labor boycott, strike, picketing, lockout or similar situation;

11.5.5 Any shortages of supplies or materials, or unavailability of equipment, required by the **Contract Work**;

11.5.6 Climatic conditions, storms, floods, droughts, tidal waves, fires, hurricanes, earthquakes, landslides or other catastrophes or acts of God, or acts of war or of the public enemy or terrorist acts, including the **City's** reasonable responses thereto; and

11.5.7 **Extra Work** which does not significantly affect the overall completion of the **Contract**, reasonable delays in the review or issuance of change orders or field orders and/or in shop drawing reviews or approvals.

11.6 Required Content of Submission of Statement of Delay Damages

11.6.1 In the verified written statement of delay damages required by Article 11.1.2, the following information shall be provided by the **Contractor**:

11.6.1.1 For each delay, the start and end dates of the claimed periods of delay and, in addition, a description of the operations that were delayed, an explanation of how they were delayed, and the reasons for the delay, including identifying the applicable act or omission of the City listed in Article 11.4.

11.6.1.2 A detailed factual statement of the claim providing all necessary dates, locations and items of **Work** affected by the claim.

11.6.1.3 The estimated amount of additional compensation sought and a breakdown of that amount into categories as described in Article 11.7.

11.6.1.4 Any additional information requested by the **Commissioner**.

11.7 Recoverable Costs

11.7.1 Delay damages may be recoverable for the following costs actually and necessarily incurred in the performance of the **Work**:

11.7.1.1 Direct labor, including payroll taxes (subject to statutory wage caps) and supplemental benefits, based on time and materials records;

11.7.1.2 Necessary materials (including transportation to the **Site**), based on time and material records;

11.7.1.3 Reasonable rental value of necessary plant and equipment other than small tools, plus fuel/energy costs according to the applicable formula set forth in Articles 26.2.4 and/or 26.2.8, based on time and material records;

11.7.1.4 Additional insurance and bond costs;

11.7.1.5 Extended **Site** overhead, field office rental, salaries of field office staff, on-site project managers and superintendents, field office staff vehicles, **Project**-specific storage, field office utilities and telephone, and field office consumables;

11.7.1.6 Labor escalation costs based on actual costs;

11.7.1.7 Materials and equipment escalation costs based on applicable industry indices unless documentation of actual increased cost is provided;

11.7.1.8 Additional material and equipment storage costs based on actual documented costs and additional costs necessitated by extended manufacturer warranty periods; and

11.7.1.9 Extended home office overhead calculated based on the following formula:

(1) Subtract from the original **Contract** amount the amount earned by original contractual **Substantial Completion** date (not

- including change orders);
- (2) Remove 15% overhead and profit from the calculation in item (1) by dividing the results of item (1) by 1.15;
- (3) Multiply the result of item (2) by 7.25% for the total home office overhead;
- (4) Multiply the result of item (3) by 7.25% for the total profit; and
- (5) The total extended home office overhead will be the total of items (3) and (4).

11.7.2 Recoverable Subcontractor Costs. When the **Work** is performed by a **Subcontractor**, the **Contractor** may be paid the actual and necessary costs of such subcontracted **Work** as outlined above in Articles 11.7.1.1 through 11.7.1.8, and an additional overhead of 5% of the costs outlined in Articles 11.7.1.1 through 11.7.1.3.

11.7.3 Non-Recoverable Costs. The parties agree that the **City** will have no liability for the following items and the **Contractor** agrees it shall make no claim for the following items:

11.7.3.1 Profit, or loss of anticipated or unanticipated profit, except as provided in Article 11.7.1.9;

11.7.3.2 Consequential damages, including, but not limited to, construction or bridge loans or interest paid on such loans, loss of bonding capacity, bidding opportunities, or interest in investment, or any resulting insolvency;

11.7.3.3 Indirect costs or expenses of any nature except those included in Article 11.7.1;

11.7.3.4 Direct or indirect costs attributable to performance of **Work** where the **Contractor**, because of situations or conditions within its control, has not progressed the **Work** in a satisfactory manner; and

11.7.3.5 Attorneys' fees and dispute and claims preparation expenses.

11.8 Any claims for delay under this Article 11 are not subject to the jurisdiction of the Contract Dispute Resolution Board pursuant to the dispute resolution process set forth in Article 27.

11.9 Any compensation provided to the **Contractor** in accordance with this Article 11 will be made pursuant to a claim filed with the **Comptroller**. Nothing in this Article 11 extends the time for the **Contractor** to file an action with respect to a claim within six months after **Substantial Completion** pursuant to Article 56.

ARTICLE 12. COORDINATION WITH OTHER CONTRACTORS

12.1 During the progress of the **Work**, **Other Contractors** may be engaged in performing other work or may be awarded other contracts for additional work on this **Project**. In that event, the **Contractor** shall coordinate the **Work** to be done hereunder with the work of such **Other Contractors** and the **Contractor** shall fully cooperate with such **Other Contractors** and carefully fit its own **Work** to that provided under other contracts as may be directed by the **Engineer**. The **Contractor** shall not commit or permit any act which will interfere with the performance of work by any **Other Contractors**.

12.2 If the **Engineer** determines that the **Contractor** is failing to coordinate its **Work** with the work of **Other Contractors** as the **Engineer** has directed, then the **Commissioner** shall have the right to withhold any payments otherwise due hereunder until the **Contractor** completely complies with the **Engineer's** directions.

12.3 The **Contractor** shall notify the **Engineer** in writing if any **Other Contractor** on this **Project** is failing to coordinate its work with the **Work** of this **Contract**. If the **Engineer** finds such charges to be true, the **Engineer** shall promptly issue such directions to the **Other Contractor** with respect thereto as the situation may require. The **City** shall not, however, be liable for any damages suffered by any **Other Contractor's** failure to coordinate its work with the **Work** of this **Contract** or by reason of the **Other Contractor's** failure to promptly comply with the directions so issued by the **Engineer**, or by reason of any **Other Contractor's** default in performance, it being understood that the **City** does not guarantee the responsibility or continued efficiency of any contractor. The **Contractor** agrees to make no claim against the **City** for any damages relating to or arising out of any directions issued by the **Engineer** pursuant to this Article 12 (including but not limited to the failure of any **Other Contractor** to comply or promptly comply with such directions), or the failure of any **Other Contractor** to coordinate its work, or the default in performance of any **Other Contractor**.

12.4 The **Contractor** shall indemnify and hold the **City** harmless from any and all claims or judgments for damages and from costs and expenses to which the **City** may be subjected or which it may suffer or incur by reason of the **Contractor's** failure to comply with the **Engineer's** directions promptly; and the **Comptroller** shall have the right to exercise the powers reserved in Article 23 with respect to any claims which may be made for damages due to the **Contractor's** failure to comply with the **Engineer's** directions promptly. Insofar as the facts and **Law** relating to any claim would preclude the **City** from being completely indemnified by the **Contractor**, the **City** shall be partially indemnified by the **Contractor** to the fullest extent provided by **Law**.

12.5 Should the **Contractor** sustain any damage through any act or omission of any **Other Contractor** having a contract with the **City** for the performance of work upon the **Site** or of work which may be necessary to be performed for the proper prosecution of the **Work** to be performed hereunder, or through any act or omission of a subcontractor of such **Other Contractor**, the **Contractor** shall have no claim against the **City** for such damage, but shall have a right to recover such damage from the **Other**

12.5 **Contractor** under the provision similar to the following provisions which apply to this Contract and have been or will be inserted in the contracts with such Other Contractors:

12.5.1 Should any **Other Contractor** having or who shall hereafter have a contract with the **City** for the performance of work upon the **Site** sustain any damage through any act or omission of the **Contractor** hereunder or through any act or omission of any **Subcontractor** of the **Contractor**, the **Contractor** agrees to reimburse such **Other Contractor** for all such damages and to defend at its own expense any action based upon such claim and if any judgment or claim (even if the allegations of the action are without merit) against the **City** shall be allowed the **Contractor** shall pay or satisfy such judgment or claim and pay all costs and expenses in connection therewith and agrees to indemnify and hold the **City** harmless from all such claims. Insofar as the facts and **Law** relating to any claim would preclude the **City** from being completely indemnified by the **Contractor**, the **City** shall be partially indemnified by the **Contractor** to the fullest extent provided by **Law**.

12.6 The **City's** right to indemnification hereunder shall in no way be diminished, waived or discharged by its recourse to assessment of liquidated damages as provided in Article 15, or by the exercise of any other remedy provided for by **Contract** or by **Law**.

ARTICLE 13. EXTENSION OF TIME FOR PERFORMANCE

13.1 If performance by the **Contractor** is delayed for a reason set forth in Article 13.3, the **Contractor** may be allowed a reasonable extension of time in conformance with this Article 13 and the **PPB**

Rules.

13.2 Any extension of time may be granted only by the **ACCO** or by the Board for the Extension of Time (hereafter “Board”) (as set forth below) upon written application by the **Contractor**.

13.3 Grounds for Extension: If such application is made, the **Contractor** shall be entitled to an extension of time for delay in completion of the **Work** caused solely:

13.3.1 By the acts or omissions of the **City**, its officials, agents or employees; or

13.3.2 By the act or omissions of **Other Contractors** on this **Project**; or

13.3.3 By supervening conditions entirely beyond the control of either party hereto (such as, but not limited to, acts of God or the public enemy, excessive inclement weather, war or other national emergency making performance temporarily impossible or illegal, or strikes or labor disputes not brought about by any act or omission of the **Contractor**).

13.3.4 The **Contractor** shall, however, be entitled to an extension of time for such causes only for the number of **Days** of delay which the **ACCO** or the Board may determine to be due solely to such causes, and then only if the **Contractor** shall have strictly complied with all of the requirements of Articles 9 and 10.

13.4 The **Contractor** shall not be entitled to receive a separate extension of time for each of several causes of delay operating concurrently, but, if at all, only for the actual period of delay in completion of the **Work** as determined by the **ACCO** or the Board, irrespective of the number of causes contributing to produce such delay. If one of several causes of delay operating concurrently results from any act, fault or omission of the **Contractor** or of its **Subcontractors** or **Materialmen**, and would of itself (irrespective of the concurrent causes) have delayed the **Work**, no extension of time will be allowed for the period of delay resulting from such act, fault or omission.

13.5 The determination made by the **ACCO** or the Board on an application for an extension of time shall be binding and conclusive on the **Contractor**.

13.6 The **ACCO** or the Board acting entirely within their discretion may grant an application for an extension of time for causes of delay other than those herein referred.

13.7 Permitting the **Contractor** to continue with the **Work** after the time fixed for its completion has expired, or after the time to which such completion may have been extended has expired, or the making of any payment to the **Contractor** after such time, shall in no way operate as a waiver on the part of the **City** of any of its rights under this **Contract**.

13.8 Application for Extension of Time:

13.8.1 Before the **Contractor’s** time extension request will be considered, the **Contractor** shall notify the **ACCO** of the condition which allegedly has caused or is causing the delay, and shall submit a written application to the **ACCO** identifying:

13.8.1(a) The **Contractor**; the registration number; and **Project** description;

13.8.1(b) Liquidated damage assessment rate, as specified in the **Contract**;

13.8.1(c) Original total bid price;

13.8.1(d) The original **Contract** start date and completion date;

13.8.1(e) Any previous time extensions granted (number and duration); and

13.8.1(f) The extension of time requested.

13.8.2 In addition, the application for extension of time shall set forth in detail:

13.8.2(a) The nature of each alleged cause of delay in completing the **Work**;

13.8.2(b) The date upon which each such cause of delay began and ended and the number of **Days** attributable to each such cause;

13.8.2(c) A statement that the **Contractor** waives all claims except for those delineated in the application, and the particulars of any claims which the **Contractor** does not agree to waive. For time extensions for **Substantial Completion** and final completion payments, the application shall include a detailed statement of the dollar amounts of each element of claim item reserved; and

13.8.2(d) A statement indicating the **Contractor's** understanding that the time extension is granted only for purposes of permitting continuation of **Contract** performance and payment for **Work** performed and that the **City** retains its right to conduct an investigation and assess liquidated damages as appropriate in the future.

13.9 Analysis and Approval of Time Extensions:

13.9.1 For time extensions for partial payments, a written determination shall be made by the **ACCO** who may, for good and sufficient cause, extend the time for the performance of the **Contract** as follows:

13.9.1(a) If the **Work** is to be completed within six (6) months, the time for performance may be extended for sixty (60) **Days**;

13.9.1(b) If the **Work** is to be completed within less than one (1) year but more than six (6) months, an extension of ninety (90) **Days** may be granted;

13.9.1(c) If the **Contract** period exceeds one (1) year, besides the extension granted in Article 13.9.1(b), an additional thirty (30) **Days** may be granted for each multiple of six (6) months involved beyond the one (1) year period; or

13.9.1(d) If exceptional circumstances exist, the **ACCO** may extend the time for performance beyond the extensions in Articles 13.9.1(a), 13.9.1(b), and 13.9.1(c). In that event, the **ACCO** shall file with the Mayor's Office of Contract Services a written explanation of the exceptional circumstances.

13.9.2 For extensions of time for **Substantial Completion** and final completion payments, the **Engineer**, in consultation with the **ACCO**, shall prepare a written analysis of the delay (including a preliminary determination of the causes of delay, the beginning and end dates for each such cause of delay, and whether the delays are excusable under the terms of this **Contract**). The report shall be subject to review by and approval of the Board, which shall have authority to question its analysis and determinations and request additional facts or documentation. The report as reviewed and made final by the Board shall be made a part of the **Agency** contract file. Neither the report itself nor anything contained therein shall operate as a

waiver or release of any claim the **City** may have against the **Contractor** for either actual or liquidated damages.

13.9.3 Approval Mechanism for Time Extensions for **Substantial Completion** or Final Completion Payments: An extension shall be granted only with the approval of the Board which is comprised of the **ACCO** of the **Agency**, the **City** Corporation Counsel, and the **Comptroller**, or their authorized representatives.

13.9.4 Neither the granting of any application for an extension of time to the **Contractor** or any **Other Contractor** on this **Project** nor the papers, records or reports related to any application for or grant of an extension of time or determination related thereto shall be referred to or offered in evidence by the **Contractor** or its attorneys in any action or proceeding.

13.10 No Damage for Delay: The **Contractor** agrees to make no claim for damages for delay in the performance of this **Contract** occasioned by any act or omission to act of the **City** or any of its representatives, except as provided for in Article 11.

ARTICLE 14. COMPLETION AND FINAL ACCEPTANCE OF THE WORK

14.1 Date for **Substantial Completion**: The **Contractor** shall substantially complete the **Work** within the time fixed in Schedule A of the General Conditions, or within the time to which such **Substantial Completion** may be extended.

14.2 Determining the Date of **Substantial Completion**: The **Work** will be deemed to be substantially complete when the two conditions set forth below have been met.

14.2.1 Inspection: The **Engineer** or **Resident Engineer**, as applicable, has inspected the **Work** and has made a written determination that it is substantially complete.

14.2.2 Approval of **Final Approved Punch List** and Date for **Final Acceptance**: Following inspection of the **Work**, the **Engineer/Resident Engineer** shall furnish the **Contractor** with a final punch list, specifying all items of **Work** to be completed and proposing dates for the completion of each specified item of **Work**. The **Contractor** shall then submit in writing to the **Engineer/Resident Engineer** within ten (10) **Days** of the **Engineer/Resident Engineer** furnishing the final punch list either acceptance of the dates or proposed alternative dates for the completion of each specified item of **Work**. If the **Contractor** neither accepts the dates nor proposes alternative dates within ten (10) **Days**, the schedule proposed by the **Engineer/Resident Engineer** shall be deemed accepted. If the **Contractor** proposes alternative dates, then, within a reasonable time after receipt, the **Engineer/Resident Engineer**, in a written notification to the **Contractor**, shall approve the **Contractor's** completion dates or, if they are unable to agree, the **Engineer/Resident Engineer** shall establish dates for the completion of each item of **Work**. The latest completion date specified shall be the date for **Final Acceptance** of the **Work**.

14.3 Date of **Substantial Completion**. The date of approval of the **Final Approved Punch List**, shall be the date of **Substantial Completion**. The date of approval of the **Final Approved Punch List** shall be either (a) if the **Contractor** approves the final punch list and proposed dates for completion furnished by the **Engineer/Resident Engineer**, the date of the **Contractor's** approval; or (b) if the **Contractor** neither accepts the dates nor proposes alternative dates, ten (10) **Days** after the **Engineer/Resident Engineer** furnishes the **Contractor** with a final punch list and proposed dates for completion; or (c) if the **Contractor** proposes alternative dates, the date that the **Engineer/Resident Engineer** sends written notification to the

Contractor either approving the **Contractor's** proposed alternative dates or establishing dates for the completion for each item of **Work**.

14.4 Determining the Date of **Final Acceptance**: The **Work** will be accepted as final and complete as of the date of the **Engineer's/Resident Engineer's** inspection if, upon such inspection, the **Engineer/Resident Engineer** finds that all items on the **Final Approved Punch List** are complete and no further **Work** remains to be done. The **Commissioner** will then issue a written determination of **Final Acceptance**.

14.5 Request for Inspection: Inspection of the **Work** by the **Engineer/Resident Engineer** for the purpose of **Substantial Completion** or **Final Acceptance** shall be made within fourteen (14) **Days** after receipt of the **Contractor's** written request therefor.

14.6 Request for Re-inspection: If upon inspection for the purpose of **Substantial Completion** or **Final Acceptance**, the **Engineer/Resident Engineer** determines that there are items of **Work** still to be performed, the **Contractor** shall promptly perform them and then request a re-inspection. If upon re-inspection, the **Engineer/Resident Engineer** determines that the **Work** is substantially complete or finally accepted, the date of such re-inspection shall be the date of **Substantial Completion** or **Final Acceptance**. Re-inspection by the **Engineer/Resident Engineer** shall be made within ten (10) **Days** after receipt of the **Contractor's** written request therefor.

14.7 Initiation of Inspection by the **Engineer/Resident Engineer**: If the **Contractor** does not request inspection or re-inspection of the **Work** for the purpose of **Substantial Completion** or **Final Acceptance**, the **Engineer/Resident Engineer** may initiate such inspection or re-inspection.

ARTICLE 15. LIQUIDATED DAMAGES

15.1 In the event the **Contractor** fails to substantially complete the **Work** within the time fixed for such **Substantial Completion** in Schedule A of the General Conditions, plus authorized time extensions, or if the **Contractor**, in the sole determination of the **Commissioner**, has abandoned the **Work**, the **Contractor** shall pay to the **City** the sum fixed in Schedule A of the General Conditions, for each and every **Day** that the time consumed in substantially completing the **Work** exceeds the time allowed therefor; which said sum, in view of the difficulty of accurately ascertaining the loss which the **City** will suffer by reason of delay in the **Substantial Completion** of the **Work** hereunder, is hereby fixed and agreed as the liquidated damages that the **City** will suffer by reason of such delay, and not as a penalty. This Article 15 shall also apply to the **Contractor** whether or not the **Contractor** is defaulted pursuant to Chapter X of this **Contract**. Neither the failure to assess liquidated damages nor the granting of any time extension shall operate as a waiver or release of any claim the **City** may have against the **Contractor** for either actual or liquidated damages.

15.2 Liquidated damages received hereunder are not intended to be nor shall they be treated as either a partial or full waiver or discharge of the **City's** right to indemnification, or the **Contractor's** obligation to indemnify the **City**, or to any other remedy provided for in this **Contract** or by **Law**.

15.3 The **Commissioner** may deduct and retain out of the monies which may become due hereunder, the amount of any such liquidated damages; and in case the amount which may become due hereunder shall be less than the amount of liquidated damages suffered by the **City**, the **Contractor** shall be liable to pay the difference.

ARTICLE 16. OCCUPATION OR USE PRIOR TO COMPLETION

16.1 Unless otherwise provided for in the **Specifications**, the **Commissioner** may take over, use, occupy or operate any part of the **Work** at any time prior to **Final Acceptance**, upon written notification to the **Contractor**. The **Engineer** or **Resident Engineer**, as applicable, shall inspect the part of the **Work** to be taken over, used, occupied, or operated, and will furnish the **Contractor** with a written statement of the **Work**, if any, which remains to be performed on such part. The **Contractor** shall not object to, nor interfere with, the **Commissioner's** decision to exercise the rights granted by Article 16. In the event the **Commissioner** takes over, uses, occupies, or operates any part of the **Work**:

16.1.1 the **Engineer/Resident Engineer** shall issue a written determination of **Substantial Completion** with respect to such part of the **Work**;

16.1.2 the **Contractor** shall be relieved of its absolute obligation to protect such part of the unfinished **Work** in accordance with Article 7;

16.1.3 the **Contractor's** guarantee on such part of the **Work** shall begin on the date of such use by the **City**; and;

16.1.4 the **Contractor** shall be entitled to a return of so much of the amount retained in accordance with Article 21 as it relates to such part of the **Work**, except so much thereof as may be retained under Articles 24 and 44.

CHAPTER IV: SUBCONTRACTS AND ASSIGNMENTS

ARTICLE 17. SUBCONTRACTS

17.1 The **Contractor** shall not make subcontracts totaling an amount more than the percentage of the total **Contract** price fixed in Schedule A of the General Conditions, without prior written permission from the **Commissioner**. All subcontracts made by the **Contractor** shall be in writing. No **Work** may be performed by a **Subcontractor** prior to the **Contractor** entering into a written subcontract with the **Subcontractor** and complying with the provisions of this Article 17.

17.2 Before making any subcontracts, the **Contractor** shall submit a written statement to the **Commissioner** giving the name and address of the proposed **Subcontractor**; the portion of the **Work** and materials which it is to perform and furnish; the cost of the subcontract; the VENDEX questionnaire if required; the proposed subcontract if requested by the **Commissioner**; and any other information tending to prove that the proposed **Subcontractor** has the necessary facilities, skill, integrity, past experience, and financial resources to perform the **Work** in accordance with the terms and conditions of this **Contract**.

17.3 In addition to the requirements in Article 17.2, **Contractor** is required to list the **Subcontractor** in the web based Subcontractor Reporting System through the City's Payee Information Portal (PIP), available at www.nyc.gov/pip.¹ For each **Subcontractor** listed, **Contractor** is required to provide the following information: maximum contract value, description of **Subcontractor's** Work, start and end date of the subcontract and identification of the **Subcontractor's** industry. Thereafter, **Contractor** will be required to report in the system the payments made to each **Subcontractor** within 30 days of making the

¹ In order to use the new system, a PIP account will be required. Detailed instructions on creating a PIP account and using the new system are also available at www.nyc.gov/pip. Additional assistance with PIP may be obtained by emailing the Financial Information Services Agency Help Desk at pip@fisa.nyc.gov.

payment. If any of the required information changes throughout the Term of the **Contract**, **Contractor** will be required to revise the information in the system.

Failure of the **Contractor** to list a **Subcontractor** and/or to report **Subcontractor** payments in a timely fashion may result in the **Commissioner** declaring the **Contractor** in default of the **Contract** and will subject **Contractor** to liquidated damages in the amount of \$100 per day for each day that the **Contractor** fails to identify a **Subcontractor** along with the required information about the **Subcontractor** and/or fails to report payments to a **Subcontractor**, beyond the time frames set forth herein or in the notice from the **City**. Article 15 shall govern the issue of liquidated damages.

17.4 If an approved **Subcontractor** elects to subcontract any portion of its subcontract, the proposed sub-subcontract shall be submitted in the same manner as directed above.

17.5 The **Commissioner** will notify the **Contractor** in writing whether the proposed **Subcontractor** is approved. If the proposed **Subcontractor** is not approved, the **Contractor** may submit another proposed **Subcontractor** unless the **Contractor** decides to do the **Work**. No **Subcontractor** shall be permitted to enter or perform any work on the **Site** unless approved.

17.6 Before entering into any subcontract hereunder, the **Contractor** shall provide the proposed **Subcontractor** with a complete copy of this document and inform the proposed **Subcontractor** fully and completely of all provisions and requirements of this **Contract** relating either directly or indirectly to the **Work** to be performed and the materials to be furnished under such subcontract, and every such **Subcontractor** shall expressly stipulate that all labor performed and materials furnished by the **Subcontractor** shall strictly comply with the requirements of this **Contract**.

17.7 Documents given to a prospective **Subcontractor** for the purpose of soliciting the **Subcontractor's** bid shall include either a copy of the bid cover or a separate information sheet setting forth the **Project** name, the **Contract** number (if available), the **Agency** (as noted in Article 2.1.6), and the **Project's** location.

17.8 The **Commissioner's** approval of a **Subcontractor** shall not relieve the **Contractor** of any of its responsibilities, duties, and liabilities hereunder. The **Contractor** shall be solely responsible to the **City** for the acts or defaults of its **Subcontractor** and of such **Subcontractor's** officers, agents, and employees, each of whom shall, for this purpose, be deemed to be the agent or employee of the **Contractor** to the extent of its subcontract.

17.9 If the **Subcontractor** fails to maintain the necessary facilities, skill, integrity, past experience, and financial resources (other than due to the **Contractor's** failure to make payments where required) to perform the **Work** in accordance with the terms and conditions of this **Contract**, the **Contractor** shall promptly notify the **Commissioner** and replace such **Subcontractor** with a newly approved **Subcontractor** in accordance with this Article 17.

17.10 The **Contractor** shall be responsible for ensuring that all **Subcontractors** performing **Work** at the **Site** maintain all insurance required by **Law**.

17.11 The **Contractor** shall promptly, upon request, file with the **Engineer** a conformed copy of the subcontract and its cost. The subcontract shall provide the following:

17.11.1 Payment to **Subcontractors**: The agreement between the **Contractor** and its **Subcontractor** shall contain the same terms and conditions as to method of payment for **Work**, labor, and materials, and as to retained percentages, as are contained in this **Contract**.

17.11.2 Prevailing Rate of Wages: The agreement between the **Contractor** and its **Subcontractor** shall include the prevailing wage rates and supplemental benefits to be paid in accordance with Labor Law Section 220.

17.11.3 Section 6-123 of the Administrative Code: Pursuant to the requirements of Section 6-123 of the Administrative Code, every agreement between the **Contractor** and a **Subcontractor** in excess of fifty thousand (\$50,000) dollars shall include a provision that the **Subcontractor** shall not engage in any unlawful discriminatory practice as defined in Title VIII of the Administrative Code (Section 8-101 *et seq.*).

17.11.4 All requirements required pursuant to federal and/or state grant agreement(s), if applicable to the **Work**.

17.12 The **Commissioner** may deduct from the amounts certified under this **Contract** to be due to the **Contractor**, the sum or sums due and owing from the **Contractor** to the **Subcontractors** according to the terms of the said subcontracts, and in case of dispute between the **Contractor** and its **Subcontractor**, or **Subcontractors**, as to the amount due and owing, the **Commissioner** may deduct and withhold from the amounts certified under this **Contract** to be due to the **Contractor** such sum or sums as may be claimed by such **Subcontractor**, or **Subcontractors**, in a sworn affidavit, to be due and owing until such time as such claim or claims shall have been finally resolved.

17.13 On contracts where performance bonds and payment bonds are executed, the **Contractor** shall include on each requisition for payment the following data: **Subcontractor's** name, value of the subcontract, total amount previously paid to **Subcontractor** for **Work** previously requisitioned, and the amount, including retainage, to be paid to the **Subcontractor** for **Work** included in the requisition.

17.14 On **Contracts** where performance bonds and payment bonds are not executed, the **Contractor** shall include with each requisition for payment submitted hereunder, a signed statement from each and every **Subcontractor** and/or **Materialman** for whom payment is requested in such requisition. Such signed statement shall be on the letterhead of the **Subcontractor** and/or **Materialman** for whom payment is requested and shall (i) verify that such **Subcontractor** and/or **Materialman** has been paid in full for all **Work** performed and/or material supplied to date, exclusive of any amount retained and any amount included on the current requisition, and (ii) state the total amount of retainage to date, exclusive of any amount retained on the current requisition.

ARTICLE 18. ASSIGNMENTS

18.1 The **Contractor** shall not assign, transfer, convey or otherwise dispose of this **Contract**, or the right to execute it, or the right, title or interest in or to it or any part thereof, or assign, by power of attorney or otherwise any of the monies due or to become due under this **Contract**, unless the previous written consent of the **Commissioner** shall first be obtained thereto, and the giving of any such consent to a particular assignment shall not dispense with the necessity of such consent to any further or other assignments.

18.2 Such assignment, transfer, conveyance or other disposition of this **Contract** shall not be valid until filed in the office of the **Commissioner** and the **Comptroller**, with the written consent of the **Commissioner** endorsed thereon or attached thereto.

18.3 Failure to obtain the previous written consent of the **Commissioner** to such an assignment,

transfer, conveyance or other disposition, may result in the revocation and annulment of this **Contract**. The **City** shall thereupon be relieved and discharged from any further liability to the **Contractor**, its assignees, transferees or sublessees, who shall forfeit and lose all monies therefor earned under the **Contract**, except so much as may be required to pay the **Contractor's** employees.

18.4 The provisions of this clause shall not hinder, prevent, or affect an assignment by the **Contractor** for the benefit of its creditors made pursuant to the **Laws** of the State of New York.

18.5 This **Contract** may be assigned by the **City** to any corporation, agency or instrumentality having authority to accept such assignment.

CHAPTER V: CONTRACTOR'S SECURITY AND GUARANTEE

ARTICLE 19. SECURITY DEPOSIT

19.1 If performance and payment bonds are required, the **City** shall retain the bid security to ensure that the successful bidder executes the **Contract** and furnishes the required payment and performance security within ten (10) **Days** after notice of the award of the **Contract**. If the successful bidder fails to execute the **Contract** and furnish the required payment and performance security, the **City** shall retain such bid security as set forth in the Information for Bidders. If the successful bidder executes the **Contract** and furnishes the required payment and performance security, the **City** shall return the bid security within a reasonable time after the furnishing of such bonds and execution of the **Contract** by the **City**.

19.2 If performance and payment bonds are not required, the bid security shall be retained by the **City** as security for the **Contractor's** faithful performance of the **Contract**. If partial payments are provided, the bid security will be returned to the **Contractor** after the sum retained under Article 21 equals the amount of the bid security, subject to other provisions of this **Contract**. If partial payments are not provided, the bid security will be released when final payment is certified by the **City** for payment.

19.3 If the **Contractor** is declared in default under Article 48 prior to the return of the deposit, or if any claim is made such as referred to in Article 23, the amount of such deposit, or so much thereof as the **Comptroller** may deem necessary, may be retained and then applied by the **Comptroller**:

19.3.1 To compensate the **City** for any expense, loss or damage suffered or incurred by reason of or resulting from such default, including the cost of re-letting and liquidated damages; or

19.3.2 To indemnify the **City** against any and all claims.

ARTICLE 20. PAYMENT GUARANTEE

20.1 On **Contracts** where one hundred (100%) percent performance bonds and payment bonds are executed, this Article 20 does not apply.

20.2 In the event the terms of this **Contract** do not require the **Contractor** to provide a payment bond or where the **Contract** does not require a payment bond for one hundred (100%) percent of the **Contract** price, the **City** shall, in accordance with the terms of this Article 20, guarantee payment of all lawful claims for:

20.2.1 Wages and compensation for labor performed and/or services rendered; and

20.2.2 Materials, equipment, and supplies provided, whether incorporated into the **Work** or not, when demands have been filed with the **City** as provided hereinafter by any person, firm, or corporation which furnished labor, material, equipment, supplies, or any combination thereof, in connection with the **Work** performed hereunder (hereinafter referred to as the “beneficiary”) at the direction of the **City** or the **Contractor**.

20.3 The provisions of Article 20.2 are subject to the following limitations and conditions:

20.3.1 If the **Contractor** provides a payment bond for a value that is less than one hundred (100%) percent of the value of the **Contract Work**, the payment bond provided by the **Contractor** shall be primary (and non-contributing) to the payment guarantee provided under this Article 20.

20.3.2 The guarantee is made for the benefit of all beneficiaries as defined in Article 20.2 provided that those beneficiaries strictly adhere to the terms and conditions of Article 20.3.4 and 20.3.5.

20.3.3 Nothing in this Article 20 shall prevent a beneficiary providing labor, services or material for the **Work** from suing the **Contractor** for any amounts due and owing the beneficiary by the **Contractor**.

20.3.4 Every person who has furnished labor or material, to the **Contractor** or to a **Subcontractor** of the **Contractor**, in the prosecution of the **Work** and who has not been paid in full therefor before the expiration of a period of ninety (90) **Days** after the date on which the last of the labor was performed or material was furnished by him/her for which the claim is made, shall have the right to sue on this payment guarantee in his/her own name for the amount, or the balance thereof, unpaid at the time of commencement of the action; provided, however, that a person having a direct contractual relationship with a **Subcontractor** of the **Contractor** but no contractual relationship express or implied with the **Contractor** shall not have a right of action upon the guarantee unless he/she shall have given written notice to the **Contractor** within one hundred twenty (120) **Days** from the date on which the last of the labor was performed or the last of the material was furnished, for which his/her claim is made, stating with substantial accuracy the amount claimed and the name of the party to whom the material was furnished or for whom the labor was performed. The notice shall be served by delivering the same personally to the **Contractor** or by mailing the same by registered mail, postage prepaid, in an envelope addressed to the **Contractor** at any place where it maintains an office or conducts its business; provided, however, that where such notice is actually received by the **Contractor** by other means, such notice shall be deemed sufficient.

20.3.5 Except as provided in Labor Law Section 220-g, no action on this payment guarantee shall be commenced after the expiration of the one-year limitations period set forth in Section 137(4)(b) of the State Finance Law.

20.3.6 The **Contractor** shall promptly forward to the **City** any notice or demand received pursuant to Article 20.3.4. The **Contractor** shall inform the **City** of any defenses to the notice or demand and shall forward to the **City** any documents the **City** requests concerning the notice or demand.

20.3.7 All demands made against the **City** by a beneficiary of this payment guarantee shall be presented to the **Engineer** along with all written documentation concerning the demand which the **Engineer** deems reasonably appropriate or necessary, which may include, but shall not be

limited to: the subcontract; any invoices presented to the **Contractor** for payment; the notarized statement of the beneficiary that the demand is due and payable, that a request for payment has been made of the **Contractor** and that the demand has not been paid by the **Contractor** within the time allowed for such payment by the subcontract; and copies of any correspondence between the beneficiary and the **Contractor** concerning such demand. The **City** shall notify the **Contractor** that a demand has been made. The **Contractor** shall inform the **City** of any defenses to the demand and shall forward to the **City** any documents the **City** requests concerning the demand.

20.3.8 The **City** shall make payment only if, after considering all defenses presented by the **Contractor**, it determines that the payment is due and owing to the beneficiary making the demand.

20.3.9 No beneficiary shall be entitled to interest from the **City**, or to any other costs, including, but not limited to, attorneys' fees, except to the extent required by State Finance Law Section 137.

20.3.10

20.4 Upon the receipt by the **City** of a demand pursuant to this Article 20, the **City** may withhold from any payment otherwise due and owing to the **Contractor** under this **Contract** an amount sufficient to satisfy the demand.

20.4.1 In the event the **City** determines that the demand is valid, the **City** shall notify the **Contractor** of such determination and the amount thereof and direct the **Contractor** to immediately pay such amount to the beneficiary. In the event the **Contractor**, within seven (7) **Days** of receipt of such notification from the **City**, fails to pay the beneficiary, such failure shall constitute an automatic and irrevocable assignment of payment by the **Contractor** to the beneficiary for the amount of the demand determined by the **City** to be valid. The **Contractor**, without further notification or other process, hereby gives its unconditional consent to such assignment of payment to the beneficiary and authorizes the **City**, on its behalf, to take all necessary actions to implement such assignment of payment, including without limitation the execution of any instrument or documentation necessary to effectuate such assignment.

20.4.2 In the event that the amount otherwise due and owing to the **Contractor** by the **City** is insufficient to satisfy such demand, the **City** may, at its option, require payment from the **Contractor** of an amount sufficient to cover such demand and exercise any other right to require or recover payment which the **City** may have under **Law** or **Contract**.

20.4.3 In the event the **City** determines that the demand is invalid, any amount withheld pending the **City**'s review of such demand shall be paid to the **Contractor**; provided, however, no lien has been filed. In the event a claim or an action has been filed, the terms and conditions set forth in Article 23 shall apply. In the event a lien has been filed, the parties will be governed by the provisions of the Lien Law of the State of New York.

20.5 The provisions of this Article 20 shall not prevent the **City** and the **Contractor** from resolving disputes in accordance with the **PPB** Rules, where applicable.

20.6 In the event the **City** determines that the beneficiary is entitled to payment pursuant to this Article 20, such determination and any defenses and counterclaims raised by the **Contractor** shall be taken into account in evaluating the **Contractor**'s performance.

20.7 Nothing in this Article 20 shall relieve the **Contractor** of the obligation to pay the claims of all

persons with valid and lawful claims against the **Contractor** relating to the **Work**.

20.8 The **Contractor** shall not require any performance, payment or other bonds of any **Subcontractor** if this **Contract** does not require such bonds of the **Contractor**.

20.9 The payment guarantee made pursuant to this Article 20 shall be construed in a manner consistent with Section 137 of the State Finance Law and shall afford to persons furnishing labor or materials to the **Contractor** or its **Subcontractors** in the prosecution of the **Work** under this **Contract** all of the rights and remedies afforded to such persons by such section, including but not limited to, the right to commence an action against the **City** on the payment guarantee provided by this Article 20 within the one-year limitations period set forth in Section 137(4)(b).

ARTICLE 21. RETAINED PERCENTAGE

21.1 If this **Contract** requires one hundred (100%) percent performance and payment security, then as further security for the faithful performance of this **Contract**, the **Commissioner** shall deduct, and retain until the substantial completion of the **Work**, five (5%) percent of the value of **Work** certified for payment in each partial payment voucher.

21.2 If this **Contract** does not require one hundred (100%) percent performance and payment security and if the price for which this **Contract** was awarded does not exceed one million (\$1,000,000) dollars, then as further security for the faithful performance of this **Contract**, the **Commissioner** shall deduct, and retain until the substantial completion of the **Work**, five (5%) percent of the value of **Work** certified for payment in each partial payment voucher.

21.3 If this **Contract** does not require one hundred (100%) percent performance and payment security and if the price for which this **Contract** was awarded exceeds one million (\$1,000,000) dollars, then as further security for the faithful performance of this **Contract**, the **Commissioner** shall deduct, and retain until the substantial completion of the **Work**, up to ten (10%) percent of the value of **Work** certified for payment in each partial payment voucher. The percentage to be retained is set forth in Schedule A of the General Conditions.

ARTICLE 22. INSURANCE

22.1 Types of Insurance: The **Contractor** shall procure and maintain the following types of insurance if, and as indicated, in Schedule A of the General Conditions (with the minimum limits and special conditions specified in Schedule A). Such insurance shall be maintained from the date the **Contractor** is required to provide Proof of Insurance pursuant to Article 22.3.1 through the date of completion of all required **Work** (including punch list work as certified in writing by the **Resident Engineer**), except for insurance required pursuant to Article 22.1.4, which may terminate upon **Substantial Completion** of the **Contract**. All insurance shall meet the requirements set forth in this Article 22. Wherever this Article requires that insurance coverage be “at least as broad” as a specified form (including all ISO forms), there is no obligation that the form itself be used, provided that the **Contractor** can demonstrate that the alternative form or endorsement contained in its policy provides coverage at least as broad as the specified form.

22.1.1 Commercial General Liability Insurance: The **Contractor** shall provide Commercial General Liability Insurance covering claims for property damage and/or bodily injury, including death, which may arise from any of the operations under this **Contract**. Coverage under this insurance shall be at least as broad as that provided by the latest edition of Insurance

Services Office (“ISO”) Form CG 0001. Such insurance shall be “occurrence” based rather than “claims-made” and include, without limitation, the following types of coverage: premises operations; products and completed operations; contractual liability (including the tort liability of another assumed in a contract); broad form property damage; independent contractors; explosion, collapse and underground (XCU); construction means and methods; and incidental malpractice. Such insurance shall contain a “per project” aggregate limit, as specified in Schedule A, that applies separately to operations under this **Contract**.

22.1.1(a) Such Commercial General Liability Insurance shall name the **City** as an Additional Insured. Coverage for the City shall specifically include the **City’s** officials and employees, be at least as broad as the latest edition of ISO Form CG 20 10 and provide completed operations coverage at least as broad as the latest edition of ISO Form CG 20 37.

22.1.1(b) Such Commercial General Liability Insurance shall name all other entities designated as additional insureds in Schedule A but only for claims arising from the **Contractor’s** operations under this **Contract**, with coverage at least as broad as the latest edition of ISO Form CG 20 26.

22.1.1(c) If the **Work** requires a permit from the Department of Buildings pursuant to 1 RCNY Section 101-08, the **Contractor** shall provide Commercial General Liability Insurance with limits of at least those required by 1 RCNY section 101-08 or greater limits required by the Agency in accordance with Schedule A. If the **Work** does not require such a permit, the minimum limits shall be those provided for in Schedule A.

22.1.1(d) If any of the **Work** includes repair of a waterborne vessel owned by or to be delivered to the **City**, such Commercial General Liability shall include, or be endorsed to include, Ship Repairer’s Legal Liability Coverage to protect against, without limitation, liability arising from navigation of such vessels prior to delivery to and acceptance by the **City**.

22.1.2 Workers’ Compensation Insurance, Employers’ Liability Insurance, and Disability Benefits Insurance: The **Contractor** shall provide, and shall cause its **Subcontractors** to provide, Workers Compensation Insurance, Employers’ Liability Insurance, and Disability Benefits Insurance in accordance with the **Laws** of the State of New York on behalf of all employees providing services under this **Contract** (except for those employees, if any, for which the **Laws** require insurance only pursuant to Article 22.1.3).

22.1.3 United States Longshoremen’s and Harbor Workers Act and/or Jones Act Insurance: If specified in Schedule A of the General Conditions or if required by **Law**, the **Contractor** shall provide insurance in accordance with the United States Longshoremen’s and Harbor Workers Act and/or the Jones Act, on behalf of all qualifying employees providing services under this **Contract**.

22.1.4 Builders Risk Insurance: If specified in Schedule A of the General Conditions, the **Contractor** shall provide Builders Risk Insurance on a completed value form for the total value of the **Work** through **Substantial Completion** of the **Work** in its entirety. Such insurance shall be provided on an All Risk basis and include coverage, without limitation, for windstorm (including named windstorm), storm surge, flood and earth movement. Unless waived by the **Commissioner**, it shall include coverage for ordinance and law, demolition and increased costs of construction, debris removal, pollutant clean up and removal, and expediting costs. Such insurance shall cover, without limitation, (a) all buildings and/or structures involved in the

Work, as well as temporary structures at the **Site**, and (b) any property that is intended to become a permanent part of such building or structure, whether such property is on the **Site**, in transit or in temporary storage. Policies shall name the **Contractor** as Named Insured and list the **City** as both an Additional Insured and a Loss Payee as its interest may appear.

22.1.4(a) Policies of such insurance shall specify that, in the event a loss occurs at an occupied facility, occupancy of such facility is permitted without the consent of the issuing insurance company.

22.1.4(b) Such insurance may be provided through an Installation Floater, at the **Contractor's** option, if it otherwise conforms with the requirements of this Article 22.1.4.

22.1.5 Commercial Automobile Liability Insurance: The **Contractor** shall provide Commercial Automobile Liability Insurance for liability arising out of ownership, maintenance or use of any owned (if any), non-owned and hired vehicles to be used in connection with this **Contract**. Coverage shall be at least as broad as the latest edition of ISO Form CA0001. If vehicles are used for transporting hazardous materials, the Automobile Liability Insurance shall be endorsed to provide pollution liability broadened coverage for covered vehicles (endorsement CA 99 48) as well as proof of MCS 90.

22.1.6 Contractors Pollution Liability Insurance: If specified in Schedule A of the General Conditions, the **Contractor** shall maintain, or cause the **Subcontractor** doing such **Work** to maintain, Contractors Pollution Liability Insurance covering bodily injury and property damage. Such insurance shall provide coverage for actual, alleged or threatened emission, discharge, dispersal, seepage, release or escape of pollutants (including asbestos), including any loss, cost or expense incurred as a result of any cleanup of pollutants (including asbestos) or in the investigation, settlement or defense of any claim, action, or proceedings arising from the operations under this **Contract**. Such insurance shall be in the **Contractor's** name and list the **City** as an Additional Insured and any other entity specified in Schedule A. Coverage shall include, without limitation, (a) loss of use of damaged property or of property that has not been physically injured, (b) transportation, and (c) non-owned disposal sites.

22.1.6(a) Coverage for the **City** as Additional Insured shall specifically include the **City's** officials and employees and be at least as broad as provided to the **Contractor** for this **Project**.

22.1.6(b) If such insurance is written on a claims-made policy, such policy shall have a retroactive date on or before the effective date of this **Contract**, and continuous coverage shall be maintained, or an extended discovery period exercised, for a period of not less than three (3) years from the time the **Work** under this **Contract** is completed.

22.1.7 Marine Insurance:

22.1.7(a) Marine Protection and Indemnity Insurance: If specified in Schedule A of the General Conditions or if the **Contractor** engages in marine operations in the execution of any part of the **Work**, the **Contractor** shall maintain, or cause the **Subcontractor** doing such **Work** to maintain, Marine Protection and Indemnity Insurance with coverage at least as broad as Form SP-23. The insurance shall provide coverage for the **Contractor** or **Subcontractor** (whichever is doing this **Work**) and for the **City** (together with its officials and employees) and any other entity specified in Schedule A as an Additional Insured for bodily injury and property damage arising from marine operations under this

Contract. Coverage shall include, without limitation, injury or death of crew members (if not fully provided through other insurance), removal of wreck, damage to piers, wharves and other fixed or floating objects and loss of or damage to any other vessel or craft, or to property on such other vessel or craft.

22.1.7(b) Hull and Machinery Insurance: If specified in Schedule A of the General Conditions or if the **Contractor** engages in marine operations in the execution of any part of the **Work**, the **Contractor** shall maintain, or cause the **Subcontractor** doing such **Work** to maintain, Hull and Machinery Insurance with coverage for the **Contractor** or **Subcontractor** (whichever is doing this Work) and for the **City** (together with its officials and employees) as Additional Insured at least as broad as the latest edition of American Institute Tug Form for all tugs used under this **Contract** and Collision Liability at least as broad as the latest edition of American Institute Hull Clauses.

22.1.7(c) Marine Pollution Liability Insurance: If specified in Schedule A of the General Conditions or if the **Contractor** engages in marine operations in the execution of any part of the **Work**, the **Contractor** shall maintain, or cause the **Subcontractor** doing such Work to maintain, Marine Pollution Liability Insurance covering itself (or the Subcontractor doing such Work) as Named Insured and the **City** (together with its officials and employees) and any other entity specified in Schedule A as an Additional Insured. Coverage shall be at least as broad as that provided by the latest edition of Water Quality Insurance Syndicate Form and include, without limitation, liability arising from the discharge or substantial threat of a discharge of oil, or from the release or threatened release of a hazardous substance including injury to, or economic losses resulting from, the destruction of or damage to real property, personal property or natural resources.

22.1.8 The **Contractor** shall provide such other types of insurance, at such minimum limits and with such conditions, as are specified in Schedule A of the General Conditions.

22.2 General Requirements for Insurance Coverage and Policies:

22.2.1 All required insurance policies shall be maintained with companies that may lawfully issue the required policy and have an A.M. Best rating of at least A-/VII or a Standard and Poor's rating of at least A, unless prior written approval is obtained from the **City** Corporation Counsel.

22.2.2 The **Contractor** shall be solely responsible for the payment of all premiums for all required policies and all deductibles and self-insured retentions to which such policies are subject, whether or not the **City** is an insured under the policy.

22.2.3 In his/her sole discretion, the **Commissioner** may, subject to the approval of the **Comptroller** and the **City** Corporation Counsel, accept Letters of Credit and/or custodial accounts in lieu of required insurance.

22.2.4 The **City's** limits of coverage for all types of insurance required pursuant to Schedule A of the General Conditions shall be the greater of (i) the minimum limits set forth in Schedule A or (ii) the limits provided to the **Contractor** as Named Insured under all primary, excess, and umbrella policies of that type of coverage.

22.2.5 The **Contractor** may satisfy its insurance obligations under this Article 22 through primary policies or a combination of primary and excess/umbrella policies, so long as all policies provide the scope of coverage required herein.

22.2.6 Policies of insurance provided pursuant to this Article 22 shall be primary and non-contributing to any insurance or self-insurance maintained by the **City**.

22.3 Proof of Insurance:

22.3.1 For all types of insurance required by Article 22.1 and Schedule A, except for insurance required by Articles 22.1.4 and 22.1.7, the **Contractor** shall file proof of insurance in accordance with this Article 22.3 within ten (10) **Days** of award. For insurance provided pursuant to Articles 22.1.4 and 22.1.7, proof shall be filed by a date specified by the **Commissioner** or ten (10) **Days** prior to the commencement of the portion of the **Work** covered by such policy, whichever is earlier.

22.3.2 For Workers' Compensation Insurance provided pursuant to Article 22.1.2, the **Contractor** shall submit one of the following forms: C-105.2 Certificate of Workers' Compensation Insurance; U-26.3 - State Insurance Fund Certificate of Workers' Compensation Insurance; Request for WC/DB Exemption (Form CE-200); equivalent or successor forms used by the New York State Workers' Compensation Board; or other proof of insurance in a form acceptable to the **Commissioner**. For Disability Benefits Insurance provided pursuant to Article 22.1.2, the Contractor shall submit DB-120.1 - Certificate Of Insurance Coverage Under The NYS Disability Benefits Law, Request for WC/DB Exemption (Form CE-200); equivalent or successor forms used by the New York State Workers' Compensation Board; or other proof of insurance in a form acceptable to the **Commissioner**. ACORD forms are not acceptable.

22.3.3 For policies provided pursuant to all of Article 22.1 other than Article 22.1.2, the **Contractor** shall submit one or more Certificates of Insurance on forms acceptable to the **Commissioner**. All such Certificates of Insurance shall certify (a) the issuance and effectiveness of such policies of insurance, each with the specified minimum limits (b) for insurance secured pursuant to Article 22.1.1 that the **City** and any other entity specified in Schedule A is an Additional Insured thereunder; (c) in the event insurance is required pursuant to Article 22.1.6 and/or Article 22.1.7, that the City is an Additional Insured thereunder; (d) the company code issued to the insurance company by the National Association of Insurance Commissioners (the NAIC number); and (e) the number assigned to the **Contract** by the **City**. All such Certificates of Insurance shall be accompanied by either a duly executed "Certification by Insurance Broker or Agent" in the form contained in Part III of Schedule A or copies of all policies referenced in such Certificate of Insurance as certified by an authorized representative of the issuing insurance carrier. If any policy is not available at the time of submission, certified binders may be submitted until such time as the policy is available, at which time a certified copy of the policy shall be submitted.

22.3.4 Documentation confirming renewals of insurance shall be submitted to the **Commissioner** prior to the expiration date of coverage of policies required under this **Contract**. Such proofs of insurance shall comply with the requirements of Articles 22.3.2 and 22.3.3.

22.3.5 The **Contractor** shall be obligated to provide the **City** with a copy of any policy of insurance provided pursuant to this Article 22 upon the demand for such policy by the **Commissioner** or the **City** Corporation Counsel.

22.4 Operations of the **Contractor**:

22.4.1 The **Contractor** shall not commence the **Work** unless and until all required certificates have been submitted to and accepted by the **Commissioner**. Acceptance by the

Commissioner of a certificate does not excuse the **Contractor** from securing insurance consistent with all provisions of this Article 22 or of any liability arising from its failure to do so.

22.4.2 The **Contractor** shall be responsible for providing continuous insurance coverage in the manner, form, and limits required by this **Contract** and shall be authorized to perform **Work** only during the effective period of all required coverage.

22.4.3 In the event that any of the required insurance policies lapse, are revoked, suspended or otherwise terminated, for whatever cause, the **Contractor** shall immediately stop all **Work**, and shall not recommence **Work** until authorized in writing to do so by the **Commissioner**. Upon quitting the **Site**, except as otherwise directed by the **Commissioner**, the **Contractor** shall leave all plant, materials, equipment, tools, and supplies on the **Site**. **Contract** time shall continue to run during such periods and no extensions of time will be granted. The **Commissioner** may also declare the **Contractor** in default for failure to maintain required insurance.

22.4.4 In the event the **Contractor** receives notice, from an insurance company or other person, that any insurance policy required under this Article 22 shall be cancelled or terminated (or has been cancelled or terminated) for any reason, the **Contractor** shall immediately forward a copy of such notice to both the **Commissioner** and the New York City Comptroller, attn: Office of Contract Administration, Municipal Building, One Centre Street, room 1005, New York, New York 10007. Notwithstanding the foregoing, the **Contractor** shall ensure that there is no interruption in any of the insurance coverage required under this Article 22.

22.4.5 Where notice of loss, damage, occurrence, accident, claim or suit is required under an insurance policy maintained in accordance with this Article 22, the **Contractor** shall notify in writing all insurance carriers that issued potentially responsive policies of any such event relating to any operations under this **Contract** (including notice to Commercial General Liability insurance carriers for events relating to the **Contractor**'s own employees) no later than 20 days after such event. For any policy where the **City** is an Additional Insured, such notice shall expressly specify that "this notice is being given on behalf of the City of New York as Insured as well as the Named Insured." Such notice shall also contain the following information: the number of the insurance policy, the name of the named insured, the date and location of the damage, occurrence, or accident, and the identity of the persons or things injured, damaged or lost. The **Contractor** shall simultaneously send a copy of such notice to the City of New York c/o Insurance Claims Specialist, Affirmative Litigation Division, New York City Law Department, 100 Church Street, New York, New York 10007.

22.4.6 In the event of any loss, accident, claim, action, or other event that does or can give rise to a claim under any insurance policy required under this Article 22, the **Contractor** shall at all times fully cooperate with the **City** with regard to such potential or actual claim.

22.5 **Subcontractor Insurance**: In the event the **Contractor** requires any **Subcontractor** to procure insurance with regard to any operations under this **Contract** and requires such **Subcontractor** to name the **Contractor** as an **Additional Insured** thereunder, the **Contractor** shall ensure that the **Subcontractor** name the **City**, including its officials and employees, as an Additional Insured with coverage at least as broad as the most recent edition of ISO Form CG 20 26.

22.6 Wherever reference is made in Article 7 or this Article 22 to documents to be sent to the **Commissioner** (e.g., notices, filings, or submissions), such documents shall be sent to the address set forth in Schedule A of the General Conditions. In the event no address is set forth in Schedule A, such documents

are to be sent to the **Commissioner's** address as provided elsewhere in this **Contract**.

22.7 Apart from damages or losses covered by insurance provided pursuant to Articles 22.1.2, 22.1.3, or 22.1.5, the **Contractor** waives all rights against the **City**, including its officials and employees, for any damages or losses that are covered under any insurance required under this Article 22 (whether or not such insurance is actually procured or claims are paid thereunder) or any other insurance applicable to the operations of the **Contractor** and/or its employees, agents, or **Subcontractors**.

22.8 In the event the **Contractor** utilizes a self-insurance program to satisfy any of the requirements of this Article 22, the **Contractor** shall ensure that any such self-insurance program provides the **City** with all rights that would be provided by traditional insurance under this Article 22, including but not limited to the defense and indemnification obligations that insurers are required to undertake in liability policies.

22.9 Materiality/Non-Waiver: The **Contractor's** failure to secure policies in complete conformity with this Article 22, or to give an insurance company timely notice of any sort required in this **Contract** or to do anything else required by this Article 22 shall constitute a material breach of this **Contract**. Such breach shall not be waived or otherwise excused by any action or inaction by the **City** at any time.

22.10 Pursuant to General Municipal Law Section 108, this **Contract** shall be void and of no effect unless **Contractor** maintains Workers' Compensation Insurance for the term of this **Contract** to the extent required and in compliance with the New York State Workers' Compensation Law.

22.11 Other Remedies: Insurance coverage provided pursuant to this Article 22 or otherwise shall not relieve the **Contractor** of any liability under this **Contract**, nor shall it preclude the **City** from exercising any rights or taking such other actions available to it under any other provisions of this **Contract** or **Law**.

ARTICLE 23. MONEY RETAINED AGAINST CLAIMS

23.1 If any claim shall be made by any person or entity (including **Other Contractors** with the **City** on this **Project**) against the **City** or against the **Contractor** and the **City** for any of the following:

- (a) An alleged loss, damage, injury, theft or vandalism of any of the kinds referred to in Articles 7 and 12, plus the reasonable costs of defending the **City**, which in the opinion of the **Comptroller** may not be paid by an insurance company (for any reason whatsoever); or
- (b) An infringement of copyrights, patents or use of patented articles, tools, etc., as referred to in Article 57; or
- (c) Damage claimed to have been caused directly or indirectly by the failure of the **Contractor** to perform the **Work** in strict accordance with this **Contract**,

the amount of such claim, or so much thereof as the **Comptroller** may deem necessary, may be withheld by the **Comptroller**, as security against such claim, from any money due hereunder. The **Comptroller**, in his/her discretion, may permit the **Contractor** to substitute other satisfactory security in lieu of the monies so withheld.

23.2 If an action on such claim is timely commenced and the liability of the **City**, or the **Contractor**,

or both, shall have been established therein by a final judgment of a court of competent jurisdiction, or if such claim shall have been admitted by the **Contractor** to be valid, the **Comptroller** shall pay such judgment or admitted claim out of the monies retained by the **Comptroller** under the provisions of this Article 23, and return the balance, if any, without interest, to the **Contractor**.

ARTICLE 24. MAINTENANCE AND GUARANTY

24.1 The **Contractor** shall promptly repair, replace, restore or rebuild, as the **Commissioner** may determine, any finished **Work** in which defects of materials or workmanship may appear or to which damage may occur because of such defects, during the one (1) year period subsequent to the date of **Substantial Completion** (or use and occupancy in accordance with Article 16), except where other periods of maintenance and guaranty are provided for in Schedule A.

24.2 As security for the faithful performance of its obligations hereunder, the **Contractor**, upon filing its requisition for payment on **Substantial Completion**, shall deposit with the **Commissioner** a sum equal to one (1%) percent of the price (or the amount fixed in Schedule A of the General Conditions) in cash or certified check upon a state or national bank and trust company or a check of such bank and trust company signed by a duly authorized officer thereof and drawn to the order of the **Comptroller**, or obligations of the **City**, which the **Comptroller** may approve as of equal value with the sum so required.

24.3 In lieu of the above, the **Contractor** may make such security payment to the **City** by authorizing the **Commissioner** in writing to deduct the amount from the **Substantial Completion** payment which shall be deemed the deposit required above.

24.4 If the **Contractor** has faithfully performed all of its obligations hereunder the **Commissioner** shall so certify to the **Comptroller** within five (5) **Days** after the expiration of one (1) year from the date of **Substantial Completion** and acceptance of the **Work** or within thirty (30) **Days** after the expiration of the guarantee period fixed in the **Specifications**. The security payment shall be repaid to the **Contractor** without interest within thirty (30) **Days** after certification by the **Commissioner** to the **Comptroller** that the **Contractor** has faithfully performed all of its obligations hereunder.

24.5 Notice by the **Commissioner** to the **Contractor** to repair, replace, rebuild or restore such defective or damaged **Work** shall be timely, pursuant to this article, if given not later than ten (10) **Days** subsequent to the expiration of the one (1) year period or other periods provided for herein.

24.6 If the **Contractor** shall fail to repair, replace, rebuild or restore such defective or damaged **Work** promptly after receiving such notice, the **Commissioner** shall have the right to have the **Work** done by others in the same manner as provided for in the completion of a defaulted **Contract**, under Article 51.

24.7 If the security payment so deposited is insufficient to cover the cost of such **Work**, the **Contractor** shall be liable to pay such deficiency on demand by the **Commissioner**.

24.8 The **Engineer's** certificate setting forth the fair and reasonable cost of repairing, replacing, rebuilding or restoring any damaged or defective **Work** when performed by one other than the **Contractor**, shall be binding and conclusive upon the **Contractor** as to the amount thereof.

24.9 The **Contractor** shall obtain all manufacturers' warranties and guaranties of all equipment and materials required by this **Contract** in the name of the **City** and shall deliver same to the **Commissioner**. All of the **City's** rights and title and interest in and to said manufacturers' warranties and guaranties may be assigned by the **City** to any subsequent purchasers of such equipment and materials or lessees of the

premises into which the equipment and materials have been installed.

CHAPTER VI: CHANGES, EXTRA WORK, AND DOCUMENTATION OF CLAIM

ARTICLE 25. CHANGES

25.1 Changes may be made to this **Contract** only as duly authorized in writing by the **Commissioner** in accordance with the **Law** and this **Contract**. All such changes, modifications, and amendments will become a part of the **Contract**. **Work** so ordered shall be performed by the **Contractor**.

25.2 **Contract** changes will be made only for **Work** necessary to complete the **Work** included in the original scope of the **Contract** and/or for non-material changes to the scope of the **Contract**. Changes are not permitted for any material alteration in the scope of **Work** in the **Contract**.

25.3 The **Contractor** shall be entitled to a price adjustment for **Extra Work** performed pursuant to a written change order. Adjustments to price shall be computed in one or more of the following ways:

25.3.1 By applicable unit prices specified in the **Contract**; and/or

25.3.2 By agreement of a fixed price; and/or

25.3.3 By time and material records; and/or

25.3.4 In any other manner approved by the **CCPO**.

25.4 All payments for change orders are subject to pre-audit by the **Engineering Audit Officer** and may be post-audited by the **Comptroller** and/or the **Agency**.

ARTICLE 26. METHODS OF PAYMENT FOR OVERRUNS AND EXTRA WORK

26.1 **Overrun of Unit Price Item**: An overrun is any quantity of a unit price item which the **Contractor** is directed to provide which is in excess of one hundred twenty-five (125%) percent of the estimated quantity for that item set forth in the bid schedule.

26.1.1 For any unit price item, the **Contractor** will be paid at the unit price bid for any quantity up to one hundred twenty-five (125%) percent of the estimated quantity for that item set forth in the bid schedule. If during the progress of the **Work**, the actual quantity of any unit price item required to complete the **Work** approaches the estimated quantity for that item, and for any reason it appears that the actual quantity of any unit price item necessary to complete the **Work** will exceed the estimated quantity for that item by twenty-five (25%) percent, the **Contractor** shall immediately notify the **Engineer** of such anticipated overrun. The **Contractor** shall not be compensated for any quantity of a unit price item provided which is in excess of one hundred twenty-five (125%) percent of the estimated quantity for that item set forth in the bid schedule without written authorization from the **Engineer**.

26.1.2 If the actual quantity of any unit price item necessary to complete the **Work** will exceed one hundred twenty-five (125%) percent of the estimated quantity for that item set forth in the bid schedule, the **City** reserves the right and the **Contractor** agrees to negotiate a new unit price for such item. In no event shall such negotiated new unit price exceed the unit bid price. If the **City** and **Contractor** cannot agree on a new unit price, then the **City** shall order the **Contractor** and the **Contractor** agrees to provide additional quantities of the item on the

basis of time and material records for the actual and reasonable cost as determined under Article 26.2, but in no event at a unit price exceeding the unit price bid.

26.2 **Extra Work:** For **Extra Work** where payment is by agreement on a fixed price in accordance with Article 25.3.2, the price to be paid for such **Extra Work** shall be based on the fair and reasonable estimated cost of the items set forth below. For **Extra Work** where payment is based on time and material records in accordance with Article 25.3.3, the price to be paid for such **Extra Work** shall be the actual and reasonable cost of the items set forth below, calculated in accordance with the formula specified therein, if any.

26.2.1 Necessary materials (including transportation to the **Site**); plus

26.2.2 Necessary direct labor, including payroll taxes (subject to statutory wage caps) and supplemental benefits; plus

26.2.3 Sales and personal property taxes, if any, required to be paid on materials not incorporated into such **Extra Work**; plus

26.2.4 Reasonable rental value of **Contractor**-owned (or **Subcontractor**-owned, as applicable), necessary plant and equipment other than **Small Tools**, plus fuel/energy costs. Except for fuel costs for pick-up trucks which shall be reimbursed based on a consumption of five (5) gallons per shift, fuel costs shall be reimbursed based on actual costs or, in the absence of auditable documentation, the following fuel consumption formula per operating hour: $(.035) \times (\text{HP rating}) \times (\text{Fuel cost/gallon})$. Reasonable rental value is defined as the lower of either seventy-five percent of the monthly prorated rental rates established in "The AED Green Book, Rental Rates and Specifications for Construction Equipment" published by Equipment Watch (the "Green Book"), or seventy-five percent of the monthly prorated rental rates established in the "Rental Rate Blue Book for Construction Equipment" published by Equipment Watch (the "Blue Book") (the applicable Blue Book rate being for rental only without the addition of any operational costs listed in the Blue Book). The reasonable rental value is deemed to be inclusive of all operating costs except for fuel/energy consumption and equipment operator's wages/costs. For multiple shift utilization, reimbursement shall be calculated as follows: first shift shall be seventy-five (75%) percent of such rental rates; second shift shall be sixty (60%) percent of the first shift rate; and third shift shall be forty (40%) percent of the first shift rate. Equipment on standby shall be reimbursed at one-third (1/3) the prorated monthly rental rate. **Contractor**-owned (or **Subcontractor**-owned, as applicable) equipment includes equipment from rental companies affiliated with or controlled by the **Contractor** (or **Subcontractor**, as applicable), as determined by the **Commissioner**. In establishing cost reimbursement for non-operating **Contractor**-owned (or **Subcontractor**-owned, as applicable) equipment (scaffolding, sheeting systems, road plates, etc.), the **City** may restrict reimbursement to a purchase-salvage/life cycle basis if less than the computed rental costs; plus

26.2.5 Necessary installation and dismantling of such plant and equipment, including transportation to and from the **Site**, if any, provided that, in the case of non-**Contractor**-owned (or non-**Subcontractor**-owned, as applicable) equipment rented from a third party, the cost of installation and dismantling are not allowable if such costs are included in the rental rate; plus

26.2.6 Necessary fees charged by governmental entities; plus

26.2.7 Necessary construction-related service fees charged by non-governmental entities, such as landfill tipping fees; plus

26.2.8 Reasonable rental costs of non-**Contractor**-owned (or non-**Subcontractor**-owned, as applicable) necessary plant and equipment other than **Small Tools**, plus fuel/energy costs. Except for fuel costs for pick-up trucks which shall be reimbursed based on a consumption of five (5) gallons per shift, fuel costs shall be reimbursed based on actual costs or, in the absence of auditable documentation, the following fuel consumption formula per hour of operation: $(.035) \times (\text{HP rating}) \times (\text{Fuel cost/gallon})$. In lieu of renting, the **City** reserves the right to direct the purchase of non-operating equipment (scaffolding, sheeting systems, road plates, etc.), with payment on a purchase-salvage/life cycle basis, if less than the projected rental costs; plus

26.2.9 Workers' Compensation Insurance, and any insurance coverage expressly required by the **City** for the performance of the **Extra Work** which is different than the types of insurance required by Article 22 and Schedule A of the General Conditions. The cost of Workers' Compensation Insurance is subject to applicable payroll limitation caps and shall be based upon the carrier's Manual Rate for such insurance derived from the applicable class Loss Cost ("LC") and carrier's Lost Cost Multiplier ("LCM") approved by the New York State Department of Financial Services, and with the exception of experience rating, rate modifiers as promulgated by the New York Compensation Insurance Rating Board ("NYCIRB"); plus

26.2.10 Additional costs incurred as a result of the **Extra Work** for performance and payment bonds; plus

26.2.11 Twelve percent (12%) percent of the total of items in Articles 26.2.1 through 26.2.5 as compensation for overhead, except that no percentage for overhead will be allowed on **Payroll Taxes** or on the premium portion of overtime pay or on sales and personal property taxes. Overhead shall include without limitation, all costs and expenses in connection with administration, management superintendence, small tools, and insurance required by Schedule A of the General Conditions other than Workers' Compensation Insurance; plus

26.2.12 Ten (10%) percent of the total of items in Articles 26.2.1 through 26.2.5, plus the items in Article 26.2.11, as compensation for profit, except that no percentage for profit will be allowed on **Payroll Taxes** or on the premium portion of overtime pay or on sales and personal property taxes; plus

26.2.13 Five (5%) percent of the total of items in Articles 26.2.6 through 26.2.10 as compensation for overhead and profit.

26.3 Where the **Extra Work** is performed in whole or in part by other than the **Contractor's** own forces pursuant to Article 26.2, the **Contractor** shall be paid, subject to pre-audit by the **Engineering Audit Officer**, the cost of such **Work** computed in accordance with Article 26.2 above, plus an additional allowance of five (5%) percent to cover the **Contractor's** overhead and profit.

26.4 Where a change is ordered, involving both **Extra Work** and omitted or reduced **Contract Work**, the **Contract** price shall be adjusted, subject to pre-audit by the **EAO**, in an amount based on the difference between the cost of such **Extra Work** and of the omitted or reduced **Work**.

26.5 Where the **Contractor** and the **Commissioner** can agree upon a fixed price for **Extra Work** in accordance with Article 25.3.2 or another method of payment for **Extra Work** in accordance with Article 25.3.4, or for **Extra Work** ordered in connection with omitted **Work**, such method, subject to pre-audit by the **EAO**, may, at the option of the **Commissioner**, be substituted for the cost plus a percentage method provided in Article 26.2; provided, however, that if the **Extra Work** is performed by a **Subcontractor**, the **Contractor** shall not be entitled to receive more than an additional allowance of five (5%) percent for overhead and profit over

the cost of such **Subcontractor's Work** as computed in accordance with Article 26.2.

ARTICLE 27. RESOLUTION OF DISPUTES

27.1 All disputes between the **City** and the **Contractor** of the kind delineated in this Article 27.1 that arise under, or by virtue of, this **Contract** shall be finally resolved in accordance with the provisions of this Article 27 and the **PPB** Rules. This procedure for resolving all disputes of the kind delineated herein shall be the exclusive means of resolving any such disputes.

27.1.1 This Article 27 shall not apply to disputes concerning matters dealt with in other sections of the **PPB** Rules, or to disputes involving patents, copyrights, trademarks, or trade secrets (as interpreted by the courts of New York State) relating to proprietary rights in computer software.

27.1.2 This Article 27 shall apply only to disputes about the scope of **Work** delineated by the **Contract**, the interpretation of **Contract** documents, the amount to be paid for **Extra Work** or disputed work performed in connection with the **Contract**, the conformity of the **Contractor's Work** to the **Contract**, and the acceptability and quality of the **Contractor's Work**; such disputes arise when the **Engineer, Resident Engineer, Engineering Audit Officer**, or other designee of the **Commissioner** makes a determination with which the **Contractor** disagrees.

27.2 All determinations required by this Article 27 shall be made in writing clearly stated, with a reasoned explanation for the determination based on the information and evidence presented to the party making the determination. Failure to make such determination within the time required by this Article 27 shall be deemed a non-determination without prejudice that will allow application to the next level.

27.3 During such time as any dispute is being presented, heard, and considered pursuant to this Article 27, the **Contract** terms shall remain in force and the **Contractor** shall continue to perform **Work** as directed by the **ACCO** or the **Engineer**. Failure of the **Contractor** to continue **Work** as directed shall constitute a waiver by the **Contractor** of its claim.

27.4 Presentation of Disputes to **Commissioner**.

Notice of Dispute and Agency Response. The **Contractor** shall present its dispute in writing ("Notice of Dispute") to the **Commissioner** within thirty (30) Days of receiving written notice of the determination or action that is the subject of the dispute. This notice requirement shall not be read to replace any other notice requirements contained in the **Contract**. The Notice of Dispute shall include all the facts, evidence, documents, or other basis upon which the **Contractor** relies in support of its position, as well as a detailed computation demonstrating how any amount of money claimed by the **Contractor** in the dispute was arrived at. Within thirty (30) Days after receipt of the detailed written submission comprising the complete Notice of Dispute, the **Engineer, Resident Engineer, Engineering Audit Officer**, or other designee of the **Commissioner** shall submit to the **Commissioner** all materials he or she deems pertinent to the dispute. Following initial submissions to the **Commissioner**, either party may demand of the other the production of any document or other material the demanding party believes may be relevant to the dispute. The requested party shall produce all relevant materials that are not otherwise protected by a legal privilege recognized by the courts of New York State. Any question of relevancy shall be determined by the **Commissioner** whose decision shall be final. Willful failure of the **Contractor** to produce any requested material whose relevancy the **Contractor** has not disputed, or whose relevancy has been affirmatively determined, shall constitute a waiver by the **Contractor** of its claim.

27.4.1 **Commissioner Inquiry.** The **Commissioner** shall examine the material and may, in his or her discretion, convene an informal conference with the **Contractor**, the **ACCO**, and the **Engineer, Resident Engineer, Engineering Audit Officer**, or other designee of the **Commissioner** to resolve the issue by mutual consent prior to reaching a determination. The **Commissioner** may seek such technical or other expertise as he or she shall deem appropriate, including the use of neutral mediators, and require any such additional material from either or both parties as he or she deems fit. The **Commissioner's** ability to render, and the effect of, a decision hereunder shall not be impaired by any negotiations in connection with the dispute presented, whether or not the **Commissioner** participated therein. The **Commissioner** may or, at the request of any party to the dispute, shall compel the participation of any **Other Contractor** with a contract related to the **Work** of this **Contract**, and that **Contractor** shall be bound by the decision of the **Commissioner**. Any **Other Contractor** thus brought into the dispute resolution proceeding shall have the same rights and obligations under this Article 27 as the **Contractor** initiating the dispute.

27.4.2 **Commissioner Determination.** Within thirty (30) **Days** after the receipt of all materials and information, or such longer time as may be agreed to by the parties, the **Commissioner** shall make his or her determination and shall deliver or send a copy of such determination to the **Contractor**, the **ACCO**, and **Engineer, Resident Engineer, Engineering Audit Officer**, or other designee of the **Commissioner**, as applicable, together with a statement concerning how the decision may be appealed.

27.4.3 **Finality of Commissioner's Decision.** The **Commissioner's** decision shall be final and binding on all parties, unless presented to the Contract Dispute Resolution Board pursuant to this Article 27. The **City** may not take a petition to the Contract Dispute Resolution Board. However, should the **Contractor** take such a petition, the **City** may seek, and the Contract Dispute Resolution Board may render, a determination less favorable to the **Contractor** and more favorable to the **City** than the decision of the **Commissioner**.

27.5 **Presentation of Dispute to the Comptroller.** Before any dispute may be brought by the **Contractor** to the Contract Dispute Resolution Board, the **Contractor** must first present its claim to the **Comptroller** for his or her review, investigation, and possible adjustment.

27.5.1 **Time, Form, and Content of Notice.** Within thirty (30) **Days** of its receipt of a decision by the **Commissioner**, the **Contractor** shall submit to the **Comptroller** and to the **Commissioner** a Notice of Claim regarding its dispute with the **Agency**. The Notice of Claim shall consist of (i) a brief written statement of the substance of the dispute, the amount of money, if any, claimed and the reason(s) the **Contractor** contends the dispute was wrongly decided by the **Commissioner**; (ii) a copy of the written decision of the **Commissioner**; and (iii) a copy of all materials submitted by the **Contractor** to the **Agency**, including the Notice of Dispute. The **Contractor** may not present to the **Comptroller** any material not presented to the **Commissioner**, except at the request of the **Comptroller**.

27.5.2 Response. Within thirty (30) **Days** of receipt of the Notice of Claim, the **Agency** shall make available to the **Comptroller** a copy of all material submitted by the **Agency** to the **Commissioner** in connection with the dispute. The **Agency** may not present to the **Comptroller** any material not presented to the **Commissioner** except at the request of the **Comptroller**.

27.5.3 **Comptroller** Investigation. The **Comptroller** may investigate the claim in dispute and, in the course of such investigation, may exercise all powers provided in Sections 7-201 and 7-203 of the Administrative Code. In addition, the **Comptroller** may demand of either party, and such party shall provide, whatever additional material the **Comptroller** deems pertinent to the claim, including original business records of the **Contractor**. Willful failure of the **Contractor** to produce within fifteen (15) **Days** any material requested by the **Comptroller** shall constitute a waiver by the **Contractor** of its claim. The **Comptroller** may also schedule an informal conference to be attended by the **Contractor**, **Agency** representatives, and any other personnel desired by the **Comptroller**.

27.5.4 Opportunity of **Comptroller** to Compromise or Adjust Claim. The **Comptroller** shall have forty-five (45) **Days** from his or her receipt of all materials referred to in Article 27.5.3 to investigate the disputed claim. The period for investigation and compromise may be further extended by agreement between the **Contractor** and the **Comptroller**, to a maximum of ninety (90) **Days** from the **Comptroller's** receipt of all materials. The **Contractor** may not present its petition to the Contract Dispute Resolution Board until the period for investigation and compromise delineated in this Article 27.5.4 has expired. In compromising or adjusting any claim hereunder, the **Comptroller** may not revise or disregard the terms of the **Contract** between the parties.

27.6 Contract Dispute Resolution Board. There shall be a Contract Dispute Resolution Board composed of:

27.6.1 The chief administrative law judge of the Office of Administrative Trials and Hearings (OATH) or his/her designated OATH administrative law judge, who shall act as chairperson, and may adopt operational procedures and issue such orders consistent with this Article 27 as may be necessary in the execution of the Contract Dispute Resolution Board's functions, including, but not limited to, granting extensions of time to present or respond to submissions;

27.6.2 The **CCPO** or his/her designee; any designee shall have the requisite background to consider and resolve the merits of the dispute and shall not have participated personally and substantially in the particular matter that is the subject of the dispute or report to anyone who so participated; and

27.6.3 A person with appropriate expertise who is not an employee of the **City**. This person shall be selected by the presiding administrative law judge from a prequalified panel of individuals, established and administered by OATH with appropriate background to act as decision-makers in a dispute. Such individual may not have a contract or dispute with the **City** or be an officer or employee of any company or organization that does, or regularly represents persons, companies, or organizations having disputes with the **City**.

27.7 Petition to the Contract Dispute Resolution Board. In the event the claim has not been settled or adjusted by the **Comptroller** within the period provided in this Article 27, the **Contractor**, within thirty (30) **Days** thereafter, may petition the Contract Dispute Resolution Board to review the

Commissioner's determination.

27.7.1 Form and Content of Petition by **Contractor**. The **Contractor** shall present its dispute to the Contract Dispute Resolution Board in the form of a petition, which shall include (i) a brief written statement of the substance of the dispute, the amount of money, if any, claimed, and the reason(s) the **Contractor** contends the dispute was wrongly decided by the **Commissioner**; (ii) a copy of the written Decision of the **Commissioner**, (iii) copies of all materials submitted by the **Contractor** to the Agency; (iv) a copy of the written decision of the **Comptroller**, if any, and (v) copies of all correspondence with, or written material submitted by the **Contractor**, to the **Comptroller**. The **Contractor** shall concurrently submit four (4) complete sets of the Petition: one set to the **City** Corporation Counsel (Attn: Commercial and Real Estate Litigation Division) and three (3) sets to the Contract Dispute Resolution Board at OATH's offices with proof of service on the **City** Corporation Counsel. In addition, the **Contractor** shall submit a copy of the written statement of the substance of the dispute, cited in (i) above, to both the **Commissioner** and the **Comptroller**.

27.7.2 **Agency Response**. Within thirty (30) **Days** of its receipt of the Petition by the **City** Corporation Counsel, the **Agency** shall respond to the brief written statement of the **Contractor** and make available to the Contract Dispute Resolution Board all material it submitted to the **Commissioner** and **Comptroller**. Three (3) complete copies of the **Agency** response shall be provided to the Contract Dispute Resolution Board and one to the **Contractor**. Extensions of time for submittal of the **Agency** response shall be given as necessary upon a showing of good cause or, upon consent of the parties, for an initial period of up to thirty (30) **Days**.

27.7.3 Further Proceedings. The Contract Dispute Resolution Board shall permit the **Contractor** to present its case by submission of memoranda, briefs, and oral argument. The Contract Dispute Resolution Board shall also permit the **Agency** to present its case in response to the **Contractor** by submission of memoranda, briefs, and oral argument. If requested by the **City** Corporation Counsel, the **Comptroller** shall provide reasonable assistance in the preparation of the **Agency's** case. Neither the **Contractor** nor the **Agency** may support its case with any documentation or other material that was not considered by the **Comptroller**, unless requested by the Contract Dispute Resolution Board. The Contract Dispute Resolution Board, in its discretion, may seek such technical or other expert advice as it shall deem appropriate and may seek, on its own or upon application of a party, any such additional material from any party as it deems fit. The Contract Dispute Resolution Board, in its discretion, may combine more than one dispute between the parties for concurrent resolution.

27.7.4 Contract Dispute Resolution Board Determination. Within forty-five (45) **Days** of the conclusion of all written submissions and oral arguments, the Contract Dispute Resolution Board shall render a written decision resolving the dispute. In an unusually complex case, the Contract Dispute Resolution Board may render its decision in a longer period, not to exceed ninety (90) **Days**, and shall so advise the parties at the commencement of this period. The Contract Dispute Resolution Board's decision must be consistent with the terms of the **Contract**. Decisions of the Contract Dispute Resolution Board shall only resolve matters before the Contract Dispute Resolution Board and shall not have precedential effect with respect to matters not before the Contract Dispute Resolution Board.

27.7.5 Notification of Contract Dispute Resolution Board Decision. The Contract Dispute Resolution Board shall send a copy of its decision to the **Contractor**, the **ACCO**, the Engineer, the **Comptroller**, the **City** Corporation Counsel, the CCPO, and the **PPB**. A decision in favor of the **Contractor** shall be subject to the prompt payment provisions of the **PPB** Rules. The

Required Payment Date shall be thirty (30) Days after the date the parties are formally notified of the Contract Dispute Resolution Board's decision.

27.7.6 Finality of Contract Dispute Resolution Board Decision. The Contract Dispute Resolution Board's decision shall be final and binding on all parties. Any party may seek review of the Contract Dispute Resolution Board's decision solely in the form of a challenge, filed within four (4) months of the date of the Contract Dispute Resolution Board's decision, in a court of competent jurisdiction of the State of New York, County of New York pursuant to Article 78 of the Civil Practice Law and Rules. Such review by the court shall be limited to the question of whether or not the Contract Dispute Resolution Board's decision was made in violation of lawful procedure, was affected by an error of **Law**, or was arbitrary and capricious or an abuse of discretion. No evidence or information shall be introduced or relied upon in such proceeding that was not presented to the Contract Dispute Resolution Board in accordance with this Article 27.

27.8 Any termination, cancellation, or alleged breach of the **Contract** prior to or during the pendency of any proceedings pursuant to this Article 27 shall not affect or impair the ability of the **Commissioner** or Contract Dispute Resolution Board to make a binding and final decision pursuant to this Article 27.

ARTICLE 28. RECORD KEEPING FOR EXTRA OR DISPUTED WORK OR WORK ON A TIME & MATERIALS BASIS

28.1 While the **Contractor** or any of its **Subcontractors** is performing **Work** on a time and material basis or **Extra Work** on a time and material basis ordered by the **Commissioner** under Article 25, or where the **Contractor** believes that it or any of its **Subcontractors** is performing **Extra Work** but a final determination by **Agency** has not been made, or the **Contractor** or any of its **Subcontractors** is performing disputed **Work** (whether on or off the **Site**), or complying with a determination or order under protest in accordance with Articles 11, 27, and 30, in each such case the **Contractor** shall furnish the **Resident Engineer** daily with three (3) copies of written statements signed by the **Contractor's** representative at the **Site** showing:

28.1.1 The name, trade, and number of each worker employed on such **Work** or engaged in complying with such determination or order, the number of hours employed, and the character of the **Work** each is doing; and

28.1.2 The nature and quantity of any materials, plant and equipment furnished or used in connection with the performance of such **Work** or compliance with such determination or order, and from whom purchased or rented.

28.2 A copy of such statement will be countersigned by the **Resident Engineer**, noting thereon any items not agreed to or questioned, and will be returned to the **Contractor** within two (2) **Days** after submission.

28.3 The **Contractor** and its **Subcontractors**, when required by the **Commissioner**, or the **Comptroller**, shall also produce for inspection, at the office of the **Contractor** or **Subcontractor**, any and all of its books, bid documents, financial statements, vouchers, records, daily job diaries and reports, and cancelled checks, and any other documents relating to showing the nature and quantity of the labor, materials, plant and equipment actually used in the performance of such **Work**, or in complying with such determination or order, and the amounts expended therefor, and shall permit the **Commissioner** and the

Comptroller to make such extracts therefrom, or copies thereof, as they or either of them may desire.

28.4 In connection with the examination provided for herein, the **Commissioner**, upon demand therefor, will produce for inspection by the **Contractor** such records as the **Agency** may have with respect to such **Extra Work** or disputed **Work** performed under protest pursuant to order of the **Commissioner**, except those records and reports which may have been prepared for the purpose of determining the accuracy and validity of the **Contractor's** claim.

28.5 Failure to comply strictly with these requirements shall constitute a waiver of any claim for extra compensation or damages on account of the performance of such **Work** or compliance with such determination or order.

ARTICLE 29. OMITTED WORK

29.1 If any **Contract Work** in a lump sum **Contract**, or if any part of a lump sum item in a unit price, lump sum, or percentage-bid **Contract** is omitted by the **Commissioner** pursuant to Article 33, the **Contract** price, subject to audit by the EAO, shall be reduced by a pro rata portion of the lump sum bid amount based upon the percent of **Work** omitted subject to Article 29.4. For the purpose of determining the pro rata portion of the lump sum bid amount, the bid breakdown submitted in accordance with Article 41 shall be considered, but shall not be the determining factor.

29.2 If the whole of a lump sum item or units of any other item is so omitted by the **Commissioner** in a unit price, lump sum, or percentage-bid **Contract**, then no payment will be made therefor except as provided in Article 29.4.

29.3 For units that have been ordered but are only partially completed, the unit price shall be reduced by a pro rata portion of the unit price bid based upon the percentage of **Work** omitted subject to Article 29.4.

29.4 In the event the **Contractor**, with respect to any omitted **Work**, has purchased any non-cancelable material and/or equipment that is not capable of use except in the performance of this **Contract** and has been specifically fabricated for the sole purpose of this **Contract**, but not yet incorporated into the **Work**, the **Contractor** shall be paid for such material and/or equipment in accordance with Article 64.2.1(b); provided, however, such payment is contingent upon the **Contractor's** delivery of such material and/or equipment in acceptable condition to a location designated by the **City**.

29.5 The **Contractor** agrees to make no claim for damages or for loss of overhead and profit with regard to any omitted **Work**.

ARTICLE 30. NOTICE AND DOCUMENTATION OF COSTS AND DAMAGES; PRODUCTION OF FINANCIAL RECORDS

30.1 If the **Contractor** shall claim to be sustaining damages by reason of any act or omission of the **City** or its agents, it shall submit to the **Commissioner** within forty-five (45) **Days** from the time such damages are first incurred, and every thirty (30) **Days** thereafter to the extent additional damages are being incurred for the same condition, verified statements of the details and the amounts of such damages, together with documentary evidence of such damages. The **Contractor** may submit any of the above statements within such additional time as may be granted by the **Commissioner** in writing upon written request therefor. Failure of the **Commissioner** to respond in writing to a written request for additional time within thirty (30) **Days** shall be deemed a denial of the request. On failure of the **Contractor** to strictly comply with

the foregoing provisions, such claims shall be deemed waived and no right to recover on such claims shall exist. Damages that the **Contractor** may claim in any action or dispute resolution procedure arising under or by reason of this **Contract** shall not be different from or in excess of the statements and documentation made pursuant to this Article 30. This Article 30.1 does not apply to claims submitted to the **Commissioner** pursuant to Article 11 or to claims disputing a determination under Article 27.

30.2 In addition to the foregoing statements, the **Contractor** shall, upon notice from the **Commissioner**, produce for examination at the **Contractor's** office, by the **Engineer, Architect or Project Manager**, all of its books of account, bills, invoices, payrolls, subcontracts, time books, daily reports, bank deposit books, bank statements, check books, and cancelled checks, showing all of its acts and transactions in connection with or relating to or arising by reason of this **Contract**, and submit itself and persons in its employment, for examination under oath by any person designated by the **Commissioner** or **Comptroller** to investigate claims made or disputes against the **City** under this **Contract**. At such examination, a duly authorized representative of the **Contractor** may be present.

30.3 In addition to the statements required under Article 28 and this Article 30, the **Contractor** and/or its **Subcontractor** shall, within thirty (30) **Days** upon notice from the **Commissioner** or **Comptroller**, produce for examination at the **Contractor's** and/or **Subcontractor's** office, by a representative of either the **Commissioner** or **Comptroller**, all of its books of account, bid documents, financial statements, accountant workpapers, bills, invoices, payrolls, subcontracts, time books, daily reports, bank deposit books, bank statements, check books, and cancelled checks, showing all of its acts and transactions in connection with or relating to or arising by reason of this **Contract**. Further, the **Contractor** and/or its **Subcontractor** shall submit any person in its employment, for examination under oath by any person designated by the **Commissioner** or **Comptroller** to investigate claims made or disputes against the **City** under this **Contract**. At such examination, a duly authorized representative of the **Contractor** may be present.

30.4 Unless the information and examination required under Article 30.3 is provided by the **Contractor** and/or its **Subcontractor** upon thirty (30) **Days'** notice from the **Commissioner** or **Comptroller**, or upon the **Commissioner's** or **Comptroller's** written authorization to extend the time to comply, the **City** shall be released from all claims arising under, relating to or by reason of this **Contract**, except for sums certified by the **Commissioner** to be due under the provisions of this **Contract**. It is further stipulated and agreed that no person has the power to waive any of the foregoing provisions and that in any action or dispute resolution procedure against the **City** to recover any sum in excess of the sums certified by the **Commissioner** to be due under or by reason of this **Contract**, the **Contractor** must allege in its complaint and prove, at trial or during such dispute resolution procedure, compliance with the provisions of this Article 30.

30.5 In addition, after the commencement of any action or dispute resolution procedure by the **Contractor** arising under or by reason of this **Contract**, the **City** shall have the right to require the **Contractor** to produce for examination under oath, up until the trial of the action or hearing before the Contract Dispute Resolution Board, the books and documents described in Article 30.3 and submit itself and all persons in its employ for examination under oath. If this Article 30 is not complied with as required, then the **Contractor** hereby consents to the dismissal of the action or dispute resolution procedure.

CHAPTER VII: POWERS OF THE RESIDENT ENGINEER, THE ENGINEER OR ARCHITECT AND THE COMMISSIONER

ARTICLE 31. THE RESIDENT ENGINEER

31.1 The **Resident Engineer** shall have the power to inspect, supervise, and control the performance

of the **Work**, subject to review by the **Commissioner**. The **Resident Engineer** shall not, however, have the power to issue an **Extra Work** order, except as specifically designated in writing by the **Commissioner**.

ARTICLE 32. THE ENGINEER OR ARCHITECT OR PROJECT MANAGER

32.1 The **Engineer** or **Architect** or **Project Manager**, in addition to those matters elsewhere herein delegated to the **Engineer** and expressly made subject to his/her determination, direction or approval, shall have the power, subject to review by the **Commissioner**:

32.1.1 To determine the amount, quality, and location of the **Work** to be paid for hereunder; and

32.1.2 To determine all questions in relation to the **Work**, to interpret the **Contract Drawings, Specifications, and Addenda**, and to resolve all patent inconsistencies or ambiguities therein; and

32.1.3 To determine how the **Work** of this **Contract** shall be coordinated with **Work** of **Other Contractors** engaged simultaneously on this **Project**, including the power to suspend any part of the **Work**, but not the whole thereof; and

32.1.4 To make minor changes in the **Work** as he/she deems necessary, provided such changes do not result in a net change in the cost to the **City** or to the **Contractor** of the **Work** to be done under the **Contract**; and

32.1.5 To amplify the **Contract Drawings**, add explanatory information and furnish additional **Specifications** and drawings, consistent with this **Contract**.

32.2 The foregoing enumeration shall not imply any limitation upon the power of the **Engineer** or **Architect** or **Project Manager**, for it is the intent of this **Contract** that all of the **Work** shall generally be subject to his/her determination, direction, and approval, except where the determination, direction or approval of someone other than the **Engineer** or **Architect** or **Project Manager** is expressly called for herein.

32.3 The **Engineer** or **Architect** or **Project Manager** shall not, however, have the power to issue an **Extra Work** order, except as specifically designated in writing by the **Commissioner**.

ARTICLE 33. THE COMMISSIONER

33.1 The **Commissioner**, in addition to those matters elsewhere herein expressly made subject to his/her determination, direction or approval, shall have the power:

33.1.1 To review and make determinations on any and all questions in relation to this **Contract** and its performance; and

33.1.2 To modify or change this **Contract** so as to require the performance of **Extra Work** (subject, however, to the limitations specified in Article 25) or the omission of **Contract Work**; and

33.1.3 To suspend the whole or any part of the **Work** whenever in his/her judgment such suspension is required:

33.1.3(a) In the interest of the **City** generally; or

33.1.3(b) To coordinate the **Work** of the various contractors engaged on this **Project** pursuant to the provisions of Article 12; or

33.1.3(c) To expedite the completion of the entire **Project** even though the completion of this particular **Contract** may thereby be delayed.

ARTICLE 34. NO ESTOPPEL

34.1 Neither the **City** nor any **Agency**, official, agent or employee thereof, shall be bound, precluded or estopped by any determination, decision, approval, order, letter, payment or certificate made or given under or in connection with this **Contract** by the **City**, the **Commissioner**, the **Engineer**, the **Resident Engineer**, or any other official, agent or employee of the **City**, either before or after the final completion and acceptance of the **Work** and payment therefor:

34.1.1 From showing the true and correct classification, amount, quality or character of the **Work** actually done; or that any such determination, decision, order, letter, payment or certificate was untrue, incorrect or improperly made in any particular, or that the **Work**, or any part thereof, does not in fact conform to the requirements of this **Contract**; and

34.1.2 From demanding and recovering from the **Contractor** any overpayment made to it, or such damages as the **City** may sustain by reason of the **Contractor's** failure to perform each and every part of its **Contract**.

CHAPTER VIII: LABOR PROVISIONS

ARTICLE 35. EMPLOYEES

35.1 The **Contractor** and its **Subcontractors** shall not employ on the **Work**:

35.1.1 Anyone who is not competent, faithful and skilled in the **Work** for which he/she shall be employed; and whenever the **Commissioner** shall inform the **Contractor**, in writing, that any employee is, in his/her opinion, incompetent, unfaithful or disobedient, that employee shall be discharged from the **Work** forthwith, and shall not again be employed upon it; or

35.1.2 Any labor, materials or means whose employment, or utilization during the course of this **Contract**, may tend to or in any way cause or result in strikes, work stoppages, delays, suspension of **Work** or similar troubles by workers employed by the **Contractor** or its **Subcontractors**, or by any of the trades working in or about the buildings and premises where **Work** is being performed under this **Contract**, or by **Other Contractors** or their **Subcontractors** pursuant to other contracts, or on any other building or premises owned or operated by the **City**, its **Agencies**, departments, boards or authorities. Any violation by the **Contractor** of this requirement may, upon certification of the **Commissioner**, be considered as proper and sufficient cause for declaring the **Contractor** to be in default, and for the **City** to take action against it as set forth in Chapter X of this **Contract**, or such other article of this **Contract** as the Commissioner may deem proper; or

35.1.3 In accordance with Section 220.3-e of the Labor Law of the State of New York (hereinafter "Labor Law"), the **Contractor** and its **Subcontractors** shall not employ on the **Work** any apprentice, unless he/she is a registered individual, under a bona fide program registered with the New York State Department of Labor. The allowable ratio of apprentices to journey-level workers in any craft classification shall not be greater than the ratio permitted to the **Contractor** as to its work force on any job under the registered program. Any employee listed on a payroll at an apprentice wage rate, who is not registered as above, shall be paid the wage rate determined by the **Comptroller** of the **City** for the classification of **Work** actually performed. The **Contractor** or **Subcontractor** will be required to furnish written evidence of the registration of its program and apprentices as well as all the appropriate ratios and wage rates, for the area of the construction prior to using any apprentices on the **Contract Work**.

35.2 If the total cost of the **Work** under this **Contract** is at least two hundred fifty thousand (\$250,000) dollars, all laborers, workers, and mechanics employed in the performance of the **Contract** on the public work site, either by the **Contractor**, **Subcontractor** or other person doing or contracting to do the whole or a part of the **Work** contemplated by the **Contract**, shall be certified prior to performing any **Work** as having successfully completed a course in construction safety and health approved by the United States Department of Labor's Occupational Safety and Health Administration that is at least ten (10) hours in duration.

35.3 In accordance with Local Law Nos. 30-2012 and 33-2012, codified at sections 6-132 and 12-113 of the Administrative Code, respectively,

35.3.1 The **Contractor** shall not take an adverse personnel action with respect to an officer or employee in retaliation for such officer or employee making a report of information concerning conduct which such officer or employee knows or reasonably believes to involve corruption, criminal activity, conflict of interest, gross mismanagement or abuse of authority by any officer or employee relating to this **Contract** to (a) the Commissioner of the Department of Investigation, (b) a member of the New York City Council, the Public Advocate, or the **Comptroller**, or (c) the **CCPO**, **ACCO**, **Agency** head, or **Commissioner**.

35.3.2 If any of the **Contractor**'s officers or employees believes that he or she has been the subject of an adverse personnel action in violation of Article 35.3.1, he or she shall be entitled to bring a cause of action against the **Contractor** to recover all relief necessary to make him or her whole. Such relief may include but is not limited to: (a) an injunction to restrain continued retaliation, (b) reinstatement to the position such employee would have had but for the retaliation or to an equivalent position, (c) reinstatement of full fringe benefits and seniority rights, (d) payment of two times back pay, plus interest, and (e) compensation for any special damages sustained as a result of the retaliation, including litigation costs and reasonable attorney's fees.

35.3.3 The **Contractor** shall post a notice provided by the **City** in a prominent and accessible place on any site where work pursuant to the **Contract** is performed that contains information about:

35.3.3(a) how its employees can report to the New York City Department of Investigation allegations of fraud, false claims, criminality or corruption arising out of or in connection with the **Contract**; and

35.3.3(b) the rights and remedies afforded to its employees under Administrative Code sections 7-805 (the New York City False Claims Act) and 12-113 (the Whistleblower Protection Expansion Act) for lawful acts taken in connection with the

reporting of allegations of fraud, false claims, criminality or corruption in connection with the **Contract**.

35.3.4 For the purposes of this Article 35.3, “adverse personnel action” includes dismissal, demotion, suspension, disciplinary action, negative performance evaluation, any action resulting in loss of staff, office space, equipment or other benefit, failure to appoint, failure to promote, or any transfer or assignment or failure to transfer or assign against the wishes of the affected officer or employee.

35.3.5 This Article 35.3 is applicable to all of the **Contractor’s Subcontractors** having subcontracts with a value in excess of \$100,000; accordingly, the **Contractor** shall include this rider in all subcontracts with a value a value in excess of \$100,000.

35.4 Article 35.3 is not applicable to this **Contract** if it is valued at \$100,000 or less. Articles 35.3.1, 35.3.2, 35.3.4, and 35.3.5 are not applicable to this **Contract** if it was solicited pursuant to a finding of an emergency.

35.5 Paid Sick Leave Law.

35.5.1 Introduction and General Provisions.

35.5.1(a) The Earned Sick Time Act, also known as the Paid Sick Leave Law (“PSLL”), requires covered employees who annually perform more than 80 hours of work in New York City to be provided with paid sick time². Contractors of the **City** or of other governmental entities may be required to provide sick time pursuant to the PSLL.

35.5.1(b) The PSLL became effective on April 1, 2014, and is codified at Title 20, Chapter 8, of the New York City Administrative Code. It is administered by the City’s Department of Consumer Affairs (“DCA”); DCA’s rules promulgated under the PSLL are codified at Chapter 7 of Title 6 of the Rules of the City of New York (“Rules”).

35.5.1(c) The **Contractor** agrees to comply in all respects with the PSLL and the Rules, and as amended, if applicable, in the performance of this **Contract**. The **Contractor** further acknowledges that such compliance is a material term of this **Contract** and that failure to comply with the PSLL in performance of this **Contract** may result in its termination.

35.5.1(d) The **Contractor** must notify the **Agency Chief Contracting Officer** of the **Agency** with whom it is contracting in writing within ten (10) days of receipt of a complaint (whether oral or written) regarding the PSLL involving the performance of this **Contract**. Additionally, the **Contractor** must cooperate with DCA’s education efforts and must comply with DCA’s subpoenas and other document demands as set forth in the PSLL and Rules.

35.5.1(e) The PSLL is summarized below for the convenience of the **Contractor**. The **Contractor** is advised to review the PSLL and Rules in their entirety. On the

² Pursuant to the PSLL, if fewer than five employees work for the same employer, as determined pursuant to New York City Administrative Code § 20-912(g), such employer has the option of providing such employees uncompensated sick time.

website www.nyc.gov/PaidSickLeave there are links to the PSL and the associated Rules as well as additional resources for employers, such as Frequently Asked Questions, timekeeping tools and model forms, and an event calendar of upcoming presentations and webinars at which the **Contractor** can get more information about how to comply with the PSL. The **Contractor** acknowledges that it is responsible for compliance with the PSL notwithstanding any inconsistent language contained herein.

35.5.2 Pursuant to the PSL and the Rules: Applicability, Accrual, and Use.

35.5.2(a) An employee who works within the City of New York for more than eighty hours in any consecutive 12-month period designated by the employer as its “calendar year” pursuant to the PSL (“Year”) must be provided sick time. Employers must provide a minimum of one hour of sick time for every 30 hours worked by an employee and compensation for such sick time must be provided at the greater of the employee’s regular hourly rate or the minimum wage. Employers are not required to provide more than 40 hours of sick time to an employee in any Year.

35.5.2(b) An employee has the right to determine how much sick time he or she will use, provided that employers may set a reasonable minimum increment for the use of sick time not to exceed four hours per **Day**. In addition, an employee may carry over up to 40 hours of unused sick time to the following Year, provided that no employer is required to allow the use of more than forty hours of sick time in a Year or carry over unused paid sick time if the employee is paid for such unused sick time and the employer provides the employee with at least the legally required amount of paid sick time for such employee for the immediately subsequent Year on the first **Day** of such Year.

35.5.2(c) An employee entitled to sick time pursuant to the PSL may use sick time for any of the following:

- i. such employee’s mental illness, physical illness, injury, or health condition or the care of such illness, injury, or condition or such employee’s need for medical diagnosis or preventive medical care;
- ii. such employee’s care of a family member (an employee’s child, spouse, domestic partner, parent, sibling, grandchild or grandparent, or the child or parent of an employee’s spouse or domestic partner) who has a mental illness, physical illness, injury or health condition or who has a need for medical diagnosis or preventive medical care;
- iii. closure of such employee’s place of business by order of a public official due to a public health emergency; or
- iv. such employee’s need to care for a child whose school or childcare provider has been closed due to a public health emergency.

35.5.2(d) An employer must not require an employee, as a condition of taking sick time, to search for a replacement. However, an employer may require an employee to provide: reasonable notice of the need to use sick time; reasonable documentation that the use of sick time was needed for a reason above if for an absence of more than three consecutive work days; and/or written confirmation that an employee used sick time pursuant to the PSL. However, an employer may not require documentation specifying the nature of a medical condition or otherwise require disclosure of the details of a medical condition as a condition of providing sick time and health information obtained solely due to an employee’s use of sick time pursuant to the PSL must be treated by the

employer as confidential.

35.5.2(e) If an employer chooses to impose any permissible discretionary requirement as a condition of using sick time, it must provide to all employees a written policy containing those requirements, using a delivery method that reasonably ensures that employees receive the policy. If such employer has not provided its written policy, it may not deny sick time to an employee because of non-compliance with such a policy.

35.5.2(f) Sick time to which an employee is entitled must be paid no later than the payday for the next regular payroll period beginning after the sick time was used.

35.5.3 Exemptions and Exceptions. Notwithstanding the above, the PSLL does not apply to any of the following:

35.5.3(a) an independent contractor who does not meet the definition of employee under section 190(2) of the New York State Labor Law;

35.5.3(b) an employee covered by a valid collective bargaining agreement in effect on April 1, 2014, until the termination of such agreement;

35.5.3(c) an employee in the construction or grocery industry covered by a valid collective bargaining agreement if the provisions of the PSLL are expressly waived in such collective bargaining agreement;

35.5.3(d) an employee covered by another valid collective bargaining agreement if such provisions are expressly waived in such agreement and such agreement provides a benefit comparable to that provided by the PSLL for such employee;

35.5.3(e) an audiologist, occupational therapist, physical therapist, or speech language pathologist who is licensed by the New York State Department of Education and who calls in for work assignments at will, determines his or her own schedule, has the ability to reject or accept any assignment referred to him or her, and is paid an average hourly wage that is at least four times the federal minimum wage;

35.5.3(f) an employee in a work study program under Section 2753 of Chapter 42 of the United States Code;

35.5.3(g) an employee whose work is compensated by a qualified scholarship program as that term is defined in the Internal Revenue Code, Section 117 of Chapter 20 of the United States Code; or

35.5.3(h) a participant in a Work Experience Program (WEP) under section 336-c of the New York State Social Services Law.

35.5.4 Retaliation Prohibited. An employer may not threaten or engage in retaliation against an employee for exercising or attempting in good faith to exercise any right provided by the PSLL. In addition, an employer may not interfere with any investigation, proceeding, or hearing pursuant to the PSLL.

35.5.5 Notice of Rights.

35.5.5(a) An employer must provide its employees with written notice of their rights pursuant to the PSLL. Such notice must be in English and the primary language spoken

by an employee, provided that DCA has made available a translation into such language. Downloadable notices are available on DCA's website at <http://www.nyc.gov/html/dca/html/law/PaidSickLeave.shtml>.

35.5.5(b) Any person or entity that willfully violates these notice requirements is subject to a civil penalty in an amount not to exceed fifty dollars for each employee who was not given appropriate notice.

35.5.6 Records. An employer must retain records documenting its compliance with the PSLL for a period of at least three years, and must allow DCA to access such records in furtherance of an investigation related to an alleged violation of the PSLL.

35.5.7 Enforcement and Penalties.

35.5.7(a) Upon receiving a complaint alleging a violation of the PSLL, DCA has the right to investigate such complaint and attempt to resolve it through mediation. Within **30 Days** of written notification of a complaint by DCA, or sooner in certain circumstances, the employer must provide DCA with a written response and such other information as DCA may request. If DCA believes that a violation of the PSLL has occurred, it has the right to issue a notice of violation to the employer.

35.5.7(b) DCA has the power to grant an employee or former employee all appropriate relief as set forth in New York City Administrative Code § 20-924(d). Such relief may include, among other remedies, treble damages for the wages that should have been paid, damages for unlawful retaliation, and damages and reinstatement for unlawful discharge. In addition, DCA may impose on an employer found to have violated the PSLL civil penalties not to exceed \$500 for a first violation, \$750 for a second violation within two years of the first violation, and \$1,000 for each succeeding violation within two years of the previous violation.

35.5.8 More Generous Policies and Other Legal Requirements. Nothing in the PSLL is intended to discourage, prohibit, diminish, or impair the adoption or retention of a more generous sick time policy, or the obligation of an employer to comply with any contract, collective bargaining agreement, employment benefit plan or other agreement providing more generous sick time. The PSLL provides minimum requirements pertaining to sick time and does not preempt, limit or otherwise affect the applicability of any other law, regulation, rule, requirement, policy or standard that provides for greater accrual or use by employees of sick leave or time, whether paid or unpaid, or that extends other protections to employees. The PSLL may not be construed as creating or imposing any requirement in conflict with any federal or state law, rule or regulation.

35.6 HireNYC: Hiring and Reporting Requirements. This Article 35.6 applies to construction contracts of \$1,000,000 or more. The **Contractor** shall comply with the requirements of Articles 35.6.1-35.6.5 for all non-trades jobs (e.g., for an administrative position arising out of **Work** ant located in New York City). The **Contractor** shall reasonably cooperate with SBS and the **City** on specific outreach events, including "Hire-on-the-Spot" events, for the hiring of trades workers in connection with the **Work**. If provided elsewhere in this **Contract**, this **Contract** is subject to a project labor agreement.

35.6.1 Enrollment. The **Contractor** shall enroll with the HireNYC system, found at www.nyc.gov/sbs, within thirty (30) days after the registration of this **Contract** pursuant to Section 328 of the New York City Charter. The **Contractor** shall provide information about the business, designate a primary contact and say whether it intends to hire for any entry

to mid-level job opportunities arising from this **Contract** and located in New York City, and, if so, the approximate start date of the first hire.

35.6.2 Job Posting Requirements.

35.6.2(a) Once enrolled in HireNYC, the **Contractor** agrees to update the HireNYC portal with all entry to mid-level job opportunities arising from this **Contract** and located in New York City, if any, which shall be defined as jobs requiring no more than an associate degree, as provided by the New York State Department of Labor (see Column F of <https://labor.ny.gov/stats/2012-2022-NYS-Employment-Prospects.xls>). The information to be updated includes the types of entry and mid-level positions made available from the work arising from the **Contract** and located in New York City, the number of positions, the anticipated schedule of initiating the hiring process for these positions, and the contact information for the **Contractor's** representative charged with overseeing hiring. The **Contractor** must update the HireNYC portal with any hiring needs arising from the contract and located in New York City, and the requirements of the jobs to be filled, no less than three weeks prior to the intended first day of employment for each new position, except with the permission of SBS, not to be unreasonably withheld, and must also update the HireNYC portal as set forth below.

35.6.2(b) After enrollment through HireNYC and submission of relevant information, SBS will work with the **Contractor** to develop a recruitment plan which will outline the candidate screening process, and will provide clear instructions as to when, where, and how interviews will take place. HireNYC will screen applicants based on employer requirements and refer applicants whom it believes are qualified to the **Contractor** for interviews. The **Contractor** must interview referred applicants whom it believes are qualified.

35.6.2(c) After completing an interview of a candidate referred by HireNYC, the **Contractor** must provide feedback via the portal within twenty (20) business days to indicate which candidates were interviewed and hired, if any. In addition, the **Contractor** shall provide the start date of new hires, and additional information reasonably related to such hires, within twenty (20) business days after the start date. In the event the **Contractor** does not have any job openings covered by this Rider in any given year, the **Contractor** shall be required to provide an annual update to HireNYC to that effect. For this purpose, the reporting year shall run from the date of the registration of the **Contract** pursuant to Charter section 328 and each anniversary date.

35.6.2(d) These requirements do not limit the **Contractor's** ability to assess the qualifications of prospective workers, and to make final hiring and retention decisions. No provision of this Article 35.6 shall be interpreted so as to require the **Contractor** to employ any particular worker.

35.6.2(e) In addition, the provisions of this Article 35.6 shall not apply to positions that the **Contractor** intends to fill with employees employed pursuant to the job retention provision of Section 22-505 of the Administrative Code of the City of New York. The **Contractor** shall not be required to report such openings with HireNYC. However, the **Contractor** shall enroll with the HireNYC system pursuant to Article 35.6.1, above, and, if such positions subsequently become open, then the remaining provisions of this Article 35.6 will apply.

35.6.3 Breach and Liquidated Damages. If the **Contractor** fails to comply with the terms of the **Contract** and this Article 35.6 (1) by not enrolling its business with HireNYC; (2) by not informing HireNYC, as required, of open positions; or (3) by failing to interview a qualified candidate, the **Agency** may assess liquidated damages in the amount of two-thousand five hundred dollars (\$2,500) per breach. For all other events of noncompliance with the terms of this Article 35.6, the **Agency** may assess liquidated damages in the amount of five hundred dollars (\$500) per breach. Furthermore, in the event the **Contractor** breaches the requirements of this Article 35.6 during the term of the **Contract**, the **City** may hold the **Contractor** in default of this **Contract**.

35.6.4 Audit Compliance. In addition to the auditing requirements set forth in other parts of the **Contract**, the **Contractor** shall permit SBS and the **City** to inspect any and all records concerning or relating to job openings or the hiring of individuals for work arising from the **Contract** and located in New York City. The **Contractor** shall permit an inspection within seven (7) business days of the request.

35.6.5 Other Reporting Requirements. The **Contractor** shall report to the **City**, on a monthly basis, all information reasonably requested by the **City** that is necessary for the **City** to comply with any reporting requirements imposed by **Law**, including any requirement that the **City** maintain a publicly accessible database. In addition, the **Contractor** agrees to comply with all reporting requirements imposed by **Law**, or as otherwise requested by the **City**.

35.6.6 Federal Hiring Requirements. If this **Contract** is federally funded (as indicated elsewhere in this **Contract**), the **Contractor** shall comply with all federal hiring requirements as may be set forth in this **Contract**, including, as applicable: (a) Section 3 of the HUD Act of 1968, which requires, to the greatest extent feasible, economic opportunities for 30 percent of new hires be given to low- and very low-income persons, particularly persons who are recipients of HUD assistance for housing and Executive Order 11246, which prohibits discrimination in employment due to race, color, religion, sex or national origin, and requires the implementation of goals for minority and female participation for work involving any construction trade.

ARTICLE 36. NO DISCRIMINATION

36.1 The **Contractor** specifically agrees, as required by Labor Law Section 220-e, as amended, that:

36.1.1 In the hiring of employees for the performance of **Work** under this **Contract** or any subcontract hereunder, neither the **Contractor**, **Subcontractor**, nor any person acting on behalf of such **Contractor** or **Subcontractor**, shall by reason of race, creed, color or national origin discriminate against any citizen of the State of New York who is qualified and available to perform the **Work** to which the employment relates;

36.1.2 Neither the **Contractor**, **Subcontractor**, nor any person on its behalf shall, in any manner, discriminate against or intimidate any employee hired for the performance of **Work** under this **Contract** on account of race, creed, color or national origin;

36.1.3 There may be deducted from the amount payable to the **Contractor** by the **City** under this **Contract** a penalty of fifty (\$50.00) dollars for each person for each **Day** during which such person was discriminated against or intimidated in violation of the provisions of this

Contract; and

36.1.4 This **Contract** may be cancelled or terminated by the **City** and all moneys due or to become due hereunder may be forfeited, for a second or any subsequent violation of the terms or conditions of this Article 36.

36.1.5 This Article 36 covers all construction, alteration and repair of any public building or public work occurring in the State of New York and the manufacture, sale, and distribution of materials, equipment, and supplies to the extent that such operations are performed within the State of New York pursuant to this **Contract**.

36.2 The **Contractor** specifically agrees, as required by Section 6-108 of the Administrative Code, as amended, that:

36.2.1 It shall be unlawful for any person engaged in the construction, alteration or repair of buildings or engaged in the construction or repair of streets or highways pursuant to a **Contract** with the **City** or engaged in the manufacture, sale or distribution of materials, equipment or supplies pursuant to a **Contract** with the **City** to refuse to employ or to refuse to continue in any employment any person on account of the race, color or creed of such person.

36.2.2 It shall be unlawful for any person or any servant, agent or employee of any person, described in Article 36.1.2, to ask, indicate or transmit, orally or in writing, directly or indirectly, the race, color or creed or religious affiliation of any person employed or seeking employment from such person, firm or corporation.

36.2.3 Breach of the foregoing provisions shall be deemed a violation of a material provision of this **Contract**.

36.2.4 Any person, or the employee, manager or owner of or officer of such firm or corporation who shall violate any of the provisions of this Article 36.2 shall, upon conviction thereof, be punished by a fine of not more than one hundred (\$100.00) dollars or by imprisonment for not more than thirty (30) **Days**, or both.

36.3 This **Contract** is subject to the requirements of Executive Order No. 50 (1980) (“E.O. 50”), as revised, and the rules and regulations promulgated thereunder. No contract will be awarded unless and until these requirements have been complied with in their entirety. By signing this **Contract**, the **Contractor** agrees that it:

36.3.1 Will not engage in any unlawful discrimination against any employee or applicant for employment because of race, creed, color, national origin, sex, age, disability, marital status or sexual orientation with respect to all employment decisions including, but not limited to, recruitment, hiring, upgrading, demotion, downgrading, transfer, training, rates of pay or other forms of compensation, layoff, termination, and all other terms and conditions of employment; and

36.3.2 Will not engage in any unlawful discrimination in the selection of **Subcontractors** on the basis of the owner’s race, color, creed, national origin, sex, age, disability, marital status or sexual orientation; and

36.3.3 Will state in all solicitations or advertisements for employees placed by or on behalf of the **Contractor** that all qualified applicants will receive consideration for employment without unlawful discrimination based on race, creed, color, national origin, sex, age, citizens status,

disability, marital status, sexual orientation, or that it is an equal employment opportunity employer; and

36.3.4 Will send to each labor organization or representative of workers with which it has a collective bargaining agreement or other contract or memorandum of understanding, written notification of its equal employment opportunity commitments under E.O. 50 and the rules and regulations promulgated thereunder; and

36.3.5 Will furnish, before the award of the **Contract**, all information and reports, including an employment report, that are required by E.O. 50, the rules and regulations promulgated thereunder, and orders of the **City** Department of Business Services, Division of Labor Services (**DLS**) and will permit access to its books, records, and accounts by the **DLS** for the purposes of investigation to ascertain compliance with such rules, regulations, and orders.

36.4 The **Contractor** understands that in the event of its noncompliance with the nondiscrimination clauses of this **Contract** or with any of such rules, regulations, or orders, such noncompliance shall constitute a material breach of this **Contract** and noncompliance with E.O. 50 and the rules and regulations promulgated thereunder. After a hearing held pursuant to the rules of the **DLS**, the Director of the **DLS** may direct the **Commissioner** to impose any or all of the following sanctions:

36.4.1 Disapproval of the **Contractor**; and/or

36.4.2 Suspension or termination of the **Contract**; and/or

36.4.3 Declaring the **Contractor** in default; and/or

36.4.4 In lieu of any of the foregoing sanctions, the Director of the **DLS** may impose an employment program.

In addition to any actions taken under this **Contract**, failure to comply with E.O. 50 and the rules and regulations promulgated thereunder, in one or more instances, may result in a **City Agency** declaring the **Contractor** to be non-responsible in future procurements. The **Contractor** further agrees that it will refrain from entering into any **Contract** or **Contract** modification subject to E.O. 50 and the rules and regulations promulgated thereunder with a **Subcontractor** who is not in compliance with the requirements of E.O. 50 and the rules and regulations promulgated thereunder.

36.5 The **Contractor** specifically agrees, as required by Section 6-123 of the Administrative Code, that:

36.5.1 The **Contractor** will not engage in any unlawful discriminatory practice in violation of Title 8 of the Administrative Code; and

36.5.2 Any failure to comply with this Article 36.5 may subject the **Contractor** to the remedies set forth in Section 6-123 of the Administrative Code, including, where appropriate, sanctions such as withholding of payment, imposition of an employment program, finding the **Contractor** to be in default, cancellation of the **Contract**, or any other sanction or remedy provided by **Law** or **Contract**.

ARTICLE 37. LABOR LAW REQUIREMENTS

37.1 The **Contractor** shall strictly comply with all applicable provisions of the Labor Law, as

amended. Such compliance is a material term of this **Contract**.

37.2 The **Contractor** specifically agrees, as required by Labor Law Sections 220 and 220-d, as amended, that:

37.2.1 Hours of **Work**: No laborer, worker, or mechanic in the employ of the **Contractor**, **Subcontractor** or other person doing or contracting to do the whole or a part of the **Work** contemplated by this **Contract** shall be permitted or required to work more than eight (8) hours in any one (1) **Day**, or more than five (5) **Days** in any one (1) week, except as provided in the Labor Law and in cases of extraordinary emergency including fire, flood, or danger to life or property, or in the case of national emergency when so proclaimed by the President of the United States of America.

37.2.2 In situations in which there are not sufficient laborers, workers, and mechanics who may be employed to carry on expeditiously the **Work** contemplated by this **Contract** as a result of such restrictions upon the number of hours and **Days** of labor, and the immediate commencement or prosecution or completion without undue delay of the **Work** is necessary for the preservation of the **Site** and/or for the protection of the life and limb of the persons using the same, such laborers, workers, and mechanics shall be permitted or required to work more than eight (8) hours in any one (1) **Day**; or five (5) **Days** in any one (1) week; provided, however, that upon application of any **Contractor**, the **Commissioner** shall have first certified to the Commissioner of Labor of the State of New York (hereinafter "Commissioner of Labor") that such public **Work** is of an important nature and that a delay in carrying it to completion would result in serious disadvantage to the public; and provided, further, that such Commissioner of Labor shall have determined that such an emergency does in fact exist as provided in Labor Law Section 220.2.

37.2.3 Failure of the **Commissioner** to make such a certification to the Commissioner of Labor shall not entitle the **Contractor** to damages for delay or for any cause whatsoever.

37.2.4 Prevailing Rate of Wages: The wages to be paid for a legal day's **Work** to laborers, workers, or mechanics employed upon the **Work** contemplated by this **Contract** or upon any materials to be used thereon shall not be less than the "prevailing rate of wage" as defined in Labor Law Section 220, and as fixed by the **Comptroller** in the attached Schedule of Wage Rates and in updated schedules thereof. The prevailing wage rates and supplemental benefits to be paid are those in effect at the time the **Work** is being performed.

37.2.5 Requests for interpretation or correction in the Information for Bidders includes all requests for clarification of the classification of trades to be employed in the performance of the **Work** under this **Contract**. In the event that a trade not listed in the **Contract** is in fact employed during the performance of this **Contract**, the **Contractor** shall be required to obtain from the **Agency** the prevailing wage rates and supplementary benefits for the trades used and to complete the performance of this **Contract** at the price at which the **Contract** was awarded.

37.2.6 Minimum Wages: Except for employees whose wage is required to be fixed pursuant to Labor Law Section 220, all persons employed by the **Contractor** and any **Subcontractor** in the manufacture or furnishing of the supplies, materials, or equipment, or the furnishing of work, labor, or services, used in the performance of this **Contract**, shall be paid, without subsequent deduction or rebate unless expressly authorized by **Law**, not less than the sum mandated by **Law**.

37.3 Working Conditions: No part of the **Work**, labor or services shall be performed or rendered by

the **Contractor** in any plants, factories, buildings or surroundings or under working conditions which are unsanitary or hazardous or dangerous to the health and safety of employees engaged in the performance of this **Contract**. Compliance with the safety, sanitary, and factory inspection **Laws** of the state in which the **Work** is to be performed shall be prima facie evidence of compliance with this Article 37.3.

37.4 Prevailing Wage Enforcement: The **Contractor** agrees to pay for all costs incurred by the **City** in enforcing prevailing wage requirements, including the cost of any investigation conducted by or on behalf of the **Agency** or the **Comptroller**, where the **City** discovers a failure to comply with any of the requirements of this Article 37 by the **Contractor** or its **Subcontractor(s)**. The **Contractor** also agrees that, should it fail or refuse to pay for any such investigation, the **Agency** is hereby authorized to deduct from a **Contractor's** account an amount equal to the cost of such investigation.

37.4.1 The Labor Law Section 220 and Section 220-d, as amended, provide that this **Contract** shall be forfeited and no sum paid for any **Work** done hereunder on a second conviction for willfully paying less than:

37.4.1(a) The stipulated prevailing wage scale as provided in Labor Law section 220, as amended, or

37.4.1(b) The stipulated minimum hourly wage scale as provided in Labor Law section 220-d, as amended.

37.4.2 For any breach or violation of either working conditions (Article 37.3) or minimum wages (Article 37.2.6) provisions, the party responsible therefor shall be liable to the **City** for liquidated damages, which may be withheld from any amounts due on any contracts with the **City** of such party responsible, or may be recovered in actions brought by the **City** Corporation Counsel in the name of the **City**, in addition to damages for any other breach of this **Contract**, for a sum equal to the amount of any underpayment of wages due to any employee engaged in the performance of this **Contract**. In addition, the **Commissioner** shall have the right to cancel contracts and enter into other contracts for the completion of the original contract, with or without public letting, and the original **Contractor** shall be liable for any additional cost. All sums withheld or recovered as deductions, rebates, refunds, or underpayment of wages hereunder, shall be held in a special deposit account and shall be paid without interest, on order of the **Comptroller**, directly to the employees who have been paid less than minimum rates of pay as set forth herein and on whose account such sums were withheld or recovered, provided that no claims by employees for such payments shall be entertained unless made within two (2) years from the date of actual notice to the **Contractor** of the withholding or recovery of such sums by the **City**.

37.4.3 A determination by the **Comptroller** that a **Contractor** and/or its **Subcontractor** willfully violated Labor Law Section 220 will be forwarded to the **City's** five District Attorneys for review.

37.4.4 The **Contractor's** or **Subcontractor's** noncompliance with this Article 37.4 and Labor Law Section 220 may result in an unsatisfactory performance evaluation and the **Comptroller** may also find and determine that the **Contractor** or **Subcontractor** willfully violated the New York Labor **Law**.

37.4.4(a) An unsatisfactory performance evaluation for noncompliance with this Article 37.4 may result in a determination that the **Contractor** is a non-responsible bidder on subsequent procurements with the **City** and thus a rejection of a future award

of a contract with the **City**, as well as any other sanctions provided for by **Law**.

37.4.4(b) Labor Law Section 220-b, as amended, provides that when two (2) final determinations have been rendered against a **Contractor** or **Subcontractor** within any consecutive six (6) year period determining that such **Contractor** or **Subcontractor** has willfully failed to pay the prevailing rate of wages or to provide supplements in accordance with the Labor Law and this Article 37.4, whether such failures were concurrent or consecutive and whether or not such final determinations concerning separate public works projects are rendered simultaneously, such **Contractor** or **Subcontractor** shall be ineligible to submit a bid on or be awarded any public works contract with the **City** for a period of five (5) years from the second final determination. If the final determination involves the falsification of payroll records or the kickback of wages or supplements, the **Contractor** or **Subcontractor** shall be ineligible to submit a bid on or be awarded any public works contract with the **City** for a period of five (5) years from the first final determination.

37.4.4(c) Labor Law Section 220, as amended, provides that the **Contractor** or **Subcontractor** found to have violated this Article 37.4 may be directed to make payment of wages or supplements including interest found to be due, and the **Contractor** or **Subcontractor** may be directed to make payment of a further sum as a civil penalty in an amount not exceeding twenty-five (25%) percent of the total amount found to be due.

37.5 The **Contractor** and its **Subcontractors** shall within ten (10) **Days** after mailing of a Notice of Award or written order, post in prominent and conspicuous places in each and every plant, factory, building, and structure where employees of the **Contractor** and its **Subcontractors** engaged in the performance of this **Contract** are employed, notices furnished by the **City**, in relation to prevailing wages and supplements, minimum wages, and other stipulations contained in Sections 220 and 220-h of the Labor Law, and the **Contractor** and its **Subcontractors** shall continue to keep such notices posted in such prominent and conspicuous places until **Final Acceptance** of the supplies, materials, equipment, or **Work**, labor, or services required to be furnished or rendered under this **Contract**.

37.6 The **Contractor** shall strictly comply with all of the provisions of Articles 37.6.1 through 37.6.5, and provide for all workers, laborers or mechanics in its employ, the following:

37.6.1 Notices Posted At **Site**: Post, in a location designated by the **City**, schedules of prevailing wages and supplements for this **Project**, a copy of all re-determinations of such schedules for the **Project**, the Workers' Compensation **Law** Section 51 notice, all other notices required by **Law** to be posted at the **Site**, the **City** notice that this **Project** is a public works project on which each worker is entitled to receive the prevailing wages and supplements for the occupation at which he or she is working, and all other notices which the **City** directs the **Contractor** to post. The **Contractor** shall provide a surface for such notices which is satisfactory to the **City**. The **Contractor** shall maintain and keep current such notices in a legible manner and shall replace any notice or schedule which is damaged, defaced, illegible or removed for any reason. The **Contractor** shall post such notices before commencing any **Work** on the **Site** and shall maintain such notices until all **Work** on the **Site** is complete; and

37.6.2 Daily **Site** Sign-in Sheets: Maintain daily **Site** sign-in sheets, and require that **Subcontractors** maintain daily **Site** sign-in sheets for its employees, which include blank spaces for an employee's name to be both printed and signed, job title, date started and Social Security number, the time the employee began work and the time the employee left

work, until **Final Acceptance** of the supplies, materials, equipment, or **Work**, labor, or services to be furnished or rendered under this **Contract** unless exception is granted by the **Comptroller** upon application by the **Agency**. In the alternative, subject to the approval of the **CCPO**, the **Contractor** and **Subcontractor** may maintain an electronic or biometric sign-in system, which provides the information required by this Article 37.6.2; and

37.6.3 Individual Employee Information Notices: Distribute a notice to each worker, laborer or mechanic employed under this **Contract**, in a form provided by the **Agency**, that this **Project** is a public works project on which each worker, laborer or mechanic is entitled to receive the prevailing rate of wages and supplements for the occupation at which he or she is working. If the total cost of the **Work** under this **Contract** is at least two hundred fifty thousand (\$250,000) dollars, such notice shall also include a statement that each worker, laborer or mechanic must be certified prior to performing any **Work** as having successfully completed a course in construction safety and health approved by the United States Department of Labor's Occupational Safety and Health Administration that is at least ten (10) hours in duration. Such notice shall be distributed to each worker before he or she starts performing any **Work** of this **Contract** and with the first paycheck after July first of each year. "Worker, laborer or mechanic" includes employees of the **Contractor** and all **Subcontractors** and all employees of suppliers entering the **Site**. At the time of distribution, the **Contractor** shall have each worker, laborer or mechanic sign a statement, in a form provided by the **Agency**, certifying that the worker has received the notice required by this Article 37.6.3, which signed statement shall be maintained with the payroll records required by this **Contract**; and

37.6.3(a) The **Contractor** and each **Subcontractor** shall notify each worker, laborer or mechanic employed under this **Contract** in writing of the prevailing rate of wages for their particular job classification. Such notification shall be given to every worker, laborer, and mechanic on their first pay stub and with every pay stub thereafter; and

37.6.4 **Site Laminated Identification Badges**: The **Contractor** shall provide laminated identification badges which include a photograph of the worker's, laborer's or mechanic's face and indicate the worker's, laborer's or mechanic's name, trade, employer's name, and employment starting date (month/day/year). Further, the **Contractor** shall require as a condition of employment on the **Site**, that each and every worker, laborer or mechanic wear the laminated identification badge at all times and that it may be seen by any representative of the **City**. The **Commissioner** may grant a written waiver from the requirement that the laminated identification badge include a photograph if the **Contractor** demonstrates that the identity of an individual wearing a laminated identification badge can be easily verified by another method; and

37.6.5 **Language Other Than English Used On Site**: Provide the **ACCO** notice when three (3) or more employees (worker and/or laborer and/or mechanic) on the **Site**, at any time, speak a language other than English. The **ACCO** will then provide the **Contractor** the notices described in Article 37.6.1 in that language or languages as may be required. The **Contractor** is responsible for all distributions under this Article 37; and

37.6.6 **Provision of Records**: The **Contractor** and **Subcontractor(s)** shall produce within five (5) **Days** on the **Site** of the **Work** and upon a written order of the **Engineer**, the **Commissioner**, the **ACCO**, the **Agency EAO**, or the **Comptroller**, such records as are required to be kept by this Article 37.6; and

37.6.7 The **Contractor** and **Subcontractor(s)** shall pay employees by check or direct deposit. If this **Contract** is for an amount greater than one million (\$1,000,000) dollars, checks issued by the **Contractor** to covered employees shall be generated by a payroll service or automated payroll system (an in-house system may be used if approved by the **Agency**). For any subcontract for an amount greater than seven hundred fifty thousand (\$750,000) dollars, checks issued by a **Subcontractor** to covered employees shall be generated by a payroll service or automated payroll system (an in-house system may be used if approved by the **Agency**); and

37.6.8 The failure of the **Contractor** or **Subcontractor(s)** to comply with the provisions of Articles 37.6.1 through 37.6.7 may result in the **Commissioner** declaring the **Contractor** in default and/or the withholding of payments otherwise due under the **Contract**.

37.7 The **Contractor** and its **Subcontractors** shall keep such employment and payroll records as are required by Section 220 of the Labor Law. The failure of the **Contractor** or **Subcontractor(s)** to comply with the provisions of this Article 37.7 may result in the **Commissioner** declaring the **Contractor** in default and/or the withholding of payments otherwise due under the **Contract**.

37.8 At the time the **Contractor** makes application for each partial payment and for final payment, the **Contractor** shall submit to the **Commissioner** a written payroll certification, in the form provided by this **Contract**, of compliance with the prevailing wage, minimum wage, and other provisions and stipulations required by Labor Law Section 220 and of compliance with the training requirements of Labor Law Section 220-h set forth in Article 35.2. This certification of compliance shall be a condition precedent to payment and no payment shall be made to the **Contractor** unless and until each such certification shall have been submitted to and received by the **Commissioner**.

37.9 This **Contract** is executed by the **Contractor** with the express warranty and representation that the **Contractor** is not disqualified under the provisions of Section 220 of the Labor Law from the award of the **Contract**.

37.10 Any breach or violation of any of the foregoing shall be deemed a breach or violation of a material provision of this **Contract**, and grounds for cancellation thereof by the **City**.

ARTICLE 38. PAYROLL REPORTS

38.1 The **Contractor** and its **Subcontractor(s)** shall maintain on the **Site** during the performance of the **Work** the original payrolls or transcripts thereof which the **Contractor** and its **Subcontractor(s)** are required to maintain and shall submit such original payrolls or transcripts, subscribed and affirmed by it as true, within thirty (30) **Days** after issuance of its first payroll, and every thirty (30) **Days** thereafter, pursuant to Labor Law Section 220(3-a)(a)(iii). The **Contractor** and **Subcontractor(s)** shall submit such original payrolls or transcripts along with each and every payment requisition. If payment requisitions are not submitted at least once a month, the **Contractor** and its **Subcontractor(s)** shall submit original payrolls and transcripts both along with its payment requisitions and independently of its payment requisitions.

38.2 The **Contractor** shall maintain payrolls or transcripts thereof for six (6) years from the date of completion of the **Work** on this **Contract**. If such payrolls and transcripts are maintained outside of New York City after the completion of the **Work** and their production is required pursuant to this Article 38, the **Contractor** shall produce such records in New York City upon request by the **City**.

38.3 The **Contractor** and **Subcontractor(s)** shall comply with any written order, direction, or request made by the **Engineer**, the **Commissioner**, the **ACCO**, the **Agency EAO**, the **Agency Labor Law**

Investigator(s), or the **Comptroller**, to provide to the requesting party any of the following information and/or records within five (5) **Days** of such written order, direction, or request:

38.3.1 Such original payrolls or transcripts thereof subscribed and affirmed by it as true and the statements signed by each worker pursuant to this Chapter VIII; and/or

38.3.2 Attendance sheets for each **Day** on which any employee of the **Contractor** and/or any of the **Subcontractor(s)** performed **Work** on the **Site**, which attendance sheet shall be in a form acceptable to the **Agency** and shall provide information acceptable to the **Agency** to identify each such employee; and/or

38.3.3 Any other information to satisfy the **Engineer**, the **Commissioner**, the **ACCO**, the **Agency EAO**, the **Agency Labor Law Investigator(s)** or the **Comptroller**, that this Chapter VIII and the Labor Law, as to the hours of employment and prevailing rates of wages and/or supplemental benefits, are being observed.

38.4 The failure of the **Contractor** or **Subcontractor(s)** to comply with the provisions of Articles 38.1 and/or 38.2 may result in the **Commissioner** declaring the **Contractor** in default and/or the withholding of payments otherwise due under the **Contract**.

ARTICLE 39. DUST HAZARDS

39.1 Should a harmful dust hazard be created in performing the **Work** of this **Contract**, for the elimination of which appliances or methods have been approved by the Board of Standards and Appeals of the City of New York, such appliances and methods shall be installed, maintained, and effectively operated during the continuance of such harmful dust hazard. Failure to comply with this provision after notice shall make this **Contract** voidable at the sole discretion of the **City**.

CHAPTER IX: PARTIAL AND FINAL PAYMENTS

ARTICLE 40. CONTRACT PRICE

40.1 The **City** shall pay, and the **Contractor** agrees to accept, in full consideration for the **Contractor's** performance of the **Work** subject to the terms and conditions hereof, the lump sum price or unit prices for which this **Contract** was awarded, plus the amount required to be paid for any **Extra Work** ordered by the **Commissioner** under Article 25, less credit for any **Work** omitted pursuant to Article 29.

ARTICLE 41. BID BREAKDOWN ON LUMP SUM

41.1 Within fifteen (15) **Days** after the commencement date specified in the **Notice to Proceed** or **Order to Work**, unless otherwise directed by the **Resident Engineer**, the **Contractor** shall submit to the **Resident Engineer** a breakdown of its bid price, or of lump sums bid for items of the **Contract**, showing the various operations to be performed under the **Contract**, as directed in the progress schedule required under Article 9, and the value of each of such operations, the total of such items to equal the lump sum price bid. Said breakdown must be approved in writing by the **Resident Engineer**.

41.2 No partial payment will be approved until the **Contractor** submits a bid breakdown that is acceptable to the **Resident Engineer**.

41.3 The **Contractor** shall also submit such other information relating to the bid breakdown as directed by the **Resident Engineer**. Thereafter, the breakdown may be used only for checking the **Contractor's** applications for partial payments hereunder, but shall not be binding upon the **City**, the **Commissioner**, or the **Engineer** for any purpose whatsoever.

ARTICLE 42. PARTIAL PAYMENTS

42.1 From time to time as the **Work** progresses satisfactorily, but not more often than once each calendar month (except where the **Commissioner** approves in writing the submission of invoices on a more frequent basis and for invoices relating to **Work** performed pursuant to a change order), the **Contractor** may submit to the **Engineer** a requisition for a partial payment in the prescribed form, which shall contain an estimate of the quantity and the fair value of the **Work** done during the payment period.

42.2 Partial payments may be made for materials, fixtures, and equipment in advance of their actual incorporation in the **Work**, as the **Commissioner** may approve, and upon the terms and conditions set forth in the General Conditions.

42.3 The **Contractor** shall also submit to the **Commissioner** in connection with every application for partial payment a verified statement in the form prescribed by the **Comptroller** setting forth the information required under Labor Law Section 220-a.

42.4 Within thirty (30) **Days** after receipt of a satisfactory payment application, and within sixty (60) **Days** after receipt of a satisfactory payment application in relation to **Work** performed pursuant to a change order, the **Engineer** will prepare and certify, and the **Commissioner** will approve, a voucher for a partial payment in the amount of such approved estimate, less any and all deductions authorized to be made by the **Commissioner** under the terms of this **Contract** or by **Law**.

ARTICLE 43. PROMPT PAYMENT

43.1 The Prompt Payment provisions of the **PPB** Rules in effect at the time of the bid will be applicable to payments made under this **Contract**. The provisions require the payment to the **Contractor** of interest on payments made after the required payment date, except as set forth in the **PPB** Rules.

43.2 The **Contractor** shall submit a proper invoice to receive payment, except where the **Contract** provides that the **Contractor** will be paid at predetermined intervals without having to submit an invoice for each scheduled payment.

43.3 Determination of interest due will be made in accordance with the **PPB** Rules.

43.4 If the **Contractor** is paid interest, the proportionate share(s) of that interest shall be forwarded by the **Contractor** to its **Subcontractor(s)**.

43.5 The **Contractor** shall pay each **Subcontractor** or **Materialman** not later than seven (7) **Days** after receipt of payment out of amounts paid to the **Contractor** by the **City** for **Work** performed by the **Subcontractor** or **Materialman** under this **Contract**.

43.5.1 If **Contractor** fails to make any payment to any **Subcontractor** or **Materialman** within seven (7) **Days** after receipt of payment by the **City** pursuant to this Article 43.5,

then the **Contractor** shall pay interest on amounts due to such **Subcontractor** or **Materialman** at the rate of interest in effect on the date such payment is made by the **Contractor** computed in accordance with Section 756-b (1)(b) of the New York General Business Law. Accrual of interest shall commence on the **Day** immediately following the expiration of the seventh **Day** following receipt of payment by the **Contractor** from the **City** and shall end on the date on which payment is made.

43.6 The **Contractor** shall include in each of its subcontracts a provision requiring each **Subcontractor** to make payment to each of its **Subcontractors** or **Materialmen** for **Work** performed under this **Contract** in the same manner and within the same time period set forth above.

ARTICLE 44. SUBSTANTIAL COMPLETION PAYMENT

44.1 The **Contractor** shall submit with the **Substantial Completion** requisition:

44.1.1 A final verified statement of any pending Article 27 disputes in accordance with the **PPB** Rules and this **Contract** and any and all alleged claims against the **City**, in any way connected with or arising out of this **Contract** (including those as to which details may have been furnished pursuant to Articles 11, 27, 28, and 30) setting forth with respect to each such claim the total amount thereof, the various items of labor and materials included therein, and the alleged value of each item; and if the alleged claim be one for delay, the alleged cause of each such delay, the period or periods of time, giving the dates when the **Contractor** claims the performance of the **Work** or a particular part thereof was delayed, and an itemized statement and breakdown of the amount claimed for each such delay.

44.1.1(a) With respect to each such claim, the **Commissioner**, the **Comptroller** and, in the event of litigation, the **City** Corporation Counsel shall have the same right to inspect, and to make extracts or copies of, the **Contractor's** books, vouchers, records, etc., as is referred to in Articles 11, 27, 28, and 30. Nothing contained in this Article 44.1.1(a) is intended to or shall relieve the **Contractor** from the obligation of complying strictly with Articles 11, 27, 28, and 30. The **Contractor** is warned that unless such claims are completely set forth as herein required, the **Contractor** upon acceptance of the **Substantial Completion** payment pursuant to this Article 44, will have waived any such claims.

44.1.2 A **Final Approved Punch List**.

44.1.3 Where required, a request for an extension of time to achieve **Substantial Completion** or final extension of time.

44.2 The **Commissioner** shall issue a voucher calling for payment of any part or all of the balance due for **Work** performed under the **Contract**, including monies retained under Article 21, less any and all deductions authorized to be made by the **Commissioner**, under this **Contract** or by **Law**, and less twice the amount the **Commissioner** considers necessary to ensure the completion of the balance of the **Work** by the **Contractor**. Such a payment shall be considered a partial and not a final payment. No **Substantial Completion** payment shall be made under this Article 44 where the **Contractor** failed to complete the **Work** within the time fixed for such completion in the Schedule A of the General Conditions, or within the time to which completion may have been extended, until an extension or extensions of time for the completion of **Work** have been acted upon pursuant to Article 13.

44.3 No further partial payments shall be made to the **Contractor** after **Substantial Completion**, except the **Substantial Completion** payment and payment pursuant to any **Contractor's** requisition that were properly filed with the **Commissioner** prior to the date of **Substantial Completion**; however, the **Commissioner** may grant a waiver for further partial payments after the date of **Substantial Completion** to permit payments for change order **Work** and/or release of retainage and deposits pursuant to Articles 21 and 24. Such waiver shall be in writing.

44.4 The **Contractor** acknowledges that nothing contained in this Article 44 is intended to or shall in any way diminish the force and effect of Article 13.

ARTICLE 45. FINAL PAYMENT

45.1 After completion and **Final Acceptance** of the **Work**, the **Contractor** shall submit all required certificates and documents, together with a requisition for the balance claimed to be due under the **Contract**, less the amount authorized to be retained for maintenance under Article 24. Such submission shall be within 90 days of the date of the **Commissioner's** written determination of **Final Acceptance**, or within such additional time as may be granted by the **Commissioner** in writing. If the **Contractor** fails to submit all required certificates and documents within the time allowed, no payment of the balance claimed shall be made to the **Contractor** and the **Contractor** shall be deemed to have forfeited its right to payment of any balance claimed. A verified statement similar to that required in connection with applications for partial payments shall also be submitted to the **Commissioner**.

45.2 Amended Verified Statement of Claims: The **Contractor** shall also submit with the final requisition any amendments to the final verified statement of any pending dispute resolution procedures in accordance with the **PPB** Rules and this **Contract** and any and all alleged claims against the **City**, in any way connected with or arising out of this **Contract** (including those as to which details may have been furnished pursuant to Articles 11, 27, 28, and 30) that have occurred subsequent to **Substantial Completion**, setting forth with respect to each such claim the total amount thereof, the various items of labor and materials included therein, and the alleged value of each such item; and if the alleged claim be one for delay, the alleged cause of each such delay, the period or periods of time, giving the dates when the **Contractor** claims the performance of the **Work** or a particular part thereof was delayed, and an itemized statement and breakdown of the amount claimed for each such delay. With reference to each such claim, the **Commissioner**, the **Comptroller** and, in the event of litigation, the **City** Corporation Counsel shall have the same right to inspect, and to make extracts or copies of, the **Contractor's** books, vouchers, records, etc., as is referred to in Articles 11, 27, 28, and 30. Nothing contained in this Article 45.2, is intended to or shall relieve the **Contractor** from the obligation of complying strictly with Articles 11, 27, 28, and 30. The **Contractor** is warned that unless such claims are completely set forth as herein required, the **Contractor**, upon acceptance of the Final Payment pursuant to Article 46, will have waived any such claims.

45.3 Preparation of Final Voucher: Upon determining the balance due hereunder other than on account of claims, the **Engineer** will prepare and certify, for the **Commissioner's** approval, a voucher for final payment in that amount less any and all deductions authorized to be made by the **Commissioner** under this **Contract** or by **Law**. In the case of a lump sum **Contract**, the **Commissioner** shall certify the voucher for final payment within thirty (30) **Days** from the date of completion and acceptance of the **Work**, provided all requests for extensions of time have been acted upon.

45.3.1 All prior certificates and vouchers upon which partial payments were made, being merely estimates made to enable the **Contractor** to prosecute the **Work** more advantageously, shall be subject to correction in the final voucher, and the certification of the **Engineer**

thereon and the approval of the **Commissioner** thereof, shall be conditions precedent to the right of the **Contractor** to receive any money hereunder. Such final voucher shall be binding and conclusive upon the **Contractor**.

45.3.2 Payment pursuant to such final voucher, less any deductions authorized to be made by the **Commissioner** under this **Contract** or by **Law**, shall constitute the final payment, and shall be made by the **Comptroller** within thirty (30) **Days** after the filing of such voucher in his/her office.

45.4 The **Contractor** acknowledges that nothing contained in this Article 45 is intended to or shall in any way diminish the force and effect of Article 13.

ARTICLE 46. ACCEPTANCE OF FINAL PAYMENT

46.1 The acceptance by the **Contractor**, or by anyone claiming by or through it, of the final payment, whether such payment be made pursuant to any judgment of any court, or otherwise, shall constitute and operate as a release of the **City** from any and all claims of and liability to the **Contractor** for anything heretofore done or furnished for the **Contractor** relating to or arising out of this **Contract** and the **Work** done hereunder, and for any prior act, neglect or default on the part of the **City** or any of its officials, agents or employees, excepting only a claim against the **City** for the amounts deducted or retained in accordance with the terms and provisions of this **Contract** or by **Law**, and excepting any claims, not otherwise waived, or any pending dispute resolution procedures which are contained in the verified statement filed with the **Contractor's** substantial and final requisitions pursuant to Articles 44 and 45.

46.2 The **Contractor** is warned that the execution by it of a release, in connection with the acceptance of the final payment, containing language purporting to reserve claims other than those herein specifically excepted from the operation of this Article 46, or those for amounts deducted by the **Commissioner** from the final requisition or from the final payment as certified by the **Engineer** and approved by the **Commissioner**, shall not be effective to reserve such claims, anything stated to the **Contractor** orally or in writing by any official, agent or employee of the **City** to the contrary notwithstanding.

46.3 Should the **Contractor** refuse to accept the final payment as tendered by the **Comptroller**, it shall constitute a waiver of any right to interest thereon.

46.4 The **Contractor**, however, shall not be barred by this Article 46 from commencing an action for breach of **Contract** to the extent permitted by **Law** and by the terms of the **Contract** for any claims that are contained in the verified statement filed with the **Contractor's** substantial and final requisitions pursuant to Articles 44 and 45 or that arose after submission of the final payment requisition, provided that a detailed and verified statement of claim is served upon the contracting **Agency** and **Comptroller** not later than forty (40) **Days** after the making of such final payment by electronic funds transfer (EFT) or the mailing of such final payment. The statement shall specify the items upon which the claim will be based and any such claim shall be limited to such items.

ARTICLE 47. APPROVAL BY PUBLIC DESIGN COMMISSION

47.1 All works of art, including paintings, mural decorations, stained glass, statues, bas-reliefs, and other sculptures, monuments, fountains, arches, and other structures of a permanent character intended for ornament or commemoration, and every design of the same to be used in the performance of this **Contract**, and the design of all bridges, approaches, buildings, gates, fences, lamps, or structures to be erected, pursuant

to the terms of this **Contract**, shall be submitted to the Art Commission, d/b/a the Public Design Commission of the City of New York, and shall be approved by the Public Design Commission prior to the erection or placing in position of the same. The final payment shall not become due or payable under this **Contract** unless and until the Public Design Commission shall certify that the design for the **Work** herein contracted for has been approved by the said Public Design Commission, and that the same has been executed in substantial accordance with the design so approved, pursuant to the provisions of Chapter 37, Section 854 of the **City** Charter, as amended.

CHAPTER X: CONTRACTOR'S DEFAULT

ARTICLE 48. COMMISSIONER'S RIGHT TO DECLARE CONTRACTOR IN DEFAULT

48.1 In addition to those instances specifically referred to in other Articles herein, the **Commissioner** shall have the right to declare the **Contractor** in default of this **Contract** if:

48.1.1 The **Contractor** fails to commence **Work** when notified to do so by the **Commissioner**; or if

48.1.2 The **Contractor** shall abandon the **Work**; or if

48.1.3 The **Contractor** shall refuse to proceed with the **Work** when and as directed by the **Commissioner**; or if

48.1.4 The **Contractor** shall, without just cause, reduce its working force to a number which, if maintained, would be insufficient, in the opinion of the **Commissioner**, to complete the **Work** in accordance with the progress schedule; or if

48.1.5 The **Contractor** shall fail or refuse to increase sufficiently such working force when ordered to do so by the **Commissioner**; or if

48.1.6 The **Contractor** shall sublet, assign, transfer, convert or otherwise dispose of this **Contract** other than as herein specified; or sell or assign a majority interest in the **Contractor**; or if

48.1.7 The **Contractor** fails to secure and maintain all required insurance; or if

48.1.8 A receiver or receivers are appointed to take charge of the **Contractor's** property or affairs; or if

48.1.9 The **Commissioner** shall be of the opinion that the **Contractor** is or has been unnecessarily or unreasonably or willfully delaying the performance and completion of the **Work**, or the award of necessary subcontracts, or the placing of necessary material and equipment orders; or if

48.1.10 The **Commissioner** shall be of the opinion that the **Contractor** is or has been willfully or in bad faith violating any of the provisions of this **Contract**; or if

48.1.11 The **Commissioner** shall be of the opinion that the **Work** cannot be completed within the time herein provided therefor or within the time to which such completion may have been extended; provided, however, that the impossibility of timely completion is, in the

Commissioner's opinion, attributable to conditions within the **Contractor's** control; or if

48.1.12 The **Work** is not completed within the time herein provided therefor or within the time to which the **Contractor** may be entitled to have such completion extended; or if

48.1.13 Any statement or representation of the **Contractor** in the **Contract** or in any document submitted by the **Contractor** with respect to the **Work**, the **Project**, or the **Contract** (or for purposes of securing the **Contract**) was untrue or incorrect when made; or if

48.1.14 The **Contractor** or any of its officers, directors, partners, five (5%) percent shareholders, principals, or other persons substantially involved in its activities, commits any of the acts or omissions specified as the grounds for debarment in the **PPB** Rules.

48.2 Before the **Commissioner** shall exercise his/her right to declare the **Contractor** in default, the **Commissioner** shall give the **Contractor** an opportunity to be heard, upon not less than two (2) **Days'** notice.

ARTICLE 49. EXERCISE OF THE RIGHT TO DECLARE DEFAULT

49.1 The right to declare the **Contractor** in default for any of the grounds specified or referred to in Article 48 shall be exercised by sending the **Contractor** a notice, signed by the **Commissioner**, setting forth the ground or grounds upon which such default is declared (hereinafter referred to as a "Notice of Default").

49.2 The **Commissioner's** determination that the **Contractor** is in default shall be conclusive, final, and binding on the parties and such a finding shall preclude the **Contractor** from commencing a plenary action for any damages relating to the **Contract**. If the **Contractor** protests the determination of the **Commissioner**, the **Contractor** may commence an action in a court of competent jurisdiction of the State of New York under Article 78 of the New York Civil Practice Law and Rules.

ARTICLE 50. QUITTING THE SITE

50.1 Upon receipt of such notice the **Contractor** shall immediately discontinue all further operations under this **Contract** and shall immediately quit the **Site**, leaving untouched all plant, materials, equipment, tools, and supplies then on the **Site**.

ARTICLE 51. COMPLETION OF THE WORK

51.1 The **Commissioner**, after declaring the **Contractor** in default, may then have the **Work** completed by such means and in such manner, by contract with or without public letting, or otherwise, as he/she may deem advisable, utilizing for such purpose such of the **Contractor's** plant, materials, equipment, tools, and supplies remaining on the **Site**, and also such **Subcontractors**, as he/she may deem advisable.

51.2 After such completion, the **Commissioner** shall make a certificate stating the expense incurred in such completion, which shall include the cost of re-letting and also the total amount of liquidated damages (at the rate provided for in the **Contract**) from the date when the **Work** should have been completed by the **Contractor** in accordance with the terms hereof to the date of actual completion of the **Work**. Such certificate shall be binding and conclusive upon the **Contractor**, its sureties, and any person claiming under the **Contractor**, as to the amount thereof.

51.3 The expense of such completion, including any and all related and incidental costs, as so certified by the **Commissioner**, and any liquidated damages assessed against the **Contractor**, shall be charged against and deducted out of monies which are earned by the **Contractor** prior to the date of default. Should the expense of such completion, as certified by the **Commissioner**, exceed the total sum which would have been payable under the **Contract** if it had been completed by the **Contractor**, any excess shall be paid by the **Contractor**.

ARTICLE 52. PARTIAL DEFAULT

52.1 In case the **Commissioner** shall declare the **Contractor** in default as to a part of the **Work** only, the **Contractor** shall discontinue such part, shall continue performing the remainder of the **Work** in strict conformity with the terms of this **Contract**, and shall in no way hinder or interfere with any **Other Contractor(s)** or persons whom the **Commissioner** may engage to complete the **Work** as to which the **Contractor** was declared in default.

52.2 The provisions of this Chapter relating to declaring the **Contractor** in default as to the entire **Work** shall be equally applicable to a declaration of partial default, except that the **Commissioner** shall be entitled to utilize for completion of the part of the **Work** as to which the **Contractor** was declared in default only such plant, materials, equipment, tools, and supplies as had been previously used by the **Contractor** on such part.

ARTICLE 53. PERFORMANCE OF UNCOMPLETED WORK

53.1 In completing the whole or any part of the **Work** under the provisions of this Chapter X, the **Commissioner** shall have the power to depart from or change or vary the terms and provisions of this **Contract**, provided, however, that such departure, change or variation is made for the purpose of reducing the time or expense of such completion. Such departure, change or variation, even to the extent of accepting a lesser or different performance, shall not affect the conclusiveness of the **Commissioner's** certificate of the cost of completion referred to in Article 51, nor shall it constitute a defense to an action to recover the amount by which such certificate exceeds the amount which would have been payable to the **Contractor** hereunder but for its default.

ARTICLE 54. OTHER REMEDIES

54.1 In addition to the right to declare the **Contractor** in default pursuant to this Chapter X, the **Commissioner** shall have the absolute right, in his/her sole discretion and without a hearing, to complete or cause to be completed in the same manner as described in Articles 51 and 53, any or all unsatisfactory or uncompleted punch list **Work** that remains after the completion date specified in the **Final Approved Punch List**. A written notice of the exercise of this right shall be sent to the **Contractor** who shall immediately quit the **Site** in accordance with the provisions of Article 50.

54.2 The expense of completion permitted under Article 54.1, including any and all related and incidental costs, as so certified by the **Commissioner**, shall be charged against and deducted out of monies which have been earned by the **Contractor** prior to the date of the exercise of the right set forth in Article 54.1; the balance of such monies, if any, subject to the other provisions of this **Contract**, to be paid to the **Contractor** without interest after such completion. Should the expense of such completion, as certified by

the **Commissioner**, exceed the total sum which would have been payable under the **Contract** if it had been completed by the **Contractor**, any excess shall be paid by the **Contractor**.

54.3 The previous provisions of this Chapter X shall be in addition to any and all other remedies available under **Law** or in equity.

54.4 The exercise by the **City** of any remedy set forth herein shall not be deemed a waiver by the **City** of any other legal or equitable remedy contained in this **Contract** or provided under **Law**.

CHAPTER XI: MISCELLANEOUS PROVISIONS

ARTICLE 55. CONTRACTOR'S WARRANTIES

55.1 In consideration of, and to induce, the award of this **Contract** to the **Contractor**, the **Contractor** represents and warrants:

55.1.1 That it is financially solvent, sufficiently experienced and competent to perform the **Work**; and

55.1.2 That the facts stated in its bid and the information given by it pursuant to the Information for Bidders is true and correct in all respects; and

55.1.3 That it has read and complied with all requirements set forth in the **Contract**.

ARTICLE 56. CLAIMS AND ACTIONS THEREON

56.1 Any claim, that is not subject to dispute resolution under the **PPB** Rules or this **Contract**, against the **City** for damages for breach of **Contract** shall not be made or asserted in any action, unless the **Contractor** shall have strictly complied with all requirements relating to the giving of notice and of information with respect to such claims, as herein before provided.

56.2 Nor shall any action be instituted or maintained on any such claims unless such action is commenced within six (6) months after **Substantial Completion**; except that:

56.2.1 Any claims arising out of events occurring after **Substantial Completion** and before **Final Acceptance** of the **Work** shall be asserted within six (6) months of **Final Acceptance** of the **Work**;

56.2.2 If the **Commissioner** exercises his/her right to complete or cause to complete any or all unsatisfactory or uncompleted punch list **Work** that remains after the completion date specified in the **Final Approved Punch List** pursuant to Article 54, any such action shall be commenced within six (6) months from the date the **Commissioner** notifies the **Contractor** in writing that he/she has exercised such right. Any claims for monies deducted, retained or withheld under the provisions of this **Contract** shall be asserted within six (6) months after the date when such monies otherwise become due and payable hereunder; and

56.2.3 If the **Commissioner** exercises his/her right to terminate the **Contract** pursuant to Article 64, any such action shall be commenced within six (6) months of the date the **Commissioner** exercises said right.

ARTICLE 57. INFRINGEMENT

57.1 The **Contractor** shall be solely responsible for and shall defend, indemnify, and hold the **City** harmless from any and all claims (even if the allegations of the lawsuit are without merit) and judgments for damages and from costs and expenses to which the **City** may be subject to or which it may suffer or incur allegedly arising out of or in connection with any infringement by the **Contractor** of any copyright, trade secrets, trademark or patent rights or any other property or personal right of any third party by the **Contractor** and/or its **Subcontractors** in the performance or completion of the **Work**. Insofar as the facts or **Law** relating to any claim would preclude the **City** from being completely indemnified by the **Contractor**, the **City** shall be partially indemnified by the **Contractor** to the fullest extent permitted by **Law**.

ARTICLE 58. NO CLAIM AGAINST OFFICIALS, AGENTS OR EMPLOYEES

58.1 No claim whatsoever shall be made by the **Contractor** against any official, agent or employee of the **City** for, or on account of, anything done or omitted to be done in connection with this **Contract**.

ARTICLE 59. SERVICE OF NOTICES

59.1 The **Contractor** hereby designates the business address, fax number, and email address specified in its bid, as the place where all notices, directions or other communications to the **Contractor** may be delivered, or to which they may be mailed. Any notice, direction, or communication from either party to the other shall be in writing and shall be deemed to have been given when (i) delivered personally; (ii) sent by certified mail, return receipt requested; (iii) delivered by overnight or same day courier service in a properly addressed envelope with confirmation; or (iv) sent by fax or email and, unless receipt of the fax or e-mail is acknowledged by the recipient by fax or e-mail, deposited in a post office box regularly maintained by the United States Postal Service in a properly addressed, postage pre-paid envelope.

59.2 **Contractor's** notice address, email address, or fax number may be changed at any time by an instrument in writing, executed and acknowledged by the **Contractor**, and delivered to the **Commissioner**.

59.3 Nothing herein contained shall, however, be deemed to preclude or render inoperative the service of any notice, direction or other communication upon the **Contractor** personally, or, if the **Contractor** is a corporation, upon any officer thereof.

ARTICLE 60. UNLAWFUL PROVISIONS DEEMED STRICKEN FROM CONTRACT

60.1 If this **Contract** contains any unlawful provision not an essential part of the **Contract** and which shall not appear to have been a controlling or material inducement to the making thereof, the same shall be deemed of no effect and shall, upon notice by either party, be deemed stricken from the **Contract** without affecting the binding force of the remainder.

ARTICLE 61. ALL LEGAL PROVISIONS DEEMED INCLUDED

61.1 It is the intent and understanding of the parties to this **Contract** that each and every provision of **Law** required to be inserted in this **Contract** shall be and is inserted herein. Furthermore, it is hereby stipulated that every such provision is to be deemed to be inserted herein, and if, through mistake or otherwise, any such provision is not inserted, or is not inserted in correct form, then this **Contract** shall forthwith upon the application of either party be amended by such insertion so as to comply strictly with the **Law** and without prejudice to the rights of either party hereunder.

ARTICLE 62. TAX EXEMPTION

62.1 The **City** is exempt from payment of Federal, State, and local taxes, including sales and compensating use taxes of the State of New York and its cities and counties on all tangible personal property sold to the **City** pursuant to the provisions of this **Contract**. These taxes are not to be included in bids. However, this exemption does not apply to tools, machinery, equipment or other property leased by or to the **Contractor**, **Subcontractor** or **Materialman** or to tangible personal property which, even though it is consumed, is not incorporated into the completed **Work** (consumable supplies) and tangible personal property that the **Contractor** is required to remove from the **Site** during or upon completion of the **Work**. The **Contractor** and its **Subcontractors** and **Materialmen** shall be responsible for and pay any and all applicable taxes, including sales and compensating use taxes, on such leased tools, machinery, equipment or other property and upon all such consumable supplies and tangible personal property that the **Contractor** is required to remove from the **Site** during or upon completion of the **Work**.

62.2 The **Contractor** agrees to sell and the **City** agrees to purchase all tangible personal property, other than consumable supplies and other tangible personal property that the **Contractor** is required to remove from the **Site** during or upon completion of the **Work**, that is required, necessary or proper for or incidental to the construction of the **Project** covered by this **Contract**. The sum paid under this **Contract** for such tangible personal property shall be in full payment and consideration for the sale of such tangible personal property.

62.2.1 The **Contractor** agrees to construct the **Project** and to perform all **Work**, labor and services rendered, necessary, proper or incidental thereto for the sum shown in the bid for the performance of such **Work**, labor, and services, and the sum so paid pursuant to this **Contract** for such **Work**, labor, and services, shall be in full consideration for the performance by the **Contractor** of all its duties and obligations under this **Contract** in connection with said **Work**, labor, and services.

62.3 20 NYCRR Section 541.3(d) provides that a **Contractor's** purchases of tangible personal property that is either incorporated into real property owned by a governmental entity or purchased for and sold to a governmental entity are exempt from sales and use tax. The **City** shall not pay sales tax for any such tangible personal property that it purchases from the **Contractor** pursuant to the **Contract**. With respect to such tangible personal property, the **Contractor**, at the request of the **City**, shall furnish to the **City** such bills of sale and other instruments as may be required by the **City**, properly executed, acknowledged and delivered assuring to the **City** title to such tangible personal property, free of liens and/or encumbrances, and the **Contractor** shall mark or otherwise identify all such tangible personal property as the property of the **City**.

62.4 Title to all tangible personal property to be sold by the **Contractor** to the **City** pursuant to the provisions of the **Contract** shall immediately vest in and become the sole property of the **City** upon delivery of such tangible personal property to the **Site**. Notwithstanding such transfer of title, the **Contractor** shall

have the full and continuing responsibility to install such tangible personal property in accordance with the provisions of this **Contract**, protect it, maintain it in a proper condition and forthwith repair, replace and make good any damage thereto, theft or disappearance thereof, and furnish additional tangible personal property in place of any that may be lost, stolen or rendered unusable, without cost to the **City**, until such time as the **Work** covered by the **Contract** is fully accepted by the **City**. Such transfer of title shall in no way affect any of the **Contractor's** obligations hereunder. In the event that, after title has passed to the **City**, any of the tangible personal property is rejected as being defective or otherwise unsatisfactory, title to all such tangible personal property shall be deemed to have been transferred back to the **Contractor**.

62.5 The purchase by **Subcontractors** or **Materialmen** of tangible personal property to be sold hereunder shall be a purchase or procurement for resale to the **Contractor** (either directly or through other **Subcontractors**) and therefore not subject to the aforesaid sales and compensating use taxes, provided that the subcontracts and purchase agreements provide for the resale of such tangible personal property and that such subcontracts and purchase agreements are in a form similar to this **Contract** with respect to the separation of the sale of consumable supplies and tangible personal property that the **Contractor** is required to remove from the **Site** during or upon completion of the **Work** from the **Work** and labor, services, and any other matters to be provided, and provided further that the subcontracts and purchase agreements provide separate prices for tangible personal property and all other services and matters. Such separation shall actually be followed in practice, including the separation of payments for tangible personal property from the payments for other **Work** and labor and other things to be provided.

62.6 The **Contractor** and its **Subcontractors** and **Materialmen** shall furnish a **Contractor** Exempt Purchase Certificate to all persons, firms or corporations from which they purchase tangible personal property for the performance of the **Work** covered by this **Contract**.

62.7 In the event any of the provisions of this Article 62 shall be deemed to be in conflict with any other provisions of this **Contract** or create any ambiguity, then the provisions of this Article 62 shall control.

ARTICLE 63. INVESTIGATION(S) CLAUSE

63.1 The parties to this **Contract** agree to cooperate fully and faithfully with any investigation, audit or inquiry conducted by a United States, a State of New York (State) or a **City** governmental agency or authority that is empowered directly or by designation to compel the attendance of witnesses and to examine witnesses under oath, or conducted by the Inspector General of a governmental agency that is a party in interest to the transaction, submitted bid, submitted proposal, contract, lease, permit or license that is the subject of the investigation, audit or inquiry.

63.2 If any person who has been advised that his/her statement, and any information from such statement, will not be used against him/her in any subsequent criminal proceeding refuses to testify before a grand jury or other governmental agency or authority empowered directly or by designation to compel the attendance of witnesses and to examine witnesses under oath concerning the award of or performance under any transaction, agreement, lease, permit, contract, or license entered into with the **City**, the State, or any political subdivision or public authority thereof, or the Port Authority of New York and New Jersey, or any local development corporation within the **City**, or any public benefit corporation organized under the **Laws** of the State of New York, or;

63.3 If any person refuses to testify for a reason other than the assertion of his/her privilege against self incrimination in an investigation, audit or inquiry conducted by a **City** or State governmental agency or authority empowered directly or by designation to compel the attendance of witnesses and to take testimony under oath, or by the Inspector General of the governmental agency that is a party in interest in, and is

seeking testimony concerning the award of, or performance under any transaction, agreement, lease, permit, contract, or license entered into with the **City**, the State, or any political subdivision thereof or any local development corporation within the **City**, then;

63.4 The **Commissioner** whose **Agency** is a party in interest to the transaction, submitted bid, submitted proposal, contract, lease, permit, or license shall convene a hearing, upon not less than five (5) **Days**' written notice to the parties involved to determine if any penalties should attach for the failure of a person to testify.

63.5 If any non-governmental party to the hearing requests an adjournment, the **Commissioner** who convened the hearing may, upon granting the adjournment, suspend any contract, lease, permit, or license, pending the final determination pursuant to Article 63.7 without the **City** incurring any penalty or damages for delay or otherwise.

63.6 The penalties which may attach after a final determination by the **Commissioner** may include but shall not exceed:

63.6.1 The disqualification for a period not to exceed five (5) years from the date of an adverse determination for any person, or any entity of which such person was a member at the time the testimony was sought, from submitting bids for, or transacting business with, or entering into or obtaining any contract, lease, permit or license with or from the **City**; and/or

63.6.2 The cancellation or termination of any and all such existing **City** contracts, leases, permits or licenses that the refusal to testify concerns and that have not been assigned as permitted under this **Contract**, nor the proceeds of which pledged, to an unaffiliated and unrelated institutional lender for fair value prior to the issuance of the notice scheduling the hearing, without the **City** incurring any penalty or damages on account of such cancellation or termination; monies lawfully due for goods delivered, work done, rentals, or fees accrued prior to the cancellation or termination shall be paid by the **City**.

63.7 The **Commissioner** shall consider and address in reaching his/her determination and in assessing an appropriate penalty the factors in Articles 63.7.1 and 63.7.2. The **Commissioner** may also consider, if relevant and appropriate, the criteria established in Articles 63.7.3 and 63.7.4, in addition to any other information which may be relevant and appropriate:

63.7.1 The party's good faith endeavors or lack thereof to cooperate fully and faithfully with any governmental investigation or audit, including but not limited to the discipline, discharge, or disassociation of any person failing to testify, the production of accurate and complete books and records, and the forthcoming testimony of all other members, agents, assignees or fiduciaries whose testimony is sought.

63.7.2 The relationship of the person who refused to testify to any entity that is a party to the hearing, including but not limited to, whether the person whose testimony is sought has an ownership interest in the entity and/or the degree of authority and responsibility the person has within the entity.

63.7.3 The nexus of the testimony sought to the subject entity and its contracts, leases, permits or licenses with the **City**.

63.7.4 The effect a penalty may have on an unaffiliated and unrelated party or entity that has a significant interest in an entity subject to penalties under Article 63.6, provided that the party

or entity has given actual notice to the **Commissioner** upon the acquisition of the interest, or at the hearing called for in Article 63.4, gives notice and proves that such interest was previously acquired. Under either circumstance the party or entity shall present evidence at the hearing demonstrating the potential adverse impact a penalty will have on such person or entity.

63.8 Definitions:

63.8.1 The term “license” or “permit” as used in this Article 63 shall be defined as a license, permit, franchise or concession not granted as a matter of right.

63.8.2 The term “person” as used in this Article 63 shall be defined as any natural person doing business alone or associated with another person or entity as a partner, director, officer, principal or employee.

63.8.3 The term “entity” as used in this Article 63 shall be defined as any firm, partnership, corporation, association, joint venture, or person that receives monies, benefits, licenses, leases, or permits from or through the **City** or otherwise transacts business with the **City**.

63.8.4 The term “member” as used in this Article 63 shall be defined as any person associated with another person or entity as a partner, director, officer, principal or employee.

63.9 In addition to and notwithstanding any other provision of this **Contract**, the **Commissioner** may in his/her sole discretion terminate this **Contract** upon not less than three (3) **Days**’ written notice in the event the **Contractor** fails to promptly report in writing to the **Commissioner** of the Department of Investigations (“DOI”) of the **City** any solicitation of money, goods, requests for future employment or other benefit or thing of value, by or on behalf of any employee of the **City** or other person, firm, corporation or entity for any purpose which may be related to the procurement or obtaining of this **Contract** by the **Contractor**, or affecting the performance of this **Contract**.

ARTICLE 64. TERMINATION BY THE CITY

64.1 In addition to termination pursuant to any other article of this **Contract**, the **Commissioner** may, at any time, terminate this **Contract** by written notice to the **Contractor**. In the event of termination, the **Contractor** shall, upon receipt of such notice, unless otherwise directed by the **Commissioner**:

64.1.1 Stop **Work** on the date specified in the notice;

64.1.2 Take such action as may be necessary for the protection and preservation of the **City**’s materials and property;

64.1.3 Cancel all cancelable orders for material and equipment;

64.1.4 Assign to the **City** and deliver to the **Site** or another location designated by the **Commissioner**, any non-cancelable orders for material and equipment that is not capable of use except in the performance of this **Contract** and has been specifically fabricated for the sole purpose of this **Contract** and not incorporated in the **Work**;

64.1.5 Take no action which will increase the amounts payable by the **City** under this
64.1.5 **Contract**.

64.2 In the event of termination by the **City** pursuant to this Article 64, payment to the **Contractor** shall be in accordance with Articles 64.2.1, 64.2.2 or 64.2.3, to the extent that each respective article applies.

64.2.1 Lump Sum Contracts or Items: On all lump sum **Contracts**, or on lump sum items in a **Contract**, the **City** will pay the **Contractor** the sum of the amounts described in Articles 64.2.1(a) and 64.2.1(b), less all payments previously made pursuant to this **Contract**. On lump sum **Contracts** only, the **City** will also pay the **Contractor** an additional sum as provided in Article 64.2.1(c).

64.2.1(a) For **Work** completed prior to the notice of termination, the **Contractor** shall be paid a pro rata portion of the lump sum bid amount, plus approved change orders, based upon the percent completion of the **Work**, as determined by the **Commissioner**. For the purpose of determining the pro rata portion of the lump sum bid amount to which the **Contractor** is entitled, the bid breakdown submitted in accordance with Article 41 shall be considered, but shall not be dispositive. The **Commissioner's** determination hereunder shall be final, binding, and conclusive.

64.2.1(b) For non-cancelable material and equipment that is not capable of use except in the performance of this **Contract** and has been specifically fabricated for the sole purpose of this **Contract**, but not yet incorporated in the **Work**, the **Contractor** shall be paid the lesser of the following, less salvage value:

64.2.1(b)(i) The Direct Cost, as defined in Article 64.2.4; or

64.2.1(b)(ii) The fair and reasonable value, if less than Direct Cost, of such material and equipment, plus necessary and reasonable delivery costs.

64.2.1(b)(iii) In addition, the **Contractor** shall be paid five (5%) percent of the amount described in Article 64.2.1(b)(i) or Article 64.2.1(b)(ii), whichever applies.

64.2.1(c) Except as otherwise provided in Article 64.2.1(d), on all lump sum **Contracts**, the **Contractor** shall be paid the percentage indicated below applied to the difference between the total lump sum bid amount and the total of all payments made prior to the notice of termination plus all payments allowed pursuant to Articles 64.2.1(a) and 64.2.1(b):

64.2.1(c)(i) Five (5%) percent of the first five million (\$5,000,000) dollars; and

64.2.1(c)(ii) Three (3%) percent of any amount between five million (\$5,000,000) dollars and fifteen million (\$15,000,000) dollars; plus

64.2.1(c)(iii) One (1%) percent of any amount over fifteen million (\$15,000,000) dollars.

64.2.1(d) In the event the **City** terminates a lump sum **Contract** pursuant to this Article 64 within ninety (90) **Days** after registration of the **Contract** with the **Comptroller**, the **Contractor** shall be paid one (1%) percent of the difference between the lump sum bid amount and the total of all payments made pursuant to this Article 64.2.

64.2.2 Unit Price Contracts or Items: On all unit price **Contracts**, or on unit price items in a

Contract, the **City** will pay the **Contractor** the sum of the amounts described in Articles 64.2.2(a) and 64.2.2(b), less all payments previously made pursuant to this **Contract**:

64.2.2(a) For all completed units, the unit price stated in the **Contract**, and

64.2.2(b) For units that have been ordered but are only partially completed, the **Contractor** will be paid:

64.2.2(b)(i) A pro rata portion of the unit price stated in the **Contract** based upon the percent completion of the unit and

64.2.2(b)(ii) For non-cancelable material and equipment, payment will be made pursuant to Article 64.2.1(b).

64.2.3 Time and Materials Contracts or Items Based on Time and Material Records: On all **Contracts** or items in a **Contract** where payment for the **Work** is based on time and material records, the **Contractor** shall be paid in accordance with Article 26, less all payments previously made pursuant to this **Contract**.

64.2.4 Direct Costs: Direct Costs as used in this Article 64.2 shall mean:

64.2.4(a) The actual purchase price of material and equipment, plus necessary and reasonable delivery costs,

64.2.4(b) The actual cost of labor involved in construction and installation at the **Site**, and

64.2.4(c) The actual cost of necessary bonds and insurance purchased pursuant to requirements of this **Contract** less any amounts that have been or should be refunded by the **Contractor's** sureties or insurance carriers.

64.2.4(d) Direct Costs shall not include overhead.

64.3 In no event shall any payments under this Article 64 exceed the **Contract** price for such items.

64.4 All payments pursuant to Article 64 shall be in the nature of liquidated damages and shall be accepted by the **Contractor** in full satisfaction of all claims against the **City**.

64.5 The **City** may deduct or set off against any sums due and payable pursuant to this Article 64, any deductions authorized by this **Contract** or by **Law** (including but not limited to liquidated damages) and any claims it may have against the **Contractor**. The **City's** exercise of the right to terminate the **Contract** pursuant to this Article 64 shall not impair or otherwise effect the **City's** right to assert any claims it may have against the **Contractor** in a plenary action.

64.6 Where the **Work** covered by the **Contract** has been substantially completed, as determined in writing by the **Commissioner**, termination of the **Work** shall be handled as an omission of **Work** pursuant to Articles 29 and 33, in which case a change order will be issued to reflect an appropriate reduction in the **Contract** sum, or if the amount is determined after final payment, such amount shall be paid by the **Contractor**.

ARTICLE 65. CHOICE OF LAW, CONSENT TO JURISDICTION AND VENUE

65.1 This **Contract** shall be deemed to be executed in the **City** regardless of the domicile of the **Contractor**, and shall be governed by and construed in accordance with the **Laws** of the State of New York and the **Laws** of the United States, where applicable.

65.2 The parties agree that any and all claims asserted against the **City** arising under this **Contract** or related thereto shall be heard and determined in the courts of the State of New York (“New York State Courts”) located in the **City** and County of New York. To effect this **Contract** and intent, the **Contractor** agrees:

65.2.1 If the **City** initiates any action against the **Contractor** in Federal court or in a New York State Court, service of process may be made on the **Contractor** either in person, wherever such **Contractor** may be found, or by registered mail addressed to the **Contractor** at its address as set forth in this **Contract**, or to such other address as the **Contractor** may provide to the **City** in writing; and

65.2.2 With respect to any action between the **City** and the **Contractor** in a New York State Court, the **Contractor** hereby expressly waives and relinquishes any rights it might otherwise have:

65.2.2(a) To move to dismiss on grounds of forum non conveniens;

65.2.2(b) To remove to Federal Court; and

65.2.2(c) To move for a change of venue to a New York State Court outside New York County.

65.2.3 With respect to any action brought by the **City** against the **Contractor** in a Federal Court located in the **City**, the **Contractor** expressly waives and relinquishes any right it might otherwise have to move to transfer the action to a Federal Court outside the **City**.

65.2.4 If the **Contractor** commences any action against the **City** in a court located other than in the **City** and County of New York, upon request of the **City**, the **Contractor** shall either consent to a transfer of the action to a New York State Court of competent jurisdiction located in the **City** and County of New York or, if the Court where the action is initially brought will not or cannot transfer the action, the **Contractor** shall consent to dismiss such action without prejudice and may thereafter reinstate the action in a New York State Court of competent jurisdiction in New York County.

65.3 If any provision(s) of this Article 65 is held unenforceable for any reason, each and all other provision(s) shall nevertheless remain in full force and effect.

ARTICLE 66. PARTICIPATION IN AN INTERNATIONAL BOYCOTT

66.1 The **Contractor** agrees that neither the **Contractor** nor any substantially owned affiliated company is participating or shall participate in an international boycott in violation of the provisions of the Federal Export Administration Act of 1979, as amended, or the regulations of the United States Department of Commerce (Commerce Department) promulgated thereunder.

66.2 Upon the final determination by the Commerce Department or any other agency of the United States as to, or conviction of the **Contractor** or a substantially-owned affiliated company thereof for participation in an international boycott in violation of the provisions of the Export Administration Act of 1979, as amended, or the regulations promulgated thereunder, the **Comptroller** may, at his/her option, render forfeit and void this **Contract**.

66.3 The **Contractor** shall comply in all respects, with the provisions of Section 6-114 of the Administrative Code and the rules and regulations issued by the **Comptroller** thereunder.

ARTICLE 67. LOCALLY BASED ENTERPRISE PROGRAM

67.1 This **Contract** is subject to the requirements of Section 6-108.1 of the Administrative Code and regulations promulgated thereunder. No construction contract shall be awarded unless and until these requirements have been complied with in their entirety; however, compliance with this Article 67 is not required if the Agency sets Subcontractor Participation Goals for Minority- and Women-Owned Business Enterprises (M/WBEs).

67.2 Unless specifically waived by the **Commissioner** with the approval of the Division of Economic and Financial Opportunity of the **City** Department of Business Services, if any portion of the **Contract** is subcontracted, not less than ten (10%) percent of the total dollar amount of the **Contract** shall be awarded to locally based enterprises (LBEs); except that where less than ten (10%) percent of the total dollar amount of the **Contract** is subcontracted, such lesser percentage shall be so awarded.

67.3 The **Contractor** shall not require performance and payment bonds from LBE **Subcontractors**.

67.4 If the **Contractor** has indicated prior to award that no **Work** will be subcontracted, no **Work** shall be subcontracted without the prior approval of the **Commissioner**, which shall be granted only if the **Contractor** makes a good faith effort beginning at least six (6) weeks before the **Work** is to be performed to obtain LBE **Subcontractors** to perform the **Work**.

67.5 If the **Contractor** has not identified sufficient LBE **Subcontractors** prior to award, it shall sign a letter of compliance stating that it complies with Section 6-108.1 of the Administrative Code, recognizes that achieving the LBE requirement is a condition of its **Contract**, and shall submit documentation demonstrating its good faith efforts to obtain LBEs. After award, the **Contractor** shall begin to solicit LBE's to perform subcontracted **Work** at least six (6) weeks before the date such **Work** is to be performed and shall demonstrate that a good faith effort has been made to obtain LBEs on each subcontract until it meets the required percentage.

67.6 Failure of the **Contractor** to comply with the requirements of Section 6-108.1 of the Administrative Code and the regulations promulgated thereunder shall constitute a material breach of this **Contract**. Remedy for such breach may include the imposition of any or all of the following sanctions:

67.6.1 Reducing the **Contractor's** compensation by an amount equal to the dollar value of the percentage of the LBE subcontracting requirement not complied with;

67.6.2 Declaring the **Contractor** in default;

67.6.3 If the **Contractor** is an LBE, de-certifying and declaring the **Contractor** ineligible to participate in the LBE program for a period of up to three (3) years.

ARTICLE 68. ANTITRUST

68.1 The **Contractor** hereby assigns, sells, and transfers to the **City** all right, title, and interest in and to any claims and causes of action arising under the antitrust **Laws** of New York State or of the United States relating to the particular goods or services purchased or procured by the **City** under this **Contract**.

ARTICLE 69. MacBRIDE PRINCIPLES PROVISIONS

69.1 Notice To All Prospective **Contractors**:

69.1.1 Local Law No. 34 of 1991 became effective on September 10, 1991 and added Section 6-115.1 of the Administrative Code. The local **Law** provides for certain restrictions on **City Contracts** to express the opposition of the people of the **City** to employment discrimination practices in Northern Ireland to promote freedom of work-place opportunity.

69.1.2 Pursuant to Section 6-115.1, prospective **Contractors** for **Contracts** to provide goods or services involving an expenditure of an amount greater than ten thousand (\$10,000.) dollars, or for construction involving an amount greater than fifteen thousand (\$15,000.) dollars, are asked to sign a rider in which they covenant and represent, as a material condition of their **Contract**, that any business operations in Northern Ireland conducted by the **Contractor** and any individual or legal entity in which the **Contractor** holds a ten (10%) percent or greater ownership interest in the **Contractor** will be conducted in accordance with the MacBride Principles of nondiscrimination in employment.

69.1.3 Prospective **Contractors** are not required to agree to these conditions. However, in the case of **Contracts** let by competitive sealed bidding, whenever the lowest responsible bidder has not agreed to stipulate to the conditions set forth in this notice and another bidder who has agreed to stipulate to such conditions has submitted a bid within five (5%) percent of the lowest responsible bid for a **Contract** to supply goods, services or construction of comparable quality, the **Agency** shall refer such bids to the Mayor, the Speaker or other officials, as appropriate, who may determine, in accordance with applicable **Law**, that it is in the best interest of the **City** that the **Contract** be awarded to other than the lowest responsible pursuant to Section 313(b)(2) of the **City** Charter.

69.1.4 In the case of **Contracts** let by other than competitive sealed bidding, if a prospective **Contractor** does not agree to these conditions, no **Agency**, elected official or the **City** Council shall award the **Contract** to that bidder unless the **Agency** seeking to use the goods, services or construction certifies in writing that the **Contract** is necessary for the **Agency** to perform its functions and there is no other responsible **Contractor** who will supply goods, services or construction of comparable quality at a comparable price.

69.2 In accordance with Section 6-115.1 of the Administrative Code, the **Contractor** stipulates that such **Contractor** and any individual or legal entity in which the **Contractor** holds a ten (10%) percent or greater ownership interest in the **Contractor** either:

69.2.1 Have no business operations in Northern Ireland, or

69.2.2 Shall take lawful steps in good faith to conduct any business operations they have in

Northern Ireland in accordance with the MacBride Principles, and shall permit independent monitoring of their compliance with such principles.

69.3 For purposes of this Article, the following terms shall have the following meanings:

69.3.1 “MacBride Principles” shall mean those principles relating to nondiscrimination in employment and freedom of work-place opportunity which require employers doing business in Northern Ireland to:

69.3.1(a) increase the representation of individuals from under-represented religious groups in the workforce, including managerial, supervisory, administrative, clerical and technical jobs;

69.3.1(b) take steps to promote adequate security for the protection of employees from under-represented religious groups both at the work-place and while traveling to and from **Work**;

69.3.1(c) ban provocative religious or political emblems from the workplace;

69.3.1(d) publicly advertise all job openings and make special recruitment efforts to attract applicants from under-represented religious groups;

69.3.1(e) establish layoff, recall, and termination procedures which do not in practice favor a particular religious group;

69.3.1(f) abolish all job reservations, apprenticeship restrictions and different employment criteria which discriminate on the basis of religion;

69.3.1(g) develop training programs that will prepare substantial numbers of current employees from under-represented religious groups for skilled jobs, including the expansion of existing programs and the creation of new programs to train, upgrade, and improve the skills of workers from under-represented religious groups;

69.3.1(h) establish procedures to assess, identify, and actively recruit employees from under-represented religious groups with potential for further advancement; and

69.3.1(i) appoint a senior management staff member to oversee affirmative action efforts and develop a timetable to ensure their full implementation.

69.4 The **Contractor** agrees that the covenants and representations in Article 69.2 are material conditions to this **Contract**. In the event the **Agency** receives information that the **Contractor** who made the stipulation required by this Article 69 is in violation thereof, the **Agency** shall review such information and give the **Contractor** an opportunity to respond. If the **Agency** finds that a violation has occurred, the **Agency** shall have the right to declare the **Contractor** in default and/or terminate this **Contract** for cause and procure supplies, services or **Work** from another source in the manner the **Agency** deems proper. In the event of such termination, the **Contractor** shall pay to the **Agency**, or the **Agency** in its sole discretion may withhold from any amounts otherwise payable to the **Contractor**, the difference between the **Contract** price for the uncompleted portion of this **Contract** and the cost to the **Agency** of completing performance of this **Contract** either itself or by engaging another **Contractor** or **Contractors**. In the case of a requirement **Contract**, the **Contractor** shall be liable for such difference in price for the entire amount of supplies required by the **Agency** for the uncompleted term of **Contractor's Contract**. In the case of a construction **Contract**, the **Agency** shall also have the right to hold the **Contractor** in partial or total default in

accordance with the default provisions of this **Contract**, and/or may seek debarment or suspension of the **Contractor**. The rights and remedies of the **Agency** hereunder shall be in addition to, and not in lieu of, any rights and remedies the **Agency** has pursuant to this **Contract** or by operation of **Law**.

ARTICLE 70. ELECTRONIC FILING/NYC DEVELOPMENT HUB

70.1 The **Contractor** shall electronically file all alteration type-2 and alteration type-3 applications via the New York City Development Hub Web site, except applications for the following types of minor alterations: enlargements, curb cuts, legalizations, fire alarms, builders pavement plans, and jobs filed on Landmark Preservation Commission calendared properties. All such filings must be professionally certified. Information about electronic filing via the New York City Development Hub is available on the **City** Department of Buildings Web site at www.nyc.gov/buildings.

ARTICLE 71. PROHIBITION OF TROPICAL HARDWOODS

71.1 Tropical hardwoods, as defined in Section 165 of the New York State Finance Law (Finance Law), shall not be utilized in the performance of this **Contract** except as expressly permitted by Section 165 of the Finance Law.

ARTICLE 72. CONFLICTS OF INTEREST

72.1 Section 2604 of the **City** Charter and other related provisions of the **City** Charter, the Administrative Code, and the Penal Law are applicable under the terms of this **Contract** in relation to conflicts of interest and shall be extended to **Subcontractors** authorized to perform **Work**, labor and services pursuant to this **Contract** and further, it shall be the duty and responsibility of the **Contractor** to so inform its respective **Subcontractors**. Notice is hereby given that, under certain circumstances, penalties may be invoked against the donor as well as the recipient of any form of valuable gift.

ARTICLE 73. MERGER CLAUSE

73.1 The written **Contract** herein, contains all the terms and conditions agreed upon by the parties hereto, and no other agreement, oral or otherwise, regarding the subject matter of this **Contract** shall be deemed to exist or to bind any of the parties hereto, or to vary any of the terms contained herein.

ARTICLE 74. STATEMENT OF WORK

74.1 The **Contractor** shall furnish all labor and materials and perform all **Work** in strict accordance with the **Specifications** and **Addenda** thereto, numbered as shown in Schedule A.

ARTICLE 75. COMPENSATION TO BE PAID TO CONTRACTOR

75.1 The **City** will pay and the **Contractor** will accept in full consideration for the performance of the **Contract**, subject to additions and deductions as provided herein, the total sum shown in Schedule A, this said sum being the amount at which the **Contract** was awarded to the **Contractor** at a public letting thereof, based upon the **Contractor's** bid for the **Contract**.

ARTICLE 76. ELECTRONIC FUNDS TRANSFER

76.1 In accordance with Section 6-107.1 of the Administrative Code, the **Contractor** agrees to accept payments under this **Contract** from the **City** by electronic funds transfer (EFT). An EFT is any transfer of funds, other than a transaction originated by check, draft or similar paper instrument, which is initiated through an electronic terminal, telephonic instrument or computer or magnetic tape so as to order, instruct or authorize a financial institution to debit or credit an account. Prior to the first payment made under this **Contract**, the **Contractor** shall designate one financial institution or other authorized payment agent and shall complete the attached "EFT Vendor Payment Enrollment Form" in order to provide the Commissioner of the **City** Department of Finance with information necessary for the **Contractor** to receive electronic funds transfer payments through a designated financial institution or authorized payment agent. The crediting of the amount of a payment to the appropriate account on the books of a financial institution or other authorized payment agent designated by the **Contractor** shall constitute full satisfaction by the **City** for the amount of the payment under this **Contract**. The account information supplied by the **Contractor** to facilitate the electronic funds transfer shall remain confidential to the fullest extent provided by **Law**.

76.2 The **Commissioner** may waive the application of the requirements of this Article 76 to payments on contracts entered into pursuant to Section 315 of the **City** Charter. In addition, the Commissioner of the Department of Finance and the Comptroller may jointly issue standards pursuant to which the **Agency** may waive the requirements of this Article 76 for payments in the following circumstances: (i) for individuals or classes of individuals for whom compliance imposes a hardship; (ii) for classifications or types of checks; or (iii) in other circumstances as may be necessary in the interest of the **City**.

ARTICLE 77. RECORDS RETENTION

77.1 The **Contractor** agrees to retain all books, records, and other documents relevant to this **Contract** for six years after the final payment or termination of this **Contract**, whichever is later. **City**, state, and federal auditors and any other persons duly authorized by the **City** shall have full access to and the right to examine any such books, records, and other documents during the retention period.

ARTICLE 78. EXAMINATION AND VIEWING OF SITE, CONSIDERATION OF OTHER SOURCES OF INFORMATION AND CHANGED SITE CONDITIONS

78.1 Pre-Bidding (Investigation) Viewing of Site – Bidders must carefully view and examine the **Site** of the proposed **Work**, as well as its adjacent area, and seek other usual sources of information, for they will be conclusively presumed to have full knowledge of any and all conditions and hazards on, about or above the **Site** relating to or affecting in any way the performance of the **Work** to be done under the **Contract** that were or should have been known by a reasonably prudent bidder. To arrange a date for visiting the **Site**,

bidders are to contact the **Agency** contact person specified in the bid documents.

78.2 Should the **Contractor** encounter during the progress of the Work site conditions or environmental hazards at the **Site** materially differing from any shown on the **Contract Drawings** or indicated in the **Specifications** or such conditions or environmental hazards as could not reasonably have been anticipated by the **Contractor**, which conditions or hazards will materially affect the cost of the **Work** to be done under the **Contract**, the attention of the **Commissioner** must be called immediately to such conditions or hazards before they are disturbed. The **Commissioner** shall thereupon promptly investigate the conditions or hazards. If the **Commissioner** finds that they do so materially differ, and that they could not have been reasonably anticipated by the **Contractor**, the **Contract** may be modified with the **Commissioner's** written approval.

ARTICLE 79. PARTICIPATION BY MINORITY-OWNED AND WOMEN-OWNED BUSINESS ENTERPRISES IN CITY PROCUREMENT

ARTICLE I. M/WBE PROGRAM

Section 6-129 of the Administrative Code of the City of New York ("Section 6-129") establishes the program for participation in City procurement ("M/WBE Program") by minority-owned business enterprises ("MBEs") and women-owned business enterprises ("WBEs"), certified in accordance with Section 1304 of the New York City Charter. As stated in Section 6-129, the intent of the program is to address the impact of discrimination on the City's procurement process, and to promote the public interest in avoiding fraud and favoritism in the procurement process, increasing competition for City business, and lowering contract costs. The contract provisions contained herein are pursuant to Section 6-129, and the rules of the Department of Small Business Services ("DSBS") promulgated thereunder.

If this Contract is subject to the M/WBE Program established by Section 6-129, the specific requirements of MBE and/or WBE participation for this Contract are set forth in Schedule B of the Contract (entitled the "M/WBE Utilization Plan") and are detailed below.

The Contractor must comply with all applicable MBE and WBE requirements for this Contract.

All provisions of Section 6-129 are hereby incorporated in the Contract by reference and all terms used herein that are not defined herein shall have the meanings given such terms in Section 6-129.

References to MBEs or WBEs shall also include such businesses certified pursuant to the executive law where credit is required by section 311 of the New York City Charter or other provision of law.

Article I, Part A, below, sets forth provisions related to the participation goals for construction, standard and professional services contracts.

Article I, Part B, below, sets forth miscellaneous provisions related to the M/WBE Program.

PART A: PARTICIPATION GOALS FOR CONSTRUCTION, STANDARD AND PROFESSIONAL SERVICES CONTRACTS OR TASK ORDERS

1. The MBE and/or WBE Participation Goals established for this Contract or Task Orders issued pursuant to this Contract, ("Participation Goals"), as applicable, are set forth on Schedule B, Part 1 to this Contract (see Page 1, Line 1 Total Participation Goals) or will be set forth on Schedule B, Part 1 to Task Orders issued pursuant to this Contract, as applicable.

The Participation Goals represent a percentage of the total dollar value of the Contract or Task Order, as applicable, that may be achieved by awarding subcontracts to firms certified with DSBS as MBEs and/or WBEs, and/or by crediting the participation of prime contractors and/or qualified joint ventures as provided in Section 3 below, unless the goals have been waived or modified by Agency in accordance with Section 6-129 and Part A, Sections 10 and 11 below, respectively.

2. If Participation Goals have been established for this Contract or Task Orders issued pursuant to this Contract, Contractor agrees or shall agree as a material term of the Contract that Contractor shall be subject to the Participation Goals, unless the goals are waived or modified by Agency in accordance with Section 6-129 and Part A, Sections 10 and 11 below, respectively.

3. If Participation Goals have been established for this Contract or Task Order issued pursuant to this Contract, a Contractor that is an MBE and/or WBE shall be permitted to count its own participation toward fulfillment of the relevant Participation Goal, provided that in accordance with Section 6-129 the value of Contractor's participation shall be determined by subtracting from the total value of the Contract or Task Order, as applicable, any amounts that the Contractor pays to direct subcontractors (as defined in Section 6-129(c)(13)), and provided further that a Contractor that is certified as both an MBE and a WBE may count its own participation either toward the goal for MBEs or the goal for WBEs, but not both.

A Contractor that is a qualified joint venture (as defined in Section 6-129(c)(30)) shall be permitted to count a percentage of its own participation toward fulfillment of the relevant Participation Goal. In accordance with Section 6-129, the value of Contractor's participation shall be determined by subtracting from the total value of the Contract or Task Order, as applicable, any amounts that Contractor pays to direct subcontractors, and then multiplying the remainder by the percentage to be applied to total profit to determine the amount to which an MBE or WBE is entitled pursuant to the joint venture agreement, provided that where a participant in a joint venture is certified as both an MBE and a WBE, such amount shall be counted either toward the goal for MBEs or the goal for WBEs, but not both.

4. A. If Participation Goals have been established for this Contract, a prospective contractor shall be required to submit with its bid or proposal, as applicable, a completed Schedule B, M/WBE Utilization Plan, Part 2 (see Pages 1-2) indicating: (a) whether the contractor is an MBE or WBE, or qualified joint venture; (b) the percentage of work it intends to award to direct subcontractors; (c) in cases where the contractor intends to award direct subcontracts, a description of the type and dollar value of work designated for participation by MBEs and/or WBEs, and the time frames in which such work is scheduled to begin and end; as well as the name, addresses, and telephone numbers of the M/WBE subcontractors if required by the solicitation; and (d) the prospective contractor's required certification and affirmations. In the event that this M/WBE Utilization Plan indicates that the bidder or proposer, as applicable, does not intend to meet the Participation Goals, the bid or proposal, as applicable, shall be deemed non-responsive, unless Agency has granted the bidder or proposer, as applicable, a pre-award waiver of the Participation Goals in accordance with Section 6-129 and Part A, Section 10 below.

B. (i) If this Contract is for a master services agreement or other requirements type contract that will result in the issuance of Task Orders that will be individually registered ("Master Services Agreement") and is subject to M/WBE Participation Goals, a prospective contractor shall be required to submit with its bid or proposal, as applicable, a completed Schedule B, M/WBE Participation Requirements for Master Services Agreements That Will Require Individually Registered Task Orders, Part 2 (page 2) indicating the prospective contractor's certification and required affirmations to make all reasonable good faith efforts to meet participation goals established on each individual Task Order issued pursuant to this Contract, or if a partial waiver is obtained or such goals are modified by the Agency, to meet the modified Participation Goals by soliciting and obtaining the participation of certified MBE and/or WBE firms. In the event that the Schedule B indicates that the bidder or proposer, as applicable, does not intend to meet the Participation Goals that may be established on Task Orders issued pursuant to this Contract, the bid or proposal, as applicable, shall be deemed non-responsive.

(ii) Participation Goals on a Master Services Agreement will be established for individual Task Orders issued after the Master Services Agreement is awarded. If Participation Goals have been established on a Task Order, a contractor shall be required to submit a Schedule B – M/WBE Utilization Plan For Independently Registered Task Orders That Are Issued Pursuant to Master Services Agreements, Part 2 (see Pages 1-2) indicating: (a) whether the contractor is an MBE or WBE, or qualified joint venture; (b) the percentage of work it intends to award to direct subcontractors; (c) in cases where the contractor intends to award direct subcontracts, a description of the type and dollar value of work designated for participation by MBEs and/or WBEs, and the time frames in which such work is scheduled to begin and end; as well as the name, addresses, and telephone numbers of the M/WBE subcontractors if required by the solicitation; and (d) the prospective contractor's required certification and affirmations. The contractor must engage in good faith efforts to meet the Participation Goals as established for the Task Order unless Agency has granted the contractor a pre-award waiver of the Participation Goals in accordance with Section 6-129 and Part A, Section 10 below.

C. THE BIDDER/PROPOSER MUST COMPLETE THE SCHEDULE B INCLUDED HEREIN (SCHEDULE B, PART 2). A SCHEDULE B SUBMITTED BY THE BIDDER/PROPOSER WHICH DOES NOT INCLUDE THE VENDOR CERTIFICATION AND REQUIRED AFFIRMATIONS WILL BE DEEMED TO BE NON-RESPONSIVE, UNLESS A FULL WAIVER OF THE PARTICIPATION GOALS IS GRANTED (SCHEDULE B, PART 3). IN THE EVENT THAT THE CITY DETERMINES THAT THE BIDDER/PROPOSER HAS SUBMITTED A SCHEDULE B WHERE THE VENDOR CERTIFICATION AND REQUIRED AFFIRMATIONS ARE COMPLETED BUT OTHER ASPECTS OF THE SCHEDULE B ARE NOT COMPLETE, OR CONTAIN A COPY OR COMPUTATION ERROR THAT IS AT ODDS WITH THE VENDOR CERTIFICATION AND AFFIRMATIONS, THE BIDDER/PROPOSER WILL BE NOTIFIED BY THE AGENCY AND WILL BE GIVEN FOUR (4) CALENDAR DAYS FROM RECEIPT OF NOTIFICATION TO CURE THE SPECIFIED DEFICIENCIES AND RETURN A COMPLETED SCHEDULE B TO THE AGENCY. FAILURE TO DO SO WILL RESULT IN A DETERMINATION THAT THE BID/PROPOSAL IS NON-RESPONSIVE. RECEIPT OF NOTIFICATION IS DEFINED AS THE DATE NOTICE IS E-MAILED OR FAXED (IF THE BIDDER/PROPOSER HAS PROVIDED AN E-MAIL ADDRESS OR FAX NUMBER), OR NO LATER THAN FIVE (5) CALENDAR DAYS FROM THE DATE OF MAILING OR UPON DELIVERY, IF DELIVERED.

5. Where an M/WBE Utilization Plan has been submitted, the Contractor shall, within 30 days of issuance by Agency of a notice to proceed, submit a list of proposed persons or entities to which it intends to award subcontracts within the subsequent 12 months. In the case of multi- year contracts, such list shall also be submitted every year thereafter. The Agency may also require the Contractor to report periodically about the contracts awarded by its direct subcontractors to indirect subcontractors (as defined in Section 6-129(c)(22)). PLEASE NOTE: If this Contract is a public works project subject to GML §101(5) (i.e., a contract valued at or below \$3M for projects in New York City) or if the Contract is subject to a project labor agreement in accordance with Labor Law §222, and the bidder is required to identify at the time of bid submission its intended subcontractors for the Wicks trades (plumbing and gas fitting; steam heating, hot water heating, ventilating and air conditioning (HVAC); and electric wiring), the Contractor must identify all those to which it intends to award construction subcontracts for any portion of the Wicks trade work at the time of bid submission, regardless of what point in the life of the contract such subcontracts will occur. In identifying intended subcontractors in the bid submission, bidders may satisfy any Participation Goals established for this Contract by proposing one or more subcontractors that are MBEs and/or WBEs for any portion of the Wicks trade work. In the event that the Contractor's selection of a subcontractor is disapproved, the Contractor shall have a reasonable time to propose alternate subcontractors.

6. MBE and WBE firms must be certified by DSBS in order for the Contractor to credit such firms' participation toward the attainment of the Participation Goals. Such certification must occur prior to the firms' commencement of work. A list of city-certified MBE and WBE firms may be obtained from the DSBS website at www.nyc.gov/buycertified, by emailing DSBS at buyer@sbs.nyc.gov, by calling (212) 513-6451, or by visiting or writing DSBS at One Liberty Plaza ., New York, New York, 10006, 11th floor. Eligible firms that have not yet

been certified may contact DSBS in order to seek certification by visiting www.nyc.gov/getcertified, emailing MWBE@sbs.nyc.gov, or calling the DSBS certification helpline at (212) 513-6311. A firm that is certified as both an MBE and a WBE may be counted either toward the goal for MBEs or the goal for WBEs, but not both. No credit shall be given for participation by a graduate MBE or graduate WBE, as defined in Section 6-129(c)(20).

7. Where an M/WBE Utilization Plan has been submitted, the Contractor shall, with each voucher for payment, and/or periodically as Agency may require, submit statements, certified under penalty of perjury, which shall include, but not be limited to, the total amount the Contractor paid to its direct subcontractors, and, where applicable pursuant to Section 6-129(j), the total amount direct subcontractors paid to indirect subcontractors; the names, addresses and contact numbers of each MBE or WBE hired as a subcontractor by the Contractor, and, where applicable, hired by any of the Contractor's direct subcontractors; and the dates and amounts paid to each MBE or WBE. The Contractor shall also submit, along with its voucher for final payment: the total amount it paid to subcontractors, and, where applicable pursuant to Section 6-129(j), the total amount its direct subcontractors paid directly to their indirect subcontractors; and a final list, certified under penalty of perjury, which shall include the name, address and contact information of each subcontractor that is an MBE or WBE, the work performed by, and the dates and amounts paid to each.

8. If payments made to, or work performed by, MBEs or WBEs are less than the amount specified in the Contractor's M/WBE Utilization Plan, Agency shall take appropriate action, in accordance with Section 6-129 and Article II below, unless the Contractor has obtained a modification of its M/WBE Utilization Plan in accordance with Section 6-129 and Part A, Section 11 below.

9. Where an M/WBE Utilization Plan has been submitted, and the Contractor requests a change order the value of which exceeds the greater of 10 percent of the Contract or Task Order, as applicable, or \$500,000, Agency shall review the scope of work for the Contract or Task Order, as applicable, and the scale and types of work involved in the change order, and determine whether the Participation Goals should be modified.

10. Pre-award waiver of the Participation Goals. (a) A bidder or proposer, or contractor with respect to a Task Order, may seek a pre-award full or partial waiver of the Participation Goals in accordance with Section 6-129, which requests that Agency change one or more Participation Goals on the grounds that the Participation Goals are unreasonable in light of the availability of certified firms to perform the services required, or by demonstrating that it has legitimate business reasons for proposing a lower level of subcontracting in its M/WBE Utilization Plan.

(b) To apply for a full or partial waiver of the Participation Goals, a bidder, proposer, or contractor, as applicable, must complete Part 3 of Schedule B and **submit such request no later than seven (7) calendar days prior to the date and time the bids, proposals, or Task Orders are due, in writing by email at MWBEModification@ddc.nyc.gov. Full or partial waiver requests that are received later than seven (7) calendar days prior to the date and time the bids, proposals, or Task Orders are due may be rejected as untimely.** Bidders, proposers, or contractors, as applicable, who have submitted timely requests will receive an Agency response by no later than two (2) calendar days prior to the due date for bids, proposals, or Task Orders; provided, however, that if that date would fall on a weekend or holiday, an Agency response will be provided by close-of-business on the business day before such weekend or holiday date.

(c) If the Agency determines that the Participation Goals are unreasonable in light of the availability of certified firms to perform the services required, it shall revise the solicitation and extend the deadline for bids and proposals, or revise the Task Order, as applicable.

(d) Agency may grant a full or partial waiver of the Participation Goals to a bidder, proposer or contractor, as applicable, who demonstrates—before submission of the bid, proposal or Task Order, as applicable—that it has legitimate business reasons for proposing the level of subcontracting in its M/WBE Utilization Plan. In making its determination, Agency shall consider factors that shall include, but not be limited

to, whether the bidder, proposer or contractor, as applicable, has the capacity and the bona fide intention to perform the Contract without any subcontracting, or to perform the Contract without awarding the amount of subcontracts represented by the Participation Goals. In making such determination, Agency may consider whether the M/WBE Utilization Plan is consistent with past subcontracting practices of the bidder, proposer or contractor, as applicable, whether the bidder, proposer or contractor, as applicable, has made efforts to form a joint venture with a certified firm, and whether the bidder, proposer, or contractor, as applicable, has made good faith efforts to identify other portions of the Contract that it intends to subcontract.

11. Modification of M/WBE Utilization Plan. (a) A Contractor may request a modification of its M/WBE Utilization Plan after award of this Contract. PLEASE NOTE: If this Contract is a public works project subject to GML §101(5) (i.e., a contract valued at or below \$3M for projects in New York City) or if the Contract is subject to a project labor agreement in accordance with Labor Law §222, and the bidder is required to identify at the time of bid submission its intended subcontractors for the Wicks trades (plumbing and gas fitting; steam heating, hot water heating, ventilating and air conditioning (HVAC); and electric wiring), the Contractor may request a Modification of its M/WBE Utilization Plan as part of its bid submission. The Agency may grant a request for Modification of a Contractor's M/WBE Utilization Plan if it determines that the Contractor has established, with appropriate documentary and other evidence, that it made reasonable, good faith efforts to meet the Participation Goals. In making such determination, Agency shall consider evidence of the following efforts, as applicable, along with any other relevant factors:

- (i) The Contractor advertised opportunities to participate in the Contract, where appropriate, in general circulation media, trade and professional association publications and small business media, and publications of minority and women's business organizations;
- (ii) The Contractor provided notice of specific opportunities to participate in the Contract, in a timely manner, to minority and women's business organizations;
- (iii) The Contractor sent written notices, by certified mail or facsimile, in a timely manner, to advise MBEs or WBEs that their interest in the Contract was solicited;
- (iv) The Contractor made efforts to identify portions of the work that could be substituted for portions originally designated for participation by MBEs and/or WBEs in the M/WBE Utilization Plan, and for which the Contractor claims an inability to retain MBEs or WBEs;
- (v) The Contractor held meetings with MBEs and/or WBEs prior to the date their bids or proposals were due, for the purpose of explaining in detail the scope and requirements of the work for which their bids or proposals were solicited;
- (vi) The Contractor made efforts to negotiate with MBEs and/or WBEs as relevant to perform specific subcontracts, or act as suppliers or service providers;
- (vii) Timely written requests for assistance made by the Contractor to Agency's M/WBE liaison officer and to DSBS;
- (viii) Description of how recommendations made by DSBS and Agency were acted upon and an explanation of why action upon such recommendations did not lead to the desired level of participation of MBEs and/or WBEs.

Agency's M/WBE officer shall provide written notice to the Contractor of the determination.

(b) The Agency may modify the Participation Goals when the scope of the work has been changed by the Agency in a manner that affects the scale and types of work that the Contractor indicated in its M/WBE Utilization Plan would be awarded to subcontractors.

12. If the Contractor was required to identify in its bid or proposal the MBEs and/or WBEs they intended to use in connection with the performance of the Contract or Task Order, substitutions to the identified firms may only be made with the approval of the Agency, which shall only be given when the Contractor has proposed to use a firm that would satisfy the Participation Goals to the same extent as the firm previously identified, unless the Agency determines that the Contractor has established, with appropriate documentary and other evidence, that it made reasonable, good faith efforts. In making such determination, the Agency shall require evidence of the

efforts listed in Section 11(a) above, as applicable, along with any other relevant factors.

13. If this Contract is for an indefinite quantity of construction, standard or professional services or is a requirements type contract and the Contractor has submitted an M/WBE Utilization Plan and has committed to subcontract work to MBEs and/or WBEs in order to meet the Participation Goals, the Contractor will not be deemed in violation of the M/WBE Program requirements for this Contract with regard to any work which was intended to be subcontracted to an MBE and/or WBE to the extent that the Agency has determined that such work is not needed.

14. If Participation Goals have been established for this Contract or a Task Order issued pursuant to this Contract, at least once annually during the term of the Contract or Task Order, as applicable, Agency shall review the Contractor's progress toward attainment of its M/WBE Utilization Plan, including but not limited to, by reviewing the percentage of work the Contractor has actually awarded to MBE and/or WBE subcontractors and the payments the Contractor made to such subcontractors.

15. If Participation Goals have been established for this Contract or a Task Order issued pursuant to this Contract, Agency shall evaluate and assess the Contractor's performance in meeting those goals, and such evaluation and assessment shall become part of the Contractor's overall contract performance evaluation.

PART B: MISCELLANEOUS

The Contractor shall take notice that, if this solicitation requires the establishment of a M/WBE Utilization Plan, the resulting contract may be audited by DSBS to determine compliance with Section 6-129. See §6-129(e)(10). Furthermore, such resulting contract may also be examined by the City's Comptroller to assess compliance with the M/WBE Utilization Plan.

1. Pursuant to DSBS rules, construction contracts that include a requirement for a M/WBE Utilization Plan shall not be subject to the law governing Locally Based Enterprises set forth in Section 6-108.1 of the Administrative Code of the City of New York.

2. DSBS is available to assist contractors and potential contractors in determining the availability of MBEs and/or WBEs to participate as subcontractors, and in identifying opportunities that are appropriate for participation by MBEs and/or WBEs in contracts.

3. Prospective contractors are encouraged to enter into qualified joint venture agreements with MBEs and/or WBEs as defined by Section 6-129(c)(30).

4. By submitting a bid or proposal the Contractor hereby acknowledges its understanding of the M/WBE Program requirements set forth herein and the pertinent provisions of Section 6-129, and any rules promulgated thereunder, and if awarded this Contract, the Contractor hereby agrees to comply with the M/WBE Program requirements of this Contract and pertinent provisions of Section 6-129, and any rules promulgated thereunder, all of which shall be deemed to be material terms of this Contract. The Contractor hereby agrees to make all reasonable, good faith efforts to solicit and obtain the participation of MBEs and/or WBEs to meet the required Participation Goals.

ARTICLE II. ENFORCEMENT

1. If Agency determines that a bidder or proposer, as applicable, has, in relation to this procurement, violated Section 6-129 or the DSBS rules promulgated pursuant to Section 6-129, Agency may disqualify such bidder or proposer, as applicable, from competing for this Contract and the Agency may revoke such bidder's or proposer's prequalification status, if applicable.

2. Whenever Agency believes that the Contractor or a subcontractor is not in compliance with Section 6-129

or the DSBS rules promulgated pursuant to Section 6-129, or any provision of this Contract that implements Section 6-129, including, but not limited to any M/WBE Utilization Plan, Agency shall send a written notice to the Contractor describing the alleged noncompliance and offering the Contractor an opportunity to be heard. Agency shall then conduct an investigation to determine whether such Contractor or subcontractor is in compliance.

3. In the event that the Contractor has been found to have violated Section 6-129, the DSBS rules promulgated pursuant to Section 6-129, or any provision of this Contract that implements Section 6-129, including, but not limited to, any M/WBE Utilization Plan, Agency may determine that one of the following actions should be taken:

- (a) entering into an agreement with the Contractor allowing the Contractor to cure the violation;
- (b) revoking the Contractor's pre-qualification to bid or make proposals for future contracts;
- (c) making a finding that the Contractor is in default of the Contract;
- (d) terminating the Contract;
- (e) declaring the Contractor to be in breach of Contract;
- (f) withholding payment or reimbursement;
- (g) determining not to renew the Contract;
- (h) assessing actual and consequential damages;
- (i) assessing liquidated damages or reducing fees, provided that liquidated damages may be based on amounts representing costs of delays in carrying out the purposes of the M/WBE Program, or in meeting the purposes of the Contract, the costs of meeting utilization goals through additional procurements, the administrative costs of investigation and enforcement, or other factors set forth in the Contract;
- (j) exercising rights under the Contract to procure goods, services or construction from another contractor and charge the cost of such contract to the Contractor that has been found to be in noncompliance; or
- (k) taking any other appropriate remedy.

4. If an M/WBE Utilization Plan has been submitted, and pursuant to this Article II, Section 3, the Contractor has been found to have failed to fulfill its Participation Goals contained in its M/WBE Utilization Plan or the Participation Goals as modified by Agency pursuant to Article I, Part A, Section 11, Agency may assess liquidated damages in the amount of ten percent (10%) of the difference between the dollar amount of work required to be awarded to MBE and/or WBE firms to meet the Participation Goals and the dollar amount the Contractor actually awarded and paid, and/or credited, to MBE and/or WBE firms. In view of the difficulty of accurately ascertaining the loss which the City will suffer by reason of Contractor's failure to meet the Participation Goals, the foregoing amount is hereby fixed and agreed as the liquidated damages that the City will suffer by reason of such failure, and not as a penalty. Agency may deduct and retain out of any monies which may become due under this Contract the amount of any such liquidated damages; and in case the amount which may become due under this Contract shall be less than the amount of liquidated damages suffered by the City, the Contractor shall be liable to pay the difference.

5. Whenever Agency has reason to believe that an MBE and/or WBE is not qualified for certification, or is participating in a contract in a manner that does not serve a commercially useful function (as defined in Section 6-129(c)(8)), or has violated any provision of Section 6-129, Agency shall notify the Commissioner of DSBS who shall determine whether the certification of such business enterprise should be revoked.

6. Statements made in any instrument submitted to Agency pursuant to Section 6-129 shall be submitted under penalty of perjury and any false or misleading statement or omission shall be grounds for the application of any applicable criminal and/or civil penalties for perjury. The making of a false or fraudulent statement by an MBE and/or WBE in any instrument submitted pursuant to Section 6-129 shall, in addition, be grounds for revocation of its certification.

7. The Contractor's record in implementing its M/WBE Utilization Plan shall be a factor in the evaluation of

its performance. Whenever Agency determines that a Contractor's compliance with an M/WBE Utilization Plan has been unsatisfactory, Agency shall, after consultation with the City Chief Procurement Officer, file an advice of caution form for inclusion in PASSPort as caution data.

CONTRACT SIGNATURE PAGE

This Contract is entered by and between the City of New York (“City”), acting by and through the **DEPARTMENT OF DESIGN AND CONSTRUCTION**, and **RE-EARTH OF STROUDSBURG INC** (“Contractor”).

This Contract consists of this contract signature page as well as the following documents (“Contract Documents”) which are located in the Documents tab of the PASSPort record titled **85024B0021-HWS2023R** -.

1. (Question answer) - HWS2023R - Executed Bid Bond 1.16.24.pdf - May 15 2024 2:14PM
2. BID SCHEDULE - Apr 26 2024 5:21PM
3. BROKER'S CERTIFICATION - May 15 2024 1:10PM
4. DISABILITY INSURANCE - May 15 2024 1:10PM
5. HWS2023R Addendum1 - Apr 26 2024 3:54PM
6. HWS2023R Bid Schedule - May 15 2024 2:08PM
7. HWS2023R V1_Infra_Bid_Booklet - Apr 26 2024 3:54PM
8. HWS2023R VOL2 OF 3 (Addendum1) - Apr 26 2024 3:54PM
9. HWS2023R VOL3 OF 3 - Apr 26 2024 3:54PM
10. INSURANCE CERTIFICATE - May 15 2024 1:08PM
11. Proposal/Bid - May 15 2024 2:09PM
12. SECURITY/BOND - May 15 2024 1:09PM
13. WORKER'S COMPENSATION - May 15 2024 1:08PM

The above order does not represent an order of precedence. The Contract shall be governed by the order of precedence, if any, in the Contract Documents or by ordinary contract principles if no such order of precedence exists.

Each party is signing this Contract electronically on the date stated in that party's electronic signature.

The City of New York

By: **DEPARTMENT OF DESIGN AND CONSTRUCTION**

ERIC MACFARLANE

(Signature)

ERIC MACFARLANE

Name: _____

Title: First Deputy Commissioner

Date: 5/20/2024 | 07:24:01 PDT

Contractor

By: **RE-EARTH OF STROUDSBURG INC**

DocuSigned by:

Mahyla Espinoza

5B27995A3E4B464...

(Signature)

Name: Mahyla Espinoza

Title: President

Date: 5/20/2024 | 07:02:27 PDT

PERFORMANCE BOND #1

Performance Bond #1 (4 Pages): Use if the total contract price is \$5 Million Or Less. Performance Bond #1 has been approved by the U.S. Small Business Administration ("SBA")for participation in its Bond Guarantee Program.

PERFORMANCE BOND #1 (Page 1)

KNOW ALL PERSONS BY THESE PRESENTS,;

That we, Re Earth of Stroudsburg, Inc.

2 Katz Drive

Stroudsburg, PA 18360

hereinafter referred to as the "Principal,"
and, Arch Insurance Company

67 Main Street

Cortland, NY 13045

hereinafter referred to as the "Surety" ("Sureties") are held and firmly bound to THE CITY OF NEW YORK, hereinafter referred to as the "City" or to its successors and assigns in the penal sum of Two Million Six Hundred Ninety-Five Thousand One Hundred Ninety-One 30/100 Dollars

(\$ 2,695,191.30) Dollars, lawful money of the United States for the payment of which said sum of money well and truly to be made, we, and each of us, bind ourselves, our heirs, executors, administrators, successors and assigns, jointly and severally, firmly by these presents.

WHEREAS, the Principal is about to enter, or has entered, into a Contract in writing with the City for

Installation of Sidewalks, Curbs, & Ped Ramps in Staten Island

Contract #HWS2023R

a copy of which Contract is annexed to and hereby made a part of this bond as though herein set forth in full; **NOW, THEREFORE,** the conditions of this obligation are such that if the Principal, his or its representatives or assigns, shall well and faithfully perform the said Contract and all modifications, amendments, additions and alterations thereto that may hereafter be made, according to its terms and its true intent and meaning, including repair and or replacement of defective work and guarantees of maintenance for the periods stated in the Contract, and shall fully indemnify and save harmless the City from all cost and damage which it may suffer by reason of the Principal's default of the Contract, and shall fully reimburse and repay the City for all outlay and expense which the City may incur in making good any such default and shall protect the said City of New York against, and pay any and all amounts, damages, cost and judgments which may or shall be recovered against said City or its officers or agents or which the said City of New York may be called upon to pay any person or corporation by reason of any damages arising or growing out of the Principal's default of the Contract, then this obligation shall be null and void, otherwise to remain in full force and effect.

PERFORMANCE BOND #1 (Page 2)

The Surety (Sureties), for value received, hereby stipulates and agrees, upon written notice from the City that the City has determined that the Principal is in default of the Contract, to (1) pay the City the cost to complete the contract as determined by the City in excess of the balance of the Contract held by the City, plus any damages or costs to which the City is entitled, up to the full amount of the above penal sum, (2) fully perform and complete the Work to be performed under the Contract, pursuant to the terms, conditions, and covenants thereof, or (3) tender a completion Contractor that is acceptable to the City. The Surety (Sureties) further agrees, at its option, either to notify the City that it elects to pay the city the cost of completion plus any applicable damages and costs under option (1) above, or to commence and diligently perform the Work specified in the Contract, including physical site work, within twenty-five (25) business days after written notice thereof from the City and, if the Surety elects to fully perform and complete the Work, then to complete all Work within the time set forth in the Contract or such other time as agreed to between the City and Surety in accordance with the Contract. If the Surety elects to tender payment pursuant to (1) above, then the Surety shall tender such amount within fifteen (15) business days notification from the City of the cost of completion. The Surety and the City reserve all rights and defenses each may have against the other; provided, however, that the Surety expressly agrees that its reservation of rights shall not provide a basis for non-performance of its obligation to pay the City the cost of completion, to commence and complete all Work as provided herein, or to tender a completion contractor.

The Surety (Sureties), for value received, for itself and its successors and assigns, hereby stipulates and agrees that the obligation of said Surety (Sureties) and its bond shall be in no way impaired or affected by any extension of time, modification, omission, addition, or change in or to the said Contract or the Work to be performed thereunder, or by any payment thereunder before the time required therein, or by any waiver of any provisions thereof, or any moneys due or to become due thereunder; and said Surety (Sureties) does hereby waive notice of any and all of such extensions, modifications, omissions, additions, changes, payments, and waivers, and hereby expressly stipulates and agrees that any and all things done and omitted to be done by and in relation to subcontractors shall have the same effect as to said Surety (Sureties) as though done or omitted to be done by or in relation to said Principal. Notwithstanding the above, if the City makes payments to the Principal before the time required by the contract that in the aggregate exceed \$100,000 or 10% of the Contract price, whichever is less, and that have not become earned prior to the Principal being found to be in default, then all payments made to the Principal before the time required by the Contract shall be added to the remaining contract value available to be paid for the completion of the Contract as if such sums had not been paid to the Principal, but shall not provide a basis for non-performance of its obligation to pay the City the cost of completion, to commence and to complete all Work as provided herein, or to tender a completion contractor.

PERFORMANCE BOND #1 (Page 3)

IN WITNESS WHEREOF, The Principal and the Surety (Sureties) have hereunto set their hands and seals, and such of them as are corporations have caused their corporate seals to be hereunto affixed and these presents to be signed by their proper officers, this

1 day of May, 2024 (Seal)

Mahyla Capinoza (L.S.)
Re Earth of Stroudsburg, Inc. Principal

(Seal)

By: Arch Insurance Company

Surety

By: [Signature]
Scott Adams Attorney-In-Fact
Surety

(Seal)

By: _____
Surety

(Seal)

By: _____
Surety

(Seal)

By: _____
Surety

(Seal)

By: _____

Bond Premium Rate 2.5%

Bond Premium Cost \$67,379.78

If the Contractor (Principal) is a partnership, the bond should be signed by each of the individuals who are partners.

If the Contractor (Principal) is a corporation, the bond should be signed in its correct corporate name by duly authorized officer, agent, or attorney-in-fact.

There should be executed an appropriate number of counterparts of the bond corresponding to the number of counterparts of the Contract.

ACKNOWLEDGMENT OF PRINCIPAL IF A CORPORATION

State of New Jersey County of Morris ss:

On this 1st day of May, 2024 before me personally came MAHYLA ESPINOZA to me known, who, being by me duly sworn did depose and say that he/she resides at 7 Mannion Drive Old Westbury, NY 11568; that he/she is the PRESIDENT of the corporation described in and which executed the foregoing instrument; and that he/she signed his/her name to the foregoing instrument by order of the directors of said corporation as the duly authorized and binding act thereof.

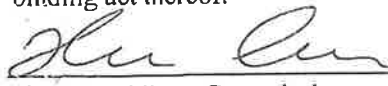
Notary Public or Commissioner of Deeds.

VIVIANE LOPRETE Notary Public, State of New Jersey My Commission Expires 09/09/2026

ACKNOWLEDGMENT OF PRINCIPAL IF A PARTNERSHIP

State of _____ County of _____ ss:

On this _____ day of _____, 20____ before me personally came _____ to me known, who, being by me duly sworn did dispose and say that he/she resides at _____; that he/she is _____ partner of _____, a limited/general partnership existing under the laws of the State of _____, the partnership described in and which executed the foregoing instrument; and that he/she signed his/her name to the foregoing instrument as the duly authorized and binding act of said partnership.

Notary Public or Commissioner of Deeds.

ACKNOWLEDGMENT OF PRINCIPAL IF AN INDIVIDUAL

State of _____ County of _____ ss:

On this _____ day of _____, 20____ before me personally came _____ to me known, who, being by me duly sworn did depose and say that he/she resides at _____, and that he/she is the individual whose name is subscribed to the within instrument and acknowledged to me that by his/her signature on the instrument, said individual executed the instrument.

Notary Public or Commissioner of Deeds

Each executed bond should be accompanied by: (a) appropriate acknowledgments of the respective parties; (b) appropriate duly certified copy of Power of Attorney or other certificate of authority where bond is executed by agent, officer or other representative of Principal or Surety; (c) a duly certified extract from By-Laws or resolutions of Surety under which Power of Attorney or other certificate of authority of its agent, officer or representative was issued, and (d) certified copy of latest published financial statement of assets and liabilities of Surety.

Affix Acknowledgments and Justification of Sureties.

This Power of Attorney limits the acts of those named herein, and they have no authority to bind the Company except in the manner and to the extent herein stated. Not valid for Note, Loan, Letter of Credit, Currency Rate, Interest Rate or Residential Value Guarantees.

POWER OF ATTORNEY

Know All Persons By These Presents:

That the Arch Insurance Company, a corporation organized and existing under the laws of the State of Missouri, having its principal administrative office in Jersey City, New Jersey (hereinafter referred to as the "Company") does hereby appoint:

Scott Adams of Cortland, NY

its true and lawful Attorney(s)in-Fact, to make, execute, seal, and deliver from the date of issuance of this power for and on its behalf as surety, and as its act and deed: Any and all bonds, undertakings, recognizances and other surety obligations, in the penal sum not exceeding One Hundred Fifty Million Dollars (\$150,000,000.00). This authority does not permit the same obligation to be split into two or more bonds in order to bring each such bond within the dollar limit of authority as set forth herein.

The execution of such bonds, undertakings, recognizances and other surety obligations in pursuance of these presents shall be as binding upon the said Company as fully and amply to all intents and purposes, as if the same had been duly executed and acknowledged by its regularly elected officers at its principal administrative office in Jersey City, New Jersey.

This Power of Attorney is executed by authority of resolutions adopted by unanimous consent of the Board of Directors of the Company on August 31, 2022, true and accurate copies of which are hereinafter set forth and are hereby certified to by the undersigned Secretary as being in full force and effect:

"VOTED, That the Chairman of the Board, the President, or the Executive Vice President, or any Senior Vice President, of the Surety Business Division, or their appointees designated in writing and filed with the Secretary, or the Secretary shall have the power and authority to appoint agents and attorneys-in-fact, and to authorize them subject to the limitations set forth in their respective powers of attorney, to execute on behalf of the Company, and attach the seal of the Company thereto, bonds, undertakings, recognizances and other surety obligations obligatory in the nature thereof, and any such officers of the Company may appoint agents for acceptance of process."

This Power of Attorney is signed, sealed and certified by facsimile under and by authority of the following resolution adopted by the unanimous consent of the Board of Directors of the Company on August 31, 2022:

VOTED, That the signature of the Chairman of the Board, the President, or the Executive Vice President, or any Senior Vice President, of the Surety Business Division, or their appointees designated in writing and filed with the Secretary, and the signature of the Secretary, the seal of the Company, and certifications by the Secretary, may be affixed by facsimile on any power of attorney or bond executed pursuant to the resolution adopted by the Board of Directors on August 31, 2022, and any such power so executed, sealed and certified with respect to any bond or undertaking to which it is attached, shall continue to be valid and binding upon the Company. In Testimony Whereof, the Company has caused this instrument to be signed and its corporate seal to be affixed by their authorized officers, this 30th day of January, 2023.

Attested and Certified

Regan A. Shulman, Secretary



Stephen C. Ruschak, Executive Vice President

STATE OF PENNSYLVANIA SS
COUNTY OF PHILADELPHIA SS

I, Michele Tripodi, a Notary Public, do hereby certify that Regan A. Shulman and Stephen C. Ruschak personally known to me to be the same persons whose names are respectively as Secretary and Executive Vice President of the Arch Insurance Company, a Corporation organized and existing under the laws of the State of Missouri, subscribed to the foregoing instrument, appeared before me this day in person and severally acknowledged that they being thereunto duly authorized signed, sealed with the corporate seal and delivered the said instrument as the free and voluntary act of said corporation and as their own free and voluntary acts for the uses and purposes therein set forth.

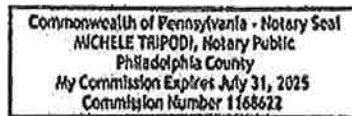

Michele Tripodi, Notary Public
My commission expires 07/31/2025

CERTIFICATION

I, Regan A. Shulman, Secretary of the Arch Insurance Company, do hereby certify that the attached Power of Attorney dated January 30, 2023 on behalf of the person(s) as listed above is a true and correct copy and that the same has been in full force and effect since the date thereof and is in full force and effect on the date of this certificate; and I do further certify that the said Stephen C. Ruschak, who executed the Power of Attorney as Executive Vice President, was on the date of execution of the attached Power of Attorney the duly elected Executive Vice President of the Arch Insurance Company.

IN TESTIMONY WHEREOF, I have hereunto subscribed my name and affixed the corporate seal of the Arch Insurance Company on this 1 day of May, 2024.

Regan A. Shulman, Secretary

This Power of Attorney limits the acts of those named therein to the bonds and undertakings specifically named therein and they have no authority to bind the Company except in the manner and to the extent herein stated.

PLEASE SEND ALL CLAIM INQUIRIES RELATING TO THIS BOND TO THE FOLLOWING ADDRESS:

Arch Insurance - Surety Division
3 Parkway, Suite 1500
Philadelphia, PA 19102



To verify the authenticity of this Power of Attorney, please contact Arch Insurance Company at SuretyAuthentic@archinsurance.com
Please refer to the above named Attorney-In-Fact and the details of the bond to which the power is attached.

STATE OF New Jersey

COUNTY OF Morris

On this 1st day of May, 2024 before me, a Notary Public within and for said County and State, personally appeared Scott Adams to me personally known, who being duly sworn, upon oath, did say that he is the authorized signatory for the Arch Insurance Company, a corporation created, organized and existing under and by the virtue of the laws of the State of Missouri that the Corporate seal affixed to the foregoing instrument is the seal of said Corporation; that the seal was affixed; and the said Scott Adams did acknowledge that he executed the said instrument as the free and deed of said Corporation.



Notary Public

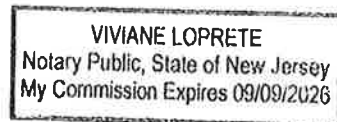

ARCH INSURANCE COMPANY
STATEMENT OF FINANCIAL CONDITION
DECEMBER 31, 2023

Assets

Cash & Cash Equivalents in Banks	\$328,130,777
Bonds owned	6,481,021,338
Stocks	813,423,103
Premiums in course of collection	945,968,974
Accrued interest and other assets	<u>1,398,321,681</u>
 Total Assets	 <u>\$ 9,966,865,873</u>

Liabilities

Reserve for losses and adjustment expenses	\$3,580,722,897
Reserve for unearned premiums	1,770,436,315
Ceded reinsurance premiums payable	1,021,006,333
Amounts withheld or retained by company for account of others	165,467,758
Reserve for taxes, expenses and other liabilities	<u>986,839,682</u>
 Total Liabilities	 <u>\$7,524,472,985</u>
 Surplus as regards policyholders	 <u>2,442,392,888</u>
 Total Surplus and Liabilities	 <u>\$9,966,865,873</u>

By:



Executive Vice President, Chief
Financial Officer and Treasurer

Attest:

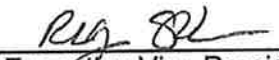

Executive Vice President,
General Counsel and Secretary

State of New Jersey)

) SS

County of Hudson)

Thomas James Ahern, Executive Vice President, Chief Financial Officer and Treasurer and
Regan Shulman, Executive Vice President, General Counsel and Secretary being duly sworn,
of ARCH INSURANCE COMPANY, Missouri; and that the foregoing is a true and correct
statement of financial condition of said company, as of December 31, 2023.

Subscribed and sworn to before me, this 7 day of March 2024

Notary Public

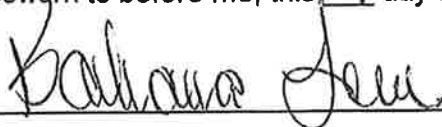

BARBARA A. LEE
Commission # 50107758
Notary Public, State of New Jersey
My Commission Expires
June 27, 2024

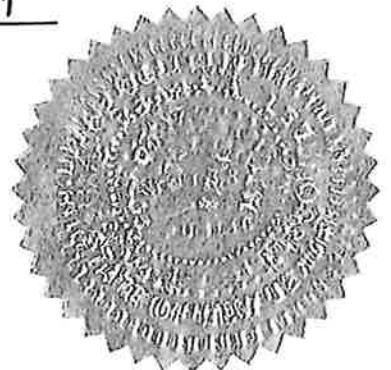

State of New York

DEPARTMENT OF FINANCIAL SERVICES

WHEREAS IT APPEARS THAT

Arch Insurance Company

Home Office Address Kansas City, Missouri

Organized under the Laws of Missouri

has complied with the necessary requirements of or pursuant to law, it is hereby

licensed to do within this State the business of

accident and health, fire, miscellaneous property, water damage, burglary and theft, glass, boiler and machinery, animal, collision, personal injury liability, property damage liability, workers' compensation and employers' liability, fidelity and surety, credit, motor vehicle and aircraft physical damage, marine and inland marine, marine protection and indemnity, credit unemployment, gap, service contract reimbursement and legal services insurance, as specified in paragraph(s) 3, 4, 5, 6, 7, 8, 9, 11, 12, 13, 14, 15, 16, 17, 19, 20, 21, 24, 26(A)(B)(C)(D), 28 and 29 of Section 1113(a) of the New York Insurance Law and also such workers' compensation insurance as may be incident to coverages contemplated under paragraphs 20 and 21 of Section 1113(a), including insurances described in the Longshoremen's and Harbor Workers' Compensation Act (Public Law No. 803, 69 Cong. as amended; 33 USC Section 901 et seq. as amended) to the extent permitted by certified copy of its charter document on file in this Department until July 1, 2024.



**In Witness Whereof, I have hereunto set
my hand and affixed the official seal of this
Department at the City of Albany, New York, this
1st day of July, 2023**

Adrienne A. Harris
Superintendent

By

Rawle Lewis
Special Deputy Superintendent

PAYMENT BOND

Use for any contract for which a Payment Bond is required.

PAYMENT BOND (Page 1)

PAYMENT BOND

KNOW ALL PERSONS BY THESE PRESENTS, That we, _____

Re Earth of Stroudsburg, Inc. _____

2 Katz Drive _____

Stroudsburg, PA 18360 _____

hereinafter referred to as the "Principal", and Arch Insurance Company _____

67 Main Street _____

Cortland, NY 13045 _____

hereinafter referred to as the "Surety" ("Sureties") are held and firmly bound to THE CITY OF NEW YORK, hereinafter referred to as the "City" or to its successors and assigns, in the penal sum of

Two Million Six Hundred Ninety-Five Thousand One Hundred Ninety-One 30/100 Dollars _____

(\$ 2,695,191.30) Dollars, lawful money of the United States, for the payment of which said sum of money well and truly to be made, we, and each of us, bind ourselves, our heirs, executors, administrators, successors and assigns, jointly and severally, firmly by these presents.

WHEREAS, the Principal is about to enter, or has entered, into a Contract in writing with the City for

Installation of Sidewalks, Curbs, & Ped Ramps in Staten Island _____

Contract #HWS2023R _____

a copy of which Contract is annexed to and hereby made a part of this bond as though herein set forth in full;

NOW, THEREFORE, the conditions of this obligation are such that if the Principal, his or its representatives or assigns and other Subcontractors to whom Work under this Contract is sublet and his or their successors and assigns shall promptly pay or cause to be paid all lawful claims for

(a) Wages and compensation for labor performed and services rendered by all persons engaged in the prosecution of the Work under said Contract, and any amendment or extension thereof or addition thereto, whether such persons be agents servants or employees of the Principal or any such Subcontractor, including all persons so engaged who perform the work of laborers or mechanics at or in the vicinity of the site of the Project regardless of any contractual relationship between the Principal or such Subcontractors, or his or their successors or assigns, on the one hand and such laborers or mechanics on the other, but not including office employees not regularly stationed at the site of the project; and

PAYMENT BOND (Page 2)

(b) Materials and supplies (whether incorporated in the permanent structure or not), as well as teams, fuels, oils, implements or machinery furnished, used or consumed by said Principal or any subcontractor at or in the vicinity of the site of the Project in the prosecution of the Work under said Contract and any amendment or extension thereof or addition thereto; then this obligation shall be void, otherwise to remain in full force and effect.

This bond is subject to the following additional conditions, limitations and agreements:

(a) The Principal and Surety (Sureties) agree that this bond shall be for the benefit of any materialmen or laborer having a just claim, as well as the City itself.

(b) All persons who have performed labor, rendered services or furnished materials and supplies, as aforesaid, shall have a direct right of action against the Principal and his, its or their successors and assigns, and the Surety (Sureties) herein, or against either or both or any of them and their successors and assigns. Such persons may sue in their own name, and may prosecute the suit to judgment and execution without the necessity of joining with any other persons as party plaintiff.

(c) The Principal and Surety (Sureties) agree that neither of them will hold the City liable for any judgment for costs of otherwise, obtained by either or both of them against a laborer or materialman in a suit brought by either a laborer or materialman under this bond for moneys allegedly due for performing work or furnishing material.

(d) The Surety (Sureties) or its successors and assigns shall not be liable for any compensation recoverable by an employee or laborer under the Workmen's Compensation Law.

(e) In no event shall the Surety (Sureties), or its successors or assigns, be liable for a greater sum than the penalty of this bond or be subject to any suit, action or proceeding hereon that is instituted by any person, firm, or corporation hereunder later than two years after the complete performance of said Contract and final settlement thereof.

The Principal, for himself and his successors and assigns, and the Surety (Sureties), for itself and its successors and assigns, do hereby expressly waive any objection that might be interposed as to the right of the City to require a bond containing the foregoing provisions, and they do hereby further expressly waive any defense which they or either of them might interpose to an action brought hereon by any person, firm or corporation, including subcontractors, materialmen and third persons, for work, labor, services, supplies or material performed rendered, or furnished as aforesaid upon the ground that there is no law authorizing the City to require the foregoing provisions to be placed in this bond.

And the Surety (Sureties), for value received, for itself and its successors and assigns, hereby stipulates and agrees that the obligation of said Surety (Sureties), and its bonds shall be in no way impaired or affected by any extension of time, modification, omission, addition, or change in or of the said Contract or the work to be performed thereunder, or by any payment thereunder before the time required therein, or by any waiver of any provisions thereof, or by any assignment, subletting or other transfer thereof or of any part thereof, or of any Work to be performed, or any moneys due to become due thereunder and said Surety (Sureties) does hereby waive notice of any and all of such extensions, modifications, omissions, additions, changes, payments, waivers, assignments, subcontracts and transfers, and hereby expressly stipulates and agrees that any and all things done and omitted to be done by and in relation to assignees, Subcontractors, and other transferees shall have the same effect as to said Surety (Sureties) as though done or omitted to be done or in relation to said Principal.

PAYMENT BOND (Page 3)

IN WITNESS WHEREOF, the Principal and the Surety (Sureties) have hereunto set their hands and seals, and such of them as are corporations have caused their corporate seals to be hereunto affixed and these presents to be signed by their proper officers, this 1 day of May, 2024.

(Seal)

Mahyla Espinoza (L.S.) Principal

Re Earth of Stroudsburg, Inc. By: _____

(Seal)

[Signature] Surety
Arch Insurance Company By: Scott Adams Attorney-In-Fact

(Seal)

By: _____

(Seal)

By: _____

(Seal)

By: _____

If the Contractor (Principal) is a partnership, the bond should be signed by each of the individuals who are partners.

If the Contractor (Principal) is a corporation, the bond should be signed in its correct corporate name by duly authorized officer, agent, or attorney-in-fact.

There should be executed an appropriate number of counterparts of the bond corresponding to the number of counterparts of the Contract.

ACKNOWLEDGMENT OF PRINCIPAL, IF A CORPORATION

State of New Jersey County of Morris ss:

On this 1st day of May, 2024, before me personally came MAHYLA ESPINOZA to me known, who, being by me duly sworn did depose and say that he resides at 1 Mansion Drive Old Westbury, NY 11568 that he is the PRESIDENT of the corporation described in and which executed the foregoing instrument; that he knows the seal of said corporation; that one of the seals affixed to said instrument is such seal; that it was so affixed by order of the directors of said corporation, and that he signed his name thereto by like order.

Notary Public or Commissioner of Deeds

VIVIANE LOPRETE Notary Public, State of New Jersey My Commission Expires 09/09/2026 of Deeds

ACKNOWLEDGMENT OF PRINCIPAL, IF A PARTNERSHIP

State of _____ County of _____ ss:

On this _____ day of _____, _____, before me personally appeared _____ to me known, and known to me to be one of the members of the firm of _____ described in and who executed the foregoing instrument; and he acknowledged to me that he executed the same as and for the act and deed of said firm.

Notary Public or Commissioner of Deeds

ACKNOWLEDGMENT OF PRINCIPAL, IF AN INDIVIDUAL

State of _____ County of _____ ss:

On this _____ day of _____, _____, before me personally appeared _____ to me known, and known to me to be the person described in and who executed the foregoing instrument; and acknowledged that he executed the same.

Notary Public or Commissioner of Deeds

Each executed bond should be accompanied by: (a) appropriate acknowledgments of the respective parties; (b) appropriate duly certified copy of Power of Attorney or other certificate of authority where bond is executed by agent, officer or other representative of Principal or Surety; (c) a duly certified extract from By-Laws or resolutions of Surety under which Power of Attorney or other certificate of authority of its agent, officer or representative was issued, and (d) certified copy of latest published financial statement of assets and liabilities of Surety.

Affix Acknowledgments and Justification of Sureties.

This Power of Attorney limits the acts of those named herein, and they have no authority to bind the Company except in the manner and to the extent herein stated. Not valid for Note, Loan, Letter of Credit, Currency Rate, Interest Rate or Residential Value Guarantees.

POWER OF ATTORNEY

Know All Persons By These Presents:

That the Arch Insurance Company, a corporation organized and existing under the laws of the State of Missouri, having its principal administrative office in Jersey City, New Jersey (hereinafter referred to as the "Company") does hereby appoint:

Scott Adams of Cortland, NY

its true and lawful Attorney(s)-in-Fact, to make, execute, seal, and deliver from the date of issuance of this power for and on its behalf as surety, and as its act and deed: Any and all bonds, undertakings, recognizances and other surety obligations, in the penal sum not exceeding One Hundred Fifty Million Dollars (\$150,000,000.00). This authority does not permit the same obligation to be split into two or more bonds in order to bring each such bond within the dollar limit of authority as set forth herein.

The execution of such bonds, undertakings, recognizances and other surety obligations in pursuance of these presents shall be as binding upon the said Company as fully and amply to all intents and purposes, as if the same had been duly executed and acknowledged by its regularly elected officers at its principal administrative office in Jersey City, New Jersey.

This Power of Attorney is executed by authority of resolutions adopted by unanimous consent of the Board of Directors of the Company on August 31, 2022, true and accurate copies of which are hereinafter set forth and are hereby certified to by the undersigned Secretary as being in full force and effect:

"VOTED, That the Chairman of the Board, the President, or the Executive Vice President, or any Senior Vice President, of the Surety Business Division, or their appointees designated in writing and filed with the Secretary, or the Secretary shall have the power and authority to appoint agents and attorneys-in-fact, and to authorize them subject to the limitations set forth in their respective powers of attorney, to execute on behalf of the Company, and attach the seal of the Company thereto, bonds, undertakings, recognizances and other surety obligations obligatory in the nature thereof, and any such officers of the Company may appoint agents for acceptance of process."

This Power of Attorney is signed, sealed and certified by facsimile under and by authority of the following resolution adopted by the unanimous consent of the Board of Directors of the Company on August 31, 2022:

VOTED, That the signature of the Chairman of the Board, the President, or the Executive Vice President, or any Senior Vice President, of the Surety Business Division, or their appointees designated in writing and filed with the Secretary, and the signature of the Secretary, the seal of the Company, and certifications by the Secretary, may be affixed by facsimile on any power of attorney or bond executed pursuant to the resolution adopted by the Board of Directors on August 31, 2022, and any such power so executed, sealed and certified with respect to any bond or undertaking to which it is attached, shall continue to be valid and binding upon the Company. In Testimony Whereof, the Company has caused this instrument to be signed and its corporate seal to be affixed by their authorized officers, this 30th day of January, 2023.

Attested and Certified



Regan A. Shulman, Secretary

Arch Insurance Company

Stephen C. Ruschak, Executive Vice President

STATE OF PENNSYLVANIA SS COUNTY OF PHILADELPHIA SS

I, Michele Tripodi, a Notary Public, do hereby certify that Regan A. Shulman and Stephen C. Ruschak personally known to me to be the same persons whose names are respectively as Secretary and Executive Vice President of the Arch Insurance Company, a Corporation organized and existing under the laws of the State of Missouri, subscribed to the foregoing instrument, appeared before me this day in person and severally acknowledged that they being thereunto duly authorized signed, sealed with the corporate seal and delivered the said instrument as the free and voluntary act of said corporation and as their own free and voluntary acts for the uses and purposes therein set forth.

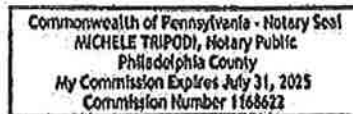

Michele Tripodi, Notary Public My commission expires 07/31/2025

CERTIFICATION

I, Regan A. Shulman, Secretary of the Arch Insurance Company, do hereby certify that the attached Power of Attorney dated January 30, 2023 on behalf of the person(s) as listed above is a true and correct copy and that the same has been in full force and effect since the date thereof and is in full force and effect on the date of this certificate; and I do further certify that the said Stephen C. Ruschak, who executed the Power of Attorney as Executive Vice President, was on the date of execution of the attached Power of Attorney the duly elected Executive Vice President of the Arch Insurance Company.

IN TESTIMONY WHEREOF, I have hereunto subscribed my name and affixed the corporate seal of the Arch Insurance Company on this 1 day of May, 2024.

Regan A. Shulman, Secretary

This Power of Attorney limits the acts of those named therein to the bonds and undertakings specifically named therein and they have no authority to bind the Company except in the manner and to the extent herein stated.

PLEASE SEND ALL CLAIM INQUIRIES RELATING TO THIS BOND TO THE FOLLOWING ADDRESS:

Arch Insurance - Surety Division 3 Parkway, Suite 1500 Philadelphia, PA 19102



To verify the authenticity of this Power of Attorney, please contact Arch Insurance Company at SuretyAuthentic@archinsurance.com Please refer to the above named Attorney-in-Fact and the details of the bond to which the power is attached.

STATE OF New Jersey

COUNTY OF Morris

On this 1st day of May, 2024 before me, a Notary Public within and for said County and State, personally appeared Scott Adams to me personally known, who being duly sworn, upon oath, did say that he is the authorized signatory for the Arch Insurance Company, a corporation created, organized and existing under and by the virtue of the laws of the State of Missouri that the Corporate seal affixed to the foregoing instrument is the seal of said Corporation; that the seal was affixed; and the said Scott Adams did acknowledge that he executed the said instrument as the free and deed of said Corporation.



Notary Public

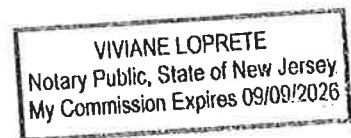

ARCH INSURANCE COMPANY
 STATEMENT OF FINANCIAL CONDITION
 DECEMBER 31, 2023

Assets

Cash & Cash Equivalents in Banks	\$328,130,777
Bonds owned	6,481,021,338
Stocks	813,423,103
Premiums in course of collection	945,968,974
Accrued interest and other assets	1,398,321,681
Total Assets	\$ 9,966,865,873

Liabilities

Reserve for losses and adjustment expenses	\$3,580,722,897
Reserve for unearned premiums	1,770,436,315
Ceded reinsurance premiums payable	1,021,006,333
Amounts withheld or retained by company for account of others	165,467,758
Reserve for taxes, expenses and other liabilities	986,839,682
Total Liabilities	\$7,524,472,985
Surplus as regards policyholders	2,442,392,888
Total Surplus and Liabilities	\$9,966,865,873

By: *[Signature]* Attest: *[Signature]*
 Executive Vice President, Chief Financial Officer and Treasurer Executive Vice President, General Counsel and Secretary

State of New Jersey)
) SS
 County of Hudson)

Thomas James Ahern, Executive Vice President, Chief Financial Officer and Treasurer and Regan Shulman, Executive Vice President, General Counsel and Secretary being duly sworn, of ARCH INSURANCE COMPANY, Missouri; and that the foregoing is a true and correct statement of financial condition of said company, as of December 31, 2023.

Subscribed and sworn to before me, this 7 day of March 2024

Notary Public *[Signature]*

BARBARA A. LEE
 Commission # 50107758
 Notary Public, State of New Jersey
 My Commission Expires
 June 27, 2024

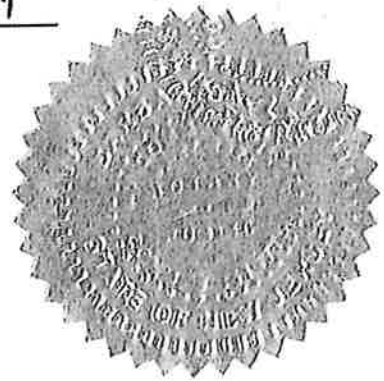

State of New York

DEPARTMENT OF FINANCIAL SERVICES

WHEREAS IT APPEARS THAT

Arch Insurance Company

Home Office Address Kansas City, Missouri

Organized under the Laws of Missouri

has complied with the necessary requirements of or pursuant to law, it is hereby

licensed to do within this State the business of

accident and health, fire, miscellaneous property, water damage, burglary and theft, glass, boiler and machinery, animal, collision, personal injury liability, property damage liability, workers' compensation and employers' liability, fidelity and surety, credit, motor vehicle and aircraft physical damage, marine and inland marine, marine protection and indemnity, credit unemployment, gap, service contract reimbursement and legal services insurance, as specified in paragraph(s) 3, 4, 5, 6, 7, 8, 9, 11, 12, 13, 14, 15, 16, 17, 19, 20, 21, 24, 26(A)(B)(C)(D), 28 and 29 of Section 1113(a) of the New York Insurance Law and also such workers' compensation insurance as may be incident to coverages contemplated under paragraphs 20 and 21 of Section 1113(a), including insurances described in the Longshoremen's and Harbor Workers' Compensation Act (Public Law No. 803, 69 Cong. as amended; 33 USC Section 901 et seq. as amended) to the extent permitted by certified copy of its charter document on file in this Department until July 1, 2024.



**In Witness Whereof, I have hereunto set
my hand and affixed the official seal of this
Department at the City of Albany, New York, this
1st day of July, 2023**

Adrienne A. Harris
Superintendent

By

A rectangular box containing a handwritten signature in dark ink, which appears to be "Rawle Lewis".

Rawle Lewis
Special Deputy Superintendent



CERTIFICATE OF LIABILITY INSURANCE

DATE (MM/DD/YYYY)
5/14/2024

THIS CERTIFICATE IS ISSUED AS A MATTER OF INFORMATION ONLY AND CONFERS NO RIGHTS UPON THE CERTIFICATE HOLDER. THIS CERTIFICATE DOES NOT AFFIRMATIVELY OR NEGATIVELY AMEND, EXTEND OR ALTER THE COVERAGE AFFORDED BY THE POLICIES BELOW. THIS CERTIFICATE OF INSURANCE DOES NOT CONSTITUTE A CONTRACT BETWEEN THE ISSUING INSURER(S), AUTHORIZED REPRESENTATIVE OR PRODUCER, AND THE CERTIFICATE HOLDER.

IMPORTANT: If the certificate holder is an ADDITIONAL INSURED, the policy(ies) must have ADDITIONAL INSURED provisions or be endorsed. If SUBROGATION IS WAIVED, subject to the terms and conditions of the policy, certain policies may require an endorsement. A statement on this certificate does not confer rights to the certificate holder in lieu of such endorsement(s).

PRODUCER DKM Insurance Agency Inc. One Rabro Drive, Suite 11 Hauppauge, NY 11788	CONTACT NAME: PHONE (A/C, No, Ext): 631 363-5200 E-MAIL ADDRESS: coi@dkminsurance.com	FAX (A/C, No): 631 363-7649	
	INSURER(S) AFFORDING COVERAGE		
INSURED RE-EARTH OF STROUDSBURG INC. 2 Katz Road Stroudsburg, PA 18360	INSURER A:	FORTEGRA SPECIALTY INS CO	NAIC # 16823
	INSURER B:	STARSTONE	25496
	INSURER C:	PROGRESSIVE	24260
	INSURER D:	STATE INSURANCE FUND	524128
	INSURER E:	FAIR AMERICAN INS & REINS CO	35157
	INSURER F:	HOMELAND INS CO OF DELAWARE	14231

COVERAGES **CERTIFICATE NUMBER:** **REVISION NUMBER:**

THIS IS TO CERTIFY THAT THE POLICIES OF INSURANCE LISTED BELOW HAVE BEEN ISSUED TO THE INSURED NAMED ABOVE FOR THE POLICY PERIOD INDICATED. NOTWITHSTANDING ANY REQUIREMENT, TERM OR CONDITION OF ANY CONTRACT OR OTHER DOCUMENT WITH RESPECT TO WHICH THIS CERTIFICATE MAY BE ISSUED OR MAY PERTAIN, THE INSURANCE AFFORDED BY THE POLICIES DESCRIBED HEREIN IS SUBJECT TO ALL THE TERMS, EXCLUSIONS AND CONDITIONS OF SUCH POLICIES. LIMITS SHOWN MAY HAVE BEEN REDUCED BY PAID CLAIMS.

INSR LTR	TYPE OF INSURANCE	ADDL INSD	SUBR WVD	POLICY NUMBER	POLICY EFF (MM/DD/YYYY)	POLICY EXP (MM/DD/YYYY)	LIMITS
A	<input checked="" type="checkbox"/> COMMERCIAL GENERAL LIABILITY <input type="checkbox"/> CLAIMS-MADE <input checked="" type="checkbox"/> OCCUR Add'l Insured 2010/2026 GEN'L AGGREGATE LIMIT APPLIES PER: <input type="checkbox"/> POLICY <input checked="" type="checkbox"/> PRO-JECT <input type="checkbox"/> LOC OTHER:	Y	Y	FKE100017500 Contractual	3/31/2024	3/31/2025	EACH OCCURRENCE \$ 1,000,000 DAMAGE TO RENTED PREMISES (Ea occurrence) \$ 50,000 MED EXP (Any one person) \$ 5,000 PERSONAL & ADV INJURY \$ 1,000,000 GENERAL AGGREGATE \$ 2,000,000 PRODUCTS - COMP/OP AGG \$ 2,000,000 \$
	AUTOMOBILE LIABILITY <input type="checkbox"/> ANY AUTO <input type="checkbox"/> OWNED AUTOS ONLY <input checked="" type="checkbox"/> SCHEDULED AUTOS <input type="checkbox"/> HIRED AUTOS ONLY <input type="checkbox"/> NON-OWNED AUTOS ONLY <input type="checkbox"/> AUTOS ONLY						
B	<input type="checkbox"/> UMBRELLA LIAB <input type="checkbox"/> OCCUR <input checked="" type="checkbox"/> EXCESS LIAB <input type="checkbox"/> CLAIMS-MADE DED RETENTION \$			R78189230ALI	3/31/2024	3/31/2025	EACH OCCURRENCE \$ 5,000,000 AGGREGATE \$ 5,000,000 \$
D	WORKERS COMPENSATION AND EMPLOYERS' LIABILITY ANY PROPRIETOR/PARTNER/EXECUTIVE OFFICER/MEMBER EXCLUDED? (Mandatory in NH) If yes, describe under DESCRIPTION OF OPERATIONS below	Y / N <input type="checkbox"/>	N / A	Z 2464 583-0	4/01/2024	4/01/2025	<input type="checkbox"/> PER STATUTE <input type="checkbox"/> OTH-ER E.L. EACH ACCIDENT \$ 1,000,000 E.L. DISEASE - EA EMPLOYEE \$ 1,000,000 E.L. DISEASE - POLICY LIMIT \$ 1,000,000
E	Railroad Protective			RPL700116000	3/31/2024	3/31/2025	Occur. \$2,000,000 Aggregate-\$6,000,000 Occur. \$1,000,000
F	Pollution Liability			793-01-24-98-0000	3/31/2024	3/31/2025	Occur. \$1,000,000

DESCRIPTION OF OPERATIONS / LOCATIONS / VEHICLES (ACORD 101, Additional Remarks Schedule, may be attached if more space is required)

Re: HWS2023R - Notice of Intent to Award - Installation of sidewalks, adjacent curbs and pedestrian ramps as necessary in various locations - Borough of Staten Island

CERTIFICATE HOLDER

NEW YORK CITY DEPARTMENT OF DESIGN & CONSTRUCTION
30-30 THOMSON AVENUE
4TH FLOOR (IDCNY BUILDING)
LONG ISLAND CITY, NY 11101

CANCELLATION

SHOULD ANY OF THE ABOVE DESCRIBED POLICIES BE CANCELLED BEFORE THE EXPIRATION DATE THEREOF, NOTICE WILL BE DELIVERED IN ACCORDANCE WITH THE POLICY PROVISIONS.

AUTHORIZED REPRESENTATIVE

Beth Thompson

CITY OF NEW YORK
CERTIFICATION BY INSURANCE BROKER OR AGENT

The undersigned insurance broker or agent represents to the City of New York that the attached Certificate of Insurance is accurate in all material respects.

DKM Insurance Agency Inc.
[Name of broker or agent (typewritten)]

1 Rabro Dr. Hauppauge NY 11788
[Address of broker or agent (typewritten)]

coi@dkminsurance.com
[Email address of broker or agent (typewritten)]

631-363-5200 /FAX 631-363-7649
[Phone number/Fax number of broker or agent (typewritten)]

Lisa Muroff
[Signature of authorized official, broker, or agent]

Lisa Muroff Broker
[Name and title of authorized official, broker, or agent (typewritten)]

State of New York)
County of Westchester) ss.:

Sworn to before me this 14 day of May 2024

Erika Ramirez

NOTARY PUBLIC FOR THE STATE OF New York

ERIKA RAMIREZ
NOTARY PUBLIC, STATE OF NEW YORK
Registration No. 01RA6354879
Qualified in West Chester County
My Commission Expires: February 21, 2025



CERTIFICATE OF NYS WORKERS' COMPENSATION INSURANCE COVERAGE

Form with 4 main sections: 1a. Legal Name & Address of Insured; 1b. Business Telephone Number of Insured; 2. Name and Address of Entity Requesting Proof of Coverage; 3a. Name of Insurance Carrier.

This certifies that the insurance carrier indicated above in box "3" insures the business referenced above in box "1a" for workers' compensation under the New York State Workers' Compensation Law. (To use this form, New York (NY) must be listed under Item 3A on the INFORMATION PAGE of the workers' compensation insurance policy).

The insurance carrier must notify the above certificate holder and the Workers' Compensation Board within 10 days IF a policy is canceled due to nonpayment of premiums or within 30 days IF there are reasons other than nonpayment of premiums that cancel the policy or eliminate the insured from the coverage indicated on this Certificate.

This certificate is issued as a matter of information only and confers no rights upon the certificate holder. This certificate does not amend, extend or alter the coverage afforded by the policy listed, nor does it confer any rights or responsibilities beyond those contained in the referenced policy.

This certificate may be used as evidence of a Workers' Compensation contract of insurance only while the underlying policy is in effect.

Please Note: Upon cancellation of the workers' compensation policy indicated on this form, if the business continues to be named on a permit, license or contract issued by a certificate holder, the business must provide that certificate holder with a new Certificate of Workers' Compensation Coverage or other authorized proof that the business is complying with the mandatory coverage requirements of the New York State Workers' Compensation Law.

Under penalty of perjury, I certify that I am an authorized representative or licensed agent of the insurance carrier referenced above and that the named insured has the coverage as depicted on this form.

Approved by: BETH THOMPSON (Print name of authorized representative or licensed agent of insurance carrier)
Approved by: [Signature] 5/14/21 (Date)

Title: Account Executive

Telephone Number of authorized representative or licensed agent of insurance carrier: 631-363-5200

Please Note: Only insurance carriers and their licensed agents are authorized to issue Form C-105.2. Insurance brokers are NOT authorized to issue it.

Workers' Compensation Law

Section 57. Restriction on issue of permits and the entering into contracts unless compensation is secured.

1. The head of a state or municipal department, board, commission or office authorized or required by law to issue any permit for or in connection with any work involving the employment of employees in a hazardous employment defined by this chapter, and notwithstanding any general or special statute requiring or authorizing the issue of such permits, shall not issue such permit unless proof duly subscribed by an insurance carrier is produced in a form satisfactory to the chair, that compensation for all employees has been secured as provided by this chapter. Nothing herein, however, shall be construed as creating any liability on the part of such state or municipal department, board, commission or office to pay any compensation to any such employee if so employed.
2. The head of a state or municipal department, board, commission or office authorized or required by law to enter into any contract for or in connection with any work involving the employment of employees in a hazardous employment defined by this chapter, notwithstanding any general or special statute requiring or authorizing any such contract, shall not enter into any such contract unless proof duly subscribed by an insurance carrier is produced in a form satisfactory to the chair, that compensation for all employees has been secured as provided by this chapter.



CERTIFICATE OF INSURANCE COVERAGE
NYS DISABILITY AND PAID FAMILY LEAVE BENEFITS LAW

PART 1. To be completed by NYS disability and Paid Family Leave benefits carrier or licensed insurance agent of that carrier

1a. Legal Name & Address of Insured (use street address only)
RE-EARTH OF STROUDSBURG INC.
918 VAN SINDEREN AVENUE
BROOKLYN, NY 11236
Work Location of Insured (Only required if coverage is specifically limited to certain locations in New York State, i.e., Wrap-Up Policy)
HWS2023R - Installation of sidewalks adjacent curbed various locations - Borough of Staten Island

1b. Business Telephone Number of Insured
5704761000
1c. Federal Employer Identification Number of Insured or Social Security Number
81-4263393

2. Name and Address of Entity Requesting Proof of Coverage (Entity Being Listed as the Certificate Holder)
NYC DEPT OF DESIGN & CONSTRUCTION
30-30 THOMSON AVE
4TH FLOOR (IDCNY BUILDING)
LONG ISLAND CITY, NY 11101

3a. Name of Insurance Carrier
Standard Security Life Insurance Company of New York
3b. Policy Number of Entity Listed in Box 1a
R68900-000
3c. Policy Effective Period
3/9/2019 to 5/13/2025

4. Policy provides the following benefits:
[X] A. Both disability and Paid Family Leave benefits.
[] B. Disability benefits only.
[] C. Paid Family Leave benefits only.
5. Policy covers:
[X] A. All of the employer's employees eligible under the NYS Disability and Paid Family Leave Benefits Law.
[] B. Only the following class or classes of employer's employees:

Under penalty of perjury, I certify that I am an authorized representative or licensed agent of the insurance carrier referenced above and that the named insured has NYS disability and/or Paid Family Leave benefits insurance coverage as described above.

Date Signed 5/14/2024 By [Signature]
(Signature of insurance carrier's authorized representative or NYS licensed insurance agent of that insurance carrier)

Telephone Number (212) 355-4141 Name and Title SUPERVISOR-DBL/POLICY SERVICES

IMPORTANT: If Boxes 4A and 5A are checked, and this form is signed by the insurance carrier's authorized representative or NYS Licensed Insurance Agent of that carrier, this certificate is COMPLETE. Mail it directly to the certificate holder.

If Box 4B, 4C or 5B is checked, this certificate is NOT COMPLETE for purposes of Section 220, Subd. 8 of the NYS Disability and Paid Family Leave Benefits Law. It must be emailed to PAU@wcb.ny.gov or it can be mailed for completion to the Workers' Compensation Board, Plans Acceptance Unit, PO Box 5200, Binghamton, NY 13902-5200.

PART 2. To be completed by the NYS Workers' Compensation Board (Only if Box 4B, 4C or 5B of Part 1 has been checked)

State of New York
Workers' Compensation Board

According to information maintained by the NYS Workers' Compensation Board, the above-named employer has complied with the NYS Disability and Paid Family Leave Benefits Law (Article 9 of the Workers' Compensation Law) with respect to all of their employees.

Date Signed By
(Signature of Authorized NYS Workers' Compensation Board Employee)

Telephone Number Name and Title

Please Note: Only insurance carriers licensed to write NYS disability and Paid Family Leave benefits insurance policies and NYS licensed insurance agents of those insurance carriers are authorized to issue Form DB-120.1. Insurance brokers are NOT authorized to issue this form.



Additional Instructions for Form DB-120.1

By signing this form, the insurance carrier identified in Box 3 on this form is certifying that it is insuring the business referenced in Box 1a for disability and/or Paid Family Leave benefits under the NYS Disability and Paid Family Leave Benefits Law. The insurance carrier or its licensed agent will send this Certificate of Insurance Coverage (Certificate) to the entity listed as the certificate holder in Box 2.

The insurance carrier must notify the above certificate holder and the Workers' Compensation Board within 10 days IF a policy is cancelled due to nonpayment of premiums or within 30 days IF there are reasons other than nonpayment of premiums that cancel the policy or eliminate the insured from coverage indicated on this Certificate. (These notices may be sent by regular mail.) Otherwise, this Certificate is valid for one year after this form is approved by the insurance carrier or its licensed agent, or until the policy expiration date listed in Box 3c, whichever is earlier.

This certificate is issued as a matter of information only and confers no rights upon the certificate holder. This certificate does not amend, extend or alter the coverage afforded by the policy listed, nor does it confer any rights or responsibilities beyond those contained in the referenced policy.

This Certificate may be used as evidence of a NYS disability and/or Paid Family Leave benefits contract of insurance only while the underlying policy is in effect.

Please Note: Upon the cancellation of the disability and/or Paid Family Leave benefits policy indicated on this form, if the business continues to be named on a permit, license or contract issued by a certificate holder, the business must provide that certificate holder with a new Certificate of Insurance Coverage for NYS disability and/or Paid Family Leave Benefits or other authorized proof that the business is complying with the mandatory coverage requirements of the NYS Disability and Paid Family Leave Benefits Law.

NYS DISABILITY AND PAID FAMILY LEAVE BENEFITS LAW

§220. Subd. 8

(a) The head of a state or municipal department, board, commission or office authorized or required by law to issue any permit for or in connection with any work involving the employment of employees in employment as defined in this article, and notwithstanding any general or special statute requiring or authorizing the issue of such permits, shall not issue such permit unless proof duly subscribed by an insurance carrier is produced in a form satisfactory to the chair, that the payment of disability benefits and after January first, two thousand and twenty-one, the payment of family leave benefits for all employees has been secured as provided by this article. Nothing herein, however, shall be construed as creating any liability on the part of such state or municipal department, board, commission or office to pay any disability benefits to any such employee if so employed.

(b) The head of a state or municipal department, board, commission or office authorized or required by law to enter into any contract for or in connection with any work involving the employment of employees in employment as defined in this article and notwithstanding any general or special statute requiring or authorizing any such contract, shall not enter into any such contract unless proof duly subscribed by an insurance carrier is produced in a form satisfactory to the chair, that the payment of disability benefits and after January first, two thousand eighteen, the payment of family leave benefits for all employees has been secured as provided by this article.

OFFICE OF THE COMPTROLLER, CITY OF NEW YORK
CONSTRUCTION WORKER PREVAILING WAGE SCHEDULE

LABOR LAW ARTICLE 8 - NYC PUBLIC WORKS

Workers, Laborers and Mechanics employed on a public work project must receive not less than the prevailing rate of wage and benefits for the classification of work performed by each upon such public work. Pursuant to New York Labor Law Article 8 the Comptroller of the City of New York has promulgated this schedule solely for Workers, Laborers and Mechanics engaged by private contractors on New York City public work projects. Prevailing rates are required to be annexed to and form part of the public work contract pursuant to Labor Law section 220 (3).

This schedule is a compilation of separate determinations of the prevailing rate of wage and supplements made by the Comptroller for each trade classification listed herein pursuant to Labor Law section 220 (5). The source of the wage and supplement rates, whether a collective bargaining agreement, survey data or other, is listed at the end of each classification.

Agency Chief Contracting Officers should contact the Bureau of Labor Law's Classification Unit with any questions concerning trade classifications, prevailing rates or prevailing practices with respect to procurement on New York City public work contracts. Contractors are advised to review the Comptroller's Prevailing Wage Schedule before bidding on public work contracts. Contractors with questions concerning trade classifications, prevailing rates or prevailing practices with respect to public work contracts in the procurement stage must contact the contracting agency responsible for the procurement.

Any error as to compensation under the prevailing wage law or other information as to trade classification, made by the contracting agency in the contract documents or in any other communication, will not preclude a finding against the contractor of prevailing wage violation.

Any questions concerning trade classifications, prevailing rates or prevailing practices on New York City public work contracts that have already been awarded may be directed to the Bureau of Labor Law's Classification Unit by calling (212) 669-4443. All callers must have the agency name and contract registration number available when calling with questions on public work contracts. Please direct all other compliance issues to: laborlaw@comptroller.nyc.gov or Bureau of Labor Law, Attn: Paul Brumlik, Office of the Comptroller, 1 Centre Street, Room 651, New York, N.Y. 10007.

Pursuant to Labor Law § 220 (3-a) (a), the appropriate schedule of prevailing wages and benefits must be posted in a prominent and accessible place at all public work sites along with the Construction Poster provided on our web site at comptroller.nyc.gov/wages. In addition, covered employees must be given the appropriate schedule of prevailing wages and benefits along with the Worker Notice provided on our web site at the time the public work project begins, and with the first paycheck to each such employee after July first of each year.

This schedule is applicable to work performed during the effective period, unless otherwise noted. Changes to this schedule are published on our web site comptroller.nyc.gov/wages. Contractors must pay the wages and supplements in effect when the worker, laborer, mechanic performs the work. Preliminary schedules for future one-year periods appear in the City Record on or about June 1 each succeeding year. Final schedules appear on or about July 1 in the City Record and on our web site comptroller.nyc.gov/wages.

Prevailing rates and ratios for apprentices are published in the Construction Apprentice Prevailing Wage Schedule. Pursuant to Labor Law § 220 (3-e), only apprentices who are individually registered in a bona fide program to which the employer contractor is a participant, registered with the

OFFICE OF THE COMPTROLLER, CITY OF NEW YORK
CONSTRUCTION WORKER PREVAILING WAGE SCHEDULE

New York State Department of Labor, may be paid at the apprentice rates. Apprentices who are not so registered must be paid as journey persons.

New York City public work projects awarded pursuant to a Project Labor Agreement (“PLA”) in accordance with Labor Law section 222 may have different labor standards for shift, premium and overtime work. Please refer to the PLA’s pre-negotiated labor agreements for wage and benefit rates applicable to work performed outside of the regular workday. More information is available at the Mayor’s Office of Contract Services (MOCS) web page at:

<https://www1.nyc.gov/site/mocs/legal-forms/project-labor-agreements.page>

All the provisions of Labor Law Article 8 remain applicable to PLA work including, but not limited to, the enforcement of prevailing wage requirements by the Comptroller in accordance with the trade classifications in this schedule; however, we will enforce shift, premium, overtime and other non-standard rates as they appear in a project’s pre-negotiated labor agreement.

In order to meet their obligation to provide prevailing supplemental benefits to each covered employee, employers must either:

- 1) Provide bona fide fringe benefits which cost the employer no less than the prevailing supplemental benefits rate; or
- 2) Supplement the employee’s hourly wage by an amount no less than the prevailing supplemental benefits rate; or
- 3) Provide a combination of bona fide fringe benefits and wage supplements which cost the employer no less than the prevailing supplemental benefits rate in total.

Although prevailing wage laws do not require employers to provide bona fide fringe benefits (as opposed to wage supplements) to their employees, other laws may. For example, the Employee Retirement Income Security Act, 29 U.S.C. § 1001 et seq., the Patient Protection and Affordable Care Act, 42 U.S.C. § 18001 et seq., and the New York City Paid Sick Leave Law, N.Y.C. Admin. Code § 20-911 et seq., require certain employers to provide certain benefits to their employees. Labor agreements to which employers are a party may also require certain benefits. The Comptroller’s Office does not enforce these laws or agreements.

Employers must provide prevailing supplemental benefits at the straight time rate for each hour worked unless otherwise noted in the classification.

Paid Holidays, Vacation and Sick Leave when listed must be paid or provided in addition to the prevailing hourly supplemental benefit rate.

For more information, please refer to the Comptroller’s Prevailing Wage Law Regulations in Title 44 of the Rules of the City of New York, Chapter 2, available at comptroller.nyc.gov/wages.

Paul Brumlik
Director of Classifications
Bureau of Labor Law

ADDENDUM

List of Amended Classifications

1. BRICKLAYER
2. CORE DRILLER
3. DRIVER: TRUCK (TEAMSTER)
4. ENGINEER - FIELD (HEAVY CONSTRUCTION)
5. HAZARDOUS MATERIAL HANDLER
6. HOUSE WRECKER
7. IRON WORKER - ORNAMENTAL
8. IRON WORKER - STRUCTURAL
9. MARBLE MECHANIC
10. MASON TENDER
11. MASON TENDER (INTERIOR DEMOLITION WORKER)
12. MOSAIC MECHANIC
13. PLUMBER
14. PLUMBER (MECHANICAL EQUIPMENT AND SERVICE)
15. PLUMBER (RESIDENTIAL RATES FOR 1, 2 AND 3 FAMILY HOME CONSTRUCTION)
16. POINTER, WATERPROOFER, CAULKER, SANDBLASTER, STEAMBLASTER
17. SHEET METAL WORKER
18. SHEET METAL WORKER - SPECIALTY
19. SIGN ERECTOR
20. STEAMFITTER - REFRIGERATION AND AIR CONDITIONER
21. TAPER
22. TILE FINISHER
23. TILE LAYER - SETTER

OFFICE OF THE COMPTROLLER, CITY OF NEW YORK
CONSTRUCTION WORKER PREVAILING WAGE SCHEDULE

TABLE OF CONTENTS

<u>CLASSIFICATION</u>	<u>PAGE</u>
ASBESTOS HANDLER	6
BLASTER	6
BOILERMAKER.....	7
BRICKLAYER	8
CARPENTER - BUILDING COMMERCIAL	9
CARPENTER - HEAVY CONSTRUCTION WORK	10
CARPENTER - HIGH RISE CONCRETE FORMS	11
CARPENTER - SIDEWALK SHED, SCAFFOLD AND HOIST	12
CARPENTER - WOOD WATER STORAGE TANK	13
CEMENT & CONCRETE WORKER.....	14
CEMENT MASON.....	15
CORE DRILLER	16
DERRICKPERSON AND RIGGER.....	17
DIVER.....	18
DOCKBUILDER - PILE DRIVER.....	19
DRIVER: TRUCK (TEAMSTER)	20
ELECTRICIAN	22
ELECTRICIAN - ALARM TECHNICIAN.....	26
ELECTRICIAN-STREET LIGHTING WORKER	27
ELEVATOR CONSTRUCTOR.....	28
ELEVATOR REPAIR & MAINTENANCE.....	29
ENGINEER	30
ENGINEER - CITY SURVEYOR AND CONSULTANT	35
ENGINEER - FIELD (BUILDING CONSTRUCTION)	36
ENGINEER - FIELD (HEAVY CONSTRUCTION).....	37
ENGINEER - FIELD (STEEL ERECTION)	38
ENGINEER - OPERATING.....	39
FLOOR COVERER	47
GLAZIER	48
GLAZIER - REPAIR & MAINTENANCE.....	49
HAZARDOUS MATERIAL HANDLER	49
HEAT AND FROST INSULATOR.....	50
HOUSE WRECKER	51
IRON WORKER - ORNAMENTAL	52
IRON WORKER - STRUCTURAL.....	53
LABORER	54
LANDSCAPING	55

OFFICE OF THE COMPTROLLER, CITY OF NEW YORK
CONSTRUCTION WORKER PREVAILING WAGE SCHEDULE

MARBLE MECHANIC.....	57
MASON TENDER	59
MASON TENDER (INTERIOR DEMOLITION WORKER)	59
METALLIC LATHER	61
MILLWRIGHT.....	61
MOSAIC MECHANIC.....	62
PAINTER.....	63
PAINTER - LINE STRIPING (ROADWAY)	64
PAINTER - METAL POLISHER.....	64
PAINTER - SIGN.....	66
PAINTER - STRUCTURAL STEEL	67
PAPERHANGER.....	68
PAVER AND ROADBUILDER.....	69
PAVER AND ROADBUILDER - LINE STRIPING (ROADWAY)	70
PLASTERER	72
PLASTERER - TENDER.....	72
PLUMBER	73
PLUMBER (MECHANICAL EQUIPMENT AND SERVICE)	74
PLUMBER (RESIDENTIAL RATES FOR 1, 2 AND 3 FAMILY HOME CONSTRUCTION).....	75
PLUMBER: PUMP & TANK.....	76
POINTER, WATERPROOFER, CAULKER, SANDBLASTER, STEAMBLASTER.....	77
ROOFER.....	78
SHEET METAL WORKER	78
SHEET METAL WORKER - SPECIALTY.....	80
SHIPYARD WORKER.....	81
SIGN ERECTOR.....	82
STEAMFITTER	83
STEAMFITTER - REFRIGERATION AND AIR CONDITIONER.....	84
STONE MASON - SETTER.....	85
TAPER	86
TELECOMMUNICATION WORKER	87
TILE FINISHER.....	88
TILE LAYER - SETTER.....	89
TIMBERPERSON	90
TUNNEL WORKER.....	90
UTILITY LOCATOR	92
WELDER.....	94

ASBESTOS HANDLER SEE HAZARDOUS MATERIAL HANDLER

BLASTER

Blaster

Effective Period: 7/1/2023 - 6/30/2024

Wage Rate per Hour: **\$57.71**

Supplemental Benefit Rate per Hour: **\$52.23**

Blaster - Hydraulic Trac Drill

Effective Period: 7/1/2023 - 6/30/2024

Wage Rate per Hour: **\$51.85**

Supplemental Benefit Rate per Hour: **\$52.23**

Blaster - Wagon: Air Trac: Quarry Bar: Drillrunners

Effective Period: 7/1/2023 - 6/30/2024

Wage Rate per Hour: **\$51.02**

Supplemental Benefit Rate per Hour: **\$52.23**

Blaster - Journeyperson

(Laborer, Chipper/Jackhammer including Walk Behind Self Propelled Hydraulic Asphalt and Concrete Breakers and Hydro (Water) Demolition, Powder Carrier, Hydraulic Chuck Tender, Chuck Tender and Nipper)

Effective Period: 7/1/2023 - 6/30/2024

Wage Rate per Hour: **\$44.50**

Supplemental Benefit Rate per Hour: **\$52.23**

Blaster - Magazine Keepers: (Watch Person)

Effective Period: 7/1/2023 - 6/30/2024

Wage Rate per Hour: **\$22.25**

Supplemental Benefit Rate per Hour: **\$52.23**

Overtime

Time and one half the regular rate after an 8 hour day.

Time and one half the regular rate for Saturday.

Double time the regular rate for Sunday.

OFFICE OF THE COMPTROLLER, CITY OF NEW YORK
CONSTRUCTION WORKER PREVAILING WAGE SCHEDULE

Overtime Holidays

Double time the regular rate for work on the following holiday(s).

New Year's Day
Memorial Day
Independence Day
Labor Day
Columbus Day
Thanksgiving Day
Christmas Day

Paid Holidays

Labor Day
Thanksgiving Day

Shift Rates

When two shifts are employed, single time rate shall be paid for each shift. When three shifts are found necessary, each shift shall work seven and one half hours (7 ½), but shall be paid for eight (8) hours of labor, and be permitted one half hour for lunch.

(Local #731)

BOILERMAKER

Boilermaker

Effective Period: 7/1/2023 - 6/30/2024

Wage Rate per Hour: **\$65.88**

Supplemental Benefit Rate per Hour: **\$48.47**

Supplemental Note: For time and one half overtime - \$72.13 For double overtime - \$95.79

Overtime Description

For Repair and Maintenance work:

Time and one half the regular rate after an 8 hour day.

Time and one half the regular rate for Saturday.

Double time the regular rate for Sunday.

For New Construction work:

Double time the regular rate after an 8 hour day.

Double time the regular time rate for Saturday.

Double time the regular rate for Sunday.

Overtime Holidays

Double time the regular rate for work on the following holiday(s).

New Year's Day
President's Day
Memorial Day
Independence Day

OFFICE OF THE COMPTROLLER, CITY OF NEW YORK
CONSTRUCTION WORKER PREVAILING WAGE SCHEDULE

Columbus Day
Election Day
Veteran's Day
Thanksgiving Day
Christmas Day

Quadruple time the regular rate for work on the following holiday(s).
Labor Day

Paid Holidays

Good Friday
Day after Thanksgiving
Day before Christmas
Day before New Year's Day

Shift Rates

On jobs requiring two (2) or three (3) shifts, the first shift shall work eight (8) hours at the regular straight-time hourly rate. The second shift shall work eight (8) hours and receive eight hours at the regular straight time hourly rate plus two dollars (\$2.00) per hour. The third shift shall work eight (8) hours and receive eight hours at the regular straight time hourly rate plus two dollars and twenty-five cents (\$2.25) per hour.

(Local #5)

BRICKLAYER

Bricklayer

Effective Period: 7/1/2023 - 1/14/2024
Wage Rate per Hour: **\$64.23**
Supplemental Benefit Rate per Hour: **\$31.75**

Effective Period: 1/15/2024 - 6/30/2024
Wage Rate per Hour: **\$65.34**
Supplemental Benefit Rate per Hour: **\$33.05**

Overtime Description

Time and one half the regular rate after a 7 hour day. If working on a job that is predominately Pointer, Cleaner, Caulker work, then Time and one half the regular rate after an 8 hour day.

Overtime

Time and one half the regular rate for Saturday.
Double time the regular rate for Sunday.
Saturday may be used as a make-up day at straight time when a day is lost during that week to inclement weather.

Overtime Holidays

OFFICE OF THE COMPTROLLER, CITY OF NEW YORK
CONSTRUCTION WORKER PREVAILING WAGE SCHEDULE

Double time the regular rate for work on the following holiday(s).

New Year's Day
President's Day
Memorial Day
Independence Day
Labor Day
Thanksgiving Day
Christmas Day

Paid Holidays

None

Shift Rates

The second shift wage rate shall be a 15% wage premium with no premium for supplemental benefits. There must be a first shift in order to work a second shift. When it is not possible to conduct alteration or repair work during regular working hours in a building occupied by tenants, eight hours will be paid at straight time rate for seven hours of work.

(Bricklayer District Council)

CARPENTER - BUILDING COMMERCIAL

Building Commercial

Effective Period: 7/1/2023 - 6/30/2024

Wage Rate per Hour: **\$55.05**

Supplemental Benefit Rate per Hour: **\$47.88**

Overtime

Time and one half the regular rate after an 8 hour day.

Time and one half the regular rate for Saturday.

Double time the regular rate for Sunday.

Saturday may be used as a make-up day at straight time when a day is lost during that week to inclement weather.

Overtime Holidays

Double time the regular rate for work on the following holiday(s).

New Year's Day
President's Day
Memorial Day
Independence Day
Labor Day
Columbus Day
Presidential Election Day
Thanksgiving Day
Day after Thanksgiving
Christmas Day

OFFICE OF THE COMPTROLLER, CITY OF NEW YORK
CONSTRUCTION WORKER PREVAILING WAGE SCHEDULE

Paid Holidays

None

Shift Rates

The second shift will receive one hour at the double time rate of pay for the last hour of the shift; eight hours pay for seven hours of work, nine hours pay for eight hours of work. There must be a first shift in order to work a second shift. When it is not possible to conduct alteration or repair work during regular working hours in a building occupied by tenants, the rule for the second shift will apply.

(Carpenters District Council)

CARPENTER - HEAVY CONSTRUCTION WORK

(Construction of Engineered Structures and Building Foundations including all form work)

Heavy Construction Work

Effective Period: 7/1/2023 - 6/30/2024

Wage Rate per Hour: **\$59.16**

Supplemental Benefit Rate per Hour: **\$55.31**

Overtime

Time and one half the regular rate after an 8 hour day.

Time and one half the regular rate for Saturday.

Double time the regular rate for Sunday.

Saturday may be used as a make-up day at straight time when a day is lost during that week to inclement weather.

Overtime Holidays

Double time the regular rate for work on the following holiday(s).

New Year's Day

President's Day

Memorial Day

Independence Day

Labor Day

Columbus Day

Presidential Election Day

Thanksgiving Day

Christmas Day

Paid Holidays

None

OFFICE OF THE COMPTROLLER, CITY OF NEW YORK
CONSTRUCTION WORKER PREVAILING WAGE SCHEDULE

Shift Rates

Off shift work commencing between 5:00 P.M. and 11:00 P.M. shall work eight and one half hours allowing for one half hour for lunch. The wage rate shall be 113% of the straight time hourly wage rate and the supplemental benefits shall be paid at the straight time rate. When two (2) or more shifts of Carpenters are employed, single time will be paid for each shift.

(Carpenters District Council)

CARPENTER - HIGH RISE CONCRETE FORMS (Excludes Engineered Structures and Building Foundations)

Carpenter High Rise A

Effective Period: 7/1/2023 - 6/30/2024

Wage Rate per Hour: **\$51.48**

Supplemental Benefit Rate per Hour: **\$44.74**

Carpenter High Rise B

Carpenter High Rise B worker is excluded from high risk operations such as erection decking, perimeter debris netting, leading edge work, self-climbing form systems, and the installation of cocoon systems unless directly supervised by a Carpenter High Rise A worker.

Effective Period: 7/1/2023 - 6/30/2024

Wage Rate per Hour: **\$40.89**

Supplemental Benefit Rate per Hour: **\$18.05**

Overtime

Time and one half the regular rate after an 8 hour day.

Time and one half the regular rate for Saturday.

Double time the regular rate for Sunday.

Saturday may be used as a make-up day at straight time when a day is lost during that week to inclement weather.

Overtime Holidays

Time and one half the regular rate for work on the following holiday(s).

New Year's Day

President's Day

Good Friday

Memorial Day

Independence Day

Labor Day

Columbus Day

Presidential Election Day

Thanksgiving Day

OFFICE OF THE COMPTROLLER, CITY OF NEW YORK
CONSTRUCTION WORKER PREVAILING WAGE SCHEDULE

Christmas Day

Paid Holidays

None

Shift Rates

The second shift wage rate shall be 113% of the straight time hourly wage rate. However, any shift beginning after 5:00 P.M. shall be paid at time and one half the regular hourly rate. There must be a first shift in order to work a second shift. When it is not possible to conduct alteration or repair work during regular working hours in a building occupied by tenants, the rule for the second shift will apply.

(Carpenters District Council)

CARPENTER - SIDEWALK SHED, SCAFFOLD AND HOIST

Carpenter - Hod Hoist

(Assisted by Mason Tender)

Effective Period: 7/1/2023 - 6/30/2024

Wage Rate per Hour: **\$53.50**

Supplemental Benefit Rate per Hour: **\$48.45**

Overtime

Time and one half the regular rate after an 8 hour day.

Time and one half the regular rate for Saturday.

Double time the regular rate for Sunday.

Saturday may be used as a make-up day at straight time when a day is lost during that week to inclement weather.

Overtime Holidays

Double time the regular rate for work on the following holiday(s).

New Year's Day

President's Day

Memorial Day

Independence Day

Labor Day

Columbus Day

Presidential Election Day

Thanksgiving Day

Day after Thanksgiving

Christmas Day

Paid Holidays

None

OFFICE OF THE COMPTROLLER, CITY OF NEW YORK
CONSTRUCTION WORKER PREVAILING WAGE SCHEDULE

Shift Rates

The second shift will receive 112% of the straight time hourly rate. Benefit fund contributions shall be paid at the straight time rate. There must be a first shift in order to work a second shift. When it is not possible to conduct alteration or repair work during regular working hours in a building occupied by tenants, the rule for the second shift will apply.

(Carpenters District Council)

CARPENTER - WOOD WATER STORAGE TANK

Tank Mechanic

Effective Period: 7/1/2023 - 6/30/2024

Wage Rate per Hour: **\$37.13**

Supplemental Benefit Rate per Hour: **\$24.18**

Tank Helper

Effective Period: 7/1/2023 - 6/30/2024

Wage Rate per Hour: **\$29.23**

Supplemental Benefit Rate per Hour: **\$24.18**

Overtime

Time and one half the regular rate after an 8 hour day.

Time and one half the regular rate for Saturday.

Double time the regular rate for Sunday.

Time and one half the regular rate for work on a holiday plus the day's pay.

Paid Holidays

New Year's Day

President's Day

Good Friday

Memorial Day

Independence Day

Labor Day

Columbus Day

Thanksgiving Day

Day after Thanksgiving

1/2 day on Christmas Eve if work is performed in the A.M.

Christmas Day

1/2 day on New Year's Eve if work is performed in the A.M.

Vacation

Employed for one (1) year.....one (1) week vacation (40 hours)

Employed for three (3) years.....two (2) weeks vacation (80 hours)

Employed for more than twenty (20) years.....three (3) weeks vacation (120 hours)

OFFICE OF THE COMPTROLLER, CITY OF NEW YORK
CONSTRUCTION WORKER PREVAILING WAGE SCHEDULE

SICK LEAVE:

Two (2) sick days after being employed for twenty (20) years.

(Carpenters District Council)

CEMENT & CONCRETE WORKER

Cement & Concrete Worker

Effective Period: 7/1/2023 - 6/30/2024

Wage Rate per Hour: **\$47.28**

Supplemental Benefit Rate per Hour: **\$30.20**

Supplemental Note: \$34.20 on Saturdays; \$38.20 on Sundays & Holidays

Cement & Concrete Worker - (Hired after 2/6/2016)

Effective Period: 7/1/2023 - 6/30/2024

Wage Rate per Hour: **\$36.80**

Supplemental Benefit Rate per Hour: **\$22.20**

Supplemental Note: \$24.20 on Saturdays; \$26.20 on Sundays & Holidays

Overtime Description

Time and one half the regular rate after 7 hour day (time and one half the regular rate after an 8 hour day when working with Dockbuilders on pile cap forms and for work below street level to the top of the foundation wall, not to exceed 2 feet or 3 feet above the sidewalk-brick shelf, when working on the foundation and structure.)

Overtime

Time and one half the regular rate for Saturday.

Double time the regular rate for Sunday.

Overtime Holidays

Double time the regular rate for work on the following holiday(s).

New Year's Day

President's Day

Good Friday

Memorial Day

Independence Day

Labor Day

Columbus Day

Presidential Election Day

Thanksgiving Day

Christmas Day

Paid Holidays

1/2 day before Christmas Day

1/2 day before New Year's Day

OFFICE OF THE COMPTROLLER, CITY OF NEW YORK
CONSTRUCTION WORKER PREVAILING WAGE SCHEDULE

Shift Rates

On shift work extending over a twenty-four hour period, all shifts are paid at straight time.

(Cement & Concrete Workers District Council 16)

CEMENT MASON

Cement Mason

Effective Period: 7/1/2023 - 6/30/2024

Wage Rate per Hour: **\$53.77**

Supplemental Benefit Rate per Hour: **\$34.01**

Supplemental Note: Supplemental benefit time and one half rate: \$61.47; Double time rate: double the base supplemental benefit rate.

Overtime Description

Time and one-half the regular rate after an 8 hour day, double time the regular rate after 10 hours. Time and one-half the regular rate on Saturday, double time the regular rate after 10 hours. Double time the regular rate on Sunday. Four Days a week at Ten (10) hours straight time is allowed.

Overtime Holidays

Double time the regular rate for work on the following holiday(s).

New Year's Day

President's Day

Good Friday

Memorial Day

Independence Day

Labor Day

Columbus Day

Presidential Election Day

Thanksgiving Day

Christmas Day

Paid Holidays

Any worker who reports to work on Christmas Eve or New Year's Eve pursuant to his employer's instruction shall be entitled to three (3) hours afternoon pay without working.

Shift Rates

For off shift work, (at times other than the regular 7:00 A.M. to 3:30 P.M. work day) a cement mason shall be paid at the regular hourly rate plus a 25% per hour differential.

(Local #780) (BCA)

CORE DRILLER

Core Driller

Effective Period: 7/1/2023 - 1/14/2024

Wage Rate per Hour: **\$43.88**

Supplemental Benefit Rate per Hour: **\$31.35**

Effective Period: 1/15/2024 - 6/30/2024

Wage Rate per Hour: **\$46.25**

Supplemental Benefit Rate per Hour: **\$33.36**

Core Driller Helper

Effective Period: 7/1/2023 - 1/14/2024

Wage Rate per Hour: **\$34.47**

Supplemental Benefit Rate per Hour: **\$31.35**

Effective Period: 1/15/2024 - 6/30/2024

Wage Rate per Hour: **\$36.28**

Supplemental Benefit Rate per Hour: **\$33.36**

Core Driller Helper(Third year in the industry)

Effective Period: 7/1/2023 - 1/14/2024

Wage Rate per Hour: **\$31.02**

Supplemental Benefit Rate per Hour: **\$31.35**

Effective Period: 1/15/2024 - 6/30/2024

Wage Rate per Hour: **\$32.62**

Supplemental Benefit Rate per Hour: **\$33.36**

Core Driller Helper (Second year in the industry)

Effective Period: 7/1/2023 - 1/14/2024

Wage Rate per Hour: **\$27.58**

Supplemental Benefit Rate per Hour: **\$31.35**

Effective Period: 1/15/2024 - 6/30/2024

Wage Rate per Hour: **\$28.98**

Supplemental Benefit Rate per Hour: **\$33.36**

Core Driller Helper (First year in the industry)

Effective Period: 7/1/2023 - 1/14/2024

Wage Rate per Hour: **\$24.13**

OFFICE OF THE COMPTROLLER, CITY OF NEW YORK
CONSTRUCTION WORKER PREVAILING WAGE SCHEDULE

Supplemental Benefit Rate per Hour: **\$31.35**

Effective Period: 1/15/2024 - 6/30/2024

Wage Rate per Hour: **\$25.32**

Supplemental Benefit Rate per Hour: **\$33.36**

Overtime Description

Time and one half the regular rate for work on a holiday plus Holiday pay when worked.

Overtime

Time and one half the regular rate after an 8 hour day.

Time and one half the regular rate for Saturday.

Double time the regular rate for Sunday.

Time and one half the regular rate for work on the following holiday(s).

Paid Holidays

New Year's Day

Memorial Day

Independence Day

Labor Day

Veteran's Day

Thanksgiving Day

Christmas Day

Shift Rates

When two (2) or more shifts are employed, single time shall be paid for each shift, but those employees employed on a shift other than from 8:00 A.M. to 5:00 P.M. shall, in addition, receive two dollars (\$2.00) per hour differential for each hour worked. When three (3) shifts are needed, each shift shall work seven and one-half (7 ½) hours paid for eight (8) hours of labor and be permitted one-half (½) hour for mealtime.

(Carpenters District Council)

DERRICKPERSON AND RIGGER

Derrick Person & Rigger

Effective Period: 7/1/2023 - 6/30/2024

Wage Rate per Hour: **\$58.90**

Supplemental Benefit Rate per Hour: **\$58.37**

Derrick Person & Rigger - Site Work

Assists the Stone Mason-Setter in the setting of stone and paving stone.

Effective Period: 7/1/2023 - 6/30/2024

Wage Rate per Hour: **\$46.49**

OFFICE OF THE COMPTROLLER, CITY OF NEW YORK
CONSTRUCTION WORKER PREVAILING WAGE SCHEDULE

Supplemental Benefit Rate per Hour: **\$46.47**

Overtime Description

The first two hours of overtime on weekdays and the first seven hours of work on Saturdays are paid at time and one half for wages and supplemental benefits. All additional overtimes is paid at double time for wages and supplemental benefits.

Overtime

Double time the regular rate for Sunday.

Overtime Holidays

Double time the regular rate for work on the following holiday(s).

New Year's Day
Washington's Birthday
Good Friday
Memorial Day
Independence Day
Labor Day
Thanksgiving Day
Christmas Day

Paid Holidays

1/2 day on Christmas Eve if work is performed in the A.M.

(Local #197)

DIVER

Diver (Marine)

Effective Period: 7/1/2023 - 6/30/2024

Wage Rate per Hour: **\$74.03**

Supplemental Benefit Rate per Hour: **\$55.31**

Diver Tender (Marine)

Effective Period: 7/1/2023 - 6/30/2024

Wage Rate per Hour: **\$53.57**

Supplemental Benefit Rate per Hour: **\$55.31**

Overtime

Time and one half the regular rate after an 8 hour day.

Time and one half the regular rate for Saturday.

Double time the regular rate for Sunday.

Saturday may be used as a make-up day at straight time when a day is lost during that week to inclement weather.

OFFICE OF THE COMPTROLLER, CITY OF NEW YORK
CONSTRUCTION WORKER PREVAILING WAGE SCHEDULE

Overtime Holidays

Double time the regular rate for work on the following holiday(s).

New Year's Day
President's Day
Memorial Day
Independence Day
Labor Day
Columbus Day
Presidential Election Day
Thanksgiving Day
Christmas Day

Paid Holidays

None

Shift Rates

When three shifts are utilized each shift shall work seven and one half-hours (7 1/2 hours) and paid for 8 hours, allowing for one half hour for lunch.

(Carpenters District Council)

DOCKBUILDER - PILE DRIVER

Dockbuilder - Pile Driver

Effective Period: 7/1/2023 - 6/30/2024

Wage Rate per Hour: **\$59.16**

Supplemental Benefit Rate per Hour: **\$55.31**

Overtime

Time and one half the regular rate after an 8 hour day.

Time and one half the regular rate for Saturday.

Double time the regular rate for Sunday.

Saturday may be used as a make-up day at straight time when a day is lost during that week to inclement weather.

Overtime Holidays

Double time the regular rate for work on the following holiday(s).

New Year's Day
President's Day
Memorial Day
Independence Day
Labor Day
Columbus Day
Presidential Election Day
Thanksgiving Day

OFFICE OF THE COMPTROLLER, CITY OF NEW YORK
CONSTRUCTION WORKER PREVAILING WAGE SCHEDULE

Christmas Day

Paid Holidays

None

Shift Rates

Off shift work commencing between 5:00 P.M. and 11:00 P.M. shall work eight and one half hours allowing for one half hour for lunch. The wage rate shall be 113% of the straight time hourly wage rate.

(Carpenters District Council)

DRIVER: TRUCK (TEAMSTER)

Driver - Dump Truck

Effective Period: 7/1/2023 - 6/30/2024

Wage Rate per Hour: **\$44.17**

Supplemental Benefit Rate per Hour: **\$53.95**

Supplemental Note: Over 40 hours worked: at time and one half rate - \$24.00; at double time rate - \$32.00

Driver - Tractor Trailer

Effective Period: 7/1/2023 - 6/30/2024

Wage Rate per Hour: **\$47.32**

Supplemental Benefit Rate per Hour: **\$52.40**

Supplemental Note: Over 40 hours worked: at time and one half rate - \$23.25; at double time rate - \$31.00

Driver - Euclid & Turnapull Operator

Effective Period: 7/1/2023 - 6/30/2024

Wage Rate per Hour: **\$47.88**

Supplemental Benefit Rate per Hour: **\$52.40**

Supplemental Note: Over 40 hours worked: at time and one half rate - \$23.25; at double time rate - \$31.00

Overtime Description

For Paid Holidays: Holiday pay for all holidays shall be prorated based two hours per day for each day worked in the holiday week, not to exceed 8 hours of holiday pay. For Thanksgiving week, the prorated share shall be 5 1/3 hours of holiday pay for each day worked in Thanksgiving week.

Overtime

Time and one half the regular rate after an 8 hour day.

Time and one half the regular rate for Saturday.

Double time the regular rate for Sunday.

Overtime Holidays

OFFICE OF THE COMPTROLLER, CITY OF NEW YORK
CONSTRUCTION WORKER PREVAILING WAGE SCHEDULE

Double time the regular rate for work on the following holiday(s).

New Year's Day
Martin Luther King Jr. Day
President's Day
Memorial Day
Independence Day
Labor Day
Columbus Day
Veteran's Day
Thanksgiving Day
Christmas Day

Paid Holidays

New Year's Day
Martin Luther King Jr. Day
President's Day
Memorial Day
Independence Day
Labor Day
Columbus Day
Veteran's Day
Thanksgiving Day
Christmas Day

Shift Rates

Off shift work commencing between 6:00 P.M. and 5:00 A.M. shall work eight and one half (8 1/2) hours allowing for one half hour for lunch

Driver Redi-Mix (Sand & Gravel)

Effective Period: 7/1/2023 - 1/14/2024

Wage Rate per Hour: **\$40.89**

Supplemental Benefit Rate per Hour: **\$47.85**

Supplemental Note: Over 40 hours worked: time and one half rate \$18.68; double time rate \$24.90

Effective Period: 1/15/2024 - 6/30/2024

Wage Rate per Hour: **\$42.09**

Supplemental Benefit Rate per Hour: **\$49.31**

Supplemental Note: Over 40 hours worked: time and one half rate \$19.58; double time rate \$26.10

Overtime Description

For Paid Holidays: Employees who do not work on a contractual holiday shall be compensated two (2) hours extra pay in straight time wages and benefits for every day on which the Employee does not pass up a day's work during the calendar week (Sunday through Saturday) of the holiday, up to a maximum of ten (10) hours in wages and eight (8) hours in benefit contributions for the holiday

Overtime

Time and one half the regular rate after an 8 hour day.

Time and one half the regular rate for Saturday.

OFFICE OF THE COMPTROLLER, CITY OF NEW YORK
CONSTRUCTION WORKER PREVAILING WAGE SCHEDULE

Double time the regular rate for Sunday.

Overtime Holidays

Double time the regular rate for work on the following holiday(s).

Martin Luther King Jr. Day
President's Day
Columbus Day
Veteran's Day

Triple time the regular rate for work on the following holiday(s).

New Year's Day
Memorial Day
Independence Day
Labor Day
Thanksgiving Day
Christmas Day

Paid Holidays

New Year's Day
Martin Luther King Jr. Day
President's Day
Memorial Day
Independence Day
Labor Day
Columbus Day
Election Day
Thanksgiving Day
Christmas Day

(Local #282)

ELECTRICIAN

(Including installation of low voltage cabling carrying data, video and/or voice on building construction/alteration/renovation projects.)

Electrician "A" (Regular Day / Day Shift)

Effective Period: 7/1/2023 - 4/12/2024

Wage Rate per Hour: **\$61.00**

Supplemental Benefit Rate per Hour: **\$60.06**

* Supplemental Note: See Supplemental Benefit Rate per Hour Note below

Effective Period: 4/13/2024 - 6/30/2024

Wage Rate per Hour: **\$62.00**

Supplemental Benefit Rate per Hour: **\$62.25**

* Supplemental Note: See Supplemental Benefit Rate per Hour Note below

OFFICE OF THE COMPTROLLER, CITY OF NEW YORK
CONSTRUCTION WORKER PREVAILING WAGE SCHEDULE

Electrician "A" (Regular Day Overtime after 7 hrs / Day Shift Overtime after 8 hrs)

Effective Period: 7/1/2023 - 4/12/2024

Wage Rate per Hour: **\$91.50**

Supplemental Benefit Rate per Hour: **\$62.02**

* Supplemental Note: See Supplemental Benefit Rate per Hour Note below

Effective Period: 4/13/2024 - 6/30/2024

Wage Rate per Hour: **\$93.00**

Supplemental Benefit Rate per Hour: **\$64.24**

* Supplemental Note: See Supplemental Benefit Rate per Hour Note below

Electrician "A" (Swing Shift)

Effective Period: 7/1/2023 - 4/12/2024

Wage Rate per Hour: **\$71.57**

Supplemental Benefit Rate per Hour: **\$68.14**

* Supplemental Note: See Supplemental Benefit Rate per Hour Note below

Effective Period: 4/13/2024 - 6/30/2024

Wage Rate per Hour: **\$72.75**

Supplemental Benefit Rate per Hour: **\$70.56**

* Supplemental Note: See Supplemental Benefit Rate per Hour Note below

Electrician "A" (Swing Shift Overtime after 7.5 hours)

Effective Period: 7/1/2023 - 4/12/2024

Wage Rate per Hour: **\$107.36**

Supplemental Benefit Rate per Hour: **\$70.45**

* Supplemental Note: See Supplemental Benefit Rate per Hour Note below

Effective Period: 4/13/2024 - 6/30/2024

Wage Rate per Hour: **\$109.13**

Supplemental Benefit Rate per Hour: **\$72.91**

* Supplemental Note: See Supplemental Benefit Rate per Hour Note below

Electrician "A" (Graveyard Shift)

Effective Period: 7/1/2023 - 4/12/2024

Wage Rate per Hour: **\$80.17**

Supplemental Benefit Rate per Hour: **\$74.99**

* Supplemental Note: See Supplemental Benefit Rate per Hour Note below

Effective Period: 4/13/2024 - 6/30/2024

Wage Rate per Hour: **\$81.49**

Supplemental Benefit Rate per Hour: **\$77.61**

* Supplemental Note: See Supplemental Benefit Rate per Hour Note below

OFFICE OF THE COMPTROLLER, CITY OF NEW YORK
CONSTRUCTION WORKER PREVAILING WAGE SCHEDULE

Electrician "A" (Graveyard Shift Overtime after 7 hours)

Effective Period: 7/1/2023 - 4/12/2024

Wage Rate per Hour: **\$120.26**

Supplemental Benefit Rate per Hour: **\$77.57**

* Supplemental Note: See Supplemental Benefit Rate per Hour Note below

Effective Period: 4/13/2024 - 6/30/2024

Wage Rate per Hour: **\$122.24**

Supplemental Benefit Rate per Hour: **\$80.23**

* Supplemental Note: See Supplemental Benefit Rate per Hour Note below

* Supplemental Benefit Rate per Hour Note

In addition to the Supplemental Benefit Rates per Hour listed above, the employer must provide an additional 6.2% of taxable gross pay earned on covered work only. This additional Supplemental Benefit Rate will terminate when the employee has contributed the maximum annual Social Security tax required by law, on all work performed.

Overtime

Time and one half the regular rate after a 7 hour day.

Time and one half the regular rate for Saturday.

Time and one half the regular rate for Sunday.

Overtime Holidays

Time and one half the regular rate for work on a holiday.

New Year's Day

Martin Luther King Jr. Day

President's Day

Memorial Day

Independence Day

Labor Day

Columbus Day

Veteran's Day

Thanksgiving Day

Day after Thanksgiving

Christmas Day

Paid Holidays

None

Shift Rates

For multiple shifts of temporary light and/or power, the temporary light and/or power employee shall be paid for 8 hours at the straight time rate. For three or less workers performing 8 hours temporary light and/or power the supplemental benefit rate is \$24.36, effective 04/13/2023 the supplemental benefit rate is \$24.78 - See * Supplemental Benefit Rate per Hour Note above.

Electrician "M" (First 8 hours)

**OFFICE OF THE COMPTROLLER, CITY OF NEW YORK
CONSTRUCTION WORKER PREVAILING WAGE SCHEDULE**

"M" rated work shall be defined as jobbing: electrical work of limited duration and scope, also consisting of repairs and/or replacement of electrical and tele-data equipment. Includes all work necessary to retrofit, service, maintain and repair all kinds of lighting fixtures and local lighting controls and washing and cleaning of foregoing fixtures.

Effective Period: 7/1/2023 - 4/12/2024

Wage Rate per Hour: **\$31.25**

Supplemental Benefit Rate per Hour: **\$26.55**

First and Second Year "M" Wage Rate Per Hour: \$26.75

First and Second Year "M" Supplemental Rate: \$24.13

Effective Period: 4/13/2024 - 6/30/2024

Wage Rate per Hour: **\$32.00**

Supplemental Benefit Rate per Hour: **\$27.20**

First and Second Year "M" Wage Rate Per Hour: \$27.50

First and Second Year "M" Supplemental Rate: \$24.79

Electrician "M" (Overtime After First 8 hours)

"M" rated work shall be defined as jobbing: electrical work of limited duration and scope, also consisting of repairs and/or replacement of electrical and tele-data equipment. Includes all work necessary to retrofit, service, maintain and repair all kinds of lighting fixtures and local lighting controls and washing and cleaning of foregoing fixtures.

Effective Period: 7/1/2023 - 4/12/2024

Wage Rate per Hour: **\$46.88**

Supplemental Benefit Rate per Hour: **\$28.53**

First and Second Year "M" Wage Rate Per Hour: \$40.13

First and Second Year "M" Supplemental Rate: \$25.82

Effective Period: 4/13/2024 - 6/30/2024

Wage Rate per Hour: **\$48.00**

Supplemental Benefit Rate per Hour: **\$29.23**

First and Second Year "M" Wage Rate Per Hour: \$41.25

First and Second Year "M" Supplemental Rate: \$26.52

Overtime

Time and one half the regular rate after an 8 hour day.

Time and one half the regular rate for Saturday.

Time and one half the regular rate for Sunday.

Overtime Holidays

Time and one half the regular rate for work on the following holiday(s).

New Year's Day

Martin Luther King Jr. Day

President's Day

Memorial Day

Independence Day

Labor Day

Columbus Day

Veteran's Day

Thanksgiving Day

OFFICE OF THE COMPTROLLER, CITY OF NEW YORK
CONSTRUCTION WORKER PREVAILING WAGE SCHEDULE

Day after Thanksgiving
Christmas Day

Paid Holidays

None

(Local #3)

ELECTRICIAN - ALARM TECHNICIAN

(Scope of Work - Inspect, test, repair, and replace defective, malfunctioning, or broken devices, components and controls of Fire, Burglar and Security Systems)

Alarm Technician

Effective Period: 7/1/2023 - 3/6/2024

Wage Rate per Hour: **\$36.40**

Supplemental Benefit Rate per Hour: **\$20.67**

Supplemental Note: \$18.80 only after 8 hours worked in a day

Effective Period: 3/7/2024 - 6/30/2024

Wage Rate per Hour: **\$37.40**

Supplemental Benefit Rate per Hour: **\$21.44**

Supplemental Note: \$19.31 only after 8 hours worked in a day

Overtime Description

Time and one half the regular rate for work on the following holidays: Columbus Day, Veterans Day, Day after Thanksgiving.

Double time the regular rate for work on the following holidays: New Year's day, Martin Luther King Jr. Day, President's Day, Memorial Day, Independence Day, Labor Day, Thanksgiving Day, Christmas Day.

Overtime

Time and one half the regular rate after an 8 hour day.

Time and one half the regular rate for Saturday.

Time and one half the regular rate for Sunday.

Paid Holidays

New Year's Day

Martin Luther King Jr. Day

President's Day

Memorial Day

Independence Day

Labor Day

Columbus Day

Veteran's Day

OFFICE OF THE COMPTROLLER, CITY OF NEW YORK
CONSTRUCTION WORKER PREVAILING WAGE SCHEDULE

Thanksgiving Day
Day after Thanksgiving
Christmas Day

Shift Rates

Night Differential is based upon a ten percent (10%) differential between the hours of 4:00 P.M. and 12:30 A.M. and a fifteen percent (15%) differential for the hours 12:00 A.M. to 8:30 A.M.

Vacation

At least 1 year of employment.....ten (10) days
5 years or more of employment.....fifteen (15) days
10 years of employment.....twenty (20) days
Plus one Personal Day per year

Sick Days:
One day per Year. Up to 4 vacation days may be used as sick days.

(Local #3)

ELECTRICIAN-STREET LIGHTING WORKER

Electrician - Electro Pole Electrician

Effective Period: 7/1/2023 - 4/17/2024
Wage Rate per Hour: **\$61.00**
Supplemental Benefit Rate per Hour: **\$62.13**
* Supplemental Note: See Supplemental Benefit Rate per Hour Note below

Effective Period: 4/18/2024 - 6/30/2024
Wage Rate per Hour: **\$62.00**
Supplemental Benefit Rate per Hour: **\$62.85**
* Supplemental Note: See Supplemental Benefit Rate per Hour Note below

Electrician - Electro Pole Foundation Installer

Effective Period: 7/1/2023 - 4/17/2024
Wage Rate per Hour: **\$46.66**
Supplemental Benefit Rate per Hour: **\$47.16**
* Supplemental Note: See Supplemental Benefit Rate per Hour Note below

Effective Period: 4/18/2024 - 6/30/2024
Wage Rate per Hour: **\$47.66**
Supplemental Benefit Rate per Hour: **\$48.72**
* Supplemental Note: See Supplemental Benefit Rate per Hour Note below

Electrician - Electro Pole Maintainer

OFFICE OF THE COMPTROLLER, CITY OF NEW YORK
CONSTRUCTION WORKER PREVAILING WAGE SCHEDULE

Effective Period: 7/1/2023 - 4/17/2024

Wage Rate per Hour: **\$40.61**

Supplemental Benefit Rate per Hour: **\$42.88**

* Supplemental Note: See Supplemental Benefit Rate per Hour Note below

Effective Period: 4/18/2024 - 6/30/2024

Wage Rate per Hour: **\$41.61**

Supplemental Benefit Rate per Hour: **\$44.45**

* Supplemental Note: See Supplemental Benefit Rate per Hour Note below

* Supplemental Benefit Rate per Hour Note

In addition to the Supplemental Benefit Rates per Hour listed above, the employer must provide an additional 6.2% of taxable gross pay earned on covered work only. This additional Supplemental Benefit Rate will terminate when the employee has contributed the maximum annual Social Security tax required by law, on all work performed.

Overtime Description

Electrician - Electro Pole Electrician: Time and one half the regular rate after a 7 hour day and after 5 consecutive days worked per week.

Electrician - Electro Pole Foundation Installer: Time and one half the regular rate after 8 hours within a 24 hour period and Saturday and Sunday.

Electrician - Electro Pole Maintainer: Time and one half the regular rate after a 7 hour day and after 5 consecutive days worked per week. Saturdays and Sundays may be used as a make-up day at straight time when a day is lost during the week to inclement weather.

Overtime Holidays

Time and one half the regular rate for work on the following holiday(s).

New Year's Day

Martin Luther King Jr. Day

President's Day

Memorial Day

Independence Day

Labor Day

Columbus Day

Veteran's Day

Thanksgiving Day

Day after Thanksgiving

Christmas Day

Paid Holidays

None

(Local #3)

ELEVATOR CONSTRUCTOR

Elevator Constructor

OFFICE OF THE COMPTROLLER, CITY OF NEW YORK
CONSTRUCTION WORKER PREVAILING WAGE SCHEDULE

Effective Period: 7/1/2023 - 6/30/2024

Wage Rate per Hour: **\$77.49**

Supplemental Benefit Rate per Hour: **\$40.28**

Overtime Description

For New Construction: work performed after an 8 hour day, Saturday, Sunday or between 4:30pm and 7:00am shall be paid at double time rate.

Existing buildings: work performed after an 8 hour day, Saturday, Sunday or between 5:30pm and 7:00 am shall be paid time and one half.

Overtime

Double time the regular rate for work on the following holiday(s).

Paid Holidays

New Year's Day

President's Day

Good Friday

Memorial Day

Independence Day

Labor Day

Columbus Day

Veteran's Day

Thanksgiving Day

Day after Thanksgiving

Christmas Day

Vacation

Employer contributes 8% of regular basic hourly rate as vacation pay for employees with more than 15 years of service, and 6% for employees with 5 to 15 years of service, and 4% for employees with less than 5 years of service.

(Local #1)

ELEVATOR REPAIR & MAINTENANCE

Elevator Service/Modernization Mechanic

Effective Period: 7/1/2023 - 6/30/2024

Wage Rate per Hour: **\$60.89**

Supplemental Benefit Rate per Hour: **\$40.18**

Overtime Description

For Scheduled Service Work: Double time - work scheduled in advance by two or more workers performed on Sundays, Holidays, and between midnight and 7:00am.

OFFICE OF THE COMPTROLLER, CITY OF NEW YORK
CONSTRUCTION WORKER PREVAILING WAGE SCHEDULE

Overtime

Time and one half the regular rate after an 8 hour day.

Time and one half the regular rate for Saturday.

Time and one half the regular rate for Sunday.

Time and one half the regular rate for work on a holiday plus the day's pay.

Paid Holidays

New Year's Day

President's Day

Good Friday

Memorial Day

Independence Day

Labor Day

Columbus Day

Veteran's Day

Thanksgiving Day

Day after Thanksgiving

Christmas Day

Shift Rates

Afternoon shift - regularly hourly rate plus a (15%) fifteen percent differential. Graveyard shift - time and one half the regular rate.

Vacation

Employer contributes 8% of regular basic hourly rate as vacation pay for employees with more than 15 years of service, and 6% for employees with 5 to 15 years of service, and 4% for employees with less than 5 years of service.

(Local #1)

ENGINEER

Engineer - Heavy Construction Operating Engineer I

Cherrypickers 20 tons and over and Loaders (rubber tired and/or tractor type with a manufacturer's minimum rated capacity of six cubic yards and over).

Effective Period: 7/1/2023 - 6/30/2024

Wage Rate per Hour: **\$75.82**

Supplemental Benefit Rate per Hour: **\$46.68**

Supplemental Note: \$85.96 on overtime

Shift Wage Rate: **\$121.31**

Engineer - Heavy Construction Operating Engineer II

Backhoes, Basin Machines, Groover, Mechanical Sweepers, Bobcat, Boom Truck, Barrier Transport (Barrier Mover) & machines of similar nature. Operation of Churn Drills and machines of a similar nature, Stetco Silent Hoist and machines of similar nature, Vac-Alls, Meyers Machines, John Beam and machines of a similar nature,

**OFFICE OF THE COMPTROLLER, CITY OF NEW YORK
CONSTRUCTION WORKER PREVAILING WAGE SCHEDULE**

Ross Carriers and Travel Lifts and machines of a similar nature, Bulldozers, Scrapers and Turn-a-Pulls: Tugger Hoists (Used exclusively for handling excavated material); Tractors with attachments, Hyster and Roustabout Cranes, Cherrypickers. Austin Western, Grove and machines of a similar nature, Scoopmobiles, Monorails, Conveyors, Trenchers: Loaders-Rubber Tired and Tractor: Barber Greene and Eimco Loaders and Eimco Backhoes; Mighty Midget and similar breakers and Tampers, Curb and Gutter Pavers and Motor Patrol, Motor Graders and all machines of a similar nature. Locomotives 10 Tons or under. Mini-Max, Break-Tech and machines of a similar nature; Milling machines, robotic and demolition machines and machines of a similar nature, shot blaster, skid steer machines and machines of a similar nature including bobcat, pile rig rubber-tired excavator (37,000 lbs. and under), 2 person auger.

Effective Period: 7/1/2023 - 6/30/2024

Wage Rate per Hour: **\$73.45**

Supplemental Benefit Rate per Hour: **\$46.68**

Supplemental Note: \$85.96 on overtime

Shift Wage Rate: **\$117.52**

Engineer - Heavy Construction Operating Engineer III

Minor Equipment such as Tractors, Post Hole Diggers, Ditch Witch (Walk Behind), Road Finishing Machines, Rollers five tons and under, Tugger Hoists, Dual Purpose Trucks, Fork Lifts, and Dempsey Dumpers, Fireperson.

Effective Period: 7/1/2023 - 6/30/2024

Wage Rate per Hour: **\$69.49**

Supplemental Benefit Rate per Hour: **\$46.68**

Supplemental Note: \$85.96 on overtime

Shift Wage Rate: **\$111.18**

Engineer - Heavy Construction Maintenance Engineer I

Installing, Repairing, Maintaining, Dismantling of all equipment including Steel Cutting, Bending and Heat Sealing Machines, Mechanical Heaters, Grout Pumps, Bentonite Pumps & Plants, Screening Machines, Fusion Coupling Machines, Tunnel Boring Machines Moles and Machines of a similar nature, Power Packs, Mechanical Hydraulic Jacks; all drill rigs including but not limited to Churn, Rotary Caisson, Raised Bore & Drills of a similar nature; Personnel, Inspection & Safety Boats or any boats used to perform functions of same, Mine Hoists, Whirlies, all Climbing Cranes, all Tower Cranes, including but not limited to Truck Mounted and Crawler Type and machines of similar nature; Maintaining Hydraulic Drills and machines of a similar nature; Well Point System-Installation and dismantling; Burning, Welding, all Pumps regardless of size and/or motor power, except River Cofferdam Pumps and Wells Point Pumps; Motorized Buggies (three or more); equipment used in the cleaning and televising of sewers, but not limited to jet-rodder/vacuum truck, vacall/vactor, closed circuit television inspection equipment; high powered water pumps, jet pumps; screed machines and concrete finishing machines of a similar nature; vermeers.

Effective Period: 7/1/2023 - 6/30/2024

Wage Rate per Hour: **\$73.08**

Supplemental Benefit Rate per Hour: **\$46.68**

Supplemental Note: \$85.96 on overtime

Shift Wage Rate: **\$116.93**

Engineer - Heavy Construction Maintenance Engineer II

On Base Mounted Tower Cranes

OFFICE OF THE COMPTROLLER, CITY OF NEW YORK
CONSTRUCTION WORKER PREVAILING WAGE SCHEDULE

Effective Period: 7/1/2023 - 6/30/2024
Wage Rate per Hour: **\$97.21**
Supplemental Benefit Rate per Hour: **\$46.68**
Supplemental Note: \$85.96 on overtime
Shift Wage Rate: **\$155.54**

Engineer - Heavy Construction Maintenance Engineer III

On Generators, Light Towers

Effective Period: 7/1/2023 - 6/30/2024
Wage Rate per Hour: **\$46.89**
Supplemental Benefit Rate per Hour: **\$46.68**
Supplemental Note: \$85.96 on overtime
Shift Wage Rate: **\$75.02**

Engineer - Heavy Construction Maintenance Engineer IV

On Pumps and Mixers including mud sucking

Effective Period: 7/1/2023 - 6/30/2024
Wage Rate per Hour: **\$48.20**
Supplemental Benefit Rate per Hour: **\$46.68**
Supplemental Note: \$85.96 on overtime
Shift Wage Rate: **\$77.12**

Engineer - Heavy Construction Service Engineer

Gradalls: Concrete Pumps: Power Houses: Driving Truck Cranes: Driving and Operating Fuel and Grease Trucks.

Effective Period: 7/1/2023 - 6/30/2024
Wage Rate per Hour: **\$65.49**
Supplemental Benefit Rate per Hour: **\$46.68**
Supplemental Note: \$85.96 on overtime
Shift Wage Rate: **\$104.78**

Engineer - Heavy Construction Service Mechanic

Shovels: Cranes: Draglines: Backhoes: Keystones: Pavers: Trenching Machines: Gunite Machines: Compressors (three (3) or more in Battery): Crawler Cranes- having a straight lattice boom with no attachment or luffing boom, no jib and no auxiliary attachment.

Effective Period: 7/1/2023 - 6/30/2024
Wage Rate per Hour: **\$44.10**
Supplemental Benefit Rate per Hour: **\$46.68**
Supplemental Note: \$85.96 on overtime
Shift Wage Rate: **\$70.56**

Engineer - Steel Erection Maintenance Engineers

OFFICE OF THE COMPTROLLER, CITY OF NEW YORK
CONSTRUCTION WORKER PREVAILING WAGE SCHEDULE

Derrick, Travelers, Tower, Crawler Tower and Climbing Cranes

Effective Period: 7/1/2023 - 6/30/2024

Wage Rate per Hour: **\$70.20**

Supplemental Benefit Rate per Hour: **\$46.68**

Supplemental Note: \$85.96 on overtime

Shift Wage Rate: **\$112.32**

Engineer - Steel Erection Oiler I

On a Truck Crane

Effective Period: 7/1/2023 - 6/30/2024

Wage Rate per Hour: **\$65.46**

Supplemental Benefit Rate per Hour: **\$46.68**

Supplemental Note: \$85.96 on overtime

Shift Wage Rate: **\$104.74**

Engineer - Steel Erection Oiler II

On a Crawler Crane

Effective Period: 7/1/2023 - 6/30/2024

Wage Rate per Hour: **\$48.91**

Supplemental Benefit Rate per Hour: **\$46.68**

Supplemental Note: \$85.96 on overtime

Shift Wage Rate: **\$78.26**

Overtime Description

On jobs of more than one shift, if the next shift employee fails to report for work through any cause over which the employer has no control, the employee on duty who works the next shift continues to work at the single time rate.

Overtime

Double time the regular rate after an 8 hour day.

Double time the regular time rate for Saturday.

Double time the regular rate for Sunday.

Double time the regular rate for work on the following holiday(s).

Paid Holidays

New Year's Day

Martin Luther King Jr. Day

President's Day

Memorial Day

Independence Day

Labor Day

Columbus Day

Veteran's Day

Thanksgiving Day

Day after Thanksgiving

Christmas Day

Engineer - Building Work Maintenance Engineers I

Installing, repairing, maintaining, dismantling (of all equipment including: Steel Cutting and Bending Machines, Mechanical Heaters, Mine Hoists, Climbing Cranes, Tower Cranes, Linden Peine, Lorain, Liebherr, Mannes, or machines of a similar nature, Well Point Systems, Deep Well Pumps, Concrete Mixers with loading Device, Concrete Plants, Motor Generators when used for temporary power and lights), skid steer machines of a similar nature including bobcat.

Effective Period: 7/1/2023 - 6/30/2024

Wage Rate per Hour: **\$63.51**

Supplemental Benefit Rate per Hour: **\$45.77**

Supplemental Note: \$84.14 on overtime

Engineer - Building Work Maintenance Engineers II

On Pumps, Generators, Mixers and Heaters

Effective Period: 7/1/2023 - 6/30/2024

Wage Rate per Hour: **\$48.46**

Supplemental Benefit Rate per Hour: **\$45.77**

Supplemental Note: \$84.14 on overtime

Engineer - Building Work Oilers I

All gasoline, electric, diesel or air operated Gradealls: Concrete Pumps, Overhead Cranes in Power Houses: Their duties shall be to assist the Engineer in oiling, greasing and repairing of all machines; Driving Truck Cranes: Driving and Operating Fuel and Grease Trucks, Cherrypickers (hydraulic cranes) over 70,000 GVW, and machines of a similar nature.

Effective Period: 7/1/2023 - 6/30/2024

Wage Rate per Hour: **\$60.19**

Supplemental Benefit Rate per Hour: **\$45.77**

Supplemental Note: \$84.14 on overtime

Engineer - Building Work Oilers II

Oilers on Crawler Cranes, Backhoes, Trenching Machines, Guniting Machines, Compressors (three or more in Battery).

Effective Period: 7/1/2023 - 6/30/2024

Wage Rate per Hour: **\$44.93**

Supplemental Benefit Rate per Hour: **\$45.77**

Supplemental Note: \$84.14 on overtime

Overtime Description

On jobs of more than one shift, if an Employee fails to report for work through any cause over which the Employer has no control, the Employee on duty will continue to work at the rate of single time.

OFFICE OF THE COMPTROLLER, CITY OF NEW YORK
CONSTRUCTION WORKER PREVAILING WAGE SCHEDULE

Overtime

Double time the regular rate after an 8 hour day.
Double time the regular time rate for Saturday.
Double time the regular rate for Sunday.
Double time the regular rate for work on the following holiday(s).

Paid Holidays

New Year's Day
Martin Luther King Jr. Day
President's Day
Memorial Day
Independence Day
Labor Day
Columbus Day
Veteran's Day
Thanksgiving Day
Christmas Day

Shift Rates

When two (2) or more shifts are employed, single time will be paid for each shift.

(Local #15)

ENGINEER - CITY SURVEYOR AND CONSULTANT

Party Chief

Effective Period: 7/1/2023 - 6/30/2024

Wage Rate per Hour: **\$42.78**

Supplemental Benefit Rate per Hour: **\$27.76**

Supplemental Note: Overtime Benefit Rate - \$33.27 per hour (time & one half) \$38.77 per hour (double time).

Instrument Person

Effective Period: 7/1/2023 - 6/30/2024

Wage Rate per Hour: **\$34.64**

Supplemental Benefit Rate per Hour: **\$27.76**

Supplemental Note: Overtime Benefit Rate - \$33.27 per hour (time & one half) \$38.77 per hour (double time).

Rodperson

Effective Period: 7/1/2023 - 6/30/2024

Wage Rate per Hour: **\$29.50**

Supplemental Benefit Rate per Hour: **\$27.76**

Supplemental Note: Overtime Benefit Rate - \$33.27 per hour (time & one half) \$38.77 per hour (double time).

OFFICE OF THE COMPTROLLER, CITY OF NEW YORK
CONSTRUCTION WORKER PREVAILING WAGE SCHEDULE

Overtime Description

Time and one half the regular rate after an 8 hour day, Time and one half the regular rate for Saturday for the first eight hours worked, Double time the regular time rate for Saturday for work performed in excess of eight hours, Double time the regular rate for Sunday and Double time the regular rate for work on a holiday.

Paid Holidays

New Year's Day
Lincoln's Birthday
President's Day
Memorial Day
Independence Day
Labor Day
Columbus Day
Veteran's Day
Thanksgiving Day
Day after Thanksgiving
Christmas Day

Employees must work at least one day in the payroll week in which the holiday occurs to receive the paid holiday

(Operating Engineer Local #15-D)

ENGINEER - FIELD (BUILDING CONSTRUCTION) (Construction of Building Projects, Concrete Superstructures, etc.)

Field Engineer - BC Party Chief

Effective Period: 7/1/2023 - 6/30/2024

Wage Rate per Hour: **\$66.83**

Supplemental Benefit Rate per Hour: **\$42.39**

Supplemental Note: Overtime Benefit Rate - \$59.89 per hour (time & one half) \$77.38 per hour (double time).

Field Engineer - BC Instrument Person

Effective Period: 7/1/2023 - 6/30/2024

Wage Rate per Hour: **\$49.67**

Supplemental Benefit Rate per Hour: **\$42.39**

Supplemental Note: Overtime Benefit Rate - \$59.89 per hour (time & one half) \$77.38 per hour (double time).

Field Engineer - BC Rodperson

Effective Period: 7/1/2023 - 6/30/2024

Wage Rate per Hour: **\$30.60**

Supplemental Benefit Rate per Hour: **\$42.39**

Supplemental Note: Overtime Benefit Rate - \$59.89 per hour (time & one half) \$77.38 per hour (double time).

OFFICE OF THE COMPTROLLER, CITY OF NEW YORK
CONSTRUCTION WORKER PREVAILING WAGE SCHEDULE

Overtime Description

Time and one half the regular rate after a 7 hour work and time and one half the regular rate for Saturday for the first seven hours worked, Double time the regular time rate for Saturday for work performed in excess of seven hours, Double time the regular rate for Sunday and Double time the regular rate for work on a holiday.

Paid Holidays

New Year's Day
President's Day
Good Friday
Memorial Day
Independence Day
Labor Day
Columbus Day
Veteran's Day
Thanksgiving Day
Christmas Day

Employees must work at least one day in the payroll week in which the holiday occurs to receive the paid holiday

(Operating Engineer Local #15-D)

ENGINEER - FIELD (HEAVY CONSTRUCTION)

(Construction of Roads, Tunnels, Bridges, Sewers, Building Foundations, Engineering Structures etc.)

Field Engineer - HC Party Chief

Effective Period: 7/1/2023 - 6/30/2024

Wage Rate per Hour: **\$77.94**

Supplemental Benefit Rate per Hour: **\$44.82**

Supplemental Note: Overtime benefit rate - \$63.41 per hour (time & one half), \$82.00 per hour (double time).

Field Engineer - HC Instrument Person

Effective Period: 7/1/2023 - 6/30/2024

Wage Rate per Hour: **\$56.07**

Supplemental Benefit Rate per Hour: **\$44.82**

Supplemental Note: Overtime benefit rate - \$63.41 per hour (time & one half), \$82.00 per hour (double time).

Field Engineer - HC Rodperson

Effective Period: 7/1/2023 - 6/30/2024

Wage Rate per Hour: **\$46.34**

Supplemental Benefit Rate per Hour: **\$44.82**

OFFICE OF THE COMPTROLLER, CITY OF NEW YORK
CONSTRUCTION WORKER PREVAILING WAGE SCHEDULE

Supplemental Note: Overtime benefit rate - \$63.41 per hour (time & one half), \$82.00 per hour (double time).

Overtime Description

Time and one half the regular rate after an 8 hour day, Time and one half the regular rate for Saturday for the first eight hours worked, Double time the regular time rate for Saturday for work performed in excess of eight hours, Double time the regular rate for Sunday and Double time the regular rate for work on a holiday.

Paid Holidays

New Year's Day
Martin Luther King Jr. Day
President's Day
Memorial Day
Independence Day
Labor Day
Columbus Day
Veteran's Day
Thanksgiving Day
Christmas Day

Employees must work at least one day in the payroll week in which the holiday occurs to receive the paid holiday

(Operating Engineer Local #15-D)

ENGINEER - FIELD (STEEL ERECTION)

Field Engineer - Steel Erection Party Chief

Effective Period: 7/1/2023 - 6/30/2024

Wage Rate per Hour: **\$72.66**

Supplemental Benefit Rate per Hour: **\$44.37**

Supplemental Note: Overtime benefit rate - \$62.73 per hour (time & one half), \$81.09 per hour (double time).

Field Engineer - Steel Erection Instrument Person

Effective Period: 7/1/2023 - 6/30/2024

Wage Rate per Hour: **\$55.67**

Supplemental Benefit Rate per Hour: **\$44.37**

Supplemental Note: Overtime benefit rate - \$62.73 per hour (time & one half), \$81.09 per hour (double time).

Field Engineer - Steel Erection Rodperson

Effective Period: 7/1/2023 - 6/30/2024

Wage Rate per Hour: **\$35.79**

Supplemental Benefit Rate per Hour: **\$44.37**

Supplemental Note: Overtime benefit rate - \$62.73 per hour (time & one half), \$81.09 per hour (double time).

Overtime Description

OFFICE OF THE COMPTROLLER, CITY OF NEW YORK
CONSTRUCTION WORKER PREVAILING WAGE SCHEDULE

Time and one half the regular rate for Saturday for the first eight hours worked.
Double time the regular rate for Saturday for work performed in excess of eight hours.

Overtime

Time and one half the regular rate after an 8 hour day.
Double time the regular rate for Sunday.
Double time the regular rate for work on the following holiday(s).

Paid Holidays

New Year's Day
Lincoln's Birthday
President's Day
Memorial Day
Independence Day
Labor Day
Columbus Day
Veteran's Day
Thanksgiving Day
Christmas Day

Employees must work at least one day in the payroll week in which the holiday occurs to receive the paid holiday

(Operating Engineer Local #15-D)

ENGINEER - OPERATING

Operating Engineer - Road & Heavy Construction I

Back Filling Machines, Cranes, Mucking Machines and Dual Drum Paver.

Effective Period: 7/1/2023 - 6/30/2024

Wage Rate per Hour: **\$90.59**

Supplemental Benefit Rate per Hour: **\$36.05**

Supplemental Note: \$65.90 overtime hours

Shift Wage Rate: **\$144.94**

Operating Engineer - Road & Heavy Construction II

Backhoes, Power Shovels, Hydraulic Clam Shells, Steel Erection, Moles and machines of a similar nature.

Effective Period: 7/1/2023 - 6/30/2024

Wage Rate per Hour: **\$93.75**

Supplemental Benefit Rate per Hour: **\$36.05**

Supplemental Note: \$65.90 overtime hours

Shift Wage Rate: **\$150.00**

Operating Engineer - Road & Heavy Construction III

OFFICE OF THE COMPTROLLER, CITY OF NEW YORK
CONSTRUCTION WORKER PREVAILING WAGE SCHEDULE

Mine Hoists (Cranes, etc. when used as Mine Hoists)

Effective Period: 7/1/2023 - 6/30/2024

Wage Rate per Hour: **\$96.73**

Supplemental Benefit Rate per Hour: **\$36.05**

Supplemental Note: \$65.90 overtime hours

Shift Wage Rate: **\$154.77**

Operating Engineer - Road & Heavy Construction IV

Gradealls, Keystones, Cranes on land or water (with digging buckets), Bridge Cranes, Vermeer Cutter and machines of a similar nature, Trenching Machines.

Effective Period: 7/1/2023 - 6/30/2024

Wage Rate per Hour: **\$94.42**

Supplemental Benefit Rate per Hour: **\$36.05**

Supplemental Note: \$65.90 overtime hours

Shift Wage Rate: **\$151.07**

Operating Engineer - Road & Heavy Construction V

Pile Drivers & Rigs (working alongside Dock Builder foreperson): Derrick Boats, Tunnel Shovels.

Effective Period: 7/1/2023 - 6/30/2024

Wage Rate per Hour: **\$92.58**

Supplemental Benefit Rate per Hour: **\$36.05**

Supplemental Note: \$65.90 overtime hours

Shift Wage Rate: **\$148.13**

Operating Engineer - Road & Heavy Construction VI

Mixers (Concrete with loading attachment), Concrete Pavers, Cableways, Land Derricks, Power Houses (Low Air Pressure Units).

Effective Period: 7/1/2023 - 6/30/2024

Wage Rate per Hour: **\$88.01**

Supplemental Benefit Rate per Hour: **\$36.05**

Supplemental Note: \$65.90 overtime hours

Shift Wage Rate: **\$140.82**

Operating Engineer - Road & Heavy Construction VII

Barrier Movers, Barrier Transport and Machines of a Similar Nature.

Effective Period: 7/1/2023 - 6/30/2024

Wage Rate per Hour: **\$71.33**

Supplemental Benefit Rate per Hour: **\$36.05**

Supplemental Note: \$65.90 overtime hours

Shift Wage Rate: **\$114.13**

OFFICE OF THE COMPTROLLER, CITY OF NEW YORK
CONSTRUCTION WORKER PREVAILING WAGE SCHEDULE

Operating Engineer - Road & Heavy Construction VIII

Utility Compressors

Effective Period: 7/1/2023 - 6/30/2024

Wage Rate per Hour: **\$55.65**

Supplemental Benefit Rate per Hour: **\$36.05**

Supplemental Note: \$65.90 overtime hours

Shift Wage Rate: **\$69.81**

Operating Engineer - Road & Heavy Construction IX

Horizontal Boring Rig

Effective Period: 7/1/2023 - 6/30/2024

Wage Rate per Hour: **\$83.78**

Supplemental Benefit Rate per Hour: **\$36.05**

Supplemental Note: \$65.90 overtime hours

Shift Wage Rate: **\$134.05**

Operating Engineer - Road & Heavy Construction X

Elevators (manually operated as personnel hoist).

Effective Period: 7/1/2023 - 6/30/2024

Wage Rate per Hour: **\$77.11**

Supplemental Benefit Rate per Hour: **\$36.05**

Supplemental Note: \$65.90 overtime hours

Shift Wage Rate: **\$123.38**

Operating Engineer - Road & Heavy Construction XI

Compressors (Portable 3 or more in battery), Driving of Truck Mounted Compressors, Well-point Pumps, Tugger Machines Well Point Pumps, Churn Drill.

Effective Period: 7/1/2023 - 6/30/2024

Wage Rate per Hour: **\$60.16**

Supplemental Benefit Rate per Hour: **\$36.05**

Supplemental Note: \$65.90 overtime hours

Shift Wage Rate: **\$96.26**

Operating Engineer - Road & Heavy Construction XII

All Drills and Machines of a similar nature.

Effective Period: 7/1/2023 - 6/30/2024

Wage Rate per Hour: **\$88.94**

Supplemental Benefit Rate per Hour: **\$36.05**

Supplemental Note: \$65.90 overtime hours

OFFICE OF THE COMPTROLLER, CITY OF NEW YORK
CONSTRUCTION WORKER PREVAILING WAGE SCHEDULE

Shift Wage Rate: **\$142.30**

Operating Engineer - Road & Heavy Construction XIII

Concrete Pumps, Concrete Plant, Stone Crushers, Double Drum Hoist, Power Houses (other than above).

Effective Period: 7/1/2023 - 6/30/2024

Wage Rate per Hour: **\$86.19**

Supplemental Benefit Rate per Hour: **\$36.05**

Supplemental Note: **\$65.90** overtime hours

Shift Wage Rate: **\$137.90**

Operating Engineer - Road & Heavy Construction XIV

Concrete Mixer

Effective Period: 7/1/2023 - 6/30/2024

Wage Rate per Hour: **\$82.44**

Supplemental Benefit Rate per Hour: **\$36.05**

Supplemental Note: **\$65.90** overtime hours

Shift Wage Rate: **\$131.90**

Operating Engineer - Road & Heavy Construction XV

Compressors (Portable Single or two in Battery, not over 100 feet apart), Pumps (River Cofferdam) and Welding Machines, Push Button Machines, All Engines Irrespective of Power (Power-Pac) used to drive auxiliary equipment, Air, Hydraulic, etc.

Effective Period: 7/1/2023 - 6/30/2024

Wage Rate per Hour: **\$56.01**

Supplemental Benefit Rate per Hour: **\$36.05**

Supplemental Note: **\$65.90** overtime hours

Shift Wage Rate: **\$89.62**

Operating Engineer - Road & Heavy Construction XVI

Concrete Breaking Machines, Hoists (Single Drum), Load Masters, Locomotives (over ten tons) and Dinkies over ten tons, Hydraulic Crane-Second Engineer.

Effective Period: 7/1/2023 - 6/30/2024

Wage Rate per Hour: **\$78.79**

Supplemental Benefit Rate per Hour: **\$36.05**

Supplemental Note: **\$65.90** overtime hours

Shift Wage Rate: **\$126.06**

Operating Engineer - Road & Heavy Construction XVII

On-Site concrete plant engineer, On-site Asphalt Plant Engineer, and Vibratory console.

Effective Period: 7/1/2023 - 6/30/2024

OFFICE OF THE COMPTROLLER, CITY OF NEW YORK
CONSTRUCTION WORKER PREVAILING WAGE SCHEDULE

Wage Rate per Hour: **\$79.36**
Supplemental Benefit Rate per Hour: **\$36.05**
Supplemental Note: \$65.90 overtime hours
Shift Wage Rate: **\$126.98**

Operating Engineer - Road & Heavy Construction XVIII

Tower Crane

Effective Period: 7/1/2023 - 6/30/2024
Wage Rate per Hour: **\$113.37**
Supplemental Benefit Rate per Hour: **\$36.05**
Supplemental Note: \$65.90 overtime hours
Shift Wage Rate: **\$181.39**

Operating Engineer - Paving I

Asphalt Spreaders, Autogrades (C.M.I.), Roto/Mil

Effective Period: 7/1/2023 - 6/30/2024
Wage Rate per Hour: **\$88.01**
Supplemental Benefit Rate per Hour: **\$36.05**
Supplemental Note: \$65.90 overtime hours
Shift Wage Rate: **\$140.82**

Operating Engineer - Paving II

Asphalt Roller

Effective Period: 7/1/2023 - 6/30/2024
Wage Rate per Hour: **\$85.79**
Supplemental Benefit Rate per Hour: **\$36.05**
Supplemental Note: \$65.90 overtime hours
Shift Wage Rate: **\$137.26**

Operating Engineer - Paving III

Asphalt Plants

Effective Period: 7/1/2023 - 6/30/2024
Wage Rate per Hour: **\$72.72**
Supplemental Benefit Rate per Hour: **\$36.05**
Supplemental Note: \$65.90 overtime hours
Shift Wage Rate: **\$116.35**

Operating Engineer - Concrete I

Cranes

OFFICE OF THE COMPTROLLER, CITY OF NEW YORK
CONSTRUCTION WORKER PREVAILING WAGE SCHEDULE

Effective Period: 7/1/2023 - 6/30/2024

Wage Rate per Hour: **\$94.01**

Supplemental Benefit Rate per Hour: **\$36.05**

Supplemental Note: \$65.90 overtime hours

Operating Engineer - Concrete II

Compressors

Effective Period: 7/1/2023 - 6/30/2024

Wage Rate per Hour: **\$56.43**

Supplemental Benefit Rate per Hour: **\$36.05**

Supplemental Note: \$65.90 overtime hours

Operating Engineer - Concrete III

Micro-traps (Negative Air Machines), Vac-All Remediation System.

Effective Period: 7/1/2023 - 6/30/2024

Wage Rate per Hour: **\$75.37**

Supplemental Benefit Rate per Hour: **\$36.05**

Supplemental Note: \$65.90 overtime hours

Operating Engineer - Steel Erection I

Three Drum Derricks

Effective Period: 7/1/2023 - 6/30/2024

Wage Rate per Hour: **\$97.68**

Supplemental Benefit Rate per Hour: **\$36.05**

Supplemental Note: \$65.90 overtime hours

Shift Wage Rate: **\$156.29**

Operating Engineer - Steel Erection II

Cranes, 2 Drum Derricks, Hydraulic Cranes, Fork Lifts and Boom Trucks.

Effective Period: 7/1/2023 - 6/30/2024

Wage Rate per Hour: **\$93.89**

Supplemental Benefit Rate per Hour: **\$36.05**

Supplemental Note: \$65.90 overtime hours

Shift Wage Rate: **\$150.22**

Operating Engineer - Steel Erection III

Compressors, Welding Machines.

Effective Period: 7/1/2023 - 6/30/2024

Wage Rate per Hour: **\$56.29**

Supplemental Benefit Rate per Hour: **\$36.05**

OFFICE OF THE COMPTROLLER, CITY OF NEW YORK
CONSTRUCTION WORKER PREVAILING WAGE SCHEDULE

Supplemental Note: \$65.90 overtime hours
Shift Wage Rate: \$90.06

Operating Engineer - Steel Erection IV

Compressors - Not Combined with Welding Machine. (Public Works Only)

Effective Period: 7/1/2023 - 6/30/2024
Wage Rate per Hour: \$53.64
Supplemental Benefit Rate per Hour: \$36.05
Supplemental Note: \$65.90 overtime hours
Shift Wage Rate: \$85.82

Operating Engineer - Building Work I

Forklifts, Plaster (Platform machine), Plaster Bucket, Concrete Pump and all other equipment used for hoisting material.

Effective Period: 7/1/2023 - 6/30/2024
Wage Rate per Hour: \$73.47
Supplemental Benefit Rate per Hour: \$36.05
Supplemental Note: \$65.90 overtime hours

Operating Engineer - Building Work II

Compressors, Welding Machines (Cutting Concrete-Tank Work), Paint Spraying, Sandblasting, Pumps (with the exclusion of Concrete Pumps), All Engines irrespective of Power (Power-Pac) used to drive Auxiliary Equipment, Air, Hydraulic, Jacking System, etc.

Effective Period: 7/1/2023 - 6/30/2024
Wage Rate per Hour: \$55.13
Supplemental Benefit Rate per Hour: \$36.05
Supplemental Note: \$65.90 overtime hours

Operating Engineer - Building Work III

Double Drum

Effective Period: 7/1/2023 - 6/30/2024
Wage Rate per Hour: \$89.09
Supplemental Benefit Rate per Hour: \$36.05
Supplemental Note: \$65.90 overtime hours

Operating Engineer - Building Work IV

Stone Derrick, Cranes, Hydraulic Cranes Boom Trucks.

Effective Period: 7/1/2023 - 6/30/2024
Wage Rate per Hour: \$94.30
Supplemental Benefit Rate per Hour: \$36.05

OFFICE OF THE COMPTROLLER, CITY OF NEW YORK
CONSTRUCTION WORKER PREVAILING WAGE SCHEDULE

Supplemental Note: \$65.90 overtime hours

Operating Engineer - Building Work V

Dismantling and Erection of Cranes, Relief Engineer.

Effective Period: 7/1/2023 - 6/30/2024

Wage Rate per Hour: **\$81.57**

Supplemental Benefit Rate per Hour: **\$36.05**

Supplemental Note: \$65.90 overtime hours

Operating Engineer - Building Work VI

4 Pole Hoist, Single Drum Hoists.

Effective Period: 7/1/2023 - 6/30/2024

Wage Rate per Hour: **\$80.71**

Supplemental Benefit Rate per Hour: **\$36.05**

Supplemental Note: \$65.90 overtime hours

Operating Engineer - Building Work VII

Rack & Pinion and House Cars

Effective Period: 7/1/2023 - 6/30/2024

Wage Rate per Hour: **\$64.28**

Supplemental Benefit Rate per Hour: **\$36.05**

Supplemental Note: \$65.90 overtime hours

For New House Car projects Wage Rate per Hour **\$51.40**

For New House Car projects: Supplemental Benefit overtime hours: **\$50.98**

Overtime Description

On jobs of more than one shift, if an Employee fails to report for work through any cause over which the Employer has no control, the Employee on duty will continue to work at the rate of single time.

For House Cars and Rack & Pinion only: Overtime paid at time and one-half for all hours in excess of eight hours in a day, Saturday, Sunday and Holidays worked.

Overtime

Double time the regular rate after an 8 hour day.

Double time the regular time rate for Saturday.

Double time the regular rate for Sunday.

Double time the regular rate for work on the following holiday(s).

Paid Holidays

New Year's Day

Martin Luther King Jr. Day

President's Day

Memorial Day

Independence Day

Labor Day

OFFICE OF THE COMPTROLLER, CITY OF NEW YORK
CONSTRUCTION WORKER PREVAILING WAGE SCHEDULE

Columbus Day
Veteran's Day
Thanksgiving Day
Day after Thanksgiving
Christmas Day

Shift Rates

When two (2) or more shifts are employed, single time will be paid for each shift.

For Steel Erection Only: Shifts may be worked at the single time rate at other than the regular working hours (8:00 A.M. to 4:30 P.M.) on the following work ONLY: Heavy construction jobs on work below the street level, over railroad tracks and on building jobs.

(Operating Engineer Local #14)

FLOOR COVERER

(Interior vinyl composition tile, sheath vinyl linoleum and wood parquet tile including site preparation and synthetic turf not including site preparation)

Floor Coverer

Effective Period: 7/1/2023 - 6/30/2024

Wage Rate per Hour: **\$55.05**

Supplemental Benefit Rate per Hour: **\$47.88**

Overtime

Time and one half the regular rate after an 8 hour day.

Time and one half the regular rate for Saturday.

Double time the regular rate for Sunday.

Saturday may be used as a make-up day at straight time when a day is lost during that week to inclement weather.

Overtime Holidays

Double time the regular rate for work on the following holiday(s).

New Year's Day

President's Day

Memorial Day

Independence Day

Labor Day

Columbus Day

Presidential Election Day

Thanksgiving Day

Day after Thanksgiving

Day before Christmas

Christmas Day

Day before New Year's Day

OFFICE OF THE COMPTROLLER, CITY OF NEW YORK
CONSTRUCTION WORKER PREVAILING WAGE SCHEDULE

Shift Rates

Two shifts may be utilized with the first shift working 8 a.m. to the end of the shift at straight time rate of pay. The wage rate for the second shift consisting of 7 hours shall be paid at 114.29% of straight time wage rate. The wage rate for the second shift consisting of 8 hours shall be paid 112.5% of the straight time wage rate. When it is not possible to conduct alteration or repair work during regular working hours in a building occupied by tenants, the rule for the second shift will apply.

(Carpenters District Council)

GLAZIER

(New Construction, Remodeling, and Alteration)

Glazier

Effective Period: 7/1/2023 - 6/30/2024

Wage Rate per Hour: **\$47.95**

Supplemental Benefit Rate per Hour: **\$53.34**

Overtime

Time and one half the regular rate after an 8 hour day.

Time and one half the regular rate for Saturday.

Time and one half the regular rate for Sunday.

Overtime Holidays

Time and one half the regular rate for work on the following holiday(s).

New Year's Day

President's Day

Memorial Day

Independence Day

Thanksgiving Day

Day after Thanksgiving

Christmas Day

Paid Holidays

None

Shift Rates

Shifts shall be any 8 consecutive hours after the normal working day for which the Glazier shall receive 9 hours pay for 8 hours worked.

(Local #1281)

GLAZIER - REPAIR & MAINTENANCE

(For the Installation of Glass - All repair and maintenance work on a particular building.)

Craft Jurisdiction for repair, maintenance and fabrication

Plate glass replacement, Storm windows and storm doors, Herculite door repairs, Door closer repairs, Glass tinting.

Effective Period: 7/1/2023 - 6/30/2024

Wage Rate per Hour: **\$27.05**

Supplemental Benefit Rate per Hour: **\$26.50**

Overtime

Time and one half the regular rate after an 8 hour day.

Time and one half the regular rate for Sunday.

Time and one half the regular rate for work on the following holiday(s).

Time and one half the regular hourly rate after 40 straight time hours in any work week.

Paid Holidays

New Year's Day

President's Day

Memorial Day

Independence Day

Labor Day

Thanksgiving Day

Day after Thanksgiving

Christmas Day

Employees must work at least one day in the payroll week in which the holiday occurs to receive the paid holiday

(Local #1281)

HAZARDOUS MATERIAL HANDLER

(Removal, abatement, encapsulation or decontamination of asbestos, lead, mold, or other toxic or hazardous waste/materials)

Handler

Effective Period: 7/1/2023 - 1/14/2024

Wage Rate per Hour: **\$38.55**

Supplemental Benefit Rate per Hour: **\$20.60**

OFFICE OF THE COMPTROLLER, CITY OF NEW YORK
CONSTRUCTION WORKER PREVAILING WAGE SCHEDULE

Effective Period: 1/15/2024 - 6/30/2024

Wage Rate per Hour: **\$39.00**

Supplemental Benefit Rate per Hour: **\$21.30**

Overtime

Time and one half the regular rate after an 8 hour day.

Time and one half the regular rate for Sunday.

Time and one half the regular hourly rate after 40 straight time hours in any work week.

Overtime Holidays

Time and one half the regular rate for work on the following holiday(s).

New Year's Day

Good Friday

Memorial Day

Independence Day

Labor Day

Thanksgiving Day

Christmas Day

Easter

Paid Holidays

None

(Local #78 and Local #12A)

HEAT AND FROST INSULATOR

Heat & Frost Insulator

Effective Period: 7/1/2023 - 6/30/2024

Wage Rate per Hour: **\$69.96**

Supplemental Benefit Rate per Hour: **\$35.76**

Overtime Description

Premium rate shall be paid for supplemental benefits during overtime work.

Overtime

Time and one half the regular rate after an 8 hour day.

Time and one half the regular rate for Saturday.

Double time the regular rate for Sunday.

Overtime Holidays

Double time the regular rate for work on the following holiday(s).

New Year's Day

Martin Luther King Jr. Day

President's Day

OFFICE OF THE COMPTROLLER, CITY OF NEW YORK
CONSTRUCTION WORKER PREVAILING WAGE SCHEDULE

Memorial Day
Independence Day
Columbus Day
Veteran's Day
Thanksgiving Day
Day after Thanksgiving
Christmas Day

Triple time the regular rate for work on the following holiday(s).
Labor Day

Paid Holidays

None

Shift Rates

The first shift shall work seven hours at the regular straight time rate. The second and third shift shall work seven hours the regular straight time hourly rate plus a fourteen percent wage and benefit premium. There must be a first shift to work the second shift, and a second shift to work the third shift. Off-hour jobs in occupied buildings may be worked on weekdays with an increment of one-dollar (\$1.00) per hour and eight (8) hours pay for seven (7) hours worked.

(Local #12) (BCA)

HOUSE WRECKER (TOTAL DEMOLITION)

House Wrecker - Tier A

On all work sites the first, second, eleventh and every third House Wrecker thereafter will be Tier A House Wreckers (i.e. 1st, 2nd, 11th, 14th etc). Other House Wreckers may be Tier B House Wreckers.

Effective Period: 7/1/2023 - 1/14/2024

Wage Rate per Hour: **\$38.93**

Supplemental Benefit Rate per Hour: **\$31.27**

Effective Period: 1/15/2024 - 6/30/2024

Wage Rate per Hour: **\$39.23**

Supplemental Benefit Rate per Hour: **\$31.57**

House Wrecker - Tier B

Effective Period: 7/1/2023 - 1/14/2024

Wage Rate per Hour: **\$28.16**

Supplemental Benefit Rate per Hour: **\$23.68**

OFFICE OF THE COMPTROLLER, CITY OF NEW YORK
CONSTRUCTION WORKER PREVAILING WAGE SCHEDULE

Effective Period: 1/15/2024 - 6/30/2024

Wage Rate per Hour: **\$28.46**

Supplemental Benefit Rate per Hour: **\$23.98**

Overtime

Time and one half the regular rate after an 8 hour day.

Time and one half the regular rate for Saturday.

Double time the regular rate for Sunday.

Overtime Holidays

Double time the regular rate for work on the following holiday(s).

New Year's Day

President's Day

Memorial Day

Independence Day

Labor Day

Thanksgiving Day

Christmas Day

Paid Holidays

None

(Mason Tenders District Council)

IRON WORKER - ORNAMENTAL

Iron Worker - Ornamental

Effective Period: 7/1/2023 - 1/14/2024

Wage Rate per Hour: **\$47.15**

Supplemental Benefit Rate per Hour: **\$63.75**

Supplemental Note: Supplemental benefits are to be paid at the applicable overtime rate when overtime is in effect.

Effective Period: 1/15/2024 - 6/30/2024

Wage Rate per Hour: **\$47.40**

Supplemental Benefit Rate per Hour: **\$64.75**

Supplemental Note: Supplemental benefits are to be paid at the applicable overtime rate when overtime is in effect.

Overtime Description

Time and one half the regular rate after a 7 hour day for a maximum of two hours on any regular work day (the 8th and 9th hour) and double time shall be paid for all work on a regular work day thereafter. Time and one half the regular rate for Saturday for the first seven hours of work and double time should be paid for all work on a Saturday thereafter. Four (4), ten (10) hour days may be worked at straight time, Monday to Thursday.

OFFICE OF THE COMPTROLLER, CITY OF NEW YORK
CONSTRUCTION WORKER PREVAILING WAGE SCHEDULE

Overtime

Double time the regular rate for Sunday.

Overtime Holidays

Double time the regular rate for work on the following holiday(s).

New Year's Day

President's Day

Memorial Day

Independence Day

Labor Day

Thanksgiving Day

Christmas Day

Paid Holidays

None

Shift Rates

When two or three shifts are employed on a job, Monday through Friday, each shift will be paid eight (8) hours at the straight time rate for eight (8) hours of work; at time and one-half the regular straight time rate for the first two (2) hours of overtime worked beyond eight (8) hours; and at double time for all work thereafter. When it is not possible to conduct alteration or repair work during regular working hours in a building occupied by tenants, eight (8) hours will be paid at straight time rate for seven (7) hours of work, and all overtime shall be paid at time and one-half the regular straight time rates. On Saturday, Sundays and Holidays, time and one-half the regular straight time rate shall be paid for all work up to seven (7) hours and double time shall be paid for all work thereafter.

(Local #580)

IRON WORKER - STRUCTURAL

Iron Worker - Structural

Effective Period: 7/1/2023 - 1/14/2024

Wage Rate per Hour: **\$57.20**

Supplemental Benefit Rate per Hour: **\$86.77**

Supplemental Note: Supplemental benefits are to be paid at the applicable overtime rate when overtime is in effect.

Effective Period: 1/15/2024 - 6/30/2024

Wage Rate per Hour: **\$57.70**

Supplemental Benefit Rate per Hour: **\$88.02**

Supplemental Note: Supplemental benefits are to be paid at the applicable overtime rate when overtime is in effect.

Overtime Description

OFFICE OF THE COMPTROLLER, CITY OF NEW YORK
CONSTRUCTION WORKER PREVAILING WAGE SCHEDULE

Monday through Friday- the first eight hours are paid at straight time, the 9th and 10th hours are paid at time and one-half the regular rate, all additional weekday overtime is paid at double the regular rate. Saturdays- the first eight hours are paid at time and one-half the regular rate, double time thereafter. Sunday-all shifts are paid at double time. Four Days a week at Ten (10) hours straight time is allowed.

Overtime

Time and one half the regular rate after an 8 hour day.
Time and one half the regular rate for Saturday.
Double time the regular rate for Sunday.

Overtime Holidays

Double time the regular rate for work on the following holiday(s).

New Year's Day
President's Day
Memorial Day
Independence Day
Labor Day
Thanksgiving Day
Christmas Day

Paid Holidays

1/2 day on Christmas Eve if work is performed in the A.M.
1/2 day on New Year's Eve if work is performed in the A.M.

Shift Rates

Monday through Friday - First Shift: First eight hours are paid at straight time, the 9th & 10th hours are paid at time and a half, double time paid thereafter. Second and third Shifts: First eight hours are paid at time and one-half, double time thereafter. Saturdays: All shifts, first eight hours paid at time and one-half, double time thereafter: Sunday all shifts are paid at double time.

Four (4), ten (10) hour days may be worked at straight time during a week, Monday thru Thursday.

(Local #40 & #361)

LABORER

(Foundation, Concrete, Excavating, Street Pipe Layer and Common)

Laborer

Excavation and foundation work for buildings, heavy construction, engineering work, and hazardous waste removal in connection with the above work. Landscaping tasks in connection with heavy construction work, engineering work and building projects. Projects include, but are not limited to pollution plants, sewers, parks, subways, bridges, highways, etc.

Effective Period: 7/1/2023 - 6/30/2024

Wage Rate per Hour: **\$44.50**

OFFICE OF THE COMPTROLLER, CITY OF NEW YORK
CONSTRUCTION WORKER PREVAILING WAGE SCHEDULE

Supplemental Benefit Rate per Hour: **\$52.23**

Overtime

Time and one half the regular rate after an 8 hour day.
Time and one half the regular rate for Saturday.
Double time the regular rate for Sunday.

Overtime Holidays

Double time the regular rate for work on the following holiday(s).

New Year's Day
Memorial Day
Independence Day
Labor Day
Columbus Day
Thanksgiving Day
Christmas Day

Paid Holidays

Labor Day
Thanksgiving Day

Shift Rates

When two shifts are employed, single time rate shall be paid for each shift. When three shifts are found necessary, each shift shall work seven and one half hours (7 ½), but shall be paid for eight (8) hours of labor, and be permitted one half hour for lunch.

(Local #731)

LANDSCAPING

(Landscaping tasks, such as tree pruning, tree removing and spraying in connection with Green Infrastructure maintenance and the planting of street trees and trees in City parks, but not when such activities are performed as part of construction or reconstruction projects.)

Landscaper (Year 6 and above)

Effective Period: 7/1/2023 - 6/30/2024
Wage Rate per Hour: **\$36.64**
Supplemental Benefit Rate per Hour: **\$17.55**

Landscaper (Year 3 - 5)

Effective Period: 7/1/2023 - 6/30/2024
Wage Rate per Hour: **\$35.47**

OFFICE OF THE COMPTROLLER, CITY OF NEW YORK
CONSTRUCTION WORKER PREVAILING WAGE SCHEDULE

Supplemental Benefit Rate per Hour: **\$17.55**

Landscaper (up to 3 years)

Effective Period: 7/1/2023 - 6/30/2024

Wage Rate per Hour: **\$32.55**

Supplemental Benefit Rate per Hour: **\$17.55**

Groundperson

Effective Period: 7/1/2023 - 6/30/2024

Wage Rate per Hour: **\$32.55**

Supplemental Benefit Rate per Hour: **\$17.55**

Tree Remover / Pruner

Effective Period: 7/1/2023 - 6/30/2024

Wage Rate per Hour: **\$42.51**

Supplemental Benefit Rate per Hour: **\$17.55**

Landscaper Sprayer (Pesticide Applicator)

Effective Period: 7/1/2023 - 6/30/2024

Wage Rate per Hour: **\$30.80**

Supplemental Benefit Rate per Hour: **\$17.55**

Watering - Plant Maintainer

Effective Period: 7/1/2023 - 6/30/2024

Wage Rate per Hour: **\$24.92**

Supplemental Benefit Rate per Hour: **\$17.55**

Overtime Description

For all overtime work performed, supplemental benefits shall include an additional seventy-five (\$0.75) cents per hour.

Overtime

Time and one half the regular rate after an 8 hour day.

Time and one half the regular rate for Saturday.

Double time the regular rate for Sunday.

Time and one half the regular rate for work on a holiday plus the day's pay.

Paid Holidays

New Year's Day

Memorial Day

Independence Day

Labor Day

Thanksgiving Day

Christmas Day

OFFICE OF THE COMPTROLLER, CITY OF NEW YORK
CONSTRUCTION WORKER PREVAILING WAGE SCHEDULE

Shift Rates

Work performed on a 4pm to 12am shift has a 15% differential. Work performed on a 12am to 8am shift has a 20% differential.

(Local #175)

MARBLE MECHANIC

Marble Setter

Effective Period: 7/1/2023 - 7/2/2023

Wage Rate per Hour: **\$57.82**

Supplemental Benefit Rate per Hour: **\$42.86**

Effective Period: 7/3/2023 - 1/14/2024

Wage Rate per Hour: **\$58.12**

Supplemental Benefit Rate per Hour: **\$43.31**

Effective Period: 1/15/2024 - 6/30/2024

Wage Rate per Hour: **\$58.47**

Supplemental Benefit Rate per Hour: **\$43.71**

Marble Finisher

Effective Period: 7/1/2023 - 7/2/2023

Wage Rate per Hour: **\$44.77**

Supplemental Benefit Rate per Hour: **\$40.16**

Effective Period: 7/3/2023 - 1/14/2024

Wage Rate per Hour: **\$45.10**

Supplemental Benefit Rate per Hour: **\$40.36**

Effective Period: 1/15/2024 - 6/30/2024

Wage Rate per Hour: **\$45.37**

Supplemental Benefit Rate per Hour: **\$40.61**

Marble Polisher

Effective Period: 7/1/2023 - 7/2/2023

Wage Rate per Hour: **\$43.97**

Supplemental Benefit Rate per Hour: **\$32.76**

Effective Period: 7/3/2023 - 1/14/2024

Wage Rate per Hour: **\$44.19**

OFFICE OF THE COMPTROLLER, CITY OF NEW YORK
CONSTRUCTION WORKER PREVAILING WAGE SCHEDULE

Supplemental Benefit Rate per Hour: **\$33.11**

Effective Period: 1/15/2024 - 6/30/2024

Wage Rate per Hour: **\$44.40**

Supplemental Benefit Rate per Hour: **\$33.46**

Marble Maintenance Finisher

Effective Period: 7/1/2023 - 7/2/2023

Wage Rate per Hour: **\$27.26**

Supplemental Benefit Rate per Hour: **\$14.55**

Effective Period: 7/3/2023 - 1/14/2024

Wage Rate per Hour: **\$27.44**

Supplemental Benefit Rate per Hour: **\$14.77**

Effective Period: 1/15/2024 - 6/30/2024

Wage Rate per Hour: **\$27.56**

Supplemental Benefit Rate per Hour: **\$15.06**

Overtime Description

Supplemental Benefit contributions are to be made at the applicable overtime rates.

Overtime

Time and one half the regular rate after an 8 hour day.

Time and one half the regular rate for Saturday.

Double time the regular rate for Sunday.

Overtime Holidays

Double time the regular rate for work on the following holiday(s).

New Year's Day

President's Day

Good Friday

Memorial Day

Independence Day

Labor Day

Columbus Day

Veteran's Day

Thanksgiving Day

Day after Thanksgiving

Christmas Day

Paid Holidays

None

(Local #7)

MASON TENDER

Mason Tender

Effective Period: 7/1/2023 - 1/14/2024

Wage Rate per Hour: **\$43.80**

Supplemental Benefit Rate per Hour: **\$29.39**
before calculating premium wage component deduct \$3.00

Effective Period: 1/15/2024 - 6/30/2024

Wage Rate per Hour: **\$44.70**

Supplemental Benefit Rate per Hour: **\$29.99**
before calculating premium wage component deduct \$3.25

Overtime

Time and one half the regular rate after an 8 hour day.

Time and one half the regular rate for Saturday.

Double time the regular rate for Sunday.

Saturday may be used as a make-up day at straight time when a day is lost during that week to inclement weather.

Overtime Holidays

Double time the regular rate for work on the following holiday(s).

New Year's Day

President's Day

Memorial Day

Independence Day

Labor Day

Thanksgiving Day

Christmas Day

Paid Holidays

None

Shift Rates

The employer may work two (2) shifts with the first shift at the straight time wage rate and the second shift receiving eight (8) hours paid for seven (7) hours work at the straight time wage rate. When it is not possible to conduct alteration work during regular working hours in a building occupied by tenants, the rule for the second shift will apply.

(Local #79)

MASON TENDER (INTERIOR DEMOLITION WORKER)

Mason Tender Tier A

OFFICE OF THE COMPTROLLER, CITY OF NEW YORK
CONSTRUCTION WORKER PREVAILING WAGE SCHEDULE

Tier A Interior Demolition Worker performs all burning, chopping, and other technically skilled tasks related to interior demolition work.

Effective Period: 7/1/2023 - 1/14/2024

Wage Rate per Hour: **\$39.19**

Supplemental Benefit Rate per Hour: **\$24.60**

before calculating premium wage component deduct \$1.50

Effective Period: 1/15/2024 - 6/30/2024

Wage Rate per Hour: **\$39.70**

Supplemental Benefit Rate per Hour: **\$24.84**

before calculating premium wage component deduct \$1.70

Mason Tender Tier B

Tier B Interior Demolition Worker performs manual work and work incidental to demolition work, such as loading and carting of debris from the work site to an area where it can be loaded in to bins/trucks for removal. Also performs clean-up of the site when demolition is completed.

Effective Period: 7/1/2023 - 1/14/2024

Wage Rate per Hour: **\$28.38**

Supplemental Benefit Rate per Hour: **\$18.92**

before calculating premium wage component deduct \$1.50

Effective Period: 1/15/2024 - 6/30/2024

Wage Rate per Hour: **\$29.89**

Supplemental Benefit Rate per Hour: **\$19.16**

before calculating premium wage component deduct \$1.70

Overtime

Time and one half the regular rate after an 8 hour day.

Time and one half the regular rate for Sunday.

Overtime Holidays

Double time the regular rate for work on the following holiday(s).

New Year's Day

President's Day

Memorial Day

Independence Day

Labor Day

Thanksgiving Day

Christmas Day

Paid Holidays

None

(Local #79)

METALLIC LATHER

Metallic Lather

Effective Period: 7/1/2023 - 6/30/2024

Wage Rate per Hour: **\$46.45**

Supplemental Benefit Rate per Hour: **\$52.80**

Supplemental Note: For time and one half overtime - \$64.80 For double overtime - \$81.60

Overtime

Time and one half the regular rate after an 8 hour day.

Time and one half the regular rate for Saturday.

Double time the regular rate for Sunday.

Overtime Holidays

Double time the regular rate for work on the following holiday(s).

New Year's Day

President's Day

Memorial Day

Independence Day

Labor Day

Columbus Day

Thanksgiving Day

Christmas Day

Paid Holidays

1/2 day on Christmas Eve if work is performed in the A.M.

1/2 day on New Year's Eve if work is performed in the A.M.

Shift Rates

Off-shift work outside of normal working hours shall receive straight time rate plus \$12 per hour for the first eight (8) hours.

(Local #46)

MILLWRIGHT

Millwright

Effective Period: 7/1/2023 - 6/30/2024

Wage Rate per Hour: **\$58.70**

Supplemental Benefit Rate per Hour: **\$57.11**

OFFICE OF THE COMPTROLLER, CITY OF NEW YORK
CONSTRUCTION WORKER PREVAILING WAGE SCHEDULE

Overtime

Time and one half the regular rate after an 8 hour day.

Time and one half the regular rate for Saturday.

Double time the regular rate for Sunday.

Saturday may be used as a make-up day at straight time when a day is lost during that week to inclement weather.

Overtime Holidays

Double time the regular rate for work on the following holiday(s).

New Year's Day

President's Day

Good Friday

Memorial Day

Independence Day

Labor Day

Columbus Day

Presidential Election Day

Veteran's Day

Thanksgiving Day

Christmas Day

Paid Holidays

1/2 day on Christmas Eve if work is performed in the A.M.

1/2 day on New Year's Eve if work is performed in the A.M.

Shift Rates

Second and third shifts receives the straight time rate of pay plus fifteen (15%) percent allowing for one half hour for a meal. There must be a first shift to work a second and third shift. All additional hours worked shall be paid at the time and one-half rate of pay plus fifteen (15%) percent for weekday hours.

(Local #740)

MOSAIC MECHANIC

Mosaic Mechanic - Mosaic & Terrazzo Mechanic

Effective Period: 7/1/2023 - 1/14/2024

Wage Rate per Hour: **\$53.40**

Supplemental Benefit Rate per Hour: **\$45.67**

Effective Period: 1/15/2024 - 6/30/2024

Wage Rate per Hour: **\$53.57**

Supplemental Benefit Rate per Hour: **\$46.52**

Mosaic Mechanic - Mosaic & Terrazzo Finisher

OFFICE OF THE COMPTROLLER, CITY OF NEW YORK
CONSTRUCTION WORKER PREVAILING WAGE SCHEDULE

Effective Period: 7/1/2023 - 1/14/2024
Wage Rate per Hour: **\$51.79**
Supplemental Benefit Rate per Hour: **\$45.67**

Effective Period: 1/15/2024 - 6/30/2024
Wage Rate per Hour: **\$51.96**
Supplemental Benefit Rate per Hour: **\$46.52**

Mosaic Mechanic - Machine Operator Grinder

Effective Period: 7/1/2023 - 1/14/2024
Wage Rate per Hour: **\$51.79**
Supplemental Benefit Rate per Hour: **\$45.67**

Effective Period: 1/15/2024 - 6/30/2024
Wage Rate per Hour: **\$51.96**
Supplemental Benefit Rate per Hour: **\$46.52**

Overtime

Time and one half the regular rate after a 7 hour day.
Time and one half the regular rate for Saturday.
Double time the regular rate for Sunday.

Overtime Holidays

Double time the regular rate for work on the following holiday(s).

- New Year's Day
- Washington's Birthday
- Good Friday
- Independence Day
- Labor Day
- Columbus Day
- Veteran's Day
- Thanksgiving Day
- Day after Thanksgiving
- Christmas Day

Paid Holidays

None

(Local #7)

PAINTER

Painter - Brush & Roller

Effective Period: 7/1/2023 - 6/30/2024

OFFICE OF THE COMPTROLLER, CITY OF NEW YORK
CONSTRUCTION WORKER PREVAILING WAGE SCHEDULE

Wage Rate per Hour: **\$43.00**

Supplemental Benefit Rate per Hour: **\$40.88**

Supplemental Note: \$46.62 on overtime

Spray & Scaffold / Decorative / Sandblast

Effective Period: 7/1/2023 - 6/30/2024

Wage Rate per Hour: **\$46.00**

Supplemental Benefit Rate per Hour: **\$40.88**

Supplemental Note: \$46.62 on overtime

Overtime

Time and one half the regular rate after a 7 hour day.

Time and one half the regular rate for Saturday.

Time and one half the regular rate for Sunday.

Overtime Holidays

Time and one half the regular rate for work on the following holiday(s).

New Year's Day

President's Day

Memorial Day

Independence Day

Labor Day

Columbus Day

Thanksgiving Day

Christmas Day

Paid Holidays

None

(District Council of Painters #9)

PAINTER - LINE STRIPING (ROADWAY)

see PAVER AND ROADBUILDER - LINE STRIPING (ROADWAY)

PAINTER - METAL POLISHER

METAL POLISHER

Effective Period: 7/1/2023 - 6/30/2024

OFFICE OF THE COMPTROLLER, CITY OF NEW YORK
CONSTRUCTION WORKER PREVAILING WAGE SCHEDULE

Wage Rate per Hour: **\$32.93**

Supplemental Benefit Rate per Hour: **\$11.99**

METAL POLISHER - NEW CONSTRUCTION

Effective Period: 7/1/2023 - 6/30/2024

Wage Rate per Hour: **\$33.88**

Supplemental Benefit Rate per Hour: **\$11.99**

METAL POLISHER - SCAFFOLD OVER 34 FEET

Effective Period: 7/1/2023 - 6/30/2024

Wage Rate per Hour: **\$36.43**

Supplemental Benefit Rate per Hour: **\$11.99**

ASSISTANT METAL POLISHER

Effective Period: 7/1/2023 - 6/30/2024

Wage Rate per Hour: **\$25.71**

Supplemental Benefit Rate per Hour: **\$11.51**

ASSISTANT METAL POLISHER - NEW CONSTRUCTION

Effective Period: 7/1/2023 - 6/30/2024

Wage Rate per Hour: **\$26.66**

Supplemental Benefit Rate per Hour: **\$11.51**

ASSISTANT METAL POLISHER - SCAFFOLD OVER 34 FEET

Effective Period: 7/1/2023 - 6/30/2024

Wage Rate per Hour: **\$28.21**

Supplemental Benefit Rate per Hour: **\$11.51**

Overtime Description

All work performed on Saturdays shall be paid at time-in-a half. The exception being; for suspended scaffold work and work deemed as a construction project; an eight (8) hour shift lost during the week due to circumstances beyond the control of the employer, up to a maximum of eight (8) hours per week, may be worked on Saturday at the straight time rate.

Holiday Pay

Only employees who have completed one year of service, including any trial period shall be eligible for holiday pay.

Overtime

Time and one half the regular rate after an 8 hour day.

Time and one half the regular rate for Saturday.

Double time the regular rate for Sunday.

Saturday may be used as a make-up day at straight time when a day is lost during that week to inclement weather.

Triple time the regular rate for work on the following holiday(s).

OFFICE OF THE COMPTROLLER, CITY OF NEW YORK
CONSTRUCTION WORKER PREVAILING WAGE SCHEDULE

Paid Holidays

New Year's Day
Martin Luther King Jr. Day
President's Day
Memorial Day
Independence Day
Labor Day
Columbus Day
Veteran's Day
Thanksgiving Day
Day after Thanksgiving
Christmas Day

Shift Rates

Four Days a week at Ten (10) hours straight a day.

Local 8A-28A

PAINTER - SIGN

Sign Painter

Effective Period: 7/1/2023 - 6/30/2024

Wage Rate per Hour: **\$45.54**

Supplemental Benefit Rate per Hour: **\$22.29**

Assistant Sign Painter

Effective Period: 7/1/2023 - 6/30/2024

Wage Rate per Hour: **\$38.70**

Supplemental Benefit Rate per Hour: **\$20.20**

Overtime Description

If any employee is required to work on any of the paid holidays then the employee shall receive double time rate of wages as well as the holiday pay for that day.

Overtime

Time and one half the regular rate after an 8 hour day.

Time and one half the regular rate for Saturday.

Time and one half the regular rate for Sunday.

Paid Holidays

New Year's Day
President's Day
Memorial Day

OFFICE OF THE COMPTROLLER, CITY OF NEW YORK
CONSTRUCTION WORKER PREVAILING WAGE SCHEDULE

Independence Day
Labor Day
Columbus Day
Election Day
Thanksgiving Day
Day after Thanksgiving
Christmas Day

Vacation

At least 1 year of employment.....1 week
2 years or more of employment.....2 weeks
8 years or more of employment.....3 weeks

(Local #8A-28A)

PAINTER - STRUCTURAL STEEL

Painters on Structural Steel

Effective Period: 7/1/2023 - 6/30/2024
Wage Rate per Hour: **\$54.50**
Supplemental Benefit Rate per Hour: **\$51.33**

Painter - Power Tool

Effective Period: 7/1/2023 - 6/30/2024
Wage Rate per Hour: **\$61.00**
Supplemental Benefit Rate per Hour: **\$51.33**
Overtime Wage Rate: \$6.50 above the "Painters on Structural Steel" overtime rate.

Overtime Description

Supplemental Benefits shall be paid for each hour worked, up to forty (40) hours per week for the period of May 1st to November 15th or up to fifty (50) hours per week for the period of November 16th to April 30th.

Overtime

Time and one half the regular rate after a 7 hour day.
Time and one half the regular rate for Saturday.
Time and one half the regular rate for Sunday.

Overtime Holidays

Double time the regular rate for work on the following holiday(s).
New Year's Day
Memorial Day
Independence Day
Labor Day
Thanksgiving Day
Christmas Day

OFFICE OF THE COMPTROLLER, CITY OF NEW YORK
CONSTRUCTION WORKER PREVAILING WAGE SCHEDULE

Paid Holidays

None

Shift Rates

Second shift is paid at regular hourly wage rates plus a ten percent (10%) differential. There must be a first shift in order to work a second shift.

(Local #806)

PAPERHANGER

Paperhanger

Effective Period: 7/1/2023 - 6/30/2024

Wage Rate per Hour: **\$48.02**

Supplemental Benefit Rate per Hour: **\$40.51**

Supplemental Note: Supplemental benefits are to be paid at the appropriate straight time and overtime rate.

Overtime

Time and one half the regular rate after a 7 hour day.

Time and one half the regular rate for Saturday.

Time and one half the regular rate for Sunday.

Overtime Holidays

Time and one half the regular rate for work on the following holiday(s).

New Year's Day

President's Day

Memorial Day

Independence Day

Labor Day

Thanksgiving Day

Day after Thanksgiving

Christmas Day

Paid Holidays

None

Shift Rates

Evening shift - 4:30 P.M. to 12:00 Midnight (regular rate of pay); any work performed before 7:00 A.M. shall be at time and one half the regular base rate of pay.

(District Council of Painters #9)

PAVER AND ROADBUILDER

Paver & Roadbuilder - Formsetter

Effective Period: 7/1/2023 - 6/30/2024

Wage Rate per Hour: **\$48.85**

Supplemental Benefit Rate per Hour: **\$51.87**

Supplemental Note: For time and one half overtime - \$56.37 For double overtime - \$60.87

Paver & Roadbuilder - Laborer

Paving and road construction work, regardless of material used, including but not limited to preparation of job sites, removal of old surfaces, asphalt and/or concrete, by whatever method, including but not limited to milling; laying of concrete; laying of asphalt for temporary, patchwork, and utility paving (but not production paving); site preparation and incidental work for installation of rubberized materials and similar surfaces; installation and repair of temporary construction fencing; slurry/seal coating, paving stones, maintenance of safety surfaces; play equipment installation, and other related work.

Effective Period: 7/1/2023 - 6/30/2024

Wage Rate per Hour: **\$44.98**

Supplemental Benefit Rate per Hour: **\$51.87**

Supplemental Note: For time and one half overtime - \$56.37 For double overtime - \$60.87

Production Paver & Roadbuilder - Screed Person

(Production paving is asphalt paving when using a paving machine or on a project where a paving machine is traditionally used)

Adjustment of paving machinery on production paving jobs.

Effective Period: 7/1/2023 - 6/30/2024

Wage Rate per Hour: **\$49.45**

Supplemental Benefit Rate per Hour: **\$51.87**

Supplemental Note: For time and one half overtime - \$56.37 For double overtime - \$60.87

Production Paver & Roadbuilder - Raker

Effective Period: 7/1/2023 - 6/30/2024

Wage Rate per Hour: **\$48.85**

Supplemental Benefit Rate per Hour: **\$51.87**

Supplemental Note: For time and one half overtime - \$56.37 For double overtime - \$60.87

Production Paver & Roadbuilder - Shoveler

General laborer (except removal of surfaces - see Paver and Roadbuilder-Laborer) including but not limited to tamper, AC paint and liquid tar work.

Effective Period: 7/1/2023 - 6/30/2024

OFFICE OF THE COMPTROLLER, CITY OF NEW YORK
CONSTRUCTION WORKER PREVAILING WAGE SCHEDULE

Wage Rate per Hour: **\$44.98**

Supplemental Benefit Rate per Hour: **\$51.87**

Supplemental Note: For time and one half overtime - \$56.37 For double overtime - \$60.87

Overtime Description

If an employee works New Year's Day or Christmas Day, they receive the single time rate plus 25%.

For Paid Holidays: Holiday pay for all holidays shall be prorated based two hours per day for each day worked in the holiday week, not to exceed 8 hours of holiday pay.

Overtime

Time and one half the regular rate after an 8 hour day.

Time and one half the regular rate for Saturday.

Double time the regular rate for Sunday.

Overtime Holidays

Double time the regular rate for work on the following holiday(s).

Memorial Day

Independence Day

Labor Day

Columbus Day

Thanksgiving Day

Paid Holidays

Memorial Day

Independence Day

Labor Day

Thanksgiving Day

Shift Rates

When two shifts are employed, the work period for each shift shall be a continuous eight (8) hours. When three shifts are employed, each shift will work seven and one half (7 ½) hours but will be paid for eight (8) hours at the straight time rate since only one half (1/2) hour is allowed for meal time.

When two or more shifts are employed, single time will be paid for each shift.

Night Work - On night work, the first eight (8) hours of work will be paid for at the single time rate, except that production paving work shall be paid at 10% over the single time rate for the screed person, rakers and shovelers directly involved only. This differential is to be paid when there is only one shift and the shift works at night. All other workers will be exempt. Hours worked over eight (8) hours during said shift shall be paid for at the time and one-half rate.

(Local #1010)

PAVER AND ROADBUILDER - LINE STRIPING (ROADWAY)

Striping - Machine Operator

OFFICE OF THE COMPTROLLER, CITY OF NEW YORK
CONSTRUCTION WORKER PREVAILING WAGE SCHEDULE

Effective Period: 7/1/2023 - 6/30/2024

Wage Rate per Hour: **\$40.00**

Supplemental Benefit Rate per Hour: **\$17.27**

Supplemental Note: For time and one half overtime - \$18.27 For double overtime - \$19.27

Lineperson (Thermoplastic)

Effective Period: 7/1/2023 - 6/30/2024

Wage Rate per Hour: **\$44.00**

Supplemental Benefit Rate per Hour: **\$17.27**

Supplemental Note: For time and one half overtime - \$18.27 For double overtime - \$19.27

Striping Assistant & Traffic Safety

Effective Period: 7/1/2023 - 6/30/2024

Wage Rate per Hour: **\$38.00**

Supplemental Benefit Rate per Hour: **\$17.27**

Supplemental Note: For time and one half overtime - \$18.27 For double overtime - \$19.27

Overtime Description

For Paid Holidays: Employees will only receive Holiday Pay for holidays not worked if said employee worked both the regularly scheduled workday before and after the holiday.

Overtime

Time and one half the regular rate after an 8 hour day.

Time and one half the regular rate for Saturday.

Time and one half the regular rate for Sunday.

Time and one half the regular rate for work on the following holiday(s).

Paid Holidays

New Year's Day

Good Friday

Memorial Day

Independence Day

Labor Day

Columbus Day

Presidential Election Day

Thanksgiving Day

Christmas Day

Vacation

Employees with one to two years service shall accrue vacation based on hours worked: 250 hours worked - 1 day vacation; 500 hours worked - 2 days vacation; 750 hours worked - 3 days vacation; 900 hours worked - 4 days vacation; 1,000 hours worked - 5 days vacation. Employees with two to five years service receive two weeks vacation. Employees with five to twenty years service receive three weeks vacation. Employees with twenty to twenty-five years service receive four weeks vacation. Employees with 25 or more years service receive five weeks vacation.

(Local #1010)

PLASTERER

Plasterer

Effective Period: 7/1/2023 - 7/31/2023

Wage Rate per Hour: **\$52.08**

Supplemental Benefit Rate per Hour: **\$23.74**

Effective Period: 8/1/2023 - 6/30/2024

Wage Rate per Hour: **\$52.10**

Supplemental Benefit Rate per Hour: **\$25.35**

Overtime

Time and one half the regular rate after an 8 hour day.

Time and one half the regular rate for Saturday.

Double time the regular rate for Sunday.

Saturday may be used as a make-up day at straight time when a day is lost during that week to inclement weather.

Overtime Holidays

Double time the regular rate for work on the following holiday(s).

New Year's Day

President's Day

Memorial Day

Independence Day

Labor Day

Thanksgiving Day

Christmas Day

Paid Holidays

None

Shift Rates

When it is not possible to conduct work during regular working hours (between 6:30am and 4:30pm), a shift differential shall be paid at the regular hourly rate plus a twelve percent (12%) per hour differential. Workers on shift work shall be allowed a paid one-half hour meal break.

(Local #262)

PLASTERER - TENDER

Plasterer - Tender

OFFICE OF THE COMPTROLLER, CITY OF NEW YORK
CONSTRUCTION WORKER PREVAILING WAGE SCHEDULE

Effective Period: 7/1/2023 - 6/30/2024

Wage Rate per Hour: **\$39.95**

Supplemental Benefit Rate per Hour: **\$31.99**

Overtime

Time and one half the regular rate after an 8 hour day.

Time and one half the regular rate for Saturday.

Double time the regular rate for Sunday.

Saturday may be used as a make-up day at straight time when a day is lost during that week to inclement weather.

Overtime Holidays

Double time the regular rate for work on the following holiday(s).

New Year's Day

Washington's Birthday

Memorial Day

Independence Day

Labor Day

Presidential Election Day

Thanksgiving Day

Christmas Day

Paid Holidays

None

Shift Rates

When work commences outside regular work hours, workers receive an hour additional (differential) wage and supplement payment. Eight hours pay for seven hours work or nine hours pay for eight hours work.

(Mason Tenders District Council)

PLUMBER

Plumber

Effective Period: 7/1/2023 - 1/14/2024

Wage Rate per Hour: **\$72.50**

Supplemental Benefit Rate per Hour: **\$41.45**

Supplemental Note: Supplemental benefit contributions are to be made at the applicable overtime rates.

Effective Period: 1/15/2024 - 6/30/2024

Wage Rate per Hour: **\$73.70**

Supplemental Benefit Rate per Hour: **\$42.25**

Supplemental Note: Supplemental benefit contributions are to be made at the applicable overtime rates.

Plumber - Temporary Services

OFFICE OF THE COMPTROLLER, CITY OF NEW YORK
CONSTRUCTION WORKER PREVAILING WAGE SCHEDULE

Temporary Services - When there are no Plumbers on the job site, there may be three shifts designed to cover the entire twenty-four hour period, including weekends if necessary, at the following rate straight time.

Effective Period: 7/1/2023 - 1/14/2024

Wage Rate per Hour: **\$58.08**

Supplemental Benefit Rate per Hour: **\$33.08**

Effective Period: 1/15/2024 - 6/30/2024

Wage Rate per Hour: **\$59.04**

Supplemental Benefit Rate per Hour: **\$33.72**

Overtime

Double time the regular rate after an 8 hour day.

Double time the regular time rate for Saturday.

Double time the regular rate for Sunday.

Overtime Holidays

Double time the regular rate for work on the following holiday(s).

New Year's Day

President's Day

Memorial Day

Independence Day

Labor Day

Columbus Day

Veteran's Day

Thanksgiving Day

Day after Thanksgiving

Christmas Day

Shift Rates

30% shift premium shall be paid for wages and fringe benefits for 4:00 pm and midnight shifts Monday to Friday.

50% shift premium shall be paid for wages and fringe benefits for 4:00 pm and midnight shift work performed on weekends. For shift work on holidays, double time wages and fringe benefits shall be paid.

(Plumbers Local #1)

PLUMBER (MECHANICAL EQUIPMENT AND SERVICE)

(Mechanical Equipment and Service work shall include any repair and/or replacement of the present plumbing system.)

Plumber

Effective Period: 7/1/2023 - 1/14/2024

Wage Rate per Hour: **\$47.45**

OFFICE OF THE COMPTROLLER, CITY OF NEW YORK
CONSTRUCTION WORKER PREVAILING WAGE SCHEDULE

Supplemental Benefit Rate per Hour: **\$20.51**

Effective Period: 1/15/2024 - 6/30/2024

Wage Rate per Hour: **\$48.20**

Supplemental Benefit Rate per Hour: **\$21.36**

Overtime

Time and one half the regular rate after an 8 hour day.

Time and one half the regular rate for Saturday.

Time and one half the regular rate for Sunday.

Overtime Holidays

Double time the regular rate for work on the following holiday(s).

New Year's Day

President's Day

Memorial Day

Independence Day

Thanksgiving Day

Day after Thanksgiving

Christmas Day

Paid Holidays

None

(Plumbers Local # 1)

PLUMBER (RESIDENTIAL RATES FOR 1, 2 AND 3 FAMILY HOME CONSTRUCTION)

Effective Period: 7/1/2023 - 1/14/2024

Wage Rate per Hour: **\$50.35**

Supplemental Benefit Rate per Hour: **\$29.73**

Effective Period: 1/15/2024 - 6/30/2024

Wage Rate per Hour: **\$51.19**

Supplemental Benefit Rate per Hour: **\$30.29**

Overtime

Double time the regular rate after an 8 hour day.

Double time the regular time rate for Saturday.

Double time the regular rate for Sunday.

Overtime Holidays

Double time the regular rate for work on the following holiday(s).

New Year's Day

President's Day

OFFICE OF THE COMPTROLLER, CITY OF NEW YORK
CONSTRUCTION WORKER PREVAILING WAGE SCHEDULE

Memorial Day
Independence Day
Labor Day
Columbus Day
Veteran's Day
Thanksgiving Day
Day after Thanksgiving
Christmas Day

Paid Holidays

None

Shift Rates

30% shift premium shall be paid for wages and fringe benefits for 4:00 pm and midnight shifts Monday to Friday.
50% shift premium shall be paid for wages and fringe benefits for 4:00 pm and midnight shift work performed on weekends. For shift work on holidays, double time wages and fringe benefits shall be paid.

(Plumbers Local #1)

PLUMBER: PUMP & TANK
Oil Trades (Installation and Maintenance)

Plumber - Pump & Tank

Effective Period: 7/1/2023 - 6/30/2024

Wage Rate per Hour: **\$69.73**

Supplemental Benefit Rate per Hour: **\$28.48**

Overtime

Time and one half the regular rate after an 8 hour day.

Time and one half the regular rate for Saturday.

Time and one half the regular rate for Sunday.

Overtime Holidays

Time and one half the regular rate for work on the following holiday(s).

New Year's Day
President's Day
Memorial Day
Independence Day
Labor Day
Columbus Day
Veteran's Day
Thanksgiving Day
Day after Thanksgiving
Christmas Day

OFFICE OF THE COMPTROLLER, CITY OF NEW YORK
CONSTRUCTION WORKER PREVAILING WAGE SCHEDULE

Paid Holidays

None

Shift Rates

All work outside the regular workday (8:00 A.M. to 3:30 P.M.) is to be paid at time and one half the regular hourly rate

(Plumbers Local #1)

**POINTER, WATERPROOFER, CAULKER, SANDBLASTER,
STEAMBLASTER
(Exterior Building Renovation)**

Journey person

Effective Period: 7/1/2023 - 6/30/2024

Wage Rate per Hour: **\$61.93**

Supplemental Benefit Rate per Hour: **\$30.25**

Overtime

Time and one half the regular rate after an 8 hour day.

Time and one half the regular rate for Saturday.

Time and one half the regular rate for Sunday.

Saturday may be used as a make-up day at straight time when a day is lost during that week to inclement weather.

Overtime Holidays

Time and one half the regular rate for work on the following holiday(s).

New Year's Day

Martin Luther King Jr. Day

President's Day

Memorial Day

Independence Day

Labor Day

Thanksgiving Day

Christmas Day

Paid Holidays

None

Shift Rates

All work outside the regular work day (an eight hour workday between the hours of 6:00 A.M. and 4:00 P.M.) is to be paid at time and one half the regular rate. However, the employer may establish one (1) or two (2) shifts

OFFICE OF THE COMPTROLLER, CITY OF NEW YORK
CONSTRUCTION WORKER PREVAILING WAGE SCHEDULE

starting at or after 4:00 P.M. to be paid at the regular hourly rate plus a 10% differential. For projects bid and performed after July 1, 2023, the first shift shall be paid at the regular hourly rate plus a 5% differential.

(Bricklayer District Council)

ROOFER

Roofer

Effective Period: 7/1/2023 - 6/30/2024

Wage Rate per Hour: **\$46.50**

Supplemental Benefit Rate per Hour: **\$38.31**

Overtime

Time and one half the regular rate after an 8 hour day.

Time and one half the regular rate for Saturday.

Time and one half the regular rate for Sunday.

Overtime Holidays

Time and one half the regular rate for work on the following holiday(s).

New Year's Day

Memorial Day

Independence Day

Labor Day

Thanksgiving Day

Christmas Day

Paid Holidays

None

Shift Rates

Second shift - Regular hourly rate plus a 10% differential. Third shift - Regular hourly rate plus a 15% differential. There must be a first shift to work the second shift, and a second shift to work the third shift. All other work outside the regular work day (an eight hour workday between the hours of 5:00 A.M. and 4:00 P.M.) is to be paid at time and one half the regular rate.

(Local #8)

SHEET METAL WORKER

Sheet Metal Worker

OFFICE OF THE COMPTROLLER, CITY OF NEW YORK
CONSTRUCTION WORKER PREVAILING WAGE SCHEDULE

Effective Period: 7/1/2023 - 1/14/2024

Wage Rate per Hour: **\$52.60**

Supplemental Benefit Rate per Hour: **\$56.93**

Supplemental Note: Supplemental benefit contributions are to be made at the applicable overtime rates.

Effective Period: 1/15/2024 - 6/30/2024

Wage Rate per Hour: **\$53.60**

Supplemental Benefit Rate per Hour: **\$58.43**

Supplemental Note: Supplemental benefit contributions are to be made at the applicable overtime rates.

Sheet Metal Worker - Fan Maintenance

(The temporary operation of fans or blowers in new or existing buildings for heating and/or ventilation, and/or air conditioning prior to the completion of the project.)

Effective Period: 7/1/2023 - 1/14/2024

Wage Rate per Hour: **\$42.08**

Supplemental Benefit Rate per Hour: **\$56.93**

Effective Period: 1/15/2024 - 6/30/2024

Wage Rate per Hour: **\$42.88**

Supplemental Benefit Rate per Hour: **\$58.43**

Sheet Metal Worker - Duct Cleaner

Effective Period: 7/1/2023 - 1/14/2024

Wage Rate per Hour: **\$19.30**

Supplemental Benefit Rate per Hour: **\$12.35**

Effective Period: 1/15/2024 - 6/30/2024

Wage Rate per Hour: **\$19.57**

Supplemental Benefit Rate per Hour: **\$12.72**

Overtime

Time and one half the regular rate after an 8 hour day.

Time and one half the regular rate for Saturday.

Double time the regular rate for Sunday.

Overtime Holidays

Double time the regular rate for work on the following holiday(s).

New Year's Day

Martin Luther King Jr. Day

President's Day

Memorial Day

Independence Day

Labor Day

Columbus Day

Veteran's Day

Thanksgiving Day

Day after Thanksgiving

OFFICE OF THE COMPTROLLER, CITY OF NEW YORK
CONSTRUCTION WORKER PREVAILING WAGE SCHEDULE

Christmas Day

Paid Holidays

None

Shift Rates

Work that can only be performed outside regular working hours (eight hours of work between 7:30 A.M. and 3:30 P.M.) - First shift (work between 3:30 P.M. and 11:30 P.M.) - 10% differential above the established hourly rate.
Second shift (work between 11:30 P.M. and 7:30 A.M.) - 15% differential above the established hourly rate.

For Fan Maintenance: On all full shifts of fan maintenance work the straight time hourly rate of pay will be paid for each shift, including nights, Saturdays, Sundays, and holidays.

(Local #28)

SHEET METAL WORKER - SPECIALTY (Decking & Siding)

Sheet Metal Specialty Worker

The first worker to perform this work must be paid at the rate of the Sheet Metal Worker. The second and third workers shall be paid the Specialty Worker Rate. The ratio of One Sheet Metal Worker, then Two Specialty Workers shall be utilized thereafter.

Effective Period: 7/1/2023 - 1/14/2024

Wage Rate per Hour: **\$49.40**

Supplemental Benefit Rate per Hour: **\$28.99**

Supplemental Note: Supplemental benefit contributions are to be made at the applicable overtime rates.

Effective Period: 1/15/2024 - 6/30/2024

Wage Rate per Hour: **\$50.10**

Supplemental Benefit Rate per Hour: **\$30.04**

Supplemental Note: Supplemental benefit contributions are to be made at the applicable overtime rates.

Overtime

Time and one half the regular rate after an 8 hour day.

Time and one half the regular rate for Saturday.

Double time the regular rate for Sunday.

Overtime Holidays

Double time the regular rate for work on the following holiday(s).

New Year's Day

Martin Luther King Jr. Day

President's Day

Memorial Day

OFFICE OF THE COMPTROLLER, CITY OF NEW YORK
CONSTRUCTION WORKER PREVAILING WAGE SCHEDULE

Independence Day
Labor Day
Columbus Day
Veteran's Day
Thanksgiving Day
Christmas Day

Paid Holidays

None

(Local #28)

SHIPYARD WORKER

Shipyard Mechanic - First Class

Effective Period: 7/1/2023 - 6/30/2024

Wage Rate per Hour: **\$30.26**

Supplemental Benefit Rate per Hour: **\$3.80**

Shipyard Mechanic - Second Class

Effective Period: 7/1/2023 - 6/30/2024

Wage Rate per Hour: **\$21.63**

Supplemental Benefit Rate per Hour: **\$3.30**

Shipyard Laborer - First Class

Effective Period: 7/1/2023 - 6/30/2024

Wage Rate per Hour: **\$23.59**

Supplemental Benefit Rate per Hour: **\$3.70**

Shipyard Laborer - Second Class

Effective Period: 7/1/2023 - 6/30/2024

Wage Rate per Hour: **\$18.43**

Supplemental Benefit Rate per Hour: **\$3.43**

Shipyard Dockhand - First Class

Effective Period: 7/1/2023 - 6/30/2024

Wage Rate per Hour: **\$25.82**

Supplemental Benefit Rate per Hour: **\$3.54**

OFFICE OF THE COMPTROLLER, CITY OF NEW YORK
CONSTRUCTION WORKER PREVAILING WAGE SCHEDULE

Shipyard Dockhand - Second Class

Effective Period: 7/1/2023 - 6/30/2024

Wage Rate per Hour: **\$18.83**

Supplemental Benefit Rate per Hour: **\$3.58**

Overtime Description

Work performed on holiday is paid double time the regular hourly wage rate plus holiday pay.

Overtime

Time and one half the regular rate after an 8 hour day.

Time and one half the regular rate for Saturday.

Double time the regular rate for Sunday.

Time and one half the regular hourly rate after 40 straight time hours in any work week.

Paid Holidays

New Year's Day

Martin Luther King Jr. Day

President's Day

Good Friday

Memorial Day

Independence Day

Labor Day

Thanksgiving Day

Day after Thanksgiving

Christmas Day

Based on Survey Data

SIGN ERECTOR

(Sheet Metal, Plastic, Electric, and Neon)

Sign Erector

Effective Period: 7/1/2023 - 1/14/2024

Wage Rate per Hour: **\$56.00**

Supplemental Benefit Rate per Hour: **\$61.89**

Effective Period: 1/15/2024 - 6/30/2024

Wage Rate per Hour: **\$58.00**

Supplemental Benefit Rate per Hour: **\$63.44**

Overtime

Time and one half the regular rate after a 7 hour day.

OFFICE OF THE COMPTROLLER, CITY OF NEW YORK
CONSTRUCTION WORKER PREVAILING WAGE SCHEDULE

Time and one half the regular rate for Saturday.
Time and one half the regular rate for Sunday.
Time and one half the regular rate for work on the following holiday(s).

Paid Holidays

New Year's Day
President's Day
Memorial Day
Independence Day
Labor Day
Columbus Day
Election Day
Thanksgiving Day
Day after Thanksgiving
Christmas Day

Shift Rates

Time and one half the regular hourly rate is to be paid for all hours worked outside the regular workday either (7:00 A.M. through 2:30 P.M.) or (8:00 A.M. through 3:30 P.M.)

(Local #137)

STEAMFITTER

Steamfitter

Effective Period: 7/1/2023 - 6/30/2024
Wage Rate per Hour: **\$69.05**
Supplemental Benefit Rate per Hour: **\$53.14**
Supplemental Note: Overtime supplemental benefit rate: \$105.54

Steamfitter -Temporary Services

Effective Period: 7/1/2023 - 6/30/2024
Wage Rate per Hour: **\$52.48**
Supplemental Benefit Rate per Hour: **\$43.57**

Overtime Description

Double time after a 7 hour day except for Temporary Services.

Overtime

Double time the regular time rate for Saturday.
Double time the regular rate for Sunday.

Overtime Holidays

Double time the regular rate for work on the following holiday(s).

OFFICE OF THE COMPTROLLER, CITY OF NEW YORK
CONSTRUCTION WORKER PREVAILING WAGE SCHEDULE

New Year's Day
President's Day
Memorial Day
Independence Day
Labor Day
Columbus Day
Veteran's Day
Thanksgiving Day
Day after Thanksgiving
Christmas Day

Paid Holidays

None

Shift Rates

May be performed outside of the regular workday except Saturday, Sunday and Holidays. When shift work is performed the wage rate for regular time worked is a 15% percent premium on wage and 15% percent premium on supplemental benefits.

Local 638

**STEAMFITTER - REFRIGERATION AND AIR CONDITIONER
(Maintenance and Installation Service Person)**

Refrigeration and Air Conditioner Mechanic

Effective Period: 7/1/2023 - 1/14/2024

Wage Rate per Hour: **\$44.85**

Supplemental Benefit Rate per Hour: **\$20.71**

Effective Period: 1/15/2024 - 6/30/2024

Wage Rate per Hour: **\$45.10**

Supplemental Benefit Rate per Hour: **\$21.71**

Overtime

Time and one half the regular rate after an 8 hour day.

Time and one half the regular rate for Saturday.

Double time the regular rate for Sunday.

Overtime Holidays

Double time the regular rate for work on the following holiday(s).

New Year's Day
Independence Day
Labor Day
Veteran's Day

OFFICE OF THE COMPTROLLER, CITY OF NEW YORK
CONSTRUCTION WORKER PREVAILING WAGE SCHEDULE

Thanksgiving Day
Christmas Day

Double time and one half the regular rate for work on the following holiday(s).

Martin Luther King Jr. Day
President's Day
Memorial Day
Columbus Day

Paid Holidays

New Year's Day
Martin Luther King Jr. Day
President's Day
Memorial Day
Independence Day
Labor Day
Columbus Day
Veteran's Day
Thanksgiving Day
Christmas Day

(Local #638-B)

STONE MASON - SETTER

Stone Mason - Setter

(Assisted by Derrickperson and Rigger)

Effective Period: 7/1/2023 - 6/30/2024

Wage Rate per Hour: **\$56.15**

Supplemental Benefit Rate per Hour: **\$53.35**

Overtime

Time and one half the regular rate after a 7 hour day.

Time and one half the regular rate for Saturday.

Double time the regular rate for Sunday.

Overtime Holidays

Double time the regular rate for work on the following holiday(s).

New Year's Day
Washington's Birthday
Good Friday
Memorial Day
Independence Day
Labor Day
Thanksgiving Day
Christmas Day

OFFICE OF THE COMPTROLLER, CITY OF NEW YORK
CONSTRUCTION WORKER PREVAILING WAGE SCHEDULE

Paid Holidays

1/2 day on Christmas Eve if work is performed in the A.M.

Shift Rates

For all work outside the regular workday (8:00 A.M. to 3:30 P.M. Monday through Friday), the pay shall be straight time plus a ten percent (10%) differential.

(Bricklayers District Council)

TAPER

Drywall Taper

Effective Period: 7/1/2023 - 1/14/2024

Wage Rate per Hour: **\$48.47**

Supplemental Benefit Rate per Hour: **\$30.01**

Effective Period: 1/15/2024 - 6/30/2024

Wage Rate per Hour: **\$48.47**

Supplemental Benefit Rate per Hour: **\$32.36**

Overtime

Time and one half the regular rate after a 7 hour day.

Time and one half the regular rate for Saturday.

Time and one half the regular rate for Sunday.

Overtime Holidays

Time and one half the regular rate for work on the following holiday(s).

New Year's Day

Martin Luther King Jr. Day

President's Day

Good Friday

Memorial Day

Independence Day

Labor Day

Columbus Day

Thanksgiving Day

Christmas Day

Paid Holidays

Any worker who reports to work on Christmas Eve or New Year's Eve pursuant to his employer's instruction shall be entitled to three (3) hours afternoon pay without working.

(Local #1974)

TELECOMMUNICATION WORKER

(Install/maintain/repair telecommunications cables carrying data, video, and/or voice except for installation on building construction/alteration/renovation projects.)

Telecommunication Worker

Effective Period: 7/1/2023 - 6/30/2024

Wage Rate per Hour: **\$47.03**

Supplemental Benefit Rate per Hour: **\$23.15**

Supplemental Note: The above rate applies for Manhattan, Bronx, Brooklyn, Queens. \$22.84 for Staten Island only.

Overtime

Time and one half the regular rate after an 8 hour day.

Time and one half the regular rate for Saturday.

Time and one half the regular rate for Sunday.

Overtime Holidays

Time and one half the regular rate for work on the following holiday(s).

New Year's Day

Lincoln's Birthday

Washington's Birthday

Memorial Day

Independence Day

Labor Day

Columbus Day

Election Day

Veteran's Day

Thanksgiving Day

Christmas Day

Paid Holidays

New Year's Day

Lincoln's Birthday

Washington's Birthday

Memorial Day

Independence Day

Labor Day

Columbus Day

Election Day

Veteran's Day

Thanksgiving Day

Christmas Day

Employees have the option of observing either Martin Luther King's Birthday or the day after Thanksgiving instead of Lincoln's Birthday

OFFICE OF THE COMPTROLLER, CITY OF NEW YORK
CONSTRUCTION WORKER PREVAILING WAGE SCHEDULE

Shift Rates

For any workday that starts before 8A.M. or ends after 6P.M. there is a 10% differential for the applicable worker's hourly rate.

Vacation

After 6 months.....one week.
After 12 months but less than 7 years.....two weeks.
After 7 or more but less than 15 years.....three weeks.
After 15 years or more but less than 25 years.....four weeks.

(C.W.A.)

TILE FINISHER

Tile Finisher

Effective Period: 7/1/2023 - 1/14/2024

Wage Rate per Hour: **\$48.78**

Supplemental Benefit Rate per Hour: **\$32.36**

Effective Period: 1/15/2024 - 6/30/2024

Wage Rate per Hour: **\$49.16**

Supplemental Benefit Rate per Hour: **\$32.56**

Overtime

Time and one half the regular rate after a 7 hour day.

Time and one half the regular rate for Saturday.

Double time the regular rate for Sunday.

Overtime Holidays

Double time the regular rate for work on the following holiday(s).

New Year's Day

President's Day

Good Friday

Memorial Day

Independence Day

Labor Day

Columbus Day

Veteran's Day

Thanksgiving Day

Day after Thanksgiving

Christmas Day

Paid Holidays

None

OFFICE OF THE COMPTROLLER, CITY OF NEW YORK
CONSTRUCTION WORKER PREVAILING WAGE SCHEDULE

Shift Rates

Off shift work day (work performed outside the regular 8:00 A.M. to 3:30 P.M. workday): shift differential of one and one quarter (1¼) times the regular straight time rate of pay for the seven hours of actual off-shift work.

(Local #7)

TILE LAYER - SETTER

Tile Layer - Setter

Effective Period: 7/1/2023 - 1/14/2024

Wage Rate per Hour: **\$63.46**

Supplemental Benefit Rate per Hour: **\$35.51**

Effective Period: 1/15/2024 - 6/30/2024

Wage Rate per Hour: **\$63.98**

Supplemental Benefit Rate per Hour: **\$35.71**

Overtime

Time and one half the regular rate after a 7 hour day.

Time and one half the regular rate for Saturday.

Double time the regular rate for Sunday.

Overtime Holidays

Double time the regular rate for work on the following holiday(s).

New Year's Day

President's Day

Good Friday

Memorial Day

Independence Day

Labor Day

Columbus Day

Veteran's Day

Thanksgiving Day

Day after Thanksgiving

Christmas Day

Shift Rates

Off shift work day (work performed outside the regular 8:00 A.M. to 3:30 P.M. workday): shift differential of one and one quarter (1¼) times the regular straight time rate of pay for the seven hours of actual off-shift work.

(Local #7)

OFFICE OF THE COMPTROLLER, CITY OF NEW YORK
CONSTRUCTION WORKER PREVAILING WAGE SCHEDULE

TIMBERPERSON

Timberperson

Effective Period: 7/1/2023 - 6/30/2024

Wage Rate per Hour: **\$54.05**

Supplemental Benefit Rate per Hour: **\$54.99**

Overtime

Time and one half the regular rate after an 8 hour day.

Time and one half the regular rate for Saturday.

Double time the regular rate for Sunday.

Saturday may be used as a make-up day at straight time when a day is lost during that week to inclement weather.

Overtime Holidays

Double time the regular rate for work on the following holiday(s).

New Year's Day

President's Day

Memorial Day

Independence Day

Labor Day

Columbus Day

Presidential Election Day

Thanksgiving Day

Christmas Day

Paid Holidays

None

Shift Rates

Off shift work commencing between 5:00 P.M. and 11:00 P.M. shall work eight and one half hours allowing for one half hour for lunch. The wage rate shall be 113% of the straight time hourly wage rate. Benefits for off-shift work shall be paid at the straight time rate.

(Local #1556)

TUNNEL WORKER

Blasters, Mucking Machine Operators (Compressed Air Rates)

Effective Period: 7/1/2023 - 6/30/2024

Wage Rate per Hour: **\$71.86**

Supplemental Benefit Rate per Hour: **\$63.35**

OFFICE OF THE COMPTROLLER, CITY OF NEW YORK
CONSTRUCTION WORKER PREVAILING WAGE SCHEDULE

Tunnel Workers (Compressed Air Rates)

Includes shield driven liner plate portions or solidification portions work (8 hour shift) during excavation phase.

Effective Period: 7/1/2023 - 6/30/2024

Wage Rate per Hour: **\$69.30**

Supplemental Benefit Rate per Hour: **\$61.35**

Top Nipper (Compressed Air Rates)

Effective Period: 7/1/2023 - 6/30/2024

Wage Rate per Hour: **\$68.14**

Supplemental Benefit Rate per Hour: **\$60.14**

Outside Lock Tender, Outside Gauge Tender, Muck Lock Tender (Compressed Air Rates)

Effective Period: 7/1/2023 - 6/30/2024

Wage Rate per Hour: **\$66.78**

Supplemental Benefit Rate per Hour: **\$59.16**

Bottom Bell & Top Bell Signal Person: Shaft Person (Compressed Air Rates)

Effective Period: 7/1/2023 - 6/30/2024

Wage Rate per Hour: **\$66.78**

Supplemental Benefit Rate per Hour: **\$59.16**

Changehouse Attendant: Powder Watchperson (Compressed Air Rates)

Effective Period: 7/1/2023 - 6/30/2024

Wage Rate per Hour: **\$58.80**

Supplemental Benefit Rate per Hour: **\$55.51**

Blasters (Free Air Rates)

Effective Period: 7/1/2023 - 6/30/2024

Wage Rate per Hour: **\$68.55**

Supplemental Benefit Rate per Hour: **\$60.82**

Tunnel Workers (Free Air Rates)

Effective Period: 7/1/2023 - 6/30/2024

Wage Rate per Hour: **\$65.58**

Supplemental Benefit Rate per Hour: **\$58.28**

All Others (Free Air Rates)

Effective Period: 7/1/2023 - 6/30/2024

OFFICE OF THE COMPTROLLER, CITY OF NEW YORK
CONSTRUCTION WORKER PREVAILING WAGE SCHEDULE

Wage Rate per Hour: **\$60.62**

Supplemental Benefit Rate per Hour: **\$53.94**

Microtunneling (Free Air Rates)

Effective Period: 7/1/2023 - 6/30/2024

Wage Rate per Hour: **\$52.46**

Supplemental Benefit Rate per Hour: **\$46.62**

Overtime Description

For work performed during excavation and primary concrete tunnel lining phases - Double time the regular rate after an 8 hour day and Saturday, Sunday and on the following holiday(s) listed below.

For Repair-Maintenance Work on Existing Equipment and Facilities - Time and one half the regular rate after a 8 hour day, Saturday, Sunday and double time the regular rate for work on the following holiday(s) listed below.

For Small-Bore Micro Tunneling Machines - Time and one-half the regular rate shall be paid for all overtime.

For work not listed above - Time and one half the regular rate after an 8 hour day and Saturday and double time the regular rate on Sunday and on the following holiday(s) listed below.

Paid Holidays

New Year's Day

Martin Luther King Jr. Day

President's Day

Memorial Day

Independence Day

Labor Day

Columbus Day

Veteran's Day

Thanksgiving Day

Day after Thanksgiving

Christmas Day

(Local #147)

UTILITY LOCATOR

(Locate & mark underground utilities for street excavation.)

Utility Locator (Year 7 and above)

Effective Period: 7/1/2023 - 6/30/2024

Wage Rate per Hour: **\$31.56**

Supplemental Benefit Rate per Hour: **\$1.43**

Utility Locator (Year 5 - 6)

Effective Period: 7/1/2023 - 6/30/2024

OFFICE OF THE COMPTROLLER, CITY OF NEW YORK
CONSTRUCTION WORKER PREVAILING WAGE SCHEDULE

Wage Rate per Hour: **\$22.85**

Supplemental Benefit Rate per Hour: **\$1.43**

Utility Locator (Year 4)

Effective Period: 7/1/2023 - 6/30/2024

Wage Rate per Hour: **\$21.54**

Supplemental Benefit Rate per Hour: **\$1.43**

Utility Locator (Year 3)

Effective Period: 7/1/2023 - 6/30/2024

Wage Rate per Hour: **\$20.30**

Supplemental Benefit Rate per Hour: **\$1.43**

Utility Locator (Year 2)

Effective Period: 7/1/2023 - 6/30/2024

Wage Rate per Hour: **\$19.13**

Supplemental Benefit Rate per Hour: **\$1.43**

Utility Locator (Year 1)

Effective Period: 7/1/2023 - 6/30/2024

Wage Rate per Hour: **\$18.04**

Supplemental Benefit Rate per Hour: **\$1.43**

Utility Locator (Up to 1 year)

Effective Period: 7/1/2023 - 6/30/2024

Wage Rate per Hour: **\$17.00**

Supplemental Benefit Rate per Hour: **\$1.43**

Supplemental Note: No benefits for the first 90 days of employment.

Overtime

Time and one half the regular rate for work on the following holiday(s).

Time and one half the regular hourly rate after 40 straight time hours in any work week.

Paid Holidays

New Year's Day

Memorial Day

Independence Day

Thanksgiving Day

Christmas Day

Shift Rates

10% shift differential to employees working any shift starting between noon and 5 AM.

Vacation

OFFICE OF THE COMPTROLLER, CITY OF NEW YORK
CONSTRUCTION WORKER PREVAILING WAGE SCHEDULE

For up to 1 year 0 hours
For year 1 - 2 48 hours per year
For year 3 - 9 96 hours per year
For year 10 or more 144 hours per year

Sick Days:

For up to 1 year employee receives 40 hours paid sick leave.
For year 1 employee earns 2 hours of paid sick leave for every 100 overtime hours worked.
For year 2 - 9 years employee earns 4 hours of paid sick leave for every 100 overtime hours worked.
For year 10 or more employee earns 6 hours of paid sick leave for every 100 overtime hours worked.

(C.W.A.)

WELDER

**WELDER AND FIREWATCH TO BE PAID AT THE RATE OF THE
JOURNEYPERSON OR REGISTERED APPRENTICE IN THE TRADE
PERFORMING THE WORK.**

OFFICE OF THE COMPTROLLER

CITY OF NEW YORK

**CONSTRUCTION APPRENTICE
PREVAILING WAGE SCHEDULE**

Pursuant to Labor Law § 220 (3-e), only apprentices who are individually registered in a bona fide program to which the employer contractor is a participant and registered with the New York State Department of Labor, may be paid at the apprentice rates in this schedule. Apprentices who are not so registered must be paid as journey persons in accordance with the trade classification of the work they actually performed.

Apprentice ratios are established to ensure the proper safety, training and supervision of apprentices. A ratio establishes the number of journey workers required for each apprentice in a program and on a job site. Ratios are interpreted as follows: in the case of a 1:1, 1:4 ratio, there must be one journey worker for the first apprentice, and four additional journey workers for each subsequent apprentice.

ADDENDUM

List of Amended Classifications

1. BRICKLAYER
2. HAZARDOUS MATERIAL HANDLER
3. HOUSE WRECKER
4. IRON WORKER - ORNAMENTAL
5. IRON WORKER - STRUCTURAL
6. MASON TENDER
7. MASON TENDER (INTERIOR DEMOLITION WORKER)
8. PLUMBER
9. SHEET METAL WORKER
10. STEAMFITTER - REFRIGERATION AND AIR CONDITIONER
11. TAPER

OFFICE OF THE COMPTROLLER, CITY OF NEW YORK
CONSTRUCTION APPRENTICE PREVAILING WAGE SCHEDULE

TABLE OF CONTENTS

<u>CLASSIFICATION</u>	<u>PAGE</u>
BOILERMAKER.....	4
BRICKLAYER.....	5
CARPENTER.....	6
CARPENTER - HIGH RISE CONCRETE FORMS.....	7
CEMENT AND CONCRETE WORKER.....	8
CEMENT MASON.....	8
DERRICKPERSON & RIGGER (STONE).....	9
DOCKBUILDER/PILE DRIVER.....	9
ELECTRICIAN.....	10
ELEVATOR CONSTRUCTOR.....	13
ELEVATOR REPAIR & MAINTENANCE.....	14
ENGINEER.....	14
ENGINEER - OPERATING.....	15
FLOOR COVERER.....	16
GLAZIER.....	16
HAZARDOUS MATERIAL HANDLER.....	17
HEAT & FROST INSULATOR.....	18
HOUSE WRECKER.....	19
IRON WORKER - ORNAMENTAL.....	20
IRON WORKER - STRUCTURAL.....	21
LABORER (FOUNDATION, CONCRETE, EXCAVATING, STREET PIPE LAYER & COMMON).....	22
MARBLE MECHANICS.....	22
MASON TENDER.....	24
MASON TENDER (INTERIOR DEMOLITION WORKER).....	25
METALLIC LATHER.....	26
MILLWRIGHT.....	27
PAINTER.....	27
PAINTER - METAL POLISHER.....	28
PAINTER - STRUCTURAL STEEL.....	29
PAVER AND ROADBUILDER.....	29
PAVER AND ROADBUILDER - LINE STRIPING (ROADWAY).....	30
PLASTERER.....	30
PLASTERER - TENDER.....	31
PLUMBER.....	32
POINTER, WATERPROOFER, CAULKER, SANDBLASTER, STEAMBLASTER.....	33
ROOFER.....	34
SHEET METAL WORKER.....	35
SIGN ERECTOR.....	37
STEAMFITTER.....	38
STEAMFITTER - REFRIGERATION & AIR CONDITIONER.....	39
STONE MASON - SETTER.....	40
TAPER.....	41
TILE LAYER - SETTER.....	42
TIMBERPERSON.....	43

BOILERMAKER

(Ratio of Apprentice to Journeyman: 1 to 1, 1 to 3)

Boilermaker (First Year)

Effective Period: 7/1/2023 - 6/30/2024
Wage Rate Per Hour: 65% of Journeyman's rate
Supplemental Benefit Rate Per Hour: \$34.37

Boilermaker (Second Year: 1st Six Months)

Effective Period: 7/1/2023 - 6/30/2024
Wage Rate Per Hour: 70% of Journeyman's rate
Supplemental Benefit Rate Per Hour: \$36.39

Boilermaker (Second Year: 2nd Six Months)

Effective Period: 7/1/2023 - 6/30/2024
Wage Rate Per Hour: 75% of Journeyman's rate
Supplemental Benefit Rate Per Hour: \$38.41

Boilermaker (Third Year: 1st Six Months)

Effective Period: 7/1/2023 - 6/30/2024
Wage Rate Per Hour: 80% of Journeyman's rate
Supplemental Benefit Rate Per Hour: \$40.40

Boilermaker (Third Year: 2nd Six Months)

Effective Period: 7/1/2023 - 6/30/2024
Wage Rate Per Hour: 85% of Journeyman's rate
Supplemental Benefit Rate Per Hour: \$42.43

Boilermaker (Fourth Year: 1st Six Months)

Effective Period: 7/1/2023 - 6/30/2024
Wage Rate Per Hour: 90% of Journeyman's rate
Supplemental Benefit Rate Per Hour: \$44.44

Boilermaker (Fourth Year: 2nd Six Months)

Effective Period: 7/1/2023 - 6/30/2024
Wage Rate Per Hour: 95% of Journeyman's rate
Supplemental Benefit Rate Per Hour: \$46.46

(Local #5)

BRICKLAYER

(Ratio of Apprentice to Journeyman: 1 to 1, 1 to 4)

Bricklayer (First 750 Hours)

Effective Period: 7/1/2023 - 1/14/2024

Wage Rate Per Hour: 50% of Journeyman's rate

Supplemental Benefit Rate Per Hour: \$22.60

Effective Period: 1/15/2024 - 6/30/2024

Wage Rate Per Hour: 50% of Journeyman's rate

Supplemental Benefit Rate Per Hour: \$23.75

Bricklayer (Second 750 Hours)

Effective Period: 7/1/2023 - 1/14/2024

Wage Rate Per Hour: 60% of Journeyman's rate

Supplemental Benefit Rate Per Hour: \$22.60

Effective Period: 1/15/2024 - 6/30/2024

Wage Rate Per Hour: 60% of Journeyman's rate

Supplemental Benefit Rate Per Hour: 23.75

Bricklayer (Third 750 Hours)

Effective Period: 7/1/2023 - 1/14/2024

Wage Rate Per Hour: 70% of Journeyman's rate

Supplemental Benefit Rate Per Hour: \$22.60

Effective Period: 1/15/2024 - 6/30/2024

Wage Rate Per Hour: 70% of Journeyman's rate

Supplemental Benefit Rate Per Hour: \$23.75

Bricklayer (Fourth 750 Hours)

Effective Period: 7/1/2023 - 1/14/2024

Wage Rate Per Hour: 80% of Journeyman's rate

Supplemental Benefit Rate Per Hour: \$22.60

Effective Period: 1/15/2024 - 6/30/2024

Wage Rate Per Hour: 80% of Journeyman's rate

Supplemental Benefit Rate Per Hour: \$ 23.75

Bricklayer (Fifth 750 Hours)

Effective Period: 7/1/2023 - 1/14/2024

OFFICE OF THE COMPTROLLER, CITY OF NEW YORK
CONSTRUCTION APPRENTICE PREVAILING WAGE SCHEDULE

Wage Rate Per Hour: 90% of Journeyperson's rate
Supplemental Benefit Rate Per Hour: \$22.60

Effective Period: 1/15/2024 - 6/30/2024
Wage Rate Per Hour: 90% of Journeyperson's rate
Supplemental Benefit Rate Per Hour: \$23.75

Bricklayer (Sixth 750 Hours)

Effective Period: 7/1/2023 - 1/14/2024
Wage Rate Per Hour: 95% of Journeyperson's rate
Supplemental Benefit Rate Per Hour: \$22.60

Effective Period: 1/15/2024 - 6/30/2024
Wage Rate Per Hour: 95% of Journeyperson's rate
Supplemental Benefit Rate Per Hour: \$23.75

(Bricklayer District Council)

CARPENTER
(Ratio of Apprentice to Journeyperson: 1 to 1, 1 to 4)

Carpenter (First Year)

Effective Period: 7/1/2023 - 6/30/2024
Wage Rate Per Hour For Building Apprentice: \$20.20
Supplemental Benefit Rate Per Hour For Building Apprentice: \$17.25

Wage Rate Per Hour For Heavy Apprentice: \$25.60
Supplemental Benefit Rate Per Hour For Heavy Apprentice: \$37.31

Carpenter (Second Year)

Effective Period: 7/1/2023 - 6/30/2024
Wage Rate Per Hour For Building Apprentice: \$23.20
Supplemental Benefit Rate Per Hour For Building Apprentice: \$18.75

Wage Rate Per Hour For Heavy Apprentice: \$31.20
Supplemental Benefit Rate Per Hour For Heavy Apprentice: \$37.31

Carpenter (Third Year)

Effective Period: 7/1/2023 - 6/30/2024
Wage Rate Per Hour For Building Apprentice: \$27.45
Supplemental Benefit Rate Per Hour For Building Apprentice: \$22.35

OFFICE OF THE COMPTROLLER, CITY OF NEW YORK
CONSTRUCTION APPRENTICE PREVAILING WAGE SCHEDULE

Wage Rate Per Hour For Heavy Apprentice: \$39.58
Supplemental Benefit Rate Per Hour For Heavy Apprentice: \$37.31

Carpenter (Fourth Year)

Effective Period: 7/1/2023 - 6/30/2024
Wage Rate Per Hour For Building Apprentice: \$35.33
Supplemental Benefit Rate Per Hour For Building Apprentice: \$24.35

Wage Rate Per Hour For Heavy Apprentice: \$47.97
Supplemental Benefit Rate Per Hour For Heavy Apprentice: \$37.31

(Carpenters District Council)

**CARPENTER - HIGH RISE CONCRETE FORMS
(Ratio of Apprentice to Journeyperson: 1 to 1, 2 to 5)**

Carpenter - High Rise (First Year)

Effective Period: 7/1/2023 - 6/30/2024
Wage Rate per Hour: \$18.27
Supplemental Benefit Rate per Hour: \$17.55

Carpenter - High Rise (Second Year)

Effective Period: 7/1/2023 - 6/30/2024
Wage Rate per Hour: \$24.70
Supplemental Benefit Rate per Hour: \$17.68

Carpenter - High Rise (Third Year)

Effective Period: 7/1/2023 - 6/30/2024
Wage Rate per Hour: \$31.28
Supplemental Benefit Rate per Hour: \$17.81

Carpenter - High Rise (Fourth Year)

Effective Period: 7/1/2023 - 6/30/2024
Wage Rate per Hour: \$38.90
Supplemental Benefit Rate per Hour: \$17.96

(Carpenters District Council)

CEMENT AND CONCRETE WORKER
(Ratio of Apprentice to Journeyman: 1 to 1, 1 to 3)

Cement & Concrete Worker (First 1333 hours)

Effective Period: 7/1/2023 - 6/30/2024
Wage Rate Per Hour: 53% of Journeyman's rate
Supplemental Benefit Rate Per Hour: \$14.79

Cement & Concrete Worker (Second 1333 hours)

Effective Period: 7/1/2023 - 6/30/2024
Wage Rate Per Hour: 69% of Journeyman's rate
Supplemental Benefit Rate Per Hour: \$19.72

Cement & Concrete Worker (Last 1334 hours)

Effective Period: 7/1/2023 - 6/30/2024
Wage Rate Per Hour: 85% of Journeyman's rate
Supplemental Benefit Rate Per Hour: \$21.30

(Cement Concrete Workers District Council)

CEMENT MASON
(Ratio of Apprentice to Journeyman: 1 to 1, 1 to 4)

Cement Mason (First Year)

Effective Period: 7/1/2023 - 6/30/2024
Wage Rate per Hour: \$19.92
Supplemental Benefit Rate per Hour: \$15.61

Cement Mason (Second Year)

Effective Period: 7/1/2023 - 6/30/2024
Wage Rate per Hour: \$24.82
Supplemental Benefit Rate per Hour: \$15.91

Cement Mason (Third Year)

OFFICE OF THE COMPTROLLER, CITY OF NEW YORK
CONSTRUCTION APPRENTICE PREVAILING WAGE SCHEDULE

Effective Period: 7/1/2023 - 6/30/2024

Wage Rate per Hour: \$30.22

Supplemental Benefit Rate per Hour: \$16.02

(Local #780)

DERRICKPERSON & RIGGER (STONE)
(Ratio of Apprentice to Journeyman: 1 to 1, 1 to 4)

Derrickperson & Rigger (stone) - First Year

Effective Period: 7/1/2023 - 6/30/2024

Wage Rate Per Hour: 50% of Journeyman's rate

Supplemental Benefit Rate Per Hour: 50% of Journeyman's rate

Derrickperson & Rigger (stone) - Second Year: 1st Six Months

Effective Period: 7/1/2023 - 6/30/2024

Wage Rate Per Hour: 70% of Journeyman's rate

Supplemental Benefit Rate Per Hour: 75% of Journeyman's rate

Derrickperson & Rigger (stone) - Second Year: 2nd Six Months

Effective Period: 7/1/2023 - 6/30/2024

Wage Rate Per Hour: 80% of Journeyman's rate

Supplemental Benefit Rate Per Hour: 75% of Journeyman's rate

Derrickperson & Rigger (stone) - Third Year

Effective Period: 7/1/2023 - 6/30/2024

Wage Rate Per Hour: 90% of Journeyman's rate

Supplemental Benefit Rate Per Hour: 75% of Journeyman's rate

(Local #197)

DOCKBUILDER/PILE DRIVER
(Ratio of Apprentice to Journeyman: 1 to 1, 1 to 6)

OFFICE OF THE COMPTROLLER, CITY OF NEW YORK
CONSTRUCTION APPRENTICE PREVAILING WAGE SCHEDULE

Dockbuilder/Pile Driver (First Year)

Effective Period: 7/1/2023 - 6/30/2024
Wage Rate Per Hour: \$25.60
Supplemental Benefit Rate Per Hour: \$37.31

Dockbuilder/Pile Driver (Second Year)

Effective Period: 7/1/2023 - 6/30/2024
Wage Rate Per Hour: \$31.20
Supplemental Benefit Rate Per Hour: \$37.31

Dockbuilder/Pile Driver (Third Year)

Effective Period: 7/1/2023 - 6/30/2024
Wage Rate Per Hour: \$39.58
Supplemental Benefit Rate Per Hour: \$37.31

Dockbuilder/Pile Driver (Fourth Year)

Effective Period: 7/1/2023 - 6/30/2024
Wage Rate Per Hour: \$47.97
Supplemental Benefit Rate Per Hour: \$37.31

(Carpenters District Council)

ELECTRICIAN

(Ratio of Apprentice to Journeyman: 1 to 1, 1 to 3)

Electrician (First Term: 0-6 Months)

Effective Period: 7/1/2023 - 4/12/2024
Wage Rate per Hour: \$18.00
Supplemental Benefit Rate per Hour: \$16.43
Overtime Supplemental Rate Per Hour: \$17.63

Effective Period: 4/13/2024 - 6/30/2024
Wage Rate per Hour: \$18.00
Supplemental Benefit Rate per Hour: \$17.18
Overtime Supplemental Rate Per Hour: \$18.38

Electrician (First Term: 7-12 Months)

Effective Period: 7/1/2023 - 4/12/2024

OFFICE OF THE COMPTROLLER, CITY OF NEW YORK
CONSTRUCTION APPRENTICE PREVAILING WAGE SCHEDULE

Wage Rate per Hour: **\$18.50**
Supplemental Benefit Rate per Hour: **\$16.69**
Overtime Supplemental Rate Per Hour: **\$17.92**

Effective Period: 4/13/2024 - 6/30/2024
Wage Rate per Hour: **\$18.50**
Supplemental Benefit Rate per Hour: **\$17.44**
Overtime Supplemental Rate Per Hour: **\$18.67**

Electrician (Second Term: 0-6 Months)

Effective Period: 7/1/2023 - 4/12/2024
Wage Rate per Hour: **\$19.50**
Supplemental Benefit Rate per Hour: **\$17.22**
Overtime Supplemental Rate Per Hour: **\$18.51**

Effective Period: 4/13/2024 - 6/30/2024
Wage Rate per Hour: **\$19.50**
Supplemental Benefit Rate per Hour: **\$17.97**
Overtime Supplemental Rate Per Hour: **\$19.26**

Electrician (Second Term: 7-12 Months)

Effective Period: 7/1/2023 - 4/12/2024
Wage Rate per Hour: **\$20.50**
Supplemental Benefit Rate per Hour: **\$17.74**
Overtime Supplemental Rate Per Hour: **\$19.10**

Effective Period: 4/13/2024 - 6/30/2024
Wage Rate per Hour: **\$20.50**
Supplemental Benefit Rate per Hour: **\$18.49**
Overtime Supplemental Rate Per Hour: **\$19.85**

Electrician (Third Term: 0-6 Months)

Effective Period: 7/1/2023 - 4/12/2024
Wage Rate per Hour: **\$21.50**
Supplemental Benefit Rate per Hour: **\$18.27**
Overtime Supplemental Rate Per Hour: **\$19.69**

Effective Period: 4/13/2024 - 6/30/2024
Wage Rate per Hour: **\$21.50**
Supplemental Benefit Rate per Hour: **\$19.02**
Overtime Supplemental Rate Per Hour: **\$20.44**

Electrician (Third Term: 7-12 Months)

Effective Period: 7/1/2023 - 4/12/2024

OFFICE OF THE COMPTROLLER, CITY OF NEW YORK
CONSTRUCTION APPRENTICE PREVAILING WAGE SCHEDULE

Wage Rate per Hour: **\$22.50**
Supplemental Benefit Rate per Hour: **\$18.79**
Overtime Supplemental Rate Per Hour: **\$20.28**

Effective Period: 4/13/2024 - 6/30/2024
Wage Rate per Hour: **\$22.50**
Supplemental Benefit Rate per Hour: **\$19.54**
Overtime Supplemental Rate Per Hour: **\$21.03**

Electrician (Fourth Term: 0-6 Months)

Effective Period: 7/1/2023 - 4/12/2024
Wage Rate per Hour: **\$23.50**
Supplemental Benefit Rate per Hour: **\$19.31**
Overtime Supplemental Rate Per Hour: **\$20.87**

Effective Period: 4/13/2024 - 6/30/2024
Wage Rate per Hour: **\$23.50**
Supplemental Benefit Rate per Hour: **\$20.06**
Overtime Supplemental Rate Per Hour: **\$21.62**

Electrician (Fourth Term: 7-12 Months)

Effective Period: 7/1/2023 - 4/12/2024
Wage Rate per Hour: **\$25.50**
Supplemental Benefit Rate per Hour: **\$20.36**
Overtime Supplemental Rate Per Hour: **\$22.05**

Effective Period: 4/13/2024 - 6/30/2024
Wage Rate per Hour: **\$25.50**
Supplemental Benefit Rate per Hour: **\$21.11**
Overtime Supplemental Rate Per Hour: **\$22.80**

Electrician (Fifth Term: 0-12 Months)

Effective Period: 7/1/2023 - 4/12/2024
Wage Rate per Hour: **\$26.75**
Supplemental Benefit Rate per Hour: **\$24.13**
Overtime Supplemental Rate Per Hour: **\$25.82**

Effective Period: 4/13/2024 - 6/30/2024
Wage Rate per Hour: **\$27.50**
Supplemental Benefit Rate per Hour: **\$24.79**
Overtime Supplemental Rate Per Hour: **\$26.52**

Electrician (Fifth Term: 13-18 Months)

Effective Period: 7/1/2023 - 4/12/2024
Wage Rate per Hour: **\$31.25**
Supplemental Benefit Rate per Hour: **\$26.55**

OFFICE OF THE COMPTROLLER, CITY OF NEW YORK
CONSTRUCTION APPRENTICE PREVAILING WAGE SCHEDULE

Overtime Supplemental Rate Per Hour: \$28.53

Effective Period: 4/13/2024 - 6/30/2024

Wage Rate per Hour: \$32.00

Supplemental Benefit Rate per Hour: \$27.20

Overtime Supplemental Rate Per Hour: \$29.23

Overtime Description

Overtime Wage paid at time and one half the regular rate

(Local #3)

ELEVATOR CONSTRUCTOR

(Ratio of Apprentice to Journeyman: 1 to 1, 1 to 2)

Elevator (Constructor) - First Year

Effective Period: 7/1/2023 - 6/30/2024

Wage Rate Per Hour: 50% of Journeyman's rate

Supplemental Rate Per Hour: \$34.18

Elevator (Constructor) - Second Year

Effective Period: 7/1/2023 - 6/30/2024

Wage Rate Per Hour: 55% of Journeyman's rate

Supplemental Rate Per Hour: \$34.79

Elevator (Constructor) - Third Year

Effective Period: 7/1/2023 - 6/30/2024

Wage Rate Per Hour: 65% of Journeyman's rate

Supplemental Rate Per Hour: \$36.01

Elevator (Constructor) - Fourth Year

Effective Period: 7/1/2023 - 6/30/2024

Wage Rate Per Hour: 75% of Journeyman's rate

Supplemental Rate Per Hour: \$37.23

(Local #1)

ELEVATOR REPAIR & MAINTENANCE
(Ratio of Apprentice to Journeyman: 1 to 1, 1 to 2)

Elevator Service/Modernization Mechanic (First Year)

Effective Period: 7/1/2023 - 6/30/2024
Wage Rate Per Hour: 50% of Journeyman's rate
Supplemental Benefit Per Hour: \$34.59

Elevator Service/Modernization Mechanic (Second Year)

Effective Period: 7/1/2023 - 6/30/2024
Wage Rate Per Hour: 55% of Journeyman's rate
Supplemental Benefit Per Hour: \$35.18

Elevator Service/Modernization Mechanic (Third Year)

Effective Period: 7/1/2023 - 6/30/2024
Wage Rate Per Hour: 65% of Journeyman's rate
Supplemental Benefit Per Hour: \$36.37

Elevator Service/Modernization Mechanic (Fourth Year)

Effective Period: 7/1/2023 - 6/30/2024
Wage Rate Per Hour: 75% of Journeyman's rate
Supplemental Benefit Per Hour: \$37.55

(Local #1)

ENGINEER
(Ratio of Apprentice to Journeyman: 1 to 1, 1 to 5)

Engineer - First Year

Effective Period: 7/1/2023 - 6/30/2024
Wage Rate per Hour: \$27.47
Supplemental Benefit Rate per Hour: \$32.38

Engineer - Second Year

OFFICE OF THE COMPTROLLER, CITY OF NEW YORK
CONSTRUCTION APPRENTICE PREVAILING WAGE SCHEDULE

Effective Period: 7/1/2023 - 6/30/2024

Wage Rate per Hour: **\$34.34**

Supplemental Benefit Rate per Hour: **\$32.38**

Engineer - Third Year

Effective Period: 7/1/2023 - 6/30/2024

Wage Rate per Hour: **\$37.77**

Supplemental Benefit Rate per Hour: **\$32.38**

Engineer - Fourth Year

Effective Period: 7/1/2023 - 6/30/2024

Wage Rate per Hour: **\$41.21**

Supplemental Benefit Rate per Hour: **\$32.38**

(Local #15)

ENGINEER - OPERATING

(Ratio of Apprentice to Journeyman: 1 to 1, 1 to 5)

Operating Engineer - First Year

Effective Period: 7/1/2023 - 6/30/2024

Wage Rate Per Hour: 40% of Operating Engineer - Road & Heavy Construction V's Rate

Supplemental Benefit Per Hour: **\$25.55**

Operating Engineer - Second Year

Effective Period: 7/1/2023 - 6/30/2024

Wage Rate Per Hour: 50% of Operating Engineer - Road & Heavy Construction V's Rate

Supplemental Benefit Per Hour: **\$25.55**

Operating Engineer - Third Year

Effective Period: 7/1/2023 - 6/30/2024

Wage Rate Per Hour: 60% of Operating Engineer - Road & Heavy Construction V's Rate

Supplemental Benefit Per Hour: **\$25.55**

(Local #14)

FLOOR COVERER

(Ratio of Apprentice to Journeyman: 1 to 1, 1 to 4)

Floor Coverer (First Year)

Effective Period: 7/1/2023 - 6/30/2024

Wage Rate per Hour: **\$25.20**

Supplemental Benefit Rate per Hour: **\$17.25**

Floor Coverer (Second Year)

Effective Period: 7/1/2023 - 6/30/2024

Wage Rate per Hour: **\$28.20**

Supplemental Benefit Rate per Hour: **\$18.75**

Floor Coverer (Third Year)

Effective Period: 7/1/2023 - 6/30/2024

Wage Rate per Hour: **\$32.45**

Supplemental Benefit Rate per Hour: **\$22.35**

Floor Coverer (Fourth Year)

Effective Period: 7/1/2023 - 6/30/2024

Wage Rate per Hour: **\$40.33**

Supplemental Benefit Rate per Hour: **\$24.35**

(Carpenters District Council)

GLAZIER

(Ratio of Apprentice to Journeyman: 1 to 1, 1 to 3)

Glazier (First Year)

Effective Period: 7/1/2023 - 6/30/2024

Wage and Supplemental Rate Per Hour: 40% of Journeyman's rate

Glazier (Second Year)

Effective Period: 7/1/2023 - 6/30/2024

OFFICE OF THE COMPTROLLER, CITY OF NEW YORK
CONSTRUCTION APPRENTICE PREVAILING WAGE SCHEDULE

Wage and Supplemental Rate Per Hour: 50% of Journeyperson's rate

Glazier (Third Year)

Effective Period: 7/1/2023 - 6/30/2024

Wage and Supplemental Rate Per Hour: 60% of Journeyperson's rate

Glazier (Fourth Year)

Effective Period: 7/1/2023 - 6/30/2024

Wage and Supplemental Rate Per Hour: 80% of Journeyperson's rate

(Local #1281)

HAZARDOUS MATERIAL HANDLER
(Ratio of Apprentice Journeyperson: 1 to 1, 1 to 3)

Handler (First 1000 Hours)

Effective Period: 7/1/2023 - 1/14/2024

Wage Rate per Hour: **\$20.00**

Supplemental Benefit Rate per Hour: **\$14.75**

Effective Period: 1/15/2024 - 6/30/2024

Wage Rate per Hour: **\$20.00**

Supplemental Benefit Rate per Hour: **\$15.35**

Handler (Second 1000 Hours)

Effective Period: 7/1/2023 - 1/14/2024

Wage Rate per Hour: **\$21.00**

Supplemental Benefit Rate per Hour: **\$14.75**

Effective Period: 1/15/2024 - 6/30/2024

Wage Rate per Hour: **\$21.00**

Supplemental Benefit Rate per Hour: **\$15.35**

Handler (Third 1000 Hours)

Effective Period: 7/1/2023 - 1/14/2024

Wage Rate per Hour: **\$24.00**

Supplemental Benefit Rate per Hour: **\$14.75**

Effective Period: 1/15/2024 - 6/30/2024

OFFICE OF THE COMPTROLLER, CITY OF NEW YORK
CONSTRUCTION APPRENTICE PREVAILING WAGE SCHEDULE

Wage Rate per Hour: **\$24.00**
Supplemental Benefit Rate per Hour: **\$15.35**

Handler (Fourth 1000 Hours)

Effective Period: 7/1/2023 - 1/14/2024
Wage Rate per Hour: **\$26.00**
Supplemental Benefit Rate per Hour: **\$14.75**

Effective Period: 1/15/2024 - 6/30/2024
Wage Rate per Hour: **\$26.00**
Supplemental Benefit Rate per Hour: **\$15.35**

(Local #78)

HEAT & FROST INSULATOR
(Ratio of Apprentice to Journeyman: 1 to 1, 1 to 3)

Heat & Frost Insulator (First Year)

Effective Period: 7/1/2023 - 6/30/2024
Wage and Supplemental Rate Per Hour: 40% of Journeyman's rate

Heat & Frost Insulator (Second Year)

Effective Period: 7/1/2023 - 6/30/2024
Wage and Supplemental Rate Per Hour: 50% of Journeyman's rate

Heat & Frost Insulator (Third Year)

Effective Period: 7/1/2023 - 6/30/2024
Wage and Supplemental Rate Per Hour: 60% of Journeyman's rate

Heat & Frost Insulator (Fourth Year)

Effective Period: 7/1/2023 - 6/30/2024
Wage and Supplemental Rate Per Hour: 70% of Journeyman's rate

(Local #12)

**HOUSE WRECKER
(TOTAL DEMOLITION)
(Ratio of Apprentice to Journeyperson: 1 to 1, 1 to 3)**

House Wrecker - First Year

Effective Period: 7/1/2023 - 1/14/2024
Wage Rate per Hour: **\$21.30**
Supplemental Benefit Rate per Hour: **\$10.97**

Effective Period: 1/15/2024 - 6/30/2024
Wage Rate per Hour: **\$21.55**
Supplemental Benefit Rate per Hour: **\$11.27**

House Wrecker - Second Year

Effective Period: 7/1/2023 - 1/14/2024
Wage Rate per Hour: **\$23.05**
Supplemental Benefit Rate per Hour: **\$10.97**

Effective Period: 1/15/2024 - 6/30/2024
Wage Rate per Hour: **\$23.30**
Supplemental Benefit Rate per Hour: **\$11.27**

House Wrecker - Third Year

Effective Period: 7/1/2023 - 1/14/2024
Wage Rate per Hour: **\$24.55**
Supplemental Benefit Rate per Hour: **\$10.97**

Effective Period: 1/15/2024 - 6/30/2024
Wage Rate per Hour: **\$24.80**
Supplemental Benefit Rate per Hour: **\$11.27**

House Wrecker - Fourth Year

Effective Period: 7/1/2023 - 1/14/2024
Wage Rate per Hour: **\$27.05**
Supplemental Benefit Rate per Hour: **\$10.97**

Effective Period: 1/15/2024 - 6/30/2024
Wage Rate per Hour: **\$27.30**
Supplemental Benefit Rate per Hour: **\$11.27**

(Mason Tenders District Council)

IRON WORKER - ORNAMENTAL

(Ratio of Apprentice to Journeyman: 1 to 1, 1 to 4)

Iron Worker (Ornamental) - First Year

Effective Period: 7/1/2023 - 1/14/2024

Wage Rate per Hour: **\$25.98**

Supplemental Benefit Rate per Hour: **\$16.00**

Effective Period: 1/15/2024 - 6/30/2024

Wage Rate per Hour: **\$26.45**

Supplemental Benefit Rate per Hour: **\$16.00**

Iron Worker (Ornamental) - Second Year

Effective Period: 7/1/2023 - 1/23/2024

Wage Rate per Hour: **\$28.45**

Supplemental Benefit Rate per Hour: **\$18.00**

Effective Period: 1/24/2024 - 6/30/2024

Wage Rate per Hour: **\$28.97**

Supplemental Benefit Rate per Hour: **\$18.00**

Iron Worker (Ornamental) - Third Year

Effective Period: 7/1/2023 - 1/14/2024

Wage Rate per Hour: **\$30.80**

Supplemental Benefit Rate per Hour: **\$19.00**

Effective Period: 1/15/2024 - 6/30/2024

Wage Rate per Hour: **\$31.36**

Supplemental Benefit Rate per Hour: **\$19.00**

Iron Worker (Ornamental) - Fourth Year

Effective Period: 7/1/2023 - 1/14/2024

Wage Rate per Hour: **\$34.39**

Supplemental Benefit Rate per Hour: **\$21.00**

Effective Period: 1/15/2024 - 6/30/2024

Wage Rate per Hour: **\$35.02**

Supplemental Benefit Rate per Hour: **\$21.00**

OFFICE OF THE COMPTROLLER, CITY OF NEW YORK
CONSTRUCTION APPRENTICE PREVAILING WAGE SCHEDULE

(Local #580)

IRON WORKER - STRUCTURAL
(Ratio of Apprentice to Journeyperson: 1 to 1, 1 to 6)

Iron Worker (Structural) - 1st Six Months

Effective Period: 7/1/2023 - 1/14/2024
Wage Rate per Hour: **\$29.73**
Supplemental Benefit Rate per Hour: **\$60.12**

Effective Period: 1/15/2024 - 6/30/2024
Wage Rate per Hour: **\$29.98**
Supplemental Benefit Rate per Hour: **\$61.01**

Iron Worker (Structural) - 7- 18 Months

Effective Period: 7/1/2023 - 1/14/2024
Wage Rate per Hour: **\$30.33**
Supplemental Benefit Rate per Hour: **\$60.12**

Effective Period: 1/15/2024 - 6/30/2024
Wage Rate per Hour: **\$30.58**
Supplemental Benefit Rate per Hour: **\$61.01**

Iron Worker (Structural) - 19 - 36 months

Effective Period: 7/1/2023 - 1/14/2024
Wage Rate per Hour: **\$30.94**
Supplemental Benefit Rate per Hour: **\$60.12**

Effective Period: 1/15/2024 - 6/30/2024
Wage Rate per Hour: **\$31.19**
Supplemental Benefit Rate per Hour: **\$61.01**

(Local #40 and #361)

LABORER (FOUNDATION, CONCRETE, EXCAVATING, STREET PIPE LAYER & COMMON)

(Ratio Apprentice to Journeyman: 1 to 1, 1 to 3)

Laborer (Foundation, Concrete, Excavating, Street Pipe Layer & Common) - First 1000 hours

Effective Period: 7/1/2023 - 6/30/2024

Wage Rate Per Hour: 50% of Journeyman's rate

Supplemental Rate Per Hour: \$50.43

Laborer (Foundation, Concrete, Excavating, Street Pipe Layer & Common) - Second 1000 hours

Effective Period: 7/1/2023 - 6/30/2024

Wage Rate Per Hour: 60% of Journeyman's rate

Supplemental Rate Per Hour: \$50.43

Laborer (Foundation, Concrete, Excavating, Street Pipe Layer & Common) - Third 1000 hours

Effective Period: 7/1/2023 - 6/30/2024

Wage Rate Per Hour: 75% of Journeyman's rate

Supplemental Rate Per Hour: \$50.43

Laborer (Foundation, Concrete, Excavating, Street Pipe Layer & Common) - Fourth 1000 hours

Effective Period: 7/1/2023 - 6/30/2024

Wage Rate Per Hour: 90% of Journeyman's rate

Supplemental Rate Per Hour: \$50.43

(Local #731)

MARBLE MECHANICS

(Ratio of Apprentice to Journeyman: 1 to 1, 1 to 4)

Cutters & Setters - First 750 Hours

Effective Period: 7/1/2023 - 6/30/2024

Wage and Supplemental Rate Per Hour: 40% of Journeyman's rate

OFFICE OF THE COMPTROLLER, CITY OF NEW YORK
CONSTRUCTION APPRENTICE PREVAILING WAGE SCHEDULE

NO BENEFITS PAID DURING THE FIRST TWO MONTHS (PROBATIONARY PERIOD)

Cutters & Setters - Second 750 Hours

Effective Period: 7/1/2023 - 6/30/2024

Wage and Supplemental Rate Per Hour: 45% of Journeyperson's rate

Cutters & Setters - Third 750 Hours

Effective Period: 7/1/2023 - 6/30/2024

Wage and Supplemental Rate Per Hour: 50% of Journeyperson's rate

Cutters & Setters - Fourth 750 Hours

Effective Period: 7/1/2023 - 6/30/2024

Wage and Supplemental Rate Per Hour: 55% of Journeyperson's rate

Cutters & Setters - Fifth 750 Hours

Effective Period: 7/1/2023 - 6/30/2024

Wage and Supplemental Rate Per Hour: 60% of Journeyperson's rate

Cutters & Setters - Sixth 750 Hours

Effective Period: 7/1/2023 - 6/30/2024

Wage and Supplemental Rate Per Hour: 65% of Journeyperson's rate

Cutters & Setters - Seventh 750 Hours

Effective Period: 7/1/2023 - 6/30/2024

Wage and Supplemental Rate Per Hour: 70% of Journeyperson's rate

Cutters & Setters - Eighth 750 Hours

Effective Period: 7/1/2023 - 6/30/2024

Wage and Supplemental Rate Per Hour: 75% of Journeyperson's rate

Cutters & Setters - Ninth 750 Hours

Effective Period: 7/1/2023 - 6/30/2024

Wage and Supplemental Rate Per Hour: 85% of Journeyperson's rate

Cutters & Setters - Tenth 750 Hours

Effective Period: 7/1/2023 - 6/30/2024

Wage and Supplemental Rate Per Hour: 95% of Journeyperson's rate

Polishers & Finishers - First 900 Hours

Effective Period: 7/1/2023 - 6/30/2024

OFFICE OF THE COMPTROLLER, CITY OF NEW YORK
CONSTRUCTION APPRENTICE PREVAILING WAGE SCHEDULE

Wage and Supplemental Rate Per Hour: 70% of Journeyperson's rate

NO BENEFITS PAID DURING THE FIRST TWO MONTHS (PROBATIONARY PERIOD)

Polishers & Finishers - Second 900 Hours

Effective Period: 7/1/2023 - 6/30/2024

Wage and Supplemental Rate Per Hour: 80% of Journeyperson's rate

Polishers & Finishers - Third 900 Hours

Effective Period: 7/1/2023 - 6/30/2024

Wage and Supplemental Rate Per Hour: 90% of Journeyperson's rate

(Local #7)

MASON TENDER

(Ratio of Apprentice to Journeyperson: 1 to 1, 1 to 3)

Mason Tender - First Year

Effective Period: 7/1/2023 - 1/14/2024

Wage Rate per Hour: **\$21.80**

Supplemental Benefit Rate per Hour: **\$10.47**

Effective Period: 1/15/2024 - 6/30/2024

Wage Rate per Hour: **\$22.05**

Supplemental Benefit Rate per Hour: **\$10.77**

Mason Tender - Second Year

Effective Period: 7/1/2023 - 1/14/2024

Wage Rate per Hour: **\$23.55**

Supplemental Benefit Rate per Hour: **\$10.47**

Effective Period: 1/15/2024 - 6/30/2024

Wage Rate per Hour: **\$23.80**

Supplemental Benefit Rate per Hour: **\$10.77**

Mason Tender - Third Year

Effective Period: 7/1/2023 - 1/14/2024

Wage Rate per Hour: **\$25.05**

Supplemental Benefit Rate per Hour: **\$10.47**

OFFICE OF THE COMPTROLLER, CITY OF NEW YORK
CONSTRUCTION APPRENTICE PREVAILING WAGE SCHEDULE

Effective Period: 1/15/2024 - 6/30/2024
Wage Rate per Hour: **\$25.30**
Supplemental Benefit Rate per Hour: **\$10.77**

Mason Tender - Fourth Year

Effective Period: 7/1/2023 - 1/14/2024
Wage Rate per Hour: **\$27.55**
Supplemental Benefit Rate per Hour: **\$10.47**

Effective Period: 1/15/2024 - 6/30/2024
Wage Rate per Hour: **\$27.80**
Supplemental Benefit Rate per Hour: **\$10.77**

(Local #79)

MASON TENDER (INTERIOR DEMOLITION WORKER)
(Ratio of Apprentice to Journeyperson: 1 to 1, 1 to 3)

Mason Tender (Interior Demolition) - First Year

Effective Period: 7/1/2023 - 1/14/2024
Wage Rate per Hour: **\$20.70**
Supplemental Benefit Rate per Hour: **\$10.82**

Effective Period: 1/15/2024 - 6/30/2024
Wage Rate per Hour: **\$21.30**
Supplemental Benefit Rate per Hour: **\$10.97**

Mason Tender (Interior Demolition) - Second Year

Effective Period: 7/1/2023 - 1/14/2024
Wage Rate per Hour: **\$22.65**
Supplemental Benefit Rate per Hour: **\$10.82**

Effective Period: 1/15/2024 - 6/30/2024
Wage Rate per Hour: **\$23.05**
Supplemental Benefit Rate per Hour: **\$10.97**

Mason Tender (Interior Demolition) - Third Year

OFFICE OF THE COMPTROLLER, CITY OF NEW YORK
CONSTRUCTION APPRENTICE PREVAILING WAGE SCHEDULE

Effective Period: 7/1/2023 - 1/14/2024
Wage Rate per Hour: **\$24.15**
Supplemental Benefit Rate per Hour: **\$10.82**

Effective Period: 1/15/2024 - 6/30/2024
Wage Rate per Hour: **\$24.55**
Supplemental Benefit Rate per Hour: **\$10.97**

Mason Tender (Interior Demolition) - Fourth Year

Effective Period: 7/1/2023 - 1/14/2024
Wage Rate per Hour: **\$26.65**
Supplemental Benefit Rate per Hour: **\$10.82**

Effective Period: 1/15/2024 - 6/30/2024
Wage Rate per Hour: **\$27.05**
Supplemental Benefit Rate per Hour: **\$10.97**

(Local #79)

METALLIC LATHER
(Ratio of Apprentice to Journeyperson: 1 to 1, 1 to 3)

Metallic Lather (First Year)

Effective Period: 7/1/2023 - 6/30/2024
Wage Rate per Hour: **\$22.55**
Supplemental Benefit Rate per Hour: **\$17.87**

Metallic Lather (Second Year)

Effective Period: 7/1/2023 - 6/30/2024
Wage Rate per Hour: **\$23.60**
Supplemental Benefit Rate per Hour: **\$16.87**

Metallic Lather (Third Year)

Effective Period: 7/1/2023 - 6/30/2024
Wage Rate per Hour: **\$24.60**
Supplemental Benefit Rate per Hour: **\$15.92**

Metallic Lather (Fourth Year)

OFFICE OF THE COMPTROLLER, CITY OF NEW YORK
CONSTRUCTION APPRENTICE PREVAILING WAGE SCHEDULE

Effective Period: 7/1/2023 - 6/30/2024
Wage Rate per Hour: **\$37.18**
Supplemental Benefit Rate per Hour: **\$21.82**

(Local #46)

MILLWRIGHT
(Ratio of Apprentice to Journeyman: 1 to 1, 1 to 4)

Millwright (First Year)

Effective Period: 7/1/2023 - 6/30/2024
Wage Rate per Hour: **\$31.74**
Supplemental Benefit Rate per Hour: **\$36.74**

Millwright (Second Year)

Effective Period: 7/1/2023 - 6/30/2024
Wage Rate per Hour: **\$37.19**
Supplemental Benefit Rate per Hour: **\$40.44**

Millwright (Third Year)

Effective Period: 7/1/2023 - 6/30/2024
Wage Rate per Hour: **\$42.64**
Supplemental Benefit Rate per Hour: **\$44.79**

Millwright (Fourth Year)

Effective Period: 7/1/2023 - 6/30/2024
Wage Rate per Hour: **\$53.54**
Supplemental Benefit Rate per Hour: **\$51.55**

(Local #740)

PAINTER
(Ratio of Apprentice to Journeyman: 1 to 1, 1 to 3)

OFFICE OF THE COMPTROLLER, CITY OF NEW YORK
CONSTRUCTION APPRENTICE PREVAILING WAGE SCHEDULE

Painter - Brush & Roller - First Year

Effective Period: 7/1/2023 - 6/30/2024

Wage Rate per Hour: **\$17.20**

Supplemental Benefit Rate per Hour: **\$18.26**

Painter - Brush & Roller - Second Year

Effective Period: 7/1/2023 - 6/30/2024

Wage Rate per Hour: **\$21.50**

Supplemental Benefit Rate per Hour: **\$23.46**

Painter - Brush & Roller - Third Year

Effective Period: 7/1/2023 - 6/30/2024

Wage Rate per Hour: **\$25.80**

Supplemental Benefit Rate per Hour: **\$27.72**

Painter - Brush & Roller - Fourth Year

Effective Period: 7/1/2023 - 6/30/2024

Wage Rate per Hour: **\$34.40**

Supplemental Benefit Rate per Hour: **\$35.83**

(District Council of Painters)

PAINTER - METAL POLISHER

(Ratio of Apprentice to Journeyman: 1 to 1, 1 to 3)

Metal Polisher (First Year)

Effective Period: 7/1/2023 - 6/30/2024

Wage Rate per Hour: **\$16.00**

Supplemental Benefit Rate per Hour: **\$7.96**

New Construction - Wage Rate Per Hour: **\$16.39**

Scaffold Over 34 Feet - Wage Rate Per Hour: **\$18.50**

Metal Polisher (Second Year)

Effective Period: 7/1/2023 - 6/30/2024

Wage Rate per Hour: **\$17.00**

Supplemental Benefit Rate per Hour: **\$7.96**

OFFICE OF THE COMPTROLLER, CITY OF NEW YORK
CONSTRUCTION APPRENTICE PREVAILING WAGE SCHEDULE

New Construction - Wage Rate Per Hour: \$17.44
Scaffold Over 34 Feet - Wage Rate Per Hour: \$19.50

Metal Polisher (Third Year)

Effective Period: 7/1/2023 - 6/30/2024
Wage Rate per Hour: **\$18.00**
Supplemental Benefit Rate per Hour: **\$7.96**
New Construction - Wage Rate Per Hour: \$18.54
Scaffold Over 34 Feet - Wage Rate Per Hour: \$20.50

(Local 8A-28)

PAINTER - STRUCTURAL STEEL
(Ratio of Apprentice to Journeyman: 1 to 1, 1 to 3)

Painters - Structural Steel (First Year)

Effective Period: 7/1/2023 - 6/30/2024
Wage and Supplemental Rate Per Hour: 40% of Journeyman's rate

Painters - Structural Steel (Second Year)

Effective Period: 7/1/2023 - 6/30/2024
Wage and Supplemental Rate Per Hour: 60% of Journeyman's rate

Painters - Structural Steel (Third Year)

Effective Period: 7/1/2023 - 6/30/2024
Wage and Supplemental Rate Per Hour: 80% of Journeyman's rate

(Local #806)

PAVER AND ROADBUILDER
(Ratio of Apprentice to Journeyman: 1 to 1, 1 to 3)

Paver and Roadbuilder - First Year (Minimum 1000 hours)

OFFICE OF THE COMPTROLLER, CITY OF NEW YORK
CONSTRUCTION APPRENTICE PREVAILING WAGE SCHEDULE

Effective Period: 7/1/2023 - 6/30/2024

Wage Rate per Hour: **\$30.86**

Supplemental Benefit Rate per Hour: **\$25.54**

Paver and Roadbuilder - Second Year (Minimum 1000 hours)

Effective Period: 7/1/2023 - 6/30/2024

Wage Rate per Hour: **\$32.50**

Supplemental Benefit Rate per Hour: **\$25.54**

(Local #1010)

PAVER AND ROADBUILDER - LINE STRIPING (ROADWAY)

(Ratio of Apprentice to Journeyperson: 1 to 1, 1 to 3)

Paver and Roadbuilder - Line Striping (Roadway) - First Year (Minimum 1000 hours)

Effective Period: 7/1/2023 - 6/30/2024

Wage Rate per Hour: **\$30.86**

Supplemental Benefit Rate per Hour: **\$17.27**

Paver and Roadbuilder - Line Striping (Roadway) - Second Year (Minimum 1000 hours)

Effective Period: 7/1/2023 - 6/30/2024

Wage Rate per Hour: **\$32.50**

Supplemental Benefit Rate per Hour: **\$17.27**

(Local #1010)

PLASTERER

(Ratio of Apprentice to Journeyperson: 1 to 1, 1 to 3)

(Each Term is 800 Hours.)

Plasterer - First Term

OFFICE OF THE COMPTROLLER, CITY OF NEW YORK
CONSTRUCTION APPRENTICE PREVAILING WAGE SCHEDULE

Effective Period: 7/1/2023 - 6/30/2024
Wage Rate Per Hour: 55% of Journeyperson's rate
Supplemental Rate Per Hour: \$17.48

Plasterer - Second Term

Effective Period: 7/1/2023 - 6/30/2024
Wage Rate Per Hour: 60% of Journeyperson's rate
Supplemental Rate Per Hour: \$18.63

Plasterer - Third Term

Effective Period: 7/1/2023 - 6/30/2024
Wage Rate Per Hour: 70% of Journeyperson's rate
Supplemental Rate Per Hour: \$20.93

Plasterer - Fourth Term

Effective Period: 7/1/2023 - 6/30/2024
Wage Rate Per Hour: 75% of Journeyperson's rate
Supplemental Rate Per Hour: \$22.10

(Local #262)

PLASTERER - TENDER
(Ratio of Apprentice to Journeyperson: 1 to 1, 1 to 3)

Plasterer Tender - First Year

Effective Period: 7/1/2023 - 6/30/2024
Wage Rate per Hour: \$21.45
Supplemental Benefit Rate per Hour: \$10.32

Plasterer Tender - Second Year

Effective Period: 7/1/2023 - 6/30/2024
Wage Rate per Hour: \$23.40
Supplemental Benefit Rate per Hour: \$10.32

Plasterer Tender - Third Year

Effective Period: 7/1/2023 - 6/30/2024
Wage Rate per Hour: \$24.90
Supplemental Benefit Rate per Hour: \$10.32

OFFICE OF THE COMPTROLLER, CITY OF NEW YORK
CONSTRUCTION APPRENTICE PREVAILING WAGE SCHEDULE

Plasterer Tender - Fourth Year

Effective Period: 7/1/2023 - 6/30/2024

Wage Rate per Hour: **\$27.40**

Supplemental Benefit Rate per Hour: **\$10.32**

(Local #79)

PLUMBER

(Ratio of Apprentice to Journeyperson: 1 to 1, 1 to 3)

Plumber - First Year: 1st Six Months

Effective Period: 7/1/2023 - 1/14/2024

Wage Rate per Hour: **\$16.78**

Supplemental Benefit Rate per Hour: **\$5.43**

Effective Period: 1/15/2024 - 6/30/2024

Wage Rate per Hour: **\$19.00**

Supplemental Benefit Rate per Hour: **\$5.43**

Plumber - First Year: 2nd Six Months

Effective Period: 7/1/2023 - 1/14/2024

Wage Rate per Hour: **\$19.78**

Supplemental Benefit Rate per Hour: **\$6.43**

Effective Period: 1/15/2024 - 6/30/2024

Wage Rate per Hour: **\$21.00**

Supplemental Benefit Rate per Hour: **\$6.43**

Plumber - Second Year

Effective Period: 7/1/2023 - 1/14/2024

Wage Rate per Hour: **\$28.99**

Supplemental Benefit Rate per Hour: **\$21.95**

Effective Period: 1/15/2024 - 6/30/2024

Wage Rate per Hour: **\$29.59**

Supplemental Benefit Rate per Hour: **\$22.35**

Plumber - Third Year

OFFICE OF THE COMPTROLLER, CITY OF NEW YORK
CONSTRUCTION APPRENTICE PREVAILING WAGE SCHEDULE

Effective Period: 7/1/2023 - 1/14/2024

Wage Rate per Hour: **\$31.09**

Supplemental Benefit Rate per Hour: **\$21.95**

Effective Period: 1/15/2024 - 6/30/2024

Wage Rate per Hour: **\$31.69**

Supplemental Benefit Rate per Hour: **\$22.35**

Plumber - Fourth Year

Effective Period: 7/1/2023 - 1/14/2024

Wage Rate per Hour: **\$33.94**

Supplemental Benefit Rate per Hour: **\$21.95**

Effective Period: 1/15/2024 - 6/30/2024

Wage Rate per Hour: **\$34.54**

Supplemental Benefit Rate per Hour: **\$22.35**

Plumber - Fifth Year: 1st Six Months

Effective Period: 7/1/2023 - 1/14/2024

Wage Rate per Hour: **\$35.34**

Supplemental Benefit Rate per Hour: **\$21.95**

Effective Period: 1/15/2024 - 6/30/2024

Wage Rate per Hour: **\$35.94**

Supplemental Benefit Rate per Hour: **\$22.35**

Plumber - Fifth Year: 2nd Six Months

Effective Period: 7/1/2023 - 1/14/2024

Wage Rate per Hour: **\$47.41**

Supplemental Benefit Rate per Hour: **\$21.95**

Effective Period: 1/15/2024 - 6/30/2024

Wage Rate per Hour: **\$48.01**

Supplemental Benefit Rate per Hour: **\$22.35**

(Plumbers Local #1)

**POINTER, WATERPROOFER, CAULKER, SANDBLASTER,
STEAMBLASTER
(Exterior Building Renovation)**

OFFICE OF THE COMPTROLLER, CITY OF NEW YORK
CONSTRUCTION APPRENTICE PREVAILING WAGE SCHEDULE

(Ratio of Apprentice to Journeyman: 1 to 1, 1 to 4)

Pointer, Waterproofer, Caulker, Sandblaster, Steamblaster - First Year

Effective Period: 7/1/2023 - 6/30/2024
Wage Rate per Hour: **\$31.48**
Supplemental Benefit Rate per Hour: **\$15.00**

Pointer, Waterproofer, Caulker, Sandblaster, Steamblaster - Second Year

Effective Period: 7/1/2023 - 6/30/2024
Wage Rate per Hour: **\$35.54**
Supplemental Benefit Rate per Hour: **\$20.20**

Pointer, Waterproofer, Caulker, Sandblaster, Steamblaster - Third Year

Effective Period: 7/1/2023 - 6/30/2024
Wage Rate per Hour: **\$41.14**
Supplemental Benefit Rate per Hour: **\$23.95**

Pointer, Waterproofer, Caulker, Sandblaster, Steamblaster - Fourth Year

Effective Period: 7/1/2023 - 6/30/2024
Wage Rate per Hour: **\$49.50**
Supplemental Benefit Rate per Hour: **\$24.95**

(Bricklayer District Council)

ROOFER

(Ratio of Apprentice to Journeyman: 1 to 1, 1 to 2)

Roofer - First Year

Effective Period: 7/1/2023 - 6/30/2024
Wage Rate Per Hour: 35% of Journeyman's rate
Supplemental Benefit Rate Per Hour: **\$3.97**

Roofer - Second Year

Effective Period: 7/1/2023 - 6/30/2024
Wage Rate Per Hour: 50% of Journeyman's rate
Supplemental Benefit Rate Per Hour: **\$19.29**

OFFICE OF THE COMPTROLLER, CITY OF NEW YORK
CONSTRUCTION APPRENTICE PREVAILING WAGE SCHEDULE

Roofer - Third Year

Effective Period: 7/1/2023 - 6/30/2024
Wage Rate Per Hour: 60% of Journeyperson's rate
Supplemental Benefit Rate Per Hour: \$23.09

Roofer - Fourth Year

Effective Period: 7/1/2023 - 6/30/2024
Wage Rate Per Hour: 75% of Journeyperson's rate
Supplemental Benefit Rate Per Hour: \$28.81

(Local #8)

SHEET METAL WORKER

(Ratio of Apprentice to Journeyperson: 1 to 1, 1 to 3)

Sheet Metal Worker (0-6 Months)

Effective Period: 7/1/2023 - 1/14/2024
Wage Rate Per Hour: 25% of Journeyperson's rate
Supplemental Rate Per Hour: \$7.19

Effective Period: 1/15/2024 - 6/30/2024
Wage Rate Per Hour: 25% of Journeyperson's rate
Supplemental Rate Per Hour: \$7.64

Sheet Metal Worker (7-18 Months)

Effective Period: 7/1/2023 - 1/14/2024
Wage Rate Per Hour: 35% of Journeyperson's rate
Supplemental Rate Per Hour: \$20.98

Effective Period: 1/15/2024 - 6/30/2024
Wage Rate Per Hour: 35% of Journeyperson's rate
Supplemental Rate Per Hour: \$21.49

Sheet Metal Worker (19-30 Months)

Effective Period: 7/1/2023 - 1/14/2024
Wage Rate Per Hour: 45% of Journeyperson's rate
Supplemental Rate Per Hour: \$28.41

Effective Period: 1/15/2024 - 6/30/2024
Wage Rate Per Hour: 45% of Journeyperson's rate

OFFICE OF THE COMPTROLLER, CITY OF NEW YORK
CONSTRUCTION APPRENTICE PREVAILING WAGE SCHEDULE

Supplemental Rate Per Hour: \$29.09

Sheet Metal Worker (31-36 Months)

Effective Period: 7/1/2023 - 1/14/2024

Wage Rate Per Hour: 55% of Journeyperson's rate

Supplemental Rate Per Hour: \$33.59

Effective Period: 1/15/2024 - 6/30/2024

Wage Rate Per Hour: 55% of Journeyperson's rate

Supplemental Rate Per Hour: \$34.41

Sheet Metal Worker (37-42 Months)

Effective Period: 7/1/2023 - 1/14/2024

Wage Rate Per Hour: 55% of Journeyperson's rate

Supplemental Rate Per Hour: \$33.59

Effective Period: 1/15/2024 - 6/30/2024

Wage Rate Per Hour: 55% of Journeyperson's rate

Supplemental Rate Per Hour: \$34.41

Sheet Metal Worker (43-48 Months)

Effective Period: 7/1/2023 - 1/14/2024

Wage Rate Per Hour: 70% of Journeyperson's rate

Supplemental Rate Per Hour: \$41.37

Effective Period: 1/15/2024 - 6/30/2024

Wage Rate Per Hour: 70% of Journeyperson's rate

Supplemental Rate Per Hour: \$42.42

Sheet Metal Worker (49-54 Months)

Effective Period: 7/1/2023 - 1/14/2024

Wage Rate Per Hour: 70% of Journeyperson's rate

Supplemental Rate Per Hour: \$41.37

Effective Period: 1/15/2024 - 6/30/2024

Wage Rate Per Hour: 70% of Journeyperson's rate

Supplemental Rate Per Hour: \$42.42

Sheet Metal Worker (55-60 Months)

Effective Period: 7/1/2023 - 1/14/2024

Wage Rate Per Hour: 80% of Journeyperson's rate

Supplemental Rate Per Hour: \$46.56

Effective Period: 1/15/2024 - 6/30/2024

Wage Rate Per Hour: 80% of Journeyperson's rate

Supplemental Rate Per Hour: \$47.76

OFFICE OF THE COMPTROLLER, CITY OF NEW YORK
CONSTRUCTION APPRENTICE PREVAILING WAGE SCHEDULE

(Local #28)

SIGN ERECTOR

(Ratio of Apprentice to Journeyman: 1 to 1, 1 to 4)

Sign Erector - First Year: 1st Six Months

Effective Period: 7/1/2023 - 6/30/2024
Wage Rate Per Hour: 35% of Journeyman's rate
Supplemental Rate Per Hour: \$17.84

Sign Erector - First Year: 2nd Six Months

Effective Period: 7/1/2023 - 6/30/2024
Wage Rate Per Hour: 40% of Journeyman's rate
Supplemental Rate Per Hour: \$20.25

Sign Erector - Second Year: 1st Six Months

Effective Period: 7/1/2023 - 6/30/2024
Wage Rate Per Hour: 45% of Journeyman's rate
Supplemental Rate Per Hour: \$22.66

Sign Erector - Second Year: 2nd Six Months

Effective Period: 7/1/2023 - 6/30/2024
Wage Rate Per Hour: 50% of Journeyman's rate
Supplemental Rate Per Hour: \$25.09

Sign Erector - Third Year: 1st Six Months

Effective Period: 7/1/2023 - 6/30/2024
Wage Rate Per Hour: 55% of Journeyman's rate
Supplemental Rate Per Hour: \$33.83

Sign Erector - Third Year: 2nd Six Months

Effective Period: 7/1/2023 - 6/30/2024
Wage Rate Per Hour: 60% of Journeyman's rate
Supplemental Rate Per Hour: \$36.81

Sign Erector - Fourth Year: 1st Six Months

Effective Period: 7/1/2023 - 6/30/2024
Wage Rate Per Hour: 65% of Journeyman's rate

OFFICE OF THE COMPTROLLER, CITY OF NEW YORK
CONSTRUCTION APPRENTICE PREVAILING WAGE SCHEDULE

Supplemental Rate Per Hour: \$40.63

Sign Erector - Fourth Year: 2nd Six Months

Effective Period: 7/1/2023 - 6/30/2024
Wage Rate Per Hour: 70% of Journeyperson's rate
Supplemental Rate Per Hour: \$43.70

Sign Erector - Fifth Year

Effective Period: 7/1/2023 - 6/30/2024
Wage Rate Per Hour: 75% of Journeyperson's rate
Supplemental Rate Per Hour: \$46.76

Sign Erector - Sixth Year

Effective Period: 7/1/2023 - 6/30/2024
Wage Rate Per Hour: 80% of Journeyperson's rate
Supplemental Rate Per Hour: \$49.80

(Local #137)

STEAMFITTER

(Ratio of Apprentice to Journeyperson: 1 to 1, 1 to 3)

Steamfitter - First Year

Effective Period: 7/1/2023 - 6/30/2024
Wage Rate and Supplemental Per Hour: 40% of Journeyperson's rate

Steamfitter - Second Year

Effective Period: 7/1/2023 - 6/30/2024
Wage Rate and Supplemental Rate Per Hour: 50% of Journeyperson's rate.

Steamfitter - Third Year

Effective Period: 7/1/2023 - 6/30/2024
Wage Rate and Supplemental Rate per Hour: 60% of Journeyperson's rate.

Steamfitter - Fourth Year

Effective Period: 7/1/2023 - 6/30/2024
Wage Rate and Supplemental Rate Per Hour: 70% of Journeyperson's rate.

OFFICE OF THE COMPTROLLER, CITY OF NEW YORK
CONSTRUCTION APPRENTICE PREVAILING WAGE SCHEDULE

Steamfitter - Fifth Year

Effective Period: 7/1/2023 - 6/30/2024

Wage Rate and Supplemental Rate Per Hour: 80% of Journeyperson's rate.

(Local #638)

**STEAMFITTER - REFRIGERATION & AIR CONDITIONER
(Ratio of Apprentice to Journeyperson: 1 to 1, 1 to 3)**

Refrigeration & Air Conditioner (First Year)

Effective Period: 7/1/2023 - 1/14/2024

Wage Rate per Hour: **\$21.71**

Supplemental Benefit Rate per Hour: **\$13.75**

Effective Period: 1/15/2024 - 6/30/2024

Wage Rate per Hour: **\$21.83**

Supplemental Benefit Rate per Hour: **\$14.31**

Refrigeration & Air Conditioner (Second Year)

Effective Period: 7/1/2023 - 1/14/2024

Wage Rate per Hour: **\$26.21**

Supplemental Benefit Rate per Hour: **\$15.09**

Effective Period: 1/15/2024 - 6/30/2024

Wage Rate per Hour: **\$26.36**

Supplemental Benefit Rate per Hour: **\$15.73**

Refrigeration & Air Conditioner (Third Year)

Effective Period: 7/1/2023 - 1/14/2024

Wage Rate per Hour: **\$30.53**

Supplemental Benefit Rate per Hour: **\$16.49**

Effective Period: 1/15/2024 - 6/30/2024

Wage Rate per Hour: **\$30.70**

Supplemental Benefit Rate per Hour: **\$17.21**

Refrigeration & Air Conditioner (Fourth Year)

Effective Period: 7/1/2023 - 1/14/2024

OFFICE OF THE COMPTROLLER, CITY OF NEW YORK
CONSTRUCTION APPRENTICE PREVAILING WAGE SCHEDULE

Wage Rate per Hour: **\$36.87**

Supplemental Benefit Rate per Hour: **\$18.38**

Effective Period: 1/15/2024 - 6/30/2024

Wage Rate per Hour: **\$37.08**

Supplemental Benefit Rate per Hour: **\$19.22**

(Local #638-B)

STONE MASON - SETTER

(Ratio Apprentice of Journeyman: 1 to 1, 1 to 2)

Stone Mason - Setters - First 750 Hours

Effective Period: 7/1/2023 - 6/30/2024

Wage and Supplemental Rate Per Hour: 50% of Journeyman's rate

Stone Mason - Setters - Second 750 Hours

Effective Period: 7/1/2023 - 6/30/2024

Wage Rate Per Hour: 60% of Journeyman's rate

Supplemental Rate Per Hour: 50% of Journeyman's rate

Stone Mason - Setters - Third 750 Hours

Effective Period: 7/1/2023 - 6/30/2024

Wage Rate Per Hour: 70% of Journeyman's rate

Supplemental Rate Per Hour: 50% of Journeyman's rate

Stone Mason - Setters - Fourth 750 Hours

Effective Period: 7/1/2023 - 6/30/2024

Wage Rate Per Hour: 80% of Journeyman's rate

Supplemental Rate Per Hour: 50% of Journeyman's rate

Stone Mason - Setters - Fifth 750 Hours

Effective Period: 7/1/2023 - 6/30/2024

Wage Rate Per Hour: 90% of Journeyman's rate

Supplemental Rate Per Hour: 50% of Journeyman's rate

Stone Mason - Setters - Sixth 750 Hours

Effective Period: 7/1/2023 - 6/30/2024

OFFICE OF THE COMPTROLLER, CITY OF NEW YORK
CONSTRUCTION APPRENTICE PREVAILING WAGE SCHEDULE

Wage Rate Per Hour: 100% of Journeyperson's rate
Supplemental Rate Per Hour: 50% of Journeyperson's rate

(Bricklayers District Council)

TAPER

(Ratio of Apprentice to Journeyperson: 1 to 1, 1 to 4)

Drywall Taper - First Year

Effective Period: 7/1/2023 - 1/14/2024

Wage Rate per Hour: **\$20.97**

Supplemental Benefit Rate per Hour: **\$14.25**

Effective Period: 1/15/2024 - 6/30/2024

Wage Rate per Hour: **\$21.41**

Supplemental Benefit Rate per Hour: **\$13.85**

Drywall Taper - Second Year

Effective Period: 7/1/2023 - 1/14/2024

Wage Rate per Hour: **\$24.24**

Supplemental Benefit Rate per Hour: **\$21.26**

Effective Period: 1/15/2024 - 6/30/2024

Wage Rate per Hour: **\$24.24**

Supplemental Benefit Rate per Hour: **\$23.11**

Drywall Taper - Third Year

Effective Period: 7/1/2023 - 1/14/2024

Wage Rate per Hour: **\$29.08**

Supplemental Benefit Rate per Hour: **\$23.01**

Effective Period: 1/15/2024 - 6/30/2024

Wage Rate per Hour: **\$29.08**

Supplemental Benefit Rate per Hour: **\$24.96**

Drywall Taper - Fourth Year

Effective Period: 7/1/2023 - 1/14/2024

Wage Rate per Hour: **\$38.78**

Supplemental Benefit Rate per Hour: **\$26.51**

OFFICE OF THE COMPTROLLER, CITY OF NEW YORK
CONSTRUCTION APPRENTICE PREVAILING WAGE SCHEDULE

Effective Period: 1/15/2024 - 6/30/2024

Wage Rate per Hour: \$38.78

Supplemental Benefit Rate per Hour: \$28.66

(Local #1974)

TILE LAYER - SETTER

(Ratio of Apprentice to Journeyman: 1 to 1, 1 to 4)

Tile Layer - Setter - First 750 Hours

Effective Period: 7/1/2023 - 6/30/2024

Wage and Supplemental Rate Per Hour: 35% of Journeyman's rate

Tile Layer - Setter - Second 750 Hours

Effective Period: 7/1/2023 - 6/30/2024

Wage and Supplemental Rate Per Hour: 40% of Journeyman's rate

Tile Layer - Setter - Third 750 Hours

Effective Period: 7/1/2023 - 6/30/2024

Wage and Supplemental Rate Per Hour: 50% of Journeyman's rate

Tile Layer - Setter - Fourth 750 Hours

Effective Period: 7/1/2023 - 6/30/2024

Wage and Supplemental Rate Per Hour: 55% of Journeyman's rate

Tile Layer - Setter - Fifth 750 Hours

Effective Period: 7/1/2023 - 6/30/2024

Wage and Supplemental Rate Per Hour: 60% of Journeyman's rate

Tile Layer - Setter - Sixth 750 Hours

Effective Period: 7/1/2023 - 6/30/2024

Wage and Supplemental Rate Per Hour: 65% of Journeyman's rate

Tile Layer - Setter - Seventh 750 Hours

Effective Period: 7/1/2023 - 6/30/2024

Wage and Supplemental Rate Per Hour: 70% of Journeyman's rate

OFFICE OF THE COMPTROLLER, CITY OF NEW YORK
CONSTRUCTION APPRENTICE PREVAILING WAGE SCHEDULE

Tile Layer - Setter - Eighth 750 Hours

Effective Period: 7/1/2023 - 6/30/2024

Wage and Supplemental Rate Per Hour: 75% of Journeyperson's rate

Tile Layer - Setter - Ninth 750 Hours

Effective Period: 7/1/2023 - 6/30/2024

Wage and Supplemental Rate Per Hour: 80% of Journeyperson's rate

Tile Layer - Setter - Tenth 750 Hours

Effective Period: 7/1/2023 - 6/30/2024

Wage and Supplemental Rate Per Hour: 90% of Journeyperson's rate

(Local #7)

TIMBERPERSON

(Ratio of Apprentice to Journeyperson: 1 to 1, 1 to 6)

Timberperson - First Year

Effective Period: 7/1/2023 - 6/30/2024

Wage Rate Per Hour: \$23.42

Supplemental Rate Per Hour: \$37.27

Timberperson - Second Year

Effective Period: 7/1/2023 - 6/30/2024

Wage Rate Per Hour: \$28.53

Supplemental Rate Per Hour: \$37.27

Timberperson - Third Year

Effective Period: 7/1/2023 - 6/30/2024

Wage Rate Per Hour: \$36.18

Supplemental Rate Per Hour: \$37.27

Timberperson - Fourth Year

Effective Period: 7/1/2023 - 6/30/2024

Wage Rate Per Hour: \$43.84

Supplemental Rate Per Hour: \$37.27

(Local #1536)



Leonard A. Mancusi
SENIOR ASSISTANT COMPTROLLER

THE CITY OF NEW YORK
OFFICE OF THE COMPTROLLER
1 CENTRE STREET ROOM 1120
NEW YORK, N.Y. 10007-2341

TELEPHONE: (212) 669-3622
FAX NUMBER: (212) 669-8499

ALAN G. HEVESI
COMPTROLLER

MEMORANDUM

November 6, 2000

To Agency Chief Contracting Officers

From: Leonard A. Mancusi

Re: Security at Construction Sites

Prior to the enactment of Administrative Code §6-109, security guards on construction sites were not subject to prevailing wages. Security guards under the New York State labor law are covered under §230 which provides that prevailing wages are to be paid for security guards in existing buildings. §6-109 of the Administrative Code which was enacted in 1996 closed this loophole by including all security guards working pursuant to a city contract as a prevailing wage trade.

Although some construction contract boilerplate language has been amended to include §6-109, sub-contractors performing security services have advised us that they were not aware of this provision and, since traditionally, security guards were not a covered trade on construction sites, and they were not advised by a prime contractor that they would have to pay prevailing wages, they have not been doing so.

To avoid the possibility of issuing stop payments against prime contractors for the failure of their security service sub-contractors to pay

prevailing wages, we suggest that you write to all your existing security guard sub-contractors and their primes and in the future, upon approval of a security guard sub-contractor, advise the contractors of their obligation to pay prevailing wages under §6-109 of the Administrative Code.

As always, your cooperation is appreciated.

LAM:er
ACCO.SECURITY AT SITES



**Department of
Design and
Construction**

**DIVISION OF INFRASTRUCTURE
BUREAU OF DESIGN**

VOLUME 2 OF 3

PROJECT ID: HWS2023R

**INSTALLATION OF SIDEWALKS, ADJACENT CURBS AND
PEDESTRIAN RAMPS AS NECESSARY IN VARIOUS LOCATIONS**

Together With All Work Incidental Thereto
BOROUGH OF STATEN ISLAND
CITY OF NEW YORK

Contractor

Dated _____, 20__

APPROVED AS TO FORM
CERTIFIED AS TO LEGAL AUTHORITY

Acting Corporation Counsel

Dated _____, 20__



**Department of
Design and
Construction**

**THE CITY OF NEW YORK
DEPARTMENT OF DESIGN AND
CONSTRUCTION
DIVISION OF INFRASTRUCTURE**
30-30 THOMSON AVENUE
LONG ISLAND CITY, NY, 11101
TEL: 718.391.1000
WEB: www.nyc.gov/ddc

TO BE FILLED IN BY THE BIDDER:

BIDDER'S NAME:

BID SECURITY (CIRCLE ONE):
BID BOND / CERTIFIED CHECK

NUMBER OF ADDENDUMS RECEIVED
AND ATTACHED TO BID:
_____ ADDENDUMS

DDC CLIENT AGENCY:
DEPARTMENT OF TRANSPORTATION

PREPARED BY:
IN HOUSE

DATE PREPARED:
11/01/2023

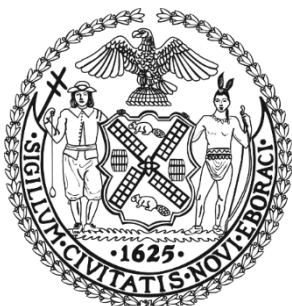

VOLUME 3 OF 3

FOR FURNISHING ALL LABOR AND MATERIALS
NECESSARY AND REQUIRED FOR:

PROJECT ID: HWS2023R SCHEDULE A SPECIFICATIONS AND REVISIONS TO STANDARD SPECIFICATIONS

**INSTALLATION OF SIDEWALKS, ADJACENT
CURBS AND PEDESTRIAN RAMPS AS
NECESSARY IN VARIOUS LOCATIONS**

TOGETHER WITH ALL WORK INCIDENTAL THERETO
**BOROUGH OF STATEN ISLAND
CITY OF NEW YORK**

VOLUME 3 OF 3

TABLE OF CONTENTS

<u>SECTION</u>	<u>DESCRIPTION</u>
	SPECIFICATIONS AND STANDARDS OF NEW YORK CITY
SCHEDULE A	GENERAL CONDITIONS TO CONSTRUCTION CONTRACT
R – PAGES	REVISIONS TO STANDARD SPECIFICATIONS
I- PAGES	NEW SECTION
S- PAGES	SPECIAL PROVISIONS
SW – PAGES	SEWER AND WATER MAIN REVISIONS TO SPECIFICATIONS
HAZ – PAGES	SUPPLEMENTAL DOCUMENTATION FOR USE WITH SPECIFICATIONS FOR HANDLING, TRANSPORTATION AND DISPOSAL OF NON-HAZARDOUS AND POTENTIALLY HAZARDOUS CONTAMINATED MATERIALS

(NO TEXT ON THIS PAGE)

SPECIFICATIONS AND STANDARDS OF NEW YORK CITY

The following specifications and standards are incorporated into the Contract Documents by reference as though fully set forth herein.

1. Standard Specifications and Drawings for New York City Department of Transportation (NYCDOT) are available:
Online at: <http://www1.nyc.gov/site/ddc/resources/publications.page>
 - a. NYC DOT Standard Highway Specifications
 - b. NYC DOT Standard Details of ConstructionOnline at: <https://www1.nyc.gov/html/dot/html/about/dotlibrary.shtml#spec>
 - c. NYC DOT Division of Street Lighting Standard Drawings
 - d. NYC DOT Standard Specifications for Traffic Signals
 - e. NYC DOT Standard Drawings for Traffic SignalsFor purchase between 9:00 A.M. and 3:00 P.M. Bid Window, at 55 Water St., Ground Floor, NYC, N.Y. 10041. Tel. (212) 839-9435.
 - f. NYC DOT Division of Street Lighting Specifications
2. The 2010 Americans with Disabilities Act (ADA) Standards; available online at: <https://www.ada.gov/regs2010/2010ADASTandards/2010ADASTandards.htm>
3. The 2013 Public Rights-of-Way Accessibility Guidelines (PROWAG); available online at: <https://www.access-board.gov/files/prowag/PROW-SUP-SNPRM-2013.pdf>
4. Standard Specifications and Drawings for New York City Department of Environmental Protection (NYCDEP) are available online at: <http://www1.nyc.gov/site/ddc/resources/publications.page>
 - a. NYC DEP Standard Sewer and Water Main Specifications, August 8, 2022
 - b. NYC DEP Instructions to Architect/Engineers Specifications for Concrete, January 1992
 - c. NYC DEP General Specification 11-Concrete, November 1991
 - d. NYC DEP Sewer Design Standards, March 27, 2023
 - e. NYC DEP Water Main Standard Drawings, December 2020
 - f. Specifications for Trunk Main Work, July 2014
 - g. Standard Green Infrastructure Specifications September 1,2021
5. Standard Design and Guidelines for Green Infrastructure Practices, latest version, available only online at: <https://www1.nyc.gov/assets/dep/downloads/pdf/water/stormwater/green-infrastructure/green-infrastructure-standard-designs.pdf>
6. Standard Specifications and Drawings for New York City Fire Department Communications facilities of New York City are available online at <https://www1.nyc.gov/assets/fdny/downloads/pdf/about/fdny-plant-operations-standard-drawings-specifications.pdf> or for pick up from the FDNY Facilities Management Bureau, Plant Operations Engineering, 316 Sgt. Beers Avenue Cluster 1 Box 16, Fort Totten, N.Y. 11359. Contact: Mr. Ed Durkin, Tel. (718) 281-3933
7. Tree Planting Standards of the City of New York Parks & Recreation are available at the following Department of Parks & Recreation website: <http://www.nycgovparks.org/pagefiles/53/Tree-Planting-Standards.pdf>
8. Standards and Specifications for Utility Joint Bid work are available online at <http://www1.nyc.gov/site/ddc/resources/publications.page>
 - a. CET SPECIFICATIONS AND SKETCHES, dated November 2010
 - b. JOINT-BIDDING SPECIFICATIONS AND SKETCHES FOR MANHATTAN, Issued August 1, 2005

SCHEDULE A

**(GENERAL CONDITIONS TO CONSTRUCTION CONTRACT
(INCLUDING GENERAL CONDITIONS RELATED TO ARTICLE 22 – INSURANCE)**

PART I. REQUIRED INFORMATION

<p align="center"><u>INFORMATION FOR BIDDERS SECTION 26 BID SECURITY</u></p> <p>The Contractor shall obtain a bid security in the amount indicated to the right.</p>	<p>Required provided the TOTAL BID PRICE set forth on the Bid Form is \$1,000,000. or more.</p> <p>Certified Check: 2% of Bid Amount or Bond: 10% of Bid Amount</p>
<p align="center"><u>INFORMATION FOR BIDDERS SECTION 26 PERFORMANCE AND PAYMENT BONDS</u></p> <p>The Contractor shall obtain performance and payment bonds in the amount indicated to the right.</p>	<p>Required for contracts in the amount of \$1,000,000 or more.</p> <p>Performance Security and Payment Security shall each be in an amount equal to 100% of the Contract Price.</p>
<p align="center"><u>INFORMATION FOR BIDDERS DEPARTMENT OF DESIGN AND CONSTRUCTION SAFETY REQUIREMENTS</u></p> <p>The Contractor shall provide the safety personnel as indicated to the right.</p>	<p><input checked="" type="checkbox"/> Project Safety Representative</p> <p><input type="checkbox"/> Dedicated, full-time Project Safety Manager</p>
<p align="center"><u>CONTRACT ARTICLE 14 DATE FOR SUBSTANTIAL COMPLETION</u></p> <p>The Contractor shall substantially complete the Work in the number of calendar days indicated to the right.</p>	<p>See Page SA-4 and as stated in the Work Orders</p>
<p align="center"><u>CONTRACT ARTICLE 15 LIQUIDATED DAMAGES</u></p> <p>If the Contractor fails to substantially complete the Work within the time fixed for substantial completion plus authorized time extensions or if the Contractor, in the sole determination of the Commissioner, has abandoned the Work, the Contractor shall pay to the City the amount indicated to the right.</p>	<p><u>\$3250.00</u> for each consecutive calendar day over Substantial Completion Time</p>
<p align="center"><u>CONTRACT ARTICLE 17. SUB-CRACKTOR</u></p> <p>The Contractor shall not make subcontracts totaling an amount more than the percentage of the total Contract price indicated to the right.</p>	<p>Not to exceed <u>49</u> % of the Contract price</p>

<p style="text-align: center;"><u>CONTRACT ARTICLE 21.</u> <u>RETAINAGE</u></p> <p>The Commissioner shall deduct and retain until the substantial completion of the Work the percent value of the Work indicated to the right.</p>	<p><u>5 %</u> of the value of the Work</p>
<p style="text-align: center;"><u>CONTRACT ARTICLE 22.</u> <u>(Per Directions Below)</u></p>	<p>See pages SA-5 through SA-12</p>
<p style="text-align: center;"><u>CONTRACT ARTICLE 24.</u> <u>DEPOSIT GUARANTEE</u></p> <p>As security for the faithful performance of its obligations, the Contractor, upon filing its requisition for payment on Substantial Completion, shall deposit with the Commissioner a sum equal to the percentage of the Contract price indicated to the right.</p>	<p>1% of Contract price</p>
<p style="text-align: center;"><u>CONTRACT ARTICLE 24.</u> <u>PERIOD OF GUARANTEE</u></p> <p>Periods of maintenance and guarantee other than the period set forth in Article 24.1 are indicated to the right.</p>	<p>Eighteen (18) Months, excluding Trees and Plants</p> <p>Twenty-four (24) Months for Trees and Plants</p>
<p style="text-align: center;"><u>CONTRACT ARTICLE 75.</u> <u>COMPENSATION TO BE PAID TO CONTRACTOR</u></p> <p>The City shall pay and the Contractor shall accept in full consideration for the performance of the Contract, subject to additions and deductions as provided herein, the total sum shown in the column to the right, being the amount at which the Contract was awarded to the Contractor at a public letting thereof, based upon the Contractor's bid for the Contract.</p>	<p>Amount for which the Contract was Awarded:</p> <p>_____</p> <p>_____ Dollars</p> <p>(\$ _____)</p>
<p style="text-align: center;"><u>CONTRACT ARTICLE 79.</u> <u>PARTICIPATION BY MINORITY-OWNED AND WOMEN-OWNED BUSINESS ENTERPRISES IN CITY PROCUREMENT</u></p>	<p>See M/WBE Utilization Plan in the PASSPort Procurement M/WBE Considerations Section</p>

<p align="center"><u>STANDARD HIGHWAY SPECIFICATIONS</u> <u>SECTION 6.40</u> <u>LIQUIDATED DAMAGES FOR ENGINEER'S FIELD OFFICE</u></p> <p>If the Contractor fails to satisfactorily provide the field office and all equipment specified in Section 6.40 - Engineer's Field Office, and/or if a cited deficiency exceed seventy two (72) hours after notice from the Engineer in writing, or is permitted to recur, liquidated damages will be assessed in the amount specified herein for each subsequent calendar day or part thereof that a cited deficiency resulting in nonpayment, as described in Section 6.40.5, is not corrected.</p>	<p>\$ <u>800.00</u> for each calendar day of deficiency</p>
<p align="center"><u>STANDARD HIGHWAY SPECIFICATIONS</u> <u>SECTION 6.70</u> <u>LIQUIDATED DAMAGES FOR MAINTENANCE AND PROTECTION OF TRAFFIC</u></p>	<p>\$ <u>400.00</u> for each instance of failure to comply with the Maintenance and Protection of Traffic requirements within three (3) hours after written notice from the Engineer.</p> <p>\$ <u>800.00</u> for each and every hour of failing to open the entire width of roadway to traffic the morning following a night/weekend work operation.</p>
<p align="center"><u>STANDARD HIGHWAY SPECIFICATIONS</u> <u>SECTION 7.13</u> <u>LIQUIDATED DAMAGES FOR MAINTENANCE OF SITE</u></p> <p>If the Contractor fails to comply, within three (3) consecutive hours after written notice from the Engineer, with the requirements of Section 7.13 - Maintenance of Site, the Contractor shall pay to the City of New York, until such notice has been complied with or rescinded, the sum specified above per calendar day, for each instance of such failure, as liquidated damages and not as a penalty, for such default.</p>	<p>\$<u>650.00</u> for each calendar day, for each occurrence</p>
<p align="center"><u>VOLUME 3 OF 3, S – PAGES,</u> <u>PART (B) HIGHWAY PROJECT SPECIFIC PROVISIONS Page S-13, ARTICLE(C) EXECUTION OF WORK ORDERS LIQUIDATED DAMAGES FOR EXECUTION OF WORK ORDERS</u></p> <p>If the Contractor fails to mobilize and begin work within the mobilization period specified in the Work Order issued and/or complete the work within the time frame for completion specified in the Work Order, liquidated damages will be assessed in the amount(s) specified herein each subsequent calendar day</p>	<p>\$<u>650.00</u> for each calendar day of failure to mobilize and begin work after the mobilization period specified in the Work Order and/or complete the work within the time frame for completion specified in the Work Order</p>

Date for Substantial Completion (Reference: Article 14)

The Contractor shall substantially complete the Work within the Final Contract Duration determined in accordance with the terms and conditions set forth herein.

The Base Contract Duration for this project is 545 consecutive calendar days (“ccds”).

The Final Contract Duration shall be the Base Contract Duration when a check mark is indicated before the word “NO”, below, and shall be the Base Contract Duration adjusted by the table set forth below when a check mark is indicated before the word “YES”, below.

 YES √ NO

When the Final Contract Duration is indicated above to be adjusted by the table below, the table may increase the Base Contract Duration depending on the date of scheduled substantial completion to avoid a scheduled substantial completion of the Work during the winter months. The date of scheduled substantial completion shall be determined by adding the Base Contract Duration to the date specified to commence work in the written Notice to Proceed. The Final Contract Duration shall then be determined as follows:

- (a) Find the row that corresponds to the month of substantial completion based on the Base Contract Duration added to the date specified to commence work in the written Notice to Proceed.
- (b) Find the number of days to be added to the Base Contract Duration in the table below. Add that number of days to the Base Contract Duration to obtain the Final Contract Duration in consecutive calendar days.

Month of Substantial Completion based on the Base Contract Duration	Number of Days of adjustment
January	150
February	120
March	90
April	60
May	30
June	0
July	0
August	0
September	0
October	0
November –December 15	0
December 16 – December 31	180

In addition, should Item No. 9.30, “Storm Water Pollution Prevention,” exist in the Contract and the required Storm Water Pollution Prevention Plan (SWPPP) does not conform to NYSDEC’s recommended Standards, an additional 60 ccd shall be added to the above Final Contract Duration.

(GENERAL CONDITIONS RELATING TO ARTICLE 22 – INSURANCE)

PART II. TYPES OF INSURANCE, MINIMUM LIMITS AND SPECIAL CONDITIONS

Note: All certificate(s) of insurance submitted pursuant to Contract Article 22.3.3 must be accompanied by a Certification by Broker consistent with Part III below and include the following information:

- For each insurance policy, the name and NAIC number of issuing company, number of policy, and effective dates;
- Policy limits consistent with the requirements listed below;
- Additional insureds or loss payees consistent with the requirements listed below; and
- The number assigned to the Contract by the City (in the “Description of Operations” field).

Insurance indicated by a blackened box (■) or by X in a □ to left will be required under this contract

Types of Insurance (per Article 22 in its entirety, including listed paragraph)	Minimum Limits and Special Conditions
<p>■ Commercial General Liability Art. 22.1.1</p>	<p>The minimum limits shall be \$ <u>3,000,000</u> per occurrence and \$ <u>6,000,000</u> per project aggregate applicable to this Contract.</p> <p>Additional Insureds:</p> <ol style="list-style-type: none"> 1. City of New York, including its officials and employees, with coverage at least as broad as ISO Form CG 20 10 and CG 20 37, 2. All person(s) or organization(s), if any, that Article 22.1.1(b) of the Contract requires to be named as Additional Insured(s), with coverage at least as broad as ISO Form CG 20 26. The Additional Insured endorsement shall either specify the entity’s name, if known, or the entity’s title (e.g., Project Manager),

<ul style="list-style-type: none"> <input checked="" type="checkbox"/> Workers' Compensation Art. 22.1.2 <input checked="" type="checkbox"/> Disability Benefits Insurance Art. 22.1.2 <input checked="" type="checkbox"/> Employers' Liability Art. 22.1.2 <input type="checkbox"/> Jones Act Art. 22.1.3 <input type="checkbox"/> U.S. Longshoremen's and Harbor Workers Compensation Act Art. 22.1.3 	<p>Workers' Compensation, Employers' Liability, and Disability Benefits Insurance: Statutory per New York State law without regard to jurisdiction.</p> <p>Note: The following forms are acceptable: (1) New York State Workers' Compensation Board Form No. C-105.2, (2) State Insurance Fund Form No. U-26.3, (3) New York State Workers' Compensation Board Form No. DB-120.1 and (4) Request for WC/DB Exemption Form No. CE-200. The City will not accept an ACORD form as proof of Workers' Compensation or Disability Insurance.</p> <p>Jones Act and U.S. Longshoremen's and Harbor Workers' Compensation Act: Statutory per U.S. Law.</p> <p><input type="checkbox"/> Additional Requirements:</p>
<ul style="list-style-type: none"> <input type="checkbox"/> Builders' Risk Art. 22.1.4 	<p><input type="checkbox"/> Required: 100% of total bid amount</p> <p><input type="checkbox"/> Required: 100 % of total bid amount for Item(s):</p> <p>Contractor the Named Insured; the City both an Additional Insured and one of the loss payees as its interests may appear.</p> <p>If the Work does not involve construction of a new building or gut renovation work, the Contractor may provide an installation floater in lieu of Builders Risk insurance.</p> <p>Note: Builders Risk Insurance may terminate upon Substantial Completion of the Work in its entirety.</p>

<input checked="" type="checkbox"/> Commercial Auto Liability Art. 22.1.5	<p>\$ <u>2,000,000</u> per accident combined single limit</p> <p>If vehicles are used for transporting hazardous materials, the Contractor shall provide pollution liability broadened coverage for covered vehicles (endorsement CA 99 48) as well as proof of MCS 90</p> <p>Additional Insureds:</p>
<input type="checkbox"/> Contractors Pollution Liability Art. 22.1.6	<p>\$ <u>5,000,000</u> per occurrence \$ <u>5,000,000</u> aggregate</p> <p>Additional Insureds: 1. City of New York, including its officials and employees, and 2. _____ 3. _____</p>
<input type="checkbox"/> Marine Protection and Indemnity Art. 22.1.7(a)	<p>\$ _____ each occurrence \$ _____ aggregate</p> <p>Additional Insureds: 1. City of New York, including its officials and employees, and 2. _____ 3. _____</p>
<input type="checkbox"/> Hull and Machinery Insurance Art. 22.1.7(b)	<p>\$ _____ per occurrence \$ _____ aggregate</p> <p>Additional Insureds: 1. City of New York, including its officials and employees, and 2. _____ 3. _____</p>

[OTHER] Art. 22.1.8

■ Professional Liability

A. The Contractor’s Professional Engineer shall maintain and submit evidence of Professional Liability Insurance in the minimum amount of \$1,000,000 per claim. The policy or policies shall include an endorsement to cover the liability assumed by the Contractor under this Contract arising out of the negligent performance of professional services or caused by an error, omission or negligent act of the Contractor’s Professional Engineer or anyone employed by the Contractor’s Professional Engineer.

B. Claims-made policies will be accepted for Professional Liability Insurance. All such policies shall have an extended reporting period option or automatic coverage of not less than two (2) years. If available as an option, the Contractor’s Professional Engineer shall purchase extended reporting period coverage effective on cancellation or termination of such insurance unless a new policy is secured with a retroactive date, including at least the last policy year.

<p>[OTHER] Art. 22.1.8</p> <p>■ Engineer’s Field Office</p> <p>Section 6.40, Standard Highway Specifications</p>	<p>Fire insurance, extended coverage and vandalism, malicious mischief and burglary, and theft insurance coverage in the amount of <u>\$40,000</u></p>
------------------------------------------------------------------------------------------------------------------------------------------------------------	--------------------------------------------------------------------------------------------------------------------------------------------------------

[OTHER] Art. 22.1.8

The Following Additional Insurance Must Be Provided:

Umbrella/Excess Liability Insurance - The Contractor shall provide Umbrella/Excess Liability Insurance in the minimum amount of \$10,000,000 per Occurrence and \$10,000,000 in Aggregate. The policy terms and condition should be at least as broad as the underlying policies. The underlying policies should comply with the insurance provision as outlined by the contract. Defense cost should be in addition to the limit of liability. The City of New York, including its officials and employees, should be included as additional insured as respects to the noted project.

Per **Article 22.2.5** of the **Standard Construction Contract**: The Contractor may satisfy its insurance obligations as defined in this Schedule A through primary policies or a combination of primary and excess/umbrella policies, so long as all policies provide the scope of coverage required herein.

SCHEDULE A
(GENERAL CONDITIONS TO CONSTRUCTION CONTRACT)
(GENERAL CONDITIONS RELATING TO ARTICLE 22 – INSURANCE)

PART III. CERTIFICATES OF INSURANCE

All certificates of insurance (except certificates of insurance solely evidencing Workers' Compensation Insurance, Employer's Liability Insurance, and/or Disability Benefits Insurance) must be accompanied by one of the following:

(1) the Certification by Insurance Broker or Agent on the following page setting forth the required information and signatures;

-- OR --

(2) copies of all policies as certified by an authorized representative of the issuing insurance carrier that are referenced in such certificate of insurance. If any policy is not available at the time of submission, certified binders may be submitted until such time as the policy is available, at which time a certified copy of the policy shall be submitted.

SCHEDULE A

(GENERAL CONDITIONS TO CONSTRUCTION CONTRACT)

PART IV. ADDRESS OF COMMISSIONER

Wherever reference is made in Article 7 or Article 22 to documents to be sent to the **Commissioner** (e.g., notices, filings, or submissions), such documents must be sent through email to insurance@ddc.nyc.gov. Hard copy documents of the above requirement are no longer required.

(NO FURTHER TEXT ON THIS PAGE)

REVISIONS TO STANDARD SPECIFICATIONS

NOTICE

The Specification Bulletin(s) (“SB(s)”) referenced in this Section (R-Pages) may consist of revisions to the following Standard Specifications:

- New York City Department of Transportation (“NYC DOT”) Standard Highway Specifications, dated 5/16/2022;
- New York City Department of Environmental Protection (“NYC DEP”) Standard Sewer and Water Main Specifications, dated 8/8/2022; and
- NYC DEP Specifications for Trunk Main Work, dated 7/2014.

The SB(s) modify and supersede portions of the applicable Standard Specifications. The provisions contained in this Contract’s I-Pages, S-Pages and SW-Pages may further modify the applicable Standard Specifications.

The following active SB(s) are included as part of this contract:

- *SB 22-006 – INCREMENTAL COST NEAR TRANSIT FACILITIES*
- *SB 23-001 – SEWER DESIGN STANDARDS*
- *SB 23-002 – PIPE BOLLARD*
- *SB 23-003 – MOBILIZATION*
- *SB 23-004 – SUSTAINABLE CONSTRUCTION*

The SB(s) are available online at:

<http://www1.nyc.gov/site/ddc/resources/specification-bulletins.page>

(NO FURTHER TEXT ON THIS PAGE)

NOTICE

UNLESS OTHERWISE NOTED, ALL SECTIONS, SUBSECTIONS, ARTICLES, OR SUBARTICLES AS REFERRED TO HEREIN WITHIN THESE NEW SECTION SPECIFICATIONS MUST BE THOSE OF THE NEW YORK CITY DEPARTMENT OF TRANSPORTATION'S (NYCDOT'S) CURRENT STANDARD HIGHWAY SPECIFICATIONS WITH CURRENT ADDITIONS, MODIFICATIONS AND REVISIONS TO THE STANDARD HIGHWAY SPECIFICATIONS (R-PAGES).

THE STANDARD HIGHWAY SPECIFICATIONS ARE NOT INCLUDED IN THESE I-PAGES. SEE THE NYCDOT STANDARD HIGHWAY SPECIFICATIONS BOOKS FOR STANDARD SPECIFICATIONS TEXTS.

(NO TEXT ON THIS PAGE)

TABLE OF CONTENTS

<u>SECTION NO.</u>	<u>DESCRIPTION</u>	<u>PAGE</u>
4.13 HWE-S	ALLOWANCE FOR CONCRETE SIDEWALK REPAIR UNDER THE CITY'S EXPEDITED/45 DAY REPAIR PREMIUM PLAN	I-1
4.13 HW-S	ALLOWANCE FOR CONCRETE SIDEWALK OF LESS THAN 100 S.F. PER PROPERTY	I-3
6.40	ENGINEER'S FIELD OFFICE	I-4
6.51 BD-P	PAVEMENT KEY AT PEDESTRIAN RAMPS (3' TO 6' WIDE)	I-12
7.13	MAINTENANCE OF SITE	I-14
7.35	PEDESTRIAN CHANNELIZER	I-22
7.70 TPR	TEMPORARY PEDESTRIAN RAMP	I-24
8.01	HANDLING, TRANSPORTING and DISPOSAL OF POTENTIAL and IDENTIFIED CONTMINATED AND HAZARDOUS MATERIALS	I-26
9.29	ALLOWANCE FOR RAILROAD FACILITIES INCLUDING INSURANCE AND FORCE ACCOUNT (ALL TYPES)	I-60
HW-900H	ALLOWANCE FOR CITY WORK ACCELERATION	I-62

(NO TEXT ON THIS PAGE)

SECTION 4.13 HWE-S - Allowance for Concrete Sidewalk Repair under the City's Expedited/45 Day Repair Premium Plan

1. Description. Under this item, a premium will be paid to the Contractor as payment for the additional costs of installing concrete sidewalk under the City's Expedited/45 Day Repair Premium plan.

2. Materials. (Not applicable)

3. Construction Details. Where the Contractor is ordered to interrupt the Contractor's current work order to perform work in the borough, but outside of the currently scheduled community board area, as requested by property owner's seeking an expedited repair of their sidewalk within 45 days of the written request made by the Engineer to the Contractor, the Contractor will be paid a premium rate of 40% above the itemized cost of 4" and 7" concrete item in the contract. Sidewalk installation will be strictly limited to defective sidewalk only and not for replacement of entire block face(s) and/or entire property frontage(s). The exact limits of sidewalk panel and flag replacement at each location will be determined solely by the Engineer. This may require substantial amount of saw cutting for which payment must be deemed included in the premium of 40% paid, under Item 4.13 HWE-S, for expedited concrete sidewalk repair work.

In addition, when that actual number of square feet of concrete sidewalk installed is an area totaling less than 100 square feet per property, then the Contractor must also be entitled to an additional twenty (20%) percent premium, under Item 4.13 HW-S, for a total premium of sixty (60%) percent of the unit price bid for that concrete sidewalk.

4. Method of Measurement. The fixed sum shown in the proposal for these items must be considered the price bid, although actual payment will be based on the work performed. The fixed sum is not to be altered in any manner by the bidder. Should the amount shown be altered, the new figures will be disregarded and the original price will be used to determine the total amount bid for the contract.

Payment under this item must be based on the actual number of square feet of concrete sidewalk installed under the City's Expedited/45 Day Repair Premium plan.

5. Basis of Payment. Actual payment under this item will be based on the method of computation described above in these specifications.

The total estimated cost of this item is the "fixed sum" amount shown for this item in the Bid Schedule. No guarantee is given that the actual lump sum cost for this item will in fact be the "fixed sum" amount. The "fixed sum" amount is included in the total bid solely to ensure that sufficient monies will be available to pay the Contractor for the additional cost necessary to relocate the Contractor's operations to expedited property locations.

This "fixed sum" amount must be included with the other amounts bid by the Contractor for all the other items under this contract.

Payment will be made under:

Item No.	Item	Pay Unit
4.13 HWE-S	ALLOWANCE FOR CONCRETE SIDEWALK REPAIR UNDER THE CITY'S EXPEDITED/45 DAY REPAIR PREMIUM PLAN	F.S.

SECTION 4.13 HW-S - Allowance for Concrete Sidewalk of Less Than 100 S.F. per Property

1. Description. Under this item, a premium will be paid to the Contractor as payment for the additional costs of installing concrete sidewalk in areas totaling less than 100 square feet per property (lot and block number), excluding concrete sidewalk in corner quadrants.

2. Materials. (Not applicable)

3. Construction Details. Where the proposed area of concrete sidewalk to be installed under other contract items, as specified in each work order, total less than 100 square feet per property, excluding concrete sidewalk in corner quadrants, a premium of 20% of the unit price bid for that concrete sidewalk item will be paid to the Contractor. Said premium will be paid under this Item 4.13 HW-S, for the additional cost of installing concrete sidewalk in small areas totaling less than 100 square feet per property (lot and block number).

4. Method of Measurement. The fixed sum shown in the proposal for these items must be considered the price bid, although actual payment will be based on the work performed. The fixed sum is not to be altered in any manner by the bidder. Should the amount shown be altered, the new figures will be disregarded, and the original price will be used to determine the total amount bid for the contract.

Payment under this item must be based on the actual number of square feet of concrete sidewalk installed in areas totaling less than 100 square feet per property.

No additional payment will be made under this item for quantities of concrete sidewalk installed in corner quadrants, and for concrete sidewalk installed in areas totaling 100 square feet, or greater, per property (block and lot).

5. Basis of Payment. Actual payment under this item will be based on the method of computation described above in these specifications.

The total estimated cost of this item is the "fixed sum" amount shown for this item in the Bid Schedule. No guarantee is given that the actual lump sum cost for this item will in fact be the "fixed sum" amount. The "fixed sum" amount is included in the total bid solely to ensure that sufficient monies will be available to pay the Contractor for the additional cost necessary to install concrete sidewalk in cumulative areas totaling less than 100 square feet per property.

This "fixed sum" amount must be included with the other amounts bid by the Contractor for all the other items under this contract.

Payment will be made under:

Item No.	Item	Pay Unit
4.13 HW-S	ALLOWANCE FOR CONCRETE SIDEWALK OF LESS THAN 100 SQUARE FEET PER PROPERTY	F.S.

The Section 6.40 below supersedes and replaces Section 6.40 of NYC DOT

Standard Specifications dated May 16, 2022

SECTION 6.40 – Engineer’s Field Office

6.40.1. DESCRIPTION. The Contractor shall provide, furnish, and maintain a fully equipped field office (Type A, B, C, CU, D, DC, or DU, as specified) for the exclusive use of and occupancy by the Department’s engineering personnel and/or Supervising Consultant (herein after called “City personnel”), and by the engineering personnel of private utilities when specified. The field office shall be at a location approved by the Engineer and shall be a commercial building, store front, or with the approval of both Office of Construction Mitigation and Coordination (OCMC) and the Community Board it may be a mobile trailer(s). If a trailer is used it shall be subject to approval by the Engineer, and all necessary permits shall be obtained by the Contractor. The Contractor may have facilities in an adjoining area separated by a lockable door, provided such facilities are in a location approved by the Engineer. The field office must be within ½ mile of the job site. Field offices located further than ½ mile from the job site will require approval by the Director or Assistant Commissioner for Construction. The field office structure and occupancy thereof shall conform to the requirements of all laws, rules, regulations and orders applicable to it. The field office and all equipment, except as otherwise specified, may be new materials or may be used materials in good condition and satisfactory to the Engineer.

6.40.2. MATERIALS.

(A) **GENERAL CONSTRUCTION.** The Engineer’s Field Office shall be in an approved and weatherproof building. It shall have a minimum ceiling height of seven (7’) feet and be partitioned to provide the number of rooms required for the type of office specified. Floor space for Field Office Types C, CU, D, and DU shall be subdivided into work areas based on a floor plan provided by the City to the Contractor upon notification of space availability.

(B) **GENERAL FACILITIES.** The field office shall contain or have the following facilities incorporated:

- (a) Lighting - Electric light, non-glare type luminaries to provide a minimum illumination level of 100 ft.- candles at desk height level.
- (b) Heating and Cooling - Adequate equipment to maintain an ambient air temperature of 70° F. ±5°.
- (c) Electrical Energy Outlets
- (d) Toilet - A separate enclosed room, properly ventilated per code and complying with applicable sanitary codes shall contain a lavatory with a sink that provides running hot and cold water, flush-type toilet, mirror, electric hand dryer, and paper towel dispenser.
- (e) Potable Water - Potable water supplied from an existing system or five (5) gallon capacity water cooler of a type to be approved by the Engineer shall be provided for use by City personnel. Replacement bottles of water shall be provided by the Contractor, when required.
- (f) Signs - Store front locations shall have a window graphic sign in black and white lettering with the following inscription. Other locations shall have a wood or metal sign affixed on the outside wall of the building with the following inscription painted in black block lettering on a white background. Paints shall be approved exterior enamels.

CITY OF NEW YORK	2-1/2”
DEPARTMENT OF DESIGN AND CONSTRUCTION	3-1/2”
INFRASTRUCTURE	2-1/2”
RESIDENT ENGINEER’S FIELD OFFICE	2-1/2”

- (g) Electric Refrigerator - Five (5) cubic feet minimum capacity for use by City personnel.

- (h) Microwave, Toaster Oven, and Coffee Maker - Basic reheating equipment or approved appliances for use by City personnel.
 - (i) Windows and Doors - All windows and doors shall be weatherproof and each equipped with adequate locking devices. Each window shall be equipped with vertical blinds. Exterior doors shall be provided with two (2) separate "high security" dead bolt type cylinder locks, keyed alike, and three (3) keys shall be furnished for each lock.
 - (j) Partitions - Partitions for work space enclosures shall be either permanent walls or of the modular type similar to Herman Miller's standard fabric covered line.
 - (k) Kitchen Sink – Mechanism to provide non-drinking, hot and cold, running water.
 - (l) Security Cameras – Wifi enabled security cameras must be provided at all entrances and exits, except that fire escapes / emergency stairwells do not require cameras. One security camera must be provided for the interior of the field office, with the location to be determined by the Engineer. Cameras must be minimum 1080p video resolution. Cameras must have internet cloud storage, with all videos stored for a minimum of two weeks. The cloud storage must be accessible via desktop or mobile. Cameras may be hardwired for power or battery powered; battery powered cameras must have the batteries changed by the Contractor as required to ensure no lapses of service. Signs must be posted indicating that the area is under video surveillance.
- (C) OFFICE EQUIPMENT.
- (a) Pencil Sharpener - One standard pencil sharpener for use by City personnel.
 - (b) Telephone Answering Machine - The telephone answering machine to be provided shall be an electronic digital voice machine with emergency call forwarding capability. It shall be operable twenty four (24) hours per day and, when unattended, shall transmit to the caller the following message:
 "You have reached the Field Office of the New York City Dept. of Design and Construction. No one is here now. We check our incoming messages frequently. We will get back to you as soon as possible. Please leave your name, message and phone number where you may be reached. In case of emergency, call the New York City Hotline at 311. Again, the emergency number is 311."
 All electronic voicemail messages shall be automatically forwarded as email attachments, to allow for the voicemails to be played remotely.
 - (c) Computer Equipment - Computers shall be provided for all contracts regardless of construction duration.
 Computers furnished by the Contractor for use by City Personnel, for the duration of the contract, shall be in accordance with Table I - ADDITIONAL SPECIFIC REQUIREMENTS, contained herein, and shall meet the following minimum requirements:
 - (1) Personal Computers – Personal Computers must meet the requirements of the US General Services Administration (GSA) Government-Wide Strategic Solutions (GSS) Standard Laptop, Desktop, and Tablet Specifications, V7. (Available online at <https://hallways.cap.gsa.gov/>)
 - (a) Computer type for Personal Computers to be "Desktop Small Form Factor." Computer type for projector laptop to be "Lightweight Notebook" or "Notebook"
 - (b) The following components listed as optional in the GSA specification must be provided with each personal computer: monitor, speakers, optical drive, smart card reader, webcam, and headset.
 - (c) The following additional software must be provided with licenses for each computer:
 1. Adobe Acrobat Pro DC or Bluebeam Revu
 2. Microsoft Office Professional
 3. Autodesk AutoCAD LT
 4. Anti-virus software
 5. Microsoft Visio (only one license required per field office)

- (2) All field offices requiring computers shall be provided with the following:
- (a) One (1) broad-band internet service account. See table below for minimum required upload and download speeds. Telephone service should be bundled together with Internet connectivity. Because of throughput requirements Verizon FIOS is the preferred connectivity provider where available.

Office Personnel #	Download Speeds (Minimum)	Upload Speeds (Minimum)
1 – 5	10 Mbps	15 Mbps
6 – 10	20 Mbps	15 Mbps
11 – 15	25 Mbps	15 Mbps
16 – 20	50 Mbps	15 Mbps

This account will be active for the life of the project. The e-mail name for the account shall be the NYCDDC Field Office/project Id (preferably Gmail or Outlook – e.g. HWK666@gmail.com).

- (b) All necessary Cabling.
- (c) Storage Boxes for and Blank CDs/DVDs.
- (d) UPS/Surge Suppressor combo.
- (e) 10 USB Thumb (or Flash) Drive – 16 GB each
- (3) All computers required for use in the Engineer's Field Office shall be delivered, installed, and setup in the Field Office by the Contractor.
- (4) All Computer Hardware shall come with a three (3) year warranty for on-site repair or replacement. Additionally, and notwithstanding any terms of the warranty to the contrary, the Contractor is responsible for rectifying all computer problems or equipment failures within one (1) business day.
- (5) An adequate supply of blank CDs/DVDs, and paper and toner cartridges for the printer shall be provided by the Contractor, and shall be replenished by the Contractor as required by the Engineer.
- (6) It is the Contractor's responsibility to ensure that electrical service and phone connections are also available at all times; that is, the Field Office Computer(s) is to be powered and turned on twenty-four (24) hours each day. Broadband connectivity is preferred at each field office location. Please take into consideration that an extra phone line dedicated to the modem must be ordered as part of the contract unless Internet broadband connectivity, via Cable or FiOS, is available at the planned field office location. Any questions regarding this policy should be directed to the Director of Information Technology Services at 718-391-1761.
- (d) Data Access - Electronic access to the EquipmentWatch Retail Rental Rates database (formerly known as The AED Green Book, published by Equipment Watch), shall be provided for all contracts that have a total Consecutive Calendar Days for General Construction duration as set forth in Schedule A of greater than 545 CCD's. Contracts of lesser duration shall not require any data access.
- (D) Field Testing Equipment.
- (a) Air Entrainment Meters - Pressure Type, with carrying case for use by City personnel. Each meter shall be capable of producing an accurate test result in approximately five (5) minutes and shall comply with ASTM Designation C231.
- (b) Slump Test Sets - Slump cone and test sets conforming to the requirements of ASTM Designation C143, complete with rod and scoop for use by City personnel.
- (c) Thermometers: For use by City personnel.
- (1) 1 Minimum-maximum thermometer.
- (2) 3 Asphalt thermometers of stainless steel construction with an accuracy of 0.5% of the full scale, able to measure temperatures from 50 to 500 degrees F. in 5 degree increments.

- (3) 3 Surface Thermometers able to measure temperatures of flat surfaces similar to Sargent-Welsh Model S81441-D, or an approved equivalent.
 - (d) Nonsparking Pinch Bar - For use in opening manholes.
 - (e) Gas Meters - For use in detecting the presence of explosive gases and vapors for use by City personnel.
 - (f) Straight Edge - One 10 foot long straight edge for use by City personnel in detecting pavement surface tolerance.
 - (g) 48" Smart Level - For use in determining pedestrian ramp and sidewalk slopes.
 - (h) Chlorine Test Kits – For testing residual chlorine levels following water main flushing.
 - (i) Green Florescent Power Trace-Dye – For testing sewer connections.
 - (j) One Million Candlepower Rechargable Flashlight.
 - (k) Distance Measuring Wheel – For measuring long distances.
- (E) Additional Office Electronics –
- (a) Photocopying machine must be a stand-alone, heavy duty, electric, dry-process color photocopying type with color scan and send capability via e-mail, a minimum production rate of 70 pages per minute and an adequate supply of copy paper, toner, etc. The machine shall be capable of duplex copying paper sizes of 8-1/2 x 11 inches, 8-1/2 x 14 inches and 11 x 17 inches, and have separate trays for each paper size. It shall have a document feeder, collator, stapler, and the capability to reduce/enlarge copies between each paper size. The supply of each size copy paper, toner, etc. shall be replenished and the machines shall be maintained for the duration of the contract by the Contractor as required by the Engineer. Make and model can be Minolta, Canon, IBM, Epson, or an approved equivalent, and shall be networked to the office computers for printing capability.
 - (b) Fax machine must be provided with an adequate supply of copy paper, toner, etc. The supply of copy paper, toner, etc. shall be replenished and the machines shall be maintained for the duration of the contract by the Contractor as required by the Engineer.
 - (c) Paper shredder must be a heavy duty commercial grade diamond cut shredder with automatic start. The shredder shall be able to receive 8-1/2 inch wide paper and shred a minimum of 15 sheets simultaneously along with CDs and staples.
 - (d) Projector must be 1080p LCD with a min. of 2200 ANSI Lumens, 1920 x 1080, 16:9, 40,000:1 contrast ratio, HDMI, VGA, USB, and a 10' diagonal, 16:9 Projection Screen. A screen must be provided if directed by the Engineer. A laptop must be provided for use with the projector, and all required cables for connecting the laptop to the projector.

6.40.3. SPECIFIC REQUIREMENTS FOR ENGINEER'S FIELD OFFICE.

In addition to the general requirements, each type of Field Office shall have the minimum floor area indicated in Table 6.40-I calculated based on usable area only, excluding any loss factors. Loss factors are defined as those areas such as lobby, sidewalk window ledge, elevator shafts and stairways. The Contractor shall provide and maintain furnishings for each type of Field Office in the quantity specified in Table 6.40-I. The furnishings shall be new or used equipment satisfactory to the Engineer:

- (a) Each Type shall have a minimum of one outside door and four windows.
- (b) Type C shall be partitioned to provide three (3) rooms.
- (c) Type CU shall be partitioned to provide four (4) rooms, one of which shall be at least 150 s.f. in area (for use by private utilities).
- (d) Type D and DC shall be partitioned to provide four (4) rooms.
- (e) Type DU shall be partitioned to provide five (5) rooms, one of which shall be at least 150 s.f. in area (for use by private utilities).

TABLE 6.40-I – ADDITIONAL SPECIFIC REQUIREMENTS

SPECIFIC REQUIREMENTS	FIELD OFFICE TYPE						
	A	B	C	C U	D	D C	D U
Minimum useable floor space (Square Feet)	4 0 0	8 0 0	1 , 2 0 0	1 , 2 0 0	1 , 8 0 0	2 , 3 2 0	1 , 8 0 0
Office desks, at least 4'-8" x 2'-8", with drawers, locks, and keys.	2	2	4	8 _a	8	8	1 2 _a
Swivel chairs, with arms, for the above.	2	2	4	8 _a	8	8	1 2 _a
Office folding chairs, metal, with padded seats and backs.	2	3	6	4 b	8	8	1 6 b
Steel supply cabinets (approximate size 72" high by 36" wide by 18" deep), with four adjustable shelves, tumbler lock and 3 keys.	1	1	1	1	1	1	1
Fire resistant cabinet, 4-drawer, legal size with lock and three (3) keys, meeting the requirements for "Filing devices, Insulated (36 E 9)" Class D Label, of the Underwriters' Laboratories, Inc. Specifications.	1	1	1	3 c	4	4	6 c
Individual lockers (17" wide x 18" deep x 72" high) with flat key locks and two (2) keys each.	1	1	4	4	4	4	4
Calculating machines, tape type with digital display registering at least ten (10) digits.	1	1	2	2	3	3	3
Waste paper baskets (metal, approximately 12" square by 16" high).	1	2	2	6 a	4	4	8 a
Fire extinguishers, non-toxic, dry chemical type meeting Underwriters Laboratories, Inc., approval for Class A, Class B and Class C fires with a minimum rating of 2A:10B:10C.	1	1	2	3 d	4	8	5 d
First Aid Kit kept properly stocked with appropriate first aid supplies at all times.	1	1	1	1	2	2	2
Drafting tables (3'-0" x 5'-0") with storage drawers and stool.	1	2	2	3 d	4	4	5 d
Photocopying Machine	1	1	1	1	1	1	1
Standalone networked color laser printer. (Not required if photocopying machine prints in color)	1	1	1	1	1	1	1
Vertical filing plan racks for six sets of 22"x36" plans each rack.	1	1	2	3 d	4	4	5 d
Telephone lines for calls, where one shall be dedicated for the Fax Machine, one for each computer fax/modem and the others for telephone instruments.	4	6	6	7 e	8	8	9 e
Telephone instruments.	2	2	3	5 e	4	4	6 e

SPECIFIC REQUIREMENTS	FIELD OFFICE TYPE						
	A	B	C	C U	D	D C	D U
Telephone answering machine.	1	1	1	1	1	1	1
Fax Machine	1	1	1	1	1	1	1
Personal Computer	1	3	3	3	4	4	4
Bottled water with refrigerator unit-hot/cold water. (For private utilities room.)	0	0	0	1	0	0	1
Paper Shredder	1	1	1	1	1	1	1
Projector	0	0	1	1	1	1	1
Conference Room, 320 square foot (20'x16' minimum, equipped with (2) 3'x6.5' tables and (30) chairs.	0	0	0	0	0	1	0

- a Provide four (4) each of Office Desks, Swivel Chairs and Waste Paper Baskets in private utilities room.*
- b Provide eight (8) Folding Chairs in private utilities room.*
- c Provide two (2) Fire Resistant 4- Drawer Legal Size Cabinets in private utilities room.*
- d Provide one (1) each of Fire Extinguisher, Drafting Table and Vertical File Rack in private utilities room.*
- e Provide one (1) telephone line and two (2) telephone instruments for the exclusive use by private utilities personnel. The line shall interconnect the two telephone instruments by push button control.*

6.40.4. CONSTRUCTION METHODS. The building shall be fully equipped and made available for use and occupancy by the Department's personnel and/or Supervision Consultant not less than thirty (30) days prior to the start of any contract work.

The building interior (including access foyers, stairwells, etc.) shall be maintained in good, clean, and sanitary working condition by the Contractor for the duration of the contract. The Contractor shall provide and pay all costs for electrical service, telephone service for calls within New York City limits, hot and cold water, heat and fuel, and daily janitor service. Staples, such as paper towels, hand soap, toilet paper, and similar supplies, shall always be available.

Where necessary, the site for a mobile trailer(s) shall be graded and shoulder stone placed and maintained as directed by the Engineer to provide a parking area for City personnel and, if necessary, an approach road shall be provided. Plumbing work shall include all water supply, drainage and piping required for the operation of a complete installation. Temporary water service shall be provided from an existing main and extended into the trailer and all fixtures requiring water supply shall be properly connected up. All necessary soil, waste, vent and drainage piping shall be provided and connected to the existing sewer or as otherwise directed.

The office, incorporated facilities, equipment, and personal property of the Department's employees shall be protected by the Contractor against loss or damage from fire, theft, or other causes, at all hours of the day and night. The Contractor shall provide fire insurance, extended coverage and vandalism, malicious mischief and burglary, and theft insurance coverage in the amount of forty thousand dollars (\$40,000.00) for office equipment of the City of New York in the Engineer's field office and for property of City personnel that is used in the contract work and stored in the office. All insurance coverage shall be written by a company approved by the Commissioner and payable in case of loss to the City of New York. The office shall be maintained by the Contractor in first class condition until final acceptance of the work.

At the direction of the Engineer, any equipment on the above lists may be deleted. The Engineer may direct that other equipment of equivalent value be supplied by the Contractor or an appropriate credit be taken for the value of equipment not provided

When directed by the Engineer, the Contractor shall disconnect all services and remove and dispose of all temporary installations from the site, including fencing, surfacing and utilities, the area shall then be cleaned, loamed and seeded if required and left in a neat and acceptable condition. On and after the date of the Engineer's Final Acceptance, the temporary structure and all installed equipment shall become the property of the Contractor, and shall be disposed of, by him, away from the site of the work. Engineer's Final Acceptance shall be when the Contractor has completed all punch list work and Official Completion Date has been set.

6.40.5. NONCONFORMANCE. No payment will be made under Engineer's Field Office for each calendar day during which there are deficiencies in compliance with the requirements of any subsection of this specification. The first calendar day shall commence twenty-four (24) hours after notice to the Contractor of such a deficiency. This non-payment shall be deducted from the Contractor's next estimate as a charge to the Contractor on the item. The amount of such calendar day non-payment will be determined by dividing the unit price bid per month by 30.

In addition, the Contractor may be subject to liquidated damages in accordance with Schedule A.

6.40.6. MEASUREMENT. The quantity to be measured for payment under this item shall be the number of months that the Field Office is available for occupancy by the Field Engineers during the period of the contract. Payment will begin the first month that the office is fully equipped, serviced as specified, and made available for occupancy. The Field Office is to be continuously made available and monthly payments will continue for the duration of the contract through a period not to exceed 6 months past the Substantial Completion date. When directed in writing by the Commissioner, the Field Office will be provided and paid for a period of time beyond 6 months past the Substantial Completion date. Payment for each month's occupancy after the date of Substantial Completion acceptance will be made as part of the final estimate. Monthly payments may be terminated on a specified date prior to acceptance of the contract by written notification by the Engineer that such office will no longer be required on the contract.

In order to incentivize early Substantial Completion of the Project, the City agrees to share the savings resulting from the reduction of the quantity measured for payment under this item.

If the determination of Substantial Completion is reached at least two (2) months earlier than the Substantial Completion date set forth in the Notice to Proceed letter, plus any approved time extensions, the Contractor and the City will evenly split the saved amount. This payment will be in addition to any payments of incentive for early completion, if one is specified for the Project.

For example, using a contract with a 30-month duration for achievement of substantial completion, with the Engineer's Field Office directed by the Commissioner to remain open six (6) months after the substantial completion date per Subsection 6.40.6 above, the following would apply under these two scenarios:

1. Project substantial completion is achieved in 28.5 months: Because the contract was completed within two (2) months of the scheduled substantial completion date, the contractor is entitled to be paid for the 28.5 month project duration plus the six (6) months after Substantial Completion, amounting to 34.5 months to be paid to the Contractor for the Engineer's Field Office, with no additional amounts due to the contractor from any savings.
2. Project substantial completion is achieved in 26 months: Because the contract was substantially completed more than two (2) months early, the contractor is entitled to be paid for the 26 month project duration plus six (6) months after substantial completion plus half of the four months saved, amounting to 34 months to be paid to the contractor for the Engineer's Field Office.

6.40.7. PRICE TO COVER. The unit price bid per month for the item Engineer's Field Office shall include the cost of furnishing all labor, materials, equipment, ground rental, fire and theft insurance, and utility charges necessary to complete the work of providing or constructing the field office; making all necessary electrical, water, sewer, and other connections required to make the above facilities operative; payment of all rental costs; furnishing and paying for heating fuel, as required; all electrical energy; private telephone services; staples, as specified; and all necessary incidentals to complete the work - all in accordance with the specifications and the directions of the Engineer.

Payment will be made under:

Item No.	Item	Pay Unit
6.40 A	ENGINEER'S FIELD OFFICE (Type A)	MONTH
6.40 B	ENGINEER'S FIELD OFFICE (Type B)	MONTH
6.40 C	ENGINEER'S FIELD OFFICE (Type C)	MONTH
6.40 CU	ENGINEER'S FIELD OFFICE (Joint Use) (Type CU)	MONTH
6.40 D	ENGINEER'S FIELD OFFICE (Type D)	MONTH
6.40 DC	ENGINEER'S FIELD OFFICE WITH CONFERENCE ROOM	MONTH
6.40 DU	ENGINEER'S FIELD OFFICE (Joint Use) (Type DU)	MONTH

SECTION 6.51 BD-P - Pavement Key at Pedestrian Ramps (3' to 6' Wide)

1.INTENT. This section describes the work of installing pavement keys in order to remove depressed or damaged wearing course, to facilitate storm water runoff (without ponding) and to facilitate installation of new pavement.

2.DESCRPTION. The construction of pavement keys must consist of cutting, milling, and removing a portion of the existing pavement to the required depth and width, generally next to curb or areas of poor pavement; all in accordance with the specifications and the directions of the Engineer.

3.METHODS. The Contractor must saw-cut or chisel-cut, for a depth of 1-1/2", a joint line in the existing asphaltic concrete wearing course at limits of pavement keys as directed.

All grindings (millings) and excavation material removed under this Section must be loaded directly into dump trucks and must be satisfactorily disposed of by the Contractor, away from the site. No debris will be allowed to accumulate at the site.

All milling must be done prior to excavation of existing curb; however, it must be done not less than two weeks prior to the excavation of existing curb.

4.USES. Pavement Key at Pedestrian Ramp (various widths) must be used in the following locations:

- a. At all locations requiring gutter adjustments (3' to 6' wide) both inside and outside corner quadrant (pedestrian ramp) areas as directed. To lower roadway or reshape roadway to eliminate ponding.
- b. To remove asphaltic bumps or depression or badly crazed areas in the roadway to provide positive surface flow away from the ramp area.
- c. Milling must be to the required depth to facilitate an average of 1-1/2" resurfacing after the work is completed.
- d. At locations to be excavated under other contract items.

5.MEASUREMENT. The quantity to be measured for payment, under Item 6.51 BD-P, must be the number of cubic yards of existing pavement actually cut out to provide a pavement key at pedestrian ramps and other locations as directed. Measurement must be a vehicle measurement based on the number of cubic yards of material removed and disposed away by Contractor, measured in trucks at the place of loading. Only water level loads will be accepted and no allowance will be made for any crown or peak of the load.

6.PRICE TO COVER. The contract price per cubic yard of Item 6.51 BD-P, must cover the cost of furnishing all labor, plant, equipment, insurance, and necessary incidentals required for completing the work, including saw cutting at beginning and end of grinding limits, cutout of existing roadway material, loading all grindings and excavated material into dump trucks, and removing and disposing of said material away from the site, all in accordance with the specifications and the directions of the Engineer.

Payment will be made under:

Item No.	Item	Pay Unit
6.51 BD-P	PAVEMENT KEY AT PEDESTRIAN RAMPS (3' TO 6' WIDE)	C.Y.

The Section below supersedes and replaces Section 7.13 of NYC DOT

Standard Specifications dated May 16, 2022

SECTION 7.13 – Maintenance of Site

7.13.1. DESCRIPTION. This section describes the maintenance, protection and cleanup of the construction site. The Contractor is placed on notice that a safe and clean site throughout all phases of the work and during all operations must be provided by the Contractor, and further that the monitoring by the City of the Contractor's site maintenance, site protection and site cleanup is considered for the purposes of the contract to be a Project objective necessary to eliminate and/or mitigate public disruption and inconvenience, and to insure public health and safety. The Contractor shall therefore, at all times, conduct this operation in a manner which promotes a clean site and insures the convenience, safety and health of general users consisting of, but not limited to, the motorist, the pedestrian and the abutting property owners/tenants, as well as those of the Contractor's employees. This includes compliance with the Contractor Code of Conduct in **Section 1.06.19**.

The provisions of this section are supplementary to and do not abrogate the General Conditions (Section 1.06) or the General Notes on the Contract Drawings relating to the protection and cleanup of the site, and the delivery and storage of materials at the site. Furthermore, any conditions pertaining to the maintenance, protection and cleanup of the construction site during the life of the contract which are addressed in the General Conditions and in the General Notes on the Contract Drawings, whether or not addressed under this Section, shall be deemed as having been addressed under this Section.

7.13.2. METHODS.

(A) GENERAL

Work under this Item shall start from the date of written notice to commence work or from the actual start of construction work at the site, whichever is later.

The Contractor shall be responsible for the maintenance of the contract streets or portions of streets pursuant to Article 7 of the Standard Construction Contract.

The Contractor shall provide the necessary personnel and equipment for adequate site maintenance within and adjacent to the contract site and all detour routes. The Contractor shall keep the work site and adjacent areas free and clean from all rubbish, debris, dust, idle construction equipment, discarded or leftover construction material and excavated material as outlined below. The Contractor shall also keep all haul routes outside the work site free and clean from all rubbish, debris and dust resulting from the Contractor's operations.

The Contractor shall protect the public from damage to persons and property, which may result directly or indirectly from any construction operation. Such protection shall include, but not be limited to, providing proper street drainage and diversion of runoffs from private properties by such means as sandbagging or pumping, controlling soil erosion and/or soil migration.

All existing Fire Department Communication facilities shall be protected and provisions made for their continuous operation during construction. ALL ALARM BOXES AND POSTS MUST REMAIN ACCESSIBLE. If, due to the Contractor's operations, Fire Alarm Service is inadvertently interrupted or Fire Communication System equipment or facilities are damaged, the Contractor will be held responsible and shall replace them at its own expense and in accordance with Fire Department requirements.

The Contractor shall be fully responsible for maintaining the completed work in an acceptable condition and protecting the completed work until relieved of such responsibility by acceptance of the contract or the completed items of work. Upon completion of each phase of work, or when

ordered by the Engineer, and before acceptance and final payment are made, the Contractor shall remove all surplus and discarded material, rubbish, equipment, debris, and temporary structures from the site, and restore the working site as directed by and to the satisfaction of the Engineer. All sewers, water mains, appurtenant structures, etc., shall be clean, free from debris and deposits.

(B) MAINTENANCE OF STREETS

Maintenance of streets and detours for vehicles shall include any repairs, as directed, including the filling of pre-existing and new potholes that may be necessary due to usage of streets by traffic. This repair work will be paid for under Item No. 4.02 CB - ASPHALTIC CONCRETE MIXTURE, or 4.02 CA - BINDER MIXTURE, as provided in the Bid Schedule.

Also, the Contractor shall provide reasonably safe and convenient walkways and passageways for pedestrian traffic. Where required by the Contract Documents or when ordered by the Engineer, the Contractor shall construct and maintain, as directed, temporary asphalt walkways and ramps in accordance with the requirements of Subsection 7.13.2.(G)(1), below, temporary wood plank or steel plate ramps or other configurations and materials, as may be required, and provide temporary pedestrian passageways (as per the NYC Department of Transportation's Standard Details of Construction, Standard Drawing H-1004, or as otherwise approved). The Contractor shall make the surface(s) of the pedestrian pathway(s) safe by eliminating ponding conditions, removing debris, sweeping, and wetting for dust control. All walkways and passageways must be in compliance with all ADA requirements.

The Contractor shall maintain access to all abutting properties and pedestrian usage of sidewalk areas, both old and new, at all times, as directed by the Engineer and as shown on the Contract Drawings, except at "Sidewalk Closings" as designated or as directed.

The Contractor shall maintain the traveled way in such a condition and conduct operations in such a manner that snow and ice may be readily removed by others as and when necessary, and in such a manner that proper drainage is provided for the melting of snow in the banks resulting from normal plowing. However, the Contractor will not be responsible for snow or ice removal on the pavement or traveled way opened for public usage, except within the limits of the work zone(s) which may include, but is not limited to, stairway, promenades, esplanade areas, and sidewalk, including those fronting the Contractor's office and the Engineer's field office all of which will be the responsibility of the Contractor. In order to minimize the amount of salts entering the storm sewer system, snow melt must not be used in place of shoveling, but must be used after all standing snow is removed. This does not prohibit applying reasonable amounts of snow melt prior to snowfall.

(C) CONTROL OF DUST AND DEBRIS

The Contractor shall control dust and debris within the work area and the traveled way. The Contractor shall mitigate material spilling from trucks with the use of tarpaulin covers. All dust producing materials shall be wet down with water to the extent necessary to minimize dust. When public or local inconvenience is caused by dust occasioned by the sweeping and cleaning operations, the Contractor shall furnish and sprinkle water onto the affected surfaces during the sweeping and cleaning operations; however, the application of water shall not be used as a substitute for sweeping.

The Contractor shall perform all work operations so that dust and debris is minimized within the work zone and mitigated before any of it leaves the work zone. Movement of dust and debris by wind, vehicles, persons, and the Contractor's operations shall be cause for sweeping and watering to be implemented immediately as directed by the Engineer. Also, should dust and dirt cover over all or portions of the work site it shall also be cause for immediate sweeping and watering by the Contractor.

All water furnished and applied under this item shall be free from harmful materials and shall be reasonably clean. Water shall be delivered in tanks or tank trucks, or by use of hydrants as permitted by the Department of Environmental Protection; however, no guarantee is made by the City as to the availability of suitable hydrants at the site. Where no suitable hydrants exist at the

site, the Contractor shall be required to furnish water in tanks or tank trucks at no additional cost to the City.

(D) CLEANING OF SITE AND WASTE DISPOSAL

The Contractor shall be responsible for the removal of all rubbish and debris from the site of the project. The Contractor shall remove all piles of rubbish, debris, waste material and wood cratings as a result of the Contractor's operations as they accumulate. When directed by the Engineer the Contractor shall cart them away from the site. The Contractor shall employ and keep engaged for this purpose an adequate force of laborers.

The Contractor shall at the beginning and end of each day be required to pick up all litter, trash and debris (excluding garbage and recycled material set to be picked up by scheduled private and/or public sanitation pickups) adjacent to and within the work zone on a daily basis, seven (7) days a week. The Contractor shall also during the day keep clean all roadways, sidewalks and other places in which the work is being performed or which are to be used in connection therewith.

The Contractor shall protect the site against unauthorized dumping of waste materials by patrolling the site and reporting violations to the Engineer, and should any unauthorized dumping occur, it shall be immediately remove by the Contractor to the Engineer's satisfaction.

While performing the above site cleaning work, the Contractor shall have available an approved mechanical street sweeper, with operator, suitable for removing dirt, debris, dust and loose stones; a sprinkler truck; adequate size pick-up truck with driver and laborers; an adequate supply of brooms, sixteen (16) inch wide or larger; and necessary hand tools and materials. The Contractor shall arrange to have necessary persons and equipment assigned to satisfy concerns relating to required clean up and restoration work. These persons with equipment shall be available to correct all matters requiring attention and shall be immediately available to respond to directives issued by the Engineer regarding specified problems of maintenance and cleaning.

The Contractor shall perform this work during the normal or extended working days. However, when required in accordance with the approved schedule or directed, the Contractor shall be prepared to extend this work beyond the normal work day, including weekends.

The Contractor shall provide trash receptacles for use by its construction staff. The trash shall be periodically removed and disposed of in compliance with local ordinances.

(E) DISPOSAL OF REMOVED MATERIALS

Except as may be otherwise specified herein or in the General Conditions, all materials which are permanently removed from the existing construction by the Contractor in accordance with the Contract Documents shall become the Contractor's property and shall be disposed of by him away from the site.

In addition, it is the intent of NYCDDC to have all metals that are excavated and removed from the site, such as iron castings street hardware (i.e. manhole frames and cover, valve box covers, hydrants, etc.), ductile iron sewer pipe, steel and ductile iron water main pipe, trolley track rails, etc. (excluding steel reinforcement embedded in concrete), recycled provided that they are not deemed contaminated or hazardous. Therefore, the Contractor shall agree to make every effort possible to recycle said metals removed from the site. As a record of such compliance, the Contractor shall be required to keep an accurate log of said materials that are excavated and removed from the site and where and how said materials are either processed for reuse or disposed of away from the site. A copy of said log shall be submitted to the Engineer along with the invoice submitted by the Contractor for payment each month.

(F) REMOVAL OF SURPLUS PLANT AND EQUIPMENT

When ordered by the Engineer, the Contractor shall be required to promptly move from any location within the contract area all such items of plant and equipment determined to be no longer necessary for the effective prosecution of the work at such point, to other locations to be designated by the

Engineer. If, in the opinion of the Engineer, plant and equipment are no longer required on any portion of the work, they shall be removed from the site when so ordered.

Where access to regularly scheduled private and/or public sanitation pickups, such as garbage and recycled materials, is blocked due to the Contractor's operations, the Contractor shall coordinate a schedule for collection of said materials, and/or shall collect and transport garbage and recycled materials to collection points, as directed by the Engineer, for disposal by public or private collections, as appropriate.

Waste material shall not be dumped in or on any part of the City's property except by special permission of the Engineer. Concrete mixing trucks shall not be washed on City streets nor shall the waste material from the washing out of concrete mixing trucks be discharged to any street, public property, sewer manhole, catch basin, sewer, street gutter, or other above or below ground structures. All excavated materials falling on roadways and sidewalks shall be promptly swept up and removed.

(G) MAINTAINING ACCESS TO PROPERTIES AT CUT AND FILL LOCATIONS

When it is necessary to cut or fill at abutting properties in accordance with the contract requirements, the Contractor shall immediately commence construction to provide entrance to and egress from said properties as shown on the Contract Drawings and/or by one of the following methods, or modifications made thereto, when so ordered by the Engineer:

(1) "Asphalt Ramps"

Temporary access ramps shall be made hard and smooth surfaced with asphaltic material (to be paid for under Item No. 4.02 CB or 4.02 CA, as provided in the Bid Schedule) The slope of temporary ramps at driveways and transition areas shall be approximately 25% [approximately a three (3") inch rise in one (1') foot] and be limited to a width of not more than eight (8') feet for single driveways and not more than twelve (12') feet for double driveways. The slope of temporary ramps at street hardware shall range between 1:10 and 1:6 (rise:run). The slope of temporary pedestrian ramps shall be limited to a width of not less than four (4') nor more than five (5') feet and a slope of approximately 1:12.

(2) "Benching"

In locations where embankments are to be constructed on existing slopes or against existing embankments with slopes steeper than 1 (vertical) on 3 (horizontal), slopes shall be benched as shown on the Contract Drawings. Benches shall be constructed as a "Temporary Retaining Wall" (Item No. 8.12). Access to abutting properties shall be provided as shown on the Contract Drawings or as per the details shown on the NYC Department of Transportation's Standard Details of Construction, Standard Drawing for Temporary Wooden Steps (Item No. 7.15).

(3) "Specified"

By methods specified and detailed on the Contract Drawings.

(H) FINAL CLEARANCE OF SITE

Immediately after the completion of the contract and before final acceptance of the Work by the Department, the Contractor shall remove all surplus material, temporary structures, and debris resulting from the Contractor's operations. Any painted markings (layout survey, etc.), excluding utility markings made under 16 NYCRR Part 753 (utility markings made under Part 753 shall not be removed), that have been placed by the Contractor and which are still remaining at the end of the contract shall be removed. Removal of painted markings shall be done using an approved power-washing method. The entire area shall be cleared and left in a neat presentable manner satisfactory to the Commissioner.

If as a result of the Contractor's operations, obstructions have fallen into a navigable waterway, they must be removed and the waterway and channel cleared; and the Contractor must obtain a release from the United States Coast Guard.

7.13.3. STORAGE OF MATERIALS AND EQUIPMENT. Roadways, sidewalks, gutters, crosswalks, and driveways shall at all times be kept clear and unobstructed unless a permit has been obtained from NYC Department of Transportation authorizing encumbrance of the roadway and/or sidewalk with equipment and/or material, provided it is in a manner which will not prevent the safe passage of vehicular traffic on such roadway designated to remain open, or the safe passage of pedestrians on such sidewalk and crosswalks, or block the normal drainage flow within the streets.

(A) DELIVERED MATERIALS NOT TO OBSTRUCT TRAFFIC

All materials delivered upon but not placed in the work shall be neatly piled so as not to obstruct public travel and shall be removed from the line of the work, at the direction of the Engineer, at no additional cost to the City. Unless the materials are so removed by the Contractor upon notice from the Engineer, the materials may be removed by the Commissioner and the expense thereof charged to the Contractor.

(B) PILING OF MATERIALS DELIVERED TO WORK SITE

Materials placed on the sidewalk or roadway shall be piled or stacked in a satisfactory and safe manner, enclosed with plastic barrels (Section 6.87) or barricades (Section 6.28 AA or 6.28 BA), and with pedestrian steel barricades (Section 7.36), "WARNING: KEEP OUT" signs (Section 6.25), and heavy duty safety orange construction fencing. The heavy duty safety orange construction fencing shall be safety orange in color, of heavy duty construction grade flexible plastic (light duty plastic screening fence will not be accepted), have a minimum height of four (4') feet, and shall be of a type approved by the Engineer. The heavy duty safety orange construction fencing shall be held vertically in place for its full length and shall be securely attached to barrels, utility poles, or a combination thereof, or other traffic control devices shown on the Contract Drawings or directed, in a manner approved by the Engineer. Loose materials shall be covered with tarpaulins, suitably held down. Areas adjacent to stored materials shall be kept clean and watered as required and as directed by the Engineer. When such materials are removed, the sidewalks and roadways must be immediately swept clean by the Contractor and control of dust shall be mitigated in accordance with the requirements of Subsection 7.13.2.(C), above.

Materials to be used in the work shall be compactly piled within limits to be designated by the Engineer. Sand and coarse aggregate may be piled within the roadway area. All old and such new material as has been approved, except sand and coarse aggregate, shall be neatly piled by the Contractor on the front half of the sidewalk, on planks or plates, if the same be flagged or otherwise improved.

Stored material shall be neatly stacked, placed at locations designated by the Engineer, and suitably enclosed or covered, protected, and wet down, as stipulated above. Streets under such construction material or equipment shall be shielded by wooden planking, skids or other protective covering approved by the Engineer. All pipes, fittings and appurtenances must be carefully stored, as approved by the Engineer, so as to prevent surface drainage, excavation material or other foreign matter from entering into the pipes, fittings and appurtenances.

Waste material and excavated material will under no conditions be permitted to remain on the work site or

Provisions must be made by the Contractor to maintain curb-line drainage through storage areas. Stored materials shall not block the normal drainage flow or cause ponding conditions within streets, and shall not be placed within fifteen (15') feet of any fire hydrant (working or not), at bus stops, within tree root zone areas, or any other areas as set forth in the rules of the department the obstruction of which would impair the safety or convenience of the public (also see General Notes on Contract Drawings for any additional information). In a street upon which there is a surface railroad, construction materials or equipment shall not be placed nearer to the track than five (5) feet.

The Contractor shall not be permitted to store, stockpile or lay down any construction material within the boundaries of tree pits or critical root zone (CRZ) of existing trees. This material includes but is not limited to: lumber, fuel and oil containers, pipes, pipe fittings, barricades, hand tools, hoses, hardware, bricks, salvaged stone or granite, trash receptacles, or asphalt. Bulk material, equipment, or vehicles shall not be stockpiled or parked within the CRZ of any tree, or within ten (10') feet of the trunk (whichever is greater). This is done to minimize surface and subsurface root and soil compaction. This applies to all

CRZs within or outside the project limit line. CRZ is calculated as (DBH x 1.5 ft = Radius). The radius calculation is equal to the critical root zone.

When no work is in progress, at least one half of the roadway must be left clear at all times.

The Contractor must remove any stored materials/equipment from the project street(s), as directed by the Engineer, within forty-eight (48) hours' notice, at no additional cost to the City. Payment for compliance with such a directive shall be deemed included in the unit price bid for this "Maintenance of Site" item.

(B) ILLUMINATION OF BUILDING MATERIAL AND EQUIPMENT ON STREETS

Pursuant to Section 19-121 of the Administrative Code of the City of New York, the Contractor's attention is directed to the following:

1. Whenever a permit is issued for any construction material or equipment, the outer surface of such construction material or equipment shall be clearly marked with high intensity fluorescent paint, reflectors, or other marking which is capable of producing a warning glow when illuminated by the headlamps of a vehicle or other source of illumination.
2. Each approved storage area shall have at least one (1) sign identifying the Contractor's name, Project ID/Name, and the phone number of the Engineer's Field Office.
3. Violations. Any person who shall violate any of the above provisions, upon conviction thereof, shall be subject to the Criminal penalties pursuant to Section 19-149 of the Administrative Code of the City of New York or Civil penalties pursuant to Section 19-150 of the Administrative Code of the City of New York, or both such fines and imprisonment.

(D) STORAGE WITHIN THE PROJECT LIMITS

The Contractor will not be permitted to store construction equipment, construction material or excavated material within the project limits, except where specifically approved by the Engineer and only under the following conditions:

The Contractor will not be permitted to allow the personal vehicles of the Contractor's work force to be stored, parked, or to stand within the limits of any designated work area or in "no parking", "no standing", and/or other restricted zones; vehicles so stored, parked, or found standing may be ticketed and/or towed at the owner's expense. This restriction shall exclude Contractor owned vehicles transporting and/or storing specialized equipment and/or materials necessary for the execution of ongoing contract work, as approved by the Engineer. The Contractor shall be responsible for properly notifying the Contractor's work force of these restrictions.

Payment for traffic control devices such as plastic barrels, barricades, pedestrian steel barricades, and warning signs used to enclose stored materials and equipment within the project limits will be paid for under the appropriately scheduled items; however, when no appropriately scheduled item or items are provided in the bid schedule, the cost of those items shall be deemed included under all scheduled items.

Materials stored on site shall be "Installed in Place" within two (2) consecutive working days of delivery to the job site, unless otherwise specified or permitted by the Engineer. (Construction supervisor will be required to maintain accurate records of all delivery dates.) No material shall be stored on site during construction shutdowns and/or stoppages scheduled to last more than five (5) consecutive working days.

(E) STORAGE OUTSIDE THE PROJECT LIMITS

The Contractor may be permitted to occupy off site street/roadway areas for material storage, subject to their availability and conformance with City wide permitting requirements for storage of materials; however, this neither implies nor guaranties the Contractor the availability and/or approval of any off site street/roadway areas.

Materials and/or equipment must be stored safely and neatly as specified above, with appropriate Maintenance and Protection of Traffic devices separating the storage area from vehicular traffic and pedestrians. Loose materials must be properly and neatly stored.

No separate payment will be made for providing off site storage site(s) where approved or for providing any traffic control devices used for off site storage, the cost of which shall be deemed included under all scheduled items.

7.13.4. NONCONFORMANCE. No payment will be made under Maintenance of Site for each calendar day during which there are deficiencies in compliance with the foregoing specification requirements, as determined by the Engineer and made evident by the Engineer's failure to sign documents each day approving payment to be made under this item.

The amount of such calendar day non-payment will be determined by dividing the unit price bid per month by thirty (30).

If the Contractor fails to maintain and protect the site, or any portion thereof, adequately and safely for a period of three (3) or more consecutive hours, the Engineer may correct the adverse conditions by any means deemed appropriate, including, but not limited to, "outside services," and shall deduct the cost of the corrective work from any monies due the Contractor. The cost of this work shall be in addition to the nonpayment for site maintenance listed above.

However, where continued nonconformance with the requirements of this specification is noted by the Engineer, and prompt Contractor compliance is deemed not to be obtainable, all contract work may be stopped by direct order of the Engineer, regardless of whether corrections are made by the Engineer as stated in the paragraph above.

Furthermore, in addition to the remedies specified above, in the event the Contractor shall fail to comply, within three (3) consecutive hours after written notice from the Engineer, with the requirements of the contract and the specifications in the matter of providing facilities and services for the maintenance, protection and cleanup of the construction site, the Contractor shall pay to the City of New York, until such notice has been complied with or rescinded, the sum shown per calendar day in Schedule A, for each instance of such failure, as liquidated damages and not as a penalty, for such default.

Any money due the City of New York under this provision shall be deducted from the amounts due or to become due to the Contractor for work performed under the contract.

7.13.5. MEASUREMENT.**(A) MAINTENANCE OF SITE (LUMP SUM)**

Payment will be made by lump sum.

(B) MAINTENANCE OF SITE (PER MONTH)

The quantity to be measured for payment under this item shall be the number of months (to the nearest 1/4 month increment) that the Contractor satisfactorily provides for the Maintenance of Site in accordance with these specifications, including winter shut down, holiday embargo, and other work suspension periods for which the Contractor remains responsible for site maintenance. Measurement for this item shall not begin until actual construction work is started at the site.

Periods where the Contractor is demobilized and not continuing the site maintenance will not be measured for payment. The Engineer will provide written notice two weeks in advance that the Contractor is being deemed to be demobilized. For the avoidance of doubt, reduced activity during winter shut downs, holiday embargos, and other work suspension periods as shown on the Contractor's approved CPM schedule do not count as demobilization, provided the Contractor continues to be responsible for site maintenance and responsive to notifications of nonconformance per **Subsection 7.13.4** above. Should such nonconformance occur during periods of demobilization, the liquidated damages described in **Subsection 7.13.4** above may be assessed during periods where maintenance of site is not being measured for payment.

In order to incentivize early completion, the City agrees to share the savings resulting from the reduction of the quantity measured for payment under this item.

If the determination of Substantial Completion is reached at least two (2) months earlier than the Substantial Completion date set forth in the Notice to Proceed letter, plus any approved time extensions, the Contractor and the City will evenly split the saved amount. This payment will be in addition to any payments of incentive for early completion, if one is specified for the Project.

For example, using a contract with a 30-month duration for achievement of substantial completion, the following would apply under these two scenarios:

1. Project substantial completion is achieved in 28.5 months: Because the contract was completed within two (2) months of the scheduled substantial completion date, the contractor is entitled to be paid the 28.5 month project duration for the Maintenance of Site, with no additional amounts due to the contractor from any savings.
2. Project substantial completion is achieved in 26 months: Because the contract was completed more than two (2) months prior to the scheduled substantial completion date, the contractor is entitled to be paid the 26 month project duration plus half of the four months saved, amounting to 28 months to be paid to the contractor for the Maintenance of Site.

7.13.6. PRICE TO COVER.

(A) MAINTENANCE OF SITE (LUMP SUM)

The lump sum price bid for Maintenance of Site shall include the cost of furnishing all labor, materials, plant, equipment, insurance and incidentals required to maintain, protect and clean up the site, all in accordance with the Contract Drawings, these specifications, and the directions of the Engineer. Payment will be made in proportion to the percentage of actual contract completion. The final payment for this item will be in direct proportion (whether higher or lower) to the final contract value as compared to the original contract value.

(B) MAINTENANCE OF SITE (PER MONTH)

The unit price bid per month for Maintenance of Site shall include the cost of furnishing all labor, materials, plant, equipment, insurance and incidentals required to maintain, protect and clean up the site, all in accordance with the Contract Drawings, these specifications, and the directions of the Engineer.

Where no separate item is provided for this work, the cost thereof shall be deemed to be included under all scheduled items.

Payment will be made under:

Item No.	Item	Pay Unit
7.13 A	MAINTENANCE OF SITE	L.S.
7.13 B	MAINTENANCE OF SITE	MONTH

**SECTION 7.35 - PEDESTRIAN CHANNELIZER
(NOT A PAY ITEM)**

7.35.1. INTENT. This section describes the work of providing interlocking pedestrian channelizers to be used as temporary pedestrian access route between pedestrian and construction work areas when directed by the Engineer.

Pedestrian channelizer must provide the same level of pedestrian guidance as concrete or plastic barrier, but should be light weight, easier to transport, install and remove with interlocking arrangements.

7.35.2. MATERIALS. The work shall consist of furnishing, maintaining, relocating, and removing pedestrian channelizer in sidewalk areas as per the specifications, as shown on the Contract Drawings or where otherwise directed by the Engineer.

Pedestrian Channelizer units must meet the requirements of the following standards:

- a. 2010 ADA Standards for Accessible Design
- b. 2011 Proposed Accessibility Guidelines for Pedestrian Facilities in the Public Right-of-Way (PROWAG)
- c. 2009 Manual on Uniform Traffic Control Devices (MUTCD), with FHWA Revisions and NYS Supplements

Product should meet the crash test and evaluation criteria contained in the American Association of State Highway and Transportation Officials' (AASHTO) Manual for Assessing Safety Hardware (MASH) and have a FHWA acceptance letter.

Acceptable products include:

- a. ADA PEDESTRIAN BARRICADE – STRONG WALL by PLASTICADE
- b. ADA COMPLIANT PEDESTRIAN BARRICADE like Safety Rail & SafetyWall by PSS
- c. Urbanite 57000 Series by Urbanite
- d. Plastic Safety System Safety Wall by PAUL PETERSON SAFETY DIVISION.
- e. Or approved equivalent

Battery operated flashing units as approved by the Engineer.

7.35.3. METHODS. Pedestrian Channelizer units of the various sizes required shall be furnished to the site, complete, ready to use. All units shall be in good condition and acceptable to the Engineer. pedestrian channelizer installed must meet the requirements of the standards listed in **Section 7.35.2** above.

The Contractor shall install pedestrian channelizer by placing them where shown on the Contract Drawings or where otherwise directed by the Engineer. Adjacent units

shall be interlocked. Weights (sand or water ballast in the unit, sandbags, concrete blocks, etc.) must be used per the manufacturer's recommendations, as necessary to ensure stability, or as directed by the Engineer. Weights must not interfere with pedestrian travel. The minimum number of interlocked barricade units in a given run must be two, unless otherwise approved by the Engineer. Where less than three units are required and approved by the Engineer, additional measures shall be taken by the Contractor to stabilize the shorter length of interlocking barricade and prevent overturning.

At corners, units four feet or less in length must be used to form smooth curved runs of barricade.

Contractor shall continuously maintain the temporary pedestrian steel barricades, where shown on the Contract Drawings or directed by the Engineer, until ordered by the Engineer to remove the barricades at the completion of a work stage. Should a unit or units of barricades become damaged or otherwise unacceptable to the Engineer, the Contractor shall replace said units within twenty-four (24) hours of notice by the Engineer, at no additional cost to the City.

Battery operated flashing units will be installed on every alternate pedestrian channelizer or as approved by the Engineer.

7.35.4. MEASUREMENT AND PAYMENT

The price of PEDESTRIAN CHANNALIZER is be deemed included in the price for item number 6.70 under Maintenance and Protection of Traffic per SECTION 6.70.

SECTION 7.70 TPR - TEMPORARY PEDESTRIAN RAMP (NOT A PAY ITEM)

7.70TPR.1. INTENT. This section describes the work of providing Temporary Pedestrian Ramps (TPRs) near new pedestrian construction work areas and the ADA guidelines. TPRs must provide access to sidewalk routes when pedestrian ramps are not accessible due to construction activities going on or around pedestrian ramps.

The work will consist of furnishing, installation, maintaining, relocating, and removing TPRs in order to access sidewalk areas as shown on the Contract Drawings or where otherwise directed by the Engineer.

TPRs must consist of temporary pedestrian ramp units having a geometry similar to that shown on the Contract Drawings, as directed the Engineer and complying with the following requirements:

1. TPR running slope must not exceed 1:12 ramp slope, which equals 4.8 degrees slope or one foot of wheelchair ramp for each inch of rise. For instance, a 30 inch rise requires a 30 foot handicap wheelchair ramp.
2. Cross slope must not exceed 1:48.
3. Handrails must be provided on both sides if rise is more than 6 inches.
4. A minimum 5' x 5' flat, unobstructed area at the top and bottom of the ramp
5. A Minimum width of 36 inches of clear space across the wheelchair ramp.
6. Maximum run of 30 feet will be allowed ramp before a rest or turn platform.
7. Ramp handrail height will be between 34" and 38" in height on both sides of the wheelchair ramps.
8. The TPR must allow for normal street drainage.

7.70TPR.2. MATERIALS AND METHODS.

1. LUMBER TPR: Lumber must have a slip-resistant surface. Use pressure treated wood for most of the wood material. Lumber must be preservative-treated southern pine, grade #2 or better. Pressure treated lumber must resist rot and decay with level of treatment as per American Wood Council latest standards. Decking board for the TPR will be at a minimum 2" thick.

2. ALUMINUM TPR: Aluminum must be high traction (e.g., textured extruded aluminum surface), dock plate with a coefficient of friction not less than 0.5 and made from high strength, lightweight aluminum; it must be slip-resistant and have a self-adjusting ground transition plate. The Ramp, Step, and Platform system is designed to be a rigid, free-standing structure. All footplates must be fastened securely to a concrete surface or 12" minimum diameter footings in order to achieve full structural integrity. Footing depth will depend on local building code. Fastening all platforms to the building or modular building with lag screws is highly recommended.

3. FIBERGLASS/PLASTIC TPR: Fiberglass/ Plastic ramps must be able to take minimum wheelchairs, foot traffic etc., not less than 550 lbs., should be ADA compliant and adapts to varying curb heights from minimum of 2.5" to 7". Must be anti-slip with high visibility surface and must be bolted for maximum stability and security. Coefficient of friction will not be less than 0.5.

All ramp handrails and ramp guardrails are designed to withstand a concentrated load of 200 pounds applied in any direction on the top of the rail.

All ramp handrails are designed to be continuous along ramp runs and in between the inside corner of 90 degree and 180 degree turns in ramp direction. Handrails are not interrupted by posts or other obstructions.

Platforms and landings will be designed to carry a uniform live load of 100 pounds per square foot and a concentrated vertical load of 300 pounds in an area of one square foot.

Walking surfaces for serial number 1, 2 and 3 above must be designed to have a coefficient of friction no less than 0.50 in all directions of travel.

7.70TPR.3. METHODS. All units must be in good condition and acceptable to the Engineer. The Contractor must install the TPR by placing them where shown on the Contract Drawings, specifications and as directed by the Engineer. All the modular ramps will be assembled as per manufacturer's instructions.

If the modular ramps are pre-assembled and transported to their locations, Contractor must use utmost care in the delivery and installation of these units.

Units can also be fabricated/constructed at site with the approval of the Engineer.

Contractor must continuously maintain the TPR, where shown on the Contract Drawings or directed by the Engineer, until ordered by the Engineer to remove the completion of a work stage.

Should a unit or units of barricades become damaged or otherwise unacceptable to the Engineer, the Contractor must replace said units within twenty-four (24) hours of notice by the Engineer, at no additional cost to the City.

7.70TPR.4. MEASUREMENT AND PAYMENT

The price of Temporary Pedestrian Ramp (TPR) will be deemed included in the prices bid for all the scheduled contract items.

The Section below supersedes and replaces Sections 8.01, 8.01 C1, 8.01 C2, 8.01H, 8.01S, 8.01W1, & 8.01 W2 of NYC DOT Standard Specifications dated May 16, 2022

SECTION 8.01 Handling, Transporting, and Disposal of Potential and Identified Contaminated and Hazardous Materials

8.01.1. DESCRIPTION. This Section provides common references and requirements for Sections 8.01 C1, 8.01 C2, 8.01H, 8.01S, 8.01W1, and 8.01 W2.

8.01.2. MATERIALS. None.

8.01.3. METHODS.

(A) NYCDEP Limitations for Discharge to Sewer

NYCDEP Bureau of Wastewater Treatment–Limitations for Effluent to Sanitary or Combined Sewers

Parameter ¹	Daily Limit	Units	Sample Type	Monthly Limit
Non-polar material ²	50	mg/l	Instantaneous	---
pH	5-11	SU's	Instantaneous	---
Temperature	< 150	Degree F	Instantaneous	---
Flash Point	> 140	Degree F	Instantaneous	---
Cadmium	2 0.69	mg/l mg/l	Instantaneous Composite	---
Chromium (VI)	5	mg/l	Instantaneous	---
Copper	5	mg/l	Instantaneous	---
Lead	2	mg/l	Instantaneous	---
Mercury	0.05	mg/l	Instantaneous	---
Nickel	3	mg/l	Instantaneous	---
Zinc	5	mg/l	Instantaneous	---
Benzene	134	ppb	Instantaneous	57
Carbontetrachloride	---	---	Composite	---
Chloroform	---	---	Composite	---
1,4 Dichlorobenzene	---	---	Composite	---
Ethylbenzene	380	ppb	Instantaneous	142
MTBE (Methyl-Tert-Butyl-Ether)	50	ppb	Instantaneous	---
Naphthalene	47	ppb	Composite	19
Phenol	---	---	Composite	---
Tetrachloroethylene (Perc)	20	ppb	Instantaneous	---
Toluene	74	ppb	Instantaneous	28
1,2,4 Trichlorobenzene	---	---	Composite	---
1,1,1 Trichloroethane	---	---	Composite	---
Xylenes (Total)	74	ppb	Instantaneous	28
PCB's (Total) ³	1	ppb	Composite	---
Total Suspended Solids (TSS)	350 ⁴	mg/l	Instantaneous	---
CBOD ⁵	---	---	Composite	---
Chloride ⁵	---	---	Instantaneous	---
Total Nitrogen ⁵	---	---	Composite	---
Total Solids ⁵	---	---	Instantaneous	---

Notes for table above:

1. All handling and preservation of collected samples and laboratory analyses of samples must be performed in accordance with 40 C.F.R. pt. 136. If 40 C.F.R. pt. 136 does not cover the pollutant in question, the handling, preservation, and analysis must be performed in accordance with the latest edition of "Standard Methods for the Examination of Water and Wastewater." All analyses must be performed using a detection level less than the lowest applicable regulatory discharge limit. If a parameter does not have a limit, then the detection level is defined as the least of the Practical Quantitation Limits identified in NYSDEC's Analytical Detectability and Quantitation Guidelines for Selected Environmental Parameters, December 1988.
2. Analysis for **non-polar materials** must be done by USEPA method 1664 Rev. A. Non-Polar Material will mean that portion of the oil and grease that is not eliminated from a solution containing N-Hexane, or any other extraction solvent the USEPA will prescribe, by silica gel absorption.
3. Analysis for PCBs is required if **both** conditions listed below are met:
 - a. if proposed discharge \geq 10,000 gpd;
 - b. if duration of a discharge $>$ 10 Days.

Analysis for PCBs must be done by USEPA method 608 with MDL= $<$ 65 ppt. PCB's (total) is the sum of PCB-1242 (Arochlor 1242), PCB-1254 (Arochlor 1254), PCB-1221 (Arochlor 1221), PCB-1232 (Arochlor 1232), PCB-1248 (Arochlor 1248), PCB-1260 (Arochlor 1260) and PCB-1016 (Arochlor 1016).

4. For discharge \geq 10,000 gpd, the TSS limit is 350 mg/l. For discharge $<$ 10,000 gpd, the limit is determined on a case-by-case basis.
5. Analysis for Carbonaceous Biochemical Oxygen Demand (CBOD), Chloride, Total Solids and Total Nitrogen are required if proposed discharge \geq 10,000 gpd.

(B) Applicable Regulations

Applicable regulations include, but are not limited to:

1. 49 CFR 100 to 179 - DOT Hazardous Materials Transport and Manifest System Requirements
2. 6 NYCRR 375-6 - NYSDEC Remedial Program Soil Cleanup Objectives
3. 6 NYCRR 360-1 NYSDEC Solid Waste Management Facilities
4. 6 NYCRR 364- Waste Transporter permits
5. Local restrictions on transportation of waste/debris
6. 40 CFR 260 to 272 - Hazardous Waste Management (RCRA)
7. 6 NYCRR 371 - Identification and Listing of Hazardous Wastes
8. 6 NYCRR 372 - Hazardous Waste Manifest System and Related Standards for Generators, Transporters and Facilities
9. 6 NYCRR 373-1 - Hazardous Waste Treatment, Storage and Disposal Facility Permitting Requirements
10. 6 NYCRR 376 - Land Disposal Restrictions
11. Posted weight limitations on roads or bridges
12. Transportation Skills Programs, Inc. 1985 - Hazardous Materials and Waste Shipping Papers and Manifests
13. Other local restrictions on transportation of waste/debris
14. Occupational Safety and Health Administration (OSHA), Standards and Regulations, 29 CFR 1910 (General Industry)
15. OSHA 29 CFR 1910.120 Hazardous Waste Operations and Emergency Response
16. OSHA Safety and Health Standards 29 CFR 1926 (Construction Industry)

17. OSHA 29 CFR 1910.146 Confined Space Entry Standard
18. Standard Operating Safety Guidelines, USEPA Office of Emergency and Remedial Response Publication, 9285.1-03
19. NIOSH / OSHA / USCG / USEPA Occupational Safety and Health Guidance Manual for Hazardous Waste Site Activities (1986)
20. U.S. Department of Health and Human Services (DHHS) "NIOSH Sampling and Analytical Methods," DHHS (NIOSH) Publication 84-100
21. ANSI, Practice for Respiratory Protection, Z88.2 (1980)
22. ANSI, Emergency Eyewash and Shower Equipment, Z41.1 (1983)
23. ANSI, Protective Footwear, Z358.1 (1981)
24. ANSI, Physical Qualifications for Respirator Use, Z88.6 (1984)
25. ANSI, Practice for Occupational and Educational Eye and Face Protection, Z87.1 (1968)
26. Water Pollution Control Federation "Manual of Practice No. 1, Safety in Wastewater Works"
27. NFPA No. 327 "Standard Procedures for Cleaning and Safeguarding Small Tanks and Containers"
28. Occupational Safety and Health Act Confined Space Entry Standard 29 CFR 1910.146.87
29. Department of Transportation 49 CFR 100 through 179
30. Department of Transportation 49 CFR 387 (46 FR 30974, 47073)
31. Environmental Protection Agency 40 CFR 136 (41 FR 52779)
32. Environmental Protection Agency 40 CFR 262 and 761
33. Resource Conservation and Recovery Act (RCRA)
34. Any transporter of hazardous or non-hazardous materials must be licensed in the State of New York and all other states traversed in accordance with all applicable regulations.

(C) Definitions

Contaminated Groundwater and Decontamination Fluids: Groundwater within the excavation trench or decontamination water that contains regulated compounds above the NYCDEP Discharge to Sewer Effluent limits.

Disposal or Treatment Facility: A facility licensed to accept either non-hazardous regulated waste or hazardous waste for either treatment or disposal.

Exclusion Zone: Work area that will be limited to access by Contractor personnel specifically trained to enter the work area only. The exclusion zone will be set up to secure the area from the public and untrained personnel. The project health and safety program will apply to all construction personnel including persons entering the work area.

Hazard Assessment: An assessment of any physical hazards that may be encountered on a work site.

Hazardous Soils: Soils that exhibit any of the characteristics of a hazardous waste, namely ignitability, corrosivity, reactivity, and toxicity, as defined in 6 NYCRR Part 371, Section 371.3 and 40 CFR Section 261.

Hazardous Substance Evaluation: An evaluation of the possible or known presence of any hazardous substances that may be encountered on a job site. This evaluation is included in the Health and Safety Plan and will include the identification and description of any hazardous substances expected to be encountered. Material Safety Data Sheets (MSDS) will be included for each substance.

Health and Safety Plan: A plan employed at a work site that describes all the measures that will be taken to assure that all work is conducted in a safe manner, and that the health of the workers and the public will be insured.

Material Handling Plan: A plan outlining the methods that will be employed to handle, transport and dispose of contaminated materials.

Non-Hazardous Contaminated Soils: Soils which exhibit a distinct chemical or petroleum odor or exhibit elevated photoionization detector readings but are not classified as hazardous waste under 6 NYCRR Part 371, Section 371.3 and 40 CFR Section 261.

New York State Health Department's Environmental Laboratory Approval Program: A program by which the state of New York approves and accredits environmental testing laboratories.

PCBs: Polychlorinated biphenyls are a group of toxic compounds commonly used as a coolant in transformers and other electrical components.

Photoionization Detector: A handheld instrument used to measure volatile organic compounds in air. The instrument ionizes the organic molecules through the use of an ultraviolet lamp.

RCRA Hazardous Waste Characteristics: Characteristics of a material which may indicate the material is hazardous. These include ignitability, corrosivity, reactivity, and toxicity.

Total Petroleum Hydrocarbons: An analytical procedure used to determine the total amount of petroleum compounds in a material.

(D) Phase I and Phase II Investigation Reports

If Phase I and / or Phase II investigation reports have been prepared for the Project, they will be included in the HAZ-Pages in Volume 3 of the Contract.

If there are no Phase I and / or Phase II investigation reports in the HAZ-Pages in Volume 3 of the Contract, but 8.01 bid items are included in the Bid Schedule, the Contractor is to assume the excavated soil is contaminated and bid on the quantities listed. The Contractor must use the Contractor's engineering judgement for pricing those items.

8.01.4. MEASUREMENT AND PAYMENT. No separate payment will be made for complying with the requirements of this Section.

ITEM 8.01 C1 HANDLING, TRANSPORTING AND DISPOSAL OF NON-HAZARDOUS CONTAMINATED SOIL

8.01 C1.1 WORK TO INCLUDE

A. General

This work will consist of the handling, transportation, and disposal of non-hazardous contaminated soils. The materials covered by this specification are soils that are contaminated with petroleum or other chemicals (including but not limited to metals, pesticides, polychlorinated biphenyls [PCBs], volatile organic compounds [VOCs], semi-volatile organic compounds [SVOCs], etc.) but cannot be classified as hazardous waste. For the purpose of this specification, soil will be defined as any material excavated below the pavement (concrete and/or asphalt) and pavement base (concrete and/or asphalt). Soil will also be defined as any material excavated from wetlands and/or wetlands adjacent area, or any areas that are not covered with hard pavement (e.g., concrete, asphalt), such as grass or dirt areas.

Soil to be excavated can be classified as non-contaminated, non-hazardous contaminated, or hazardous soil. Non-contaminated soils are defined as soils not exhibiting any of the following characteristics:

- Exceedances of New York State Department of Environmental Conservation (NYSDEC) Part 375-6 Restricted Commercial Soil Cleanup Objectives (SCOs) for street work, with the exception of benzo(a)pyrene which will have a limit of 3 parts per million (ppm), Restricted Residential SCOs for work areas in parkland, Residential SCOs for work in housing project areas, and Protection of Ecological Resources SCOs for work in wetlands and/or wetlands adjacent area.
- Elevated Photo-Ionization Detector (PID) readings (readings of greater than 10 parts per million [ppm] on a calibrated PID), which is subsequently confirmed by laboratory analysis specified under 8.01 C2.1.B.3
- Visual evidence of contamination, such as the presence of staining, discoloration, which is subsequently confirmed by laboratory analysis and exhibits exceedances of applicable SCOs.
- Petroleum and/or chemical odors, which are subsequently confirmed by laboratory analysis and exhibits exceedances of applicable SCOs.
- Physical evidence of coal ash, municipal solid waste, dredged spoils, or greater than 50% of the material is construction and demolition debris.

Non-hazardous contaminated soils are defined as soils exhibiting one or more of the above characteristics. Non-hazardous contaminated soils must be handled, transported, and disposed of in accordance with the specifications for Item 8.01 C1 – Handling, Transporting and Disposal of Non-Hazardous Contaminated Soil.

Hazardous soils are defined as soils showing exceedances of Toxicity Characteristic Leaching Procedure (TCLP) Regulatory Levels for Hazardous Waste published in Resource Conservation and Recovery Act (RCRA), 6 New York Codes, Rules, and Regulations (NYCRR) Part 371, or 40 Code of Federal Regulations (CFR) Section 261. Hazardous soils must be handled, transported, and disposed of in accordance with the specifications of this section.

This entire specification 8.01 covers the handling, transportation, and disposal of non-hazardous contaminated soils and hazardous soils only. Non-contaminated soil can be reused at the Project site, provided it meets other Contract requirements. Non-hazardous contaminated soils and hazardous soils cannot be reused. Excess non-contaminated soil becomes the property and responsibility of the Contractor.

The Contractor must ensure that all operations associated with the handling, sampling, loading, transportation, and disposal of non-hazardous contaminated soils are in compliance with all applicable Federal, State, and City statutes and regulations.

The Contractor must supply all equipment, material and labor required to conduct the specified work of this Item. The Contractor must document the excavation, handling, transportation and disposal of non-hazardous contaminated soils with analytical reports, manifests, photos, and clean fill documentation.

B. Request for Approval of Subcontractors

In accordance with Article 17 of the Contract, a subcontractor/subconsultant, such as the Environmental Consultant and the waste hauler, is not permitted to start work until approved by the Engineer. If the Contractor performs work using a subcontractor/subconsultant prior to approval, the Contractor will not be paid for the work performed by that subcontractor/subconsultant and the Contractor may be subject to penalties including, but not limited to, initiation of default proceedings.

The Contractor must submit a completed original Request for Approval of Subcontractors (RFAS) form and all required documents, such as legal identity, project reference list, Corporate Health and Safety Plan (HASP), waste transporter permits, Occupational Safety and Health Administration (OSHA) 10 certification, Hazardous Waste and Emergency Response (HAZWOPER) certification, etc., to the Engineer at least 30 days prior to the scheduled subcontract work start date. The Engineer must then submit the original RFAS to DDC Safety and Site Support, Office of Environmental and Hazmat Services (OEHS) for review and approval. If the RFAS is denied by OEHS, OEHS will issue the final denial and return the original RFAS to the Engineer. If the RFAS is approved by OEHS, OEHS will forward the original RFAS package and an approval memo to the DDC Agency Chief Contracting Officer (ACCO) for further review and approval. The ACCO's Vendor Integrity Unit and Office of Contract Opportunity (OCO) will review the subcontractor/subconsultant's overall business integrity and compliance with the vendor integrity requirements in the PASSPort system, Executive Order 50, Local Law 1, and Minority- and Women-Owned Business Enterprise/ Disadvantaged Business Enterprise (MWBE/DBE) participation as per the Contract. ACCO will issue the final Approval or Denial. The original RFAS will be returned to the Engineer, who will subsequently notify and return the original RFAS to the Contractor.

C. Environmental Consultant

The Contractor must retain an independent Environmental Consultant to obtain all permits, prepare the plans required in the specification 8.01 and as per DDC issued templates, and perform all field screening, sampling, air monitoring, and other health and safety services. The Contractor is not permitted to self-perform this work. The Environmental Consultant must be approved under the RFAS process and must demonstrate the minimum requirements as set forth below:

1. The Environmental Consultant project supervisor on site and other designated key personnel must have a minimum of three (3) years of experience in the environmental field dealing with issues associated with contaminated/hazardous soils. Such experience must include oversight of environmental investigations, specifically including VOC and dust monitoring services as a routine part of daily operations.
2. The Environmental Consultant must be experienced in work of similar nature, size, and complexity and must have previous experience in working with DDC.
3. The Environmental Consultant must furnish a list of at least five (5) projects completed within the last 3 years, identifying the location, nature of services provided, owner, owner's contact, contact's working telephone number, project duration and value of the projects.

D. Sampling and Analysis

Prior to the performance of soil sampling, the Contractor will submit a Field Sampling Plan (FSP). Soil sampling must not be conducted until OEHS has approved the FSP. The Contractor must conduct sampling and analysis of the impacted soils as specified under Item 8.01 C2 – Sampling and Testing of Non-Hazardous Contaminated/Potentially Hazardous Soil for Disposal Purposes. The laboratory results must be forwarded to OEHS for review to determine if the soils would be handled and disposed of as non-hazardous contaminated soils or hazardous soils.

E. Material Handling Plan

At least 45 days prior to the commencement of work, the Contractor must submit to the OEHS for review a Material Handling Plan (MHP). The MHP must be approved by the OEHS prior to the Contractor beginning any soil excavation work. The MHP must, at a minimum, consist of:

1. The Contractor's procedures for identifying non-hazardous contaminated soils during excavation, including the specific model and manufacturer of intended organic vapor monitoring equipment and calibration procedures to be used. It should also include the training and experience of the personnel who will operate the equipment.
2. The Contractor's procedures for safely handling non-hazardous contaminated soils. The procedures must include personnel safety and health as well as environmental protection considerations.
3. For the proposed laboratory for analysis of representative soil samples, provide the following: (a) name, (b) address, (c) telephone number, and (d) New York State Department of Health's (NYSDOH) Environmental Laboratories Accreditation Program (ELAP) status.
4. Identification of the Contractor's proposed waste transporter(s) (hauler). This information must include:
 - a) Name and Waste Transporter Permit Number;
 - b) Address;
 - c) Name of responsible contact for the waste transporter;
 - d) Telephone number for the contact;
 - e) All necessary permit authorizations for each type of waste transported; and,
 - f) Previous experience in performing the type of work specified herein.
5. The name and location of the facility where an off-site scale is located. The Contractor must outline the procedures for controlling trucks leaving the work site and enroute to the off-site scale.
6. All staging/stockpiling areas (if stockpiling areas are intended and available), or alternate procedures that will be used. Alternate procedures may include, but are not limited to, agreements from the intended disposal facilities to accept boring data and/or analytical data previously obtained during the site characterization so that materials may be directly loaded into vehicles for shipment to the disposal facility.
7. A backup facility must be provided, should the staging/stockpile areas become unavailable, insufficient in area, or presented by some other unforeseen difficulty.
8. Identification of the Contractor's two proposed Treatment Storage or Disposal (TSD) facilities for contaminated soils (primary and back-up) for final disposal of the soils. Both primary and backup TSD facilities must be currently state-licensed disposal facilities approved to receive contaminated soil. The information required for each facility must include:
 - a. General Information

- i. Facility name and the State identification number;
 - ii. Facility location;
 - iii. Name of responsible contact for the facility;
 - iv. Telephone number for contact;
 - v. Signed letter of agreement to accept waste as specified in this Specification. The letter must indicate agreement to handle and accept the specified estimated quantities and types of material during the time period specified in the project schedule and any time extension as deemed necessary; and,
 - vi. Unit of measure utilized at disposal facility for costing purposes.
- b. A listing of all permits, licenses, letters of approval, and other authorizations to operate, which are currently held and valid for the proposed facility.
 - c. A listing of all permits, licenses, letters of approval, and other authorizations to operate which have been applied for by the proposed facility but not yet granted or issued.
 - d. The Contractor must specify and describe the disposal/containment unit(s) that the proposed facility will use to manage the waste. The Contractor must identify the capacity available in the units and the capacity reserved for the subject waste.
 - e. The Contractor must provide the date of the proposed facility's last compliance inspection.
 - f. A list of all active (unresolved) compliance orders (or agreements), enforcement notices, or notices of violations issued to the proposed facility must be provided. The source and nature of the cause of violation must be stated, if known.
9. Description of all sampling and field/laboratory analyses that will be needed to obtain disposal facility approval.

8.01 C1.2 MATERIALS

- A. The Contractor must provide containers as specified in the United States Department of Transportation (USDOT) regulations.
- B. The Contractor must provide polyethylene sheeting, which is to be placed under (20mil. thickness minimum) and over (10 mil. thickness minimum) soil piles.
- C. The Contractor must assure that the waste transporter's appropriate choice of vehicles and operating practices are fitted to prevent spillage or leakage of non-hazardous contaminated material during transportation.
- D. The Contractor must provide, install, and maintain any temporary stockpiling or loading facilities on site as required until completion of material handling activities. The location and design of any such facilities must be included in the MHP.

8.01 C1.3 CONSTRUCTION DETAILS

A. Material Handling

- 1. Immediately after excavation of non-hazardous contaminated soil, the Contractor must:
 - a. Load material directly onto trucks/tankers/roll offs for disposal off site; or,
 - b. If interim stockpiling is required, place non-hazardous contaminated soil on a minimum of 20 mil. polyethylene sheeting and cover it securely by minimum of 10 mil. polyethylene sheeting to protect against cross contamination, airborne dust, leaching or runoff of contaminants into the subsurface, groundwater, or stormwater. Weight or secure the sheeting by appropriate means and seal seams as approved by the DDC to prevent tearing or removal by wind or weather. Grade surrounding surface to

provide for positive drainage away from pile. Each stockpile must not exceed 500 cubic yards. Non-hazardous contaminated soils must be stockpiled separately from non-contaminated and hazardous soil at an off-site location approved by DDC or secured on-site by the Contractor, meeting all required Federal, State and Local stipulations. Stockpiles must be at least 800 feet away from any sensitive receptors, such as schools, daycare center, hospitals, nursing homes, etc., and at least 100 feet away from any water body.

2. Institute appropriate procedures and security measures to ensure the protection of site personnel and the public from non-hazardous contaminated materials as described in the approved MHP, Environmental Health & Safety Plan (EHASP), and Item 8.01 S - Health and Safety.
3. Any soil encountered that appears to contain unknown contaminants (based on visual, odor, or other observation), or that vary substantially from the material originally identified must be segregated in stockpiles and the Environmental Consultant promptly notified to collect soil samples for analysis. Construct stockpiles to the same requirements as stated in subsection (A)(1)(b) above.
4. Provide any dewatering that is necessary to complete the work. Contaminated water must be disposed of in accordance with Item 8.01 W1 – Removal, Treatment and Discharge/Disposal of Contaminated Water.
5. Provide and operate field organic vapor test equipment, a PID or a flame ionization detector (FID), to detect general organic vapor levels at intervals of approximately 50 cubic yards of soil excavated, when visual or odor observations indicate the material may substantially differ from the soil previously excavated, and/or as directed by the Environmental Consultant.

B. Off-Site Transportation to Disposal Facility

1. General
 - a. The Contractor must furnish all labor, equipment, supplies and incidental costs required to transport non-hazardous contaminated material from the work area to the off-site disposal facility, and any other items and services required for transporting non-hazardous contaminated material for disposal at an off-site facility.
 - b. The Contractor will be responsible for tracking all materials and vehicles from the site to the off-site scale at the final TSD facility.
 - c. The Contractor must submit to the Engineer the certified tare and gross weight slips for each load received at the accepted facility which must be attached to each returned manifest. These documents must be maintained and kept with project field records.
 - d. Non-hazardous contaminated soils must be delivered to the disposal or treatment facility within 30 calendar days after excavation.
 - e. The Contractor must coordinate the schedule for truck arrival and material deliveries at the job site to meet the approved project schedule.
 - f. The Contractor must inspect all vehicles leaving the project site to ensure that non-hazardous contaminated soils adhering to the wheels or undercarriage are removed prior to the vehicle leaving the site.
 - g. The Contractor must obtain letters of commitment from the waste haulers and the TSD facility to haul and accept shipments when directed by the Engineer in consultation with OEHS.
 - h. The Contractor must provide waste profile forms to OEHS for review and approval before transporting non-hazardous contaminated soil to the approved TSD facility.

2. Hauling

- a. The Contractor must coordinate manifesting, placarding of shipments, and vehicle decontamination. All quantities must be measured and recorded upon arrival at the disposal facility. If any deviation between the two (2) records occurs, the matter is to be reported immediately to the Engineer and to be resolved by the Contractor to the satisfaction of the Engineer.
- b. The Contractor will be held responsible, at its own cost, for any and all actions necessary to remedy situations involving material spilled in transit or mud and dust tracked off-site.
- c. The Contractor must ensure that trucks are protected against contamination by properly covering and lining them with polyethylene sheeting or by decontaminating them prior to and between acceptance of loads. Trucks with loaded non-hazardous contaminated soil must be covered securely with tarps before leaving the project site to prevent generation of airborne dust during hauling.
- d. The Contractor will be responsible for inspecting the access routes for road conditions, overhead clearance, and weight restrictions.
- e. The Contractor must only use the transporter(s) identified in the approved MHP for the performance of work. A revised MHP or an addendum to the original approved MHP must be submitted to OEHS for review and approval at no additional cost to the City for any use of substitute or additional transporters.
- f. The Contractor must develop, document, and implement a policy for accident prevention.
- g. The Contractor must not combine non-hazardous contaminated materials from other projects with material from this project.
- h. No material will be transported until approval by the Engineer is obtained.

3. Off-Site Disposal

- a. The Contractor must use only the disposal facility(ies) identified in the approved MHP for the performance of the work. A revised MHP or an addendum to the original approved MHP must be submitted to OEHS for review and approval at no additional cost to the City for any use of substitutions or additions of disposal facilities.
- b. The Contractor must be responsible for acceptance of the materials at an approved facility, for ensuring that the facility is properly permitted to accept the stated materials, and for ensuring that the facility provides the stated treatment and/or disposal services.
- c. The City reserves the right to contact and visit the TSD facility, and regulatory agencies to verify the agreement to accept the stated materials and to verify any other information provided.
- d. In the event that the identified and approved facility ceases to accept the stated materials or the facility ceases operations, it is the Contractor's responsibility to locate an alternate approved and permitted facility(ies) for accepting materials. The alternate facility(ies) must be approved in writing by the Engineer in the same manner and with the same requirements as for the original facility(ies). This must be done at no extra cost or delay to the City.
- e. The Contractor must obtain manifest forms and complete the shipment manifest records required by the appropriate regulatory agencies for verifying the material and quantity of each load in unit of volume and weight. Copies of each manifest must be submitted to the Engineer within four (4) business days following shipment, and within three (3) business days after notification of receipt of the facility. The signed manifests must be maintained and kept with the project field records. Any manifest discrepancies must be

reported immediately to the Engineer and be resolved by the Contractor to the satisfaction of the Engineer.

4. Equipment and Vehicle Decontamination
 - a. The Contractor must design and construct a portable decontamination station to be used to decontaminate equipment and vehicles that have been used to handle contaminated soil. The cost for this work will be paid under Item 8.01 S - Health and Safety.
 - b. Water generated during the decontamination process must be disposed of in accordance with Item 8.01 W1 – Removal, Treatment and Discharge/Disposal of Contaminated Water.

8.01 C1.4 METHOD OF MEASUREMENT

- A. Quantities for contaminated soils will be measured in tons. The tonnage will be determined by off-site truck scales, as per Subsection 8.01 C1(3)(B)(1), that are capable of generating load tickets.
- B. Final disposal of hazardous soil will be paid for under Item 8.01 H – Handling, Transporting and Disposal of Hazardous Soil.
- C. Disposal of contaminated water will be paid for under Item 8.01 W1 – Removal, Treatment and Discharge/Disposal of Contaminated Water. Backfill will be paid for under its respective item as specified in the Contract Documents.
- D. The Environmental Consultant will be paid under Item 8.01 S – Health and Safety.

8.01 C1.5 PRICE TO COVER

The unit bid price per ton for Item 8.01 C1 must include the cost of furnishing all labor, materials, equipment plan, and insurance for excavation, handling, transportation, disposal, documentation, fees, permits, loading, stockpiling, hauling, and any other incidentals necessary to complete all the work as specified herein for handling, transporting, and disposal of non-hazardous contaminated soil.

Payment will be made under:

ITEM NUMBER	DESCRIPTION	PAY UNIT
8.01 C1	Handling, Transporting and Disposal of Non-Hazardous Contaminated Soil	Tons

**ITEM 8.01 C2 SAMPLING AND TESTING OF NON-HAZARDOUS
CONTAMINATED/POTENTIALLY HAZARDOUS SOIL FOR DISPOSAL
PURPOSES**

8.01 C2.1 WORK TO INCLUDE

A. Description

The work will consist of collecting and analyzing representative samples of soil to be excavated in-situ and/or ex-situ from stockpiles for parameters typically requested by the disposal facilities to determine if the soil to be excavated is suitable for reuse, or to be hauled off-site for disposal purposes as contaminated and/or hazardous soil.

B. Sampling and Laboratory Analysis

1. At least forty-five (45) days prior to the commencement of work, the Contractor's Environmental Consultant must submit an FSP and an Investigation Health and Safety Plan (Investigation HASP) to OEHS for review and approval, prior to conducting the field sampling. The FSP must include, at a minimum, the following information:
 - a. Project information;
 - b. Description of sample collection methodology for soil which appears to contain contaminants based on PID readings and field observation;
 - c. Type of analyses;
 - d. Sample preservation and handling;
 - e. Training and experience of the personnel who will collect the samples;
 - f. Equipment decontamination;
 - g. Analytical laboratory's name, address, New York State Department of Health's ELAP certification number, and telephone number;
 - h. Map of the project area;
 - i. Sample location plan; and,
 - j. Chain of Custody.

The Investigation HASP must identify actual and potential hazards associated with planned sampling field activities and stipulate appropriate health and safety procedures, so as to minimize field personnel exposures to physical, biological, and chemical hazards that may be present in the sampling media. The Investigation HASP must include, at a minimum, the following information:

- a. Project information;
- b. Description of work to be performed;
- c. Names of responsible health and safety personnel;
- d. Worker training;
- e. Job hazard analysis;
- f. Confined Space Entry Plan (if applicable);
- g. Personal monitoring (if applicable);
- h. Community Air Monitoring Plan (CAMP, if applicable);
- i. Personnel Protection Equipment (PPE);
- j. Decontamination;

- k. Safety rules;
 - l. Spill prevention and control, dust control, vapor/odor suppression procedures;
 - m. Identification of nearest hospital and route; and,
 - n. Emergency Incident Reporting.
2. The Contractor's Environmental Consultant must collect one (1) grab sample and one (1) composite sample per 500 cubic yards of soil to be excavated in-situ and/or ex-situ from stockpiles. Sample locations must be placed A) throughout or along areas within the project limits, and B) within any portion of the project area that exhibits any of the characteristics described in Section 8.01 C1.1 A (evidence of potential contamination via elevated PID readings, olfactory or visual evidence). For in-situ sampling, each grab soil sample must be collected from either the 6-inch interval above the water table (when encountered), or the 6-inch interval above the bottom of the proposed excavation depth (where recovery allowed), or from the 6-inch interval showing the highest potential for contamination based on field observation. For composite soil sampling, grid sampling must be performed for projects with excavation depth deeper than six (6) feet below grade. Each composite sample must consist of five (5) grab samples and discrete aliquots collected from various intervals along the depth of excavation at each sampling boring location. For stockpiled soils, each composite sample must consist of five (5) grab samples collected from various depths within each soil stockpile, at least two feet below the soil surface. For drummed soil, one (1) composite sample per 10 drums must be collected. Each composite soil sample must consist of one (1) grab sample from each of the 10 drums.
 3. Laboratory sampling should include analyses for VOCs, Polycyclic Aromatic Hydrocarbons (PAHs), PCBs, Toxicity Characteristic Leaching Procedure (TCLP) Metals (Resource Conservation and Recovery Act [RCRA] 8), the three RCRA Characteristics, ignitability, reactivity, and corrosivity, and Paint Filter Test. Additionally, should the disposal facility(ies) require specific analyses to accept material, the additional analyses should be included at no additional cost to the City.
 4. Should the Contractor seek to remove non-contaminated excess soils from the site, the Contractor will be required to coordinate the Beneficial Use Determination (BUD) with NYSDEC prior to moving the soils in accordance with the 6 New York Code, Rules, and Regulations (NYCRR) Parts 360.12 and 360.13. The Contractor must keep the Engineer informed of the approval status and removal schedule of any and all soils being removed from the site which are not going to an approved disposal facility.
 5. The quality of the data from the sampling program is the Contractor's responsibility. The Contractor must furnish all qualified personnel, materials, equipment and instruments necessary to carry out the sampling. Unless directed otherwise, all sampling procedures must follow the NYSDEC sampling guidelines and protocols. All sampling must be conducted by a qualified person trained in sampling protocols using standard accepted practices for obtaining representative samples.
 6. Each grab and composite sample must be analyzed for all parameters required by disposal facilities accepting contaminated and hazardous soil, in addition to any specific criteria a sample is being analyzed for.
 7. All sample containers must be marked and identified with legible sample labels, which must indicate the project name, sample location and/or container, the sample number, the date and time of sampling, preservatives utilized and other information that may be useful in determining the character of the sample. Chain-of-custody must be tracked from laboratory issuance of sample containers through laboratory receipt of the samples.
 8. The Contractor must maintain a bound sample logbook. The Contractor must provide the Engineer access to it at all times and must turn it over to the Engineer in good condition

at the completion of the work. The following information, at a minimum, must be recorded to the log:

- a. Sample identification number;
 - b. Sample location;
 - c. Field observation;
 - d. Sample type;
 - e. Analyses;
 - f. Date/time of collection;
 - g. Collector's name;
 - h. Sample procedures and equipment utilized; and,
 - i. Date sent to laboratory and name of laboratory.
9. The City reserves the right to direct the Contractor to conduct alternative sampling in lieu of the parameters described in subsection 8.01 C2(1)(B)(4) if the situation warrants. The substitute sampling parameters will be of equal or lesser monetary value than those described in subsection 8.01 C2(1)(B)(4), as determined by industry laboratory pricing standards.
 10. Only dedicated sampling equipment may be used to collect these samples. All equipment involved in field sampling must be decontaminated before being brought to the sampling location and must be properly disposed after use.
 11. The Contractor's Environmental Consultant must prepare a Field Sampling Result Report (FSSR), tabulate the analytical results, and compare the data to the applicable NYSDEC Part 375.6 SCOs and TCLP for Hazardous Waste published in RCRA and 6 NYCRR Part 371, or 40 CFR Section 261. If the soil is to be disposed of in a disposal facility outside of the State of New York, the soil sampling data must also be compared to the applicable regulatory criteria established by the state in which the disposal facility is located. The FSSR, with the tabulated tables and laboratory analytical data, must be submitted to OEHS for review and approval prior to any soil reuse or disposal activities.
 12. Soils exceeding any of the hazardous characteristic criteria meet the legal definition of hazardous soils (rather than non-hazardous contaminated soils) and must be transported or disposed of under Item 8.01 H – Handling, Transporting and Disposal of Hazardous Soil. All analyses must be done by a laboratory that has received approval from the ELAP for the methods to be used. The Contractor must specify the laboratory in the MHP.
 13. The Contractor must contact the disposal facility where the waste will be sent for permanent disposal, and arrange to collect any additional samples required by the facility. The cost associated with additional sampling and testing must be included in the bid price of this Item.

8.01 C2.2 METHOD OF MEASUREMENT

Quantities for samples must be measured as the number of sets of samples that are tested. A set will be defined as one (1) grab and one (1) composite samples per 500 cubic yards to be analyzed for the full range of parameters as specified in subsection 8.01 C2(1)(B)(3).

8.01 C2.3 PRICE TO COVER

The unit price bid per set for Item 8.01 C2 will include the cost of furnishing all labor, materials, equipment, plan, and insurance necessary for sampling, handling, transporting, testing, documentation, fees, permits, and any other incidentals necessary to complete the work as specified herein for in-situ and ex-situ soil sampling and analysis for waste disposal parameters.

Payment will be made under:

Item No.	Description	Pay Unit
8.01 C2	SAMPLING AND TESTING OF CONTAMINATED/POTENTIALLY HAZARDOUS SOIL FOR DISPOSAL PURPOSES	SETS

ITEM 8.01 H HANDLING, TRANSPORTING AND DISPOSAL OF HAZARDOUS SOIL**8.01 H.1 WORK TO INCLUDE****A. General**

This work will consist of the handling, transportation, and disposal of hazardous soils, which are defined as soils showing exceedances of TCLP for Hazardous Waste published in RCRA, 6 NYCRR Part 371, or 40 CFR Section 261. Hazardous soil can also be contaminated soils, as defined in Item 8.01 C1, but must be handled, transported, and disposed of as hazardous soil under Item 8.01 H, in accordance with the specifications herein. For the purpose of this specification, soil will be defined as any materials excavated below the pavement and base for pavement. Soil will also be defined as any material excavated from wetlands and/or wetlands adjacent areas, or any areas that are not covered with hard pavement (e.g., concrete, asphalt), such as grass or dirt areas.

The Contractor must ensure that all operations associated with the handling, sampling, loading, transportation, and disposal of hazardous materials are in compliance with the applicable Federal, State, and Local statutes and regulations, including Local Law 72 which becomes effective upon discovery of a TCLP lead exceedance. A sampling report, along with the executive summary, must be transmitted to OEHS within 48 hours of discovery to post on DDC website, as required by Local Law 72.

The Contractor must supply all equipment, material and labor required to conduct the specified work under this section. The Contractor must document the excavation, handling, sampling, and testing, transportation, and disposal of hazardous soils. The City must be listed in the disposal documents as the waste generator.

The Contractor must decontaminate all equipment prior to its removal from the exclusion zone and/or following contact with hazardous materials, as detailed in Item 8.01 S - Health and Safety. Water generated during the decontamination process must be disposed of under Item 8.01 W1 – Removal, Treatment and Discharge/Disposal of Contaminated Water.

The Contractor must retain an Environmental Consultant, meeting the requirements specified in Section 8.01 C1, and the Contractor is not permitted to self-perform this work. The Environmental Consultant must conduct sampling for laboratory analysis of soil to be excavated to determine whether the soil is contaminated and/or hazardous.

Hazardous soils are defined as soils showing exceedances of Toxicity Characteristic Leaching Procedure (TCLP) Regulatory Levels for Hazardous Waste published in Resource Conservation and Recovery Act (RCRA), 6 New York Codes, Rules, and Regulations (NYCRR) Part 371, or 40 Code of Federal Regulations (CFR) Section 261. Hazardous soils must be handled, transported, and disposed of in accordance with the specifications of this section.

All work under Item 8.01 H must be performed under the direct supervision of the Contractor's Environmental Consultant, as approved by the OEHS.

B. Material Handling Plan:

At least 45 days prior to the commencement of work, the Contractor must submit to the OEHS for review an MHP. The MHP must be approved by the OEHS prior to the Contractor beginning any soil excavation work. The MHP must, at a minimum, consist of:

1. The Contractor's procedures for identifying hazardous soils during excavation, including the specific model and manufacturer of intended organic vapor monitoring equipment and calibration procedures to be used. It should also include the training and experience of the personnel who will operate the equipment.
2. The Contractor's procedures for safely handling hazardous soils or soils which have not yet been tested but are believed to be potentially hazardous. The procedures must include personnel safety and health, as well as environmental protection considerations.

3. Name, address, NYSDOH ELAP status and telephone number of the proposed laboratory for analysis of representative soil samples.
4. Identification of the Contractor's proposed waste transporter(s). This information must include:
 1. Name and Waste Transporter Permit Number;
 2. Address;
 3. Name of responsible contact for the waste transporter;
 4. Telephone number for the contact;
 5. All necessary permit authorizations for each type of waste transported; and,
 6. Previous experience in performing the type of work specified herein.
5. The name and location of the facility where an off-site scale is located. The Contractor must outline the procedures on controlling trucks leaving the work site and enroute to the off-site scale.
6. All staging/stockpiling areas (if stockpiling areas are intended and available), or alternate procedures that will be used. Alternate procedures may include, but are not limited to, agreements from the intended disposal facilities to accept boring data and/or analytical data previously obtained during the site characterization so that materials may be directly loaded into vehicles for shipment to the disposal facility.
7. A backup facility must be provided, should the staging/stockpile areas become unavailable, insufficient in area or not be present by some other unforeseen difficulty.
8. Identification of the Contractor's two proposed Treatment Storage or Disposal (TSD) facilities for hazardous soils (primary and back-up) for final disposal of the hazardous soils. Both primary and backup TSD facilities must be currently USEPA or State-approved RCRA TSD facilities for hazardous soils. The information required for each facility must include:
 - a. General Information
 - i. Facility name and the USEPA identification number;
 - ii. Facility location;
 - iii. Name of responsible contact for the facility;
 - iv. Telephone number for contact;
 - v. Signed letter of agreement to accept waste as specified in this Specification. The letter must indicate agreement to handle and accept the specified estimated quantities and types of material during the time period specified in the project schedule and any time extension as deemed necessary; and,
 - vi. Unit of measure utilized at disposal facility for costing purposes.
 - b. A listing of all permits, licenses, letters of approval, and other authorizations to operate, which are currently held and valid for the proposed facility.
 - c. A listing of all permits, licenses, letters of approval, and other authorizations to operate which have been applied for by the proposed facility but not yet granted or issued.
 - d. The Contractor must specify and describe the disposal/containment unit(s) that the proposed facility will use to manage the waste. The Contractor must identify the capacity available in the units and the capacity reserved for the subject waste.
 - e. The Contractor must provide the date of the proposed facility's last compliance inspection under RCRA.

- f. A list of all active (unresolved) compliance orders (or agreements), enforcement notices, or notices of violations issued to the proposed facility must be provided. The source and nature of the cause of violation must be stated, if known.
- 9. Description of all sampling and field/laboratory analyses that will be needed to obtain disposal facility approval.

8.01 H.2 MATERIALS

- A. The Contractor must provide containers as specified in the USDOT regulations.
- B. The Contractor must provide polyethylene sheeting, which is to be placed under (20 mil. thickness minimum) and over (10 mil. thickness minimum) soil piles.
- C. The Contractor must assure that the waste transporter's appropriate choice of vehicles and operating practices are fitted to prevent spillage or leakage of contaminated material during transportation.
- D. The Contractor must provide, install, and maintain any temporary stockpiling or loading facilities on site as required until completion of material handling activities. The location and design of any such facilities must be included in the MHP.

8.01 H.3 CONSTRUCTION DETAILS

A. Material Handling

- 1. Immediately after excavation of hazardous soil, the Contractor must:
 - a. Load material directly onto drums/trucks/tankers/roll offs for disposal off site. Containers must be labeled as hazardous soil while being held for disposal; or
 - b. If interim stockpiling is required, place hazardous soil on a minimum of 20 mil. polyethylene sheeting and cover it securely with polyethylene sheeting a minimum of 10 mil. to protect against cross contamination, airborne dust, leaching or runoff of contaminants into the subsurface, groundwater, or stormwater. Weight or secure the sheeting by appropriate means and seal seams as approved by the Engineer to prevent tearing or removal by wind or weather. Grade surrounding surface to provide for positive drainage away from pile. Each stockpile must not exceed 500 cubic yards. Hazardous soils must be stockpiled separately from uncontaminated and contaminated soil at an off-site location approved by the Engineer or secured on-site by the Contractor, meeting all required Federal, State and Local stipulations. Stockpiles must be labelled as hazardous soil and situated at least 800 feet away from any sensitive receptors, such as schools, daycare center, hospitals, nursing homes, etc., and at least 100 feet away from any water body.
- 2. Institute appropriate procedures and security measures to ensure the protection of site personnel and the protection of the public from hazardous soils as described in the approved MHP, EHASP, and Item 8.01 S – Environmental Health and Safety.
- 3. Any soil encountered that appears to contain unknown contaminants (based on visual, odor, or other observation), or that vary substantially from the material originally identified must be segregated in stockpiles and the Environmental Consultant promptly notified to collect soil samples for analysis. Construct stockpiles to the same requirements as stated in subsection (A)(1)(b) above.
- 4. Provide any dewatering that is necessary to complete the work. Contaminated water must be disposed of in accordance with Item 8.01 W1 – Removal, Treatment and Discharge/Disposal of Contaminated Water.
- 5. Provide and operate field organic vapor test equipment, a PID or an FID, to detect general organic vapor levels at intervals of approximately 50 cubic yards of soil excavated, when visual or odor observations indicate the material may substantially differ from the soil previously excavated and/or as directed by the Environmental Consultant.

C. Off-Site Transportation to Disposal Facility

1. General

- a. The Contractor must furnish all labor, equipment, supplies and incidental costs required to transport hazardous material from the work area to the off-site disposal facility, and any other items and services required for transporting hazardous material for disposal at an off-site facility.
- b. The Contractor is responsible for obtaining the USEPA hazardous waste generator identification number for the City. The application must be submitted to OEHS for review and approval prior to submission to USEPA. The Contractor must prepare the annual hazardous waste report for the project and submit to the NYSDEC and USEPA.
- c. The Contractor will be responsible for tracking all material/vehicles from the site to the off-site scale and to the approved disposal facility.
- d. The Contractor must provide to the Engineer certified tare and gross weight slips for each load received at the accepted facility which must be attached to each returned manifest. These documents must be maintained and kept with project field records.
- e. Hazardous soils must be delivered to the disposal or treatment facility within 30 calendar days after excavation.
- f. The Contractor must coordinate the schedule for truck arrival and material deliveries at the job site to meet the approved project schedule.
- g. The Contractor must inspect all vehicles leaving the project site to ensure that hazardous soils adhering to the wheels or undercarriage are removed prior to the vehicle leaving the site.
- h. The Contractor must obtain letters of commitment from the waste haulers and the TSD facility to haul and accept shipments.
- i. The Contractor must provide waste profile forms to OEHS for review and approval before transporting hazardous soil to the approved TSD facility.

2. Hauling

- a. The Contractor must coordinate manifesting, placarding of shipments, and vehicle decontamination. All quantities must be measured and recorded upon arrival at the disposal facility. If any deviation between the two records occurs, the matter is to be reported immediately to the Engineer and be resolved by the Contractor to the satisfaction of the Engineer.
- b. The Contractor will be responsible, at its own cost, for any and all actions necessary to remedy situations involving material spilled in transit or mud and dust tracked off-site.
- c. The Contractor must ensure that trucks are protected against contamination by properly covering and lining them with polyethylene sheeting or by decontaminating them prior to and between acceptance of loads. Trucks with loaded hazardous soil must be covered securely with tarp before leaving the project site to prevent generation of airborne dust during hauling.
- d. The Contractor will be responsible for inspecting the access routes for road conditions, overhead clearance, and weight restrictions.
- e. The Contractor must only use the transporter(s) identified in the approved MHP for the performance of work. Only a transporter with a current Part 364 Waste Transporter Permit from NYSDEC may transport hazardous soil. A revised MHP or an addendum to

the original approved MHP must be submitted to OEHS for review and approval at no additional cost to the City for any use of substitute or additional transporters.

- f. The Contractor must develop, document, and implement a policy for accident prevention.
 - g. The Contractor must not combine hazardous materials from other projects with material from this project.
 - h. No material will be transported until approval by the Engineer is obtained.
3. Off-Site Disposal
- a. The Contractor must use only the disposal facility(ies) identified in the approved MPH for the performance of the work. A revised MHP or an addendum to the original approved MHP must be submitted to OEHS for review and approval at no additional cost to the City for any use of substitutions or additions of disposal facility.
 - b. The Contractor will be responsible for acceptance of the materials at an approved facility, for ensuring that the facility is properly permitted to accept the stated materials, and for ensuring that the facility provides the stated treatment and/or disposal services.
 - c. The City reserves the right to contact and visit the TSD facility and regulatory agencies to verify the agreement to accept the stated materials and to verify any other information provided.
 - d. In the event that the identified and approved facility ceases to accept the stated materials or the facility ceases operations, it is the Contractor's responsibility to locate an alternate approved and permitted facility(ies) for accepting materials. The alternate facility(ies) must be approved in writing by the Engineer in the same manner and with the same requirements as for the original facility(ies). This must be done at no extra cost or delay to the City.
 - e. The Contractor must obtain manifest forms, and complete the shipment manifest records required by the appropriate regulatory agencies for verifying the material and quantity of each load in unit of volume and weight. Copies of each manifest must be submitted to the Engineer within four (4) business days following shipment, and within three (3) business days after notification of receipt of the facility. The signed manifests must be maintained and kept with the project field records. Any manifest discrepancies must be reported immediately to the Engineer and be resolved by the Contractor to the satisfaction of the Engineer.
 - f. The Contractor must submit all results and weights to the Engineer.
 - g. The Contractor is responsible to pay all fees associated with the generation and disposal of all excavated hazardous waste. These fees include, but are not limited to, the New York State Department of Finance and Taxation (DFT) quarterly fees for hazardous waste and the NYSDEC annual hazardous waste regulatory fee program. The Contractor must submit a copy of proof of payment to the Engineer and OEHS.
4. Equipment and Vehicle Decontamination
- a. The Contractor must design and construct a portable decontamination station to be used to decontaminate equipment and vehicles that have been used to handle hazardous soil. The cost for this work will be paid under Item 8.01 S - Health and Safety.
 - b. Water generated during the decontamination process must be disposed of in accordance with Item 8.01 W1 – Removal, Treatment, and Discharge/Disposal of Contaminated Water.

8.01 H.4 METHOD OF MEASUREMENT

- A. Quantities for hazardous soils will be measured in tons. The tonnage will be determined by off-site truck scales, as per Subsection 8.01 H3(C)(1)(C), that are capable of generating load tickets.
- B. Final disposal of non-contaminated soil will be paid for under Item 8.01 C1 – Handling, Transporting and Disposal of Non-Hazardous Contaminated Soil.
- C. Disposal of decontamination water will be paid for under Item 8.01 W1 – Removal, Treatment and Discharge/Disposal of Contaminated Water.
- D. Backfill will be paid for under its respective item as specified in the contract document.
- E. The Environmental Consultant will be paid under Item 8.01 S – Health and Safety.

8.01 H.5 PRICE TO COVER

The unit bid price bid per ton for Item 8.01 H will include the cost of furnishing all labor, materials, equipment, plan, and insurance for excavation, handling, transportation, disposal, documentation, fees, permits, loading, stockpiling, hauling, and any other incidentals necessary to complete all the work as specified herein for handling, transporting, and disposal of hazardous soil.

Payment will be made under:

Item No.	Description	Pay Unit
8.01 H	HANDLING, TRANSPORTING, AND DISPOSAL OF HAZARDOUS SOIL	TONS

ITEM 8.01 S HEALTH And SAFETY**8.01 S.1 WORK TO INCLUDE**Health and Safety Requirements**A. Scope of Work**

It is the Contractor's responsibility to stage and conduct the Contractor's work in a safe manner. The Contractor must implement an EHASP for non-hazardous contaminated or hazardous soil intrusive activities as set forth in OSHA Standards 1910.120 and 1926.650-652. The Contractor must ensure that all workers have at a minimum hazard awareness training. The Contractor must segregate contaminated work area in secured exclusion zones. These zones must limit access to Contractor personnel specifically trained to enter the work area. The exclusion zone must be set up to secure the area from the public and untrained personnel. The project health and safety program will apply to all construction personnel including persons entering the work area. In addition, the Contractor must protect the public from on-site hazards, including subsurface contaminants associated with on-site activities. The EHASP must be signed off by a Certified Industrial Hygienist and reviewed and approved by OEHS.

Work must include, but not be limited to:

1. Implementation of a baseline medical program.
2. Providing safety equipment and protective clothing for site personnel, including maintenance of equipment on a daily basis; replacement of disposable equipment as required; decontamination of clothing, equipment and personnel; and providing all other health and safety measures.
3. Providing, installing, operating and maintaining on-site emergency medical first aid equipment as specified in this section for which payment is not provided under other pay items in this Contract.
4. Providing, installing, operating, maintaining and decommissioning all equipment and personnel decontamination facilities specified within this section, including, but not limited to, the decontamination pad, decontamination water supply, decontamination water collection equipment and all other items and services required for the implementation of the health and safety requirements for which pay items are not provided elsewhere in this Contract.
5. Provide the minimum health and safety requirements for excavation activities within the limits of this Contract.
6. Implement and enforce an EHASP: The EHASP as presented in these specifications is dynamic with provisions for change to reflect new information, new practices or procedures, changing site environmental conditions or other situations which may affect site workers and the public. The EHASP will also address measures for community protection, accident prevention, personnel protection, emergency response/contingency planning, air monitoring, odor control and hazardous chemicals expected on site. Providing a Confined Space Entry Program as defined in the Occupational Safety and Health Act, Confined Space Entry Standard, 29 CFR 1910.146.

B. Environmental Consulting Services

The Contractor must retain an Environmental Consultant to obtain all permits and perform all field screening, air monitoring, community air monitoring, soil and water sampling, and health and safety services.

1. If conditions within the exclusion zone are deemed hazardous, then the Contractor and its Environmental Consultant must ensure that all personnel working within identified exclusion zones and/or involved (direct contact) with the handling, storage or transport of

hazardous and contaminated materials must have completed a minimum of forty (40) hours of Health and Safety Training on Hazardous Waste Sites in accordance with 29 CFR 1910.120(e). The training program must be conducted by a qualified safety instructor. If conditions in the exclusion zone are deemed to be non-hazardous, the Environmental Consultant must provide site specific training.

2. The Contractor must ensure that on-site management and supervisors directly responsible for or who supervise employees engaged in hazardous waste operations must receive the training specified in above and at least eight (8) additional hours of specialized training on managing such operations at the time of job assignment.

C. Submittals

1. The Contractor must submit a written EHASP, as specified herein, to OEHS for review and approval. The written EHASP must be submitted, within thirty (30) calendar days after the availability of analytical results of the soil and groundwater testing, as required under Section 8.01 C2 and Section 8.01 W2. The Contractor must make all necessary revisions required by OEHS and resubmit the EHASP to OEHS for acceptance. Start-up work for the project will not be permitted until written acceptance has been issued by OEHS.
2. Daily safety logs must be maintained by the Contractor and must be submitted to the Engineer either on request or on completion of the work. Training logs must be maintained by the Contractor and submitted to the Engineer either on request or on completion of the work. Daily logs on air monitoring during excavation activities must be prepared and maintained by the Contractor and submitted to the Engineer either on request or upon completion of the work.
3. A closeout report must be submitted by the Contractor to the Engineer upon completion of the work within the defined exclusion zones. This report must summarize the daily safety and monitoring logs and provides an overview of the Contractor's performance regarding environmental and safety issues. The report must carefully document all areas where contamination has been found including pictures, addresses of locations, and potential sources.
4. Medical Surveillance Examinations: The Contractor must submit to the Engineer the name, office address and telephone number of the medical consultant utilized. Evidence of baseline medical examinations together with the evidence of the ability to wear National Institute for Occupational Safety and Health (NIOSH) approved respirators (as specified in American National Standards Institute (ANSI) Z88.6) must be provided to the Engineer for all construction personnel who are to enter the exclusion zones.
5. Accident Reports: All accidents, spills, or other health and safety incidents must be reported to the Engineer.

D. Health and Safety Plan

The EHASP must comply with OSHA regulations 29 CFR 1910.120/1926.65. This document must at a minimum contain the following:

1. Description of work to be performed
2. Site description
3. Key personnel
4. Worker training procedures
5. Work practices and segregation of work area
6. Hazardous substance evaluation
7. Hazard assessment
8. Personal and community air monitoring procedures and action levels

9. Personal protective equipment
10. Decontamination procedures
11. Safety rules
12. Emergency procedures
13. Spill prevention and control, as well as spill reporting procedures
14. Dust control, vapor/odor suppression procedures
15. Identification of the nearest hospital and route
16. Confined space procedures
17. Excavation safety procedures

8.01 S.2 MEASUREMENT

Health and Safety Requirements

- A. 25% of the lump sum price will be paid when the following items are implemented or mobilized:
 - Medical surveillance program
 - Health and safety training
 - Health and safety plan
 - Environmental and personnel monitoring
 - Instrumentation
 - Spill control
 - Dust control
 - Personnel and equipment decontamination facilities
 - Personnel protective clothing
 - Communications
 - Mobilization
- B. 50% will be paid in proportional monthly amounts over the period of work.
- C. 25% will be paid when the operation is demobilized and removed from the project site.

8.01 S.3 PRICE TO COVER

Health and Safety Requirements

The lump sum price bid for the health and safety requirements will include all labor, materials, equipment, and insurance necessary to complete the work in accordance with these specifications. The price bid will include, but not be limited to, the following:

- A. Providing training, safety personnel, air monitoring and medical examinations as specified.
- B. Providing safety equipment and protective clothing for site personnel, including maintenance of equipment on a daily basis; replacement of disposable equipment as required; decontamination of clothing, equipment and personnel; and all other health and safety activities or costs not paid for under other pay items in this Contract.
- C. Providing, installing, operating and maintaining on-site emergency medical and first aid equipment. This includes all furnishings, equipment, supplies and maintenance of all medical

equipment, and all other health and safety items and services for which payment is not provided under other pay items in this Contract.

- D. Providing, installing, operating, maintaining, and decommissioning all personnel and equipment decontamination facilities, including decontamination pad, decontamination water supply, and all other items and services required for the implementation of the health and safety requirements for which pay items are not provided elsewhere in this Contract. Vehicle decontamination pads will be included in the price of this item. Disposal of decontamination fluid will be paid for under Item 8.01 W1 – Removal, Treatment, and Discharge/Disposal of Contaminated Water.
- E. Spill Control
1. Payment will account for furnishing, installing, and maintaining all spill control equipment and facilities. Payment will include equipment and personnel to perform emergency measures required to contain any spillage and to remove spilled materials and soils or liquids that become contaminated due to spillage during work within the exclusion zones and handling of excavated soils and liquids from these areas. This collected spill material will be properly disposed of.
 2. Payment under this item will not include testing, handling, transportation or disposal of petroleum-contaminated/potentially hazardous soils excavated during construction. The price for this work will be paid for under Items 8.01 C1 – Handling, Transporting and Disposal of Non-Hazardous Contaminated Soil, 8.01 C2 – Sampling and Testing of Contaminated/Potentially Hazardous Soil for Disposal Purposes or 8.01 H – Handling, Transporting and Disposal of Hazardous Soil, as appropriate.
- F. Dust Control
- Payment will account for furnishing, installing, and maintaining dust control equipment and facilities to be used whenever applicable dust levels are exceeded. Payment will include all necessary labor, equipment, clean water, foam, and all other materials required by the Dust Control Plan. The NYSDOH Community Air Monitoring Plan (CAMP) may be used as guidance.
- G. Vapor/Odor Suppression
- Payment will account for furnishing, installing and maintaining vapor/odor control equipment and facilities to be used whenever organic vapor monitoring or the presence of odors indicates that vapor suppression is required to protect workers or the public. Payment will include all necessary labor, equipment, clean water, foam and all other materials required by the Vapor/Odor Suppression Plan.
- H. Mobilization/Demobilization
1. Mobilization

Payment will include the following, but not be limited to:

 - a. All work required to furnish, install and maintain all signs, fencing, support zone facilities, parking areas and all temporary utilities;
 - b. All work required to furnish, install, and maintain an office space with phone and utilities for health and safety personnel;
 - c. All work required for complete preparation of lay down area for roll-off containers, including sampling, and any required fencing;
 - d. All direct invoiced cost from bonding companies and government agencies for permits and costs of insurance; and
 - e. All other items and services required for mobilization and site preparation.

2. Demobilization

Payment will include but not be limited to: All work required to sample the area; remove from the site all equipment, temporary utilities and supporting facilities; performance of necessary decontamination and repairs; disposal of disposable equipment and protective gear and other items and services required for complete demobilization.

Payment will be made under:

Item No.	Description	Pay Unit
8.01 S	HEALTH AND SAFETY	LUMP SUM

ITEM 8.01 W1 REMOVAL, TREATMENT, AND DISCHARGE/DISPOSAL OF CONTAMINATED WATER

8.01 W1.1 WORK TO INCLUDE

General: This work must consist of the proper removal and disposal of all contaminated groundwater and decontamination water generated during construction operations. The Contractor must be solely responsible for the proper disposal or discharge of all contaminated water generated at the job site. The Contractor will have the option of treating water on-site for discharge to the sewer system or removing contaminated water for off-site disposal. The Contractor must be responsible to choose a method compatible to the construction work and will be compensated on a per day basis regardless of method employed. The Contractor will be compensated for only those days where the system is in full operation.

The Contractor must retain a dewatering/water treatment Specialist (hereinafter the "Specialist") and laboratory as specified under Item 8.01 W2 – Sampling and Testing of Contaminated Water, to conduct any testing that may be required for disposal of impacted water.

The dewatering/water treatment Specialist is responsible to obtain all permits; perform all water sampling, testing; and provide ancillary services related to dewatering and water treatment. The Specialist must at a minimum provide documentation to OEHS demonstrating the minimum requirements as set forth below:

1. The Specialist must demonstrate that it has, at a minimum, three (3) years' experience in the design of dewatering plans. The Specialist should demonstrate expertise dealing with issues associated with contaminated water. During that three (3) year period, the Specialist must demonstrate that it provided dewatering and water treatment systems as a routine part of its daily operations.
2. The Specialist must be experienced in work of this nature, size, and complexity and must have previous experience in working with the NYSDEC.
3. The Specialist must furnish a list of at least five (5) projects completed within the last (3) years, identifying the location, nature of services provided, owner, owner's contact, contact's telephone number, project duration and value of the projects.
4. If conditions within the exclusion zone are deemed hazardous, then the Contractor and its Environmental Consultant must ensure that all personnel working within identified exclusion zones and/or involved (direct contact) with the handling, storage or transport of hazardous and contaminated material must have completed a minimum of forty (40) hours of Health and Safety Training on Hazardous Waste Sites in accordance with 29 CFR 1910.120(e). The training program must be conducted by a qualified safety instructor. If conditions in the exclusion zone are deemed to be non-hazardous, the Specialist will be responsible to provide site-specific training to its employees and other affected personnel.
5. The Contractor must ensure that on-site management and supervisors directly responsible for or who supervise employees engaged in hazardous waste operations must receive the training specified in above and at least eight (8) additional hours of specialized training on managing such operations at the time of job assignment.

The Contractor must document all operations associated with the handling, sampling and disposal of contaminated water, and ensure that they are in compliance with applicable Federal, State and Local statutes and regulations.

The Contractor must supply all labor, equipment, transport, plant, material, treatment, and other incidentals required to conduct the specified work of this section.

If water will be disposed of into the sewer system, the Contractor must ensure the Specialist treats the water to comply with the New York City Department of Environmental Protection (NYCDEP) Sewer Effluent Limit concentrations prior to discharge. The Contractor is responsible for providing settling or filtering tanks and any other apparatus required by NYCDEP. Alternatively, the Contractor can provide a plan for transport and disposal at an off-site waste disposal facility.

Within forty-five (45) calendar days after award of Contract, the Contractor must submit to OEHS for review and approval, a Water Handling Plan (WHP). The WHP must be approved by OEHS prior to the Contractor's commencement of work. The minimum requirements for the WHP are specified herein Item 8.01W 1.2, for each type of disposal (disposal into the sewer or off-site disposal). The Contractor must maintain a complete, up to date copy of the WHP on the job site at all times.

8.01 W1.2 CONSTRUCTION DETAILS

For each disposal method the Contractor proposes to utilize (disposal to sewer or off-site disposal), the WHP must include the information required in paragraphs A and B below, as appropriate.

A. On-site treatment and discharge into New York City sewers.

1. Regulations: The Contractor must comply with all applicable regulations. This includes but may not be limited to:
 - Title 15-New NYCDEP Sewer Use Regulations.
2. Permits: The Contractor is solely responsible to obtain all necessary and appropriate Federal, State and Local permits and approvals. The Contractor will be responsible for performing all and any system pilot tests required for permit approval. This includes but may not be limited to:
 - a. Industrial waste approval for the New York City sewer system.
 - b. Groundwater discharge permit for the New York City sewer system (NYCDEP Division of Sewer Regulation and Control), if discharge to sewer exceeds 10,000 gallons per day.
 - c. The Contractor must comply with NYSDEC State Pollutant Discharge Elimination System (SPDES) General Permit for Stormwater Runoff from Construction Activity (SPDES General Permit) GP-0-20-001 or its successor.
 - d. Long Island well permit for Brooklyn and Queens sites, if well points are used for dewatering.
 - e. Wastewater quality control application, NYCDEP.
3. The WHP for this portion of the work must include the following at a minimum:
 - a. Identification and design of Contractor's proposed treatment to assure that the water meets the NYCDEP sewer use guidelines prior to discharge to the sewer, including identification of all materials, procedures, settling or filtering tanks, filters and other appurtenances proposed for treatment and disposal of contaminated water.
 - b. The name, address and telephone number of the contact for the Contractor's proposed chemical laboratory, as well as the laboratory's certifications under Federal, State or non-governmental bodies.
 - c. The name, address and telephone number of the contact for the Contractor's proposed Environmental Consultant.
 - d. Copies of all submitted permit applications and approved permits the Contractor have received.
4. Materials

The Contractor must supply all settling or filtering tanks, pumps, filters, treatment devices and other appurtenances for treatment, temporary storage and disposal of contaminated water. All equipment must be suitable for the work described herein.
5. Execution
 - a. The Contractor is solely responsible for disposal of all water, in accordance with all Federal, State and Local regulations.
 - b. The Contractor is solely responsible for any treatment required to assure that water discharged into the sewer is in compliance with all permits and Federal, State and Local statutes and regulations.
 - c. The Contractor is solely responsible for the quality of the water disposed of into the sewers.

- d. The Contractor is responsible for sampling and testing of water for the NYCDEP Sewer Effluent Limit concentrations. The quality of the data is the Contractor's responsibility. Any sampling and testing must be conducted and paid in accordance with Item 8.01 W2 – Sampling and Testing of Contaminated Water.
- e. The Contractor will be responsible to maintain the discharge rate to the sewer such that all permit requirements are met, the capacity of the sewer is not exceeded and no surcharging occurs downstream due to the Contractor's actions. Dewatering by means of well points or deep wells will not be allowed in the Boroughs of Brooklyn or Queens where the rate of pumping exceeds forty-five (45) gallons per minute unless the appropriate permit has been secured from the NYSDEC.
- f. Disposal of Treatment Media
 - (1) The Contractor will be responsible for disposal or recycling of treatment media in accordance with all Federal, State and Local regulations.
 - (2) The Contractor must provide the Engineer with all relevant documentation concerning the disposal of treatment media, including manifests, bills of lading, certificates of recycling or destruction and other applicable documentation.
 - (3) **Disposal of treatment media will not be considered a separate pay item; instead it will be considered as incidental work thereto and included in the unit price bid.**

B. Off-Site Disposal

- 1. Regulations: The Contractor must conform to all applicable Federal, State and Local regulations pertaining to the transportation, storage and disposal of any hazardous and/or non-hazardous materials as listed in Attachment 2.
- 2. The following must be submitted to the Engineer prior to initiating any off-site disposal:
 - a.
 - (1) Name and waste transporter permit number
 - (2) Address
 - (3) Name of responsible contact for the waste transporter
 - (4) Any and all necessary permit authorizations for each type of waste transported
 - (5) Previous experience in performing the type of work specified herein
 - b. General information for each proposed treatment/disposal facility and at least one backup treatment/disposal facility
 - (1) Facility name and USEPA identification number
 - (2) Facility location
 - (3) Name of responsible contact for the facility
 - (4) Telephone number for contact
 - (5) Unit of measure utilized at facility for costing purposes
 - c. A listing of all permits, licenses, letters of approval and other authorizations to operate, which are currently held and valid for the proposed facility as they pertain to receipt and management of the wastes derived from this Contract.
 - d. A listing of all permits, licenses, letters of approval and other authorizations to operate which have been applied for by the proposed facility but not yet granted or issued. Provide dates of application(s) submitted. Planned submittals must also be noted.
 - e. The Contractor must specify and describe the disposal/containment unit(s) that the proposed facility will use to manage the waste and provide dates of construction

and beginning of use, if applicable. Drawings may be provided. The Contractor must identify the capacity available in the units and the capacity reserved for the subject waste.

- f. The Contractor must provide the date of the proposed facility's last compliance inspection.
 - g. A list of all active (unresolved) compliance orders, agreements, enforcement notices or notices of violations issued to the proposed facility must be submitted. The source and nature of the cause of violation must be stated, if known. If groundwater contamination is noted, details of the facility's groundwater monitoring program must be provided.
 - h. Description of all sampling and field/laboratory analyses that will be needed to obtain disposal facility approval.
3. Materials
- All vessels for temporary storage and transport to an off-site disposal facility must be as required in DOT regulations.
4. Execution
- a. General
 - (1) The Contractor must organize and maintain the material shipment records/manifests required by Federal, State and Local laws. The Contractor must include all bills of lading, certificates of destruction, recycling or treatment and other applicable documents.
 - (2) The Contractor must coordinate the schedule for truck arrival and material deliveries at the job site to meet the approved project schedule. The schedule must be compatible with the availability of equipment and personnel for material handling at the job site.
 - (3) The Contractor must inspect all vehicles leaving the project site to ensure that contaminated liquids are not spilling and are contained for transport.
 - (4) The Contractor must obtain letters of commitment from the waste haulers and the treatment, disposal or recovery facility to haul and accept shipment. The letter must indicate agreement to handle and accept the specified estimated quantities and types of material during the time period specified in the project schedule and any time extension as deemed as necessary.
 - (5) The Contractor must verify the volume of each shipment of water from the site.
 - (6) The Contractor is responsible for sampling and testing of water for off-site disposal. The quality of the data is the Contractor's responsibility. Any sampling and testing must be conducted and paid in accordance with Item 8.01 W2 – Sampling and Testing of Contaminated Water.
 - (7) The Contractor is responsible for any additional analyses required by the TSD facility, and for the acceptance of the water at an approved TSD facility.
 - b. Hauling
 - (1) The Contractor must not deliver waste to any facility other than the TSD facility(ies) listed on the shipping manifest.
 - (2) The Contractor must coordinate manifesting, placarding of shipments, and vehicle decontamination. All quantities must also be measured and recorded upon arrival at the TSD facility(ies). If any deviation between the two records

occurs, the matter is to be reported immediately to the Engineer and must be resolved by the Contractor to the satisfaction of the Engineer.

- (3) The Contractor will be responsible for any and all actions necessary to remedy situations involving material spilled in transit or mud and dust tracked off-site. This cleanup must be accomplished at the Contractor's expense.
 - (4) The Contractor will be responsible for inspecting the access routes for road conditions, overhead clearance and weight restrictions.
 - (5) The Contractor must only use the transporter(s) identified in the WHP for the performance of work. Only a transporter with a current Part 364 Waste Transporter Permit from NYSDEC may transport this material. Any use of substitute or additional transporters must have previous written approval from the Engineer at no additional cost to the City.
 - (6) The Contractor must develop, document, and implement a policy for accident prevention.
 - (7) The Contractor must not combine waste materials from other projects with material from this project.
 - (8) The Contractor must obtain for the City a hazardous waste generator identification number and will sign the manifest as the generator, if necessary.
 - (9) No material must be transported until approved by the Engineer.
- c. Disposal Facilities
- (1) The Contractor must use only the TSD facility(ies) identified in the WHP for the performance of the work. Substitutions or additions must not be permitted without prior written approval from OEHS, and, if approved, must be at no extra cost to the City.
 - (2) The Contractor will be responsible for acceptance of the material at an approved TSD facility, for ensuring that the facility is properly permitted to accept the stated material, and that the facility provides the stated storage and/or disposal services.
 - (3) The City reserves the right to contact and visit the disposal facility and regulatory agencies to verify the agreement to accept the stated material and to verify any other information provided. This does not in any way relieve the Contractor of the Contractor's responsibilities under this Contract.
 - (4) In the event that the identified and approved facility ceases to accept the stated materials or the facility ceases operations, it is the Contractor's responsibility to locate an alternate approved and permitted facility(ies) for accepting materials. The Contractor is responsible for making the necessary arrangements to utilize the facility(ies), and the alternate facility(ies) must be approved in writing by the Engineer in the same manner and with the same requirements as for the original facility(ies). This must be done with no extra cost or delay to the City.
- d. Equipment and Vehicle Decontamination
- (1) The Contractor must design and construct a portable decontamination station to be used to decontaminate equipment and vehicles exiting the exclusion zone. The cost for this work will be paid under Item 8.01 S – Health and Safety.

8.01 W1.3 METHOD OF MEASUREMENT

The quantity for on-site treatment and discharge or off-site disposal will be on a per day basis.

8.01 W1.4 PRICE TO COVER

- A. The per day price bid for Item 8.01 W1 will include the cost of furnishing all labor, materials, equipment, plan, and insurance for handling, transportation, disposal, documentation, permits, hauling, mobilization and demobilization, and any other incidentals thereto to complete the work.
- B. The Contractor will not be paid for water that is within the NYCDEP Sewer Discharge Limits.

Payment will be made under:

Item No.	Description	Pay Unit
8.01 W1	REMOVAL, TREATMENT AND DISCHARGE/DISPOSAL OF CONTAMINATED WATER	DAY

ITEM 8.01 W2 Sampling And Testing Of Contaminated Water**8.01 W2.1 WORK TO INCLUDE****A. Description**

The work will consist of sampling and testing of potentially contaminated groundwater, surface runoff within the excavated area and all contaminated water generated during the decontamination process.

B. Sampling and Testing

1. The Contractor is responsible, at a minimum, for sampling and testing of contaminated water for the NYCDEP Sewer Effluent Limit concentrations as listed in Attachment 1, and in accordance with the Engineer-approved FSP and the Investigation HASP, as specified in 8.01 C2. The quality of the data is the Contractor's responsibility. Any additional testing required by the Federal, State and/or disposal facilities must be included in the bid price of this Item.
2. All sampling and testing must be conducted by a person trained in sampling protocols using accepted standard practices and/or the NYSDEC sampling guidelines and protocols.
3. All sample containers must be marked with legible sample labels which must indicate the project name, sample location and/or container, the sample number, the date and time of sampling, preservatives utilized, how the sample was chilled to 4 degrees Celsius, and other information that may be useful in determining the character of the sample.
4. Chain-of-custody must be tracked from laboratory issuance of sample containers through receipt of the samples.
5. The Contractor must maintain a bound sample log book. The Contractor must provide the Engineer access to it at all times and must turn it over to the Engineer in good condition at the completion of the work. The following information, as a minimum, must be recorded to the log:
 - a. Sample identification number
 - b. Sample location
 - c. Field observation
 - d. Sample type
 - e. Analyses
 - f. Date/time of collection
 - g. Collector's name
 - h. Sample procedures and equipment used
 - i. Date sent to laboratory/name of laboratory
6. Only dedicated sampling equipment may be used to collect these samples. All equipment involved in field sampling must be decontaminated before being brought to the site, and must be properly disposed of after use.
7. Samples must be submitted to the Contractor's laboratory within the holding times for the parameters analyzed.
8. All analyses must be done by a laboratory that has received approval from the NYSDOH's ELAP for the methods to be done. The Contractor must specify the laboratory in the WHP.
9. Analytical results for water discharged to the sewer and for off-site disposal must be submitted to the Engineer no later than five (5) days after sample collection.
10. The City reserves the right to direct the Contractor to conduct alternative sampling in lieu of the parameters described above, if the situation warrants. The substitute sampling parameters will be of equal or lesser monetary value than those described above, as determined by industry laboratory pricing standards.

8.01 W2.2 METHOD OF MEASUREMENT

Quantities for samples will be measured as the number of sets of samples that are tested for the NYCDEP Sewer Effluent Limit concentrations. A set will be defined as one (1) representative sample analyzed for the full range of NYCDEP parameters as specified in Attachment 1.

8.01 W2.3 PRICE TO COVER

The unit price bid per set for Item 8.01 W2 will include the cost of furnishing all labor, materials, equipment, plan, and insurance for handling, transport, sampling, testing, documentation, permits, other incidentals necessary to complete the work of sampling and testing of contaminated water. Any additional costs incurred by the Contractor for sampling and testing of contaminated water will be included in the bid price of this Item.

Payment will be made under:

Item No.	Description	Pay Unit
8.01 W2	SAMPLING AND TESTING OF CONTAMINATED WATER	SETS

**SECTION 9.29- ALLOWANCE FOR RAILROAD FACILITIES INCLUDING INSURANCE
AND FORCE ACCOUNT (ALL TYPES)****9.29.1. DESCRIPTION.**

Under this item the Contractor must negotiate with the railroad to obtain a permit to enter railroad property, determine the scope and cost of flaggers/spotters and all associated railroad work, and submit a deposit to the railroad to cover the railroad's miscellaneous costs associated with this contract and all required insurances.

9.29.2. MATERIALS.

(Not applicable)

9.29.3. CONSTRUCTION DETAILS.

Prior to the Contractor providing any services under this Section, the Engineer will provide written direction to the Contractor. The written direction will include:

- The name and contact information of the railroad;
- Additional Insurance requirements;
- Special railroad requirements and provisions;
- Scope and area of work where railroad coordination is required.

When directed by the Engineer, the Contractor must negotiate with the railroad to obtain a permit to enter railroad property, comply with all relevant railroad requirements, and provide a payment fund to the railroad for all miscellaneous expenses incurred by the railroad due to the contractor entering the railroad property. These expenses include the costs incurred by the railroad to provide flaggers, spotters, engineering services (plan review/comments), accounting services (cost work-up and negotiations), construction inspection, or any other labor, material or equipment necessary to provide a safe environment to both the contractor and the railroad. The right-of-entry permit must be obtained prior to commencement of any work within the boundaries of the railroad. The railroad will not provide any services necessitated by the Contractor's operations until the permit is obtained.

This allowance must take care of all the railroad insurances as directed by the Engineer.

9.29.4. METHOD OF MEASUREMENT.

The fixed price lump sum shown in the Bid Schedule for this item must be included in the total bid price; however, actual payment to the Contractor will be based on the actual invoices submitted by the Contractor in connection with the railroad works as described above.

9.29.5. BASIS OF PAYMENT.

The fixed sum must be considered the price bid for this item. The fixed sum is not to be altered in any manner by the bidder. Should the amount shown be altered, the new figures will be disregarded and the original price will be used to determine the total amount bid for the contract.

The fixed sum payment made under this item will be equal to the sum of all invoices submitted by the Contractor as proof of work performed for this item, as approved by the Engineer.

The total estimated cost of this item is the "fixed sum" amount shown for this item in the Bid Schedule and must not be varied in the bid. The "fixed sum" amount is included in the bid solely to ensure that sufficient monies will be available to pay the Contractor for this work, which may be more or less than the fixed sum amount.

The unit price will cover the cost of all labor, materials, equipment, insurance, and incidentals necessary to complete the work under this section in accordance with the Contract Drawings, the specifications and the directions of the Engineer.

Payment will be made under:

Item No.	Item	Pay Unit
9.29	ALLOWANCE FOR RAILROAD FACILITIES INCLUDING INSURANCE AND FORCE ACCOUNT (ALL TYPES)	F.S.

SECTION HW-900H – ALLOWANCE FOR CITY WORK ACCELERATION

Under this Section, the Contractor will be paid for City work deemed necessary by DDC's Commissioner to accelerate the City work items in the project during critical periods but the use of this item will expire on the original contract substantial completion date. Such accelerated City work includes:

- (A) 100% of the premium portions of overtime pay for working during non-scheduled work hours which must be defined as those hours of work outside the permissible hours stated in the original contract OCMC Traffic Stipulations; or,
- (B) The premium portion of overtime pay for overtime actually worked beyond the 40-hour work week but within the permissible hours of work stated in the original contract OCMC Traffic Stipulations; or,
- (C) All other incidental expenditures caused by modifications of project site regulations or administrative requirements ordered by the Commissioner that result in additional costs to perform contract work as specified.

Such accelerated City work must be paid for under this item in accordance with the requirements of **Articles 25 and 26** of the Standard Construction Contract.

Payment made under this Fixed Sum item must cover the cost of all labor, materials, plant, equipment, insurance, and incidentals necessary to accelerate the City work as ordered by DDC's Commissioner.

No guarantee is given that this allowance item will in fact be required in this contract. The estimated "fixed sum" amount shown in the Bid Schedule is included in the total bid solely to ensure a method of payment for any accelerated work performed by the Contractor, as directed by DDC's Commissioner.

Payment will be made under:

Item No.	Item	Pay Unit
HW-900H	ALLOWANCE FOR CITY WORK ACCELERATION	F.S.

S - PAGES

GENERAL AND SPECIAL PROVISIONS:

- (A) GENERAL PROVISIONS**
 - (B) HIGHWAY PROJECT SPECIFIC PROVISIONS**
 - (C) SEWER & WATER MAIN PROJECT SPECIFIC PROVISIONS**
 - (D) GREEN INFRASTRUCTURE PROVISIONS**
-

NOTICE

THE PAGES CONTAINED HEREIN (S-PAGES) ARE GENERAL AND SPECIAL PROVISIONS THAT SHALL APPLY TO AND BECOME PART OF THE CONTRACT.

(NO TEXT ON THIS PAGE)

TABLE OF CONTENTS

(A) GENERAL PROVISIONS

ARTICLE	DESCRIPTION	PAGE NO.
A	LINES AND GRADES	S-1
B	SPECIFIC TRAFFIC STIPULATIONS	S-1
C	HOLIDAYS CONSTRUCTION EMBARGO	S-1
D	CONTRACT ITEMS THAT INCLUDE BACKFILL AS PART OF THEIR WORK	S-2
E	ACCELERATED PROJECT SCHEDULE AND COMBINATION OF STAGES	S-2
F	DISPOSAL OF EXCESS EXCAVATED MATERIAL	S-2
G	NO EXTENSIONS OF TIME FOR WINTER SHUT-DOWN	S-2
H	PRIVATE UTILITY HARDWARE ADJUSTMENTS	S-2
I	SURVEY MONUMENTS	S-2
J	RESTORATION OF ADJACENT AREAS	S-2
K	FLAGGERS	S-2
L	FUEL COST	S-3
M	NYCDPR CONSTRUCTION PERMITS AND OTHER REQUIREMENTS	S-3
N	START OF CONTRACT WORK	S-4
O	STANDARD WORKING HOURS	S-4
P	TREE BARRIERS	S-4
Q	UTILITIES	S-4
R	HOUSE CONNECTIONS	S-4
S	STREET LIGHT AND TRAFFIC SIGNAL	S-4
T	SAW CUT	S-5
U	PRE-CONSTRUCTION STAGE	S-5

ARTICLE	DESCRIPTION	PAGE NO.
V	EXISTING SEWERS. WATER AND APPURTENANCE	S-5
W	RECONNECTING EXISTING SEWERS TO NEW MANHOLES	S-5
X	VIBRATION MONITORING	S-5
Y	CITY ASSETS	S-6
Z	“AS-BUILT” DRAWINGS FOR WATER MAINS AND APPURTENANCES 24-INCHES (600-MM.) AND LARGER	S-6
AA	NO ADDITIONAL PAYMENT	S-7
AB	SHEETING AND EXCAVATION AT TRANSIT FACILITIES	S-7
AC	ARCHAEOLOGICAL DISCOVERIES	S-7
AD	USE OF CITY WATER	S-8
AE	PUBLIC DISSEMINATION OF INFORMATION	S-9
AF	PRICES TO INCLUDE	S-9

(B) HIGHWAY PROJECT SPECIFIC PROVISIONS

ARTICLE	DESCRIPTION	PAGE NO.
1.	INSPECTION FORM	S-10
2.	PERMITS	S-11
3.	ALTERNATE PEDESTRIAN ACCESS	S-11
4.	GREEN INFRASTRUCTURE PROTECTION	S-11
5.	RETURNED CONCRETE CURB	S-11
6.	CAPACITY	S-12
7.	LOCATIONS	S-12
8.	NOTICE TO PROCEED AND WORK ORDERS	S-12
9	GUARANTEED MINIMUM	S-14
10	SCHEDULE OF WORK	S-14

11	TEMPORARY RESTORATIONS NOT ALLOWED	S-15
12	Item 6.44	S-15
13	PAVEMENT MARKINGS	S-15
14	PEDESTRIAN RAMP WIDTH	S-15
15	PRICE TO INCLUDE	S-15

SKETCHES / DRAWINGS

SKETCH	DESCRIPTION	PAGE NO.
1	SIDEWALK VIOLATION AND PAYMENT	S-16
2	CURB INSTALLATION DETAIL	S-17
3	7" SIDEWALK FOR CORNER QUADRANT DETAIL	S-18
4	OCMC TRAFFIC STIPULATION	S-19
5	MAINTENANCE & PROTECTION OF TRAFFIC GUIDELINES	S-25

(C) SEWER & WATER MAIN PROJECT SPECIFIC PROVISIONS

(NO TEXT)

(D) GREEN INFRASTRUCTURE PROVISIONS

(NO TEXT)

(NO TEXT ON THIS PAGE)

(A) GENERAL PROVISIONS

A. LINES AND GRADES. The Contractor must furnish lines and grades in accordance with Section 1.06.27 of the NYCDOT Standard Highway Specifications, except that survey controls established for this project may no longer exist and the Contractor will be required to re-establish the survey control information using official Borough Survey Control Monuments and Bench Marks, where they exist. The Contractor must check with Topographic Section of the Borough President's Office as to the reliability and accuracy of the data to be used for lines and grades.

B. SPECIFIC TRAFFIC STIPULATIONS. Under this contract, the Contractor must perform the work in strict accordance with the requirements of Section 6.70 in the Standard Highway Specifications, specific traffic stipulations as called for on the plans, Office of Construction Mitigation and Coordination (OCMC) Traffic Stipulations attached to the end of these Special Provisions, and the directions of the Engineer. In case of a conflict, the Engineer's decision will be final. The Contractor must plan and schedule the work in order to accommodate all special events listed in the NYCDOT Special Events Annual Calendars. The calendars are available at the following link:

https://nycdot.sharepoint.com/:f:/s/publicshare/Ei2XN4G99_JFkdrjD_cJ0QBtSPR2xhVrApcqAs1KSLpeA?e=j276PF

In addition, the cost of compliance with requirements of the OCMC Traffic Stipulations, unless otherwise provided for, will be deemed included in the prices bid for all scheduled items..

C. HOLIDAY CONSTRUCTION EMBARGO. A special Holiday Construction Embargo will be in effect on the Friday of the week preceding Thanksgiving Day week from 6:00 AM to 11:59 PM and again from the Monday of Thanksgiving Day week from 6:00 AM through January 2, at 11:59 PM. Roadway and sidewalk construction activities will be restricted during the embargo period on the streets listed below*.

Any permits issued prior to the date of this notice, for work during this embargo period on the streets listed below* which do not already have the permit stipulation "410" are hereby suspended for the period noted above. All permittees must comply with this embargo unless a special waiver is granted by OCMC. Waiver requests must be filed at least thirteen days before Thanksgiving Day, in the Permit Office by filing a "Request for Roadway/Sidewalk Permits During "Embargo Periods" and submitting supporting documentation. Waiver requests should only be submitted for critical reasons for a specific project. If a waiver is granted, the applicant will be notified so they can apply for the approved permits. Waivers **are not** required for ongoing Building Construction Activity Permits which already include the "410" permit stipulation. Waiver request forms may be obtained at any Permit Office or on the Department of Transportation's website at:

<http://www.nyc.gov/html/dot/downloads/pdf/holidayembapp.pdf>

Prior to this embargo period all necessary measures must be taken so that all roadways and sidewalks are in proper condition to allow for the expeditious and safe movement of vehicular, bicycle and pedestrian traffic. Tool carts, cable reels, containers, and material stored on roadways must be removed during the embargo period.

The opening of utility access covers is prohibited on any of the streets noted below** between the hours of 6:00 AM and midnight unless the utility or Contractor files for an Emergency Authorization Number as required by Section 2-07 of the Department of Transportation's Highway Rules. The planned opening of utility access covers may occur during the hours of 12:01 AM and 5:59 AM where no authorization number is required.

Temporary restoration of the streets and sidewalks and removal thereof, if required for the Holiday Embargo period, will be paid for under the appropriate scheduled items.

No extension of time due to the shutdown period will be granted to the Contractor for completion of the work.

* Please note that this embargo only applies to NYCDOT construction permits.

** List of street and maps of the affected locations are available by borough on the Department of Transportation's website at: <http://www.nyc.gov/html/dot/html/motorist/trafalrt.shtml>

D. CONTRACT ITEMS THAT INCLUDE BACKFILL AS A PART OF THEIR WORK. The following will pertain to all contract items that have backfill as a part of their work: Backfilling will comply with Subsection 4.11.3 of the Standard Specifications and no additional payment will be made for any Highway or Street Lighting work item requiring Contractor to furnish additional fill material to meet these requirements when backfilling.

E. ACCELERATED PROJECT SCHEDULE AND COMBINATION OF STAGES. Contractor will plan and/or stage his/her work schedule using all hours/days available. Contractor is advised that all applicable unit prices will include, for the purpose of this contract, all overtime costs, premium time costs, shift differentials required to complete construction within the specified "Time(s) of Completion" stipulated in this contract.

Contractor will be permitted to accelerate this project, to combine stages and/or work sequences. Any such changes will be shown in the construction schedule, to be furnished in accordance with the General Provisions of the Standard Specifications.

F. DISPOSAL OF EXCESS EXCAVATED MATERIAL. All excess excavated material, with the exception of contaminated material, will become the property of the Contractor and will be properly disposed of away from the site, at the Contractor's expense. Contaminated material will be disposed of separately in accordance with contract requirements.

G. NO EXTENSION OF TIME FOR WINTER SHUT-DOWN. Where the Contractor's approved work schedule for installing sidewalk, curb, roadway base and/or pavement falls within the winter period of December 1st through April 1st, the Contractor will NOT be granted an extension of time for completion of this contract due to the winter shut-down period, unless otherwise provided in Schedule A.

H. PRIVATE UTILITY HARDWARE ADJUSTMENTS. will be performed by the owning utility company or its agent, at its expense. The Contractor must notify the utility company 72 hours prior to start of work at each location where its hardware requires adjustment.

I. SURVEY MONUMENTS. When working in the vicinity of survey monument the Contractor will hand excavate per Item 8.02 AB-S, 8.02 A and 8.02 B (as applicable), at City Survey Monuments, for a distance of five (5) feet around each monument, as directed by the Engineer.

J. RESTORATION OF ADJACENT AREAS. The Contractor will be required to remove all form work. In planting strip areas, the Contractor will be required to restore areas damaged as a result of the Contractor's operations, to the satisfaction of the Engineer, with sod. The Contractor will also, as directed by the Engineer, make safe adjacent areas to the Contractor's work, such as: restoring missing or damaged pavement markings that were removed or damaged as a result of the Contractor's operations (as per requirements of Section 6.44 in the Standard Specifications); resetting granite blocks in tree pits; and, applying binder mixture (Item 4.02 CA or as applicable) where badly broken sidewalk or curb may create a dangerous condition just outside his area of operation, where and when directed by the Engineer.

All restoration work must be performed to the satisfaction of the Engineer.

K. FLAGGERS. The Contractor is notified that wherever the Item No. "6.52" and words "flagger", "flagperson" and "flagman" are used in the contract documents and drawings it will mean the

Item No. "6.52 CG" and the words "Crossing Guard", respectively. The Contractor is advised that until the Comptroller of the City of New York sets a prevailing wage rate for crossing guards, there are no prevailing wage rates for crossing guards.

For projects that require compliance with the Davis-Bacon Act, wherever the Item No. "6.52" and words "flagger", "flagperson" and "flagman" are used in the contract documents and drawings it will mean the Item No. "6.52 FED" and the words "Uniformed Flagperson", respectively.

L. FUEL COST. The Contractor is notified that the fuel cost per gallon used in the formula under Sub-Article 26.2.8 of the Standard Construction Contract for Extra Work will be derived from the fuel price index for the United States East Coast published weekly by the United States Energy Information Administration ("USEIA"), and available on its website at <http://www.eia.gov/petroleum/gasdiesel/>. The USEIA-published cost per gallon for the applicable fuel on the East Coast for the week in which the first day of each calendar quarter during the contract term occurs (i.e., January 1st, April 1st, July 1st and September 1st) will be used in the reimbursement formula for all **Extra Work** invoiced that was performed during that calendar quarter. Should the USEIA stop publishing this fuel price index, the fuel cost per gallon will be determined by reference to a substitute index to be agreed upon by the Contractor and the City.

M. NYCDPR CONSTRUCTION PERMITS AND OTHER REQUIREMENTS.

1. At least thirty (30) days prior to the upcoming start of construction at or near the New York City Department of Parks and Recreation (NYCDPR) land, the Contractor is required to issue a notice to NYCDPR about the start of construction activity. At least 30 days in advance of the Order to Work Date, the Contractor must notify the New York City Department of Parks and Recreation (NYCDPR) of the upcoming start of construction by emailing interagency@parks.nyc.gov.

2. Parks Construction Permits are required for all work on Parkland. Construction Permits may also be required for work on sidewalks adjacent to Parks properties or other areas maintained by NYCDPR such as Greenstreets depending on the scope of work. It is the Contractor's responsibility to coordinate with Parks via email at interagency@parks.nyc.gov to establish whether Construction Permits are required for the contract scope of work.

3. The Contractor will not be permitted to store, stage, stockpile, barricade, lay down construction materials or equipment, or otherwise impede access to Parkland, Greenstreets, or sidewalks in the right-of-way fronting Park properties unless such permission is granted by NYCDPR via issuance of a Parks Construction Permit.

4. The Contractor must obtain the necessary Parks Construction Permit from NYCDPR prior to the start of work on Parkland or areas under Parks' jurisdiction. The Construction Permit application is found online at <https://www.nycgovparks.org/permits/construction>.

5. When no Construction Permit is required, the contractor must notify Parks at interagency@parks.nyc.gov at least one week in advance of any construction adjacent to Greenstreets or in the right-of-way fronting Parks properties to allow for coordination as needed.

6. The Contractor is responsible for the protection of any Greenstreets, sidewalks, and other landscape features under NYCDPR jurisdiction that are adjacent to or enclosed by the construction area, including hardscape, landscape, shrubs, and trees. Any areas and features disturbed or damaged during construction activity are the responsibility of the Contractor to restore and repair.

7. Many NYCDPR properties are indicated on the publicly accessible online mapping resource of the New York City Department of Information Technology and Telecommunications (DOITT) at <http://maps.nyc.gov/doitt/nycitymap/>. However, the map is not exhaustive, and Contractors should confirm Parks properties in the vicinity of their work with NYCDPR.

8. The Contractor must take necessary precautions to prevent interference with or damage to utilities or other facilities during construction. The cost of all work connected with maintaining and protecting utilities affected by the work be borne by the Contractor and the cost will be deemed included in the price bid for the various items in the contract.

9. In the event the Contractor damages an existing utility or interrupts utility service, the Contractor will immediately notify its owner and the Engineer and must commence repair/replacement work as instructed by the Engineer.

10. In the event the Contractor causes an interruption in utility service, the Contractor will immediately arrange for service to be restored and may not cease the repair work until service is restored. The Contractor will not continue work until the service is restored, unless otherwise directed by the Engineer. All corrective utility work will be acceptable to the engineer and the subject utility owner.

11. If any utility service or connection of unknown ownership is encountered during construction which appears to enter or serve Parkland, Contractor must contact Parks at interagency@parks.nyc.gov to inquire if Parks is the owner of such utility.

N. START OF CONTRACT WORK. The Contractor is notified that a Notice To Proceed (NTP) date will be issued for work to commence within 21 to 30 Days of Contract Registration.

O. STANDARD WORKING HOURS: In absence of OCMC Traffic Stipulations, Section 1.06.23 (P) of NYC DOT STANDARD HIGHWAY SPECIFICATIONS regarding standard working hours is to be followed is to be followed. Work performed outside the standard working hours must be pre-approved by NYC DDC.

P. TREE BARRIERS. The Contractor will furnish, install, maintain and subsequently remove temporary Protective Tree Barriers. Protective Tree Barriers will be Type B, unless otherwise directed by the Engineer, and will be constructed and installed as shown on the Protective Tree Barrier sketch in Department Of Transportation, Standard Highway Details Of Construction, Drawing No. H-1046A, as directed by the Engineer, and in accordance with Department of Parks and Recreation requirements.

Price of the tree barriers must be included in the in the unit prices bid for all scheduled items.

Q. UTILITIES. All utility locations and invert elevations are not guaranteed, nor is there any guarantee that all existing utilities, whether functional or abandoned within the project area are shown.

R. HOUSE CONNECTIONS. All existing house connections will be maintained and supported during construction. The Contractor will replace any existing house connection damaged as a result of the Contractor's construction operations as ordered by the Engineer at no cost to the City.

S. STREET LIGHT AND TRAFFIC SIGNAL. The Contractor is responsible for any damage to the existing street lighting and traffic signal equipment, including underground conduits and the safety of both pedestrian and vehicular traffic for the duration of the contract.

Should any conduits, cables or foundations need repair due to the Contractor's negligent operations during construction, all work will be performed according to NYCDOT Bureau of Traffic's Standard Drawings and Specifications and City of New York DOT System Engineering Specifications (dated November 2013) at the sole expense of the Contractor.

It is the Contractor's responsibility to secure an approved electrical Contractor to perform all traffic signal work (if any). For list of approved electrical Contractors, contact Mr. Hasib Amini or James Celentano, New York City Department of Transportation at (212) 839-3386/ (212) 839-3129.

T. SAW CUT. The Contractor is advised that where the existing roadway pavement is designated to be replaced from curb to curb, then no full depth saw cutting of pavement for sewer and water main trenches will be required, except at the limits of full width pavement restoration. No separate or additional payment will be made for any saw cutting.

U. PRE-CONSTRUCTION STAGE. The Contractor is advised that the Base Contract Duration (consecutive calendar days "ccds") must also include pre-construction stage from the Notice To Proceed date. During this stage the Contractor is required to submit the necessary shop drawings, obtain all permits and submit the health and safety plan for review and approval. The Engineer's field office will also need to be established during this pre-construction stage period. Failure to comply with the pre-construction stage requirements may result in assessing liquidated damages to the Contractor for everyday beyond the pre-construction stage duration. The liquidated damage will be of equivalent value as identified in the Schedule A for work beyond the construction completion date.

V. EXISTING SEWERS, WATER AND APPURTENANCE. The Contractor is notified that at some locations there may exist sewers, manholes, water mains, etc., which are to remain undisturbed and are in close proximity to the line of the proposed work. The Contractor exercise extreme care, minimize the trench width of the proposed sewers and take all necessary precautions in placing sheeting and during excavation of the trenches to prevent any damage to the existing structures, pavement, curbs, and sidewalks that are to remain while working adjacent to them. The Contractor maybe restricted to use wood sheeting at certain critical locations as directed by the Engineer. Should any damage occur to any portion of the existing structures that are to remain due to the Contractor's operations, the Contractor will make all repairs to the existing structures to the satisfaction of and as directed by the Engineer. The cost of such repair will be borne by the Contractor, at no cost to the City. Additional cost to use wood sheeting specifically to ensure integrity of existing sewer structures will be deemed included in all bid items for work.

W. RECONNECTING EXISTING SEWERS TO NEW MANHOLES. If there are locations on the contract plans, where the Contractor is required to reconnect all existing sewers to the proposed manholes in this contract. The said manholes will be fabricated to provide openings for the existing sewers at the specified invert elevations as shown on the contract drawings. The cost of reconnecting existing sewer pipes to new manholes, including concrete collar with steel reinforcements and/or grouting around the existing sewer pipes at the openings and all work necessary to complete the pipe reconnection, to the satisfaction of the Resident Engineer will be deemed included in the prices bid for all items of work. No additional payment will be made.

***[ARTICLE "X" IS ONLY APPLICABLE IF ITEMS FOR VIBRATION MONITORING
ITEM NO. 76.31 IS IN THE BID SCHEDULE]***

X. VIBRATION MONITORING. In case of structures requiring vibration monitoring, the Contractor, in addition to Continuous Real Time Monitoring for Vibrations as determined in the Construction Report must provide Continuous Real Time Monitoring for Vibrations of existing buildings/structures adjacent

to or in the proximity of different types of construction activities being conducted including, but not limited to, installation of sheeting for construction of proposed water and sewer mains, installation of sheeting for excavation of jacking/receiving pits, direct jacking of sewers, piling work or as directed by the Engineer.

Y. CITY ASSETS. The Contractor is advised that any City owned light poles, traffic signals, street name signs, traffic signs and encumbrances including, but not limited to, underground conduit displaced as the result of the installation of the new sewers, water mains, catch basins, catch basin connections and appurtenances will be replaced in kind and as directed by the Engineer. The cost of such work will be deemed included in the prices bid for all items of work under this contract.

[ARTICLE "Z" IS ONLY APPLICABLE FOR WATERMAIN 24-INCHES AND HIGHER]

Z. "AS-BUILT" DRAWINGS FOR WATER MAINS AND APPURTENANCES 24-INCHES (600-MM.) AND LARGER: Upon the completion of the work for each Capital Project and as a condition precedent to obtaining the certificate for Substantial Completion for each Capital Project under Article 44 of the Contract, the Contractor will furnish "As-Built" drawings for water mains and appurtenances 24-inches and larger to the City. The Contractor will prepare and submit the "As-Built" record drawings to the Engineer for approval. Approved "As-Built" drawings will be delivered to the Department of Design and Construction, 30-30 Thomson Avenue, Long Island City, New York, 11101-3045. The following guideline is provided for the preparation of "As-Built" record drawings:

1. The Contractor will prepare the "As-Built" drawings on AutoCAD and will provide to the City two (2) sets of Mylar and AutoCAD files on a CD. The drawings on CD's and the plotted Mylar's will conform to the standard size of 22" x 36" (559-mm. x 914-mm.) using a 1"=30' (1:360) horizontal and 1"=10' (1:120) vertical scale. The Mylar will be 3-mil in thickness.

2. The "As-Built" drawings will include but not be limited to the following guidelines summarized below:

(a) Drawings will consist of the same legend and layout of title boxes shown on the contract drawings.

(b) Each plotted Mylar drawing will contain the signature and stamp of the Contractor's NYS Professional Engineer/Registered Architect.

(c) The drawings will include:

- street name and crossing street(s) or distance from;
- north arrow;
- property lines and widths;
- legal and existing street widths, street alignment and grades;
- "new" curb lines and widths;
- water main center line measured off the "new" curb line;
- horizontal stationing for all valves, hydrants, outlets, blow-offs, house service connections, etc., measured on a horizontal line as established by the Borough Office Bureau of Topographic;

- alignment and appurtenance location stationing, and deflection angles;
- cover and elevations (Datum used will be that of the Borough where work is located);
- location of pipe joints;
- profile of all piping;
- complete details of all outlet piping roundabouts;
- complete details of all blow-off connections to the sewer;
- complete details of all air cocks;
- location of taps and access manholes;
- location of all cathodic protection stations;
- Venturi sensing lines plans and profiles;
- all appropriate notes.

3. The cost of preparing and submitting "As-Built" approved drawings will be deemed included in the prices bid for all scheduled bid items in the contract. No separate or additional payment will be made for this work.

AA. NO ADDITIONAL PAYMENT. The Contractor is advised that any fences, guardrails, boulders, asphalt walkway of the park, fixtures, other encumbrances removed within project limits during construction will be replaced in kind to the satisfaction of the Engineer. The cost of such work will be deemed included in the prices bid for all contract items of work and no additional or separate payment will be made.

AB. SHEETING AND EXCAVATION AT TRANSIT FACILITIES. In case of transit facilities like MTA, LIRR, METRO NORTH etc., the Contractor will exercise extreme caution and take all necessary precautions in placing sheeting and excavation to prevent any damage to the existing underground or overhead structures and its appurtenances during construction work throughout the project area. The Contractor must take full responsibility to protect the said structures and its appurtenances and any damage caused by the Contractor's operations must be made good by the Contractor to the satisfaction of the Engineer at no additional cost to the City.

The Contractor must submit shop drawings to the Transit facilities showing all the details and methods of construction, such as, sheeting and bracing, including the Contractor's procedure and sequence of construction, supporting and/or protection of the existing structures and its appurtenances, with necessary design calculations for approval prior to starting of the construction. The design will be made by a New York State Licensed Professional Engineer skilled in this type of construction and as further evidenced by the imprint of Professional Engineer's seal and signature on all drawings. The cost of this work will be deemed included in the price bid for all items of work under this contract.

AC. ARCHAEOLOGICAL DISCOVERIES. The Contractor is notified that if requested by the Resident Engineer and the City, the Contractor will be required retain the services of an Archaeologist (the "City's Archaeologist") for this project.

The City's Archaeologist will be notified in advance and will be present on site during sub-surface excavations as deemed necessary. The City's Archaeologist will be authorized to halt

construction at any time in order to record and/or recover any archaeological resources encountered during excavations, and to stabilize in place any human remains encountered.

For the purpose of evaluating and recording archaeological resources, the City's Archaeologist will be allowed to enter trenches provided all standard safety requirements are met. It is understood that some construction down time may be necessary.

In the event that human remains, and/or other significant archaeological deposits are encountered during construction or archaeological investigations, Landmarks Preservation Commission (LPC) will be notified as directed by the City's Archaeologist and the State Historic Preservation Office (SHPO) requires that the following protocol is implemented:

1. At all times human remains must be treated with the utmost dignity and respect. Should human remains be encountered work in the general area of the discovery will stop immediately and the location will be immediately secured and protected from damage and disturbance.

2. Human remains or associated artifacts will be left in place and not disturbed. No skeletal remains or materials associated with the remains will be collected or removed until appropriate consultation has taken place and a plan of action has been developed.

3. The County coroner and local law enforcement as well as the SHPO and the involved agency will be notified immediately. The coroner and local law enforcement will make the official ruling on the nature of the remains, being either forensic or archeological. If the remains are archeological in nature, a bio-archaeologist will confirm the identification as human.

4. If human remains are determined to be Native American, the remains will be left in place and protected from further disturbance until a plan for their protection or removal can be generated. The involved agency will consult SHPO and appropriate Native American groups to determine a plan of action that is consistent with the Native American Graves Protection and Repatriation Act (NAGPRA) guidance.

5. If human remains are determined to be Euro-American, African- American, etc., the remains will be left in place and protected from further disturbance until a plan for their avoidance or removal can be generated. Consultation with the SHPO and other appropriate parties will be required to determine a plan of action.

Should extra work be ordered by the Resident Engineer as a result of any archaeological discoveries, it will be paid for from the Fixed Sum included in, and in accordance with Item HW-908 Allowance for Extra Work Due To Archaeological Discoveries.

AD. USE OF CITY WATER. Please refer to NYCDOT STANDARD HIGHWAY SPECIFICATIONS (May 16, 2022), Sub Section 1.06.23 (A), Rules, Laws, and Requirements, for use of City water.

AE. PUBLIC DISSEMINATION OF INFORMATION. The Contractor agrees to hold confidential, both during and after the completion or termination of this Contract, all of the reports, information, or data, furnished to, or prepared, assembled or used by, the Contractor under this Contract. The Contractor agrees to maintain the confidentiality of such reports, information, or data by using a reasonable degree of care, and using at least the same degree of care that the Contractor uses to preserve the confidentiality of its own confidential information. The Contractor agrees that such reports, information, or data will not be made available to any person or entity without the prior written approval of the Commissioner. The obligation under this Section to hold reports, information or data confidential will not apply where the Contractor is legally required to disclose such reports, information or data by virtue of a subpoena, court order or otherwise (“disclosure demand”), provided that the Contractor complies with the following: (1) the Contractor will provide advance notice to the Commissioner, in writing or by e-mail, that it received a disclosure demand for such reports, information or data and (2) if requested by the Commissioner, the Contractor will not disclose such reports, information or data until the City has exhausted its legal rights, if any, to prevent disclosure of all or a portion of such reports, information, or data. The previous sentence will not apply if the Contractor is prohibited by law from disclosing to the City the disclosure demand for such reports, information or data.

The Contractor will restrict access to confidential information to persons who have a legitimate work-related purpose to access such information. The Contractor agrees that it will instruct its officers, employees, and agents to maintain the confidentiality of any and all information required to be kept confidential by this Contract.

The Contractor, and its officers, employees, and agents will notify the Commissioner, at any time either during or after completion or termination of this Contract, of any intended statement to the press or any intended issuing of any material for publication in any media of communication (print, news, television, radio, Internet, etc.) regarding the services provided or the data collected pursuant to this Contract at least twenty-four (24) hours prior to any statement to the press or at least five (5) business days prior to the submission of the material for publication, or such shorter periods as are reasonable under the circumstances. The Contractor may not issue any statement or submit any material for publication that includes confidential information as prohibited by this Section.

At the request of the Commissioner, the Contractor will return to the Commissioner any and all confidential information in the possession of the Contractor or its subContractors. If the Contractor or its subContractors are legally required to retain any confidential information, the Contractor will notify the Commissioner in writing and set forth the confidential information that it intends to retain and the reasons why it is legally required to retain such information. The Contractor will confer with the Commissioner, in good faith, regarding any issues that arise from the Contractor retaining such confidential information. If the Commissioner does not request such information, or the Law does not require otherwise, such information will be maintained in accordance with the requirements set forth in the Contract Documents.

AF. PRICES TO INCLUDE. No direct payment will be made for costs incurred in complying with the foregoing Special Provisions, unless otherwise provided. Said costs will be deemed to have been included in the prices bid for all the scheduled contract items.

(B) HIGHWAY PROJECT SPECIFIC PROVISIONS

1. INSPECTION FORM.

- a. Prior to the issuance of substantial completion, all locations constructed under this contract must be substantially complete and accompanied by an approved inspection form and where applicable, approved technical infeasibility form(s).
- b. The approved PRISM inspection form will be the determination made by the Engineer informing the Contractor that the pedestrian ramps are accepted or rejected as non-compliant with Contract Specifications and thereby instructing the Contractor to reconstruct the rejected pedestrian ramps at no cost to the City.
- c. Prior to concreting a pedestrian ramp, if any location cannot be built compliant due to existing structures, topography or trees, then the Contractor must immediately request the presence of the Resident Engineer during the framing phase. The Contractor will layout the ramp by placing nail stakes at all grade changes (ramp, landing, sidewalk approaches etc.) in the concrete sidewalk, and explain to the Resident Engineer which elements of the ped ramp cannot be built compliant and why. The Resident Engineer will either approve or disapprove the request for Technical Infeasibility and document such decisions. The Contractor is then required to complete a Technical Infeasibility form (TIF) no later than two (2) weeks after construction. All TIFs submitted to the Engineer must be signed and sealed by a licensed Professional Engineer registered in New York State. No separate payment will be made to the Contractor for services of Professional Engineer and the price to be deemed included into the price of all pedestrian ramp items. All TIFs must be approved by the Engineer otherwise the pedestrian ramp must be re-installed to be ADA compliant at no additional cost to the City.

The PRISM inspection form may be found at the following website:

https://www.nycpedramps.info/sites/default/files/2023-03/TI_23-001_Pedestrian_Ramp_Inspection_Application_PRISM.pdf

The TIF may be found at the following website:

https://www.nycpedramps.info/sites/default/files/2023-01/DOT_Technical-InfeasibilityForm_v2.0.

2. PERMITS.

- a. Contractors must obtain Series 04, Type 412 Sidewalk Construction permits for all locations that require modification and/or installation of sidewalks, driveways and pedestrian ramps. Permits will be procured by the Contract at no cost to the City.
- b. For all work locations within 200' of an MTA facility, the Contractor is required to enter into an agreement with the MTA to secure permits to work near their facility. Any costs associated with MTA providing said approvals will be reimbursed under item number 9.29.
- c. The Contractor must obtain all Department of Parks and Recreation Tree work permit(s) for all locations where installation of sidewalks, driveways and pedestrian ramps are within 50 feet of a tree under City jurisdiction. Permits will be procured by the Contractor at no cost to the City.

3. ALTERNATE PEDESTRIAN ACCESS. Throughout all phases of construction, where pedestrian access routes are closed, alternate pedestrian access routes must be provided. When existing pedestrian facilities are disrupted, closed, or relocated in a Temporary Traffic Control (TTC) zone, the temporary facilities will be detectable and will include accessibility features, such as ramps and railings if required. Temporary pedestrian access routes must be designed to allow passing throughout and must comply with the minimum requirements of Manual on Uniform Traffic Control Devices (MUTCD) and Public Right-of-Way Accessibility Guidelines (PROWAG). The MPT plans and notes for this project outline these requirements and any related layouts to the Contractor.

If the Contractor encounters a field condition where the included Mandatory MPT plan is not applicable, they are required to provide a new plan signed and sealed by a licensed Engineer.

4. GREEN INFRASTRUCTURE ASSET PROTECTION.

- (A) Provide sandbag to all curb cuts at all green infrastructure assets.
- (B) Install a 3' high barrier around all adjacent and downstream bioswales and wrap a silt fence around the perimeter of the bioswale. For bioswales with trees, provide a 6 feet high barrier with silt fence or as directed by the Engineer.
- (C) Install filter fabric beneath the grating of all adjacent and downstream catch basins.

5. RETURNED CONCRETE CURB. Construction of Returned Concrete Curb must follow SECTION 4.08 of NYCDOT Standard Specifications and Detail Number: RCC-1 herein the S- PAGES. Returned concrete curb are to be built against an adjacent property line, around buffer zones or as directed by the Engineer whenever existing sidewalk grades are to be lowered.

Construction of Returned Concrete Curb must follow SECTION 4.08 of NYCDOT Standard Specifications and the details provided in Technical Bulletin (TB 22-002) Titled H-1060 Steel Faced Curb at Pedestrian Ramps and Sidewalk Curb at

https://www.nycpedramps.info/sites/default/files/2022-08/TB_22-002%20-%20H-1060%20Steel%20Faced%20Curb%20at%20Pedestrian%20Ramps%20and%20Sidewalk%20Curb%20-%20signed.pdf

6. CAPACITY.

(A) Required Production Rates. This Contract is being bid for reconstruction of approximately 52670.00 S.F. of sidewalk including driveways and pedestrian ramps with the requirement that the Contractor has the capacity to successfully execute up to 4 simultaneous Locations and complete a minimum of 3000.00 S.F. per month (approximately) during the construction season. Failure to comply may result in the Contractor being declared in default of the Contract under the requirements of Article 48 of the Standard Construction Contract.

(B) Capacity for Contract Award. Prior to award, the Contractor must prove that the Contractor meets the following capacity requirements:

- i. Cash Flow. The Contractor must show financial statements showing that the Contractor has sufficient access to liquid capital equal to or greater than 25% of the total Bid Price.
- ii. Equipment. The Contractor must show access to sufficient equipment, particularly backhoes and dump trucks, to meet the required production rates in subsection 6 (A) above. In order to show access to sufficient equipment, the Contractor must identify the quantities of equipment necessary to meet the required production rates.
- iii. Manpower. The Contractor must show access to sufficient craft labor to meet the required production rates in subsection 6 (A) above.
- iv. Supervision. The Contractor must identify the field supervisors or superintendents who will supervise the work under this contract. The identified superintendents and supervisors must attend the pre-award meeting. For each superintendent and supervisor, the Contractor must provide the resume and relevant experience of the individual, including, at a minimum, all relevant experience of the individual for the three (3) years prior to the bid date. Sufficient superintendents must be identified and provided, but in any event not less than one (1) superintendent for every four (4) work crews.

7. LOCATIONS. This Contract will be for work within the Staten Island (all Community Boards). The Engineer will select and obtain Locations for submission to the Contractor. Locations for this contract will be furnished to the Contractor by written Work Order.

8. NOTICE TO PROCEED AND WORK ORDERS.

(A) Notice to Proceed and Initial Work order. The Contractor is hereby advised that the "Notice to Proceed" and first Work Order, with the work for the first location or group of locations, will be given promptly after registration and, pursuant to Article 8 of the Standard Construction Contract, the Contractor must commence work on the date specified

in the written notice signed by the Commissioner.

(B) Issuance of Work Orders. Following issuance of the “Notice to Proceed” and as the need for services arises, the Engineer will issue a written Work Order to the Contractor. The Work Order will include the following:

- i. Location of Work
- ii. Scope of Work (i.e., Installation of sidewalk and any necessary Ped ramps at designated locations etc.)
- iii. Technical Infeasibility (TI) final approval Status for ramps where a TI review was requested at the time of the joint inspection.
- iv. Presence of city trees within 50’ of the estimated construction limits. Tree permits and tree surveys not needed for locations marked as “No”.
- v. The time frame for completion of all required services, based on the required production rate of 3000 S.F. per month(approximately), typically not more than 30 calendar days per location;
- vi. The required mobilization period to begin construction, typically fourteen (14) calendar days. The Contractor must verify the information in the field and discrepancies, if any, will be reported to the Engineer. The Contractor will inspect each work location jointly with the Engineer, at least two (2) weeks in advance of the start of construction at each location, to determine possible interferences of the existing facilities with the installation of sidewalks, driveways and pedestrian ramps. All request for a TI application must be made at the joint inspection. Where private utility facilities, such as telephone booths, utility poles, electric vaults, etc., interfere with the installation of sidewalks, driveways and pedestrian ramps, the Contractor will notify those private utility facility operators at least two (2) weeks in advance of the starting work at each location. If mail box relocation is required, the U.S. Post Office will be notified. Installation of pedestrian ramps at each location will not start prior to the removal of interferences, as determined by the Engineer. Where existing bollards, guard booths, non-City-owned signs and sign posts, etc., cause interference with the installation of sidewalks, driveways and pedestrian ramps, they will be carefully removed and either delivered to the property owner or disposed of away from the site, as directed by the Engineer, at no cost to the City.

(C) Execution of Work Orders. The Contractor must mobilize and begin work within the mobilization period specified in the Work Order and complete the work, including any deficiencies as directed by the engineer, within the time frame for completion specified in the Work Order.

- i. The Contractor must provide sufficient work force crews to successfully execute up to 4 simultaneous locations specified in the Work Order. Each work force crew will be defined as a sufficient number of workers with adequate supervision, support staff and equipment necessary to perform the work efficiently as specified herein and directed by the Engineer. Where the Contractor can demonstrate to the Engineer that the Contractor has substantially completed work at a locations, the Contractor may be permitted to start work at additional locations, on a one-to-one basis, at the sole discretion of the Engineer.

- ii. In the event the Contractor fails to complete all required services set forth in the Work Order within the specified time frame plus authorized time extensions, liquidated damages will be assessed on a daily basis in the amount specified in Schedule A.
- iii. Contractor is required to provide a land survey of the sidewalk corner quadrant and sidewalk transition areas, whenever the Contractor needs to document that the corner cannot be build ADA-compliant due to the existing field conditions, or at the request of the engineer.
- iv. There cannot be more than 4 corners pending pavement key or final asphalt restoration at any given time. Final restoration for any individual corner must be completed within 7 days of concreting operation.

9. GUARANTEED MINIMUM. In the event the Contractor is not directed to perform any services hereunder, the City agrees to pay, and the Contractor agrees to accept, a fee of \$2,000. The Contractor further agrees that under such circumstances, it has no action for damages or for loss of profits against the City. In addition, if no services are ordered, the City agrees to reimburse the Contractor the actual and reasonable cost of required performance and payment bonds, with no mark up for overhead and profit. In its request for reimbursement, the Contractor will provide a copy of the cancelled check for the required bonds, as well as any other documentation required by the Commissioner.

10. SCHEDULE OF WORK. The Contractor must prepare a progress schedule, in accordance with the requirements of Article 9 of the Contract, based on working at the same time at not more than 4 active locations. Where the Contractor's work operations are not able to meet its approved progress schedule, the Engineer may order the Contractor to provide additional work force as may be necessary. Failure to comply with such orders within seven (7) calendar days after the written notice from the Engineer may result in the Contractor being declared in default of the Contract in accordance with the procedure contained in Article 48 of the Standard Construction Contract.

NOTE: THE DEPARTMENT RESERVES THE RIGHT TO:

- (A) Substitute alternate and equivalent locations contiguous to the described locations should the need to delete any of the preceding locations arise;
- (B) Delete any locations if funding is insufficient to complete all of this work;
- (C) Delete any location where any of the following conditions are encountered: a vault structure interferes with construction of sidewalk, driveways or pedestrian ramp; Transit Authority structure interferes with construction of sidewalk, driveways or pedestrian ramp; or, a distinctive sidewalk has to be installed.
- (D) Delete any item of work where directed by the Engineer.

11. TEMPORARY RESTORATION NOT ALLOWED. No temporary restoration of asphaltic concrete work is allowed. All such temporary asphalt restoration work where required must be done as permanent restoration within 7 days of completion of the reconstructed pedestrian ramp, or as directed by the engineer. Failure to complete the permanent restoration within the required time will result in assessment of Liquidated Damages at the rate set forth in Schedule A. Work done under permanent restoration will be paid accordingly as per the relevant BID SCHEDULE items, e.g. 4.02 CB, 4.04 H, etc.

12. Item 6.44 - The NYC DOT Standard Specifications Section 6.44.3(F) entire text is modified herein as following:

Preformed reflectorized pavement markings from NYSDOT Approved List 727-04 may be used for all pavement marking restorations, at no extra cost.

13. PAVEMENT MARKINGS. Any modification(s) to proposed crosswalk pavement markings must be reviewed and approved by NYCDOT's Design and Construction unit. NYCDOT will require the Engineer to develop crosswalk pavement markings record drawings (if required) or other sketches for review and approval before installation.

14. PEDESTRIAN RAMP WIDTH. 5' Wide Ped Ramps are to be built for all Directional and Perpendicular ramps.

15. PRICES TO INCLUDE. No direct payment will be made for costs incurred in complying with the foregoing Special Provisions, unless otherwise provided. Said costs will be deemed to have been included in the prices bid for all the scheduled contract items.

DRAWINGS AND SKETCHES

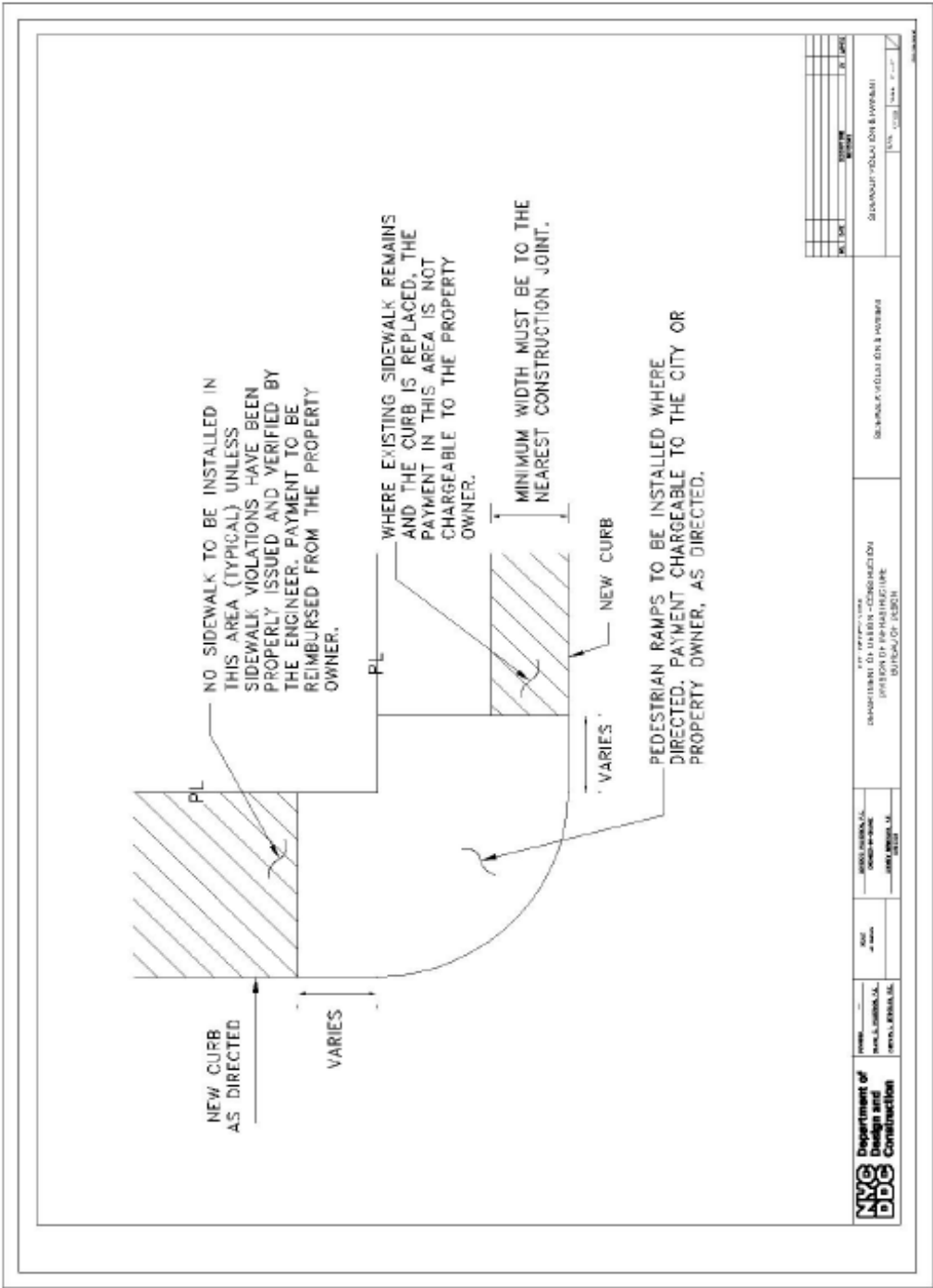

NO. OF SHEETS	10
SHEET NO.	10
DATE	10/10/23
BY	10/10/23
CHECKED	10/10/23
APPROVED	10/10/23

DEPARTMENT OF DESIGN AND CONSTRUCTION
 DIVISION OF PERMITS AND CONSTRUCTION
 BUREAU OF DESIGN

NEW YORK STATE
 DEPARTMENT OF DESIGN AND CONSTRUCTION
 DIVISION OF PERMITS AND CONSTRUCTION
 BUREAU OF DESIGN

NEW YORK STATE
 DEPARTMENT OF DESIGN AND CONSTRUCTION
 DIVISION OF PERMITS AND CONSTRUCTION
 BUREAU OF DESIGN

NEW YORK STATE
 DEPARTMENT OF DESIGN AND CONSTRUCTION
 DIVISION OF PERMITS AND CONSTRUCTION
 BUREAU OF DESIGN



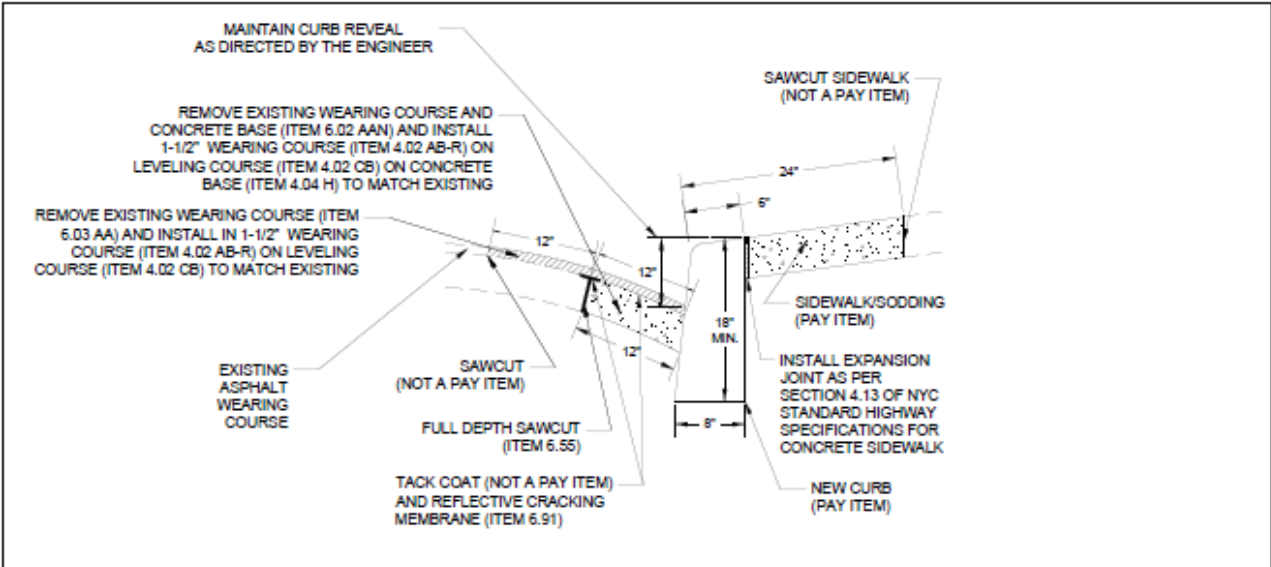

CURB INSTALLATION DETAIL

NOTE:

A. ROADWAY AREA RESTORATION:

1. Removal, disposal of existing wearing course, and restoration as indicated will be paid under the appropriate scheduled items.
2. At dirt shoulders, the curb trench must be backfilled, compacted and topped with 4" binder mixture where directed and approved by the Engineer, the cost of which will be paid under Asphaltic Concrete Mixture, as provided.
3. At Belgian Block pavement covered with asphaltic location, one course of the blocks may be removed and restored with Asphaltic Concrete Mixture. At Belgian Block surface pavement locations, the blocks must be reset, unless otherwise directed by the Engineer. The cost of this work is included in the price bid for the curb item.
4. Any pavement markings disturbed on roadway restoration or pavement keys must be restored, paid for under the appropriate scheduled items in Section 6.44 of NYC Standard Highway Specifications.

B. SIDEWALK AREA RESTORATION:

1. The sawcutting, removal, disposal of existing sidewalk and restoration with new sidewalk will be paid for under the appropriate sidewalk item, as per specifications.
2. At grass sidewalk areas, the curb must be backfilled, compacted as necessary, and topped with 6" of topsoil and sodded, the cost of which is included in the price bid for the sodding item.

N.Y.C. Dept. of Transportation
CURB INSTALLATION DETAIL
9/13/2023

7" SIDEWALK FOR CORNER QUADRANT DETAIL

NOTES:

- 1. AREA A1 = $\frac{R1 * R2}{2}$
- 2. AREA A2 = COEFFICIENT * C * H
- 3. SIDEWALK AREA = A1 + A2

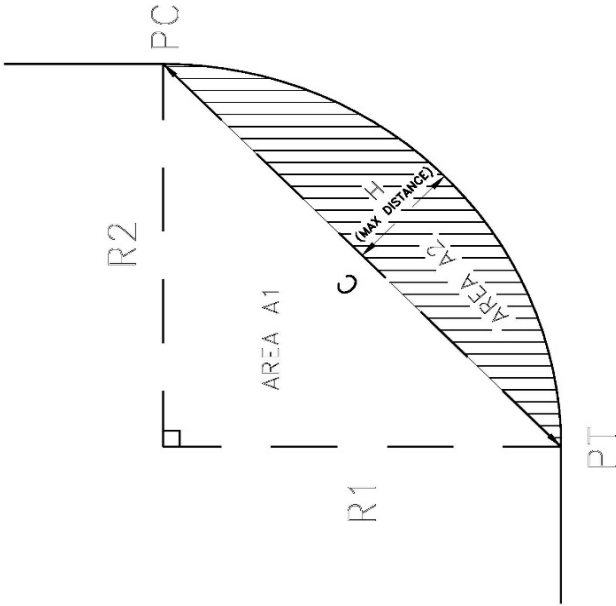

PLAN VIEW OF CORNER QUADRANT (N.T.S.)

H/C	Coefficient	H/C	Coefficient
0.01	0.6667	0.26	0.7014
0.02	0.6669	0.27	0.7041
0.03	0.6671	0.28	0.7068
0.04	0.6675	0.29	0.7096
0.05	0.6680	0.30	0.7125
0.06	0.6686	0.31	0.7154
0.07	0.6693	0.32	0.7185
0.08	0.6701	0.33	0.7216
0.09	0.6710	0.34	0.7248
0.10	0.6720	0.35	0.7280
0.11	0.6731	0.36	0.7314
0.12	0.6743	0.37	0.7348
0.13	0.6756	0.38	0.7383
0.14	0.6770	0.39	0.7419
0.15	0.6785	0.40	0.7455
0.16	0.6801	0.41	0.7492
0.17	0.6818	0.42	0.7530
0.18	0.6836	0.43	0.7568
0.19	0.6855	0.44	0.7607
0.20	0.6875	0.45	0.7647
0.21	0.6896	0.46	0.7687
0.22	0.6918	0.47	0.7728
0.23	0.6941	0.48	0.7769
0.24	0.6964	0.49	0.7811
0.25	0.6989	0.50	0.7854

	SCALE AS SHOWN	DESIGNER STEVE J. JACOBI, P.E. ENGINEER-IN-CHARGE DANIEL BERNARDI, P.E. CHECKER	CITY OF NEW YORK DEPARTMENT OF DESIGN + CONSTRUCTION DIVISION OF INFRASTRUCTURE BUREAU OF DESIGN	METHOD OF CALCULATION FOR CIRCULAR SEGMENTS AT CORNER QUADRANTS	CALCULATION FOR CIRCULAR SEGMENTS AT CORNER QUADRANTS
PROJECT NO. _____		DRAWING NO. _____		DATE: _____	

OCMC TRAFFIC STIPULATIONS**OCMC TRAFFIC STIPULATIONS**

July 6, 2020

OCMC FILE NO: CEC-12-124 Amendment #1
CONTRACT NO: All Sidewalk, Curb and Pedestrian Ramp Repair/Replacement Contracts Citywide
PROJECT: Sidewalk, Curb and Pedestrian Ramp Repair/Replacement Citywide
LOCATION(S): VARIOUS LOCATIONS CITYWIDE

PERMISSION IS HEREBY GRANTED TO THE **NEW YORK CITY DEPARTMENT OF DESIGN AND CONSTRUCTION**, AND ITS DULY AUTHORIZED AGENT, TO ENTER UPON AND RESTRICT THE FLOW OF TRAFFIC AT THE ABOVE LOCATION(S) FOR THE PURPOSE OF CARRYING OUT THE ABOVE NOTED PROJECT, SUBJECT TO THE STIPULATIONS, AS NOTED BELOW:

I. SPECIAL STIPULATIONS

- A. **EMBARGOES** – A CONSTRUCTION EMBARGO WILL APPLY TO THOSE LOCATIONS BELOW WHICH FALL WITHIN THE **HOLIDAY EMBARGO** OR ANY OTHER SPECIAL EVENT EMBARGOES PUBLISHED BY THE BUREAU OF PERMIT MANAGEMENT AND CONSTRUCTION CONTROL.
- B. **BIKE LANES** – FOR ANY WORK IN OR AFFECTING A BIKE LANE, THE PERMITTEE MUST COMPLY WITH THE **NEW GUIDELINES FOR THE MAINTENANCE & PROTECTION OF TRAFFIC PLAN FOR CYCLING**, WHICH ARE AVAILABLE AT:
[HTTPS://WWW1.NYC.GOV/HTML/DOT/DOWNLOADS/PDF/BIKE-MPT-GUIDELINES.PDF](https://www1.nyc.gov/html/dot/downloads/pdf/bike-mpt-guidelines.pdf)
- C.
- D. **BIKE SHARE STATIONS**: THE PERMITTEE SHALL NOT REMOVE, RELOCATE, DAMAGE OR DISRUPT THE OPERATION OF EXISTING BIKE SHARE STATIONS WITHOUT FIRST CONTACTING NYC BIKE SHARE AT 855-245-3311 FOR THEIR REQUIREMENTS PRIOR TO COMMENCING WORK.
- E. **CITYBENCH**: THE PERMITTEE SHALL NOT REMOVE, RELOCATE, DAMAGE OR DISRUPT AN EXISTING CITYBENCH WITHOUT FIRST CONTACTING NYC DOT AT 212-839-6569, OR VIA EMAIL AT CITYBENCH@DOT.NYC.GOV PRIOR TO COMMENCING WORK.
- F. **PROTECTION OF NYC DEP GREEN INFRASTRUCTURE**: THE PERMITTEE SHALL TAKE PRECAUTION OF NYC DEP GREEN INFRASTRUCTURE IN THE RIGHT-OF-WAY. THE PERMITTEE MUST PROTECT NYC DEP GREEN INFRASTRUCTURE DOWNSTREAM OF THE WORK OR WITHIN FIVE (5) FEET OF THE WORK AREA. THE PERMITTEE MUST EMAIL NYC DEP AT SUSTAINABILITY@DEP.NYC.GOV FOR PROTECTION REQUIREMENTS PRIOR TO COMMENCING WORK. THE PERMITTEE IS RESPONSIBLE FOR RESTORATION OF DAMAGED NYC DEP INFRASTRUCTURE AS DIRECTED BY NYC DEP.
- G. **BUS STOPS** – THE PERMITTEE SHALL PROVIDE WRITTEN NOTICE TO NYC DOT OCMC AND NEW YORK CITY TRANSIT (NYCT) A MINIMUM OF FIVE (5) WEEKS IN ADVANCE FOR LANE/STREET CLOSURES THAT AFFECT BUS ROUTES/BUS STOPS.
- H. **STREET LIGHTS / TRAFFIC SIGNALS**: THE PERMITTEE SHALL NOT REMOVE OR RELOCATE EXISTING STREET LIGHTS OR TRAFFIC SIGNALS WITHOUT FIRST OBTAINING APPROVAL FROM NYCDOT STREET LIGHTING / TRAFFIC SIGNALS UNIT.
- I. **TRAFFIC CAMERAS, DETECTION/COMMUNICATION EQUIPMENT**: IF AT ANY TIME DURING THE APPROVED WORK, THE PERMITTEE ENCOUNTERS TRAFFIC SURVEILLANCE CAMERAS, DETECTION EQUIPMENT OR ANY TYPE OF COMMUNICATION EQUIPMENT (WIRELESS OR HARD-WIRED) ON ANY NYC DOT FACILITY, THAT IS NOT INCLUDED ON THE DESIGN/BUILD DRAWINGS, THE PERMITTEE SHALL IMMEDIATELY NOTIFY NYC DOT TRAFFIC MANAGEMENT BY PHONE AT 718-433-3390 OR 718-433-3340 AND VIA EMAIL AT TMC@DOT.NYC.GOV AND AWAIT DIRECTION PRIOR TO CONTINUING WORK.
- J. **METERS** – THE PERMITTEE SHALL NOT REMOVE OR RELOCATE PARKING METERS WITHOUT FIRST OBTAINING APPROVAL FROM NYCDOT PARKING METER DIVISION AT 718 – 894 – 8651.

- K. **TEST PITS** – THE BELOW TRAFFIC STIPULATIONS DO NOT APPLY TO TEST PIT WORK RELATED TO THIS CONTRACT. WORK HOURS AND OTHER REQUIREMENTS FOR TEST PIT OPERATIONS MAY DIFFER FROM THE STIPULATIONS IDENTIFIED BELOW. THE PERMITEE SHALL BE REQUIRED TO OBTAIN SEPARATE PERMITS RELATED TO TEST PITS.
- L. **TEMPORARY PARKING REGULATIONS/PAVEMENT MARKINGS** – THE PERMITEE IS REQUIRED TO INSTALL, MAINTAIN AND REMOVE ALL NECESSARY TEMPORARY PARKING AND REGULATORY SIGNS AND PAVEMENT MARKINGS, AND RESTORE THEIR ORIGINAL CONDITION PER NYC DOT STANDARDS, PRIOR TO EXPIRATION OF THEIR PERMITS. THE PERMITEE OR AGENCY PERFORMING PUBLIC OUTREACH SHALL POST AND MAINTAIN ADVISORY SIGNS A MINIMUM OF 48 HOURS PRIOR TO CHANGING EXISTING PARKING REGULATION SIGNS TO APPROVED TEMPORARY CONSTRUCTION PARKING REGULATION SIGNS. THE ADVISORY SIGNS SHOULD BE POSTED ON ALL POLES AND DRIVE RAILS ON THE SEGMENT AFFECTED, INDICATING THE DATE OF THE CHANGE, THE NEW REGULATIONS AND A TELEPHONE NUMBER TO OBTAIN MORE INFORMATION.
- M. **ACCESS TO ABUTTING PROPERTIES** – THE PERMITEE SHALL COORDINATE ALL ACTIVITIES WITH ABUTTING PROPERTY OWNERS TO ENSURE ACCESS IS PROVIDED TO/FROM ENTRANCES/DRIVEWAYS AT ALL TIMES.
- N. **AUTHORIZED PARKING** – PRIOR TO PERFORMING WORK WHICH IMPACTS AUTHORIZED PARKING, THE PERMITEE SHALL SUBMIT IN WRITING, AND COPY OCMC-STREETS, A REQUEST TO OCCUPY SPACE CURRENTLY USED BY AUTHORIZED VEHICLES. APPROVAL MUST BE RECEIVED FROM AUTHORIZED PARKING PRIOR TO OCCUPYING THESE AREAS.
- O. **NOTIFICATION** – THE PERMITEE MUST AT LEAST TWO (2) WORKING DAYS BEFORE THE START OF CONSTRUCTION NOTIFY THE NYC FIRE DEPARTMENT, NYC POLICE DEPARTMENT, NYCEMS, LOCAL COMMUNITY BOARD, BOROUGH PRESIDENT’S OFFICE-CHIEF ENGINEER, NYCDOT OCMC OFFICE, AND ALL ABUTTING PROPERTY OWNERS.
- P. **CONSTRUCTION INFORMATIONAL SIGNS** – THIS PROJECT REQUIRES A CONSTRUCTION PROJECT INFORMATIONAL SIGN (CPIS) IN ACCORDANCE WITH NYCDOT HIGHWAY RULE SECTION 2-02 (4) AND (5). CRITERIA AND A PROTOTYPE FOR THIS SIGN MAY BE FOUND ON THE NYCDOT WEBSITE AT:
[HTTP://WWW.NYC.GOV/HTML/DOT/DOWNLOADS/PDF/DOT_CPIS_DIRECTIONS.PDF](http://www.nyc.gov/html/dot/downloads/pdf/dot_cpis_directions.pdf)
- Q. **ENHANCED MITIGATIONS**
- o **“NO STANDING ANYTIME-TEMPORARY CONSTRUCTION” SIGNS** AND TEMPORARY PAVEMENT MARKINGS SHALL BE INSTALLED AND MAINTAINED AS WARRANTED BY THE MAINTENANCE AND PROTECTION OF TRAFFIC (MPT) REQUIRED TO FACILITATE TRAFFIC MOVEMENTS THROUGH THE WORK ZONE. ALL TEMPORARY SIGNS AND PAVEMENT MARKINGS SHALL BE REMOVED UPON COMPLETION OF THE PROJECT.
 - o **COMMUNITY OUTREACH** SHALL BE PROVIDED FOR THE DURATION OF THE PROJECT.

II. MAINTENANCE AND PROTECTION OF TRAFFIC**NON-CRITICAL ROADWAY****A. ROADWAYS UP TO 44 FEET IN WIDTH:**

1. Work hours shall be as follows:
 - a. Monday to Friday 7am to 6pm.
 - b. Saturday 8am to 6pm.
 - c. Sunday 9am to 6pm.
 - d. In school zones when school is in session work Monday to Friday 9am to 2pm, an authorization letter from the school principal is required. When school is not in session above work times may apply.
 - e. A school variance (VAR001) is granted by as stipulated by DOT.
 - f. Should NO STANDING rush hour regulations apply adjacent/opposite of the work zone then the hours specified on the regulation will apply. OCMC streets should be contacted in writing by the engineer in charge only in they are requesting a waiver and consideration to work during restricted hours.
2. Contractor must maintain (1) 11-foot lane for traffic on a one-way street and (2) 11-foot lanes one in each direction on a two-way street.
3. Contractor shall provide a 5-foot clear sidewalk or a 5-foot clear pedestrian walkway in the roadway at all times. Occupancy of NO STOPPING ZONES, NO STANDING ZONES and AUTHORIZED PARKING is prohibited. If a pedestrian walkway in the roadway is used it must be ramped for handicapped access. All crosswalks must be opened to pedestrians.
4. Contractor shall not work on opposite sidewalks/curbs simultaneously.

B. ROADWAYS 45 FEET OR GREATER IN WIDTH

1. Work hours shall be as follows:
 - a. Monday to Friday 7am to 6pm.
 - b. Saturday 8am to 6pm.
 - c. Sunday 9am to 6pm.
 - d. In School zones when school is in session work Monday to Friday 9am to 2pm. An authorization letter from the school principal is required. When school is not in session above work times may apply.
 - e. A school variance (VAR001) is granted by as stipulated by DOT.
 - f. Should NO STANDING rush hour regulations apply adjacent/opposite of the work zone then the hours specified on the regulation will apply. OCMC streets should be contacted in writing by the engineer in charge only if they are requesting a waiver and consideration to work during restricted hours.
 - g. In school zones when school is in session work Monday to Friday 9am to 2pm. An authorization letter from the school principal is required. When school is not in session above work times may apply.

2. Contractor must maintain (1) 11-foot lane for traffic on a one-way street and (2) 11-foot lanes one in each direction on a two-way street.
3. Contractor shall provide a 5-foot clear sidewalk or a 5-foot clear pedestrian walkway in the roadway at all times. Occupancy of NO STOPPING ZONES, NO STANDING ZONES and AUTHORIZED PARKING is prohibited. If a pedestrian walkway in the roadway is used it must be ramped for handicapped access. All crosswalks must be opened to pedestrians.
4. Contractor shall not work on opposite sidewalks/curbs simultaneously.

CRITICAL ROADWAYS

NOTE: On some roadways with high pedestrian/vehicular volumes (e.g. Times Square, Downtown Brooklyn, Queensboro Plaza) OCMC-Streets reserves the right to determine the appropriate maintenance and protection of traffic in consultation with the engineer in charge for the agency performing the work. In these locations the stipulations identified in CEC-12-124 may not be used.

1. Work hours shall be as follows:
 - a. Monday to Friday 9am to 4pm.
 - b. Saturday 8am to 6pm.
 - c. Sunday 9am to 6pm.
 - d. In School zones when school is in session work Monday to Friday 9am to 2pm, an authorization letter from the school principal is required. When school is not in session above work times may apply.
 - e. A School variance (VAR001) is granted by as stipulated by DOT.
 - f. Should NO STANDING rush hour regulations apply adjacent/opposite of the work zone then the hours specified on the regulation will apply. OCMC streets should be contacted in writing by the engineer in charge only in they are requesting a waiver and consideration to work during restricted hours.
 - g. In School zones when school is in session work Monday to Friday 9am to 2pm. An authorization letter from the school principal is required. When school is not in session above work times may apply.
 - h. A School variance (VAR001) is granted by as stipulated by DOT
2. Contractor must maintain (1) 11-foot lane for traffic on a one-way street and (2) 11-foot lanes one in each direction on a two-way street.
3. Contractor shall provide a 5-foot clear sidewalk or a 5-foot clear pedestrian walkway in the roadway at all times. Occupancy of NO STOPPING ZONES, NO STANDING ZONES and AUTHORIZED PARKING is prohibited. If a pedestrian walkway in the roadway is used it must be ramped for handicapped access. All crosswalks must be opened to pedestrians.
4. Contractor shall not work on opposite sidewalks/curbs simultaneously.

III. GENERAL NOTES

- A. **THIS IS NOT A PERMIT.** THIS STIPULATION SHEET MUST BE SUBMITTED WITH ALL REQUESTS FOR PERMITS PERTAINING TO THE ABOVE CONTRACT AND PRESENT AT THE WORK SITE ALONG WITH ALL ACTIVE CONSTRUCTION PERMITS WHEN THE APPROVED WORK IS BEING PERFORMED.

- B. THE PERMITTEE MUST COMPLY WITH ALL CONSTRUCTION EMBARGOS ISSUED BY THE NYCDOT INCLUDING THE HOLIDAY EMBARGO.
- C. THE PERMITTEE SHALL COMPLY WITH ALL REQUIREMENTS OF THE NYCDOT SPECIAL EVENTS UNIT AS IDENTIFIED BELOW:
1. **STREET FAIRS / FESTIVALS**
 - ALL EXCAVATIONS MUST BE PLATED WITH SKID RESISTANT PLATES.
 - PLATES MUST BE RECESSED AND FLUSH WITH PAVEMENT.
 - ALL PAVEMENT DEFECTS MUST BE CORRECTED WITHIN OR ADJACENT TO THE WORK ZONE.
 - THE CONTRACTOR IS RESPONSIBLE FOR ANY DEFECTS WITHIN THE IMMEDIATE VICINITY IF NYCDOT STREET & ARTERIAL MAINTENANCE CANNOT MAKE REPAIRS DUE TO PROJECT INTERFERENCE (AS DETERMINED BY NYCDOT).
 - ALL EQUIPMENT, TRAILERS AND MATERIAL STORAGE MUST BE REMOVED.
 2. **RUNNING / WALKING / BIKING EVENTS**
 - ALL EXCAVATIONS MUST BE BACKFILLED AND PAVED OR PLATES MUST BE RECESSED AND PAVED OVER FLUSH WITH PAVEMENT.
 - ALL PAVEMENT DEFECTS MUST BE CORRECTED WITHIN OR ADJACENT TO THE WORK ZONE.
 - THE CONTRACTOR IS RESPONSIBLE FOR ANY DEFECTS WITHIN THE IMMEDIATE VICINITY IF NYCDOT STREET & ARTERIAL MAINTENANCE CANNOT MAKE REPAIRS DUE TO PROJECT INTERFERENCE (AS DETERMINED BY NYCDOT).
 - ALL EQUIPMENT, TRAILERS AND MATERIAL STORAGE MUST BE REMOVED.
 3. **PARADES**
 - ALL EXCAVATIONS MUST BE BACKFILLED AND PAVED OR PLATES MUST BE RECESSED AND PAVED OVER FLUSH WITH PAVEMENT.
 - FORMATION AND DISPERSAL AREA PLATES MUST BE RECESSED AND FLUSH WITH PAVEMENT (PLATES MUST BE SKID RESISTANT).
 - ALL PAVEMENT DEFECTS MUST BE CORRECTED WITHIN OR ADJACENT TO THE WORK ZONE.
 - THE CONTRACTOR IS RESPONSIBLE FOR ANY DEFECTS WITHIN THE IMMEDIATE VICINITY IF NYCDOT STREET & ARTERIAL MAINTENANCE CANNOT MAKE REPAIRS DUE TO PROJECT INTERFERENCE (AS DETERMINED BY NYCDOT).
 - ALL EQUIPMENT, TRAILERS AND MATERIAL STORAGE MUST BE REMOVED.
 4. **MAYORAL EVENTS**
 - ALL EXCAVATIONS MUST BE BACKFILLED AND PAVED OR PLATES MUST BE RECESSED AND PAVED OVER FLUSH WITH PAVEMENT.
 - ALL PAVEMENT DEFECTS MUST BE CORRECTED WITHIN OR ADJACENT TO THE WORK ZONE.
 - THE CONTRACTOR IS RESPONSIBLE FOR ANY DEFECTS WITHIN THE IMMEDIATE VICINITY IF NYCDOT STREET & ARTERIAL MAINTENANCE CANNOT MAKE REPAIRS DUE TO PROJECT INTERFERENCE (AS DETERMINED BY NYCDOT).
 - ALL EQUIPMENT, TRAILERS AND MATERIAL STORAGE MUST BE REMOVED.
- D. ALL RELOCATION WORK BY THE UTILITIES SUCH AS; CON EDISON, TELEPHONE, GAS AND CABLE COMPANIES SHALL PRECEDE THE PERMITTEE'S START OF WORK ON ALL AFFECTED ROADWAYS IN THE IMPACTED CONTRACT AREA.
- E. THE PERMITTEE IS ADVISED THAT OTHER CONTRACTORS MAY BE WORKING IN THE GENERAL AREA DURING THE TERM OF THIS STIPULATION. IN WHICH EVENT, THE PERMITTEE MAY REQUIRE MODIFICATIONS BY THE OCMC-STREETS.

- F. THE PERMITTEE IS NOT AUTHORIZED TO ENTER, OCCUPY OR USE ANY PUBLICLY-OWNED OR PRIVATELY OWNED, NON-PAVED, LANDSCAPE OR NON-LANDSCAPED LOCATION WITHOUT SPECIFIC WRITTEN PERMISSION. WHEN THE LOCATION IS WITHIN THE RIGHT-OF-WAY OF A LIMITED-ACCESS ARTERIAL HIGHWAY, **WRITTEN** APPROVAL FROM THE NYCDOT OCMC-HIGHWAYS IS REQUIRED. WHEN THE LOCATION IS WITHIN THE RIGHT-OF-WAY OF A PUBLIC STREET OR PUBLIC PARK, **WRITTEN** APPROVAL FROM THE NEW YORK CITY DEPARTMENT OF TRANSPORTATION OR NEW YORK CITY DEPARTMENT OF PARKS AND RECREATION IS REQUIRED. WHEN THE LOCATION IS WITHIN THE RIGHT-OF-WAY OF ANY OTHER JURISDICTION SUCH AS PRIVATE PROPERTY, STATE, FEDERAL ETC., IT IS THE PERMITTEE'S RESPONSIBILITY TO DETERMINE THE PROPERTY OWNER AND OBTAIN THE WRITTEN APPROVAL.
 - G. THE PERMITTEE SHALL ADHERE TO THE NYCDOT BUREAU OF BRIDGES' SPECIAL PROVISIONS FOR LANDSCAPE PROTECTION, MAINTENANCE AND RESTORATION, ITEMS 1.18.15 THROUGH 1.18.19, WHENEVER AND WHEREVER ANY OF THE PERMITTEE'S ACTIVITIES OCCUR WITHIN A LIMITED ACCESS ARTERIAL HIGHWAY RIGHT - OF - WAY.
 - H. NO DEVIATION OR DEPARTURE FROM THESE STIPULATIONS WILL BE PERMITTED WITHOUT THE PRIOR WRITTEN APPROVAL FROM THE OCMC-STREETS. REQUEST FOR SUCH MODIFICATIONS SHALL BE SUBMITTED TO THE OFFICE OF THE OCMC-STREETS, NEW YORK CITY DEPARTMENT OF TRANSPORTATION, A MINIMUM OF TWENTY (20) DAYS IN ADVANCE FOR CONSIDERATION.
 - I. FOR ANY CONSTRUCTION ACTIVITY RESULTING IN THE FULL CLOSURE OF A ROADWAY FOR MORE THAN 180 CONSECUTIVE CALENDAR DAYS, THE CONTRACTOR MUST PRODUCE AND SUBMIT A COMMUNITY REASSESSMENT, IMPACT AND AMELIORATION (CRIA) STATEMENT TO NYCDOT PLANNING AND OBTAIN THEIR APPROVAL BEFORE APPLYING FOR PERMITS, IN COMPLIANCE WITH THE PROVISIONS OF LOCAL LAW 24 STREET CLOSURE LAW.
 - J. FOR THIS PROJECT THE PERMITTEE SHALL FURNISH, INSTALL AND MAINTAIN ALL NECESSARY ADVANCE WARNING AND DETOUR SIGNS, TEMPORARY CONTROL DEVICES, BARRICADES, LIGHTS AND FLASHING ARROW BOARDS IN ACCORDANCE WITH THE "MANUAL ON UNIFORM TRAFFIC CONTROL DEVICES," THE TYPICAL SCHEMES INCLUDED IN THIS SPECIFICATION; AND AS ORDERED BY THE ENGINEER-IN-CHARGE AND THE OCMC-STREETS.
 - K. THE PERMITTEE SHALL BE RESPONSIBLE FOR IDENTIFYING HIS CONSTRUCTION SIGNAGE. THE IDENTIFICATION SHALL INCLUDE THE PERMITTEE'S NAME, SPONSORING AGENCY NAME AND THE CONTRACT NUMBER. THE IDENTIFICATION SHALL BE PLACED ON THE BACK OF THE SIGN. THE LETTERING SHALL BE THREE (3) INCHES HIGH.
 - L. THE OCMC-STREETS RESERVES THE RIGHT TO VOID OR MODIFY THESE STIPULATIONS SHOULD CONSTRUCTION FAIL TO COMMENCE WITHIN TWO (2) YEARS OF THE SIGNED DATE OF THESE STIPULATIONS.
-

NICOLAS DAGHER

NICOLAS DAGHER P.E.

EXECUTIVE DIRECTOR

OCMC

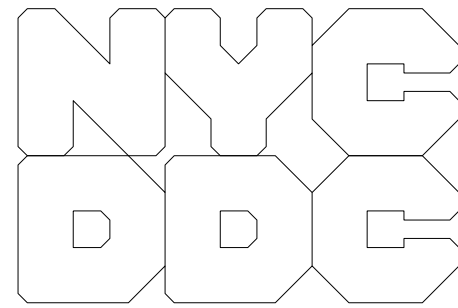

Department of Design and Construction

MAINTENANCE & PROTECTION OF TRAFFIC GUIDELINES (FOR STANDARD PEDESTRIAN RAMP & SIDEWALK CONTRACTS)

NOTES:

- 1- ITEMS IN COLUMN (2) WILL ONLY BE PAID IF THEY ARE FOUND IN THE BID SCHEDULE WITH THE EXCEPTION OF ADA COMPLIANT TEMPORARY PEDESTRIAN RAMP WHICH IS NOT A PAY ITEM.
- 2- IF ITEM NUMBER 6.70 (-G, -P, -R, -S), LUMP SUM IS IN THE BID SCHEDULE THEN ITEM NUMBERS IN COLUMN (2) WILL BE DEEMED INCLUDED IN THE PRICE OF ITEM NUMBER 6.70 (-G, -P, -R, -S).

NOVEMBER 2022











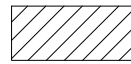

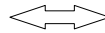
LEGEND (1)	ITEM NUMBER (2)
 CONSTRUCTION WORK AREA	
 FLASHING ARROW BOARD	9.99 (A, D, M, AD, AM) AS PER SITE CONDITIONS
 ONE WAY TRAFFIC (EXISTING)	
 TWO-WAY TRAFFIC (EXISTING)	
 NEW TRAFFIC DIRECTION DURING CONSTRUCTION	
 LIGHTED TIMBER BARRICADE	6.28AA
 TIMBER CURB (WITH ORANGE FENCING)	6.26
 PEDESTRIAN CHANNELIZER	7.35
 SURFACE APPLIED DETECTABLE WARNING UNITS (TEMPORARY)	4.13 DSAT
 PLASTIC BARRELS	6.87
 TEMPORARY SIGN WITH TEXT	6.25RS
 CROSSING GUARD	6.52 CG
 UNIFORMED FLAGPERSON (FEDERALLY FUNDED PROJECTS ONLY)	6.52 FED
 ADA COMPLIANT TEMPORARY PEDESTRIAN RAMP (SECTION 7.70 TPR)	NOT A PAY ITEM

TABLE OF CONTENTS (3)	PAGE NUMBER (4)
GENERAL NOTES	PR MPT 1
GENERAL NOTES - CONSTRUCTION OF NEW CURBS, SIDEWALKS AND RAMPS	PR MPT 2
TEMPORARY TRAFFIC SIGNS TABLE	PR MPT 3
CONSTRUCTION OF NEW PEDESTRIAN RAMPS: 4-WAY INTERSECTIONS ROAD WIDTH GREATER THAN OR EQUAL TO 30 FEET (2-WAY TRAFFIC) AND ROAD WIDTH GREATER THAN OR EQUAL TO 19 FEET (1-WAY TRAFFIC) (PROVIDE 5 FOOT WIDTH ADA COMPLIANT TEMPORARY PEDESTRIAN WALKWAY)	PR MPT 4
CONSTRUCTION OF NEW PEDESTRIAN RAMPS: 4-WAY INTERSECTIONS ROAD WIDTH LESS THAN 30 FEET (2-WAY TRAFFIC) OR ROAD WIDTH LESS THAN 19 FEET (1-WAY TRAFFIC)	PR MPT 5
CONSTRUCTION OF NEW PEDESTRIAN RAMPS: MID-BLOCK RAMPS ROAD WIDTH GREATER THAN OR EQUAL TO 30 FEET (2-WAY TRAFFIC) AND ROAD WIDTH GREATER THAN OR EQUAL TO 19 FEET (1-WAY TRAFFIC) (PROVIDE 5 FOOT WIDTH ADA COMPLIANT TEMPORARY PEDESTRIAN WALKWAY)	PR MPT 6
CONSTRUCTION OF NEW PEDESTRIAN RAMPS: MID-BLOCK RAMPS ROAD WIDTH LESS THAN 30 FEET (2-WAY TRAFFIC) OR ROAD WIDTH LESS THAN 19 FEET (1-WAY TRAFFIC)	PR MPT 7
CONSTRUCTION OF NEW PEDESTRIAN RAMPS: T- INTERSECTION ROAD WIDTH GREATER THAN OR EQUAL TO 30 FEET (2-WAY TRAFFIC) AND ROAD WIDTH GREATER THAN OR EQUAL TO 19 FEET (1-WAY TRAFFIC) (PROVIDE 5 FOOT WIDTH ADA COMPLIANT TEMPORARY PEDESTRIAN WALKWAY)	PR MPT 8
CONSTRUCTION OF NEW PEDESTRIAN RAMPS: T-INTERSECTION ROAD WIDTH LESS THAN 30 FEET (2-WAY TRAFFIC) OR ROAD WIDTH LESS THAN 19 FEET (1-WAY TRAFFIC)	PR MPT 9
CONSTRUCTION OF PEDESTRIAN RAMPS IN MEDIANS AND ISLANDS TEMPORARY PEDESTRIAN WALKWAY - WALKABLE MEDIAN	PR MPT 10
CONSTRUCTION OF PEDESTRIAN RAMPS IN MEDIANS AND ISLANDS FULL MEDIAN OR ISLAND CLOSURE	PR MPT 11
CONSTRUCTION OF NEW SIDEWALKS RESIDENTIAL AREA	SW MPT 12
CONSTRUCTION OF NEW SIDEWALKS COMMERCIAL & HIGH DENSITY PEDESTRIAN TRAFFIC AREA (PROVIDE 5 FOOT WIDTH ADA COMPLIANT TEMPORARY PEDESTRIAN WALKWAY)	SW MPT 13
CONSTRUCTION OF NEW SIDEWALKS COMMERCIAL & HIGH DENSITY PEDESTRIAN TRAFFIC AREA	SW MPT 14

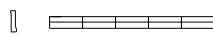
CITY OF NEW YORK
DEPARTMENT OF DESIGN AND CONSTRUCTION

MAINTENANCE AND PROTECTION OF TRAFFIC
GENERAL NOTES

GENERAL NOTES
APPLICABLE TO ALL STAGES

- 1. THESE GUIDELINES COVER THE MINIMUM REQUIREMENTS FOR A TYPICAL STREET INTERSECTION. THE ENGINEER RESERVES THE RIGHT TO REQUEST ADDITIONAL P.E. STAMPED MAINTENANCE AND PROTECTION OF TRAFFIC (MPT) PLANS ON A CASE-BY-CASE BASIS.
- 2. THE CONTRACTOR MUST NOTIFY THE DEPARTMENT OF TRANSPORTATION'S OFFICE OF CONSTRUCTION MITIGATION AND COORDINATION (O.C.M.C.) (TELEPHONE NO. 1-212-839-9621) AND THE DIVISION OF TRAFFIC OPERATIONS (TELEPHONE NO. 1-718-433-3370) AT LEAST 20 DAYS BEFORE THE START OF CONSTRUCTION TO SCHEDULE A PRE-CONSTRUCTION MEETING.
- 3. PRIOR TO ANY WORK PERMITS BEING ISSUED, A PRE-CONSTRUCTION MEETING WILL BE HELD TWENTY (20) DAYS IN ADVANCE BY DDC CONSTRUCTION. AT THAT TIME, THE CONTRACTOR MUST PROVIDE A CONSTRUCTION SCHEDULE TO THE ENGINEER. ARRANGEMENTS FOR THE MEETING WILL BE COORDINATED BY DDC CONSTRUCTION.
- 4. ADDITIONAL MPT DEVICES MAY BE REQUIRED. CONTRACTOR IS RESPONSIBLE FOR MAINTAINING MPT CONFORMING TO THE REQUIREMENTS OF THE ENGINEER, O.C.M.C., THE CONTRACT AND SPECIFICATIONS SET FORTH IN THE LATEST EDITION OF THE MANUAL ON UNIFORM TRAFFIC CONTROL DEVICES FOR STREETS AND HIGHWAYS (MUTCD).
 - CONSTRUCTION OF NEW CURBS
 - CONSTRUCTION OF NEW SIDEWALKS AND PEDESTRIAN RAMPS

THE CONTRACTOR MUST WAIT 24 HOURS AFTER THE POURING OF THE NEW CURBS BEFORE THE CONSTRUCTION OF NEW SIDEWALKS.
- 6. TO PERMIT ADEQUATE VISIBILITY AT INTERSECTION AREAS, ALL BARRICADES MUST BE PLACED SO AS NOT TO HINDER PEDESTRIAN OR VEHICULAR SIGHT LINES.
- 7. EXCAVATIONS MUST BE COMPLETELY ENCLOSED WITH TIMBER CURBS, LIGHTED BARRICADES, AND PEDESTRIAN CHANNELIZERS UNLESS OTHERWISE SHOWN HEREIN OR DIRECTED BY THE ENGINEER. ALL BOUNDARIES BETWEEN CONSTRUCTION WORK AREAS AND TEMPORARY PEDESTRIAN WALKWAYS IN THE ROAD MUST BE CLEARLY AND CONTINUOUSLY DELINEATED WITH ADA COMPLIANT PEDESTRIAN CHANNELIZERS AS SHOWN ON THE MPT PLANS AND AS APPROVED OR DIRECTED BY THE ENGINEER.
- 8. ALL INTERSECTIONS MUST BE OPEN TO TRAFFIC AFTER WORKING HOURS.
- 9. MAINTENANCE OF PEDESTRIAN ACCESS TO ALL ABUTTING PROPERTIES, ENTRANCES, AND EXITS FROM DWELLINGS, EMERGENCY EXITS AND PEDESTRIAN USAGE OF CROSSWALK AND SIDEWALK AREAS BOTH NEW AND EXISTING MUST BE CONTINUOUS AT ALL TIMES.
- 10. THE CONTRACTOR MUST PROVIDE ACCESS FOR EMERGENCY TRAFFIC, SCHOOL BUSES AND LOCAL TRAFFIC AT ALL TIMES UPON DEMAND. THE CONTRACTOR WILL BE REQUIRED TO MOVE AND RESTORE BARRICADES AS ORDERED BY THE ENGINEER FOR ACCESS AT NO COST TO THE CITY.
- 11. ALL SIGNS AND BARRICADES MUST CONFORM TO STANDARDS SPECIFIED IN THE NATIONAL "MANUAL OF UNIFORM TRAFFIC CONTROL DEVICES" (EXCEPT WHERE OTHERWISE REQUIRED HEREIN) WHERE APPLICABLE AND APPROVED BY THE ENGINEER.
- 12. ALL ADVANCE WARNING SIGNS MUST BE INSTALLED BETWEEN 150 AND 200 FEET BEFORE THE CONSTRUCTION ZONE. ALL "END ROAD WORK" SIGNS MUST BE INSTALLED 200 FEET AFTER THE CONSTRUCTION ZONE. TWO (2) 24"x24" ORANGE FLEXIBLE PLASTIC FLAGS MUST BE ATTACHED TO THE TWO SIDE CORNERS OF EACH DIAMOND SHAPED ADVANCE WARNING SIGN.

- 13. ALL IDENTIFICATION MARKINGS ON BARRELS MUST NOT FACE TRAFFIC AND MUST BE BELOW THE BOTTOM REFLECTORIZED BAND.
- 14. THE CONTRACTOR IS REQUIRED TO INSTALL TEMPORARY PAVEMENT MARKINGS AFTER THE EXISTING MARKINGS ARE REMOVED. THIS OPERATION MUST BE DONE ON THE SAME DAY. WHEN THE TEMPORARY MARKINGS ARE NO LONGER NECESSARY, THEY MUST BE OBLITERATED BY SCARIFICATION, UNTIL THEY ARE NO LONGER VISIBLE AT NO ADDITIONAL COST TO THE CITY.
- 15. THE CONTRACTOR MUST EMPLOY AND ASSIGN CROSSING GUARD/FLAGPERSON AT LOCATIONS SPECIFIED BY THE ENGINEER AND TRAFFIC ENFORCEMENT AGENTS WHEN STIPULATED BY O.C.M.C., TO ASSIST IN CONTROLLING THE FLOW OF TRAFFIC AS REQUIRED AND DIRECTED BY THE ENGINEER.
- 16. ALL CONTRACTOR'S VEHICLES, EQUIPMENT AND PERSONNEL MUST BE KEPT WITHIN THE DESIGNATED WORK AREAS.
- 17. NOTWITHSTANDING PROVISIONS HEREIN CONTAINED, IT REMAINS THE CONTRACTOR'S RESPONSIBILITY TO IMPLEMENT MINOR ADDITIONAL MEASURES THAT ARE NECESSARY TO PROVIDE FOR AND MAINTAIN THE SAFETY OF VEHICULAR TRAFFIC AND PEDESTRIANS DURING CONSTRUCTION. THE PROVISION AND USE OF SUPPLIES SUCH AS TRAFFIC CONES, HIGH VISIBILITY RIBBONS, AND FLAGS WHERE NECESSARY OR DIRECTED BY THE ENGINEER, WILL BE CONSIDERED AS MINOR AND INCIDENTAL ITEMS. PAYMENT TO BE INCLUDED IN THE PRICE BID FOR ALL SCHEDULED ITEMS.
- 18. PEDESTRIAN CHANNELIZATION DEVICES MUST BE PROVIDED BETWEEN PEDESTRIAN CIRCULATION PATHS AND WORK ZONES, WHEREVER PEDESTRIANS ARE DETOURED INTO THE ROADWAY. ALL PEDESTRIAN CHANNELIZATION DEVICES MUST BE ADA COMPLIANT AND MUST HAVE A CONTINUOUS DETECTABLE EDGE. THE USE OF CONES, PLASTIC BARRELS, STEEL PEDESTRIAN BARRICADES, OR CAUTION TAPE STRETCHED BETWEEN TRAFFIC CONTROL DEVICES ARE NOT ADEQUATE AND NOT ACCEPTABLE.
- 19. PEDESTRIAN DETOURS/TEMPORARY PEDESTRIAN WALKWAYS, FOR ALL STAGES IN CONSTRUCTION, MUST BE ACCESSIBLE AND MEET CURRENT ADA REQUIREMENTS.
- 20. AN ADA COMPLIANT TEMPORARY PEDESTRIAN RAMP MUST BE PROVIDED WHEN PEDESTRIANS ARE BEING DETOURED OFF THE SIDEWALK AND ONTO THE ROADWAY AND THERE IS NO EXISTING PEDESTRIAN RAMP OR IF EXISTING PEDESTRIAN RAMP IS NON-ADA COMPLIANT. NO PAYMENT WILL BE MADE FOR ADA COMPLIANT TEMPORARY PEDESTRIAN RAMP.
- 21. IT IS THE CONTRACTOR'S RESPONSIBILITY TO COORDINATE WITH OTHER CONTRACTORS WHO HAVE ON-GOING STREET IMPROVEMENT CONSTRUCTION IN THE AREA AND/OR WITHIN THE PROJECT LIMITS AND WILL ARRANGE THE PROJECT'S SCHEDULE OF CONSTRUCTION IN SUCH A TIME FRAME AS NOT TO DISRUPT OR INTERFERE WITH THE WORKABILITY OF EITHER MAINTENANCE OF TRAFFIC PLAN.
- 22. NO DEVIATION OR DEPARTURE FROM THE O.C.M.C. TRAFFIC STIPULATIONS WILL BE PERMITTED WITHOUT THE PRIOR WRITTEN APPROVAL FROM O.C.M.C. REQUEST FOR SUCH MODIFICATIONS MUST BE SUBMITTED TO O.C.M.C. A MINIMUM OF TWENTY (20) DAYS IN ADVANCE FOR CONSIDERATION.
- 23. THE CONTRACTOR MUST PROVIDE STORAGE AREAS OFF THE JOB SITE AS REQUIRED (NO SEPARATE PAYMENT). SEE NYC DEPARTMENT OF TRANSPORTATION (DOT) STANDARD DETAILS OF CONSTRUCTION DRAWING #H-1057 FOR MAINTENANCE OF TRAFFIC DEVICES REQUIRED AT THESE STORAGE AREAS.

- 24. PROVISIONS FOR BUSES AND PASSENGERS:
 - a. THE CONTRACTOR MUST MAINTAIN ACCESS TO AND EGRESS FROM BUSES AT ALL TIMES DURING EXECUTION OF THE WORK BY TEMPORARILY RELOCATING BUS STOPS AS DIRECTED AND APPROVED BY THE ENGINEER.
 - b. THE CONTRACTOR MUST NOT COMMENCE WORKING IN THE AREA OF ANY EXISTING BUS STOP UNTIL IT HAS BEEN TEMPORARILY RELOCATED AS DIRECTED AND APPROVED BY THE ENGINEER.
 - c. THE CONTRACTOR MUST KEEP THE AREA TO WHICH A BUS STOP IS RELOCATED FREE FROM AND UNDISTURBED BY ANY CONSTRUCTION ACTIVITY OR OTHER IMPEDIMENT DURING THE PERIOD OF IT'S USE AS A BUS STOP.
 - d. ADJUSTMENT TO BUS STOP NO STANDING, BUS LAYOVER, BUS PARKING SIGNS, OR ANY OTHER SUCH SIGNS AND SUPPORTS WHICH ARE LIKELY TO BE AFFECTED BY THE PROJECT AND/OR FOR CONFIRMING BUS STOP LOCATIONS FOR THE INSTALLATION OF NEW BUS PADS, NEW CURB CUTS, TREES, TREE PITS, FIRE HYDRANT, BIOSWALE ETC. WILL REQUIRE COORDINATION THROUGH:

TAJINDER JASSAL
DIRECTOR, BUS STOP MANAGEMENT GROUP
NYC DEPARTMENT OF TRANSPORTATION
58-50 57TH ROAD, ROOM # 209
MASPETH, NY 11378

BUS ROUTES AFFECTED BY THE PROJECT MAY REQUIRE BUS DIVERSIONS. ARRANGEMENTS WILL BE MADE THROUGH:

MS. SARAH WYSS
ACTING DIRECTOR, OPERATIONS PLANNING
NEW YORK CITY TRANSIT
2 BROADWAY, 17TH FLOOR
NEW YORK, NY 10004
646.252.5517

TEMPORARY RELOCATION OF BUS STOP SIGNS WILL INCLUDE:

CONTRACTOR WILL PAY A FEE PER BUS STOP TO NYC DOT TO RELOCATE BUS STOP SIGNS, BUS LAYOVER SIGNS, BUS PARKING SIGN OR RELATED POLES. CONTRACTOR MAY NOT REMOVE AND/OR BAG THE AFFECTED SIGNS AND POLES ABOVE. NO SEPARATE PAYMENT WILL BE MADE TO THE CONTRACTOR FOR THIS WORK.

THE INSTALLATION OF ONE "BUS STOP RELOCATED" SIGN (BLACK LETTERS ON ORANGE BACKGROUND) ON EXISTING POST, WITH THE FOLLOWING LEGEND:

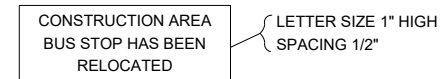

THE INSTALLATION OF ONE "BUS STOP RELOCATION" SIGN (BLACK LETTERS ON ORANGE BACKGROUND) WITH THE FOLLOWING LEGEND:

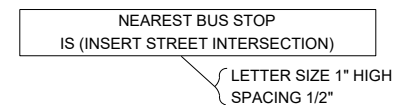

- e. THE CONTRACTOR MAY NOT WORK WITHIN AN AREA IN WHICH A BUS STOP HAS BEEN TEMPORARILY RELOCATED UNTIL REQUIRED WORK WITHIN THE AREA OF THE PERMANENT BUS STOP THEREOF HAS BEEN SUBSTANTIALLY COMPLETED INCLUDING TEMPORARY PAVEMENT RESTORATION, AND UNTIL THE AREA OF THE PERMANENT BUS STOP HAS BEEN RESTORED TO PUBLIC USE TO THE SATISFACTION AND APPROVAL OF THE ENGINEER.

- 25. THE CONTRACTOR IS REQUIRED TO MAINTAIN EXISTING BICYCLE FACILITIES WITH A SMOOTH RIDING SURFACE AND FREE OF DEBRIS OR OTHER OBSTRUCTIONS, AT ALL TIMES. IF THIS IS NOT POSSIBLE A TEMPORARY BICYCLE DETOUR PLAN MUST BE PREPARED BY THE CONTRACTOR AND SUBMITTED TO O.C.M.C. FOR APPROVAL.
- 26. FOR ANY CHANGES IN PARKING REGULATIONS DURING THE CONSTRUCTION, IT IS THE CONTRACTOR'S RESPONSIBILITY TO INSTALL, MAINTAIN AND RELOCATE THE EXISTING SIGNS, IN ACCORDANCE WITH O.C.M.C. STIPULATIONS OF ADVANCED NOTICE.
- 27. "NO STANDING" SIGNS TO BE INSTALLED WHERE REQUIRED AT LEAST TWENTY-FOUR (24) HOURS PRIOR TO THE START OF WORK IN EACH SECTION AND REMOVED WITHIN TWENTY- FOUR HOURS AFTER COMPLETION OF THE WORK IN THAT SECTION. ALL SIGNS MUST BE OBTAINED FROM NYC DOT.
- 28. ALL TEMPORARY SIGNS FOR PEDESTRIAN TRAFFIC ARE TO BE SECURED TO PEDESTRIAN STEEL BARRICADES OR PEDESTRIAN CHANNELIZERS.
- 29. ALL TEMPORARY SIGNS FOR VEHICULAR TRAFFIC ARE TO BE MOUNTED TO LAMPPOSTS OR ON CRASHWORTHY DUAL-SPRING SIGN STANDS PLACED ON THE ROAD. TEMPORARY SIGNS CANNOT BE MOUNTED ON PLASTIC BARRELS. TEMPORARY TRAFFIC SIGNS, INCLUDING THEIR SUPPORTS, MUST NOT IMPEDE PEDESTRIAN WALKWAY WIDTH.
- 30. THE CONTRACTOR WILL BE PERMITTED TO OCCUPY ONE TEN (10) FEET WIDE TRAFFIC LANE IMMEDIATELY ADJACENT TO THE CURB AS PART OF THE WORK AREA FOR CONDUCTING CONSTRUCTION OPERATIONS DURING WORK PERIODS. AS APPROVED AND DIRECTED BY THE ENGINEER.
- 31. THE CONTRACTOR MUST SUPPLY, INSTALL, RELOCATE AND MAINTAIN SIGNS AND OTHER APPROVED DEVICES FOR WARNING, CONTROLLING, ROUTING, DIRECTING AND DETOURING TRAFFIC AS INDICATED AND AS DIRECTED BY THE ENGINEER AND IN ACCORDANCE WITH "MANUAL ON UNIFORM TRAFFIC CONTROL DEVICES". THE EXACT LOCATION, SIZE, WORDING AND DETAILS OF THE SIGN, PLANTS AND MOUNTINGS, AND OTHER DEVICES WILL BE SUBJECT TO APPROVAL BY THE ENGINEER.
- 32. A MINIMUM FIVE (5) FOOT WIDE ADA COMPLIANT TEMPORARY PEDESTRIAN WALKWAY IS REQUIRED IF BOTH OF THE FOLLOWING CONDITIONS EXIST: STREET WIDTH GREATER THAN OR EQUAL TO THIRTY (30) FEET FOR A TWO-WAY STREET, AND STREET WIDTH GREATER THAN OR EQUAL TO NINETEEN (19) FEET FOR A ONE-WAY STREET.
- 33. IF A FIVE (5) FOOT WIDE ADA COMPLIANT TEMPORARY PEDESTRIAN WALKWAY IS REQUIRED AS PER GENERAL NOTE 32, THE CONTRACTOR MUST PROVIDE TWO (2) CROSSING GUARDS/UNIFORMED FLAGPERSON (ONE AT EACH CROSSWALK), ITEM NO. 6.52 CG/6.52 FED, WHEN HEAVY MACHINERY NEEDS TO ACCESS THE WORK AREA AND THE FIVE (5) FOOT WIDE TEMPORARY PEDESTRIAN WALKWAY CANNOT BE MAINTAINED AS APPROVED AND DIRECTED BY THE ENGINEER. THE SOLE PURPOSE OF THESE CROSSING GUARDS IS TO REDIRECT THE PEDESTRIANS SAFELY AROUND THE WORK AREA.

REVISED NOVEMBER 2022

MAINTENANCE AND PROTECTION OF TRAFFIC

GENERAL NOTES - CONSTRUCTION OF NEW CURBS, SIDEWALKS AND RAMPS

CONSTRUCTION OF NEW CURBS

1. THE CONTRACTOR MAY INITIALIZE THE CONSTRUCTION OF NEW CURBS IN A WORK AREA OF 200 FEET LONG ONLY. AFTER A SATISFACTORY START OF THE WORK, AS APPROVED AND DIRECTED BY THE ENGINEER, THE CONTRACTOR WILL BE PERMITTED TO EXTEND THE WORK AREA TO THE MAXIMUM LENGTH OF 600 FEET.
2. PLASTIC BARRELS OR TIMBER CURBS MAY BE USED TO DELINEATE THE WORK AREA AND THE ROADWAY AS SHOWN IN TYPICAL PLANS. PLASTIC BARRELS MAY NOT BE USED TO CHANNELIZE PEDESTRIANS. ONLY PEDESTRIAN CHANNELIZERS MAY BE USED TO CHANNELIZE/GUIDE PEDESTRIANS AS SHOWN IN TYPICAL PLANS AND AS DIRECTED AND APPROVED BY THE ENGINEER.
3. PLACE CONSTRUCTION SIGNS AS SHOWN IN TYPICAL PLANS AND AS DIRECTED BY THE ENGINEER.
4. MAINTAIN PEDESTRIAN CROSSING AT CORNERS AT ALL TIMES BY RELOCATING CROSSWALKS TO AREAS OF STRAIGHT CURB ADJACENT TO CORNERS UNDER CONSTRUCTION. ONLY ONE CORNER AT A TIME, PER INTERSECTION MAY BE CONSTRUCTED, EXCEPT AS OTHERWISE APPROVED BY THE ENGINEER. WORKING SIMULTANEOUSLY ON BOTH SIDES OF THE STREET WILL NOT BE PERMITTED. THE USE OF AN ADA COMPLIANT TEMPORARY PEDESTRIAN RAMP MAY BE REQUIRED AS PER GENERAL NOTE 20 ON SHEET PR MPT 1.
5. MAINTENANCE OF PEDESTRIAN ACCESS TO ALL ABUTTING PROPERTIES, ENTRANCES AND EXITS FROM DWELLINGS, EMERGENCY EXIT AREAS MUST BE CONTINUOUS AT ALL TIMES.
6. UPON COMPLETION OF CURB WORK AT EACH LOCATION THE CONTRACTOR MUST BACKFILL AROUND CURB AND PLACE 4" ASPHALTIC CONCRETE MIXTURE TO RESTORE STREET. RESTORE SIDEWALK WITH 2" ASPHALTIC CONCRETE MIXTURE AT CORNERS ONLY WHERE DIRECTED BY THE ENGINEER. SEE NYC DOT STANDARD DETAILS OF CONSTRUCTION DRAWING #H-1054. MAINTAIN PEDESTRIAN TRAFFIC AT CROSSWALK AREAS.
7. IF A TEMPORARY PEDESTRIAN WALKWAY IS NOT REQUIRED AS PER GENERAL NOTE 32 ON SHEET PR MPT 1, UPON COMPLETION OF EACH DAYS WORK THE CONTRACTOR MUST RELOCATE THE BARRELS AND BARRICADES ADJACENT TO THE CURB. THERE WILL BE NO DIRECT PAYMENT FOR THE DAILY RELOCATION OF BARREL AND BARRICADES HEREUNDER.

IF A TEMPORARY PEDESTRIAN WALKWAY IS REQUIRED AS PER GENERAL NOTE 32 ON SHEET PR MPT 1, UPON COMPLETION OF EACH DAYS WORK THE CONTRACTOR MUST PLACE THE MPT ITEMS AND TEMPORARY WALKWAY AS SHOWN IN TYPICAL PLANS. THERE WILL BE NO DIRECT PAYMENT FOR THE DAILY RELOCATION OF MPT ITEMS AND TEMPORARY WALKWAY.
8. EACH DAY THE WORK AREA MAY BE ADVANCED A MAXIMUM DISTANCE EQUAL TO THE LENGTH OF CURB SUBSTANTIALLY COMPLETED ON THAT DAY, WHICH WILL BE DEFINED AS INCLUDING TEMPORARY PAVEMENT RESTORATION, AS APPROVED BY THE ENGINEER.

CONSTRUCTION OF NEW SIDEWALKS AND PEDESTRIAN RAMPS

1. SIDEWALK CONSTRUCTION MUST PROCEED IMMEDIATELY UPON COMPLETION OF CURB AS DIRECTED BY THE ENGINEER.
2. THE CONTRACTOR MAY OCCUPY AND INSTALL PEDESTRIAN RAMPS AT A MAXIMUM OF ONE (1) CORNER OF ANY INTERSECTION AT A TIME.
3. IF A TEMPORARY PEDESTRIAN WALKWAY AROUND THE WORK AREA IS REQUIRED AS PER GENERAL NOTE 32 ON SHEET PR MPT 1, IT MUST BE PROVIDED WHEN THE SITE IS UNATTENDED.

IF ROAD WIDTH DOES NOT ALLOW FOR A TEMPORARY WALKWAY, THE CORNER IS TO REMAIN CLOSED TO PEDESTRIAN TRAFFIC AT ALL TIMES OR IF A FIVE (5) FOOT WIDE ADA COMPLIANT PEDESTRIAN WALKWAY CANNOT BE MAINTAINED, THE CONTRACTOR MUST CLOSE THE SIDEWALK AND DIVERT PEDESTRIANS AROUND THE WORK AREA AS INDICATED ON THE PLANS OR AS DIRECTED BY THE ENGINEER.
4. THE CONTRACTOR MUST PROVIDE MPT ITEMS AND WARNING SIGNS TO DELINEATE THE WORK AREAS AS SHOWN ON PLAN OR AS DIRECTED AND APPROVED BY THE ENGINEER.
5. SIDEWALK ADJACENT TO CORNER CURBS AND SIDEWALK ADJACENT TO STRAIGHT CURB MUST NOT BE DISTURBED SIMULTANEOUSLY WITHIN THE SAME BLOCK.
6. THE CONTRACTOR MUST PROVIDE ACCESS TO PRIVATE PROPERTY AT ALL TIMES BY FURNISHING AND INSTALLING PEDESTRIAN BRIDGES AS AND WHERE DIRECTED BY THE ENGINEER. ONCE ACCESS IS RESTORED TO THE PRIVATE PROPERTY, THE CONTRACTOR MUST REMOVE THE PEDESTRIAN BRIDGES.
7. THE CONTRACTOR MUST LIMIT THE EXTENT OF EXISTING SIDEWALK TO BE REMOVED EACH DAY TO THE SAME AREA OF CONCRETE SIDEWALK THAT WILL BE REPLACED THE FOLLOWING DAY. NO UNPROTECTED EXCAVATION MAY REMAIN AT THE END OF EACH DAY'S WORK.
8. THE CONTRACTOR WILL PROVIDE SMOOTH TRANSITION WITH ASPHALTIC CONCRETE MIXTURE BETWEEN SIDEWALK COMPLETED AND WORK YET TO BE STARTED.
9. THE CONTRACTOR MUST PROVIDE LOCAL PEDESTRIAN ACCESS AT ALL TIMES.
10. AFTER COMPLETING THE WORK IN THE SIDEWALK AREA THE CONTRACTOR MUST REMOVE ALL MPT ITEMS AND ALL SURPLUS CONSTRUCTION MATERIAL, AND MUST REOPEN THE SIDEWALK TO PEDESTRIAN TRAFFIC AS DIRECTED BY ENGINEER.

CITY OF NEW YORK
DEPARTMENT OF DESIGN AND CONSTRUCTION

MAINTENANCE AND PROTECTION OF TRAFFIC
TEMPORARY TRAFFIC SIGNS TABLE

TEMPORARY TRAFFIC SIGNS TABLE					
NAME	SIGN	MUTCD CODE	COLOR CODE	SIZE	DESCRIPTION
(A)		W20-1	A	36"X36"	ROAD WORK AHEAD
(B)		W20-2	A	36"X36"	DETOUR AHEAD
(C1)		M4-9	A	30"X24"	DETOUR (WITH ARROW)
(C2)		M4-9L	A	30"X24"	DETOUR (WITH LEFT ARROW)
(C3)		M4-9R	A	30"X24"	DETOUR (WITH RIGHT ARROW)
(DL)		W1-4	A	30"X30"	LARGE ARROW KEEP LEFT
(DR)		W1-4	A	30"X30"	LARGE ARROW KEEP RIGHT
(E)		R11-2	B	48"X30"	ROAD CLOSED
(F)		R11-3a	B	60"X30"	ROAD CLOSED (EXCEPT LOCAL & EMERGENCY TRAFFIC)
(GL)		W1-6L	A	48"X24"	ONE WAY (ARROW POINTING LEFT)
(GR)		W1-6R	A	48"X24"	ONE WAY (ARROW POINTING RIGHT)
(J)		CUSTOM	B	24"X12"	CROSSWALK CLOSED, USE OTHER SIDE
(K)		R9-11	B	24"X18"	SIDEWALK CLOSED AHEAD, CROSS HERE (WITH ARROW)
(L)		R9-10	B	24"X12"	SIDEWALK CLOSED, USE OTHER SIDE
(M)		R3-2	B	24"X24"	NO LEFT TURN
(N)		R3-1	B	24"X24"	NO RIGHT TURN
(O)		G20-2	A	36"X18"	END ROAD WORK
(P)		W6-3	A	36"X36"	TWO WAY TRAFFIC

TEMPORARY TRAFFIC SIGNS TABLE					
NAME	SIGN	MUTCD CODE	COLOR CODE	SIZE	DESCRIPTION
(Q)		W4-2L	A	36"X36"	LANE REDUCTION TRANSITION SIGN
		W4-2R	A	36"X36"	
(R)		R3-3	B	24"X24"	NO TURNS
(S)		W20-3	A	36"X36"	ROAD CLOSED AHEAD
(T)		M6-4	B	21"X15"	DOUBLE ARROW
(U)		CUSTOM COMBINATION	TOP C	TOP 12"X18"	TOP NO STANDING ANYTIME (WITH DOUBLE ARROW)
			BOTTOM A	BOTTOM 6"X18"	BOTTOM TEMPORARY CONSTRUCTION REGULATION
(V)		M6-1	B	21"X15"	ARROW (LEFT OR RIGHT)
(W)		R3-5	B	30"X36"	RIGHT (LEFT) TURN ONLY
(X)		R9-9	B	24"X12"	SIDEWALK CLOSED, USE WALKWAY
(Y)		W20-5	A	36"X36"	LANE CLOSED AHEAD
(Z)		W20-7a	A	36"X36"	CROSSING GUARD

COLOR CODE LEGEND	
CODE	DESCRIPTION
A	BLACK LEGEND AND BORDER ON AN ORANGE BACKGROUND
B	BLACK LEGEND AND BORDER ON A WHITE BACKGROUND
C	RED LEGEND AND BORDER ON A WHITE BACKGROUND
D	BLACK AND WHITE LEGEND AND BLACK BORDER ON AN ORANGE BACKGROUND

NOTES:

1. ALL SIGNS AS PER LATEST EDITION OF THE NATIONAL "MANUAL ON UNIFORM TRAFFIC CONTROL DEVICES" (MUTCD).
2. DIMENSIONS ARE SHOWN IN INCHES AND ARE SHOWN AS WIDTH x HEIGHT.
3. THESE TABLES ARE FOR REFERENCE PURPOSES ONLY. FOR ADDITIONAL SIGNAGE NOT SHOWN ON THESE TABLES REFER TO THE MUTCD.
4. ALL SIGNS TO BE REFLECTORIZED.
5. LETTERS ON SIGNS TO BE 5" HIGH.
6. SIGN LOCATION TO BE AS DIRECTED AND APPROVED BY THE ENGINEER.
7. MOUNTING OF SIGNS TO BE AS DIRECTED AND APPROVED BY THE ENGINEER.

CITY OF NEW YORK
DEPARTMENT OF DESIGN AND CONSTRUCTION

MAINTENANCE AND PROTECTION OF TRAFFIC
CONSTRUCTION OF NEW PEDESTRIAN RAMPS: 4-WAY INTERSECTIONS
ROAD WIDTH GREATER THAN OR EQUAL TO 30 FEET (2-WAY TRAFFIC) AND
ROAD WIDTH GREATER THAN OR EQUAL TO 19 FEET (1-WAY TRAFFIC)
(PROVIDE 5 FOOT WIDE ADA COMPLIANT TEMPORARY PEDESTRIAN WALKWAY)

**THIS MPT SKETCH IS SHOWING
THE UNATTENDED CONDITIONS**

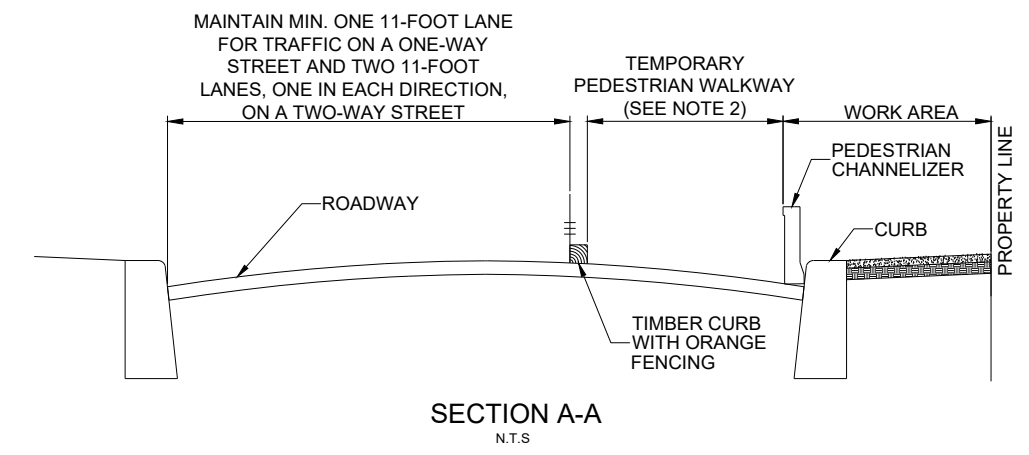
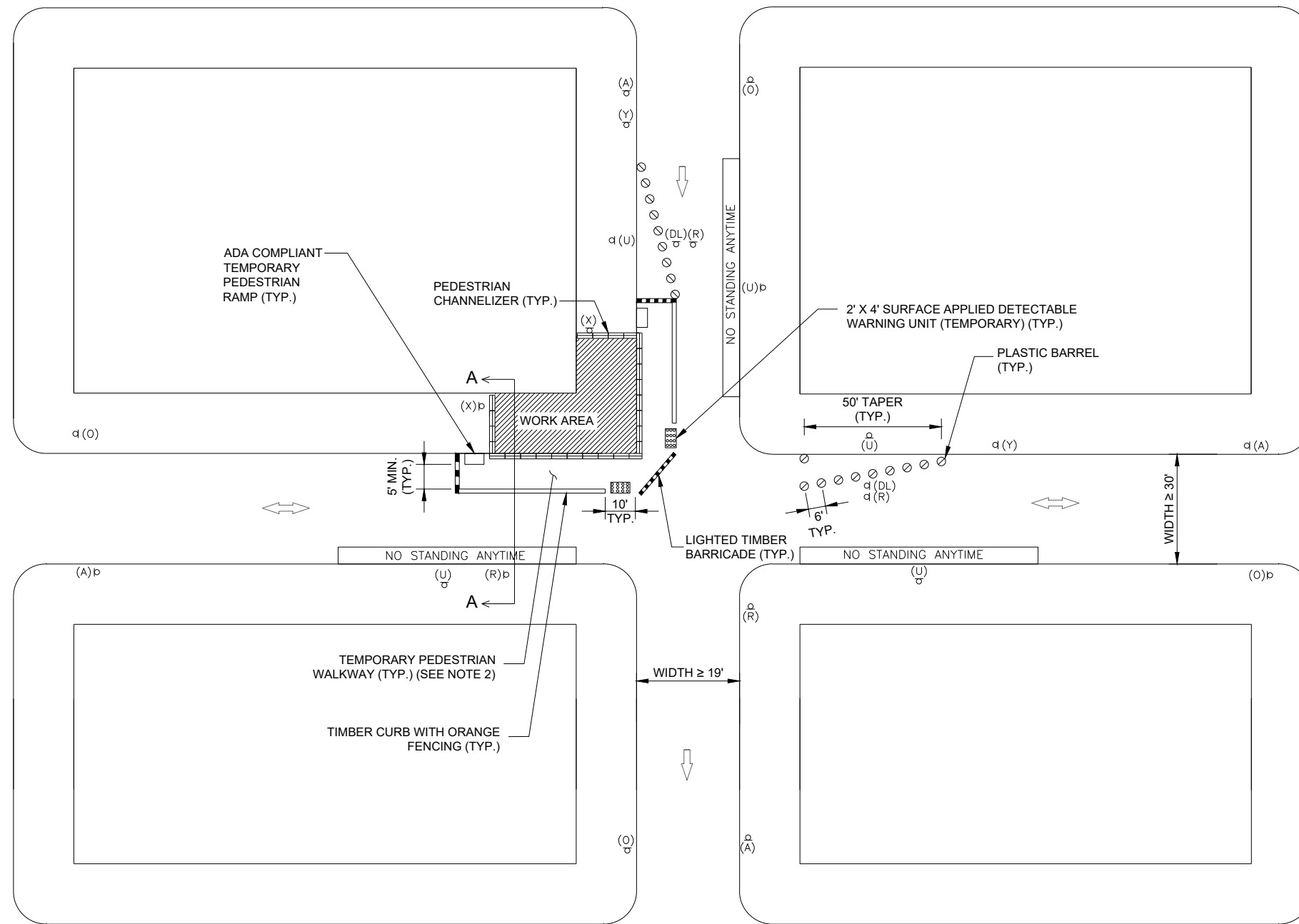

NOTES:

1. THE CONTRACTOR MAY OCCUPY A MAXIMUM OF ONE CORNER IN AN INTERSECTION AT ANY TIME.
2. IF A MINIMUM FIVE (5) FOOT WIDE ADA COMPLIANT TEMPORARY PEDESTRIAN WALKWAY IS REQUIRED AS PER GENERAL NOTE 32 ON SHEET PR MPT 1, WHEN THE SITE IS UNATTENDED A TEMPORARY PEDESTRIAN WALKWAY MUST BE PROVIDED IN THE ROADWAY AS SHOWN OR IN THE SIDEWALK.
3. IF THE SIDEWALK IS WIDER THAN FIFTEEN (15) FEET, THE CONTRACTOR MAY USE FIVE (5) FEET ALONG THE RIGHT-OF-WAY (R.O.W.) LINE AS A TEMPORARY PEDESTRIAN WALKWAY IF THAT PORTION OF THE SIDEWALK IS ADA COMPLIANT, AS DIRECTED AND APPROVED BY THE ENGINEER. IF BOTH CONDITIONS EXIST, THE CONTRACTOR MUST USE PEDESTRIAN CHANNELIZERS TO DELINEATE THE TEMPORARY PEDESTRIAN WALKWAY FROM THE WORK AREA. THE TEMPORARY TRAFFIC SIGNS AND OTHER MPT ITEMS LEADING UP TO THE WORK AREA MUST BE ADJUSTED IN ORDER TO GUIDE THE PEDESTRIAN PROPERLY.
4. TIMBER CURBS WITH ORANGE FENCING MUST BE INSTALLED WHEN THE SITE IS UNATTENDED. PLASTIC BARRELS MAY BE USED IN LIEU OF TIMBER CURBS WHEN THE SITE IS ATTENDED. WHEN PLASTIC BARRELS ARE USED IN LIEU OF TIMBER CURBS, PEDESTRIANS MUST NOT USE THE TEMPORARY PEDESTRIAN WALKWAY AND CROSSING GUARDS MUST BE PROVIDED BY THE CONTRACTOR AS PER GENERAL NOTE 33 ON SHEET PR MPT 1 TO GUIDE PEDESTRIANS SAFELY AROUND THE WORK AREA.
5. TEMPORARY SURFACE APPLIED DETECTABLE WARNING UNIT (DWS) TO BE REMOVED, AND ROADWAY TO BE RESTORED, WHEN CONSTRUCTION IS COMPLETED. NO ADDITIONAL PAYMENT FOR REPAIR OF THE ROADWAY FROM THE DAMAGE OF THE TEMPORARY DWS.
6. PLASTIC BARRELS, SIX (6) FEET ON CENTER, ARE REQUIRED TO SEPARATE LANES TRAVELING IN THE OPPOSITE DIRECTION WHENEVER TRAFFIC IS REDIRECTED PAST THE YELLOW PAVEMENT MARKINGS. (NOT SHOWN ON DRAWINGS)

TYPICAL PLAN
NOT TO SCALE

REVISED OCTOBER 2023

MAINTENANCE AND PROTECTION OF TRAFFIC

CONSTRUCTION OF NEW PEDESTRIAN RAMPS: 4-WAY INTERSECTIONS

ROAD WIDTH LESS THAN 30 FEET (2-WAY TRAFFIC) OR
ROAD WIDTH LESS THAN 19 FEET (1-WAY TRAFFIC)

**THIS MPT SKETCH IS SHOWING
THE ATTENDED CONDITIONS**

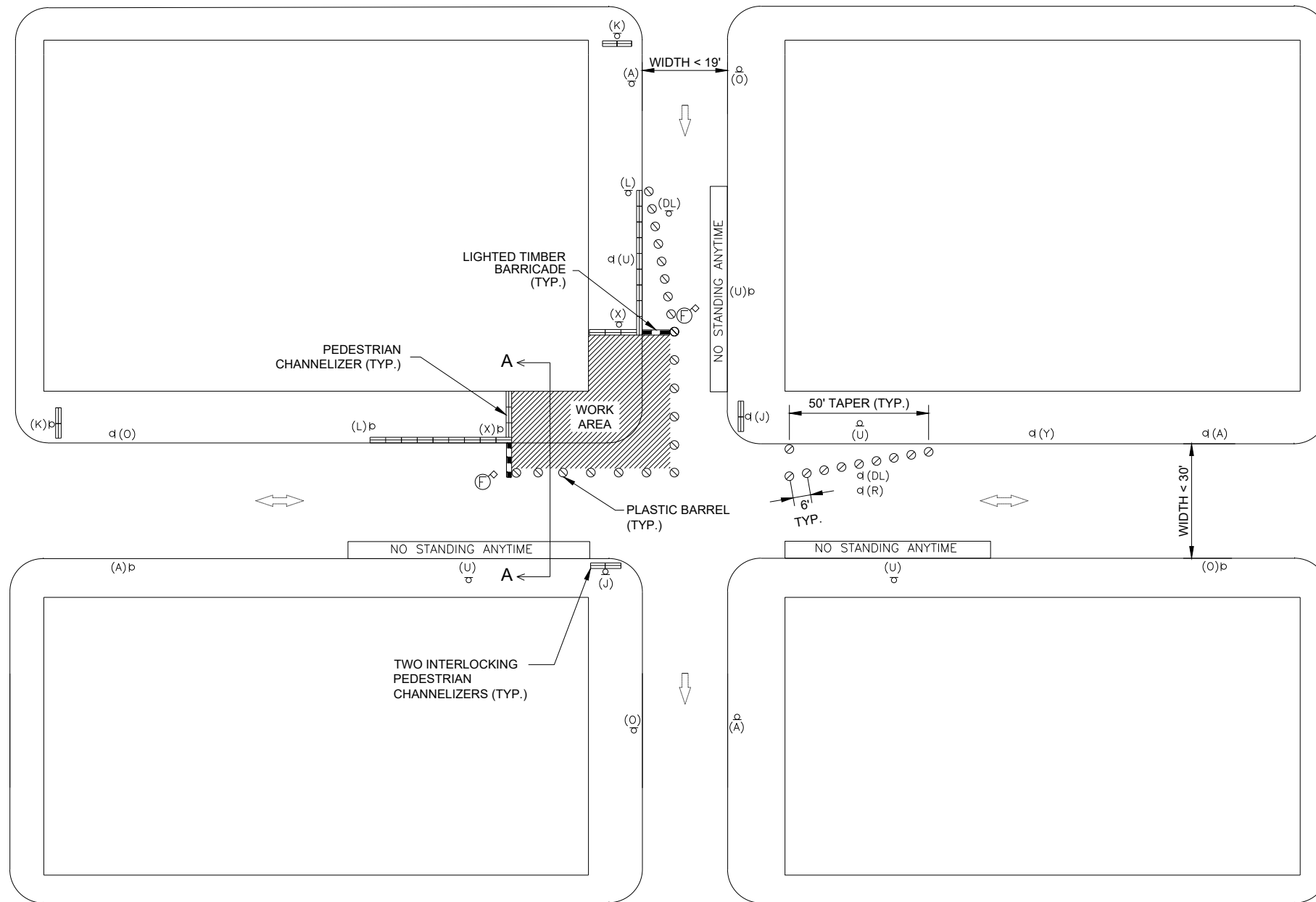

TYPICAL PLAN
NOT TO SCALE

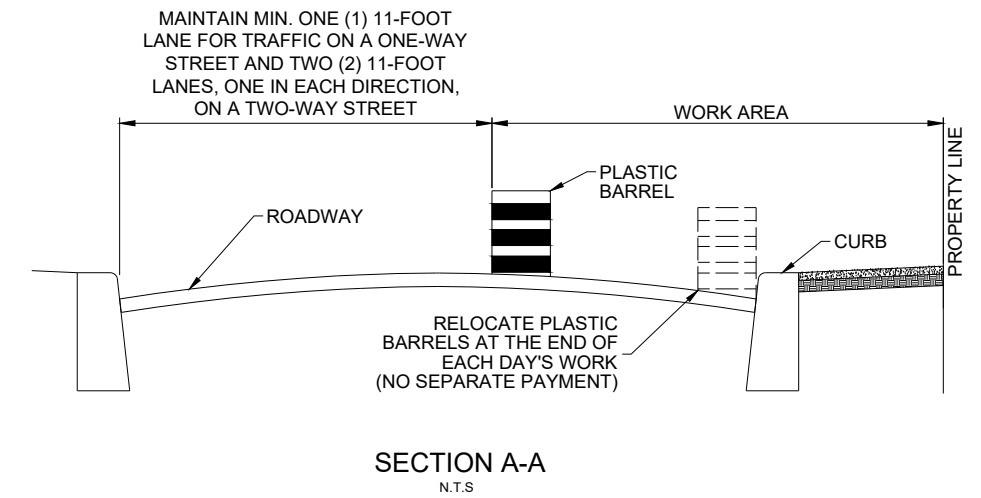

NOTES:

1. THE CONTRACTOR MAY OCCUPY A MAXIMUM OF ONE CORNER IN AN INTERSECTION AT ANY TIME.
2. IF THE SIDEWALK IS WIDER THAN FIFTEEN (15) FEET, THE CONTRACTOR MAY USE FIVE (5) FEET ALONG THE RIGHT-OF-WAY (R.O.W.) LINE AS A TEMPORARY PEDESTRIAN WALKWAY IF THAT PORTION OF THE SIDEWALK IS ADA COMPLIANT, AS DIRECTED AND APPROVED BY THE ENGINEER. IF BOTH CONDITIONS EXIST, THE CONTRACTOR MUST USE PEDESTRIAN CHANNELIZERS TO DELINEATE THE TEMPORARY PEDESTRIAN WALKWAY FROM THE WORK AREA. THE TEMPORARY TRAFFIC SIGNS AND OTHER MPT ITEMS LEADING UP TO THE WORK AREA MUST BE ADJUSTED IN ORDER TO GUIDE THE PEDESTRIAN PROPERLY.
3. AT THE END OF THE WORK DAY OR WHEN THE SITE IS LEFT UNATTENDED, BARRELS MUST BE PUSHED IN ALONG THE CURB. CORNER AND ADJACENT CROSSWALKS ARE TO REMAIN CLOSED TO PEDESTRIAN TRAFFIC.
4. PLASTIC BARRELS, SIX (6) FEET ON CENTER, ARE REQUIRED TO SEPARATE LANES TRAVELING IN THE OPPOSITE DIRECTION WHENEVER TRAFFIC IS REDIRECTED PAST THE YELLOW PAVEMENT MARKINGS. (NOT SHOWN ON DRAWINGS)

REVISED OCTOBER 2021

CITY OF NEW YORK
DEPARTMENT OF DESIGN AND CONSTRUCTION

MAINTENANCE AND PROTECTION OF TRAFFIC

CONSTRUCTION OF NEW PEDESTRIAN RAMPS: MID-BLOCK RAMPS

ROAD WIDTH GREATER THAN OR EQUAL TO 30 FEET (2-WAY TRAFFIC) AND

ROAD WIDTH GREATER THAN OR EQUAL TO 19 FEET (1-WAY TRAFFIC)

(PROVIDE 5 FOOT WIDE ADA COMPLIANT TEMPORARY PEDESTRIAN WALKWAY)

**THIS MPT SKETCH IS SHOWING
THE UNATTENDED CONDITIONS**

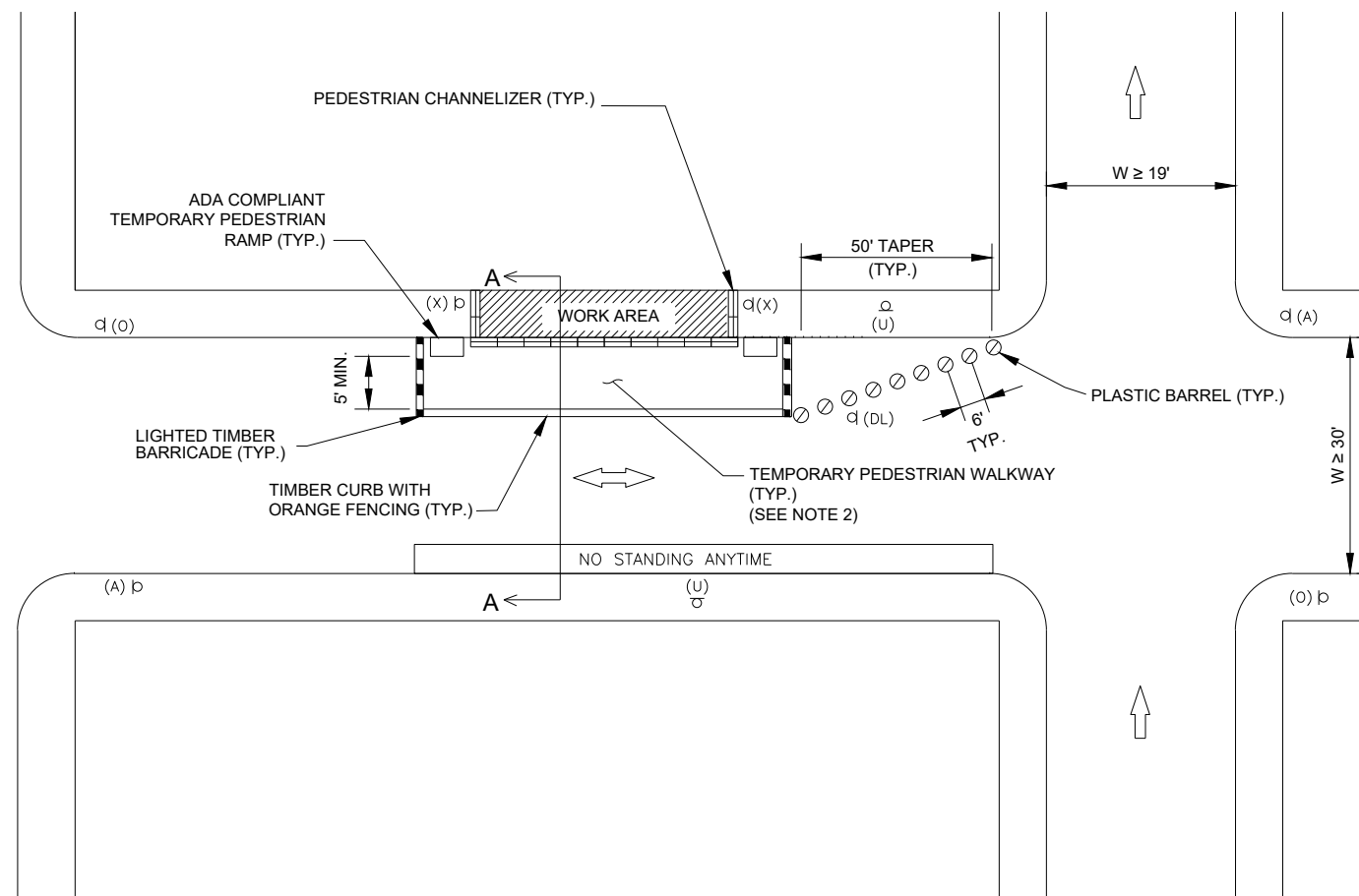

TYPICAL PLAN
NOT TO SCALE

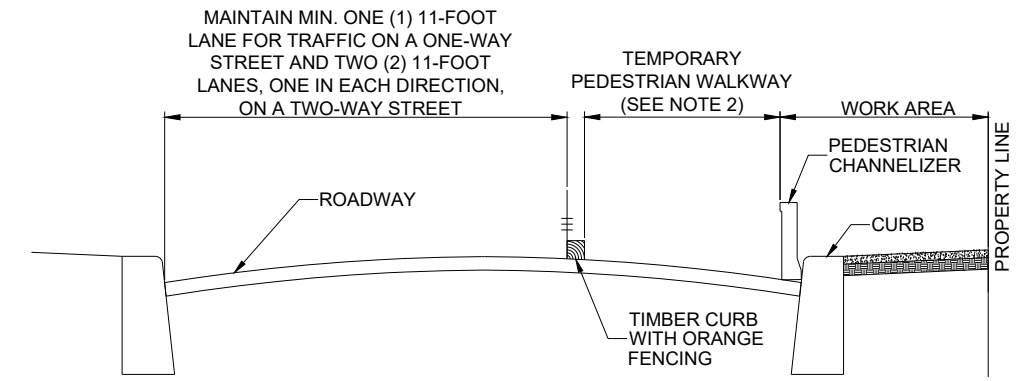

SECTION A-A
N.T.S

NOTES:

1. THE CONTRACTOR MAY OCCUPY A MAXIMUM OF ONE CORNER IN AN INTERSECTION AT ANY TIME.
2. IF A MINIMUM FIVE (5) FOOT WIDE ADA COMPLIANT TEMPORARY PEDESTRIAN WALKWAY IS REQUIRED AS PER GENERAL NOTE 32 ON SHEET PR MPT 1, WHEN THE SITE IS UNATTENDED A TEMPORARY PEDESTRIAN WALKWAY MUST BE PROVIDED IN THE ROADWAY AS SHOWN OR IN THE SIDEWALK.
3. IF THE SIDEWALK IS WIDER THAN FIFTEEN (15) FEET, THE CONTRACTOR MAY USE FIVE (5) FEET ALONG THE RIGHT-OF-WAY (R.O.W.) LINE AS A TEMPORARY PEDESTRIAN WALKWAY IF THAT PORTION OF THE SIDEWALK IS ADA COMPLIANT, AS DIRECTED AND APPROVED BY THE ENGINEER. IF BOTH CONDITIONS EXIST, THE CONTRACTOR MUST USE PEDESTRIAN CHANNELIZERS TO DELINEATE THE TEMPORARY PEDESTRIAN WALKWAY FROM THE WORK AREA. THE TEMPORARY TRAFFIC SIGNS AND OTHER MPT ITEMS LEADING UP TO THE WORK AREA MUST BE ADJUSTED IN ORDER TO GUIDE THE PEDESTRIAN PROPERLY.
4. TIMBER CURBS WITH ORANGE FENCING MUST BE INSTALLED WHEN THE SITE IS UNATTENDED. PLASTIC BARRELS MAY BE USED IN LIEU OF TIMBER CURBS WHEN THE SITE IS ATTENDED. WHEN PLASTIC BARRELS ARE USED IN LIEU OF TIMBER CURBS, PEDESTRIANS MUST NOT USE THE TEMPORARY PEDESTRIAN WALKWAY AND CROSSING GUARDS MUST BE PROVIDED BY THE CONTRACTOR AS PER GENERAL NOTE 33 ON SHEET PR MPT 1 TO GUIDE PEDESTRIANS SAFELY AROUND THE WORK AREA.
5. PLASTIC BARRELS, SIX (6) FEET ON CENTER, ARE REQUIRED TO SEPARATE LANES TRAVELING IN THE OPPOSITE DIRECTION WHENEVER TRAFFIC IS REDIRECTED PAST THE YELLOW PAVEMENT MARKINGS. (NOT SHOWN ON DRAWINGS)

REVISED OCTOBER 2023

CITY OF NEW YORK
DEPARTMENT OF DESIGN AND CONSTRUCTION

MAINTENANCE AND PROTECTION OF TRAFFIC

CONSTRUCTION OF NEW PEDESTRIAN RAMPS: MID-BLOCK RAMPS

ROAD WIDTH LESS THAN 30 FEET (2-WAY TRAFFIC) OR
ROAD WIDTH LESS THAN 19 FEET (1-WAY TRAFFIC)

**THIS MPT SKETCH IS SHOWING
THE ATTENDED CONDITIONS**

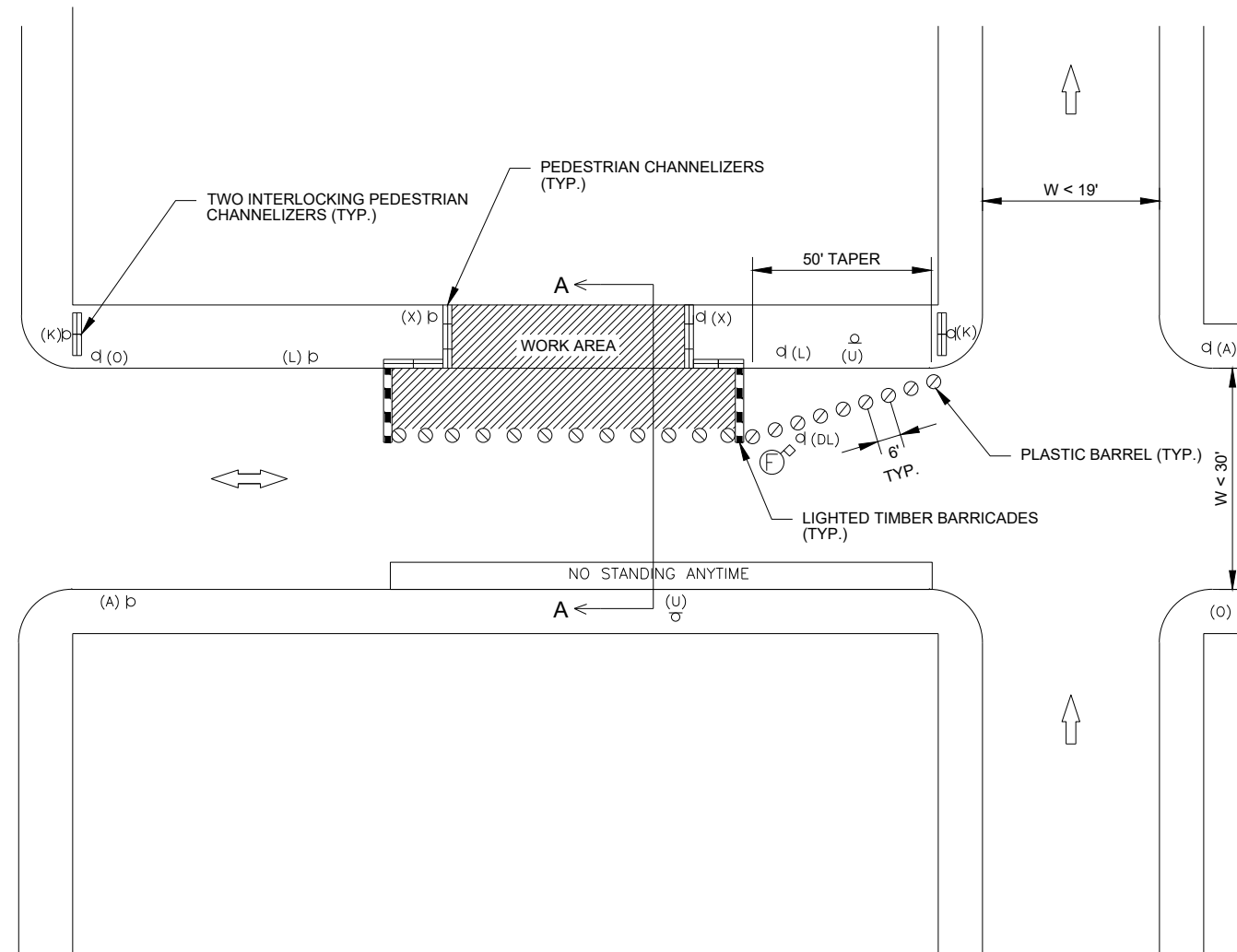

TYPICAL PLAN
NOT TO SCALE

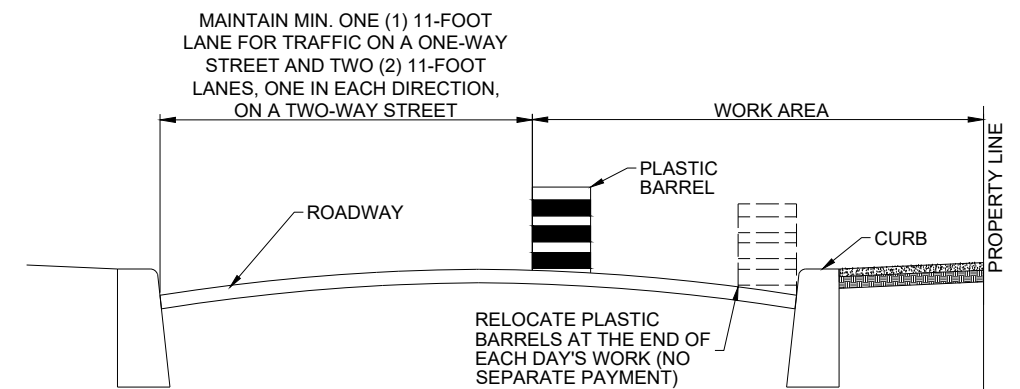

SECTION A-A
N.T.S

NOTES:

1. THE CONTRACTOR MAY WORK AT A MAXIMUM OF ONE MID-BLOCK RAMP AT ANY TIME ON ANY STREET.
2. IF THE SIDEWALK IS WIDER THAN FIFTEEN (15) FEET, THE CONTRACTOR MAY USE FIVE (5) FEET ALONG THE RIGHT-OF-WAY (R.O.W.) LINE AS A TEMPORARY PEDESTRIAN WALKWAY IF THAT PORTION OF THE SIDEWALK IS ADA COMPLIANT, AS DIRECTED AND APPROVED BY THE ENGINEER. IF BOTH CONDITIONS EXIST, THE CONTRACTOR MUST USE PEDESTRIAN CHANNELIZERS TO DELINEATE THE TEMPORARY PEDESTRIAN WALKWAY FROM THE WORK AREA. THE TEMPORARY TRAFFIC SIGNS AND OTHER MPT ITEMS LEADING UP TO THE WORK AREA MUST BE ADJUSTED IN ORDER TO GUIDE THE PEDESTRIAN PROPERLY.
3. PLASTIC BARRELS, SIX (6) FEET ON CENTER, ARE REQUIRED TO SEPARATE LANES TRAVELING IN THE OPPOSITE DIRECTION WHENEVER TRAFFIC IS REDIRECTED PAST THE YELLOW PAVEMENT MARKINGS. (NOT SHOWN IN DRAWINGS)

REVISED OCTOBER 2021

CITY OF NEW YORK
DEPARTMENT OF DESIGN AND CONSTRUCTION

MAINTENANCE AND PROTECTION OF TRAFFIC

CONSTRUCTION OF NEW PEDESTRIAN RAMPS: T-INTERSECTION

ROAD WIDTH GREATER THAN OR EQUAL TO 30 FEET (2-WAY TRAFFIC) AND

ROAD WIDTH GREATER THAN OR EQUAL TO 19 FEET (1-WAY TRAFFIC)

(PROVIDE 5 FOOT WIDE ADA COMPLIANT TEMPORARY PEDESTRIAN WALKWAY)

THIS MPT SKETCH IS SHOWING THE UNATTENDED CONDITIONS

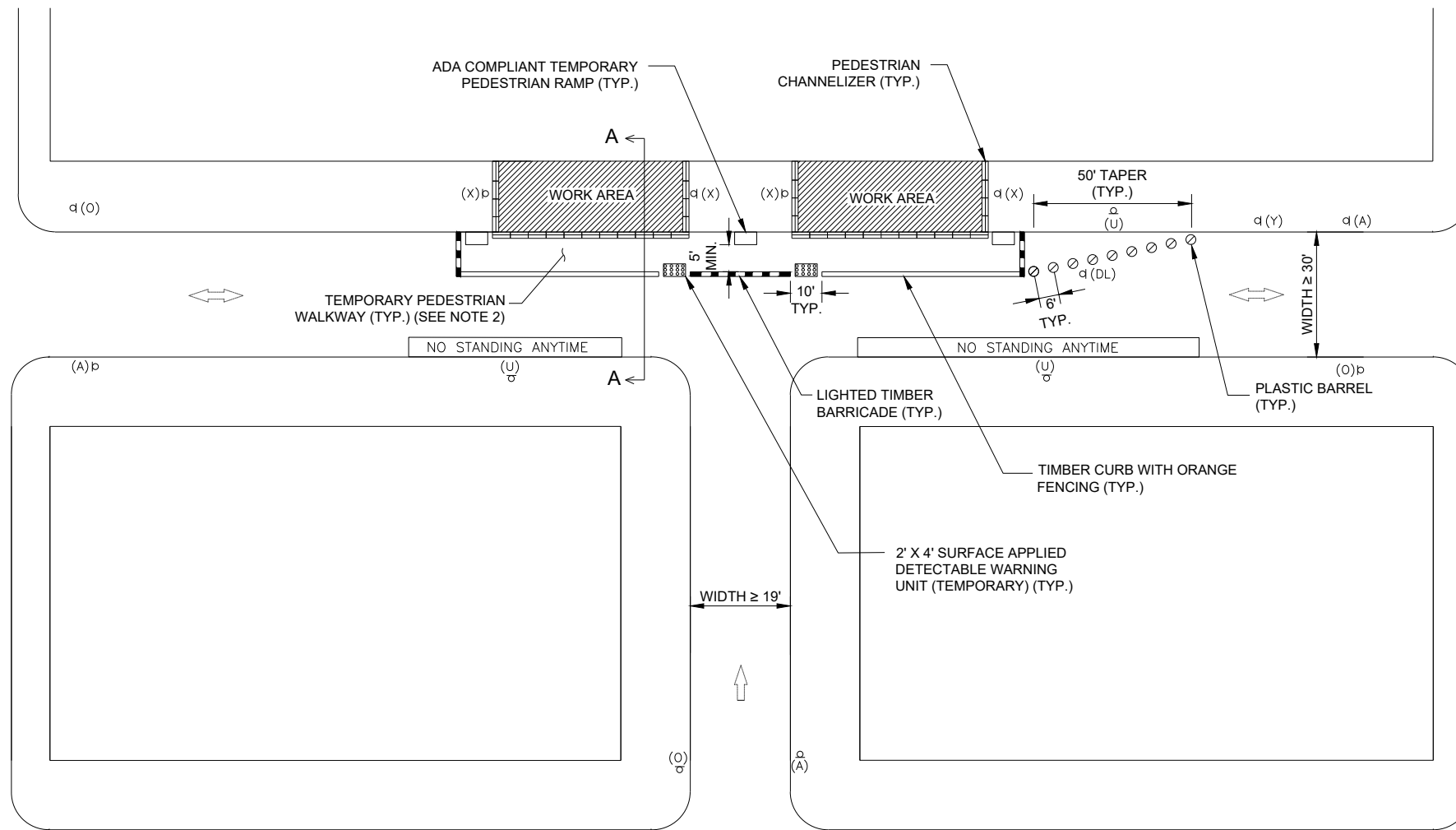

TYPICAL PLAN
NOT TO SCALE

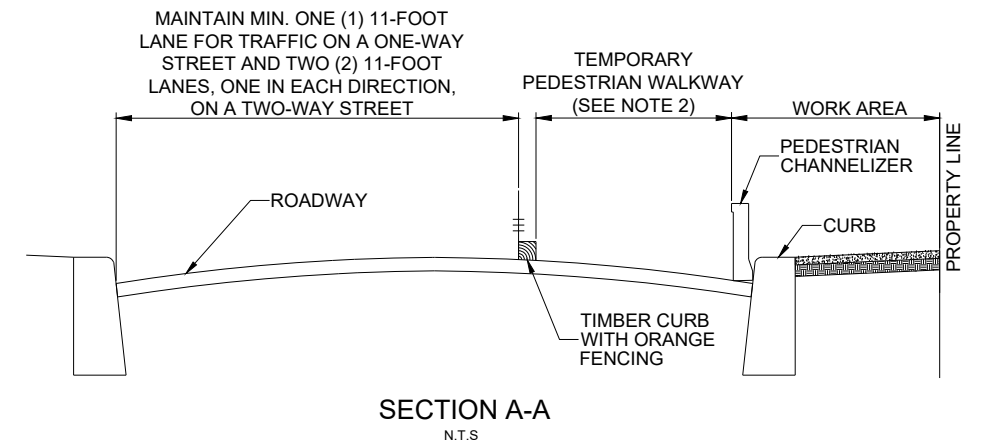

NOTES:

1. THE CONTRACTOR MAY WORK AT 2 CORNERS SIMULTANEOUSLY AT THE TOP OF THE T-INTERSECTION ONLY.
2. IF A MINIMUM FIVE (5) FOOT WIDE ADA COMPLIANT TEMPORARY PEDESTRIAN WALKWAY IS REQUIRED AS PER GENERAL NOTE 32 ON SHEET PR MPT 1, WHEN THE SITE IS UNATTENDED A TEMPORARY PEDESTRIAN WALKWAY MUST BE PROVIDED IN THE ROADWAY AS SHOWN OR IN THE SIDEWALK.
3. IF THE SIDEWALK IS WIDER THAN FIFTEEN (15) FEET, THE CONTRACTOR MAY USE FIVE (5) FEET ALONG THE RIGHT-OF-WAY (R.O.W.) LINE AS A TEMPORARY PEDESTRIAN WALKWAY IF THAT PORTION OF THE SIDEWALK IS ADA COMPLIANT, AS DIRECTED AND APPROVED BY THE ENGINEER. IF BOTH CONDITIONS EXIST, THE CONTRACTOR MUST USE PEDESTRIAN CHANNELIZERS TO DELINEATE THE TEMPORARY PEDESTRIAN WALKWAY FROM THE WORK AREA. THE TEMPORARY TRAFFIC SIGNS AND OTHER MPT ITEMS LEADING UP TO THE WORK AREA MUST BE ADJUSTED IN ORDER TO GUIDE THE PEDESTRIAN PROPERLY.
4. TIMBER CURBS WITH ORANGE FENCING MUST BE INSTALLED WHEN THE SITE IS UNATTENDED. PLASTIC BARRELS MAY BE USED IN LIEU OF TIMBER CURBS WHEN THE SITE IS ATTENDED. WHEN PLASTIC BARRELS ARE USED IN LIEU OF TIMBER CURBS, PEDESTRIANS MUST NOT USE THE TEMPORARY PEDESTRIAN WALKWAY AND CROSSING GUARDS MUST BE PROVIDED BY THE CONTRACTOR AS PER GENERAL NOTE 33 ON SHEET PR MPT 1 TO GUIDE PEDESTRIANS SAFELY AROUND THE WORK AREA.
5. TEMPORARY SURFACE APPLIED DETECTABLE WARNING UNIT (DWS) TO BE REMOVED, AND ROADWAY TO BE RESTORED, WHEN CONSTRUCTION IS COMPLETED. NO ADDITIONAL PAYMENT FOR REPAIR OF THE ROADWAY FROM THE DAMAGE OF THE TEMPORARY DWS.
6. PLASTIC BARRELS, SIX (6) FEET ON CENTER, ARE REQUIRED TO SEPARATE LANES TRAVELING IN THE OPPOSITE DIRECTION WHENEVER TRAFFIC IS REDIRECTED PAST THE YELLOW PAVEMENT MARKINGS. (NOT SHOWN ON DRAWINGS)

CITY OF NEW YORK
DEPARTMENT OF DESIGN AND CONSTRUCTION

MAINTENANCE AND PROTECTION OF TRAFFIC
CONSTRUCTION OF NEW PEDESTRIAN RAMPS: T-INTERSECTION
ROAD WIDTH LESS THAN 30 FEET (2-WAY TRAFFIC) OR
ROAD WIDTH LESS THAN 19 FEET (1-WAY TRAFFIC)

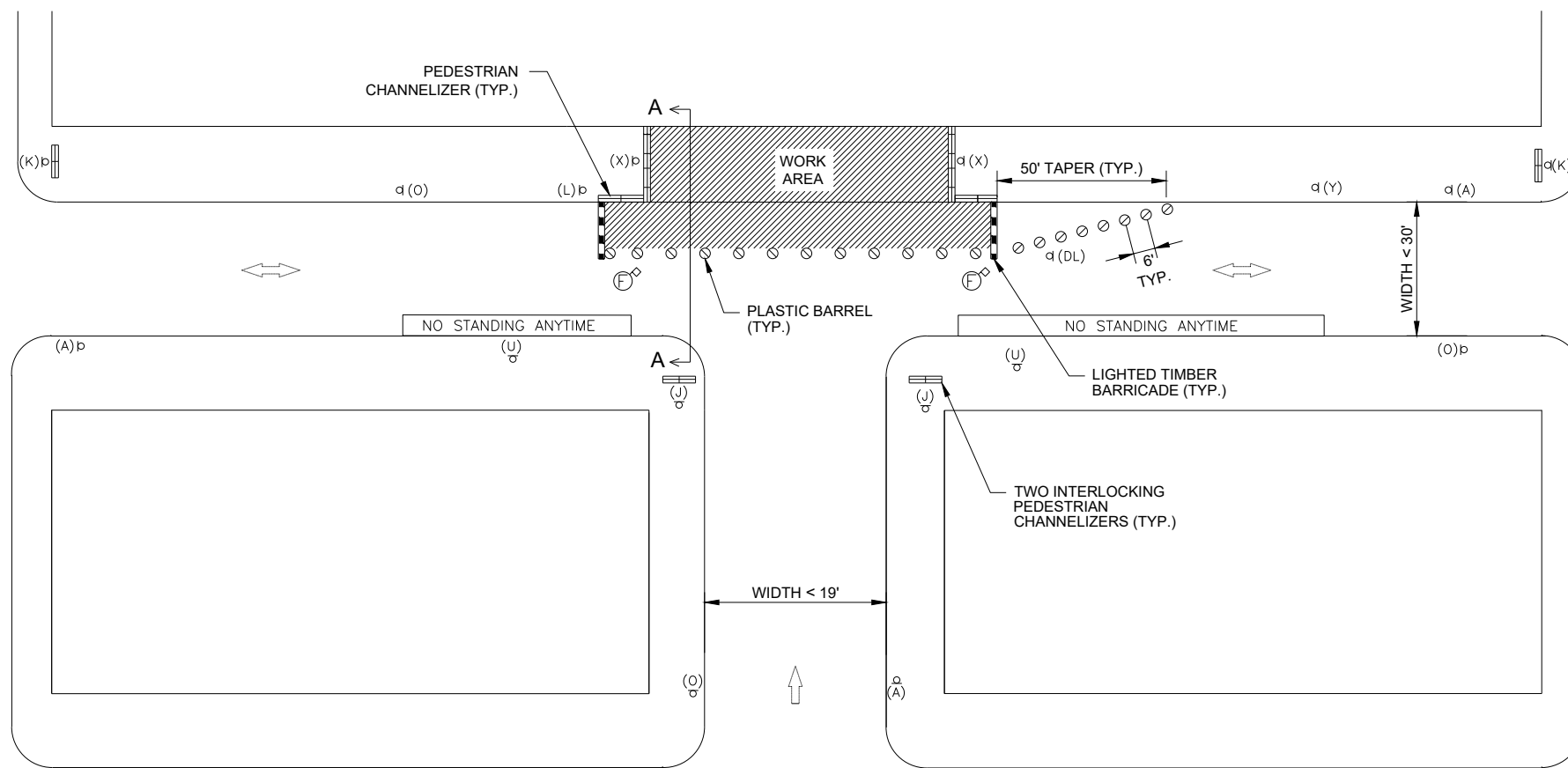

TYPICAL PLAN
NOT TO SCALE

**THIS MPT SKETCH IS SHOWING
THE ATTENDED CONDITIONS**

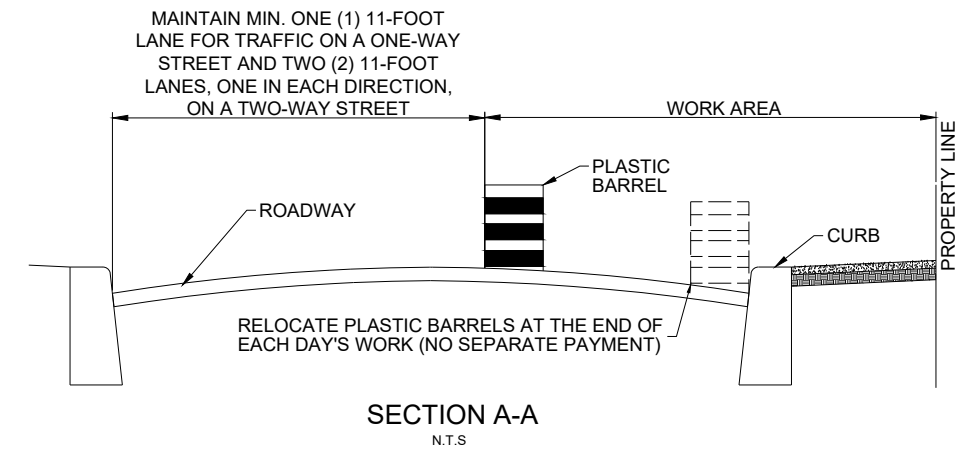

NOTES:

1. THE CONTRACTOR MAY WORK AT 2 CORNERS SIMULTANEOUSLY AT THE TOP OF THE T-INTERSECTION ONLY.
2. IF THE SIDEWALK IS WIDER THAN FIFTEEN (15) FEET, THE CONTRACTOR MAY USE FIVE (5) FEET ALONG THE RIGHT-OF-WAY (R.O.W.) LINE AS A TEMPORARY PEDESTRIAN WALKWAY IF THAT PORTION OF THE SIDEWALK IS ADA COMPLIANT, AS DIRECTED AND APPROVED BY THE ENGINEER. IF BOTH CONDITIONS EXIST, THE CONTRACTOR MUST USE PEDESTRIAN CHANNELIZERS TO DELINEATE THE TEMPORARY PEDESTRIAN WALKWAY FROM THE WORK AREA. THE TEMPORARY TRAFFIC SIGNS AND OTHER MPT ITEMS LEADING UP TO THE WORK AREA MUST BE ADJUSTED IN ORDER TO GUIDE THE PEDESTRIAN PROPERLY.
3. AT THE END OF THE WORK DAY OR WHEN THE SITE IS LEFT UNATTENDED, BARRELS MUST BE PUSHED IN ALONG THE CURB. CORNER AND ADJACENT CROSSWALKS ARE TO REMAIN CLOSED TO PEDESTRIAN TRAFFIC.
4. PLASTIC BARRELS, SIX (6) FEET ON CENTER, ARE REQUIRED TO SEPARATE LANES TRAVELING IN THE OPPOSITE DIRECTION WHENEVER TRAFFIC IS REDIRECTED PAST THE YELLOW PAVEMENT MARKINGS. (NOT SHOWN ON DRAWINGS)

MAINTENANCE AND PROTECTION OF TRAFFIC

CONSTRUCTION OF PEDESTRIAN RAMPS IN MEDIANS AND ISLANDS

TEMPORARY PEDESTRIAN WALKWAY - WALKABLE MEDIAN

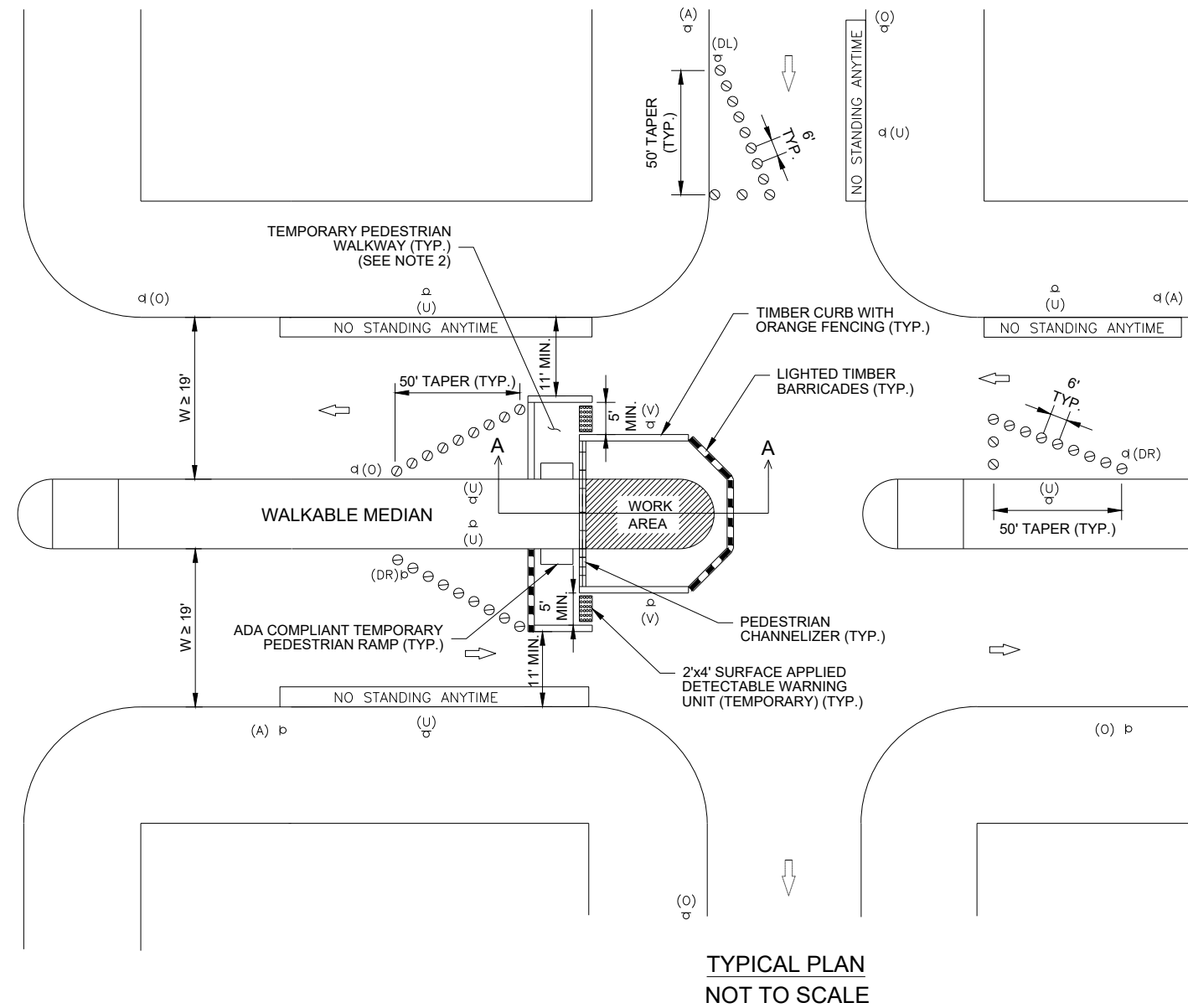

THIS MPT SKETCH IS SHOWING THE UNATTENDED CONDITIONS

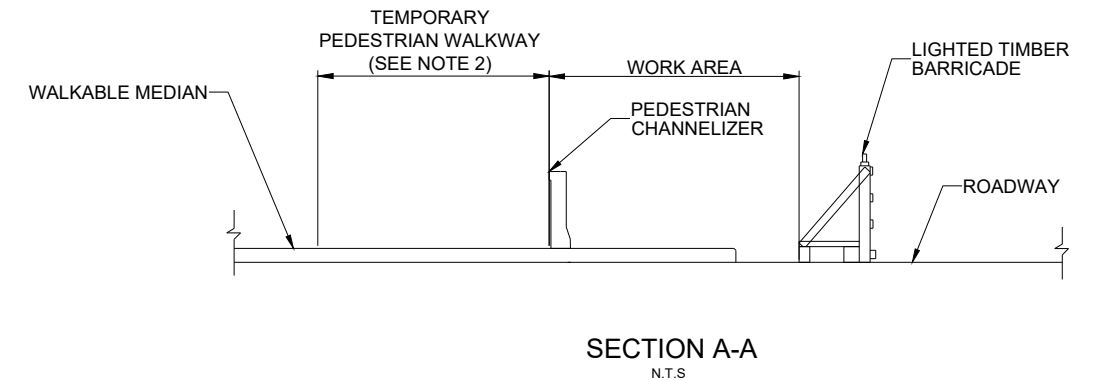

NOTES:

1. THE CONTRACTOR MAY OCCUPY A MAXIMUM OF ONE CORNER OR MEDIAN IN AN INTERSECTION AT ANY TIME.
2. IF A MINIMUM FIVE (5) FOOT WIDE ADA COMPLIANT TEMPORARY PEDESTRIAN WALKWAY IS REQUIRED AS PER GENERAL NOTE 32 ON SHEET PR MPT 1, WHEN THE SITE IS UNATTENDED A TEMPORARY PEDESTRIAN WALKWAY MUST BE PROVIDED IN THE ROADWAY AS SHOWN.
3. TIMBER CURBS WITH ORANGE FENCING MUST BE INSTALLED WHEN THE SITE IS UNATTENDED. PLASTIC BARRELS MAY BE USED IN LIEU OF TIMBER CURBS WHEN THE SITE IS ATTENDED. WHEN PLASTIC BARRELS ARE USED IN LIEU OF TIMBER CURBS, PEDESTRIANS MUST NOT USE THE TEMPORARY PEDESTRIAN WALKWAY AND CROSSING GUARDS MUST BE PROVIDED BY THE CONTRACTOR AS PER GENERAL NOTE 33 ON SHEET PR MPT 1 TO GUIDE PEDESTRIANS SAFELY AROUND THE WORK AREA.
4. TEMPORARY SURFACE APPLIED DETECTABLE WARNING UNIT (DWS) TO BE REMOVED, AND ROADWAY TO BE RESTORED, WHEN CONSTRUCTION IS COMPLETED. NO ADDITIONAL PAYMENT FOR REPAIR OF THE ROADWAY FROM THE DAMAGE OF THE TEMPORARY DWS.
5. PLASTIC BARRELS, SIX (6) FEET ON CENTER, ARE REQUIRED TO SEPARATE LANES TRAVELING IN THE OPPOSITE DIRECTION WHENEVER TRAFFIC IS REDIRECTED PAST THE YELLOW PAVEMENT MARKINGS. (NOT SHOWN ON DRAWINGS)

MAINTENANCE AND PROTECTION OF TRAFFIC

CONSTRUCTION OF PEDESTRIAN RAMPS IN MEDIANS AND ISLANDS

FULL MEDIAN OR ISLAND CLOSURE

THIS MPT SKETCH IS SHOWING THE ATTENDED CONDITIONS

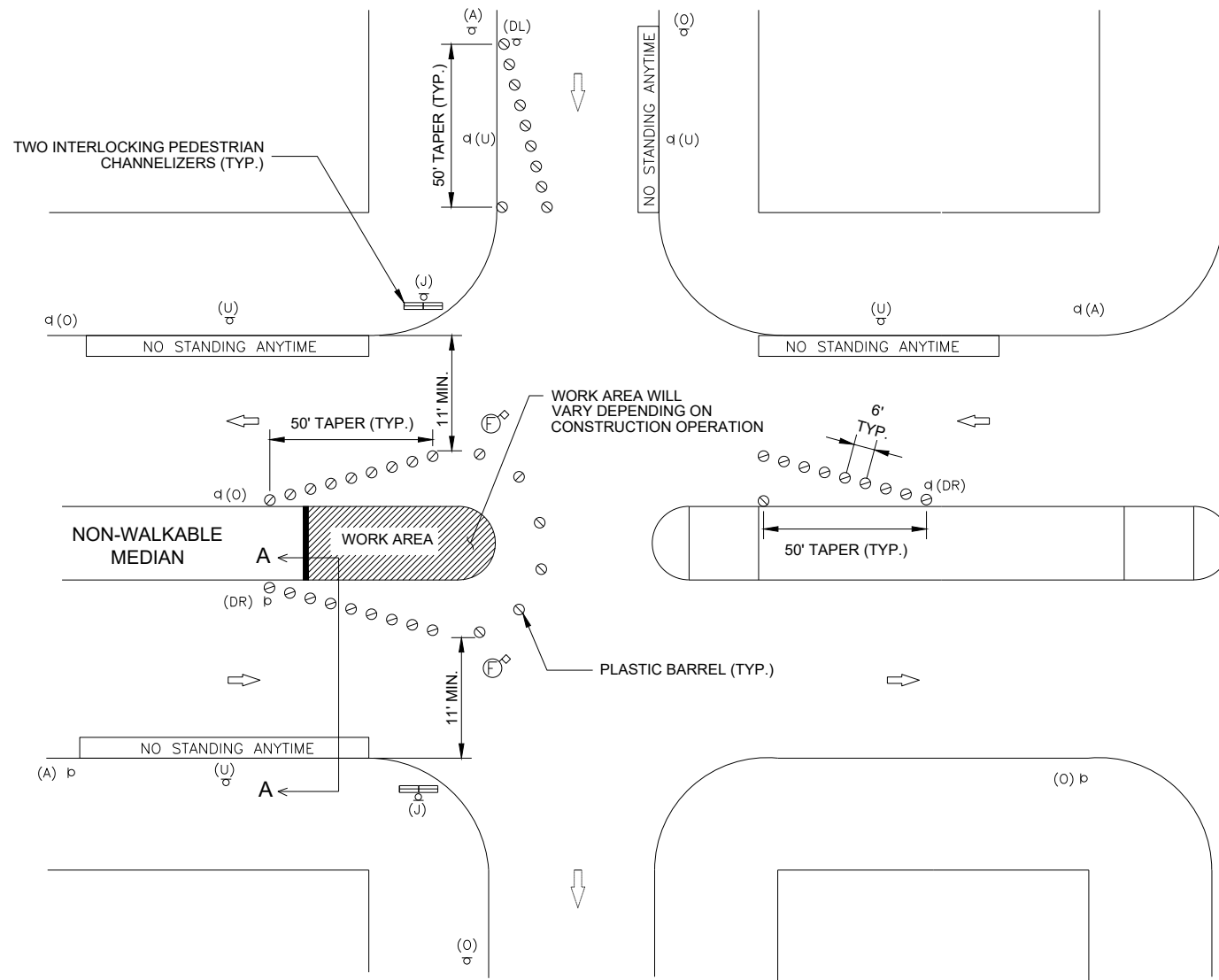

TYPICAL PLAN
NOT TO SCALE

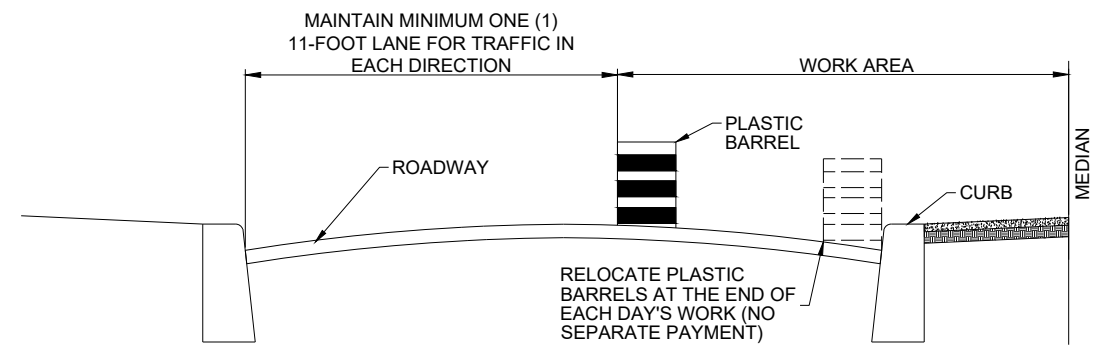

SECTION A-A
N.T.S

NOTES:

1. THE CONTRACTOR MAY OCCUPY A MAXIMUM OF ONE CORNER OR MEDIAN IN AN INTERSECTION AT ANY TIME.
2. AT THE END OF THE WORK DAY OR WHEN THE SITE IS LEFT UNATTENDED, BARRELS MUST BE PUSHED IN ALONG THE CURB. CORNER AND ADJACENT CROSSWALKS ARE TO REMAIN CLOSED TO PEDESTRIAN TRAFFIC.
3. PLASTIC BARRELS, SIX (6) FEET ON CENTER, ARE REQUIRED TO SEPARATE LANES TRAVELING IN THE OPPOSITE DIRECTION WHENEVER TRAFFIC IS REDIRECTED PAST THE YELLOW PAVEMENT MARKINGS. (NOT SHOWN ON DRAWINGS)

CITY OF NEW YORK
DEPARTMENT OF DESIGN AND CONSTRUCTION

MAINTENANCE AND PROTECTION OF TRAFFIC
CONSTRUCTION OF NEW SIDEWALKS
RESIDENTIAL AREA

**THIS MPT SKETCH IS SHOWING
THE ATTENDED CONDITIONS**

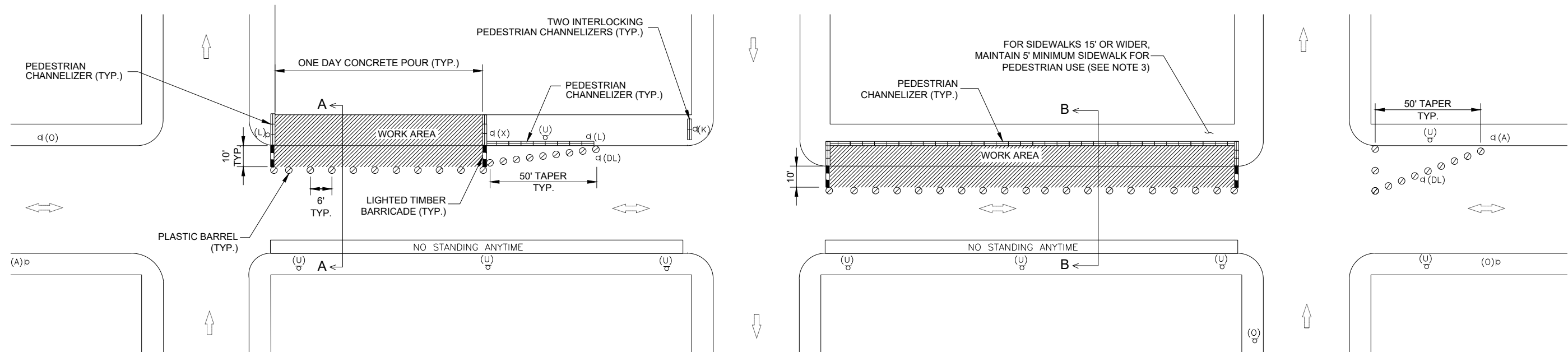

TYPICAL PLAN
NOT TO SCALE

NOTES:

1. AT THE END OF THE WORK DAY OR WHEN THE SITE IS LEFT UNATTENDED, BARRELS MUST BE PUSHED IN ALONG THE CURB.
2. PLASTIC BARRELS, SIX (6) FEET ON CENTER, IS REQUIRED TO SEPARATE LANES TRAVELING IN THE OPPOSITE DIRECTION WHENEVER TRAFFIC IS REDIRECTED PAST THE YELLOW PAVEMENT MARKINGS. (NOT SHOWN ON DRAWINGS)
3. IF THE SIDEWALK IS WIDER THAN FIFTEEN (15) FEET, THE CONTRACTOR MAY USE FIVE (5) FEET ALONG THE RIGHT OF WAY (R.O.W.) LINE AS A TEMPORARY PEDESTRIAN WALKWAY IF THAT PORTION OF THE SIDEWALK IS ADA COMPLIANT, AS DIRECTED AND APPROVED BY THE ENGINEER. IF BOTH CONDITIONS EXIST, THE CONTRACTOR SHOULD USE THE SKETCH WITH SECTION B-B ON THIS PAGE.

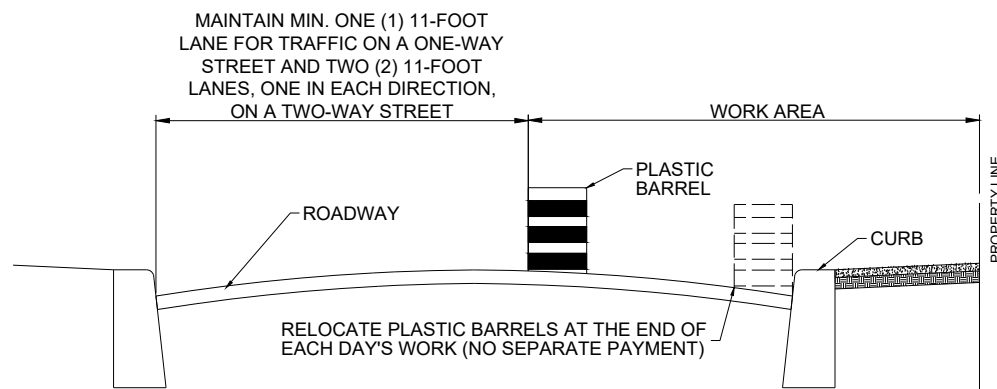

SECTION A-A
N.T.S

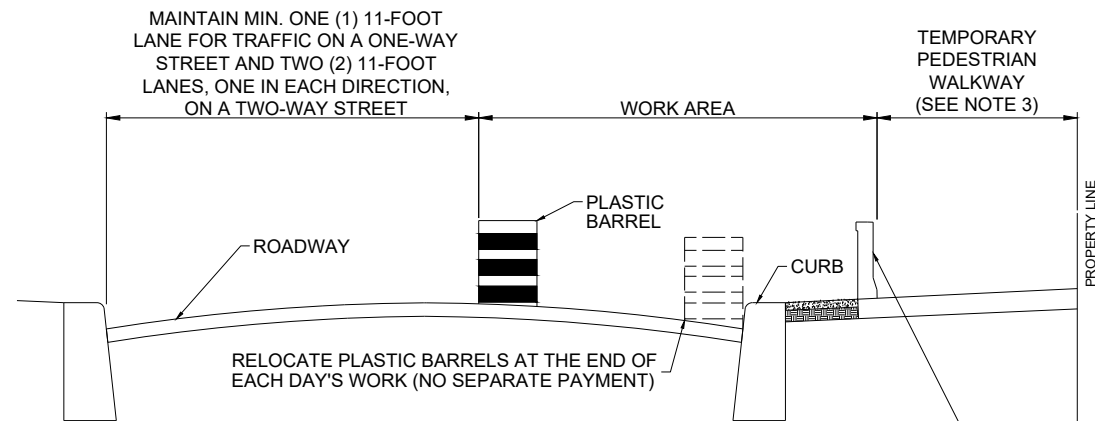

SECTION B-B
N.T.S

REVISED OCTOBER 2021

MAINTENANCE AND PROTECTION OF TRAFFIC
CONSTRUCTION OF NEW SIDEWALKS
COMMERCIAL & HIGH DENSITY PEDESTRIAN TRAFFIC AREA
(PROVIDE 5 FOOT WIDE ADA COMPLIANT TEMPORARY PEDESTRIAN WALKWAY)

**THIS MPT SKETCH IS SHOWING
THE UNATTENDED CONDITIONS**

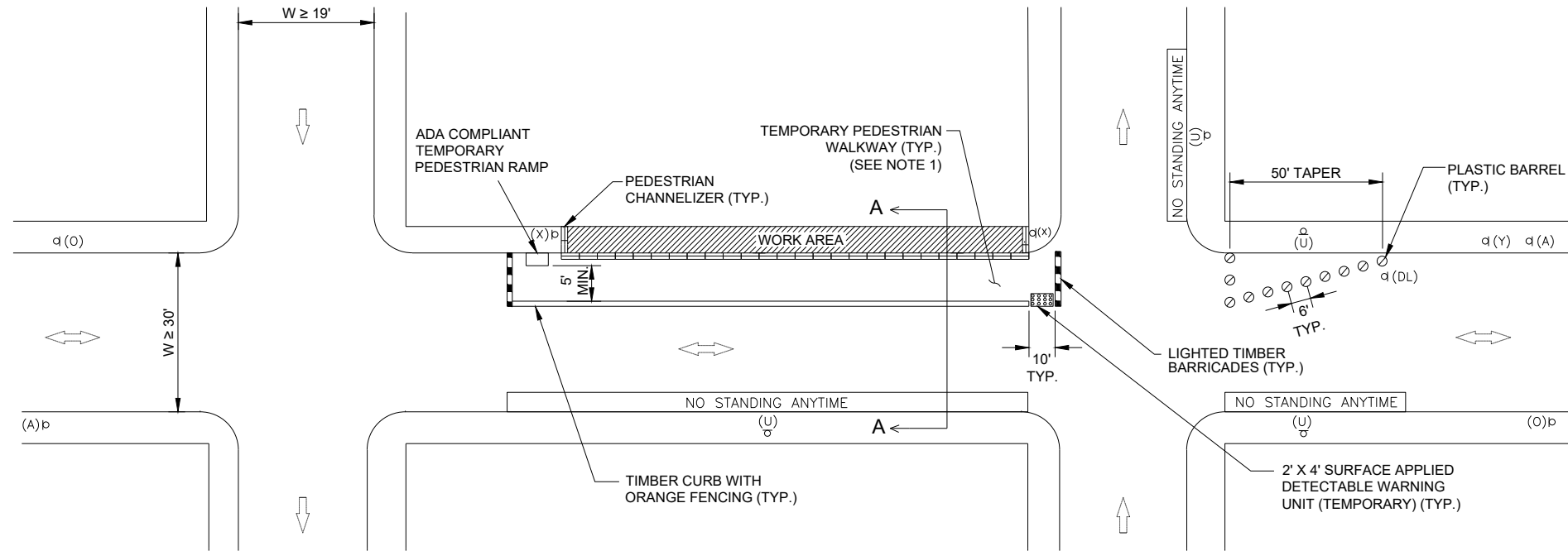

TYPICAL PLAN
NOT TO SCALE

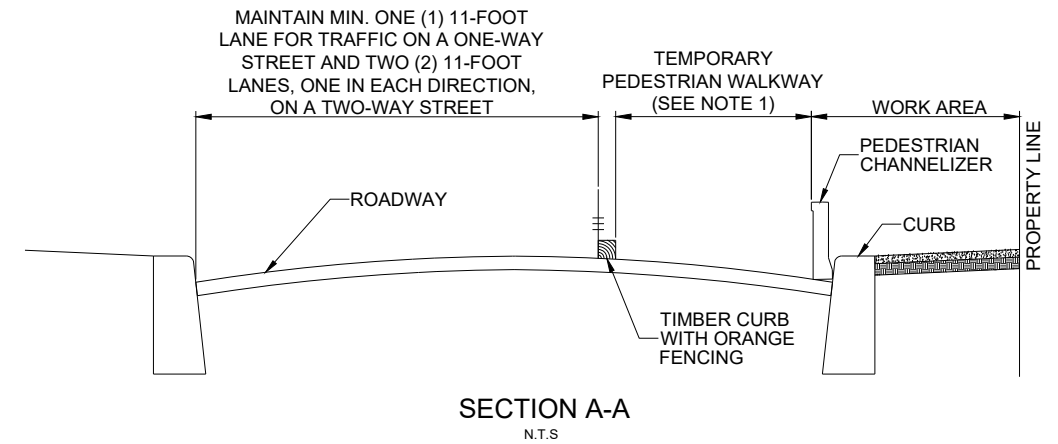

NOTES:

1. IF A MINIMUM FIVE (5) FOOT WIDE ADA COMPLIANT TEMPORARY PEDESTRIAN WALKWAY IS REQUIRED AS PER GENERAL NOTE 32 ON SHEET PR MPT 1, WHEN THE SITE IS UNATTENDED A TEMPORARY PEDESTRIAN WALKWAY MUST BE PROVIDED IN THE ROADWAY AS SHOWN OR IN THE SIDEWALK.
2. TIMBER CURBS WITH ORANGE FENCING MUST BE INSTALLED WHEN THE SITE IS UNATTENDED. PLASTIC BARRELS MAY BE USED IN LIEU OF TIMBER CURBS WHEN THE SITE IS ATTENDED. WHEN PLASTIC BARRELS ARE USED IN LIEU OF TIMBER CURBS, PEDESTRIANS MUST NOT USE THE TEMPORARY PEDESTRIAN WALKWAY AND CROSSING GUARDS MUST BE PROVIDED BY THE CONTRACTOR AS PER GENERAL NOTE 33 ON SHEET PR MPT 1 TO GUIDE PEDESTRIANS SAFELY AROUND THE WORK AREA.
3. TEMPORARY SURFACE APPLIED DETECTABLE WARNING UNIT (DWS) TO BE REMOVED, AND ROADWAY TO BE RESTORED, WITHIN 24 HOURS AFTER CONSTRUCTION IS COMPLETED. NO ADDITIONAL PAYMENT FOR REPAIR OF THE ROADWAY FROM THE DAMAGE OF THE TEMPORARY DWS.
4. PLASTIC BARRELS, SIX (6) FEET ON CENTER, ARE REQUIRED TO SEPARATE LANES TRAVELING IN THE OPPOSITE DIRECTION WHENEVER TRAFFIC IS REDIRECTED PAST THE YELLOW PAVEMENT MARKINGS. (NOT SHOWN ON DRAWINGS)

REVISED OCTOBER 2021

MAINTENANCE AND PROTECTION OF TRAFFIC

CONSTRUCTION OF NEW SIDEWALKS

COMMERCIAL & HIGH DENSITY PEDESTRIAN TRAFFIC AREA

THIS MPT SKETCH IS SHOWING
THE ATTENDED CONDITIONS

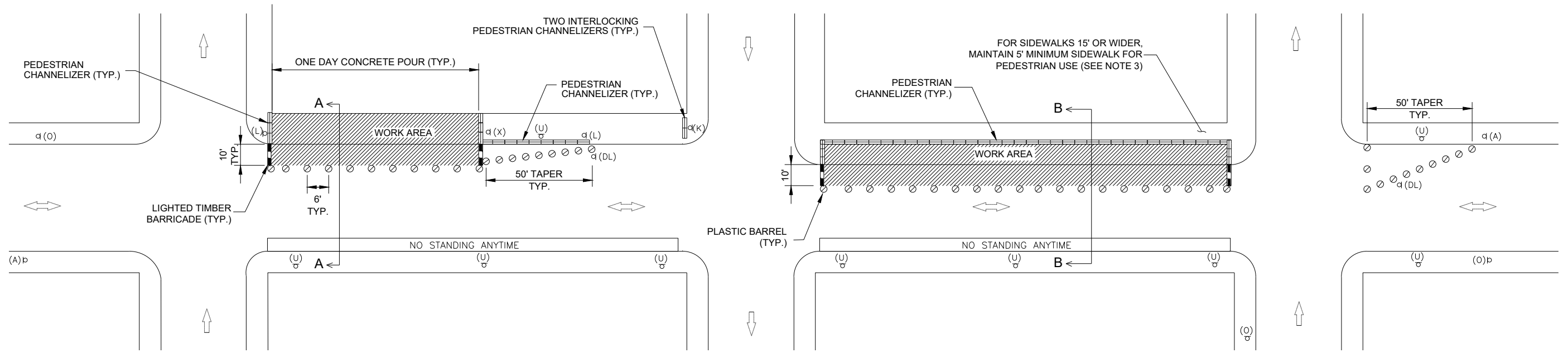

TYPICAL PLAN
NOT TO SCALE

NOTES:

1. AT THE END OF THE WORK DAY OR WHEN THE SITE IS LEFT UNATTENDED, BARRELS MUST BE PUSHED IN ALONG THE CURB.
2. PLASTIC BARRELS, SIX (6) FEET ON CENTER, ARE REQUIRED TO SEPARATE LANES TRAVELING IN THE OPPOSITE DIRECTION WHENEVER TRAFFIC IS REDIRECTED PAST THE YELLOW PAVEMENT MARKINGS. (NOT SHOWN ON DRAWINGS)
3. IF THE SIDEWALK IS WIDER THAN FIFTEEN (15) FEET, THE CONTRACTOR MAY USE FIVE (5) FEET ALONG THE RIGHT OF WAY (R.O.W.) LINE AS A TEMPORARY PEDESTRIAN WALKWAY IF THAT PORTION OF THE SIDEWALK IS ADA COMPLIANT, AS DIRECTED AND APPROVED BY THE ENGINEER. IF BOTH CONDITIONS EXIST, THE CONTRACTOR SHOULD USE THE SKETCH WITH SECTION B-B ON THIS PAGE.

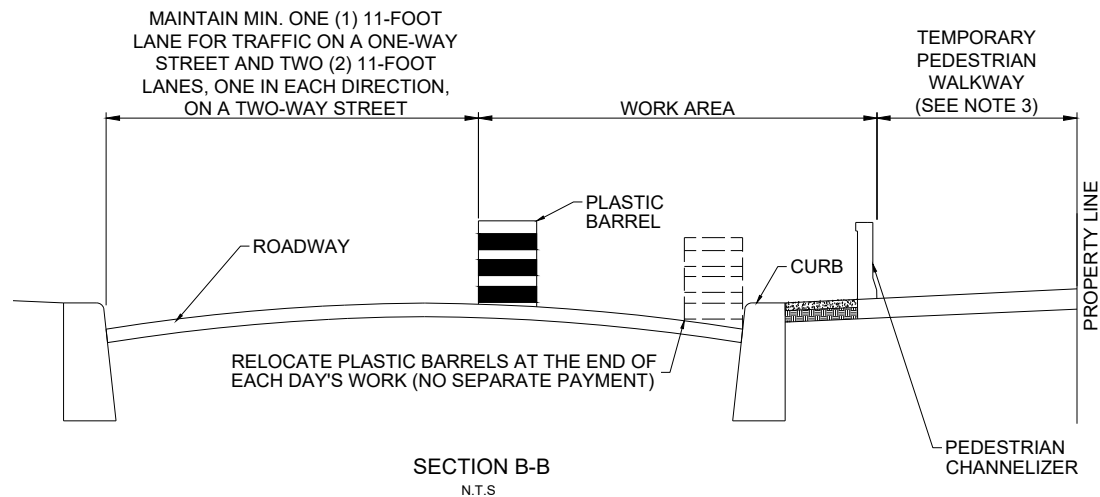
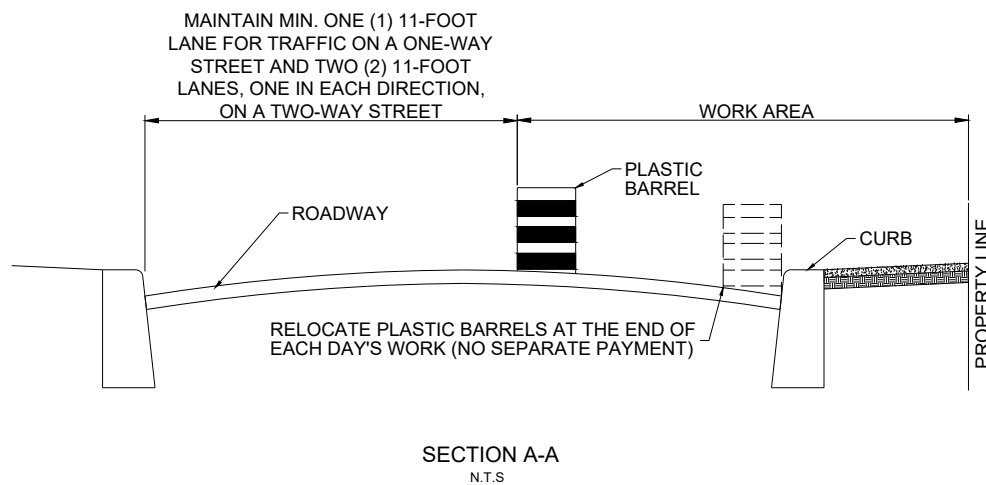

REVISED OCTOBER 2021

(C) SEWER & WATER MAIN PROJECT SPECIFIC PROVISIONS

(NO TEXT)

(D) GREEN INFRASTRUCTURE PROVISIONS

(NO TEXT)

NOTICE

The Standard Sewer And Water Main Specifications of the Department of Environmental Protection, Sewer Design Standards of the Department of Environmental Protection, Water Main Standard Drawings of the Department of Environmental Protection, Specifications For Trunk Main Work of the Department of Environmental Protection and the Standard Highway Specifications of the Department of Transportation of The City of New York, must be included as part of the contract documents. These said specifications and standard drawings are hereby revised under the following section headings:

- A. NOTICE TO BIDDERS
- B. REVISIONS TO THE STANDARD SEWER AND WATER MAIN SPECIFICATIONS
- C. REVISIONS TO THE SPECIFICATIONS FOR TRUNK MAIN WORK

(NO TEXT ON THIS PAGE)

A. NOTICE TO BIDDERS

(NO TEXT ON THIS PAGE)

B. REVISIONS TO THE STANDARD SEWER AND WATER MAIN SPECIFICATIONS

- (1) **Refer** to **Subsection 10.21 - Contractor To Notify City Departments**, Page 21:
Add the following to **Subsection 10.21**:

(1) N.Y.C. D.E.P., BUREAU OF WATER AND SEWERS OPERATIONS

The Contractor will notify Mr. Peter Gordon, P.E. Linear Capital Program Management Division at the Department of Environmental Protection, 59-17 Junction Blvd., 3rd floor low rise, Corona N.Y. 11368, at (718) 595-4347 at least thirty (30) days prior to the start of construction.

(2) N.Y.C. DEPARTMENT OF TRANSPORTATION

The Contractor will notify Mr. Hasib Amini / Akmal Mikhail – Traffic Signal/Street Lighting Operations, 34-02 Queens Blvd., Long Island City, N.Y. 11101 at (212) 839-3386 / (212) 839-3368, at least seventy-two (72) hours prior to the start of construction.

(3) N.Y.C. TRANSIT AUTHORITY

The Contractor is advised that bus routes as well as bus stops, within the scope of this project may be affected during construction operations. The Contractor shall notify the Transit Authority at least two (2) weeks prior to the start of construction, in order to make the necessary arrangements.

Arrangements shall be made through:

Ms. Sarah Wyss
Director Of Short Range, Bus Service Planning (SRB)
New York City Transit
2 Broadway, 17th Floor
New York, N.Y. 10004
Telephone No. (646) 252-5517
sarah.wyss@nyct.com

- (2) **Refer** to **Subsection 10.24 – Damaged Water Service Pipes To Be Repaired By A Licensed Plumber**, Page 22:
Add the following to **Subsection 10.24**:

If the damaged or cut water service pipe is lead, galvanized steel, or galvanized iron, the service pipe must not be partially replaced, but fully replaced from the main to the house control valve. If the service pipe was damaged, cut, or otherwise interrupted due to the Contractor's actions or means & methods (including selection of shoring systems), the water service pipe will be replaced at the Contractor's own cost.

- (3) **Refer** to **Subsection 10.30 - Contractor To Provide For Traffic**, Page 24:
Add the following to **Subsection 10.30**:

a. Traffic Stipulations:

The Contractor must refer to Traffic Stipulations identified in the maintenance of traffic requirements under Highway Contract No. HWS2023R.

- (4) Refer to **Subsection 71.41.4 - Specific Pavement Restoration Provisions**, Page 531:
Add the following to **Subsection 71.41.4**:

(E) Specific Pavement Restoration Provisions:

- (1) Within the limits of the highway reconstruction the restoration shall be accomplished and paid for in accordance with Highway Construction Plans, Details and Specifications for Highway Project ID. HWS2023R.

C. REVISIONS TO THE SPECIFICATIONS FOR TRUNK MAIN WORK

(NO TEXT)

END OF SECTION
This Section consists of four (4) pages.

HAZ - PAGES**SUPPLEMENTAL DOCUMENTATION FOR USE
WITH SPECIFICATIONS FOR HANDLING,
TRANSPORTATION AND DISPOSAL
OF NONHAZARDOUS AND POTENTIALLY
HAZARDOUS CONTAMINATED MATERIALS**

NOTICE

THE PAGES CONTAINED IN THIS SECTION ARE ISSUED FOR THE PURPOSE OF SPECIFYING THE REQUIREMENTS OF THE CONTRACT DOCUMENTS AND HEREBY MADE PART OF SAID CONTRACT DOCUMENTS.

(NO TEXT ON THIS PAGE)

**SPECIFICATIONS FOR
HANDLING, TRANSPORTATION, AND DISPOSAL
OF POTENTIAL AND IDENTIFIED
CONTAMINATED AND HAZARDOUS MATERIALS**

FY23 PRIOR NOTICE SIDEWALKS – STATEN ISLAND

**BOROUGH OF STATEN ISLAND
CITY OF NEW YORK**

Project ID: HWS2023R

Prepared By:



30-30 Thomson Avenue
Long Island City, New York 11101

October 19, 2023

Notice to Bidders

DISCLAIMER: NO CORRIDOR ASSESSMENT REPORT (CAR) OR SUBSURFACE CORRIDOR INVESTIGATION (SCI) DATA IS PROVIDED. THE CONTRACTOR IS TO ASSUME THE EXCAVATED SOIL IS CONTAMINATED AND BID ON THE QUANTITIES LISTED. THE CONTRACTOR SHALL USE THE CONTRACTOR'S ENGINEERING JUDGMENT FOR PRICING OF THOSE ITEMS.



**Department of
Design and
Construction**

**DIVISION OF INFRASTRUCTURE
BUREAU OF DESIGN**

VOLUME 3 OF 3

PROJECT ID: HWS2023R

**INSTALLATION OF SIDEWALKS, ADJACENT CURBS AND
PEDESTRIAN RAMPS AS NECESSARY IN VARIOUS LOCATIONS**

Together With All Work Incidental Thereto
BOROUGH OF STATEN ISLAND
CITY OF NEW YORK

_____ *Contractor*

Dated _____, 20____
