



**THE CITY OF NEW YORK
DEPARTMENT OF DESIGN AND CONSTRUCTION
DIVISION OF INFRASTRUCTURE**

30-30 THOMSON AVENUE
LONG ISLAND CITY, NEW YORK 11101-3045
TELEPHONE (718) 391-1000
WEBSITE www.nyc.gov/buildnyc

**VOLUME 1 OF 3
BID BOOKLET**

LAW

FOR FURNISHING ALL LABOR AND MATERIALS NECESSARY AND REQUIRED FOR:

PROJECT ID: HWQ121B4

RECONSTRUCTION OF LAKEVIEW BOULEVARD EAST

LAKEVIEW LANE - FROM BAISLEY BOULEVARD TO 122ND AVENUE
122ND AVENUE - FROM LAKEVIEW LANE TO LAKEVIEW BOULEVARD EAST
LAKEVIEW BOULEVARD EAST - FROM 122ND AVENUE TO 118TH AVENUE
118TH AVENUE - FROM LAKEVIEW BOULEVARD EAST TO LONG STREET

NEW STORM AND SANITARY SEWERS (SEQ200436) IN:

LAKEVIEW LANE - FROM BAISLEY BOULEVARD TO 122ND AVENUE
122ND AVENUE - FROM LAKEVIEW LANE TO LAKEVIEW BOULEVARD EAST
LAKEVIEW BOULEVARD EAST - FROM 122ND AVENUE TO 118TH AVENUE
119TH AVENUE - FROM LONG STREET TO 164TH STREET
164TH STREET - FROM 119TH AVENUE TO 120TH AVENUE

**CAPITAL PROJECT WM-1
WATER MAIN WORK IN:**

LAKEVIEW LANE - FROM BAISLEY BOULEVARD TO 122ND AVENUE
122ND AVENUE - FROM LAKEVIEW LANE TO LAKEVIEW BOULEVARD EAST
LAKEVIEW BOULEVARD EAST - FROM 122ND AVENUE TO 118TH AVENUE
118TH AVENUE - FROM LAKEVIEW BOULEVARD EAST TO LONG STREET
119TH AVENUE - FROM LONG STREET TO 164TH STREET
164TH STREET - FROM 119TH AVENUE TO 120TH AVENUE

INCLUDING STREET LIGHTING AND TRAFFIC WORK

Together With All Work Incidental Thereto

**BOROUGH OF QUEENS
CITY OF NEW YORK**

FOR THE DEPARTMENT OF TRANSPORTATION
PREPARED BY
AKRF Engineering P.C., & HAZEN AND SAWYER

15-148

January 30, 2015





Bid Tab

CORRECTION*

Description	RECONSTRUCTION OF LAKEVIEW BOULEVARD EAST, ETC., BOROUGH OF QUEENS		
Bid Date	6/16/2015	FMS ID	HWQ121B4
Estimated Cost	\$10,272,148.00	Client Agency	DOT
Bid Security	Not less than 2% of Total Bid Price	PLA	No
Time Allowed	730 CCD	Contract Manager	Victoria Ayo- Vaughan
Addendum	7	Project Manager	Trofimov, Igor
PIN	8502015HW0021C	E-PIN	85015B0135
Selective Bidding	<input type="checkbox"/> Yes <input checked="" type="checkbox"/> No	Consultant	AKRF Engineers P.C.

Bid Rank	Vendor	Bid Amount	Security Type
1	P & T II CONTRACTING CORP.	\$11,729,618.01	Bond
2	BOVE INDUSTRIES, INC.	\$11,749,749.00	Bond
3	C.A.C. INDUSTRIES, INC.	\$13,331,959.83	Bond
4	JR CRUZ CORP.	*\$13,974,092.60	Bond
5	PERFETTO CONTRACTING CO. INC.	\$14,075,000.00	Bond

Recorder: Yamina Youb ext. 1016

Approver: 



September 24, 2015

CERTIFIED MAIL - RETURN RECEIPT REQUEST

P & T II Contracting Corp.
2417 Jericho Turnpike Suite 315
Garden City Park, NY 11040

RE: FMS ID: HWQ121B4
E-PIN: 85015B0135001
DDC PIN: 8502015HW0021C
Reconstruction of Lakeview Boulevard East, etc.,
Borough of Queens
NOTICE OF AWARD

Dear Contractor:

You are hereby awarded the above referenced contract based upon your bid in the amount of \$11,729,618.01 submitted at the bid opening on June 16, 2015. Within ten (10) days of your receipt of this notice of award, you are required to take the actions set forth in Paragraphs (1) through (3) below. For your convenience, attached please find a copy of Schedule A of the General Conditions to the Contract, which sets forth the types and amounts of insurance coverage required for this contract.

- (1) Execute four copies of the Agreement in the Contracts Unit, 30-30 Thomson Avenue, 1st Floor, Long Island City, New York (IDCNY Building). A Commissioner of Deeds will be available to witness and notarize your signature. The Agreement must be signed by an officer of the corporation or a partner of the firm.
- (2) Submit to the Contracts Unit four properly executed performance and payment bonds. If required for this contract, copies of performance and payment bonds are attached.
- (3) Submit to the Contracts Unit the following insurance documentation: (a) original certificate of insurance for general liability in the amount required by Schedule A, and (b) original certificates of insurance or other proof of coverage for workers' compensation and disability benefits, as required by New York State Law. The insurance documentation specified in this paragraph is required for registration of the contract with the Comptroller's Office.

On or before the contract commencement date, you are required to submit all other certificates of insurance and/or policies in the types and amounts required by Schedule A. Such certificates of Insurance and/or policies must be submitted to the Agency Chief Contracting Office, Attention: Risk Manager, Fourth Floor at the above indicated department address.

Your attention is directed to the section of the Information for Bidders entitled "Failure to Execute Contract". As indicated in this section, in the event you fail to execute the contract and furnish the required bonds within the (10) days of your receipt of this notice of award, your bid security will be retained by the City and you will be liable for the difference between your bid price and the price for which the contract is subsequently awarded, less the amount of the bid security retained.

Sincerely,



Lorraine Holley

SPECIAL NOTICE TO BIDDERS

The New York City Department of Small Business Services (SBS), in conjunction with the New York Business Development Corporation (NYBDC), have established a **NYC Construction Loan** pilot program to provide prime contractors and subcontractors financing for mobilization costs on certain City construction projects.

Under this initiative, loans are available for early stage mobilization needs such as insurance, labor, supplies and equipment. Bidders are strongly encouraged to visit "Growing Your Business" at www.nyc.gov/nycbusiness to learn more about the loan or contact constructionloan@sbs.nyc.gov / (212) 513-6444 to obtain details and to determine preliminary eligibility.

A successful loan applicant will be required to make an assignment of its contract (or subcontract) payments to the lender NYBDC until the loan is repaid. If the loan is to a subcontractor, a prime contractor must honor the terms of such an assignment.

A prime contractor may not discriminate against a subcontractor or potential subcontractor by reason of the subcontractor's participation, or nonparticipation, in the NYC Construction Loan program.

(NO TEXT ON THIS PAGE)

CITY OF NEW YORK
DEPARTMENT OF
DESIGN AND CONSTRUCTION
DIVISION OF INFRASTRUCTURE
BID BOOKLET

FOR FURNISHING ALL LABOR AND MATERIALS
NECESSARY AND REQUIRED FOR:

PROJECT ID: HWQ121B4

RECONSTRUCTION OF LAKEVIEW BOULEVARD EAST

LAKEVIEW LANE - FROM BAISLEY BOULEVARD TO 122ND AVENUE
122ND AVENUE - FROM LAKEVIEW LANE TO LAKEVIEW BOULEVARD EAST
LAKEVIEW BOULEVARD EAST - FROM 122ND AVENUE TO 118TH AVENUE
118TH AVENUE - FROM LAKEVIEW BOULEVARD EAST TO LONG STREET

NEW STORM AND SANITARY SEWERS (SEQ200436) IN:

LAKEVIEW LANE - FROM BAISLEY BOULEVARD TO 122ND AVENUE
122ND AVENUE - FROM LAKEVIEW LANE TO LAKEVIEW BOULEVARD EAST
LAKEVIEW BOULEVARD EAST - FROM 122ND AVENUE TO 118TH AVENUE
119TH AVENUE - FROM LONG STREET TO 164TH STREET
164TH STREET - FROM 119TH AVENUE TO 120TH AVENUE

CAPITAL PROJECT WM-1
WATER MAIN WORK IN:

LAKEVIEW LANE - FROM BAISLEY BOULEVARD TO 122ND AVENUE
122ND AVENUE - FROM LAKEVIEW LANE TO LAKEVIEW BOULEVARD EAST
LAKEVIEW BOULEVARD EAST - FROM 122ND AVENUE TO 118TH AVENUE
118TH AVENUE - FROM LAKEVIEW BOULEVARD EAST TO LONG STREET
119TH AVENUE - FROM LONG STREET TO 164TH STREET
164TH STREET - FROM 119TH AVENUE TO 120TH AVENUE

INCLUDING STREET LIGHTING AND TRAFFIC WORK

Together With All Work Incidental Thereto

BOROUGH OF QUEENS
CITY OF NEW YORK

(NO TEXT ON THIS PAGE)

CITY OF NEW YORK
DEPARTMENT OF DESIGN AND CONSTRUCTION
DIVISION OF INFRASTRUCTURE

BID BOOKLET

TABLE OF CONTENTS

SECTION	PAGE
PART A	
1. Table of Contents.....	1
2. Special Notice to Bidders.....	2
3. Attachment 1 – Bid Information.....	A-1
4. Bid Schedule.....	B-1
5. Bid Form.....	C-1
6. Affirmation.....	C-6
7. Bid Bond	C-7
8. M/WBE Program: M/WBE Utilization Plan.....	5
9. Apprenticeship Program Requirements	19
PART B	
10. Safety Questionnaire	21
11. Pre-award Process.....	24
12. Project Reference Form.....	26
13. Contract Certificate.....	29
14. Vendex Compliance.....	30
15. Iran Divestment Act Compliance Rider	31
16. Construction Employment Report.....	33

(NO TEXT ON THIS PAGE)

**CITY OF NEW YORK
DEPARTMENT OF DESIGN AND CONSTRUCTION
DIVISION OF INFRASTRUCTURE**

SPECIAL NOTICE TO BIDDERS

BID SUBMISSION REQUIREMENTS

THE FOLLOWING DOCUMENTS ARE TO BE COMPLETED AND SUBMITTED WITH THE BID:

1. Bid Schedule and Bid Form, including Affirmation
2. Bid Security (if required, see Attachment 1 on Page A-1)
3. Schedule B: M/WBE Utilization Plan (if participation goals have been established)

**FAILURE TO SUBMIT ITEMS (1), (2) AND (3)
WILL RESULT IN THE DISQUALIFICATION OF THE BID.**

4. Safety Questionnaire
5. Construction Employment Report (if bid is \$1,000,000 or more)
6. Contract Certificate (if bid is less than \$1,000,000)
7. Confirmation of Vendex Compliance
8. Bidder's Certification of Compliance with Iran Divestment Act
9. Special Experience Requirements (if applicable)
10. Apprenticeship Program Questionnaire (if applicable)
11. Any addenda issued prior to the receipt of bids

**FAILURE TO SUBMIT ITEMS (4) THROUGH (11)
MAY RESULT IN THE DISQUALIFICATION OF THE BID.**

NOTES:

- (1) All of the above referred to blank forms to be completed and submitted with the bid are included in the BID BOOKLET.
- (2) If the bidder has any questions or requires additional information, please contact the Department of Design and Construction by phone (718-391- 2601) or by fax (718-391-2615).
- (3) VENDEX QUESTIONNAIRES: The Bidder is advised that Vendex Questionnaires and procedures have been changed. Vendex Questionnaires, as well as detailed instructions, may be obtained at www.nyc.gov/vendex. The bidder may also obtain Vendex forms and instructions by contacting the Agency Chief Contracting Officer or the contact person for this contract.
- (4) SPECIAL EXPERIENCE REQUIREMENTS: The Bidder is advised that Special Experience Requirements may apply to this contract. Such requirements are set forth on pages 3, 3a, 3b, and 4 of this Bid Booklet.

SPECIAL NOTICE TO BIDDERS

SPECIAL EXPERIENCE REQUIREMENTS (Revised 03/2014)

- (A) **SPECIAL EXPERIENCE REQUIREMENTS FOR THE BIDDER:** The Special Experience Requirements set forth below apply to the bidder. Compliance with such Special Experience Requirements will be determined solely by the City prior to an award of contract. Failure to comply with the Special Experience Requirements will result in rejection of the bid as non-responsive.

The requirements in this Section (A) apply to this contract where indicated by a blackened box (■).

- The bidder must, within the last seven (7) consecutive years prior to the bid opening, have successfully completed in a timely fashion at least one (1) project similar in scope and type to the required work. Such prior project may have been performed as a prime contractor, subcontractor or sub-subcontractor.

The Special Experience Requirements next to the blackened box below apply to the bidder. If the bidder intends to perform such work itself, it must demonstrate compliance with the Special Experience Requirements. If the bidder intends to subcontract this work, the proposed subcontractor or sub-subcontractor must demonstrate compliance with the Special Experience Requirements. The contractor, subcontractor or sub-subcontractor (hereinafter referred to as the "entity") that will perform any specific area of work indicated by the blackened box below, may have performed the required prior project(s) as a prime contractor, subcontractor or sub-subcontractor. Once approved, no substitution will be permitted, unless the qualifications of the proposed replacement have been approved in writing in advance by the City.

- Trunk Water Main Work:** The entity that will perform the trunk water main work must, within the last seven (7) consecutive years prior to the bid opening, have successfully completed in a timely fashion at least one (1) project similar in scope and type to the required work.
- Best Management Practice Work:** Best Management Practice ("BMP") Work is any item of work in the Bid Schedule that begins with the prefix "BMP". The entity that will perform any BMP Work must, within the last five (5) consecutive years prior to the bid opening, have successfully completed in a timely fashion at least three (3) projects similar in scope and type to the required work.

For professional services in connection with BMP Work, (i.e., monitoring and reporting services), the individual who will perform the required services must, within the last five (5) consecutive years prior to the bid opening, have successfully completed in a timely fashion at least three (3) projects similar in scope and type to the required work. Additional requirements are set forth below.

- The individual serving as the Restoration Specialist (Construction Monitor) must be a Registered Landscape Architect licensed by the state of New York, or must have equivalent professional experience.
- The individual serving as the Erosion and Sediment Control Licensed/Certified Professional must be a Certified Professional in Erosion and Sediment Control (CPESC), certified by CPESC, Inc.
- Micro-Tunneling/Pipe Jacking Work:** The entity that will perform the micro-tunneling/pipe jacking work must, within the last five (5) consecutive years prior to the bid opening, have successfully completed in a timely fashion at least two (2) projects similar in scope and type to the required work.
- OTHER:** _____

(B) SPECIAL EXPERIENCE REQUIREMENTS FOR SPECIFIC AREAS OF WORK (to be provided after an award of contract):

The requirements in this Section (B) apply to this contract where indicated by a blackened box (■).

The Special Experience Requirements set forth below apply to the contractor, subcontractor or sub-subcontractor that will perform the specific area of work. **Compliance with such Special Experience Requirements will be determined solely by the City after an award of contract.** After an award of contract, when requested by the City, the contractor will be required to submit the qualifications of the contractor, subcontractor or sub-subcontractor that will perform the specific area of work. If the bidder intends to perform such work itself, it must demonstrate compliance with the Special Experience Requirements. If the bidder intends to subcontract this work, the proposed subcontractor or sub-subcontractor must demonstrate compliance with the Special Experience Requirements. Once approved, no substitution will be permitted, unless the qualifications of the proposed replacement have been approved in writing in advance by the City.

Special Experience Requirements apply to the contractor, subcontractor or sub-subcontractor (hereinafter referred to as the "entity") that will perform any specific area of work indicated by a blackened box. The entity may have performed the required prior project(s) as a prime contractor, subcontractor or sub-subcontractor.

- Hazmat Work:** Hazmat Work is any item of work in the Bid Schedule that begins with the prefix 8.01. The entity that will perform any Hazmat Work must, within the last three (3) consecutive years prior to the bid opening, have successfully completed in a timely fashion at least five (5) projects similar in scope and type to the required work.
- Pile, CFA Pile, and/or Mini-Pile Work:** The entity that will perform the Pile, CFA Pile and/or Mini-Pile Work must, within the last three (3) consecutive years prior to the bid opening, have successfully completed in a timely fashion at least two (2) projects similar in scope and type to the required work.

For professional services in connection with Pile Work, (i.e., engineering and inspection services), the individual who will perform the required services must be a Professional Engineer licensed by the state of New York. Such individual must also comply with the above requirements for prior projects.

- Construction Report, Monitoring And Post-Construction Report, and Continuous Real-Time Monitoring For Vibrations And Movements And Post-Construction Report Work:** The entity that will perform the Construction Report, Monitoring For Vibrations And Movements, and Post-Construction Report Work must, within the last three (3) consecutive years prior to the bid opening, have successfully completed in a timely fashion at least two (2) projects similar in scope and type to the required work.

For professional services in connection with Reporting and Monitoring Work, (i.e., engineering and inspection services), the individual who will perform the required services must be a Professional Engineer licensed by the state of New York. Such individual must also comply with the above requirements for prior projects.

- OTHER:** _____

(C) **SPECIFICATIONS:** In the event of any conflict, omission or inconsistency between (1) the Specifications and/or Contract Drawings, and (2) the Special Experience Requirements in Section (B) of the Special Notice To Bidders, the special experience listed in the Specifications and/or Contract Drawings shall be controlling. The Special Experience Requirements in Section (B) of this Special Notice To Bidders are only for the convenience of the bidders.

(D) **SUBMISSION REQUIREMENTS:** For each project submitted to demonstrate compliance with the Special Experience Requirements, the bidder must complete and submit the Qualification Form included in the Bid Booklet. The City will only evaluate a project if the following criteria are met: (1) the project is described on the Qualification Form, and (2) all information on the Qualification Form is provided. The City will not evaluate any project which does not comply with the criteria set forth herein, including any project which is referred to only on the resume of an individual.

If Special Experience Requirements are indicated for any specific area of work, the submission requirement set forth above shall apply to the entity that will perform the specific area of work.

(E) **CONDITIONS:** In determining compliance with the Special Experience Requirements for the bidder set forth above, the City may consider prior projects completed by principal(s) or other employees of the bidder while affiliated with another entity, subject to the conditions set forth below.

- Any principal or other employee on whose prior experience the bidder is relying to demonstrate compliance with this special experience requirement must have held the following: (a) a significant management role in the prior entity with which he/she was affiliated, and (b) a significant management role in the entity submitting the bid for a period of six (6) months or more from the inception of the bidding entity.
- The bidder may not rely on the experience of its principals or other employees to demonstrate compliance with any other requirements, including without limitation, financial requirements or requirements for a specified minimum amount of annual gross revenues.

(F) **JOINT VENTURES:** In the event the bidder is a joint venture, at least one firm in the joint venture must meet the above described experience requirements.

Qualification Form

List previous projects completed to meet the special experience requirements for this contract.
Please photocopy this form for submission of all required projects.

Name of Contractor: _____

Name of Project: _____

Location of Project: _____

Owner or Owner's representative (Architect or Engineer) who is familiar with the work performed:

Name: _____

Title: _____ Phone Number: _____

Brief description of the Project completed or the Project in progress: _____

Was the Project performed as a prime, a subcontractor or a sub-subcontractor: _____

Amount of Contract, Subcontract or Sub-subcontract: _____

Start Date and Completion Date: _____

Name of Contractor: _____

Name of Project: _____

Location of Project: _____

Owner or Owner's representative (Architect or Engineer) who is familiar with the work performed:

Name: _____

Title: _____ Phone Number: _____

Brief description of the Project completed or the Project in progress: _____

Was the Project performed as a prime, a subcontractor or a sub-subcontractor: _____

Amount of Contract, Subcontract or Sub-subcontract: _____

Start Date and Completion Date: _____

(NO TEXT ON THIS PAGE)

ATTACHMENT 1 - BID INFORMATION

PROJECT ID: HWQ121B4

PIN: 8502015HW0021C

Description and Location of Work:

RECONSTRUCTION OF LAKEVIEW BOULEVARD EAST

LAKEVIEW LANE - FROM BAISLEY BOULEVARD TO 122ND AVENUE
122ND AVENUE - FROM LAKEVIEW LANE TO LAKEVIEW BOULEVARD EAST
LAKEVIEW BOULEVARD EAST - FROM 122ND AVENUE TO 118TH AVENUE
118TH AVENUE - FROM LAKEVIEW BOULEVARD EAST TO LONG STREET

NEW STORM AND SANITARY SEWERS (SEQ200436) IN:

LAKEVIEW LANE - FROM BAISLEY BOULEVARD TO 122ND AVENUE
122ND AVENUE - FROM LAKEVIEW LANE TO LAKEVIEW BOULEVARD EAST
LAKEVIEW BOULEVARD EAST - FROM 122ND AVENUE TO 118TH AVENUE
119TH AVENUE - FROM LONG STREET TO 164TH STREET
164TH STREET - FROM 119TH AVENUE TO 120TH AVENUE

CAPITAL PROJECT WM-1
WATER MAIN WORK IN:

LAKEVIEW LANE - FROM BAISLEY BOULEVARD TO 122ND AVENUE
122ND AVENUE - FROM LAKEVIEW LANE TO LAKEVIEW BOULEVARD EAST
LAKEVIEW BOULEVARD EAST - FROM 122ND AVENUE TO 118TH AVENUE
118TH AVENUE - FROM LAKEVIEW BOULEVARD EAST TO LONG STREET
119TH AVENUE - FROM LONG STREET TO 164TH STREET
164TH STREET - FROM 119TH AVENUE TO 120TH AVENUE

INCLUDING STREET LIGHTING AND TRAFFIC WORK

Together With All Work Incidental Thereto

BOROUGH OF QUEENS
CITY OF NEW YORK

Documents Available At:

30-30 Thomson Avenue
First Floor Bid Procurement Room
Long Island City, New York 11101
8:30 A.M. to 4:00 P.M. - Monday through Friday

Submission of Bids To:

30-30 Thomson Avenue
First Floor Bid Procurement Room
Long Island City, New York 11101
Before 11:00 A.M. on JUNE 16, 2015

Bid Opening:

30-30 Thomson Avenue
First Floor Bid Procurement Room
Long Island City, New York 11101

Time and Date: 11:00 A.M. on JUNE 16, 2015

Pre-Bid Conference:

Yes _____ No X
If Yes, Mandatory _____ Optional: _____
Time and Date: _____
Location: _____

Bid Security:

Bid Security is required in the amount set forth below; provided, however, bid security is not required if the TOTAL BID PRICE set forth on the Bid Form is less than \$ 1,000,000.00.

- (1) Bond in an amount not less than 10% of the TOTAL BID PRICE set forth on the Bid Form, OR
- (2) Certified Check in an amount not less than 2% of the TOTAL BID PRICE set forth on the Bid Form.

Performance and Payment Security: Required for contracts in the amount of \$1,000,000 or more. Performance Security and Payment Security shall each be in an amount equal to 100% of the Contract Price.

Agency Contact Person:

Lorraine Holley
Phone: 718-391-2601 FAX: 718-391-2615

(NO TEXT ON THIS PAGE)

BID SCHEDULE

NOTICE TO BIDDERS

Items listed in this Bid Schedule which have one (1) digit followed by a decimal (e.g. 4.02 CB), except for items beginning with the number "8.01", shall comply with the requirements of the corresponding numerical Sections of the NYCDOT Standard Highway Specifications, dated November 1, 2010, as amended by Addendum No. 1, herein Volume 3 of 3.

Items listed in this Bid Schedule which have two (2) digits beginning with the number "5" or "6" or "7" followed by a decimal (e.g. 52.11D12, 60.12D16, 73.11AB) shall comply with the requirements of the New York City Department of Environmental Protection (NYCDEP) Standard Sewer and Water Main Specifications, dated July 1, 2014, as amended by Addendum No. 2, herein Volume 3 of 3.

Items listed in this Bid Schedule beginning with the number "8.01" followed by a letter (e.g. 8.01 C2) shall comply with the requirements of the corresponding numerical Sections of the DDC Specifications for Handling, Transportation and Disposal of Nonhazardous and Potentially Hazardous Contaminated Materials contained in Addendum No. 5, herein Volume 3 of 3.

Items listed in this Bid Schedule beginning with "NYC-" (e.g. NYC-610.0112, NYC-610.01940082) are modified versions of the New York State Department of Transportation (NYSDOT) Specifications and shall comply with the corresponding alphanumeric Sections in Addendum No. 1, herein Volume 3 of 3.

Items listed in this Bid Schedule beginning with the prefix "BMP" (e.g. BMP-7.510, BMP-7.516, etc.), shall comply with the requirements of the corresponding alphanumeric Sections incorporated in Addendum No. 4, herein Volume 3 of 3.

Items listed in this Bid Schedule beginning with the prefix "UTL-" (e.g. UTL-6.01.1) are for Gas Cost Sharing (EP-7) work and shall comply with the requirements of Addendum No. 3, herein Volume 3 of 3.

Items listed in this Bid Schedule beginning with the prefix "SL-" (e.g. SL-24.01.04) are Street Lighting Items, less the prefix, which shall be done in accordance with the requirements of Sub-Section 1.06.23.(D) and Section 1.06.49 in the Standard Highway Specifications.

(NO TEXT)

BID FORM
THE CITY OF NEW YORK
DEPARTMENT OF DESIGN AND CONSTRUCTION
DIVISION OF INFRASTRUCTURE

**BID FOR FURNISHING ALL LABOR AND
MATERIAL NECESSARY AND REQUIRED FOR:**

PROJECT ID: HWQ121B4

RECONSTRUCTION OF LAKEVIEW BOULEVARD EAST

LAKEVIEW LANE - FROM BAISLEY BOULEVARD TO 122ND AVENUE
122ND AVENUE - FROM LAKEVIEW LANE TO LAKEVIEW BOULEVARD EAST
LAKEVIEW BOULEVARD EAST - FROM 122ND AVENUE TO 118TH AVENUE
118TH AVENUE - FROM LAKEVIEW BOULEVARD EAST TO LONG STREET

NEW STORM AND SANITARY SEWERS (SEQ200436) IN:

LAKEVIEW LANE - FROM BAISLEY BOULEVARD TO 122ND AVENUE
122ND AVENUE - FROM LAKEVIEW LANE TO LAKEVIEW BOULEVARD EAST
LAKEVIEW BOULEVARD EAST - FROM 122ND AVENUE TO 118TH AVENUE
119TH AVENUE - FROM LONG STREET TO 164TH STREET
164TH STREET - FROM 119TH AVENUE TO 120TH AVENUE

CAPITAL PROJECT WM-1

WATER MAIN WORK IN:

LAKEVIEW LANE - FROM BAISLEY BOULEVARD TO 122ND AVENUE
122ND AVENUE - FROM LAKEVIEW LANE TO LAKEVIEW BOULEVARD EAST
LAKEVIEW BOULEVARD EAST - FROM 122ND AVENUE TO 118TH AVENUE
118TH AVENUE - FROM LAKEVIEW BOULEVARD EAST TO LONG STREET
119TH AVENUE - FROM LONG STREET TO 164TH STREET
164TH STREET - FROM 119TH AVENUE TO 120TH AVENUE

INCLUDING STREET LIGHTING AND TRAFFIC WORK

Together With All Work Incidental Thereto

**BOROUGH OF QUEENS
CITY OF NEW YORK**

Name of Bidder: P#T II Contracting Corp.

Date of Bid Opening: June 16, 2015

Bidder is: (Check one, whichever applies) Individual () Partnership () Corporation ()

Place of Business of Bidder: 2417 Seicho tpke #315 Garden City Parks, N.Y. 11040

Bidder's Telephone Number: 718.206.0245 Fax Number: 918.206.0083

Bidder's E-Mail Address: ptacontracting@gmail.com

Residence of Bidder (If Individual): _____

If Bidder is a Partnership, fill in the following blanks:

Names of Partners

Residence of Partners

If Bidder is a Corporation, fill in the following blanks:

Organized under the laws of the State of New York.

Name and Home Address of President: Lenny Pereira

57 Ledgewood Dr. Smithtown, N.Y. 1

Name and Home Address of Secretary: Daniel McCallan

1023 Friendly Rd. Upper Brookville, N.Y.

Name and Home Address of Treasurer: _____

BID FORM

The above-named Bidder affirms and declares:

1. The said bidder is of lawful age and the only one interested in this bid; and no person, firm or corporation other than hereinbefore named has any interest in this bid, or in the Contract proposed to be taken.
2. By submission of this bid, each bidder and each person signing on behalf of any bidder certifies, and in the case of a joint bid each party thereto certifies as to its own organization, under penalty of perjury, that to the best of its knowledge and belief: (1) the prices in this bid have been arrived at independently without collusion, consultation, communication or agreement, for the purpose of restricting competition, as to any matter relating to such prices with any other bidder or with any competitor; (2) unless otherwise required by law, the prices quoted in this bid have not been knowingly disclosed by the bidder and will not knowingly be disclosed by the bidder prior to opening, directly or indirectly, to any other bidder or to any competitor; and (3) No attempt has been made or will be made by the bidder to induce any other person, partnership or corporation to submit or not to submit a bid for the purpose of restricting competition.
3. No councilman or other officer or employee or person whose salary is payable in whole or in part from the City Treasury is directly or indirectly interested in this bid, or in the supplies, materials, equipment, work or labor to which it relates, or in any of the profits thereof.
4. The bidder is not in arrears to the City of New York upon debt or contract or taxes, and is not a defaulter, as surety or otherwise, upon any obligation of the City of New York, and has not been declared not responsible, or disqualified, by any agency of the City of New York or State of New York, nor is there any proceeding pending relating to the responsibility or qualification of the bidder to receive public contracts except as set forth on the Affirmation included as page C-6 of this Bid Booklet.

The bidder hereby affirms that it has paid all applicable City income, excise and other taxes for all years it has conducted business activities in New York City.

5. The bidder, as an individual, or as a member, partner, director or officer of the bidder, if the same be a firm, partnership or corporation, executes this document expressly warranting and representing that should this bid be accepted by the City and the Contract awarded to him, he and his subcontractors engaged in the performance: (1) will comply with the provisions of Section 6-108 of the Administrative Code of the City of New York and the non-discrimination provisions of Section 220a of the New York State Labor Law, as more expressly and in detail set forth in the Agreement; (2) will comply with Section 6-109 of the Administrative Code of the City of New York in relation to minimum wages and other stipulations as more expressly and in detail set forth in the Agreement; (3) have complied with the provisions of the aforesaid laws since their respective effective dates, and (4) will post notices to be furnished by the City, setting forth the requirements of the aforesaid laws in prominent and conspicuous places in each and every plant, factory, building and structure where employees engaged in the performance of the Contract can readily view it, and will continue to keep such notices posted until the supplies, materials and equipment, or work labor and services required to be furnished or rendered by the Contractor have been finally accepted by the City. In the event of any breach or violation of the foregoing, the Contractor may be subject to damages, liquidated or otherwise, cancellation of the Contract and suspension as a bidder for a period of three years. (The words, "the bidder", "he", "his", and "him" where used herein shall mean the individual bidder, firm, partnership or corporation executing this bid).

AFFIRMATION

PROJECT ID. HWQ121B4

The undersigned bidder affirms and declares that said bidder is not in arrears to the City of New York upon debt, contract or taxes and is not a defaulter, as surety or otherwise, upon obligation to the City of New York, and has not been declared not responsible, or disqualified, by any agency of the City of New York, nor is there any proceeding pending relating to the responsibility or qualification of the bidder to receive public contracts except: NONE

(If none, the bidder shall insert the word "None" in the space provided above.)

Full Name of Bidder: P&T II Contracting Corp.
Address: 2417 Jericho tpke # 315
City Garden City Park, State N.Y. Zip Code 11040

CHECK ONE BOX AND INCLUDE APPROPRIATE NUMBER:

A - Individual or Sole Proprietorship*
SOCIAL SECURITY NUMBER

B - Partnership, Joint Venture or other unincorporated organization
EMPLOYER IDENTIFICATION NUMBER

C - Corporation
EMPLOYER IDENTIFICATION NUMBER

20.4708892

By: _____

Signature

Title: _____

If a corporation, place seal here

This affirmation must be signed by an officer or duly authorized representative.

*Under the Federal Privacy Act the furnishing of Social Security Numbers by bidders on City contracts is voluntary. Failure to provide a Social Security Number will not result in a bidder's disqualification. Social Security Numbers will be used to identify bidders, proposers or vendors to ensure their compliance with laws, to assist the City in enforcement of laws, as well as to provide the City a means of identifying of businesses which seek City contracts.

(NO TEXT ON THIS PAGE)

BID SCHEDULE

- NOTE:**
- (1) The Agency may reject a bid if it contains unbalanced bid prices. An unbalanced bid is considered to be one containing lump sum or unit items which do not reflect reasonable actual costs plus a reasonable proportionate share of the Bidder's anticipated profit, overhead costs, and other indirect costs, anticipated for the performance of the items in question.
 - (2) The following bid prices on Unit Price Contracts are to be paid for the actual quantities of the item numbers in the completed work or structure, and they cover the cost of all work, labor, material, tools, plant and appliances of every description necessary to complete the entire work, as specified, and the removal of all debris, temporary work and appliances.
 - (3) PLEASE BE SURE A LEGIBLE BID IS ENTERED, IN INK, FOR EACH ITEM.
Alterations must be initialed in ink by the bidder.
 - (4) The Extended Amount entered in Column 6 shall be the product of the Estimated Quantity in Column 3 times the Unit Price Bid in Column 5.
 - (5) Prospective bidders must examine the Bid Schedule carefully and, before bidding, must advise the Commissioner, in writing, if any pages are missing, and must request that such missing pages be furnished them. The pages of this Bid Schedule are numbered consecutively, as follows:
B - 3 Through B - 43

PLEASE BE SURE A LEGIBLE BID IS ENTERED FOR EACH ITEM.
THE BIDDER SHALL INSERT THE TOTAL BID PRICE IN
THE BID FORM ON PAGE C-4 OF THIS BID BOOKLET.

BID SCHEDULE FORM

COL 1 SEQ. NO.	COL 2 ITEM NUMBER and DESCRIPTION	COL 3 ENGINEERS ESTIMATE OF QUANTITY	COL 4 UNIT	COL 5 UNIT PRICE (IN FIGURES) DOLLARS	COL 6 EXTENDED AMOUNT (IN FIGURES) DOLLARS
001	4.02 AB-R ASPHALTIC CONCRETE WEARING COURSE, 1-1/2" THICK	356.00	S.Y.	18	6,408
002	4.02 AF-R ASPHALTIC CONCRETE WEARING COURSE, 2" THICK	6,485.00	S.Y.	22	142,670
003	4.02 AG ASPHALTIC CONCRETE WEARING COURSE, 3" THICK	12,500.00	S.Y.	28	350,000
004	4.02 CB ASPHALTIC CONCRETE MIXTURE	4,974.00	TONS	150	746,100
005	4.04 AC CONCRETE BASE FOR PAVEMENT, 6" THICK, CLASS B-32	2,020.00	C.Y.	250	505,000
006	4.04 H CONCRETE BASE FOR PAVEMENT, VARIABLE THICKNESS FOR TRENCH RESTORATION, (HIGH-EARLY STRENGTH)	288.00	C.Y.	350	100,800

3/25/2015 12:00 AM

NEW YORK CITY DEPARTMENT OF DESIGN AND CONSTRUCTION
 DIVISION OF INFRASTRUCTURE - BUREAU OF DESIGN

PROJECT ID: HWQ121B4

CONTRACT PIN: 8502015HW0021C

BID SCHEDULE FORM

COL 1 SEQ. NO.	COL 2 ITEM NUMBER and DESCRIPTION	COL 3 ENGINEER'S ESTIMATE OF QUANTITY	COL 4 UNIT	COL 5 UNIT PRICE (IN FIGURES) DOLLARS CTS	COL 6 EXTENDED AMOUNT (IN FIGURES) DOLLARS CTS
007	4.08 AA CONCRETE CURB (18" DEEP)	6,895.00	L.F.	35 -	241,325 -
008	4.09 AD STRAIGHT STEEL FACED CONCRETE CURB (18" DEEP)	270.00	L.F.	65 -	17,550 -
009	4.09 CD CORNER STEEL FACED CONCRETE CURB (18" DEEP)	740.00	L.F.	125 -	92,500 -
010	4.11 CA FILL, PLACE MEASUREMENT	1,660.00	C.Y.	15 -	24,900 -
011	4.13 AAS 4" CONCRETE SIDEWALK (UNPIGMENTED)	29,180.00	S.F.	10 -	291,800 -
012	4.13 BAS 7" CONCRETE SIDEWALK (UNPIGMENTED)	6,590.00	S.F.	12 50	82,375 -

3/25/2015 12:00 AM

NEW YORK CITY DEPARTMENT OF DESIGN AND CONSTRUCTION
DIVISION OF INFRASTRUCTURE - BUREAU OF DESIGN

PROJECT ID: HWQ121B4

CONTRACT PIN: 8502015HW0021C

BID SCHEDULE FORM

COL 1 SEQ. NO.	COL 2 ITEM NUMBER and DESCRIPTION	COL 3 ENGINEER'S ESTIMATE OF QUANTITY	COL 4 UNIT	COL 5 UNIT PRICE (IN FIGURES)		COL 6 EXTENDED AMOUNT (IN FIGURES)	
				DOLLARS	CTS	DOLLARS	CTS
013	4.13 DE EMBEDDED PREFORMED DETECTABLE WARNING UNITS	400.00	S.F.				
014	4.15 TOPSOIL	145.00	C.Y.	19	-	7,600	-
015	4.15 SS STRUCTURAL SOIL FOUNDATION MATERIAL	336.00	C.Y.	110	-	15,950	-
016	4.16 AA TREES REMOVED (4" TO UNDER 12" CALIPER)	4.00	EACH	150	-	50,400	-
017	4.16 AB TREES REMOVED (12" TO UNDER 18" CALIPER)	7.00	EACH				
018	4.16 AC TREES REMOVED (18" TO UNDER 24" CALIPER)	1.00	EACH				
				500	-	2,000	-
				1000	-	7,000	-
				1500	-	1,500	-

3/25/2015 12:00 AM

NEW YORK CITY DEPARTMENT OF DESIGN AND CONSTRUCTION
 DIVISION OF INFRASTRUCTURE - BUREAU OF DESIGN

PROJECT ID: HWQ121B4

CONTRACT PIN: 8502015HW0021C

BID SCHEDULE FORM

COL 1 SEQ. NO.	COL 2 ITEM NUMBER AND DESCRIPTION	COL 3 ENGINEERS ESTIMATE OF QUANTITY	COL 4 UNIT	COL 5 UNIT PRICE (IN FIGURES) DOLLARS	COL 6 EXTENDED AMOUNT (IN FIGURES) DOLLARS
019	4.16 AD TREES REMOVED (24" CALIPER AND COVER)	1.00	EACH	-	-
020	4.16 CAS TREES PLANTED, 3" TO 3-1/2" CALIPER, LIQUIDAMBER STYRACIFLUA	3.00	EACH	2500	2500
021	4.16 CC TREES PLANTED, 3" TO 3-1/2" CALIPER, GLED. TRIACAN. INERMIS	2.00	EACH	1250	3750
022	4.16 CGBPS TREES PLANTED, 3" TO 3-1/2" CALIPER, GINKGO BILOBA "PRINCENTON SE"	8.00	EACH	1250	2,500
023	4.16 COT TREES PLANTED, 3" TO 3-1/2" CALIPER, COTINUS OBOVATUS	6.00	EACH	1250	10,000
024	4.16 CPC TREES PLANTED, 3" TO 3-1/2" CALIPER, PRUNUS CERASIFERA	4.00	EACH	1250	7500
				1250	5000

BID SCHEDULE FORM

COL 1 SEQ. NO.	COL 2 ITEM NUMBER and DESCRIPTION	COL 3 ENGINEER'S ESTIMATE OF QUANTITY	COL 4 UNIT	COL 5 UNIT PRICE (IN FIGURES)		COL 6 EXTENDED AMOUNT (IN FIGURES)	
				DOLLARS	CTS	DOLLARS	CTS
025	4.16 CQ TREES PLANTED, 3" TO 3-1/2" CALIPER, AMELANCHIER	5.00	EACH	1250	-	6250	-
026	4.16 CSRI TREES PLANTED, 3" TO 3-1/2" CALIPER, SYRINGA RETICULATA "IVORY SILK"	11.00	EACH	1250	-	13,750	-
027	4.16 CV TREES PLANTED, 2-1/2" TO 3" CALIPER, CRATAEGUS VIRIDIS "WINTER KING"	7.00	EACH	1000	-	7,000	-
028	4.16 HCC TREES PLANTED, 7 TO 8' HIGH, CERCIS CANADENSIS	13.00	EACH	1000	-	13,000	-
029	4.16 HCK TREES PLANTED, 10 TO 12 FEET HIGH, SINGLE STEM SP. CORNUS KOUSA	6.00	EACH	1000	-	6,000	-
030	4.18 A MAINTENANCE TREE PRUNING (UNDER 12" CAL.)	72.00	EACH	250	-	18,000	-

3/25/2015 12:00 AM

NEW YORK CITY DEPARTMENT OF DESIGN AND CONSTRUCTION
 DIVISION OF INFRASTRUCTURE - BUREAU OF DESIGN

PROJECT ID: HWQ121B4

CONTRACT PIN: 8502015HW0021C

BID SCHEDULE FORM

COL 1 SEQ. NO.	COL 2 ITEM NUMBER and DESCRIPTION	COL 3 ENGINEER'S ESTIMATE OF QUANTITY	COL 4 UNIT	COL 5 UNIT PRICE (IN FIGURES) DOLLARS - CTS.	COL 6 EXTENDED AMOUNT (IN FIGURES) DOLLARS - CTS.
031	4.18 B MAINTENANCE TREE PRUNING (12" TO UNDER 18" CAL.)	21.00	EACH	350 -	7350 -
032	4.18 C MAINTENANCE TREE PRUNING (18" TO UNDER 24" CAL.)	2.00	EACH	450 -	900 -
033	4.18 D MAINTENANCE TREE PRUNING (24" CAL. AND OVER)	9.00	EACH	600 -	5400 -
034	4.18 R TREE ROOT PRUNING (UNDER 12" Cal.)	1.00	EACH	500 -	500 -
035	4.18 RP ROOT PRUNING	33.00	EACH	500 -	16,500 -
036	4.19 SODDING	1,085.00	S.Y.	5 -	5425 -

BID SCHEDULE FORM

COL 1 SEC. NO.	COL 2 ITEM NUMBER and DESCRIPTION	COL 3 ENGINEER'S ESTIMATE OF QUANTITY	COL 4 UNIT	COL 5 UNIT PRICE (IN FIGURES)		COL 6 EXTENDED AMOUNT (IN FIGURES)	
				DOLLARS	CTS	DOLLARS	CTS
037	4.20 SEEDING	4,822.00	S.Y.	1	50	7233	-
038	4.21 TREE CONSULTANT	1,440.00	P/HR	63	50	91,440	-
039	50.21M3C024D 24" R.C.P. CLASS III STORM SEWER, ON CONCRETE CRADLE	254.00	L.F.	425	-	107,950	-
040	50.21M3C030D 30" R.C.P. CLASS III STORM SEWER, ON CONCRETE CRADLE	100.00	L.F.	525	-	52,500	-
041	50.21M3C036D 36" R.C.P. CLASS III STORM SEWER, ON CONCRETE CRADLE	929.00	L.F.	675	-	627,075	-
042	50.21M3E024D 24" R.C.P. CLASS III STORM SEWER, ENCASED IN CONCRETE	528.00	L.F.	500	-	264,000	-

3/25/2015 12:00 AM

NEW YORK CITY DEPARTMENT OF DESIGN AND CONSTRUCTION
DIVISION OF INFRASTRUCTURE - BUREAU OF DESIGN

PROJECT ID: HWQ121B4

CONTRACT PIN: 8502015HW0021C

BID SCHEDULE FORM

COL 1 SEQ. NO.	COL 2 ITEM NUMBER AND DESCRIPTION	COL 3 ENGINEER'S ESTIMATE OF QUANTITY	COL 4 UNIT	COL 5 UNIT PRICE (IN FIGURES) DOLLARS	COL 6 EXTENDED AMOUNT (IN FIGURES) DOLLARS	COL 7 CTS
043	50.21M3E030D 30" R.C.P. CLASS III STORM SEWER, ENCASED IN CONCRETE	532.00	L.F.	550	292,600	-
044	50.21M3E030W 30"W X 19"H R.C.P. CLASS HE-III STORM SEWER, ENCASED IN CONCRETE	370.00	L.F.	725	268,250	-
045	50.21M3E036D 36" R.C.P. CLASS III STORM SEWER, ENCASED IN CONCRETE	31.00	L.F.	775	24,025	-
046	50.21M3E038W 38"W X 24"H R.C.P. CLASS HE-III STORM SEWER, ENCASED IN CONCRETE	472.00	L.F.	900	424,800	-
047	50.21M3E042D 42" R.C.P. CLASS III STORM SEWER, ENCASED IN CONCRETE	120.00	L.F.	1000	120,000	-
048	50.31MC12 12" E.S.V.P. STORM SEWER, ON CONCRETE CRADLE	43.00	L.F.	325	13975	-

BID SCHEDULE FORM

COL 1 SEQ. NO.	COL 2 ITEM NUMBER and DESCRIPTION	COL 3 ENGINEER'S ESTIMATE OF QUANTITY	COL 4 UNIT	COL 5 UNIT PRICE (IN FIGURES)		COL 6 EXTENDED AMOUNT (IN FIGURES) DOLLARS
				DOLLARS	CTS	
049	50.31MC15 15" E.S.V.P. STORM SEWER, ON CONCRETE CRADLE	77.00	L.F.	350	-	26,950
050	50.31MC18 18" E.S.V.P. STORM SEWER, ON CONCRETE CRADLE	328.00	L.F.	375	-	123,000
051	50.31ME12 12" E.S.V.P. STORM SEWER, ENCASED IN CONCRETE	30.00	L.F.	400 300	-	12,000 9,000
052	50.31ME18 18" E.S.V.P. STORM SEWER, ENCASED IN CONCRETE	306.00	L.F.	425	-	130,050
053	50.31SC10 10" E.S.V.P. SANITARY SEWER, ON CONCRETE CRADLE	518.00	L.F.	869	-	450,142
054	50.31SE08 8" E.S.V.P. SANITARY SEWER, ENCASED IN CONCRETE	30.00	L.F.	675	-	20,250

3/25/2015 12:00 AM

NEW YORK CITY DEPARTMENT OF DESIGN AND CONSTRUCTION
 DIVISION OF INFRASTRUCTURE - BUREAU OF DESIGN

PROJECT ID: HWQ121B4

CONTRACT PIN: 8502015HW0021C

BID SCHEDULE FORM

COL 1 SEQ. NO	COL 2 ITEM NUMBER and DESCRIPTION	COL 3 ENGINEER'S ESTIMATE OF QUANTITY	COL 4 UNIT	COL 5 UNIT PRICE (IN FIGURES) DOLLARS CTS	COL 6 EXTENDED AMOUNT (IN FIGURES) DOLLARS CTS
055	50.41S6E08 8" D.I.P. CLASS 56 SANITARY SEWER, ENCASED IN CONCRETE	125.00	L.F.	1250 -	156,250 -
056	51.11C001 CHAMBER NO. 1	1.00	EACH	48000 -	48,000 -
057	51.11C002 CHAMBER NO. 2	1.00	EACH	48000 -	48,000 -
058	51.11C003 CHAMBER NO. 3	1.00	EACH	48000 -	48,000 -
059	51.11C004 CHAMBER NO. 4	1.00	EACH	48000 -	48,000 -
060	51.11P004 STANDARD 4'-0" DIAMETER PRECAST MANHOLE	2.00	EACH	4000 -	8,000 -

BID SCHEDULE FORM

COL 1 SEQ NO	COL 2 ITEM NUMBER and DESCRIPTION	COL 3 ENGINEER'S ESTIMATE OF QUANTITY	COL 4 UNIT	COL 5 UNIT PRICE (IN FIGURES)		COL 6 EXTENDED AMOUNT (IN FIGURES)	
				DOLLARS	CTS	DOLLARS	CTS
061	51.11P005 STANDARD 5'-0" DIAMETER PRECAST MANHOLE	6.00	EACH	5000	-	30,000	-
062	51.11P006 STANDARD 6'-0" DIAMETER PRECAST MANHOLE	2.00	EACH	6000	-	12,000	-
063	51.21S0A1000V STANDARD MANHOLE TYPE A-1	13.00	EACH	3500	-	45,500	-
064	51.21S0A3000V STANDARD SHALLOW MANHOLE TYPE A-3	7.00	EACH	3500	-	24,500	-
065	51.21S0C1036R STANDARD MANHOLE TYPE C-1 ON 36" R.C.P. SEWER	5.00	EACH	7500	-	37,500	-
066	51.21S0E1030H STANDARD MANHOLE TYPE E-1 ON 30"W X 19"H H.E.R.C.P. SEWER	3.00	EACH	10000	-	30,000	-

3/25/2015 12:00 AM

NEW YORK CITY DEPARTMENT OF DESIGN AND CONSTRUCTION
 DIVISION OF INFRASTRUCTURE - BUREAU OF DESIGN

PROJECT ID: HWQ121B4

CONTRACT PIN: 8502015HW0021C

BID SCHEDULE FORM

COL 1 SEQ. NO.	COL 2 ITEM NUMBER AND DESCRIPTION	COL 3 ENGINEER'S ESTIMATE OF QUANTITY	COL 4 UNIT	COL 5 UNIT PRICE (IN FIGURES) DOLLARS	COL 6 EXTENDED AMOUNT (IN FIGURES) DOLLARS	CTS
067	51.21S0E1038H STANDARD MANHOLE TYPE E-1 ON 38"W X 24"H H.E.R.C.P. SEWER	3.00	EACH	12,500	37,500	-
068	51.23RF REPLACEMENT OF EXISTING MANHOLE FRAME AND COVER	14.00	EACH	900	12,600	-
069	51.41S001 STANDARD CATCH BASIN, TYPE 1	49.00	EACH	7000	343,000	-
070	51.41S002 STANDARD CATCH BASIN, TYPE 2	1.00	EACH	7000	7000	-
071	51.41S003 STANDARD CATCH BASIN, TYPE 3	1.00	EACH	11,000	11,000	-
072	52.11D12 12" DUCTILE IRON PIPE BASIN CONNECTION	618.00	L.F.	275	169,950	-

BID SCHEDULE FORM

COL. 1 SEQ. NO.	COL. 2 ITEM NUMBER and DESCRIPTION	COL. 3 ENGINEER'S ESTIMATE OF QUANTITY	COL. 4 UNIT	COL. 5 UNIT PRICE (IN FIGURES)		COL. 5 EXTENDED AMOUNT (IN FIGURES)	
				DOLLARS	CTS	DOLLARS	CTS
073	52.31D06S08 6" DUCTILE IRON PIPE SPUR FOR HOUSE CONNECTION ON 8" D.I.P. SANITARY SEWER	2.00	EACH	1000	-	2000	-
074	52.31V06S08 6" E.S.V.P. SPUR FOR HOUSE CONNECTION ON 8" E.S.V.P. SANITARY SEWER	4.00	EACH	500	-	2,000	-
075	52.31V06S10 6" E.S.V.P. SPUR FOR HOUSE CONNECTION ON 10" E.S.V.P. SANITARY SEWER	22.00	EACH	500	-	11,000	-
076	52.41D06R 6" D.I.P. HOUSE CONNECTION DRAIN ON CONCRETE CRADLE (RECONNECTION)	12.00	L.F.	75	-	900	-
077	52.41V06R 6" E.S.V.P. HOUSE CONNECTION DRAIN ON CONCRETE CRADLE (RECONNECTION)	156.00	L.F.	50	-	7800	-
078	53.11DR TELEVISION INSPECTION AND DIGITAL AUDIO-VISUAL RECORDING OF SEWERS	4,991.00	L.F.	3	-	14973	-

3/25/2015 12:00 AM

NEW YORK CITY DEPARTMENT OF DESIGN AND CONSTRUCTION
 DIVISION OF INFRASTRUCTURE - BUREAU OF DESIGN

PROJECT ID: HWQ121B4

CONTRACT PIN: 8502015HW0021C

BID SCHEDULE FORM

COL 1 SEQ. NO.	COL 2 ITEM NUMBER and DESCRIPTION	COL 3 ENGINEERS ESTIMATE OF QUANTITY	COL 4 UNIT	COL 5 UNIT PRICE (IN FIGURES) DOLLARS	COL 6 EXTENDED AMOUNT (IN FIGURES) DOLLARS	C.T.S.
079	6.01 AC CLEARING AND GRUBBING	720.00	S.Y.	50	36,000	-
080	6.02 AAN UNCLASSIFIED EXCAVATION	4,696.00	C.Y.	65	305,240	-
081	6.02 PA PNEUMATIC EXCAVATION AROUND TREES	1.00	C.Y.	500	500	-
082	6.24 ASPHALTIC CONCRETE SIDEWALK	2,203.00	S.F.	50	110,150	-
083	6.25 RS TEMPORARY SIGNS	3,435.00	S.F.	0	34	35
084	6.26 TIMBER CURB	3,490.00	L.F.	0	34	90

3/25/2015 12:00 AM

NEW YORK CITY DEPARTMENT OF DESIGN AND CONSTRUCTION
 DIVISION OF INFRASTRUCTURE - BUREAU OF DESIGN

PROJECT ID: HWQ121B4

CONTRACT PIN: 8502015HW0021C

BID SCHEDULE FORM

COL 1 SEG NO	COL 2 ITEM NUMBER and DESCRIPTION	COL 3 ENGINEERS ESTIMATE OF QUANTITY	COL 4 UNIT	COL 5 UNIT PRICE (IN FIGURES) DOLLARS	COL 6 EXTENDED AMOUNT (IN FIGURES) DOLLARS	CTS
085	6.28 AA LIGHTED TIMBER BARRICADES	2,160.00	L.F.	0	21,600	-
086	6.30 AR REMOVE EXISTING GUIDE RAIL	360.00	L.F.	50	18,000	-
087	6.30 RE RELOCATE BEAM TYPE GUIDE RAIL	12.00	L.F.	125	1,500	-
088	6.36 DR STRUCTURAL REPAIR AND ADJUSTMENT OF UTILITY STRUCTURES	20.00	C.Y.	0	0	20
089	6.40 D ENGINEER'S FIELD OFFICE (TYPE D)	30.00	MONTH	4000	120,000	-
090	6.41 LINE AND GRADE SURVEYS	1.00	L.S.	25000	25,000	-

3/25/2015 12:00 AM

NEW YORK CITY DEPARTMENT OF DESIGN AND CONSTRUCTION
 DIVISION OF INFRASTRUCTURE - BUREAU OF DESIGN

PROJECT ID: HWQ121B4

CONTRACT PIN: 8502015HW0021C

BID SCHEDULE FORM

COL 1 SEQ. NO.	COL 2 ITEM NUMBER AND DESCRIPTION	COL 3 ENGINEER'S ESTIMATE OF QUANTITY	COL 4 UNIT	COL 5 UNIT PRICE (IN FIGURES) DOLLARS	COL 6 EXTENDED AMOUNT (IN FIGURES) DOLLARS	COL 7 CTS
091	6.43 PHOTOGRAPHS	1,680.00	SETS	20 -	33,600 -	-
092	6.44 THERMOPLASTIC REFLECTORIZED PAVEMENT MARKINGS (4" WIDE)	10,200.00	L.F.	1 75	17850 -	-
093	6.49 TEMPORARY PAVEMENT MARKINGS (4" WIDE)	4,500.00	L.F.	0 01	45 -	-
094	6.50 CLEANING OF DRAINAGE STRUCTURES	7.00	EACH	1000 -	7000 -	-
095	6.52 CG CROSSING GUARD	6,000.00	P/HR	0 01	600 -	-
096	6.53 REMOVE EXISTING LANE MARKINGS (4" WIDE)	200.00	L.F.	1 -	200 -	-

3/25/2015 12:00 AM

NEW YORK CITY DEPARTMENT OF DESIGN AND CONSTRUCTION
DIVISION OF INFRASTRUCTURE - BUREAU OF DESIGN

PROJECT ID: HWQ121B4

CONTRACT PIN: 8502015HW0021C

BID SCHEDULE FORM

COL 1 SEQ. NO.	COL 2 ITEM NUMBER and DESCRIPTION	COL 3 ENGINEERS ESTIMATE OF QUANTITY	COL 4 UNIT	COL 5 UNIT PRICE (IN FIGURES)		COL 6 EXTENDED AMOUNT (IN FIGURES)	
				DOLLARS	CTS	DOLLARS	CTS
097	6.55 SAWCUTTING EXISTING PAVEMENT	660.00	L.F.	1	-	660	-
098	6.74 B STEEL EDGING STRIP	514.00	L.F.	75	-	38,550	-
099	6.75 GRINDING EXISTING ASPHALTIC CONCRETE WEARING COURSE	530.00	C.Y.	135	-	71,550	-
100	6.82 A REMOVING EXISTING TRAFFIC AND STREET NAME SIGNS	210.00	S.F.	10	-	2100	-
101	6.82 B REMOVING EXISTING TRAFFIC AND STREET NAME SIGN POSTS	160.00	L.F.	10	-	1600	-
102	6.83 AA FURNISHING NEW NON-REFLECTORIZED TRAFFIC SIGNS	30.00	S.F.	25	-	750	-

3/25/2015 12:00 AM

NEW YORK CITY DEPARTMENT OF DESIGN AND CONSTRUCTION
 DIVISION OF INFRASTRUCTURE - BUREAU OF DESIGN

PROJECT ID: HWQ121B4

CONTRACT PIN: 8502015HW0021C

BID SCHEDULE FORM

COL 1 SEQ. NO.	COL 2 ITEM NUMBER and DESCRIPTION	COL 3 ENGINEER'S ESTIMATE OF QUANTITY	COL 4 UNIT	COL 5 UNIT PRICE (IN FIGURES) DOLLARS CTS	COL 6 EXTENDED AMOUNT (IN FIGURES) DOLLARS CTS
103	6.83 AB FURNISHING NEW TRAFFIC SIGN POSTS	360.00	L.F.	10 -	3600 -
104	6.83 AR FURNISHING NEW REFLECTORIZED TRAFFIC SIGNS	170.00	S.F.	25 -	4250 -
105	6.83 BA INSTALLING TRAFFIC SIGNS	200.00	S.F.	10 -	2000 -
106	6.83 BB INSTALLING TRAFFIC SIGN POSTS	360.00	L.F.	10 -	3600 -
107	6.86 AA FURNISHING NEW STREET NAME SIGNS	100.00	S.F.	50 -	5000 -
108	6.86 AB FURNISHING NEW STREET NAME SIGN POSTS	260.00	L.F.	20 -	5200 -

BID SCHEDULE FORM

COL 1 SEQ. NO.	COL 2 ITEM NUMBER and DESCRIPTION	COL 3 ENGINEER'S ESTIMATE OF QUANTITY	COL 4 UNIT	COL 5 UNIT PRICE (IN FIGURES)		COL 6 EXTENDED AMOUNT (IN FIGURES)	
				DOLLARS	CTS	DOLLARS	CTS
109	6.86 BA INSTALLING STREET NAME SIGNS	100.00	S.F.	50	-	5000	-
110	6.86 BB INSTALLING STREET NAME SIGN POSTS	260.00	L.F.	20	-	5200	-
111	6.87 PLASTIC BARRELS	555.00	EACH	6	01	5	55
112	6.91 REFLECTIVE CRACKING MEMBRANE (18" WIDE)	9,380.00	L.F.	3	-	28,140	-
113	6.99 AUDIO AND VIDEO DOCUMENTATION SURVEY	1.00	L.S.	10000	-	10,000	-
114	60.11R516 FURNISHING AND DELIVERING 16-INCH DUCTILE IRON RESTRAINED JOINT PIPE (CLASS 55)	30.00	L.F.	125	-	3750	-

3/25/2015 12:00 AM

NEW YORK CITY DEPARTMENT OF DESIGN AND CONSTRUCTION
 DIVISION OF INFRASTRUCTURE - BUREAU OF DESIGN

PROJECT ID: HWQ121B4

CONTRACT PIN: 8502015HW0021C

BID SCHEDULE FORM

COL 1 SEQ. NO.	COL 2 ITEM NUMBER and DESCRIPTION	COL 3 ENGINEER'S ESTIMATE OF QUANTITY	COL 4 UNIT	COL 5 UNIT PRICE (IN FIGURES) DOLLARS	COL 6 EXTENDED AMOUNT (IN FIGURES) DOLLARS
115	60.11R520 FURNISHING AND DELIVERING 20-INCH DUCTILE IRON RESTRAINED JOINT PIPE (CLASS 55)	130.00	L.F.	125 -	16,250 -
116	60.11R606 FURNISHING AND DELIVERING 6-INCH DUCTILE IRON RESTRAINED JOINT PIPE (CLASS 56)	240.00	L.F.	25 -	6,000 -
117	60.11R608 FURNISHING AND DELIVERING 8-INCH DUCTILE IRON RESTRAINED JOINT PIPE (CLASS 56)	4,150.00	L.F.	50 -	207,500 -
118	60.11R612 FURNISHING AND DELIVERING 12-INCH DUCTILE IRON RESTRAINED JOINT PIPE (CLASS 56)	210.00	L.F.	75 -	15,750 -
119	60.12D06 LAYING 6-INCH DUCTILE IRON PIPE AND FITTINGS	260.00	L.F.	100 -	26,000 -
120	60.12D08 LAYING 8-INCH DUCTILE IRON PIPE AND FITTINGS	4,535.00	L.F.	150 -	680,250 -

BID SCHEDULE FORM

COL 1 SEQ. NO.	COL 2 ITEM NUMBER and DESCRIPTION	COL 3 ENGINEER'S ESTIMATE OF QUANTITY	COL 4 UNIT	COL 5 UNIT PRICE (IN FIGURES) DOLLARS CTS	COL 6 EXTENDED AMOUNT (IN FIGURES) DOLLARS
121	60.12D12 LAYING 12-INCH DUCTILE IRON PIPE AND FITTINGS	250.00	L.F.	200	50,000 -
122	60.12D16 LAYING 16-INCH DUCTILE IRON PIPE AND FITTINGS	40.00	L.F.	275	11,000 -
123	60.12D20 LAYING 20-INCH DUCTILE IRON PIPE AND FITTINGS	160.00	L.F.	275	44,000 -
124	60.13M0A24 FURNISHING AND DELIVERING DUCTILE IRON MECHANICAL JOINT 24-INCH DIAMETER AND SMALLER FITTINGS, INCLUDING WEDGE TYPE RETAINER GLANDS	14.00	TONS	8400	117,600 -
125	60.18BJC20EL FURNISHING, DELIVERING AND INSTALLING BELL JOINT CLAMPS, COMPLETE FOR 20-INCH PIPE AND LESS	26.00	EACH	0	0 26 -

3/25/2015 12:00 AM

NEW YORK CITY DEPARTMENT OF DESIGN AND CONSTRUCTION
 DIVISION OF INFRASTRUCTURE - BUREAU OF DESIGN

PROJECT ID: HWQ121B4

CONTRACT PIN: 8502015HW0021C

BID SCHEDULE FORM

COL 1 SEQ NO	COL 2 ITEM NUMBER and DESCRIPTION	COL 3 ENGINEERS ESTIMATE OF QUANTITY	COL 4 UNIT	COL 5 UNIT PRICE (IN FIGURES) DOLLARS	COL 6 EXTENDED AMOUNT (IN FIGURES) DOLLARS
126	61.11DMM06 FURNISHING AND DELIVERING 6-INCH MECHANICAL JOINT DUCTILE IRON GATE VALVE COMPLETE WITH WEDGE TYPE RETAINER GLANDS	16.00	EACH	1500 -	24,000 -
127	61.11DMM08 FURNISHING AND DELIVERING 8-INCH MECHANICAL JOINT DUCTILE IRON GATE VALVE COMPLETE WITH WEDGE TYPE RETAINER GLANDS	17.00	EACH	2000 -	34,000 -
128	61.11DMM12 FURNISHING AND DELIVERING 12-INCH MECHANICAL JOINT DUCTILE IRON GATE VALVE COMPLETE WITH WEDGE TYPE RETAINER GLANDS	1.00	EACH	5000 -	5,000 -
129	61.11DMM20 FURNISHING AND DELIVERING 20-INCH MECHANICAL JOINT DUCTILE IRON GATE VALVE COMPLETE WITH WEDGE TYPE RETAINER GLANDS	1.00	EACH	19000 -	19,000 -
130	61.11TWC03 FURNISHING AND DELIVERING 3-INCH WET CONNECTION TAPPING VALVE COMPLETE WITH WEDGE TYPE RETAINER GLANDS	3.00	EACH	500 -	1500 -

BID SCHEDULE FORM

COL 1 SEQ. NO.	COL 2 ITEM NUMBER AND DESCRIPTION	COL 3 ENGINEERS ESTIMATE OF QUANTITY	COL 4 UNIT	COL 5 UNIT PRICE (IN FIGURES)		COL 6 EXTENDED AMOUNT (IN FIGURES)	
				DOLLARS	CTS	DOLLARS	CTS
131	61.12DMM06 SETTING 6-INCH MECHANICAL JOINT DUCTILE IRON GATE VALVE COMPLETE WITH WEDGE TYPE RETAINER GLANDS	16.00	EACH	500	-	8000	-
132	61.12DMM08 SETTING 8-INCH MECHANICAL JOINT DUCTILE IRON GATE VALVE COMPLETE WITH WEDGE TYPE RETAINER GLANDS	17.00	EACH	1000	-	17000	-
133	61.12DMM12 SETTING 12-INCH MECHANICAL JOINT DUCTILE IRON GATE VALVE COMPLETE WITH WEDGE TYPE RETAINER GLANDS	1.00	EACH	2000	-	2000	-
134	61.12DMM20 SETTING 20-INCH MECHANICAL JOINT DUCTILE IRON GATE VALVE COMPLETE WITH WEDGE TYPE RETAINER GLANDS	1.00	EACH	5000	-	5000	-
135	61.12TWC03 SETTING 3-INCH WET CONNECTION TAPPING VALVE COMPLETE WITH WEDGE TYPE RETAINER GLANDS	3.00	EACH	500	-	1500	-
136	62.11SD FURNISHING AND DELIVERING HYDRANTS	15.00	EACH	3500	-	52,500	-

3/25/2015 12:00 AM

NEW YORK CITY DEPARTMENT OF DESIGN AND CONSTRUCTION
 DIVISION OF INFRASTRUCTURE - BUREAU OF DESIGN

PROJECT ID: HWQ121B4

CONTRACT PIN: 8502015HW0021C

BID SCHEDULE FORM

COL 1 SEQ. NO.	COL 2 ITEM NUMBER AND DESCRIPTION	COL 3 ENGINEER'S ESTIMATE OF QUANTITY	COL 4 UNIT	COL 5 UNIT PRICE (IN FIGURES) DOLLARS	COL 6 EXTENDED AMOUNT (IN FIGURES) DOLLARS	CTS
137	62.12SG SETTING HYDRANTS COMPLETE WITH WEDGE TYPE RETAINER GLANDS	15.00	EACH	1,000	15,000	-
138	62.13RH REMOVING HYDRANTS	9.00	EACH	500	4,500	-
139	62.14FS FURNISHING, DELIVERING AND INSTALLING HYDRANT FENDERS	30.00	EACH	250	7,500	-
140	63.11VC FURNISHING AND DELIVERING VARIOUS CASTINGS	15.00	TONS	1,500	22,500	-
141	64.11EL WITHDRAWING AND REPLACING HOUSE SERVICES USING 1-1/2 INCH OR LARGER SCREW TAPS	2.00	EACH	325	650	-
142	64.11ST WITHDRAWING AND REPLACING HOUSE SERVICES USING SMALLER THAN 1-1/2-INCH SCREW TAPS	56.00	EACH	225	12,600	-

BID SCHEDULE FORM

COL 1 SEQ. NO.	COL 2 ITEM NUMBER and DESCRIPTION	COL 3 ENGINEER'S ESTIMATE OF QUANTITY	COL 4 UNIT	COL 5 UNIT PRICE (IN FIGURES)		COL 6 EXTENDED AMOUNT (IN FIGURES)
				DOLLARS	CTS	
143	64.12COEG CUTTING AND OFFSETTING HOUSE SERVICE WATER CONNECTIONS (EQUAL TO OR GREATER THAN 3-INCH DIAMETER)	10.00	L.F.	100	-	1,000
144	64.12COLT CUTTING AND OFFSETTING HOUSE SERVICE WATER CONNECTIONS (LESS THAN 3-INCH DIAMETER)	260.00	L.F.	50	-	13,000
145	64.12ESEG EXTENDING HOUSE SERVICE WATER CONNECTIONS (EQUAL TO OR GREATER THAN 3-INCH DIAMETER)	10.00	L.F.	110	-	1,100
146	64.12ESLT EXTENDING HOUSE SERVICE WATER CONNECTIONS (LESS THAN 3- INCH DIAMETER)	100.00	L.F.	65	-	6,500
147	64.13WC08 FURNISHING, DELIVERING AND INSTALLING WET CONNECTION SLEEVE ON 8-INCH WATER MAIN PIPE WITH VARIOUS OUTLETS	3.00	EACH	2,500	-	7,500
148	65.11BR FURNISHING, DELIVERING AND INSTALLING BANDS, RODS, WASHERS, ETC., COMPLETE, FOR RESTRAINING JOINTS	3,000.00	LBS.	1	-	3,000

3/25/2015 12:00 AM

NEW YORK CITY DEPARTMENT OF DESIGN AND CONSTRUCTION
 DIVISION OF INFRASTRUCTURE - BUREAU OF DESIGN

PROJECT ID: HWQ121B4

CONTRACT PIN: 8502015HW0021C

BID SCHEDULE FORM

COL 1 SEQ. NO.	COL 2 ITEM NUMBER and DESCRIPTION	COL 3 ENGINEER'S ESTIMATE QUANTITY	COL 4 UNIT	COL 5 UNIT PRICE (IN FIGURES) DOLLARS	COL 6 EXTENDED AMOUNT (IN FIGURES) DOLLARS	GTS
149	65.21PS FURNISHING AND PLACING POLYETHYLENE SLEEVE Unit price bid shall not be less than: \$ 0.50	2,400.00	L.F.	0	1200	-
150	65.31FF FURNISHING, DELIVERING AND PLACING FILTER FABRIC Unit price bid shall not be less than: \$ 0.10	35,700.00	S.F.	0	3570	-
151	65.71SG FURNISHING, DELIVERING AND PLACING SCREENED GRAVEL OR SCREENED BROKEN STONE BEDDING	130.00	C.Y.	50	6500	-
152	7.12 A PROCTOR ANALYSIS	22.00	EACH	500	11000	-
153	7.12 B IN-PLACE SOIL DENSITY TEST	66.00	EACH	300	19,800	-
154	7.13 B MAINTENANCE OF SITE Unit price bid shall not be less than: \$ 7,500.00	24.00	MONTH	7500	180,000	-

BID SCHEDULE FORM

COL 1 SEQ. NO.	COL 2 ITEM NUMBER and DESCRIPTION	COL 3 ENGINEER'S ESTIMATE OF QUANTITY	COL 4 UNIT	COL 5 UNIT PRICE (IN FIGURES) DOLLARS	COL 6 EXTENDED AMOUNT (IN FIGURES) DOLLARS	CTS
155	7.30 B REMOVAL OF TRACK	200.00	L.F.	150	30,000	-
156	7.36 PEDESTRIAN STEEL BARRICADES	3,000.00	L.F.	0	30	-
157	7.68 A GEOGRID	1,007.00	S.Y.	25	25,175	-
158	7.88 AA RODENT INFESTATION SURVEY AND MONITORING Unit price bid shall not be less than: \$ 3,600.00	1.00	L.S.	3600	3,600	-
159	7.88 AB RODENT BAIT STATIONS Unit price bid shall not be less than: \$ 60.00	192.00	EACH	60	11,520	-
160	7.88 AC BAITING OF RODENT BAIT STATIONS Unit price bid shall not be less than: \$ 9.25	192.00	EACH	9	1,776	-

3/25/2015 12:00 AM

NEW YORK CITY DEPARTMENT OF DESIGN AND CONSTRUCTION
 DIVISION OF INFRASTRUCTURE - BUREAU OF DESIGN

PROJECT ID: HWQ121B4

CONTRACT PIN: 8502015HW0021C

BID SCHEDULE FORM

COL 1 SEQ. NO.	COL 2 ITEM NUMBER and DESCRIPTION	COL 3 ENGINEER'S ESTIMATE OF QUANTITY	COL 4 UNIT	COL 5 UNIT PRICE (IN FIGURES) DOLLARS	COL 6 EXTENDED AMOUNT (IN FIGURES) DOLLARS
161	7.88 AD WATERBUG BAIT APPLICATIONS Unit price bid shall not be less than: \$ 65.00	24.00	BLOCK	65	1560
162	70.11TT TIMBER PILES (TREATED) Unit price bid shall not be less than: \$ 17.50	2,450.00	V.F.	30	73,500
163	70.21DK DECKING	400.00	S.Y.	0	4
164	70.31FN FENCING Unit price bid shall not be less than: \$ 1.50	19,836.00	L.F.	1	29,754
165	70.51EO EXCAVATION OF BOULDERS IN OPEN CUT Unit price bid shall not be less than: \$ 75.00	55.00	C.Y.	75	4125
166	70.71SB STONE BALLAST Unit price bid shall not be less than: \$ 15.00	50.00	C.Y.	15	750

BID SCHEDULE FORM

COL 1 SEQ. NO.	COL 2 ITEM NUMBER and DESCRIPTION	COL 3 ENGINEER'S ESTIMATE OF QUANTITY	COL 4 UNIT	COL 5 UNIT PRICE (IN FIGURES)		COL 6 EXTENDED AMOUNT (IN FIGURES) DOLLARS	CTS
				DOLLARS	CTS		
167	70.81CB CLEAN BACKFILL Unit price bid shall not be less than: \$ 15.00	3,206.00	C.Y.	15	-	48,090	-
168	70.91SW12 FURNISHING AND PLACING SHEETING AND BRACING IN TRENCH FOR WATER MAIN PIPE 12-INCH IN DIAMETER AND LESS	500.00	S.F.	0	01	5	-
169	70.91SW20 FURNISHING AND PLACING SHEETING AND BRACING IN TRENCH FOR WATER MAIN PIPE 20-INCH IN DIAMETER	1,625.00	S.F.	0	01	16	25
170	73.11AB ADDITIONAL BRICK MASONRY Unit price bid shall not be less than: \$ 62.50	20.00	C.Y.	62	50	1250	-
171	73.21AC ADDITIONAL CONCRETE Unit price bid shall not be less than: \$ 62.50	50.00	C.Y.	325	-	16,250	-
172	73.31AE0 ADDITIONAL EARTH EXCAVATION INCLUDING TEST PITS (ALL DEPTHS) Unit price bid shall not be less than: \$ 20.00	90.00	C.Y.	200	-	1800	-

3/25/2015 12:00 AM

NEW YORK CITY DEPARTMENT OF DESIGN AND CONSTRUCTION
 DIVISION OF INFRASTRUCTURE - BUREAU OF DESIGN

PROJECT ID: HWQ121B4

CONTRACT PIN: 8502015HW0021C

BID SCHEDULE FORM

COL 1 SEQ. NO.	COL 2 ITEM NUMBER and DESCRIPTION	COL 3 ENGINEER'S ESTIMATE OF QUANTITY	COL 4 UNIT	COL 5 UNIT PRICE (IN FIGURES) DOLLARS CTS	COL 6 EXTENDED AMOUNT (IN FIGURES) DOLLARS CTS
173	73.41AG ADDITIONAL SELECT GRANULAR BACKFILL Unit price bid shall not be less than: \$ 15.00	590.00	C.Y.	15 -	8850 -
174	73.51AS ADDITIONAL STEEL REINFORCING BARS Unit price bid shall not be less than: \$ 1.00	1,050.00	LBS.	2 -	2100 -
175	76.11CR CONSTRUCTION REPORT	1.00	L.S.	25000 -	25000 -
176	76.21MR MONITORING AND POST-CONSTRUCTION REPORT	1.00	L.S.	10000 -	10,000 -
177	8.01 C1 HANDLING, TRANSPORTING AND DISPOSAL OF NON-HAZARDOUS CONTAMINATED SOIL	4,000.00	TONS	0 01	40 -
178	8.01 C2 SAMPLING AND TESTING OF CONTAMINATED/POTENTIALLY HAZARDOUS SOIL FOR DISPOSAL PURPOSES	8.00	SETS	0 01	0 08

BID SCHEDULE FORM

COL 1 SEQ. NO.	COL 2 ITEM NUMBER and DESCRIPTION	COL 3 ENGINEER'S ESTIMATE OF QUANTITY	COL 4 UNIT	COL 5 UNIT PRICE (IN FIGURES) DOLLARS	COL 6 EXTENDED AMOUNT (IN FIGURES) DOLLARS	CTS
179	8.01 H HANDLING, TRANSPORTING AND DISPOSAL OF HAZARDOUS SOIL	150.00	TONS	0	1	50
180	8.01 S HEALTH AND SAFETY	1.00	L.S.	0	0	01
181	8.01 W1 REMOVAL, TREATMENT, AND DISCHARGE/DISPOSAL OF CONTAMINATED WATER	14.00	DAY	0	0	14
182	8.01 W2 SAMPLING AND TESTING OF WATER	2.00	SETS	0	0	02
183	8.02 A SPECIAL CARE EXCAVATION AND RESTORATION FOR SIDEWALK WORK	1,772.00	S.F.	10	17,270	-
184	8.02 B SPECIAL CARE EXCAVATION AND RESTORATION FOR CURB WORK	243.00	L.F.	50	12,150	-

3/25/2015 12:00 AM

NEW YORK CITY DEPARTMENT OF DESIGN AND CONSTRUCTION
 DIVISION OF INFRASTRUCTURE - BUREAU OF DESIGN

PROJECT ID: HWQ121B4

CONTRACT PIN: 8502015HW0021C

BID SCHEDULE FORM

COL 1 SEQ. NO.	COL 2 ITEM NUMBER and DESCRIPTION	COL 3 ENGINEER'S ESTIMATE OF QUANTITY	COL 4 UNIT	COL 5 UNIT PRICE (IN FIGURES) DOLLARS C.T.S.	COL 6 EXTENDED AMOUNT (IN FIGURES) DOLLARS C.T.S.
173	73.41AG ADDITIONAL SELECT GRANULAR BACKFILL Unit price bid shall not be less than: \$ 15.00	590.00	C.Y.	15 -	8850 -
174	73.51AS ADDITIONAL STEEL REINFORCING BARS Unit price bid shall not be less than: \$ 1.00	1,050.00	LBS.	2 -	2100 -
175	76.11CR CONSTRUCTION REPORT	1.00	L.S.	25000 -	25000 -
176	76.21MR MONITORING AND POST-CONSTRUCTION REPORT	1.00	L.S.	10000 -	10,000 -
177	8.01 C1 HANDLING, TRANSPORTING AND DISPOSAL OF NON-HAZARDOUS CONTAMINATED SOIL	4,000.00	TONS	0 01	40 -
178	8.01 C2 SAMPLING AND TESTING OF CONTAMINATED/POTENTIALLY HAZARDOUS SOIL FOR DISPOSAL PURPOSES	8.00	SETS	0 01	0 08

BID SCHEDULE FORM

COL 1 SEQ. NO.	COL 2 ITEM NUMBER and DESCRIPTION	COL 3 ENGINEER'S ESTIMATE OF QUANTITY	COL 4 UNIT	COL 5 UNIT PRICE (IN FIGURES) DOLLARS	COL 6 EXTENDED AMOUNT (IN FIGURES) DOLLARS	CTS
179	8.01 H HANDLING, TRANSPORTING AND DISPOSAL OF HAZARDOUS SOIL	150.00	TONS	0	1	50
180	8.01 S HEALTH AND SAFETY	1.00	L.S.	0	0	01
181	8.01 W1 REMOVAL, TREATMENT, AND DISCHARGE/DISPOSAL OF CONTAMINATED WATER	14.00	DAY	0	0	14
182	8.01 W2 SAMPLING AND TESTING OF WATER	2.00	SETS	0	0	02
183	8.02 A SPECIAL CARE EXCAVATION AND RESTORATION FOR SIDEWALK WORK	1,772.00	S.F.	10	17,720	-
184	8.02 B SPECIAL CARE EXCAVATION AND RESTORATION FOR CURB WORK	243.00	L.F.	50	12,150	-

3/25/2015 12:00 AM

NEW YORK CITY DEPARTMENT OF DESIGN AND CONSTRUCTION
 DIVISION OF INFRASTRUCTURE - BUREAU OF DESIGN

PROJECT ID: HWQ121B4

CONTRACT PIN: 8502015HW0021C

BID SCHEDULE FORM

COL 1 SECTION	COL 2 ITEM NUMBER and DESCRIPTION	COL 3 ENGINEERS ESTIMATE OF QUANTITY	COL 4 UNIT	COL 5 UNIT PRICE (IN FIGURES) DOLLARS CTS	COL 6 EXTENDED AMOUNT (IN FIGURES) DOLLARS CTS
185	8.32 BARK CHIP MULCH	340.00	S.Y.	50 -	17000 -
186	9.04 HW ALLOWANCE FOR ANTI-FREEZE ADDITIVE IN CONCRETE PRICE BID SHALL BE FOR THE FIXED SUM OF \$ 50,000.00	1.00	F.S.	50,000 00	50,000 00
187	BMP-7.09 LICENSED SURVEYOR	2.00	DAY	2500 -	5,000 -
188	BMP-7.103-A CONCRETE (NONSTRUCTURAL)	5.00	C.Y.	350 -	1750 -
189	BMP-7.107-B RIP-RAP AND ANGULAR NATURAL FIELD STONE	11.00	C.Y.	500 -	5500 -

BID SCHEDULE FORM

COL 1 SEQ. NO.	COL 2 ITEM NUMBER and DESCRIPTION	COL 3 ENGINEER'S ESTIMATE OF QUANTITY	COL 4 UNIT	COL 5 UNIT PRICE (IN FIGURES) DOLLARS CTS	COL 6 EXTENDED AMOUNT (IN FIGURES) DOLLARS CTS
190	BMP-7.109 GEOTEXTILE FABRIC	1,890.00	S.F.	1 -	1890 -
191	BMP-7.129-1 STRUCTURE NO. 1	1.00	EACH	552,811 -	552,811 -
192	BMP-7.304-A EXCAVATION	1,230.00	C.Y.	110 -	135,300 -
193	BMP-7.307-A GRADING	1,790.00	S.F.	250 -	4475 -
194	BMP-7.308 FILL	990.00	C.Y.	60 -	59400 -
195	BMP-7.401-I SEEDING	8,900.00	S.F.	1 -	8900 -

3/25/2015 12:00 AM

NEW YORK CITY DEPARTMENT OF DESIGN AND CONSTRUCTION
DIVISION OF INFRASTRUCTURE - BUREAU OF DESIGN

PROJECT ID: HWQ121B4

CONTRACT PIN: 8502015HW0021C

BID SCHEDULE FORM

COL 1 SEQ. NO.	COL 2 ITEM NUMBER and DESCRIPTION	COL 3 ENGINEER'S ESTIMATE OF QUANTITY	COL 4 UNIT	COL 5 UNIT PRICE (IN FIGURES) DOLLARS CTS.	COL 6 EXTENDED AMOUNT (IN FIGURES) DOLLARS CTS.
190	BMP-7.109 GEOTEXTILE FABRIC	1,890.00	S.F.	1 -	1890 -
191	BMP-7.129-1 STRUCTURE NO. 1	1.00	EACH	552,811 -	552,811 -
192	BMP-7.304-A EXCAVATION	1,230.00	C.Y.	110 -	135,300 -
193	BMP-7.307-A GRADING	1,790.00	S.F.	2. 250 50	4475 -
194	BMP-7.308 FILL	990.00	C.Y.	077/25115	59400 -
195	BMP-7.401-I SEEDING	8,900.00	S.F.	1 -	8900 -

3/25/2015 12:00 AM

NEW YORK CITY DEPARTMENT OF DESIGN AND CONSTRUCTION
 DIVISION OF INFRASTRUCTURE - BUREAU OF DESIGN

PROJECT ID: HWQ121B4

CONTRACT PIN: 8502015HW0021C

BID SCHEDULE FORM

COL. 1 SEQ. NO.	COL. 2 ITEM NUMBER and DESCRIPTION	COL. 3 ENGINEER'S ESTIMATE OF QUANTITY	COL. 4 UNIT	COL. 5 UNIT PRICE (IN FIGURES) DOLLARS CTS.	COL. 6 EXTENDED AMOUNT (IN FIGURES) DOLLARS CTS.
185	8.32 BARK CHIP MULCH	340.00	S.Y.	50 -	17,000 -
186	9.04 HW ALLOWANCE FOR ANTI-FREEZE ADDITIVE IN CONCRETE PRICE BID SHALL BE FOR THE FIXED SUM OF \$ 50,000.00	1.00	F.S.	50,000 00	50,000 00
187	BMP-7.09 LICENSED SURVEYOR	2.00	DAY	2,500 -	5,000 -
188	BMP-7.103-A CONCRETE (NONSTRUCTURAL)	5.00	C.Y.	350 -	1,750 -
189	BMP-7.107-B RIP-RAP AND ANGULAR NATURAL FIELD STONE	11.00	C.Y.	500 -	5,500 -

3/25/2015 12:00 AM

NEW YORK CITY DEPARTMENT OF DESIGN AND CONSTRUCTION
 DIVISION OF INFRASTRUCTURE - BUREAU OF DESIGN

PROJECT ID: HWQ121B4

CONTRACT PIN: 8502015HW0021C

BID SCHEDULE FORM

COL 1 SEQ. NO	COL 2 ITEM NUMBER and DESCRIPTION	COL 3 ENGINEERS ESTIMATE OF QUANTITY	COL 4 UNIT	COL 5 UNIT PRICE (IN FIGURES) DOLLARS CTS	COL 6 EXTENDED AMOUNT (IN FIGURES) DOLLARS CTS
196	BMP-7.401-J HERBACEOUS PLANTS (PLUGS)	3,015.00	EACH	6 -	18,090 -
197	BMP-7.403 TOPSOIL	46.00	C.Y.	90 -	4140 -
198	BMP-7.404-A RESTORATION SPECIALIST	590.00	HRS	125 -	73750 -
199	BMP-7.404-B EROSION AND SEDIMENT CONTROL LICENSED/CERTIFIED PROFESSIONAL	208.00	DAY	1 -	208 -
200	BMP-7.407-A EROSION CONTROL MAT	2,670.00	S.F.	2.50 250	6675 -
201	BMP-7.407-B EROSION CONTROL MAT - CURLLED WOOD OR COCONUT FIBER	1,250.00	S.F.	3 61161/3	3750 -

BID SCHEDULE FORM

COL 1 SEQ. NO.	COL 2 ITEM NUMBER and DESCRIPTION	COL 3 ENGINEER'S ESTIMATE OF QUANTITY	COL 4 UNIT	COL 5 UNIT PRICE (IN FIGURES) DOLLARS CTS	COL 6 EXTENDED AMOUNT (IN FIGURES) DOLLARS CTS
202	BMP-7.408-B HERBICIDE APPLICATION	1.00	CREW DAY	2500 -	2500 -
203	BMP-7.413 TEMPORARY GOOSE EXCLUSION FENCE	680.00	L.F.	10 -	6800 -
204	BMP-7.417 DEBRIS EXCLUSION FENCE	220.00	L.F.	13 -	2860 -
205	BMP-7.504 REINFORCED SILT FENCE	1,060.00	L.F.	25 -	26,500 -
206	BMP-7.509-A STABILIZED CONSTRUCTION ENTRANCE	2.00	EACH	15000 -	30,000 -
207	BMP-7.510 PORTABLE SEDIMENT TANK	2.00	EACH	5000 -	10,000 -

3/25/2015 12:00 AM

NEW YORK CITY DEPARTMENT OF DESIGN AND CONSTRUCTION
 DIVISION OF INFRASTRUCTURE - BUREAU OF DESIGN

PROJECT ID: HWQ121B4

CONTRACT PIN: 8502015HW0021C

BID SCHEDULE FORM

COL 1 SEQ. NO.	COL 2 ITEM NUMBER and DESCRIPTION	COL 3 ENGINEER'S ESTIMATE OF QUANTITY	COL 4 UNIT	COL 5 UNIT PRICE (IN FIGURES) DOLLARS CTS	COL 6 EXTENDED AMOUNT (IN FIGURES) DOLLARS CTS
208	BMP-7.516 TURBIDITY CURTAIN	430.00	L.F.	30 -	12,900 -
209	BMP-7.606-B PERMANENT MAINTENANCE ACCESSWAY (PAVERS)	780.00	S.F.	40 -	31,200 -
210	BMP-7.710 RENO MATTRESS	18.00	S.Y.	130 -	2,340 -
211	NYC-610.0112 APPLYING MYCORRHIZAL FUNGI	73.00	LBS.	25 -	1,825 -
212	NYC-610.01940082 APPLYING COMPOST	273.00	C.Y.	90 -	24,570 -
213	SL-20.02.02 FURNISH AND INSTALL STANDARD TYPE ANCHOR BOLT FOUNDATION, AS PER DRAWING E-3788	1.00	EACH	1500 -	1,500 -

BID SCHEDULE FORM

COL 1 SEQ. NO.	COL 2 ITEM NUMBER and DESCRIPTION	COL 3 ENGINEER'S ESTIMATE OF QUANTITY	COL 4 UNIT	COL 5 UNIT PRICE (IN FIGURES)		COL 6 EXTENDED AMOUNT (IN FIGURES)	
				DOLLARS	CTS	DOLLARS	CTS
214	SL-21.02.02 FURNISH AND INSTALL A STANDARD WOOD POLE	5.00	EACH	5000	-	25,000	-
215	SL-21.03.02 FURNISH AND INSTALL TYPE 2S, 4S, 6S, 8S OR 12S LAMPPOST WITH TRANSFORMER BASE	1.00	EACH	2500	-	2,500	-
216	SL-21.09.03 REMOVE A WOOD POLE WITH ALL ATTACHMENTS, IF ANY	2.00	EACH	1500	-	3,000	-
217	SL-22.16.05 FURNISH AND INSTALL ROADWAY TYPE LED FIXTURE AS PER SPECIFICATION 466 WITH PEC RECEPTACLE AND PEC	35.00	EACH	500	-	17,500	-
218	SL-24.01.04 REMOVE BRACKET, LUMINAIRE AND CONTROL, IF ANY, FROM WOOD POLE	29.00	EACH	500	-	14,500	-
219	SL-24.01.05 FURNISH AND INSTALL FABRICATED STEEL 8 Ft. BRACKET WITH HARDWARE ON WOOD POLE, AS PER DRAWING J-3585.	35.00	EACH	1500	-	52,500	-

3/25/2015 12:00 AM

NEW YORK CITY DEPARTMENT OF DESIGN AND CONSTRUCTION
 DIVISION OF INFRASTRUCTURE - BUREAU OF DESIGN

PROJECT ID: HWQ121B4

CONTRACT PIN: 8502015HW0021C

BID SCHEDULE FORM

COL 1 SEQ. NO.	COL 2 ITEM NUMBER and DESCRIPTION	COL 3 ENGINEERS ESTIMATE OF QUANTITY	COL 4 UNIT	COL 5 UNIT PRICE (IN FIGURES)		COL 6 EXTENDED AMOUNT (IN FIGURES) DOLLARS	CTS
				DOLLARS	CTS		
220	SL-26.06.02 FURNISH AND INSTALL LED FIRE ALARM LUMINAIRES.	1.00	EACH	2500	-	2500	-
221	UTL-6.01.1 GAS MAIN CROSSING SEWER UP TO 24" IN DIAMETER (S6.01) Unit price bid shall not be less than: \$ 1,040.00	3.00	EACH	1040	-	3120	-
222	UTL-6.01.2 GAS MAIN CROSSING SEWER 30" IN DIAMETER (S6.01) Unit price bid shall not be less than: \$ 1,770.00	1.00	EACH	1770	-	1770	-
223	UTL-6.01.2A GAS MAIN CROSSING 38"W X 24"H HORIZONTAL ELLIPTICAL REINFORCED CONCRETE STORM SEWER (S6.01) Unit price bid shall not be less than: \$ 1,870.00	1.00	EACH	1870	-	1870	-
224	UTL-6.01.2B GAS MAIN CROSSING 30"W X 19"H HORIZONTAL ELLIPTICAL REINFORCED CONCRETE STORM SEWER (S6.01) Unit price bid shall not be less than: \$ 1,770.00	1.00	EACH	1770	-	1770	-
225	UTL-6.01.9 GAS MAIN CROSSING WATER MAIN UP TO 20" IN DIAMETER (S6.01) Unit price bid shall not be less than: \$ 485.00	4.00	EACH	485	-	1940	-

BID SCHEDULE FORM

COL 1 SEQ. NO	COL 2 ITEM NUMBER and DESCRIPTION	COL 3 ENGINEER'S ESTIMATE OF QUANTITY	COL 4 UNIT	COL 5 UNIT PRICE (IN FIGURES)		COL 6 EXTENDED AMOUNT (IN FIGURES)	
				DOLLARS	CTS	DOLLARS	CTS
226	UTL-6.02 EXTRA EXCAVATION FOR THE INSTALLATION OF CATCH BASIN SEWER DRAIN PIPES WITH GAS INTERFERENCES (\$6.02) Unit price bid shall not be less than: \$ 715.00	2.00	EACH	715	-	1430	-
227	UTL-6.03 REMOVAL OF ABANDONED GAS FACILITIES. ALL SIZES. (\$6.03) Unit price bid shall not be less than: \$ 15.00	2,500.00	L.F.	15	-	37500	-
228	UTL-6.03.1 REMOVAL OF ABANDONED GAS FACILITIES WITH POSSIBLE COAL TAR WRAP. ALL SIZES. (\$6.03) Unit price bid shall not be less than: \$ 25.00	200.00	L.F.	25	-	5000	-
229	UTL-6.04 ADJUST HARDWARE TO GRADE USING SPACER RINGS/ADAPTORS. (STREET REPAVING.) (\$6.04) Unit price bid shall not be less than: \$ 35.00	20.00	EACH	35	-	700	-
230	UTL-6.05 ADJUST HARDWARE TO GRADE BY RESETTING. (ROAD RECONSTRUCTION.) (\$6.05) Unit price bid shall not be less than: \$ 65.00	20.00	EACH	65	-	1300	-
231	UTL-6.06 SPECIAL CARE EXCAVATION AND BACKFILLING (\$6.06) Unit price bid shall not be less than: \$ 180.00	500.00	C.Y.	180	-	90,000	-

3/25/2015 12:00 AM

NEW YORK CITY DEPARTMENT OF DESIGN AND CONSTRUCTION
 DIVISION OF INFRASTRUCTURE - BUREAU OF DESIGN

PROJECT ID: HWQ121B4

CONTRACT PIN: 8502015HW0021C

BID SCHEDULE FORM

COL 1 SEQ. NO.	COL 2 ITEM NUMBER AND DESCRIPTION	COL 3 ENGINEER'S ESTIMATE OF QUANTITY	COL 4 UNIT	COL 5 UNIT PRICE (IN FIGURES) DOLLARS CENTS	COL 6 EXTENDED AMOUNT (IN FIGURES) DOLLARS CENTS
232	UTL-6.07 TEST PITS FOR GAS FACILITIES (S6.07) Unit price bid shall not be less than: \$ 100.00	20.00	C.Y.	100 -	2000 -
233	UTL-GCS-2WS GAS INTERFERENCES AND ACCOMMODATIONS PRICE BID SHALL BE FOR THE FIXED SUM OF \$ 30,000.00	1.00	F.S.	30,000 00	30,000 00

SUB-TOTAL: \$ 11,278,478.86

234	6.39 A MOBILIZATION BID PRICE OF MOBILIZATION SHALL NOT EXCEED 4% OF THE ABOVE SUB-TOTAL PRICE.	1.00	L.S.		457,139 15
-----	---	------	------	--	------------

TOTAL BID PRICE: \$ 11,729,618.01

PLEASE BE SURE A LEGIBLE BID IS ENTERED FOR EACH ITEM.
 THE BIDDER SHALL INSERT THE TOTAL BID PRICE IN
 THE BID FORM ON PAGE C-4 OF THIS BID BOOKLET.

(NO TEXT ON THIS PAGE)

BID FORM

PROJECT ID. HWQ121B4

TOTAL BID PRICE: In the space provided below, the Bidder shall indicate its Total Bid Price in figures. Such Total Bid Price is set forth on the final page of the Bid Schedule.

TOTAL BID PRICE:
(a/k/a BID PROPOSAL)

\$ 11,729,618.00

4.4
6/16/15

BIDDER'S SIGNATURE AND AFFIDAVIT

Bidder: P&T II Contracting Corp.

By: 
(Signature of Partner or corporate officer)



Attest:
(Corporate Seal)

Secretary of Corporate Bidder

Affidavit on the following page should be subscribed
and sworn to before a Notary Public

BID FORM (TO BE NOTARIZED)

AFFIDAVIT WHERE BIDDER IS AN INDIVIDUAL

STATE OF NEW YORK, COUNTY OF _____ ss: _____ being duly sworn says:
I am the person described in and who executed the foregoing bid, and the several matters therein stated are in all respects true.

(Signature of the person who signed the Bid)

Subscribed and sworn to before me this _____ day of _____, _____

Notary Public

AFFIDAVIT WHERE BIDDER IS A PARTNERSHIP

STATE OF NEW YORK, COUNTY OF _____ ss: _____ being duly sworn says:
I am a member of _____ the firm described in and which executed the foregoing bid. I subscribed the name of the firm thereto on behalf of the firm, and the several matters therein stated are in all respects true.

(Signature of Partner who signed the Bid)

Subscribed and sworn to before me this _____ day of _____, _____

Notary Public

AFFIDAVIT WHERE BIDDER IS A CORPORATION

STATE OF NEW YORK, COUNTY OF Queens ss: _____ being duly sworn says:
I am the President of the above named corporation whose name is subscribed to and which executed the foregoing bid. I reside at 57 ledgewood DR. Smithtown. NY.
I have knowledge of the several matters therein stated, and they are in all respects true.



(Signature of Corporate Officer who signed the Bid)

Subscribed and sworn to before me this 16th day of June, 2015

Notary Public

CLAUDIA J. WHITFIELD
NOTARY PUBLIC-STATE OF NEW YORK
No. 01WH5004514
Qualified in Queens County
My Commission Expires November 16, 2018

BID BOND 1
FORM OF BID BOND

KNOW ALL MEN BY THESE PRESENTS. That we, P & T II Contracting Corp.
2417 Jericho Turnpike, Garden City Park, NY 11040

hereinafter referred to as the "Principal", and Liberty Mutual Insurance Company
1200 MacArthur Blvd., Mahwah, NJ 07043

hereinafter referred to as the "Surety" are held and firmly bound to THE CITY OF NEW YORK,
hereinafter referred to as the "CITY", or to its successors and assigns in the penal sum of _____

TEN PERCENT OF AMOUNT BID

(10% Amt Bid), Dollars lawful money of the United States, for the payment of which said sum of money well and truly to be made, we, and each of us, bind ourselves, our heirs, executors, administrators, successors and assigns, jointly and severally, firmly by these presents.

Whereas, the Principal is about to submit (or has submitted) to the City the accompanying proposal, hereby made a part hereof, to enter into a contract in writing for _____

Cont. #HWQ121B4 - Reconstruction of Lakeview Blvd. East - Boro of Queens

NOW, THEREFORE, the conditions of this obligation are such that if the Principal shall not withdraw said Proposal without the consent of the City for a period of forty-five (45) days after the opening of bids and in the event of acceptance of the Principal's Proposal by the City, if the Principal shall:

(a) Within ten (10) days after notification by the City, execute in quadruplicate and deliver to the City all the executed counterparts of the Contract in the form set forth in the Contract Documents, in accordance with the proposal as accepted, and

(b) Furnish a performance bond and separate payment bond, as may be required by the City, for the faithful performance and proper fulfillment of such Contract, which bonds shall be satisfactory in all respects to the City and shall be executed by good and sufficient sureties, and

(c) In all respects perform the agreement created by the acceptance of said Proposal as provided in the Information for Bidders, bound herewith and made a part hereof, or if the City shall reject the aforesaid Proposal, then this obligation shall be null and void; otherwise to remain in full force and effect.



BID BOND 2

In the event that the Proposal of the Principal shall be accepted and the Contract be awarded to him the Surety hereunder agrees subject only to the payment by the Principal of the premium therefore, if requested by the City, to write the aforementioned performance and payment bonds in the form set forth in the Contract Documents.

It is expressly understood and agreed that the liability of the Surety for any and all claims hereunder shall in no event exceed the penal amount of this obligation as herein stated.

There shall be no liability under this bond if, in the event of the acceptance of the Principal's Proposal by the City, either a performance bond or payment bond, or both, shall not be required by the City on or before the 30th day after the date on which the City signs the Contract.

The surety, for the value received, hereby stipulates and agrees that the obligations of the Surety and its bond shall in no way be impaired or affected by any postponements of the date upon which the City will receive or open bids, or by any extensions of the time within which the City may accept the Principal's Proposal, or by any waiver by the City of any of the requirements of the Information for Bidders, and the Surety hereby waives notice of any such postponements, extensions, or waivers.

IN WITNESS WHEREOF, the Principal and the Surety have hereunto set their hands and seals and such of them as are corporations have caused their corporate seals to be hereto affixed and these presents to be signed by their proper officers the 8th day of June, 2015.

(Seal)

P & T II Contracting Corp.

(L.S.)

Principal

By:

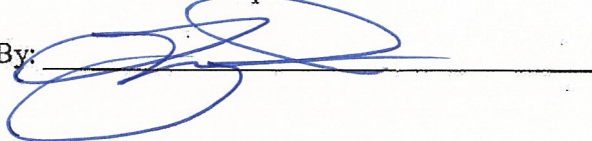

(Seal)

Liberty Mutual Insurance Company

Surety

By:

Robert Kempner, Attorney-in-Fact

11111



BID BOND 3

ACKNOWLEDGMENT OF PRINCIPAL, IF A CORPORATION

State of _____ County of _____ ss:
On this _____ day of _____, _____, before me personally came
_____ to me known, who, being by me duly sworn, did depose and say
that he resides at _____
that he is the _____ of _____
the corporation described in and which executed the foregoing instrument; that he knows the seal of said
corporation; that one of the seals affixed to said instrument is such seal; that it was so affixed by order of
the directors of said corporation, and that he signed his name thereto by like order.

Notary Public

ACKNOWLEDGMENT OF PRINCIPAL, IF A PARTNERSHIP

State of _____ County of _____ ss:
On this _____ day of _____, _____, before me personally appeared
_____ to me known and known to me to be one of the members of the
firm of _____ described in and who executed the foregoing
instrument, and he acknowledged to me that he executed the same as and for the act and deed of said
firm.

Notary Public

ACKNOWLEDGMENT OF PRINCIPAL, IF AN INDIVIDUAL

State of _____ County of _____ ss:
On this _____ day of _____, _____, before me personally appeared
_____ to me known and known to me to be the person described in
and who executed the foregoing instrument and acknowledged that he executed the same.

Notary Public

AFFIX ACKNOWLEDGMENTS AND JUSTIFICATION OF SURETIES



ACKNOWLEDGEMENT OF PRINCIPAL, OF A CORPORATION

STATE OF New York

SS:

COUNTY OF Queens

On this 16th day of June, 2017 before me personally came Lenny Pereira to me known, who, being by me duly sworn did depose and say that he resides at Smithtown, NY that he is the President of P+T II Contracting Corp the corporation described in and which executed the foregoing instrument; that he knows the seal of said corporation; that one of the seals affixed to the foregoing instrument is such seal; that it was an affixed by order of the board of directors of said corporation; and that he signed his name thereto by like order.

CLAUDIA J WHITFIELD
NOTARY PUBLIC-STATE OF NEW YORK
No. 01WH5004514
Qualified in Queens County
My Commission Expires November 16, 2018

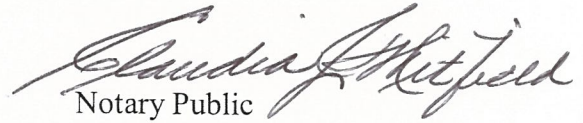
Notary Public

ACKNOWLEDGEMENT OF SURETY

STATE OF New York

SS:

COUNTY OF Nassau

On this 8th day of June, 2015, before me personally came Robert Kempner to me known, who, being by me duly sworn, did depose and say that he is an Attorney-In-Fact of Liberty Mutual Insurance Company the corporation described in and which executed the within instrument; that he knows the corporate seal of said corporation; that the seal affixed to the within instrument is such corporate seal, and that he signed and said instrument and affixed the said seal as Attorney-In-Fact by authority of the Board of Directors of said corporation and by authority of this office under the Standing Resolutions thereof.

LYNN ANN INFANTI
Notary Public, State of New York
No. 01IN6004351
Qualified in Suffolk County
Commission Expires March 23, 2018

My commission expires _____



Notary Public

11

11



THIS POWER OF ATTORNEY IS NOT VALID UNLESS IT IS PRINTED ON RED BACKGROUND.

This Power of Attorney limits the acts of those named herein, and they have no authority to bind the Company except in the manner and to the extent herein stated.

Certificate No. 6930593

American Fire and Casualty Company
The Ohio Casualty Insurance Company

Liberty Mutual Insurance Company
West American Insurance Company

POWER OF ATTORNEY

KNOWN ALL PERSONS BY THESE PRESENTS: That American Fire & Casualty Company and The Ohio Casualty Insurance Company are corporations duly organized under the laws of the State of New Hampshire, that Liberty Mutual Insurance Company is a corporation duly organized under the laws of the State of Massachusetts, and West American Insurance Company is a corporation duly organized under the laws of the State of Indiana (herein collectively called the "Companies"), pursuant to and by authority herein set forth, does hereby name, constitute and appoint, Joseph Sforzo; Robert Kempner; Robert W. O'Kane; Susan P. Hammel

all of the city of Plainview, state of NY each individually if there be more than one named, its true and lawful attorney-in-fact to make, execute, seal, acknowledge and deliver, for and on its behalf as surety and as its act and deed, any and all undertakings, bonds, recognizances and other surety obligations, in pursuance of these presents and shall be as binding upon the Companies as if they have been duly signed by the president and attested by the secretary of the Companies in their own proper persons.

IN WITNESS WHEREOF, this Power of Attorney has been subscribed by an authorized officer or official of the Companies and the corporate seals of the Companies have been affixed thereto this 31st day of March, 2015.

American Fire and Casualty Company
The Ohio Casualty Insurance Company
Liberty Mutual Insurance Company
West American Insurance Company

By: David M. Carey
David M. Carey, Assistant Secretary

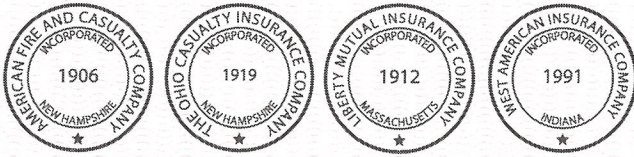

STATE OF PENNSYLVANIA ss
COUNTY OF MONTGOMERY

On this 31st day of March, 2015, before me personally appeared David M. Carey, who acknowledged himself to be the Assistant Secretary of American Fire and Casualty Company, Liberty Mutual Insurance Company, The Ohio Casualty Insurance Company, and West American Insurance Company, and that he, as such, being authorized so to do, execute the foregoing instrument for the purposes therein contained by signing on behalf of the corporations by himself as a duly authorized officer.

IN WITNESS WHEREOF, I have hereunto subscribed my name and affixed my notarial seal at Plymouth Meeting, Pennsylvania, on the day and year first above written.



COMMONWEALTH OF PENNSYLVANIA
Notarial Seal
Teresa Pastella, Notary Public
Plymouth Twp., Montgomery County
My Commission Expires March 28, 2017
Member, Pennsylvania Association of Notaries

By: Teresa Pastella
Teresa Pastella, Notary Public

This Power of Attorney is made and executed pursuant to and by authority of the following By-laws and Authorizations of American Fire and Casualty Company, The Ohio Casualty Insurance Company, Liberty Mutual Insurance Company, and West American Insurance Company which resolutions are now in full force and effect reading as follows:

ARTICLE IV – OFFICERS – Section 12. Power of Attorney. Any officer or other official of the Corporation authorized for that purpose in writing by the Chairman or the President, and subject to such limitation as the Chairman or the President may prescribe, shall appoint such attorneys-in-fact, as may be necessary to act in behalf of the Corporation to make, execute, seal, acknowledge and deliver as surety any and all undertakings, bonds, recognizances and other surety obligations. Such attorneys-in-fact, subject to the limitations set forth in their respective powers of attorney, shall have full power to bind the Corporation by their signature and execution of any such instruments and to attach thereto the seal of the Corporation. When so executed, such instruments shall be as binding as if signed by the President and attested to by the Secretary. Any power or authority granted to any representative or attorney-in-fact under the provisions of this article may be revoked at any time by the Board, the Chairman, the President or by the officer or officers granting such power or authority.

ARTICLE XIII – Execution of Contracts – SECTION 5. Surety Bonds and Undertakings. Any officer of the Company authorized for that purpose in writing by the chairman or the president, and subject to such limitations as the chairman or the president may prescribe, shall appoint such attorneys-in-fact, as may be necessary to act in behalf of the Company to make, execute, seal, acknowledge and deliver as surety any and all undertakings, bonds, recognizances and other surety obligations. Such attorneys-in-fact subject to the limitations set forth in their respective powers of attorney, shall have full power to bind the Company by their signature and execution of any such instruments and to attach thereto the seal of the Company. When so executed such instruments shall be as binding as if signed by the president and attested by the secretary.

Certificate of Designation – The President of the Company, acting pursuant to the Bylaws of the Company, authorizes David M. Carey, Assistant Secretary to appoint such attorneys-in-fact as may be necessary to act on behalf of the Company to make, execute, seal, acknowledge and deliver as surety any and all undertakings, bonds, recognizances and other surety obligations.

Authorization – By unanimous consent of the Company's Board of Directors, the Company consents that facsimile or mechanically reproduced signature of any assistant secretary of the Company, wherever appearing upon a certified copy of any power of attorney issued by the Company in connection with surety bonds, shall be valid and binding upon the Company with the same force and effect as though manually affixed.

I, Gregory W. Davenport, the undersigned, Assistant Secretary, of American Fire and Casualty Company, The Ohio Casualty Insurance Company, Liberty Mutual Insurance Company, and West American Insurance Company do hereby certify that the original power of attorney of which the foregoing is a full, true and correct copy of the Power of Attorney executed by said Companies, is in full force and effect and has not been revoked.

IN TESTIMONY WHEREOF, I have hereunto set my hand and affixed the seals of said Companies this 8th day of June, 2015.

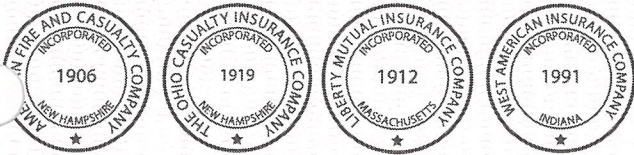

By: Gregory W. Davenport
Gregory W. Davenport, Assistant Secretary

Not valid for mortgage, note, loan, letter of credit, currency rate, interest rate or individual value guarantees.

To confirm the validity of this Power of Attorney call 1-610-832-8240 between 9:00 am and 4:30 pm EST on any business day.

11

11





LIBERTY MUTUAL INSURANCE COMPANY
 FINANCIAL STATEMENT — DECEMBER 31, 2014

Assets		Liabilities	
Cash and Bank Deposits.....	\$744,221,142	Unearned Premiums.....	\$6,288,178,795
*Bonds — U.S Government.....	1,718,117,704	Reserve for Claims and Claims Expense.....	16,879,324,618
*Other Bonds.....	11,205,872,087	Funds Held Under Reinsurance Treaties.....	211,983,009
*Stocks.....	9,533,437,819	Reserve for Dividends to Policyholders.....	1,246,547
Real Estate.....	277,742,849	Additional Statutory Reserve.....	40,877,587
Agents' Balances or Uncollected Premiums.....	4,150,041,316	Reserve for Commissions, Taxes and	
Accrued Interest and Rents.....	129,261,358	Other Liabilities.....	<u>2,664,248,124</u>
Other Admitted Assets.....	<u>14,896,464,393</u>	Total.....	<u>\$26,085,858,680</u>
		Special Surplus Funds.....	\$53,954,363
Total Admitted Assets.....	<u>\$42,655,158,668</u>	Capital Stock.....	10,000,000
		Paid in Surplus.....	8,829,117,542
		Unassigned Surplus.....	7,676,228,083
		Surplus to Policyholders.....	<u>16,569,299,988</u>
		Total Liabilities and Surplus.....	<u>\$42,655,158,668</u>



* Bonds are stated at amortized or investment value; Stocks at Association Market Values.
 The foregoing financial information is taken from Liberty Mutual Insurance Company's financial statement filed with the state of Massachusetts Department of Insurance.

I, TIM MIKOLAJEWSKI, Assistant Secretary of Liberty Mutual Insurance Company, do hereby certify that the foregoing is a true, and correct statement of the Assets and Liabilities of said Corporation, as of December 31, 2014, to the best of my knowledge and belief.

IN WITNESS WHEREOF, I have hereunto set my hand and affixed the seal of said Corporation at Seattle, Washington, this 20th day of March, 2015.

T. Mikolajewski

Assistant Secretary

11

11



M/WBE PROGRAM

M/WBE UTILIZATION PLAN

M/WBE Program Requirements: The requirements for the M/WBE Program are set forth on the following pages of this Bid Booklet, in the section entitled “Notice to All Prospective Contractors”.

Schedule B: M/WBE Utilization Plan: Schedule B: M/WBE Utilization Plan for this Contract is set forth in this Bid Booklet on the pages following the section entitled “Notice to All Prospective Contractors”. The M/WBE Utilization Plan (Part I) indicates whether Participation Goals have been established for this Contract. If Participation Goals have been established for this Contract, the bidder must submit an M/WBE Utilization Plan (Part II) with its bid.

Waiver: The bidder may seek a full or partial pre-award waiver of the Participation Goals in accordance with the “Notice to All Prospective Contractors” (See Part A, Section 10). The bidder’s request for a waiver must be submitted at least seven (7) calendar days prior to the bid date. Waiver requests submitted after the deadline will not be considered. The form for requesting a waiver of the Participation Goals is set forth in the M/WBE Utilization Plan (Part III).

Rejection of the Bid: The bidder must complete Schedule B: M/WBE Utilization Plan (Part II) set forth in this Bid Booklet on the pages following the section entitled “Notice to All Prospective Contractors”. A Schedule B submitted by the bidder which does not include the Vendor Certification and Required Affirmations (See Section V of Part II) will be deemed to be non-responsive, unless a full waiver of the Participation Goals is granted (Schedule B, Part III). In the event that the City determines that the bidder has submitted a Schedule B where the Vendor Certification and Required Affirmations are completed but other aspects of the Schedule B are not complete, or contain a copy or computation error that is at odds with the Vendor Certification and Required Affirmations, the bidder will be notified by the Agency and will be given four (4) calendar days from receipt of notification to cure the specified deficiencies and return a completed Schedule B to the Agency. Failure to do so will result in a determination that the Bid is non-responsive. Receipt of notification is defined as the date notice is emailed or faxed (if the bidder has provided an email address or fax number), or no later than five (5) calendar days from the date of mailing or upon delivery, if delivered.

Impact on LBE Requirements: If Participation Goals have been established for the participation of M/WBEs, the contractor is not required to comply with the Locally Based Enterprise Program (“LBE”). The LBE Program is set forth in Article 67 of the Contract.

NOTICE TO ALL PROSPECTIVE CONTRACTORS

**PARTICIPATION BY MINORITY-OWNED AND WOMEN-OWNED BUSINESS
ENTERPRISES IN CITY PROCUREMENT**

ARTICLE I. M/WBE PROGRAM

Local Law No. 129 of 2005 added and Local Law 1 of 2013 amended Section 6-129 of the Administrative Code of the City of New York (hereinafter "Section 6-129"). Section 6-129 establishes the program for participation in City procurement ("M/WBE Program") by minority-owned business enterprises ("MBEs") and women-owned business enterprises ("WBEs"), certified in accordance with Section 1304 of the New York City Charter. As stated in Section 6-129, the intent of the program is to address the impact of discrimination on the City's procurement process, and to promote the public interest in avoiding fraud and favoritism in the procurement process, increasing competition for City business, and lowering contract costs. The contract provisions contained herein are pursuant to Section 6-129, and the rules of the Department of Small Business Services ("DSBS") promulgated thereunder.

If this Contract is subject to the M/WBE Program established by Section 6-129, the specific requirements of MBE and/or WBE participation for this Contract are set forth in Schedule B of the Contract (entitled the "M/WBE Utilization Plan"), and are detailed below. The Contractor must comply with all applicable MBE and WBE requirements for this Contract.

All provisions of Section 6-129 are hereby incorporated in the Contract by reference and all terms used herein that are not defined herein shall have the meanings given such terms in Section 6-129. Article I, Part A, below, sets forth provisions related to the participation goals for construction, standard and professional services contracts. Article I, Part B, below, sets forth miscellaneous provisions related to the M/WBE Program.

PART A

**PARTICIPATION GOALS FOR CONSTRUCTION, STANDARD
AND PROFESSIONAL SERVICES CONTRACTS OR TASK ORDERS**

1. The **MBE and/or WBE Participation Goals** established for this Contract or Task Orders issued pursuant to this Contract, ("**Participation Goals**"), as applicable, are set forth on Schedule B, Part I to this Contract (see Page 1, line 1 Total Participation Goals) or will be set forth on Schedule B, Part I to Task Orders issued pursuant to this Contract, as applicable.

The **Participation Goals** represent a percentage of the total dollar value of the Contract or Task Order, as applicable, that may be achieved by awarding subcontracts to firms certified with New York City Department of Small Business Services as MBEs and/or WBEs, and/or by crediting the participation of prime contractors and/or qualified joint ventures as provided in Section 3 below, unless the goals have been waived or modified by Agency in accordance with Section 6-129 and Part A, Sections 10 and 11 below, respectively.

2. If **Participation Goals** have been established for this Contract or Task Orders issued pursuant to this Contract, Contractor agrees or shall agree as a material term of the Contract that Contractor shall be subject to the **Participation Goals**, unless the goals are waived or modified by Agency in accordance with Section 6-129 and Part A, Sections 10 and 11 below, respectively.

3. If **Participation Goals** have been established for this Contract or Task Order issued pursuant to this Contract, a Contractor that is an MBE and/or WBE shall be permitted to count its own participation toward fulfillment of the relevant **Participation Goal**, provided that in accordance with Section 6-129 the value of Contractor's participation shall be determined by subtracting from the total value of the Contract or Task Order, as applicable, any amounts that the Contractor pays to direct subcontractors (as defined in Section 6-129(c)(13)), and provided further that a Contractor that is certified as both an MBE and a WBE may count its own participation either toward the goal for MBEs or the goal for WBEs, but not both.

A Contractor that is a qualified joint venture (as defined in Section 6-129(c)(30)) shall be permitted to count a percentage of its own participation toward fulfillment of the relevant **Participation Goal**. In accordance with Section 6-129, the value of Contractor's participation shall be determined by subtracting from the total value of the Contract or Task Order, as applicable, any amounts that Contractor pays to direct subcontractors, and then multiplying the remainder by the percentage to be applied to total profit to determine the amount to which an MBE or WBE is entitled pursuant to the joint venture agreement, provided that where a participant in a joint venture is certified as both an MBE and a WBE, such amount shall be counted either toward the goal for MBEs or the goal for WBEs, but not both.

4. A. If **Participation Goals** have been established for this Contract, a prospective contractor shall be required to submit with its bid or proposal, as applicable, a completed Schedule B, M/WBE Utilization Plan, Part II (see Pages 2-4) indicating: (a) whether the contractor is an MBE or WBE, or qualified joint venture; (b) the percentage of work it intends to award to direct subcontractors; and (c) in cases where the contractor intends to award direct subcontracts, a description of the type and dollar value of work designated for participation by MBEs and/or WBEs, and the time frames in which such work is scheduled to begin and end. In the event that this M/WBE Utilization Plan indicates that the bidder or proposer, as applicable, does not intend to meet the **Participation Goals**, the bid or proposal, as applicable, shall be deemed non-responsive, unless Agency has granted the bidder or proposer, as applicable, a pre-award waiver of the Participation Goals in accordance with Section 6-129 and Part A, Section 10 below.

B. (i) If this Contract is for a master services agreement or other requirements type contract that will result in the issuance of Task Orders that will be individually registered ("Master Services Agreement") and is subject to M/WBE **Participation Goals**, a prospective contractor shall be required to submit with its bid or proposal, as applicable, a completed Schedule B, M/WBE Participation Requirements for Master Services Agreements That Will Require Individually Registered Task Orders, Part II (page 2) indicating the prospective contractor's certification and required affirmations to make all reasonable good faith efforts to meet participation goals established on each individual Task Order issued pursuant to this Contract, or if a partial waiver is obtained or such goals are modified by the Agency, to meet the modified **Participation Goals** by soliciting and obtaining the participation of certified MBE and/or WBE firms. In the event that the Schedule B indicates that the bidder or proposer, as applicable, does not intend to meet the **Participation Goals** that may be established on Task Orders issued pursuant to this Contract, the bid or proposal, as applicable, shall be deemed nonresponsive.

(ii) **Participation Goals** on a Master Services Agreement will be established for individual Task Orders issued after the Master Services Agreement is awarded. If **Participation Goals** have been established on a Task Order, a contractor shall be required to submit a Schedule B – M/WBE Utilization Plan For Independently Registered Task Orders That Are Issued Pursuant to Master Services Agreements, Part II (see Pages 2-4) indicating: (a) whether the contractor is an MBE or WBE, or qualified joint venture; (b) the percentage of work it intends to award to direct subcontractors; and (c) in cases where the contractor intends to award direct subcontracts, a description of the type and dollar value of work designated for participation by MBEs and/or WBEs, and the time frames in which such work is scheduled to begin and end. The contractor must engage in good faith efforts to meet the **Participation Goals** as established for the Task Order unless Agency has granted the contractor a pre-award waiver of the Participation Goals in accordance with Section 6-129 and Part A, Section 10 below.

C. **THE BIDDER/PROPOSER MUST COMPLETE THE SCHEDULE B INCLUDED HEREIN (SCHEDULE B, PART II). A SCHEDULE B SUBMITTED BY THE BIDDER/PROPOSER WHICH DOES NOT INCLUDE THE VENDOR CERTIFICATION AND REQUIRED AFFIRMATIONS (SEE SECTION V OF PART II) WILL BE DEEMED TO BE NON-RESPONSIVE, UNLESS A FULL WAIVER OF THE PARTICIPATION GOALS IS GRANTED (SCHEDULE B, PART III). IN THE EVENT THAT THE CITY DETERMINES THAT THE BIDDER/PROPOSER HAS SUBMITTED A SCHEDULE B WHERE THE VENDOR CERTIFICATION AND REQUIRED AFFIRMATIONS ARE COMPLETED BUT OTHER ASPECTS OF THE SCHEDULE B ARE NOT COMPLETE, OR CONTAIN A COPY OR COMPUTATION ERROR THAT IS AT ODDS WITH THE VENDOR CERTIFICATION AND AFFIRMATIONS, THE BIDDER/PROPOSER WILL BE NOTIFIED BY THE AGENCY AND WILL BE GIVEN FOUR (4) CALENDAR DAYS FROM RECEIPT OF NOTIFICATION TO CURE THE SPECIFIED DEFICIENCIES AND RETURN A COMPLETED SCHEDULE B TO THE AGENCY. FAILURE TO DO _**

SO WILL RESULT IN A DETERMINATION THAT THE BID/PROPOSAL IS NON-RESPONSIVE. RECEIPT OF NOTIFICATION IS DEFINED AS THE DATE NOTICE IS E-MAILED OR FAXED (IF THE BIDDER/PROPOSER HAS PROVIDED AN E-MAIL ADDRESS OR FAX NUMBER), OR NO LATER THAN FIVE (5) CALENDAR DAYS FROM THE DATE OF MAILING OR UPON DELIVERY, IF DELIVERED.

5. Where an **M/WBE** Utilization Plan has been submitted, the Contractor shall, within 30 days of issuance by Agency of a notice to proceed, submit a list of proposed persons or entities to which it intends to award subcontracts within the subsequent 12 months. In the case of multiyear contracts, such list shall also be submitted every year thereafter. The Agency may also require the Contractor to report periodically about the contracts awarded by its direct subcontractors to indirect subcontractors (as defined in Section 6-129(c)(22)). **PLEASE NOTE: If this Contract is a public works project subject to GML §101(5) (i.e., a contract valued at or below \$3M for projects in New York City) or if the Contract is subject to a project labor agreement in accordance with Labor Law §222, and the bidder is required to identify at the time of bid submission its intended subcontractors for the Wicks trades (plumbing and gas fitting; steam heating, hot water heating, ventilating and air conditioning (HVAC); and electric wiring), the Contractor must identify all those to which it intends to award construction subcontracts for any portion of the Wicks trade work at the time of bid submission, regardless of what point in the life of the contract such subcontracts will occur. In identifying intended subcontractors in the bid submission, bidders may satisfy any Participation Goals established for this Contract by proposing one or more subcontractors that are MBEs and/or WBEs for any portion of the Wicks trade work.** In the event that the Contractor's selection of a subcontractor is disapproved, the Contractor shall have a reasonable time to propose alternate subcontractors.

6. MBE and WBE firms must be certified by DSBS in order for the Contractor to credit such firms' participation toward the attainment of the **Participation Goals**. Such certification must occur prior to the firms' commencement of work. A list of MBE and WBE firms may be obtained from the DSBS website at www.nyc.gov/buycertified, by emailing DSBS at buyer@sbs.nyc.gov, by calling (212) 513-6356, or by visiting or writing DSBS at 110 William St., New York, New York, 10038, 7th floor. Eligible firms that have not yet been certified may contact DSBS in order to seek certification by visiting www.nyc.gov/getcertified, emailing MWBE@sbs.nyc.gov, or calling the DSBS certification helpline at (212) 513-6311. A firm that is certified as both an MBE and a WBE may be counted either toward the goal for MBEs or the goal for WBEs, but not both. No credit shall be given for participation by a graduate MBE or graduate WBE, as defined in Section 6-129(c)(20).

7. Where an **M/WBE** Utilization Plan has been submitted, the Contractor shall, with each voucher for payment, and/or periodically as Agency may require, submit statements, certified under penalty of perjury, which shall include, but not be limited to, the total amount the Contractor paid to its direct subcontractors, and, where applicable pursuant to Section 6-129(j), the total amount direct subcontractors paid to indirect subcontractors; the names, addresses and contact numbers of each MBE or WBE hired as a subcontractor by the Contractor, and, where applicable, hired by any of the Contractor's direct subcontractors; and the dates and amounts paid to each MBE or WBE. The Contractor shall also submit, along with its voucher for final payment: the total amount it paid to subcontractors, and, where applicable pursuant to Section 6-129(j), the total amount its direct subcontractors paid directly to their indirect subcontractors; and a final list, certified under penalty of perjury, which shall include the name, address and contact information of each subcontractor that is an MBE or WBE, the work performed by, and the dates and amounts paid to each.

8. If payments made to, or work performed by, MBEs or WBEs are less than the amount specified in the Contractor's **M/WBE** Utilization Plan, Agency shall take appropriate action, in accordance with Section 6-129 and Article II below, unless the Contractor has obtained a modification of its **M/WBE** Utilization Plan in accordance with Section 6-129 and Part A, Section 11 below.

9. Where an **M/WBE** Utilization Plan has been submitted, and the Contractor requests a change order the value of which exceeds the greater of 10 percent of the Contract or Task Order, as applicable, or \$500,000, Agency shall review the scope of work for the Contract or Task Order, as applicable, and the scale and types of work involved in the change order, and determine whether the **Participation Goals** should be modified.

10. Pre-award waiver of the **Participation Goals**. (a) A bidder or proposer, or contractor with respect to a Task Order, may seek a pre-award full or partial waiver of the **Participation Goals** in accordance with Section 6-129, which requests that Agency change one or more **Participation Goals** on the grounds that the **Participation Goals** are unreasonable in light of the availability of certified firms to perform the services required, or by demonstrating that it has legitimate business reasons for proposing a lower level of subcontracting in its M/WBE Utilization Plan.

(b) To apply for a full or partial waiver of the **Participation Goals**, a bidder, proposer, or contractor, as applicable, must complete Part III (Page 5) of Schedule B and submit such request no later than seven (7) calendar days prior to the date and time the bids, proposals, or Task Orders are due, in writing to the Agency by email at poped@ddc.nyc.gov or via facsimile at (718) 391-1886. Bidders, proposers, or contractors, as applicable, who have submitted requests will receive an Agency response by no later than two (2) calendar days prior to the due date for bids, proposals, or Task Orders; provided, however, that if that date would fall on a weekend or holiday, an Agency response will be provided by close-of-business on the business day before such weekend or holiday date.

(c) If the Agency determines that the **Participation Goals** are unreasonable in light of the availability of certified firms to perform the services required, it shall revise the solicitation and extend the deadline for bids and proposals, or revise the Task Order, as applicable.

(d) Agency may grant a full or partial waiver of the **Participation Goals** to a bidder, proposer or contractor, as applicable, who demonstrates—before submission of the bid, proposal or Task Order, as applicable—that it has legitimate business reasons for proposing the level of subcontracting in its M/WBE Utilization Plan. In making its determination, Agency shall consider factors that shall include, but not be limited to, whether the bidder, proposer or contractor, as applicable, has the capacity and the bona fide intention to perform the Contract without any subcontracting, or to perform the Contract without awarding the amount of subcontracts represented by the **Participation Goals**. In making such determination, Agency may consider whether the M/WBE Utilization Plan is consistent with past subcontracting practices of the bidder, proposer or contractor, as applicable, whether the bidder, proposer or contractor, as applicable, has made efforts to form a joint venture with a certified firm, and whether the bidder, proposer, or contractor, as applicable, has made good faith efforts to identify other portions of the Contract that it intends to subcontract.

11. Modification of M/WBE Utilization Plan. (a) A Contractor may request a modification of its M/WBE Utilization Plan after award of this Contract. **PLEASE NOTE: If this Contract is a public works project subject to GML §101(5) (i.e., a contract valued at or below \$3M for projects in New York City) or if the Contract is subject to a project labor agreement in accordance with Labor Law §222, and the bidder is required to identify at the time of bid submission its intended subcontractors for the Wicks trades (plumbing and gas fitting; steam heating, hot water heating, ventilating and air conditioning (HVAC); and electric wiring), the Contractor may request a Modification of its M/WBE Utilization Plan as part of its bid submission.** The Agency may grant a request for Modification of a Contractor's M/WBE Utilization Plan if it determines that the Contractor has established, with appropriate documentary and other evidence, that it made reasonable, good faith efforts to meet the **Participation Goals**. In making such determination, Agency shall consider evidence of the following efforts, as applicable, along with any other relevant factors:

- (i) The Contractor advertised opportunities to participate in the Contract, where appropriate, in general circulation media, trade and professional association publications and small business media, and publications of minority and women's business organizations;
- (ii) The Contractor provided notice of specific opportunities to participate in the Contract, in a timely manner, to minority and women's business organizations;
- (iii) The Contractor sent written notices, by certified mail or facsimile, in a timely manner, to advise MBEs or WBEs that their interest in the Contract was solicited;
- (iv) The Contractor made efforts to identify portions of the work that could be substituted for portions originally designated for participation by MBEs and/or WBEs in the M/WBE Utilization Plan, and for which the Contractor claims an inability to retain MBEs or WBEs;

- (v) The Contractor held meetings with MBEs and/or WBEs prior to the date their bids or proposals were due, for the purpose of explaining in detail the scope and requirements of the work for which their bids or proposals were solicited;
- (vi) The Contractor made efforts to negotiate with MBEs and/or WBEs as relevant to perform specific subcontracts, or act as suppliers or service providers;
- (vii) Timely written requests for assistance made by the Contractor to Agency's M/WBE liaison officer and to DSBS;
- (viii) Description of how recommendations made by DSBS and Agency were acted upon and an explanation of why action upon such recommendations did not lead to the desired level of participation of MBEs and/or WBEs.

Agency's M/WBE officer shall provide written notice to the Contractor of the determination.

(b) The Agency may modify the **Participation Goals** when the scope of the work has been changed by the Agency in a manner that affects the scale and types of work that the Contractor indicated in its M/WBE Utilization Plan would be awarded to subcontractors.

12. If this Contract is for an indefinite quantity of construction, standard or professional services or is a requirements type contract and the Contractor has submitted an M/WBE Utilization Plan and has committed to subcontract work to MBEs and/or WBEs in order to meet the **Participation Goals**, the Contractor will not be deemed in violation of the M/WBE Program requirements for this Contract with regard to any work which was intended to be subcontracted to an MBE and/or WBE to the extent that the Agency has determined that such work is not needed.

13. If **Participation Goals** have been established for this Contract or a Task Order issued pursuant to this Contract, at least once annually during the term of the Contract or Task Order, as applicable, Agency shall review the Contractor's progress toward attainment of its M/WBE Utilization Plan, including but not limited to, by reviewing the percentage of work the Contractor has actually awarded to MBE and/or WBE subcontractors and the payments the Contractor made to such subcontractors.

14. If **Participation Goals** have been established for this Contract or a Task Order issued pursuant to this Contract, Agency shall evaluate and assess the Contractor's performance in meeting those goals, and such evaluation and assessment shall become part of the Contractor's overall contract performance evaluation.

PART B: MISCELLANEOUS

1. The Contractor shall take notice that, if this solicitation requires the establishment of an M/WBE Utilization Plan, the resulting contract may be audited by DSBS to determine compliance with Section 6-129. See §6-129(e)(10). Furthermore, such resulting contract may also be examined by the City's Comptroller to assess compliance with the M/WBE Utilization Plan.

2. Pursuant to DSBS rules, construction contracts that include a requirement for an M/WBE Utilization Plan shall not be subject to the law governing Locally Based Enterprises set forth in Section 6-108.1 of the Administrative Code of the City of New York.

3. DSBS is available to assist contractors and potential contractors in determining the availability of MBEs and/or WBEs to participate as subcontractors, and in identifying opportunities that are appropriate for participation by MBEs and/or WBEs in contracts.

4. Prospective contractors are encouraged to enter into qualified joint venture agreements with MBEs and/or WBEs as defined by Section 6-129(c)(30).

5. By submitting a bid or proposal the Contractor hereby acknowledges its understanding of the M/WBE Program requirements set forth herein and the pertinent provisions of Section 6-129, and any rules promulgated thereunder, and if awarded this Contract, the Contractor hereby agrees to comply with the M/WBE Program requirements of this Contract and pertinent provisions of Section 6-129, and any rules promulgated thereunder, all of which shall be deemed to be material terms of this Contract. The Contractor hereby agrees to make all reasonable, good faith efforts to solicit and obtain the participation of MBEs and/or WBEs to meet the required **Participation Goals**.

ARTICLE II. ENFORCEMENT

1. If Agency determines that a bidder or proposer, as applicable, has, in relation to this procurement, violated Section 6-129 or the DSBS rules promulgated pursuant to Section 6-129, Agency may disqualify such bidder or proposer, as applicable, from competing for this Contract and the Agency may revoke such bidder's or proposer's prequalification status, if applicable.

2. Whenever Agency believes that the Contractor or a subcontractor is not in compliance with Section 6-129 or the DSBS rules promulgated pursuant to Section 6-129, or any provision of this Contract that implements Section 6-129, including, but not limited to any **M/WBE Utilization Plan**, Agency shall send a written notice to the Contractor describing the alleged noncompliance and offering the Contractor an opportunity to be heard. Agency shall then conduct an investigation to determine whether such Contractor or subcontractor is in compliance.

3. In the event that the Contractor has been found to have violated Section 6-129, the DSBS rules promulgated pursuant to Section 6-129, or any provision of this Contract that implements Section 6-129, including, but not limited to, any **M/WBE Utilization Plan**, Agency may determine that one of the following actions should be taken:

- (a) entering into an agreement with the Contractor allowing the Contractor to cure the violation;
- (b) revoking the Contractor's pre-qualification to bid or make proposals for future contracts;
- (c) making a finding that the Contractor is in default of the Contract;
- (d) terminating the Contract;
- (e) declaring the Contractor to be in breach of Contract;
- (f) withholding payment or reimbursement;
- (g) determining not to renew the Contract;
- (h) assessing actual and consequential damages;
- (i) assessing liquidated damages or reducing fees, provided that liquidated damages may be based on amounts representing costs of delays in carrying out the purposes of the M/WBE Program, or in meeting the purposes of the Contract, the costs of meeting utilization goals through additional procurements, the administrative costs of investigation and enforcement, or other factors set forth in the Contract;
- (j) exercising rights under the Contract to procure goods, services or construction from another contractor and charge the cost of such contract to the Contractor that has been found to be in noncompliance; or
- (k) taking any other appropriate remedy.

4. If an **M/WBE Utilization Plan** has been submitted, and pursuant to this Article II, Section 3, the Contractor has been found to have failed to fulfill its **Participation Goals** contained in its **M/WBE Utilization Plan** or the **Participation Goals** as modified by Agency pursuant to Article I, Part A, Section 11, Agency may assess liquidated damages in the amount of ten percent (10%) of the difference between the dollar amount of work required to be awarded to MBE and/or WBE firms to meet the **Participation Goals** and the dollar amount the Contractor actually awarded and paid, and/or credited, to MBE and/or WBE firms. In view of the difficulty of accurately ascertaining the loss which the City will suffer by reason of Contractor's failure to meet the **Participation Goals**, the foregoing amount is hereby fixed and agreed as the liquidated damages that the City will suffer by reason of such failure, and not as a penalty. Agency may deduct and retain out of any monies which may become due under this Contract the amount of any such liquidated damages; and in case the amount which may become due under this Contract shall be less than the amount of liquidated damages suffered by the City, the Contractor shall be liable to pay the difference.

5. Whenever Agency has reason to believe that an MBE and/or WBE is not qualified for certification, or is participating in a contract in a manner that does not serve a commercially useful function (as defined in Section 6-129(c)(8)), or has violated any provision of Section 6-129, Agency shall notify the Commissioner of DSBS who shall determine whether the certification of such business enterprise should be revoked.

6. Statements made in any instrument submitted to Agency pursuant to Section 6-129 shall be submitted under penalty of perjury and any false or misleading statement or omission shall be grounds for the application of any applicable criminal and/or civil penalties for perjury. The making of a false or fraudulent statement by an MBE and/or WBE in any instrument submitted pursuant to Section 6-129 shall, in addition, be grounds for revocation of its certification.

7. The Contractor's record in implementing its M/WBE Utilization Plan shall be a factor in the evaluation of its performance. Whenever Agency determines that a Contractor's compliance with an M/WBE Utilization Plan has been unsatisfactory, Agency shall, after consultation with the City Chief Procurement Officer, file an advice of caution form for inclusion in VENDEX as caution data.

SCHEDULE B – M/WBE Utilization Plan
Part I: M/WBE Participation Goals

Part I to be completed by contracting agency

Contract Overview

APT E- Pin # 85015B0135 FMS Project ID#: HWQ121B4
 Project Title/ Agency PIN # RECONSTRUCTION OF LAKEVIEW BOULEVARD EAST / 8502015HW0021C
 Bid/Proposal Response Date JUNE 16, 2015
 Contracting Agency Department of Design and Construction
 Agency Address 30-30 Thomson Ave. City Long Island City State NY Zip Code 11101
 Contact Person Ann-Chevealle Brown Title MWBE Liaison & Compliance
 Telephone # (718) 391-1175 Email Brownann@ddc.nyc.gov

Project Description (attach additional pages if necessary)

RECONSTRUCTION OF LAKEVIEW BOULEVARD EAST
 LAKEVIEW LANE - FROM BAISLEY BOULEVARD TO 122ND AVENUE
 122ND AVENUE - FROM LAKEVIEW LANE TO LAKEVIEW BOULEVARD EAST
 LAKEVIEW BOULEVARD EAST - FROM 122ND AVENUE TO 118TH AVENUE
 118TH AVENUE - FROM LAKEVIEW BOULEVARD EAST TO LONG STREET
NEW STORM AND SANITARY SEWERS (SEQ200436) IN:
 LAKEVIEW LANE - FROM BAISLEY BOULEVARD TO 122ND AVENUE
 122ND AVENUE - FROM LAKEVIEW LANE TO LAKEVIEW BOULEVARD EAST
 LAKEVIEW BOULEVARD EAST - FROM 122ND AVENUE TO 118 TH AVENUE
 119TH AVENUE - FROM LONG STREET TO 164TH STREET
 164TH STREET - FROM 119TH AVENUE TO 120TH AVENUE
CAPITAL PROJECT WM-1
WATER MAIN WORK IN:
 LAKEVIEW LANE - FROM BAISLEY BOULEVARD TO 122ND AVENUE
 122ND AVENUE - FROM LAKEVIEW LANE TO LAKEVIEW BOULEVARD EAST
 LAKEVIEW BOULEVARD EAST - FROM 122ND AVENUE TO 118TH AVENUE
 118TH AVENUE - FROM LAKEVIEW BOULEVARD EAST TO LONG STREET
 119TH AVENUE - FROM LONG STREET TO 164TH STREET
 164TH STREET - FROM 119TH AVENUE TO 120TH AVENUE
INCLUDING STREET LIGHTING AND TRAFFIC WORK
 Together With All Work Incidental Thereto
BOROUGH OF QUEENS
CITY OF NEW YORK

M/WBE Participation Goals for Services

Enter the percentage amount for each group or for an unspecified goal. Please note that there are no goals for Asian Americans in Professional Services.

Prime Contract Industry: Construction

Group	Percentage
Unspecified*	
or	12%
Black American	UNSPECIFIED*
Hispanic American	UNSPECIFIED*
Asian American	UNSPECIFIED*
Women	UNSPECIFIED*
Total Participation Goals	12% Line 1

*Note: For this procurement, individual ethnicity and gender goals are not specified. The Total Participation Goal for construction contracts may be met by using either Black-American, Hispanic-American, Asian American, or Women certified firms or any combination of such firms.

Tax ID #: 20.4708892

APT E-
PIN #: _____

SCHEDULE B - Part II: M/WBE Participation Plan

Part II to be completed by the bidder/proposer.

Please note: For Non-M/WBE Prime Contractors who will NOT subcontract any services and will self-perform the entire contract, you must obtain a FULL waiver by completing the Waiver Application on pages 17 and 18 and timely submitting it to the contracting agency pursuant to the Notice to Prospective Contractors. Once a FULL WAIVER is granted, it must be included with your bid or proposal and you do not have to complete or submit this form with your bid or proposal.

Section I: Prime Contractor Contact Information

Tax ID # 20.4708892 FMS Vendor ID # _____
 Business Name PTI Contracting Corp. Contact Person Lenny Pereira
 Address 2417 Seneca Pkwy # 315 Garden City Park N.Y 11040
 Telephone # 718.206.0245 Email ptcontracting@gmail.com

Section II: M/WBE Utilization Goal Calculation: Check the applicable box and complete subsection.

PRIME CONTRACTOR ADOPTING AGENCY M/WBE PARTICIPATION GOALS

<input checked="" type="checkbox"/> For Prime Contractors (including Qualified Joint Ventures and M/WBE firms) adopting Agency M/WBE Participation Goals.	Total Bid/Proposal Value	Agency Total Participation Goals (Line 1, Page 13)	Calculated M/WBE Participation Amount
Calculate the total dollar value of your total bid that you agree will be awarded to M/WBE subcontractors for services and/or credited to an M/WBE prime contractor or Qualified Joint Venture. Please review the Notice to Prospective Contractors for more information on how to obtain credit for M/WBE participation.	\$11,729,618.01 X	12%	= \$ 1,407,554.16 Line 2

PRIME CONTRACTOR OBTAINED PARTIAL WAIVER APPROVAL: ADOPTING MODIFIED M/WBE PARTICIPATION GOALS

<input type="checkbox"/> For Prime Contractors (including Qualified Joint Ventures and M/WBE firms) adopting Modified M/WBE Participation Goals.	Total Bid/Proposal Value	Adjusted Participation Goal (From Partial Waiver)	Calculated M/WBE Participation Amount
Calculate the total dollar value of your total bid that you agree will be awarded to M/WBE subcontractors for services and/or credited to an M/WBE prime contractor or Qualified Joint Venture. Please review the Notice to Prospective Contractors for more information on how to obtain credit for M/WBE participation.	\$ X		= \$ Line 3

Section III: M/WBE Utilization Plan: How Proposer/Bidder Will Fulfill M/WBE Participation Goals. Please review the Notice to Prospective Contractors for more information on how to obtain credit for M/WBE participation. Check applicable box. The Proposer or Bidder will fulfill the M/WBE Participation Goals:

- As an M/WBE Prime Contractor that will self-perform and/or subcontract to other M/WBE firms a portion of the contract the value of which is at least the amount located on Lines 2 or 3 above, as applicable. The value of any work subcontracted to non-M/WBE firms will not be credited towards fulfillment of M/WBE Participation Goals. Please check all that apply to Prime Contractor:
 MBE WBE
- As a Qualified Joint Venture with an M/WBE partner, in which the value of the M/WBE partner's participation and/or the value of any work subcontracted to other M/WBE firms is at least the amount located on Lines 2 or 3 above, as applicable. The value of any work subcontracted to non M/WBE firms will not be credited towards fulfillment of M/WBE Participation Goals.
- As a non M/WBE Prime Contractor that will enter into subcontracts with M/WBE firms the value of which is at least the amount located on Lines 2 or 3 above, as applicable.

Section IV: General Contract Information

What is the expected percentage of the total contract dollar value that you expect to award in subcontracts for services, regardless of M/WBE status? % 23.3597 %

Enter brief description of the type(s) and dollar value of subcontracts for all/any services you plan on subcontracting if awarded this contract. For each item, indicate whether the work is designated for participation by MBEs and/or WBEs and the time frame in which such work is scheduled to begin and end. Use additional sheets if necessary.

Line	MBE/WBE	Description	Value	Time Frame
1	MBE	Trucking	300,000.00	Entire length of contract
2	MBE	Asphalt Paving	910,000.00	Last 1/4 of Project
3	MBE	Robot Entering	20,000.00	Entire length of Contract
4	MBE	Photo + Video	40,000.00	Entire length of Project
5	MBE	Tree Consultant	90,000.00	Entire length of Project
6	MBE	Tree Pruning + Removal	50,000.00	First half of Project
7	Non MBE	Line Stripping	15,000.00	Last 1/4 of Project
8	Non MBE	Tree Planting	70,000.00	Last 1/4 of Project
9	Non MBE	Leak + Compaction	35,000.00	Entire length of Project
10	Non MBE	Pile Driving	50,000.00	Entire length of Project
11	Non MBE	Electric Work	85,000.00	Last 1/4 of Project
12	Non MBE	Deaerating	75,000.00	Entire length of Project
13	Non MBE	Best Management Practices	1,000,000.00	Entire length of Project
14				
15				
16				
17				

✓ Scopes of Subcontract Work

Tax ID #: 20.4708892

APT E-
PIN #: _____

Section V: Vendor Certification and Required Affirmations

I hereby:

- 1) acknowledge my understanding of the M/WBE participation requirements as set forth herein and the pertinent provisions of Section 6-129 of the Administrative Code of the City of New York ("Section 6-129"), and the rules promulgated thereunder;
- 2) affirm that the information supplied in support of this M/WBE Utilization Plan is true and correct;
- 3) agree, if awarded this Contract, to comply with the M/WBE participation requirements of this Contract, the pertinent provisions of Section 6-129, and the rules promulgated thereunder, all of which shall be deemed to be material terms of this Contract;
- 4) agree and affirm that it is a material term of this Contract that the Vendor will award the total dollar value of the M/WBE Participation Goals to certified MBEs and/or WBEs, unless a full waiver is obtained or such goals are modified by the Agency; and
- 5) agree and affirm, if awarded this Contract, to make all reasonable, good faith efforts to meet the M/WBE Participation Goals, or if a partial waiver is obtained or such goals are modified by the Agency, to meet the modified Participation Goals by soliciting and obtaining the participation of certified MBE and/or WBE firms.

Signature		Date	<u>6/16/15</u>
Print Name	<u>Lenny Pereira</u>	Title	<u>President</u>

SCHEDULE B – PART III – REQUEST FOR WAIVER OF M/WBE PARTICIPATION REQUIREMENT

Contract Overview

Tax ID # _____ FMS Vendor ID # _____
 Business Name _____
 Contact Name _____ Telephone # _____ Email _____
 Type of Procurement Competitive Sealed Bids Other Bid/Response Due Date _____
 APT E-PIN # (for this procurement): _____ Contracting Agency: _____

M/WBE Participation Goals as described in bid/solicitation documents

_____ % Agency M/WBE Participation Goal

Proposed M/WBE Participation Goal as anticipated by vendor seeking waiver

_____ % of the total contract value anticipated in good faith by the bidder/proposer to be subcontracted for services and/or credited to an M/WBE Prime Contractor or Qualified Joint Venture.

Basis for Waiver Request: Check appropriate box & explain in detail below (attach additional pages if needed)

- Vendor does not subcontract services, and has the capacity and good faith intention to perform all such work itself with its own employees.
- Vendor subcontracts some of this type of work but at a lower % than bid/solicitation describes, and has the capacity and good faith intention to do so on this contract. (Attach subcontracting plan outlining services that the vendor will self-perform and subcontract to other vendors or consultants.)
- Vendor has other legitimate business reasons for proposing the M/WBE Participation Goal above. Explain under separate cover.

References

List 3 most recent contracts performed for NYC agencies (if any). Include information for each subcontract awarded in performance of such contracts. Add more pages if necessary.

CONTRACT NO. _____	AGENCY _____	DATE COMPLETED _____
Total Contract Amount \$ _____	Total Amount Subcontracted \$ _____	
Item of Work Subcontracted and Value of subcontract _____	Item of Work Subcontracted and Value of subcontract _____	Item of Work Subcontracted and Value of subcontract _____
CONTRACT NO. _____	AGENCY _____	DATE COMPLETED _____
Total Contract Amount \$ _____	Total Amount Subcontracted \$ _____	
Item of Work Subcontracted and Value of subcontract _____	Item of Work Subcontracted and Value of subcontract _____	Item of Work Subcontracted and Value of subcontract _____
CONTRACT NO. _____	AGENCY _____	DATE COMPLETED _____
Total Contract Amount \$ _____	Total Amount Subcontracted \$ _____	
Item of Work Subcontracted and Value of subcontract _____	Item of Work Subcontracted and Value of subcontract _____	Item of Work Subcontracted and Value of subcontract _____

List 3 most recent contracts performed for other entities. Include information for each subcontract awarded in performance of such contracts. Add more pages if necessary.

(Complete ONLY if vendor has performed fewer than 3 New York City contracts.)

TYPE OF Contract	ENTITY	DATE COMPLETED
Manager at entity that hired vendor (Name/Phone No./Email)		
Total Contract Amount \$	Total Amount Subcontracted \$	
Type of Work Subcontracted		

TYPE OF Contract	AGENCY/ENTITY	DATE COMPLETED
Manager at agency/entity that hired vendor (Name/Phone No./Email)		
Total Contract Amount \$	Total Amount Subcontracted \$	
Item of Work Subcontracted and Value of subcontract	Item of Work Subcontracted and Value of subcontract	Item of Work Subcontracted and Value of subcontract

TYPE OF Contract	AGENCY/ENTITY	DATE COMPLETED
Manager at entity that hired vendor (Name/Phone No./Email)		
Total Contract Amount \$	Total Amount Subcontracted \$	
Item of Work Subcontracted and Value of subcontract	Item of Work Subcontracted and Value of subcontract	Item of Work Subcontracted and Value of subcontract

VENDOR CERTIFICATION: I hereby affirm that the information supplied in support of this waiver request is true and correct, and that this request is made in good faith.

Signature: _____ Date: _____
 Print Name: _____ Title: _____

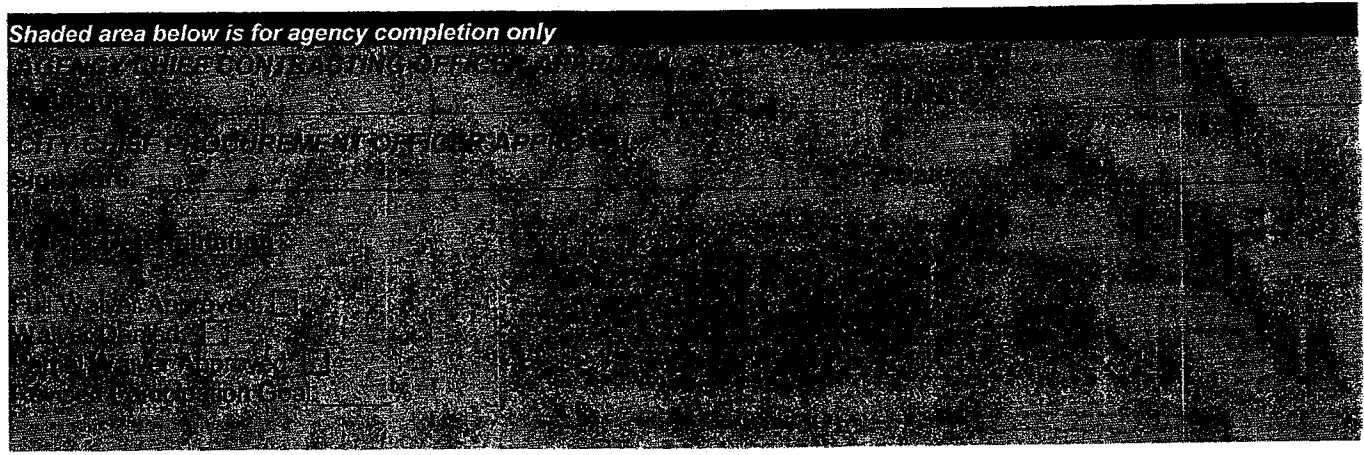

APPRENTICESHIP PROGRAM REQUIREMENTS

Bidders are advised that the Apprenticeship Program Requirements set forth below apply to each contract for which a check mark is indicated before the word "Yes". Compliance with these requirements will be determined solely by the City.

YES NO

(1) Apprenticeship Program Requirements

Notice to Bidders: Please be advised that, pursuant to the authority granted to the City under Labor Law Section 816-b, the Department of Design and Construction hereby requires that the contractor awarded a contract as a result of this Invitation for Bids, and any of its subcontractors with subcontracts worth one million dollars or over, have, prior to entering into such contract or subcontract, apprenticeship agreements appropriate for the type and scope of work to be performed that have been registered with, and approved by, the New York State Commissioner of Labor. In addition, the contractor and its subcontractors will be required to show that such apprenticeship programs have three years of current, successful experience in providing career opportunities.

The failure to prove, upon request, that these requirements have been met shall result in the contract not being awarded to the contractor or the subcontract not being approved.

Please be further advised that, pursuant to Labor Law Section 220, the allowable ratio of apprentices to journeypersons in any craft classification shall not be greater than the ratio permitted to the contractor as to its workforce on any job under the registered apprenticeship program.

(2) Apprenticeship Program Questionnaire

The bidder must submit a completed and signed Apprenticeship Program Questionnaire. The Questionnaire is set forth on the following page of the Bid Booklet.

SAFETY QUESTIONNAIRE

The bidder must include, with its bid, all information requested on this Safety Questionnaire. Failure to provide a completed and signed Safety Questionnaire at the time of bid opening may result in disqualification of the bid as non-responsive.

1. Bidder Information:

Company Name: _____

DDC Project Number: _____

Company Size: _____ Ten (10) employees or less
_____ Greater than ten (10) employees

Company has previously worked for DDC _____ YES _____ NO

2. Type(s) of Construction Work

TYPE OF WORK	LAST 3 YEARS	THIS PROJECT
General Building Construction	_____	_____
Residential Building Construction	_____	_____
Nonresidential Building Construction	_____	_____
Heavy Construction, except building	_____	_____
Highway and Street Construction	_____	_____
Heavy Construction, except highways	_____	_____
Plumbing, Heating, HVAC	_____	_____
Painting and Paper Hanging	_____	_____
Electrical Work	_____	_____
Masonry, Stonework and Plastering	_____	_____
Carpentry and Floor Work	_____	_____
Roofing, Siding, and Sheet Metal	_____	_____
Concrete Work	_____	_____
Specialty Trade Contracting	_____	_____
Asbestos Abatement	_____	_____
Other (specify)	_____	_____
_____	_____	_____

3. Experience Modification Rate:

The Experience Modification Rate (EMR) is a rating generated by the National Council of Compensation Insurance (NCCI). This rating is used to determine the contractor's premium for worker's compensation insurance. The contractor may obtain its EMR by contacting its insurance broker or the NCCI. If the contractor cannot obtain its EMR, it must submit a written explanation as to why.

Project ID. _____

The Contractor must indicate its Intrastate and Interstate EMR for the past three years. [Note: For contractors with less than three years of experience, the EMR will be considered to be 1.00].

YEAR	INTRASTATE RATE	INTERSTATE RATE
_____	_____	_____
_____	_____	_____
_____	_____	_____

If the Intrastate and/or Interstate EMR for any of the past three years is greater than 1.00, the contractor must attach, to this questionnaire, a written explanation for the rating and identify what corrective action was taken to correct the situation resulting in that rating.

4. OSHA Information:

___ YES ___ NO Contractor has received a willful violation issued by OSHA or New York City Department of Buildings (NYCDOB) within the last three years.

___ YES ___ NO Contractor has had an incident requiring OSHA notification within 8 hours (all work-related fatalities) or an incident requiring OSHA notification within 24 hours (all work-related impatient hospitalizations, all amputations and all losses of an eye).

The Occupational Safety and Health Act (OSHA) of 1970 requires employers with ten or more employees, on a yearly basis to complete and maintain on file the form entitled "Log of Work-related Injuries and Illnesses". This form is commonly referred to as the OSHA 300 Log (OSHA 200 Log for 2001 and earlier).

The OSHA 300 Log must be submitted for the last three years for contractors with more than ten employees.

The Contractor must indicate the total number of hours worked by its employees, as reflected in payroll records for the past three years.

The contractor must submit the Incident Rate for Lost Time Injuries (the Incident Rate) for the past three years. The Incident Rate is calculated in accordance with the formula set forth below. For each given year, the total number of incidents is the total number of non-fatal injuries and illnesses reported on the OSHA 300 Log. The 200,000 hours represents the equivalent of 100 employees working forty hours a week, fifty weeks per year.

$$\text{Incident Rate} = \frac{\text{Total Number of Incidents} \times 200,000}{\text{Total Number of Hours Worked by Employees}}$$

YEAR	TOTAL NUMBERS OF HOURS WORKED BY EMPLOYEES	INCIDENT RATE
_____	_____	_____
_____	_____	_____
_____	_____	_____

If the contractor's Incident Rate for any of the past three years is one point higher than the Incident Rate for the type of construction it performs (listed below), the contractor must attach, to this questionnaire, a written explanation for the relatively high rate.

General Building Construction	8.5
Residential Building Construction	7.0
Nonresidential Building Construction	10.2
Heavy Construction, except building	8.7
Highway and Street Construction	9.7
Heavy Construction, except highways	8.3
Plumbing, Heating, HVAC	11.3
Painting and Paper Hanging	6.9
Electrical Work	9.5
Masonry, Stonework and Plastering	10.5
Carpentry and Floor Work	12.2
Roofing, Siding, and Sheet Metal	10.3
Concrete Work	8.6
Specialty Trade Contracting	8.6

5. Safety Performance on Previous DDC Project(s)

YES NO Contractor previously audited by the DDC Office of Site Safety.

DDC Project Number(s): _____, _____, _____

YES NO Accident on previous DDC Project(s).

DDC Project Number(s): _____, _____, _____

YES NO Fatality or Life-altering Injury on DDC Project(s) within the last three years. [Examples of a life-altering injury include loss of limb, loss of a sense (e.g., sight, hearing), or loss of neurological function].

DDC Project Number(s): _____, _____, _____

Date: _____

By: _____
(Signature of Owner, Partner, Corporate Officer)

Title: _____

(NO TEXT ON THIS PAGE)

Pre-Award Process

The bidder is advised that as part of the pre-award review of its bid, it may be required to submit the information described in Sections (A) through (D) below. If required, such information must be submitted by the bidder within five (5) business days following receipt of notification from DDC that it is among the low bidders. Such notification from DDC will be by facsimile or in writing and will specify the types of information must be submitted. The types of information the bidder may be required to submit are described below. In the event the bidder fails to submit the required information within the specified time frame, its bid may be rejected as nonresponsive.

- (A) **Project Reference Form:** If required, the bidder must complete and submit the Project Reference Form set forth on pages 26 through 28 of this Bid Booklet. The Project Reference Form consists of 3 parts: (1) Similar Contracts Completed by the Bidder, (2) Contracts Currently Under Construction by the Bidder, and (3) Pending Contracts Not Yet Started by the Bidder.
- (B) **Copy of License:** If required, the bidder must submit a copy of the license under which the bidder will be performing the work. Such license must clearly show the following: (1) Name of the Licensee, (2) License Number, and (3) Expiration date of the License. A copy of the license will be required from bidders for the following contracts: Plumbing Work, Electrical Work and Asbestos Abatement.
- (C) **Financial Information:** If required, the bidder must submit the financial information described below:
- (1) **Audited Financial Statements:** Financial statements (Balance Sheet and Income Statement) of the entity submitting the bid, as audited by an independent auditor licensed to practice as a certified public accountant (CPA). Audited financial statements for the three most recent fiscal years must be submitted. Each such financial statement must include the auditor's standard report.
- If the bidder does not have audited financial statements, it must submit an affidavit attesting to the fact that the bidder does not have such statements. In addition, the bidder must submit the following documentation covering the three most recent fiscal years: signed federal tax returns, unaudited financial statements, and a "certified review letter" from a certified public accountant (CPA) verifying the unaudited financial statements.
- Unless the most recent audited or unaudited financial statement was issued within ninety (90) days, the bidder must submit interim financial information that includes data on financial position and results of operation (income data) for the current fiscal year. Such information may be summarized on a monthly or quarterly basis or at other intervals.
- (2) **Schedule of Aged Accounts Receivable,** including portion due within ninety (90) days.

(D) **Project Specific Information:** If required, the bidder must submit the project specific information described below:

- (1) Statement indicating the number of years of experience the bidder has had and in what type of construction.
- (2) Resumes of all key personnel to be involved in the project, including the proposed project superintendent.
- (3) List of significant pieces of equipment expected to be used for the contract, and whether such equipment is owned or leased.
- (4) Description of work expected to be subcontracted, and to what firms, if known.
- (5) List of key material suppliers.
- (6) Preliminary bar chart time schedule
- (7) Contractor's expected means of financing the project. This should be based on the assumption that the contractor is required to finance 2X average monthly billings throughout the contract period.
- (8) Any other issues the contractor sees as impacting his ability to complete the project according to the contract.

In addition to the information described in Sections (A) through (D) above, the bidder shall submit such additional information as the Commissioner may require, including without limitation, an explanation or justification for specific unit price items.

The bidder is further advised that it may be required to attend a pre-award meeting with DDC representatives. If such a meeting is convened, the bidder will be advised as to any additional material to be provided.

A. PROJECT REFERENCES – SIMILAR CONTRACTS COMPLETED BY THE BIDDER

List all contracts substantially completed within the last 4 years similar to the contract being awarded, up to a maximum of 10, in descending order of date of substantial completion.

Project & Location	Contract Type	Contract Amount (\$000)	Date Completed	Owner Reference & Tel. No.	Architect/Engineer Reference & Tel. No. if different from owner

B. PROJECT REFERENCES – CONTRACTS CURRENTLY UNDER CONSTRUCTION BY THE BIDDER

List all contracts currently under construction even if they are not similar to the contract being awarded.

Project & Location	Contract Type	Contract Amount (\$000)	Subcontracted to Others (\$000)	Uncompleted Portion (\$000)	Date Scheduled to Complete	Owner Reference & Tel. No.	Architect/Engineer Reference & Tel. No. if different from owner

C. PROJECT REFERENCES – PENDING CONTRACTS NOT YET STARTED BY THE BIDDER

List all contracts awarded to or won by the bidder but not yet started.

Project & Location	Contract Type	Contract Amount (\$000)	Date Scheduled to Start	Owner Reference & Tel. No.	Architect/Engineer Reference & Tel. No. if different from owner

(NO TEXT ON THIS PAGE)

**OFFICE OF THE MAYOR
BUREAU OF LABOR SERVICES
CONTRACT CERTIFICATE**

To be completed if the contract is less than \$1,000,000

Contractor: _____

Address: _____

Telephone Number: _____

Name and Title of Signatory: _____

Contracting Agency or Owner: _____

Project Number: _____

Proposed Contract Amount: _____

Description and Address of Proposed Contract: _____

Names of Subcontractors in the amount of 750,000 or more on this contract (if not known at this time, so state indicating that trades will be subcontracted):

I, (fill in name of person signing) _____,
hereby affirm that I am authorized by the above-named contractor to certify that said contractor's proposed contract with the above-named owner or city agency is less than \$1,000,000. This affirmation is made in accordance with Executive Order No. 50 (1980) as amended and its implementing regulations.

Date

Signature

WILLFUL OR FRAUDULENT FALSIFICATION OF ANY DATA OR INFORMATION SUBMITTED HEREWITH MAY RESULT IN THE TERMINATION OF ANY CONTRACT BETWEEN THE CITY AND THE BIDDER OR CONTRACTOR AND BAR THE BIDDER OR CONTRACTOR FROM PARTICIPATION IN ANY CITY CONTRACT FOR A PERIOD OF UP TO THREE YEARS. FURTHER, SUCH FALSIFICATION MAY RESULT IN CRIMINAL PROSECUTION.

(NO TEXT ON THIS PAGE)

Certificate of No Change Form

- Please submit two completed forms. Copies will not be accepted.
- Please send both copies to the agency that requested it, unless you are advised to send it directly to the Mayor's Office of Contract Services (MOCS).
- A materially false statement willfully or fraudulently made in connection with this certification, and/or the failure to conduct appropriate due diligence in verifying the information that is the subject of this certification, may result in rendering the submitting entity non-responsible for the purpose of contract award.
- A materially false statement willfully or fraudulently made in connection with this certification may subject the person making the false statement to criminal charges

I, Lenny Pereira, being duly sworn, state that I have read
Enter Your Name

and understand all the items contained in the vendor questionnaire and any submission of change as identified on page one of this form and certify that as of this date, these items have not changed. I further certify that, to the best of my knowledge, information and belief, those answers are full, complete, and accurate; and that, to the best of my knowledge, information, and belief, those answers continue to be full, complete, and accurate.

In addition, I further certify on behalf of the submitting vendor that the information contained in the principal questionnaire(s) and any submission of change identified on page two of this form have not changed and have been verified and continue, to the best of my knowledge, to be full, complete and accurate.

I understand that the City of New York will rely on the information supplied in this certification as additional inducement to enter into a contract with the submitting entity.

Vendor Questionnaire *This section is required.*

This refers to the vendor questionnaire(s) submitted for the vendor doing business with the City.

Name of Submitting Entity: P#T II Contracting Corp.

Vendor's Address: 2417 Jericho Tpke #315 Garden City PARK, NY 11040

Vendor's EIN or TIN: 20-4708892 Requesting Agency: NYCDDC

Are you submitting this Certification as a parent? (Please circle one) Yes No

Signature date on the last full vendor questionnaire signed for the submitting vendor: 9.27.12

Signature date on change submission for the submitting vendor: _____

Principal Questionnaire

This section refers to the most recent principal questionnaire submissions.



	Principal Name	Date of signature on last full Principal Questionnaire	Date(s) of signature on submission of change
1	Lenny Pereira	9.27.12	
2	Daniel McCollon	9.27.12	
3	Gil Gomes	9.27.12	
4	Lenny S. Pereira	9.27.12	
5			
6			

Check if additional changes were submitted and attach a document with the date of additional submissions.

Certification *This section is required.*

This form must be signed and notarized. Please complete this twice. Copies will not be accepted.

Certified By:

Lenny Pereira
Name (Print)

President
Title

P&T II Contracting Corp.
Name of Submitting Entity

[Signature] 9/2/15
Signature Date

CLAUDIA J WHITFIELD

NOTARY PUBLIC-STATE OF NEW YORK

No. 01WH5004514

Qualified in Queens County

My Commission Expires November 16, 2018

Notarized By:

[Signature]
Notary Public

County License Issued License Number

Sworn to before me on: 9/2/15
Date

IRAN DIVESTMENT ACT COMPLIANCE RIDER

FOR NEW YORK CITY CONTRACTORS

The Iran Divestment Act of 2012, effective as of April 12, 2012, is codified at State Finance Law (“SFL”) §165-a and General Municipal Law (“GML”) §103-g. The Iran Divestment Act, with certain exceptions, prohibits municipalities, including the City, from entering into contracts with persons engaged in investment activities in the energy sector of Iran. Pursuant to the terms set forth in SFL §165-a and GML §103-g, a person engages in investment activities in the energy sector of Iran if:

- (a) The person provides goods or services of twenty million dollars or more in the energy sector of Iran, including a person that provides oil or liquefied natural gas tankers, or products used to construct or maintain pipelines used to transport oil or liquefied natural gas, for the energy sector of Iran; or
- (b) The person is a financial institution that extends twenty million dollars or more in credit to another person, for forty-five days or more, if that person will use the credit to provide goods or services in the energy sector in Iran and is identified on a list created pursuant to paragraph (b) of subdivision three of Section 165-a of the State Finance Law and maintained by the Commissioner of the Office of General Services.

A bid or proposal shall not be considered for award nor shall any award be made where the bidder or proposer fails to submit a signed and verified bidder’s certification.

Each bidder or proposer must certify that it is not on the list of entities engaged in investment activities in Iran created pursuant to paragraph (b) of subdivision 3 of Section 165-a of the State Finance Law. In any case where the bidder or proposer cannot certify that they are not on such list, the bidder or proposer shall so state and shall furnish with the bid or proposal a signed statement which sets forth in detail the reasons why such statement cannot be made. The City of New York may award a bid to a bidder who cannot make the certification on a case by case basis if:

- (1) The investment activities in Iran were made before the effective date of this section (i.e., April 12, 2012), the investment activities in Iran have not been expanded or renewed after the effective date of this section and the person has adopted, publicized and is implementing a formal plan to cease the investment activities in Iran and to refrain from engaging in any new investments in Iran: or
- (2) The City makes a determination that the goods or services are necessary for the City to perform its functions and that, absent such an exemption, the City would be unable to obtain the goods or services for which the contract is offered. Such determination shall be made in writing and shall be a public document.

**BIDDER'S CERTIFICATION OF COMPLIANCE WITH
IRAN DIVESTMENT ACT**

Pursuant to General Municipal Law §103-g, which generally prohibits the City from entering into contracts with persons engaged in investment activities in the energy sector of Iran, the bidder/proposer submits the following certification:

[Please Check One]

BIDDER'S CERTIFICATION

- By submission of this bid or proposal, each bidder/proposer and each person signing on behalf of any bidder/proposer certifies, and in the case of a joint bid each party thereto certifies as to its own organization, under penalty of perjury, that to the best of its knowledge and belief, that each bidder/proposer is not on the list created pursuant to paragraph (b) of subdivision 3 of Section 165-a of the State Finance Law.

- I am unable to certify that my name and the name of the bidder/proposer does not appear on the list created pursuant to paragraph (b) of subdivision 3 of Section 165-a of the State Finance Law. I have attached a signed statement setting forth in detail why I cannot so certify.

SIGNATURE

PRINTED NAME

TITLE

Sworn to before me this
_____ day of _____, 20____

Notary Public

Dated:

**THE CITY OF NEW YORK
DEPARTMENT OF SMALL BUSINESS SERVICES
DIVISION OF LABOR SERVICES
CONTRACT COMPLIANCE UNIT
110 WILLIAMS STREET
NEW YORK, NEW YORK 10038
PHONE: (212) 513-6323
FAX: (212) 618-8879**

CONSTRUCTION

EMPLOYMENT

REPORT

(NO TEXT ON THIS PAGE)

The City of New York
 Department of Small Business Services
 Division of Labor Services
 Contract Compliance Unit
 110 William Street
 New York, New York 10038
 Phone: (212) 513 - 6323
 Fax: (212) 618-8879

CONSTRUCTION EMPLOYMENT REPORT
 INSTRUCTIONS

WHO MUST FILE A CONSTRUCTION EMPLOYMENT REPORT

A Construction Employment Report (ER) must be filed if you meet the following conditions:

CONTRACT FUNDING SOURCE	CONTRACTOR	CONTRACT VALUE	SUBMISSION REQUIREMENT
Federal/Federally assisted	Prime and subcontractors	\$10,000 or greater	Construction Employment Report
City and state funded	Prime contractor	\$1,000,000 or greater	
	Subcontractor	\$750,000 or greater	
		Less than \$750,000	Less than \$750,000 Certificate (City/State Only)

Prime Contractor:

- A general contractor or construction manager selected to perform work on a construction project funded (in whole or in part) by the federal government with a proposed contract value of \$10,000 or more.
- A general contractor or construction manager selected to perform work on a construction project funded or assisted by the City of New York with a proposed contract value of \$1,000,000 or more.

Subcontractor:

- A subcontractor selected to perform work on a construction project funded (in whole or in part) by the federal government with a proposed contract value of \$10,000 or more.
- A subcontractor selected to perform work on a construction project funded or assisted by the City of New York with a proposed contract value of \$750,000 or more.
- A subcontractor selected to perform work on a construction project funded or assisted by the City of New York with a proposed contract value of less than \$750,000 must submit a "Less than \$750,000" certificate.

WHERE TO FILE

Employment Reports must be filed with the City agency awarding the contract. If you are a contractor or subcontractor who will be working for a private developer in receipt of funding or assistance from the City, the ER must be filed with the City agency with jurisdiction over the developer's project.

DLS REVIEW PROCESS

In accordance with Executive Order 50 (EO 50), upon receipt by DLS of a completed ER, DLS conducts a review of the contractor's current employment policies, practices and procedures, as well as perform a statistical analysis of the contractor's workforce, if necessary. The process is as follows:

1. Within five (5) business days, DLS will review the ER for completeness and accuracy. If any information is omitted or incorrect, or if necessary documents are not submitted, the submission shall be deemed incomplete and DLS will inform the contractor. The substantive compliance review does not commence until the submission is complete. **An incomplete submission will delay the review process and may preclude or interrupt the contract approval.**
2. If the ER submission is complete, the compliance review will proceed, resulting in one of the following:

Certificate of Approval

The contractor is found to be in compliance with all applicable laws and regulations. The approval is valid for 36 months.

Continued Approval Certificate

The contractor has been issued a Certificate of Approval in the previous 36 months which is good for the applicable contract.

Conditional Certificate of Compliance

The contractor is required to take corrective actions in order to be in compliance with EO 50. The contractor must meet the conditions within one month of the issue of the Conditional Certificate.

Determination of Nonperformance

The contractor has failed to take the required corrective actions stipulated in the Conditional Certificate. A determination of nonperformance may prevent a contractor from receiving an award of a contract.

HOW TO COMPLETE THE EMPLOYMENT REPORT

Contents

General Information

Part I: Contractor/Subcontractor Information

Part II: Employment Policies and Practices

Part III: Contract Bid Information and Projected and Current Workforce Forms

Signature Page

PART I: CONTRACTOR/SUBCONTRACTOR INFORMATION

Questions 7 – 11: Please provide the required contact information for your company. All contracts must have a designated Equal Employment Officer.

Question 12: If you are a subcontractor, you must state the name of the contractor for whom you are providing the construction services.

Question 13: Please provide the number of permanent employees in your company.

Question 14a-g: The Project Identification Number (PIN) and the Contract Registration ID Number (CT#) can be obtained from the City agency. Provide a description of the trade work you will perform on this project and the address where the work will be performed. Subcontractors can obtain this information from the contract they have with the prime contractor.

Questions 15 – 18: If your company has received a valid Certificate of Approval within the past 36 months, been audited by the United States Department of Labor, Office of Federal Contract Compliance Programs (OFCCP), or if your company has submitted an ER for a different contract for which you have not yet received a compliance certificate, then you only need to complete and submit the following:

- General Information section
- Part I - Contractor/Subcontractor Information
- Form B - Projected Workforce
- Signature Page

If your company is currently waiting for an approval on another contract previously submitted, be certain to identify the date on which you submitted the completed Employment Report, the name of the City contracting agency with which the contract was made, and the name and telephone number of the person to whom the Employment Report was submitted.

If your company was issued a Conditional Certificate of Approval, all required corrective actions must have been taken or DLS will not issue a Continued Certificate.

- Question 18: If the company was audited by the OFCCP, also provide the following:
- Identify the reviewing OFCCP office by its name and address
 - If an unconditional certificate of compliance was issued by the OFCCP, attach a copy of the certificate in lieu of completing Parts II and III;
 - Include copies of all corrective actions and documentation of OFCCP's performance; and
 - Provide a copy of all stated OFCCP findings.

Question 19: Please provide a copy of any Collective Bargaining Agreement(s) which is negotiated through an employer trade association on behalf of your organization or any of its affiliates.

PART II: EMPLOYMENT POLICIES AND PRACTICES

Remember to label all documents with the question number for which they are submitted.

Questions 20a – j: You must respond to the questions as to whether or not your firm has documents reflecting written policies, benefits and procedures. If so, then you must identify by name each document in which the policy(ies), procedure(s) and benefit(s) is located and submit copies of all of the document(s). If your firm follows unwritten practices or procedures, include an explanation of how they operate. Please submit the most current document(s), including all applicable amendments. Label each document and/or unwritten practice according to the question to which it corresponds (e.g. 20a, 20b, etc.)

Questions 21a – h: Inquires about the manner/methods by which you comply with the requirements of the Immigration Reform and Control Act of 1986 (IRCA).

Question 22: Inquires into where and how I-9 forms are maintained and stored.

Questions 23a – e: Inquires into whether or not there is a requirement that an applicant or employee be subjected to a medical examination at any given time. Copies of the medical information questionnaire and instructions must be submitted with the Employment Report.

Question 24: Indicate the existence and location of all statements of your firm's Equal Employment Opportunity policy and attach a copy of each statement.

Question 25: Submit any current Affirmative Action Plan(s) created pursuant to Executive Order 11246.

Question 26: If your firm or collective bargaining agreement has an internal grievance procedure, indicate this and submit a copy of the policy and procedure. If unwritten, explain its nature and operation. Explain how your firm's procedure addresses EEO complaints.

Question 27: If your employees have used the procedure in the last three (3) years, please submit an explanation in the format indicated below:

1. Number of complaint(s)	2. Nature of the complaint(s)	3. Position(s) of the complainant(s)	4. Was an investigation conducted? Y/N	5. Current status of the disposition
---------------------------	-------------------------------	--------------------------------------	---	--------------------------------------

Question 28: Indicate whether in the past three (3) years complaints have been filed with a court of law or administrative agency, naming your company as a defendant (or respondent) in a complaint alleging violation of any anti-discrimination or affirmative action laws. If yes, develop and submit a log to show, for each administrative/and or judicial action filed, the following information:

1. Name(s) of complainant(s)	2. Administrative agency or court in which action was filed	3. Nature of the complaint(s)	4. Current status	5. If not pending, the complaint's disposition
------------------------------	---	-------------------------------	-------------------	--

Question 29: Identify each job for which a physical qualification exists. Identify and explain the physical qualification(s) for each stated job. Submit job descriptions for each job and the reasons for the qualifications.

Question 30: Identify each job for which there exists any qualification related to age, race, color, national origin, sex, creed, disability, marital status, sexual orientation or citizenship status. Identify and explain the specific related qualification for each job stated. Submit job descriptions for each job and the reasons for the qualifications.

PART III: CONTRACT BID INFORMATION AND PROJECTED AND CURRENT WORKFORCE FORMS

FORM A: CONTRACT BID INFORMATION – USE OF SUBCONTRACTORS/TRADES

Your projections for the utilization of subcontractors on the proposed contract are to be provided in this section. A chart has been provided for the identification of subcontractors. Information is to be provided to the extent known at the time the ER is filed for review by DLS. If the subcontractor's name is unknown, then write "unknown". Under "ownership", enter the appropriate race/ethnic and gender code. If the contract is federally funded or assisted and the subcontractor is being utilized in accordance with applicable federal requirements with respect to Minority Business Enterprise or Woman Business Enterprise requirements, enter the appropriate code. This will also apply to state funded contracts with similar requirements for minority and female owned businesses.

FORM B: PROJECTED WORKFORCE FOR WORK TO BE PERFORMED ON THIS PROJECT

For each trade to be engaged by your company for this project, enter the projected workforce for Males and Females by trade classification in the charts provided.

FORM C: CURRENT WORKFORCE FOR WORK TO BE PERFORMED ON THIS PROJECT

For each trade *currently* engaged by your company for all work performed in NYC, enter the current workforce for Males and Females by trade classification in the charts provided.

SIGNATURE PAGE

The signatory of this Employment Report and all other documents submitted to DLS must be an official authorized to enter into a binding legal agreement. The signature page must be completed in its entirety and notarized. Only original signatures will be accepted.

The City of New York Department of Small Business Services
Division of Labor Services Contract Compliance Unit
110 William Street, New York, New York 10038
Phone: (212) 513 - 6323
Fax: (212) 618-8879

CONSTRUCTION EMPLOYMENT REPORT

GENERAL INFORMATION

1. Your contractual relationship in this contract is: Prime contractor Subcontractor
- 1a. Are M/WBE goals attached to this project? Yes No
2. Please check one of the following if your firm would like information on how to certify with the City of New York as a:
 Minority Owned Business Enterprise Locally Based Business Enterprise
 Women Owned Business Enterprise Emerging Business Enterprise
 Disadvantaged Business Enterprise
- 2a. If you are certified as an **MBE, WBE, LBE, EBE** or **DBE**, what city/state agency are you certified with? _____ Are you DBE certified? Yes No
3. Please indicate if you would like assistance from SBS in identifying certified M/WBEs for contracting opportunities: Yes No
4. Is this project subject to a project labor agreement? Yes No
5. Are you a Union contractor? Yes No If yes, please list which local(s) you affiliated with _____
6. Are you a Veteran owned company? Yes No

PART I: CONTRACTOR/SUBCONTRACTOR INFORMATION

7. _____
Employer Identification Number or Federal Tax I.D. Email Address
8. _____
Company Name
9. _____
Company Address and Zip Code
10. _____
Chief Operating Officer Telephone Number
11. _____
Designated Equal Opportunity Compliance Officer Telephone Number
(If same as Item #10, write "same")
12. _____
Name of Prime Contractor and Contact Person
(If same as Item #8, write "same")

13. Number of employees in your company: _____

14. Contract information:

(a) _____ (b) _____
Contracting Agency (City Agency) Contract Amount

(c) _____ (d) _____
Procurement Identification Number (PIN) Contract Registration Number (CT#)

(e) _____ (f) _____
Projected Commencement Date Projected Completion Date

(g) Description and location of proposed contract:

15. Has your firm been reviewed by the Division of Labor Services (DLS) within the past 36 months and issued a Certificate of Approval? Yes___ No___

If yes, attach a copy of certificate.

16. Has DLS within the past month reviewed an Employment Report submission for your company and issued a Conditional Certificate of Approval? Yes___ No___

If yes, attach a copy of certificate.

NOTE: DLS WILL NOT ISSUE A CONTINUED CERTIFICATE OF APPROVAL IN CONNECTION WITH THIS CONTRACT UNLESS THE REQUIRED CORRECTIVE ACTIONS IN PRIOR CONDITIONAL CERTIFICATES OF APPROVAL HAVE BEEN TAKEN.

17. Has an Employment Report already been submitted for a different contract (not covered by this Employment Report) for which you have not yet received compliance certificate?
Yes___ No___ If yes,

Date submitted: _____

Agency to which submitted: _____

Name of Agency Person: _____

Contract No: _____

Telephone: _____

18. Has your company in the past 36 months been audited by the United States Department of Labor, Office of Federal Contract Compliance Programs (OFCCP)? Yes___ No___

If yes,

(a) Name and address of OFCCP office.

(b) Was a Certificate of Equal Employment Compliance issued within the past 36 months?
Yes___ No___

If yes, attach a copy of such certificate.

(c) Were any corrective actions required or agreed to? Yes___ No___

If yes, attach a copy of such requirements or agreements.

(d) Were any deficiencies found? Yes___ No___

If yes, attach a copy of such findings.

19. Is your company or its affiliates a member or members of an employers' trade association which is responsible for negotiating collective bargaining agreements (CBA) which affect construction site hiring? Yes___ No___

If yes, attach a list of such associations and all applicable CBA's.

PART II: DOCUMENTS REQUIRED

20. For the following policies or practices, attach the relevant documents (e.g., printed booklets, brochures, manuals, memoranda, etc.). If the policy(ies) are unwritten, attach a full explanation of the practices. See instructions.

- ___ (a) Health benefit coverage/description(s) for all management, nonunion and union employees (whether company or union administered)
- ___ (b) Disability, life, other insurance coverage/description
- ___ (c) Employee Policy/Handbook
- ___ (d) Personnel Policy/Manual
- ___ (e) Supervisor's Policy/Manual
- ___ (f) Pension plan or 401k coverage/description for all management, nonunion and union employees, whether company or union administered
- ___ (g) Collective bargaining agreement(s).
- ___ (h) Employment Application(s)
- ___ (i) Employee evaluation policy/form(s).
- ___ (j) Does your firm have medical and/or non-medical (i.e. education, military, personal, pregnancy, child care) leave policy?

21. To comply with the Immigration Reform and Control Act of 1986 when and of whom does your firm require the completion of an I-9 Form?

- (a) Prior to job offer Yes ___ No ___
- (b) After a conditional job offer Yes ___ No ___
- (c) After a job offer Yes ___ No ___
- (d) Within the first three days on the job Yes ___ No ___
- (e) To some applicants Yes ___ No ___
- (f) To all applicants Yes ___ No ___
- (g) To some employees Yes ___ No ___
- (h) To all employees Yes ___ No ___

22. Explain where and how completed I-9 Forms, with their supportive documentation, are maintained and made accessible.

23. Does your firm or any of its collective bargaining agreements require job applicants to take a medical examination? Yes ___ No ___

If yes, is the medical examination given:

- (a) Prior to a job offer Yes ___ No ___
- (b) After a conditional job offer Yes ___ No ___
- (c) After a job offer Yes ___ No ___
- (d) To all applicants Yes ___ No ___
- (e) Only to some applicants Yes ___ No ___

If yes, list for which applicants below and attach copies of all medical examination or questionnaire forms and instructions utilized for these examinations.

24. Do you have a written equal employment opportunity (EEO) policy? Yes ___ No ___

If yes, list the document(s) and page number(s) where these written policies are located.

25. Does the company have a current affirmative action plan(s) (AAP)

- ___ Minorities and Women
- ___ Individuals with handicaps
- ___ Other. Please specify _____

26. Does your firm or collective bargaining agreement(s) have an internal grievance procedure with respect to EEO complaints? Yes ___ No ___

If yes, please attach a copy of this policy.

If no, attach a report detailing your firm's unwritten procedure for handling EEO complaints.

27. Has any employee, within the past three years, filed a complaint pursuant to an internal grievance procedure or with any official of your firm with respect to equal employment opportunity? Yes___ No___

If yes, attach an internal complaint log. See instructions.

28. Has your firm, within the past three years, been named as a defendant (or respondent) in any administrative or judicial action where the complainant (plaintiff) alleged violation of any anti-discrimination or affirmative action laws? Yes___ No___

If yes, attach a log. See instructions.

29. Are there any jobs for which there are physical qualifications? Yes___ No___

If yes, list the job(s), submit a job description and state the reason(s) for the qualification(s).

30. Are there any jobs for which there are age, race, color, national origin, sex, creed, disability, marital status, sexual orientation, or citizenship qualifications? Yes___ No___

If yes, list the job(s), submit a job description and state the reason(s) for the qualification(s).

SIGNATURE PAGE

I, (print name of authorized official signing) _____ hereby certify that the information submitted herewith is true and complete to the best of my knowledge and belief and submitted with the understanding that compliance with New York City's equal employment requirements, as contained in Chapter 56 of the City Charter, Executive Order No. 50 (1980), as amended, and the implementing Rules and Regulations, is a contractual obligation. I also agree on behalf of the company to submit a certified copy of payroll records to the Division of Labor Services on a monthly basis.

Contractor's Name

Name of person who prepared this Employment Report

Title

Name of official authorized to sign on behalf of the contractor

Title

Telephone Number

Signature of authorized official

Date

If contractors are found to be underutilizing minorities and females in any given trade based on Chapter 56 Section 3H, the Division of Labor Services reserves the right to request the contractor's workforce data and to implement an employment program.

Contractors who fail to comply with the above mentioned requirements or are found to be in noncompliance may be subject to the withholding of final payment.

Willful or fraudulent falsifications of any data or information submitted herewith may result in the termination of the contract between the City and the bidder or contractor and in disapproval of future contracts for a period of up to five years. Further, such falsification may result in civil and/or criminal prosecution.

To the extent permitted by law and consistent with the proper discharge of DLS' responsibilities under Charter Chapter 56 of the City Charter and Executive Order No. 50 (1980) and the implementing Rules and Regulations, all information provided by a contractor to DLS shall be confidential.

Only original signatures accepted.

Sworn to before me this _____ day of _____ 20 _____

Notary Public

Authorized Signature

Date

FORM A. CONTRACT BID INFORMATION: USE OF SUBCONTRACTORS/TRADES

1. Do you plan to subcontractor work on this contract? Yes ___ No ___
2. If yes, complete the chart below.

NOTE: All proposed subcontractors with a subcontract in excess of \$750,000 must complete an Employment Report for review and approval before the contract may be awarded and work commences.

SUBCONTRACTOR'S NAME*	OWNERSHIP (ENTER APPROPRIATE CODE LETTERS BELOW)	WORK TO BE PERFORMED BY SUBCONTRACTOR	TRADE PROJECTED FOR USE BY SUBCONTRACTOR	PROJECTED DOLLAR VALUE OF SUBCONTRACT

***If subcontractor is presently unknown, please enter the trade (craft name).**

OWNERSHIP CODES

- W: White
- B: Black
- H: Hispanic
- A: Asian
- N: Native American
- F: Female

FORM B: PROJECTED WORKFORCE

TRADE CLASSIFICATION CODES

- (J) Journeylevel Workers
- (A) Apprentice
- (H) Helper
- (TRN) Trainee
- (TOT) Total by Column

For each trade to be engaged by your company for this project, enter the projected workforce for Males and Females by trade classification on the charts below.

Trade:	MALES					FEMALES				
	(1)	(2)	(3)	(4)	(5)	(6)	(7)	(8)	(9)	(10)
	White Non Hisp.	Black Non Hisp.	Hisp.	Asian	Native Amer.	White Non Hisp.	Black Non Hisp.	Hisp.	Asian	Native Amer.
J										
H										
A										
TRN										
TOT										

Total (Col. #1-10):

Total Minority, Male & Female
(Col. #2,3,4,5,7,8,9, & 10):

Total Female
(Col. #6 - 10):

What are the recruitment sources for you projected hires (i.e., unions, government employment office, job tap center, community outreach)?

FORM B. PROJECTED WORKFORCE

Trade: _____

Union Affiliation, if applicable _____

Total (Col. #1-10): _____

Total Minority, Male & Female
(Col. #2,3,4,5,7,8,9, & 10): _____

Total Female
(Col. #6 - 10): _____

MALES

(1) White Non Hisp.	(2) Black Non Hisp.	(3) Hisp.	(4) Asian	(5) Native Amer.

J
H
A
TRN
TOT

FEMALES

(6) White Non Hisp.	(7) Black Non Hisp.	(8) Hisp.	(9) Asian	(10) Native Amer.

What are the recruitment sources for you projected hires (i.e., unions, government employment office, job tap center, community outreach)?

FORM C: CURRENT WORKFORCE

TRADE CLASSIFICATION CODES

- (J) Journeylevel Workers
- (H) Helper
- (TOT) Total by Column
- (A) Apprentice
- (TRN) Trainee

For each trade currently engaged by your company for all work performed in New York City, enter the current workforce for Males and Females by trade classification on the charts below.

Trade:	MALES						FEMALES													
	(1)		(2)		(3)		(4)		(5)		(6)		(7)		(8)		(9)		(10)	
	White Non Hisp.	Black Non Hisp.	White Non Hisp.	Black Non Hisp.	Hisp.	Asian	Native Amer.	White Non Hisp.	Black Non Hisp.	Hisp.	Asian	Native Amer.	White Non Hisp.	Black Non Hisp.	Hisp.	Asian	Native Amer.			
J																				
H																				
A																				
TRN																				
TOT																				

Total (Col. #1-10):

Total Minority, Male & Female
(Col. #2,3,4,5,7,8,9, & 10):

Total Female
(Col. #6 - 10):

What are the recruitment sources for you projected hires (i.e., unions, government employment office, job tap center, community outreach)?

FORM C: CURRENT WORKFORCE

Trade: _____

Union Affiliation, if applicable

Total (Col. #1-10): _____

Total Minority, Male & Female
(Col. #2,3,4,5,7,8,9, & 10): _____

Total Female
(Col. #6 -- 10): _____

MALES

(1) White Non Hisp.	(2) Black Non Hisp.	(3) Hisp.	(4) Asian	(5) Native Amer.

J
H
A
TRN
TOT

FEMALES

(6) White Non Hisp.	(7) Black Non Hisp.	(8) Hisp.	(9) Asian	(10) Native Amer.

What are the recruitment sources for you projected hires (i.e., unions, government employment office, job tap center, community outreach)?

(NO TEXT ON THIS PAGE)



The City of New York Department of Small Business Services
Division of Labor Services Contract Compliance Unit
110 William Street, New York, New York 10038
Phone: (212) 513 - 6323
Fax: (212) 618-8879

CONSTRUCTION EMPLOYMENT REPORT

GENERAL INFORMATION

1. Your contractual relationship in this contract is: Prime contractor ___ Subcontractor x
- 1a. Are MWBE goals attached to this project? Yes ___ No ___
2. Please check one of the following if your firm would like information on how to certify with the City of New York as a:

<input type="checkbox"/> Minority Owned Business Enterprise	<input type="checkbox"/> Locally Based Business Enterprise
<input type="checkbox"/> Women Owned Business Enterprise	<input type="checkbox"/> Emerging Business Enterprise
<input type="checkbox"/> Disadvantaged Business Enterprise	
- 2a. If you are certified as an **MBE, WBE, LBE, EBE** or **DBE**, what city/state agency are you certified with? _____ Are you DBE certified? Yes ___ No ___
3. Please indicate if you would like assistance from SBS in identifying certified M/WBEs for contracting opportunities: Yes ___ No ___
4. Is this project subject to a project labor agreement? Yes ___ No ___
5. Are you a Union contractor? Yes ___ No ___ If yes, please list which local(s) you affiliated with _____
6. Are you a Veteran owned company? Yes ___ No ___

PART I: CONTRACTOR/SUBCONTRACTOR INFORMATION

7. _____
Employer Identification Number or Federal Tax I.D. Email Address
8. _____
Company Name
9. _____
Company Address and Zip Code
10. _____
Chief Operating Officer Telephone Number
11. _____
Designated Equal Opportunity Compliance Officer Telephone Number
(If same as Item #10, write "same")
12. _____
Name of Prime Contractor and Contact Person
(If same as Item #8, write "same")

13. Number of employees in your company: _____

14. Contract information:

(a) _____ (b) _____
Contracting Agency (City Agency) Contract Amount

(c) _____ (d) _____
Procurement Identification Number (PIN) Contract Registration Number (CT#)

(e) _____ (f) _____
Projected Commencement Date Projected Completion Date

(g) Description and location of proposed contract:

15. Has your firm been reviewed by the Division of Labor Services (DLS) within the past 36 months and issued a Certificate of Approval? Yes___ No___

If yes, attach a copy of certificate.

16. Has DLS within the past month reviewed an Employment Report submission for your company and issued a Conditional Certificate of Approval? Yes___ No___

If yes, attach a copy of certificate.

NOTE: DLS WILL NOT ISSUE A CONTINUED CERTIFICATE OF APPROVAL IN CONNECTION WITH THIS CONTRACT UNLESS THE REQUIRED CORRECTIVE ACTIONS IN PRIOR CONDITIONAL CERTIFICATES OF APPROVAL HAVE BEEN TAKEN.

17. Has an Employment Report already been submitted for a different contract (not covered by this Employment Report) for which you have not yet received compliance certificate?
Yes___ No___ If yes,

Date submitted: _____

Agency to which submitted: _____

Name of Agency Person: _____

Contract No: _____

Telephone: _____

18. Has your company in the past 36 months been audited by the United States Department of Labor, Office of Federal Contract Compliance Programs (OFCCP)? Yes___ No___

If yes,

(a) Name and address of OFCCP office.

(b) Was a Certificate of Equal Employment Compliance issued within the past 36 months?
Yes___ No___

If yes, attach a copy of such certificate.

(c) Were any corrective actions required or agreed to? Yes___ No___

If yes, attach a copy of such requirements or agreements.

(d) Were any deficiencies found? Yes___ No___

If yes, attach a copy of such findings.

19. Is your company or its affiliates a member or members of an employers' trade association which is responsible for negotiating collective bargaining agreements (CBA) which affect construction site hiring? Yes___ No___

If yes, attach a list of such associations and all applicable CBA's.

PART II: DOCUMENTS REQUIRED

20. For the following policies or practices, attach the relevant documents (e.g., printed booklets, brochures, manuals, memoranda, etc.). If the policy(ies) are unwritten, attach a full explanation of the practices. See instructions.

- ___ (a) Health benefit coverage/description(s) for all management, nonunion and union employees (whether company or union administered)
- ___ (b) Disability, life, other insurance coverage/description
- ___ (c) Employee Policy/Handbook
- ___ (d) Personnel Policy/Manual
- ___ (e) Supervisor's Policy/Manual
- ___ (f) Pension plan or 401k coverage/description for all management, nonunion and union employees, whether company or union administered
- ___ (g) Collective bargaining agreement(s).
- ___ (h) Employment Application(s)
- ___ (i) Employee evaluation policy/form(s).
- ___ (j) Does your firm have medical and/or non-medical (i.e. education, military, personal, pregnancy, child care) leave policy?

21. To comply with the Immigration Reform and Control Act of 1986 when and of whom does your firm require the completion of an I-9 Form?

- | | |
|--|----------------|
| (a) Prior to job offer | Yes ___ No ___ |
| (b) After a conditional job offer | Yes ___ No ___ |
| (c) After a job offer | Yes ___ No ___ |
| (d) Within the first three days on the job | Yes ___ No ___ |
| (e) To some applicants | Yes ___ No ___ |
| (f) To all applicants | Yes ___ No ___ |
| (g) To some employees | Yes ___ No ___ |
| (h) To all employees | Yes ___ No ___ |

22. Explain where and how completed I-9 Forms, with their supportive documentation, are maintained and made accessible.

23. Does your firm or any of its collective bargaining agreements require job applicants to take a medical examination? Yes ___ No ___

If yes, is the medical examination given:

- | | |
|-----------------------------------|----------------|
| (a) Prior to a job offer | Yes ___ No ___ |
| (b) After a conditional job offer | Yes ___ No ___ |
| (c) After a job offer | Yes ___ No ___ |
| (d) To all applicants | Yes ___ No ___ |
| (e) Only to some applicants | Yes ___ No ___ |

If yes, list for which applicants below and attach copies of all medical examination or questionnaire forms and instructions utilized for these examinations.

24. Do you have a written equal employment opportunity (EEO) policy? Yes ___ No ___

If yes, list the document(s) and page number(s) where these written policies are located.

25. Does the company have a current affirmative action plan(s) (AAP)

- ____ Minorities and Women
- ____ Individuals with handicaps
- ____ Other. Please specify _____

26. Does your firm or collective bargaining agreement(s) have an internal grievance procedure with respect to EEO complaints? Yes ___ No ___

If yes, please attach a copy of this policy.

If no, attach a report detailing your firm's unwritten procedure for handling EEO complaints.

27. Has any employee, within the past three years, filed a complaint pursuant to an internal grievance procedure or with any official of your firm with respect to equal employment opportunity? Yes___ No___

If yes, attach an internal complaint log. See instructions.

28. Has your firm, within the past three years, been named as a defendant (or respondent) in any administrative or judicial action where the complainant (plaintiff) alleged violation of any anti-discrimination or affirmative action laws? Yes___ No___

If yes, attach a log. See instructions.

29. Are there any jobs for which there are physical qualifications? Yes___ No___

If yes, list the job(s), submit a job description and state the reason(s) for the qualification(s).

30. Are there any jobs for which there are age, race, color, national origin, sex, creed, disability, marital status, sexual orientation, or citizenship qualifications? Yes___ No___

If yes, list the job(s), submit a job description and state the reason(s) for the qualification(s).

SIGNATURE PAGE

I, (print name of authorized official signing) _____ hereby certify that the information submitted herewith is true and complete to the best of my knowledge and belief and submitted with the understanding that compliance with New York City's equal employment requirements, as contained in Chapter 56 of the City Charter, Executive Order No. 50 (1980), as amended, and the implementing Rules and Regulations, is a contractual obligation. I also agree on behalf of the company to submit a certified copy of payroll records to the Division of Labor Services on a monthly basis.

Contractor's Name

Name of person who prepared this Employment Report

Title

Name of official authorized to sign on behalf of the contractor

Title

Telephone Number

Signature of authorized official

Date

If contractors are found to be underutilizing minorities and females in any given trade based on Chapter 56 Section 3H, the Division of Labor Services reserves the right to request the contractor's workforce data and to implement an employment program.

Contractors who fail to comply with the above mentioned requirements or are found to be in noncompliance may be subject to the withholding of final payment.

Willful or fraudulent falsifications of any data or information submitted herewith may result in the termination of the contract between the City and the bidder or contractor and in disapproval of future contracts for a period of up to five years. Further, such falsification may result in civil and/or criminal prosecution.

To the extent permitted by law and consistent with the proper discharge of DLS' responsibilities under Charter Chapter 56 of the City Charter and Executive Order No. 50 (1980) and the implementing Rules and Regulations, all information provided by a contractor to DLS shall be confidential.

Only original signatures accepted.

Sworn to before me this _____ day of _____ 20 _____

Notary Public

Authorized Signature

Date

FORM A CONTRACT BID INFORMATION: USE OF SUBCONTRACTORS/TRADES

1. Do you plan to subcontractor work on this contract? Yes ___ No ___
2. If yes, complete the chart below.

NOTE: All proposed subcontractors with a subcontract in excess of \$750,000 must complete an Employment Report for review and approval before the contract may be awarded and work commences.

SUBCONTRACTOR'S NAME*	OWNERSHIP (ENTER APPROPRIATE CODE LETTERS BELOW)	WORK TO BE PERFORMED BY SUBCONTRACTOR	TRADE PROJECTED FOR USE BY SUBCONTRACTOR	PROJECTED DOLLAR VALUE OF SUBCONTRACT

***If subcontractor is presently unknown, please enter the trade (craft name).**

OWNERSHIP CODES

- W: White
- B: Black
- H: Hispanic
- A: Asian
- N: Native American
- F: Female

FORM B: PROJECTED WORKFORCE

TRADE CLASSIFICATION CODES

- (J) Journeylevel Workers
- (H) Helper
- (A) Apprentice
- (TRN) Trainee
- (TOT) Total by Column

For each trade to be engaged by your company for this project, enter the projected workforce for Males and Females by trade classification on the charts below.

Trade:	MALES						FEMALES			
	(1) White Non Hisp.	(2) Black Non Hisp.	(3) Hisp.	(4) Asian	(5) Native Amer.	(6) White Non Hisp.	(7) Black Non Hisp.	(8) Hisp.	(9) Asian	(10) Native Amer.
J										
H										
A										
TRN										
TOT										

Total (Col. #1-10):

Total Minority, Male & Female
(Col. #2,3,4,5,7,8,9, & 10):

Total Female
(Col. #6 - 10):

What are the recruitment sources for you projected hires (i.e., unions, government employment office, job tap center, community outreach)?

FORM B: PROJECTED WORKFORCE

Trade: _____

Union Affiliation, if applicable _____

Total (Col. #1-10): _____

Total Minority, Male & Female
(Col. #2,3,4,5,7,8,9, & 10): _____

Total Female
(Col. #6 - 10): _____

MALES

(1) White Non Hisp.	(2) Black Non Hisp.	(3) Hisp.	(4) Asian	(5) Native Amer.

J
H
A
TRN
TOT

FEMALES

(6) White Non Hisp.	(7) Black Non Hisp.	(8) Hisp.	(9) Asian	(10) Native Amer.

What are the recruitment sources for you projected hires (i.e., unions, government employment office, job tap center, community outreach)?

FORM C: CURRENT WORKFORCE

TRADE CLASSIFICATION CODES

- (J) Journeylevel Workers
- (H) Helper
- (TOT) Total by Column
- (A) Apprentice
- (TRN) Trainee

For each trade currently engaged by your company for all work performed in New York City, enter the current workforce for Males and Females by trade classification on the charts below.

Trade:	MALES					FEMALES								
	(1)		(2)		(3)	(4)		(5)	(6)		(7)	(8)	(9)	(10)
	White Non Hisp.	Black Non Hisp.	White Non Hisp.	Black Non Hisp.	Hisp.	Asian	Native Amer.	White Non Hisp.	Black Non Hisp.	White Non Hisp.	Black Non Hisp.	Hisp.	Asian	Native Amer.
J														
H														
A														
TRN														
TOT														

Total (Col. #1-10): _____

Total Minority, Male & Female
(Col. #2,3,4,5,7,8,9, & 10): _____

Total Female
(Col. #6 - 10): _____

What are the recruitment sources for you projected hires (i.e., unions, government employment office, job tap center, community outreach)?

FORM C: CURRENT WORKFORCE

Trade: _____

Union Affiliation, if applicable _____

Total (Col. #1-10): _____

Total Minority, Male & Female
(Col. #2,3,4,5,7,8,9, & 10): _____

Total Female
(Col. #6 - 10): _____

MALES

(1) White Non Hisp.	(2) Black Non Hisp.	(3) Hisp.	(4) Asian	(5) Native Amer.
J				
H				
A				
TRN				
TOT				

FEMALES

(6) White Non Hisp.	(7) Black Non Hisp.	(8) Hisp.	(9) Asian	(10) Native Amer.
J				
H				
A				
TRN				
TOT				

What are the recruitment sources for you projected hires (i.e., unions, government employment office, job tap center, community outreach)?

(NO TEXT ON THIS PAGE)



The City of New York Department of Small Business Services
Division of Labor Services Contract Compliance Unit
110 William Street, New York, New York 10038
Phone: (212) 513 - 6323 Fax: (212) 618-8879

Date _____

File Number _____

**LESS THAN \$750,000 SUBCONTRACT CERTIFICATE
(CITY, STATE AND ICIP ONLY)**

Are you currently certified as one of the following? Please check yes or no:

MBE Yes ___ No ___ WBE Yes ___ No ___ LBE Yes ___ No ___

DBE Yes ___ No ___ EBE Yes ___ No ___

If you are certified as an MBE, WBE, LBE, EBE or DBE, what city/state agency are you certified with?

Please check one of the following if your firm would like information on how to certify with the City of New York as a:

___ Minority Owned Business Enterprise ___ Locally based Business Enterprise

___ Women Owned Business Enterprise ___ Emerging Business Enterprise

___ Disadvantaged Business Enterprise

Company Name Employer Identification Number or Federal Tax I.D

Company Address and Zip Code

Contact Person (First Name, Last Name) Telephone Number

Fax Number E-mail Address

Description and location of proposed subcontract: _____

Are you a Union contractor? Yes ___ No ___ If yes, please list which local(s) you affiliated with

Are you a Veteran owned company? Yes ___ No ___

Procurement Identification Number (PIN)
(City contracts only)

Contract Registration Number (CT#)
(City contracts only)

Block and Lot Number
(ICIP projects only)

Contract Amount

I, (print name of authorized official signing) _____ hereby certify that I am authorized by the above-named subcontractor to certify that said subcontractor's proposed contract with the above named owner or City agency is less than \$750,000. This affirmation is made in accordance with NYC Charter Chapter 56, Executive Order No. 50 (1980) and the implementing Rules.

Willful or fraudulent falsifications of any data or information submitted herewith may result in the termination of the contract between the City and the bidder or contractor and in disapproval of future contracts for a period of up to five years. Further, such falsification may result in civil and/or criminal prosecution.

Signature of authorized official _____ Date _____

Only original signatures accepted.

Sworn to before me this _____ day of _____ 20____

Notary Public	Authorized Signature	Date
---------------	----------------------	------





**Department of
Design and
Construction**

**INFRASTRUCTURE DIVISION
BUREAU OF DESIGN**

VOLUME 1 OF 3

PROJECT ID:HWQ121B4

RECONSTRUCTION OF LAKEVIEW BOULEVARD EAST

LAKEVIEW LANE - FROM BAISLEY BOULEVARD TO 122ND AVENUE
122ND AVENUE - FROM LAKEVIEW LANE TO LAKEVIEW BOULEVARD EAST
LAKEVIEW BOULEVARD EAST - FROM 122ND AVENUE TO 118TH AVENUE
118TH AVENUE - FROM LAKEVIEW BOULEVARD EAST TO LONG STREET

NEW STORM AND SANITARY SEWERS (SEQ200436) IN:

LAKEVIEW LANE - FROM BAISLEY BOULEVARD TO 122ND AVENUE
122ND AVENUE - FROM LAKEVIEW LANE TO LAKEVIEW BOULEVARD EAST
LAKEVIEW BOULEVARD EAST - FROM 122ND AVENUE TO 118TH AVENUE
119TH AVENUE - FROM LONG STREET TO 164TH STREET
164TH STREET - FROM 119TH AVENUE TO 120TH AVENUE

CAPITAL PROJECT WM-1

WATER MAIN WORK IN:

LAKEVIEW LANE - FROM BAISLEY BOULEVARD TO 122ND AVENUE
122ND AVENUE - FROM LAKEVIEW LANE TO LAKEVIEW BOULEVARD EAST
LAKEVIEW BOULEVARD EAST - FROM 122ND AVENUE TO 118TH AVENUE
118TH AVENUE - FROM LAKEVIEW BOULEVARD EAST TO LONG STREET
119TH AVENUE - FROM LONG STREET TO 164TH STREET
164TH STREET - FROM 119TH AVENUE TO 120TH AVENUE

INCLUDING STREET LIGHTING AND TRAFFIC WORK

Together With All Work Incidental Thereto

BOROUGH OF QUEENS

CITY OF NEW YORK

Contractor.

Dated _____, 20____



**Department of
Design and
Construction**

**THE CITY OF NEW YORK
DEPARTMENT OF DESIGN AND CONSTRUCTION
DIVISION OF INFRASTRUCTURE**

30-30 THOMSON AVENUE
LONG ISLAND CITY, NEW YORK 11101-3045
TELEPHONE (718) 391-1000
WEBSITE www.nyc.gov/buildnyc

VOLUME 2 OF 3

**INFORMATION FOR BIDDERS
CONTRACT
PERFORMANCE AND PAYMENT BONDS
PREVAILING WAGE SCHEDULE**

FOR FURNISHING ALL LABOR AND MATERIALS NECESSARY AND REQUIRED FOR:

PROJECT ID: HWQ121B4

RECONSTRUCTION OF LAKEVIEW BOULEVARD EAST

**LAKEVIEW LANE - FROM BAISLEY BOULEVARD TO 122ND AVENUE
122ND AVENUE - FROM LAKEVIEW LANE TO LAKEVIEW BOULEVARD EAST
LAKEVIEW BOULEVARD EAST - FROM 122ND AVENUE TO 118TH AVENUE
118TH AVENUE - FROM LAKEVIEW BOULEVARD EAST TO LONG STREET**

NEW STORM AND SANITARY SEWERS (SEQ200436) IN:

**LAKEVIEW LANE - FROM BAISLEY BOULEVARD TO 122ND AVENUE
122ND AVENUE - FROM LAKEVIEW LANE TO LAKEVIEW BOULEVARD EAST
LAKEVIEW BOULEVARD EAST - FROM 122ND AVENUE TO 118TH AVENUE
119TH AVENUE - FROM LONG STREET TO 164TH STREET
164TH STREET - FROM 119TH AVENUE TO 120TH AVENUE**

**CAPITAL PROJECT WM-1
WATER MAIN WORK IN:**

**LAKEVIEW LANE - FROM BAISLEY BOULEVARD TO 122ND AVENUE
122ND AVENUE - FROM LAKEVIEW LANE TO LAKEVIEW BOULEVARD EAST
LAKEVIEW BOULEVARD EAST - FROM 122ND AVENUE TO 118TH AVENUE
118TH AVENUE - FROM LAKEVIEW BOULEVARD EAST TO LONG STREET
119TH AVENUE - FROM LONG STREET TO 164TH STREET
164TH STREET - FROM 119TH AVENUE TO 120TH AVENUE**

INCLUDING STREET LIGHTING AND TRAFFIC WORK

Together With All Work Incidental Thereto

**BOROUGH OF QUEENS
CITY OF NEW YORK**

**FOR THE DEPARTMENT OF TRANSPORTATION
PREPARED BY**

AKRF Engineering P.C., & HAZEN AND SAWYER

January 30, 2015



5-148





**THE CITY OF NEW YORK
DEPARTMENT OF DESIGN AND CONSTRUCTION
DIVISION OF INFRASTRUCTURE**

30-30 THOMSON AVENUE
LONG ISLAND CITY, NEW YORK 11101-3045
TELEPHONE (718) 391-1000
WEBSITE www.nyc.gov/buildnyc

VOLUME 2 OF 3

**INFORMATION FOR BIDDERS
CONTRACT
PERFORMANCE AND PAYMENT BONDS
PREVAILING WAGE SCHEDULE**

FOR FURNISHING ALL LABOR AND MATERIALS NECESSARY AND REQUIRED
FOR:

FOR THE DEPARTMENT OF TRANSPORTATION
PREPARED BY
IN-HOUSE DESIGN

DECEMBER 24, 2013





NOTICE TO BIDDERS

Please be advised that the City of New York has issued a new Standard Construction Contract. The new Contract, which is incorporated in this bid, is significantly different from the 2008 version previously used by the City. A listing of some of the significant changes is provided below. This notice is only a partial listing. Please refer to the Contract itself for a full understanding of the changes and the actual text of the changes that were made. The text of the revised Standard Construction Contract is the controlling document should there be any discrepancies between this notice and the Standard Construction Contract.

Significant changes include the following:

ARTICLE 11 DAMAGES CAUSED BY DELAYS

In 2008, the City embarked on a pilot project to test the use of new construction contract language altering the allocation of the risk of project delays, as between the City and the contractor. The City has determined to make the pilot project language the standard language for all City construction contracts. Accordingly, there is now one Standard City Construction Contract that it to be used by all agencies for all bids released after the release of the new contract. The damages for delay language is Article 11. Please note that changes have been made to the damages for delay provisions from the pilot to the adopted version.

ARTICLE 22 INSURANCE

Changes have been made to the insurance provisions, including incorporating requirements that the insurance provided comply with recent NYC Department of Buildings regulations specifying required dollar limits for CGL insurance for certain projects and requiring proof of builder's risk insurance prior to Work commencing rather than within 10 days of award.

ARTICLE 26 EXTRA WORK

The percentage paid for overhead for Extra Work pursuant to Section 26.1.11 is increased from 10% to 12% and the calculation of Worker's Compensation insurance costs reimbursed for Extra Work has been clarified.

ARTICLE 37 LABOR LAW REQUIREMENTS
ARTICLE 38 PAYROLL REPORTS

The provisions governing Labor Law provisions have been tightened, including requirements the employee identification cards include a photo (unless the requirement is waived), a prohibition on cash payments to employees and subcontractors, and clear enforcement authority requirements.

ARTICLE 70 ELECTRONIC FILING

A provision is added to make mandatory the electronic filing of certain alteration permits with the Department of Buildings.

Other significant changes include the following:

ARTICLE 7 INDEMNIFICATION

Changes have been made to the indemnification provisions.

ARTICLE 14 FINAL ACCEPTANCE OF WORK
ARTICLE 44 SUBSTANTIAL COMPLETION PAYMENT

The Commissioner is no longer required to issue a substantial completion determination in addition to the already existing requirement that the Engineer issue a substantial completion determination and reach an agreement on a punch list of remaining work. Now, the Engineer, when issuing the punch list to the Contractor, must also include a proposed schedule for the completion of the punch list. The Contractor may propose an alternative schedule that is subject to the approval of the Engineer. If the Contractor fails to respond to the Engineer's proposed schedule, the Engineer's schedule is deemed accepted.

ARTICLE 15 LIQUIDATED DAMAGES

The contract is revised to match Schedule A to provide that liquidated damages are available only until substantial completion.

ARTICLE 17 SUBCONTRACTS

The requirements for prior approval of subcontractors, and for contractors to be responsible for the actions of their subcontractors, have been tightened. The requirement that the Contractor list subcontractors in the City's Payee Information Portal has been added; the provision was previously attached as a rider.

ARTICLE 19 SECURITY DEPOSIT

The provisions governing the return of bid deposits are clarified.

ARTICLE 20 PAYMENT GUARANTEE

The Payment Guaranty provisions, which apply when the City does not require the Contractor to obtain payment bonds, has been significantly revised to track the requirements of State Finance law 137.

ARTICLE 28 RECORDKEEPING FOR EXTRA OR DISPUTED WORK

The recordkeeping requirement that currently apply to payments for Time & Materials for extra work are expressly made applicable to regular work that is paid for on a T & M basis.

ARTICLE 35 EMPLOYEES

The whistleblower provisions of local law are added to the construction contract. They previously have been attached as a rider.

ARTICLE 38 PAYROLL REPORTS
ARTICLE 77 RECORDS RETENTION

Requirements that records be maintained for six years and directions on how such records must be made available.

ARTICLE 42 PARTIAL PAYMENTS

Increased flexibility has been provided for when contractors may submit invoices.

ARTICLE 62 TAX EXEMPTION

The provisions identifying the State tax exemption for municipalities are revised to more clearly describe State law.

(NO TEXT ON THIS PAGE)

CITY OF NEW YORK

**DEPARTMENT OF
DESIGN AND CONSTRUCTION
DIVISION OF INFRASTRUCTURES**

INFORMATION FOR BIDDERS

SEPTEMBER 2008

(NO TEXT ON THIS PAGE)

*CITY OF NEW YORK CITY
DEPARTMENT OF DESIGN AND CONSTRUCTION
INFORMATION FOR BIDDERS*

TABLE OF CONTENTS

SECTION 1.	DESCRIPTION AND LOCATION OF WORK	1
SECTION 2.	TIME AND PLACE FOR RECEIPT OF BIDS	1
SECTION 3.	DEFINITIONS	1
SECTION 4.	INVITATION FOR BIDS AND CONTRACT DOCUMENTS	1
SECTION 5.	PRE-BID CONFERENCE	2
SECTION 6.	AGENCY CONTACT	2
SECTION 7.	BIDDER'S OATH	2
SECTION 8.	EXAMINATION AND VIEWING OF SITE, CONSIDERATION OF OTHER SOURCES OF INFORMATION AND CHANGED CONDITIONS	2
SECTION 9.	EXAMINATION OF PROPOSED CONTRACT	3
SECTION 10.	FORM OF BID	3
SECTION 11.	IRREVOCABILITY OF BID	3
SECTION 12.	ACKNOWLEDGMENT OF AMENDMENTS	4
SECTION 13.	BID SAMPLES AND DESCRIPTIVE LITERATURE	4
SECTION 14.	PROPRIETARY INFORMATION/TRADE SECRETS	4
SECTION 15.	PRE-OPENING MODIFICATION OR WITHDRAWAL OF BIDS	4
SECTION 16.	BID EVALUATION AND AWARD	4
SECTION 17.	LATE BIDS, LATE WITHDRAWALS AND LATE MODIFICATIONS	5
SECTION 18.	WITHDRAWAL OF BIDS.	5
SECTION 19.	MISTAKE IN BIDS	5
SECTION 20.	LOW TIE BIDS	6
SECTION 21.	REJECTION OF BIDS	6
SECTION 22.	RIGHT TO APPEAL DETERMINATIONS OF NON-RESPONSIVENESS OR NON-RESPONSIBILITY AND RIGHT TO PROTEST SOLICITATIONS AND AWARD	7
SECTION 23.	AFFIRMATIVE ACTION AND EQUAL EMPLOYMENT OPPORTUNITY	7
SECTION 24.	VENDEX QUESTIONNAIRES	7
SECTION 25.	COMPLAINTS ABOUT THE BID PROCESS	8
SECTION 26.	BID, PERFORMANCE AND PAYMENT SECURITY	8
SECTION 27.	FAILURE TO EXECUTE CONTRACT	9
SECTION 28.	BIDDER RESPONSIBILITIES AND QUALIFICATIONS	9
SECTION 29.	EMPLOYMENT REPORT	10
SECTION 30.	LABOR LAW REQUIREMENTS	10
SECTION 31.	INSURANCE	10
SECTION 32.	LUMP SUM CONTRACTS	11
SECTION 33.	UNIT PRICE CONTRACTS	11
SECTION 34.	EXCISE TAX	11
SECTION 35.	LICENSES AND PERMITS	11
SECTION 36.	MULTIPLE PRIME CONTRACTORS	11
SECTION 37.	LOCALLY BASED ENTERPRISE REQUIREMENTS (LBE)	12
SECTION 38.	BID SUBMISSION REQUIREMENTS	13
SECTION 39.	COMPTROLLER'S CERTIFICATE	14
SECTION 40.	PROCUREMENT POLICY BOARD RULES	14
SECTION 41.	DDC SAFETY REQUIREMENTS	14

(NO TEXT ON THIS PAGE)

INFORMATION FOR BIDDERS

1. Description and Location of Work

The description and location of the work for which bids are requested are specified in Attachment 1, "Bid Information". Attachment 1 is included as page A-1 of the Bid Booklet.

2. Time and Place for Receipt of Bids

Sealed bids shall be received on or before the date and hour specified in Attachment 1, at which time they will be publicly opened and read aloud in the presence of the Commissioner or his or her representative, and any bidders who may desire to be present.

3. Definitions

The definitions set forth in the Procurement Policy Board Rules shall apply to this Invitation For Bids.

4. Invitation For Bids and Contract Documents

(A) Except for titles, sub-titles, headings, running headlines, tables of contents and indices (all of which are printed herein merely for convenience) the following, except for such portions thereof as may be specifically excluded, shall be deemed to be part of the Contract and the Invitation for Bids.

- (1) All provisions required by law to be inserted in this Contract, whether actually inserted or not
- (2) The Contract Drawings and Specifications
- (3) The General Conditions, the General Requirements and the Special Conditions, if any
- (4) The Contract
- (5) The Information for Bidders; Request for Proposals; Notice of Solicitation and Proposal For Bids; Bid or Proposal, and, if used, the Bid Booklet
- (6) The Budget Director's Certificate; all Addenda issued prior to the receipt of the bids; the Notice of Award; Performance and Payment Bonds, if required; and the Notice to Proceed with the Work.

(B) For particulars as to this procurement, including quantity and quality of the purchase, extent of the work or labor to be performed, delivery and performance schedule, and any other special instructions, prospective bidders are referred to the Invitation For Bids Documents. A copy of such documents can be obtained at the location set forth in Attachment 1.

(C) Deposit for Copy of Invitation For Bids Documents: Prospective bidders may obtain a copy of the Invitation For Bids Documents by complying with the conditions set forth in the Notice of Solicitation. The deposit must be in the form of a check or money order made payable to the City of New York, and drawn upon a state or national bank or trust company, or a check of such bank or trust company signed by a duly authorized officer thereof.

(D) Return of Invitation For Bids Documents: All Invitation For Bids Documents must be returned to the Department upon request. If the bidder elects not to submit a bid thereunder, the

Invitation For Bids Documents shall be returned to the Department, along with a statement that no bid will be submitted.

(E) Return of Deposit: Such deposit will be returned within 30 days after the award of the contract or the rejection of all bids as set forth in the advertisement, provided the Invitation For Bids Documents are returned to the location specified in Attachment 1, in physical condition satisfactory to the Commissioner.

(F) Additional Copies: Additional copies of the Invitation For Bids Documents may be obtained, subject to the conditions set forth in the advertisement for bids.

5. Pre-Bid Conference

A pre-bid conference shall be held as set forth in Attachment 1. Nothing stated at the pre-bid conference shall change the terms or conditions of the Invitation For Bids Documents, unless a change is made by written amendment as provided in Section 9 below. Failure to attend a mandatory pre-bid conference shall constitute grounds for the rejection of the bid.

6. Agency Contact

Any questions or correspondence relating to this bid solicitation shall be addressed to the Agency Contact person specified in Attachment 1.

7. Bidder's Oath

(A) The bid shall be properly signed by an authorized representative of the bidder and the bid shall be verified by the written oath of the authorized representative who signed the bid, that the several matters stated and information furnished therein are in all aspects true.

(B) A materially false statement willfully or fraudulently made in connection with the bid or any of the forms completed and submitted with the bid may result in the termination of any Contract between the City and the Bidder. As a result, the Bidder may be barred from participating in future City contracts as well as be subject to possible criminal prosecution.

8. Examination and Viewing of Site, Consideration of Other Sources of Information and Changed Conditions

(A) Pre-Bidding (Investigation) Viewing of Site -Bidders must carefully view and examine the site of the proposed work, as well as its adjacent area, and seek other usual sources of information, for they will be conclusively presumed to have full knowledge of any and all conditions on, about or above the site relating to or affecting in any way the performance of the work to be done under the Contract which were or should have been indicated to a reasonably prudent bidder. To arrange a date for visiting the work site, bidders are to contact the Agency Contact person specified in Attachment 1.

(B) Should the contractor encounter during the progress of the work subsurface conditions at the site materially differing from any shown on the Contract Drawings or indicated in the Specifications or such subsurface conditions as could not reasonably have been anticipated by the contractor and were not anticipated by the City, which conditions will materially affect the cost of the work to be done under the

Contract, the attention of the Commissioner must be called immediately to such conditions before they are disturbed. The Commissioner shall thereupon promptly investigate the conditions. If he finds that they do so materially differ, or that they could not have been reasonably anticipated by the contractor and were not anticipated by the City, the Contract may be modified with his written approval.

9. Examination of Proposed Contract

(A) Request for Interpretation or Correction: Prospective bidders must examine the Contract Documents carefully and before bidding must request the Commissioner in writing for an interpretation or correction of every patent ambiguity, inconsistency or error therein which should have been discovered by a reasonably prudent bidder. Such interpretation or correction, as well as any additional contract provisions the Commissioner may decide to include, will be issued in writing by the Commissioner as an addendum to the Contract, which will be transmitted to each person recorded as having received a copy of the Contract Documents from the Department. Transmission of such addendum will be by mail, e-mail, facsimile or hand delivery. Such addendum will also be posted at the place where the Contract Documents are available for the inspection of prospective bidders. Upon transmission as provided for herein, such addendum shall become a part of the Contract Documents, and binding on all bidders, whether or not actual notice of such addendum is shown.

(B) Only Commissioner's Interpretation or Correction Binding: Only the written interpretation or correction so given by the Commissioner shall be binding, and prospective bidders are warned that no other officer, agent or employee of the City is authorized to give information concerning, or to explain or interpret, the Contract.

(C) Documents given to a subcontractor for the purpose of soliciting the subcontractor's bid shall include either a copy of the bid cover sheet or a separate information sheet setting forth the project name, the Contract number (if available), the contracting agency and the Project's location.

10. Form of Bid

Each bid must be submitted upon the prescribed form and must contain: a) the name, residence and place of business of the person or persons making the same; b) the names of all persons interested therein, and if no other person is so interested, such fact must be distinctly stated; c) a statement to the effect that it is made without any connection with any other person making a bid for the same purpose and that it is in all respects fair and without collusion or fraud; d) a statement that no Council member or other officer or employee or person whose salary is payable in whole or part from the City Treasury is directly or indirectly interested therein or in the supplies, materials or equipment and work or labor to which it relates, or in any portion of the profits thereof; e) a statement that the bidder is not in arrears to the City or to any agency upon a debt or contract or taxes, and is not a defaulter as surety or otherwise upon any obligation to the City to any agency thereof, except as set forth in the bid.

THE BID SHALL BE TYPEWRITTEN OR WRITTEN LEGIBLY IN INK. THE BID SHALL BE SIGNED IN INK. ERASURES OR ALTERATIONS SHALL BE INITIALED BY THE SIGNER IN INK. FAILURE TO CONFORM TO THE REQUIREMENTS OF THIS SECTION 10 SHALL RESULT IN THE REJECTION OF THE BID.

11. Irrevocability of Bid

The prices set forth in the bid cannot be revoked and shall be effective until the award of the Contract, unless the bid is withdrawn as provided for in Sections 15 and 18 below.

12. Acknowledgment of Amendments

The receipt of any amendment to the Contract Documents shall be acknowledged by the bidder in its bid submission.

13. Bid Samples and Descriptive Literature

Bid samples and descriptive literature shall not be submitted by the bidder, unless expressly requested elsewhere in the Contract or Contract Documents. Any unsolicited bid samples or descriptive literature which are submitted shall not be examined or tested and shall not be deemed to vary any of the provisions of this Contract.

14. Proprietary Information/Trade Secrets

(A) The bidder shall identify those portions of the bid which it deems to be confidential, proprietary information or trade secrets, and provide justification why such materials shall not be disclosed by the City. All such materials shall be clearly indicated by stamping the pages on which such information appears, at the top and bottom thereof with the word "Confidential". Such materials stamped "Confidential" must be easily separable from the non-confidential sections of the bid.

(B) All such materials so indicated shall be reviewed by the Agency and any decision not to honor a request for confidentiality shall be communicated in writing to the bidder. For those bids which are unsuccessful, all such confidential materials shall be returned to the bidder. Prices, makes and model or catalog numbers of the items offered, deliveries, and terms of payment shall be publicly available after bid opening, regardless of any designation of confidentiality made by the bidder.

15. Pre-Opening Modification or Withdrawal of Bids

Bids may be modified or withdrawn by written notice received in the office designated in Attachment 1, before the time and date set for the bid opening. If a bid is withdrawn in accordance with this Section, the bid security, if any, shall be returned to the bidder.

16. Bid Evaluation and Award

In accordance with the New York City Charter, the Procurement Policy Board Rules and the terms and conditions of this Invitation For Bids, this Contract shall be awarded, if at all, to the responsible bidder whose bid meets the requirements and evaluation criteria set forth in the Invitation For Bids, and whose bid price is either the most favorable bid price or, if the Invitation For Bids so states, the most favorable evaluated bid price. A bid may not be evaluated for any requirement or criterion that is not disclosed in the Invitation For Bids.

Restriction: No negotiations with any bidder shall be allowed to take place except under the circumstances and in the manner set forth in Section 21. Nothing in this Section shall be deemed to permit a contract award to a bidder submitting a higher quality item than that designated in the Invitation For Bids, if that bid is not also the most favorable bid.

17. Late Bids, Late Withdrawals and Late Modifications

Any bid received at the place designated in the solicitation after the time and date set for receipt of bids is late and shall not be considered. Any request for withdrawal or modification received at the place designated in the solicitation after the time and date set for receipt of bids is late and shall not be considered. The exception to this provision is that a late modification of a successful bid that makes the bid terms more favorable to the City shall be considered at any time it is received.

18. Withdrawal of Bids.

Except as provided for in Section 15, above, a bidder may not withdraw its bid before the expiration of forty-five (45) days after the date of the opening of bids; thereafter, a bidder may withdraw its bid only in writing and in advance of an actual award. If within sixty (60) days after the execution of the Contract, the Commissioner fails to fix the date for commencement of work by written notice to the bidder, the bidder, at his option, may ask to be relieved of his obligation to perform the work called for by written notice to the Commissioner. If such notice is given to the Commissioner, and the request to withdraw is granted, the bidder waives all claims in connection with this Contract.

19. Mistake in Bids

(A) Mistake Discovered Before Bid Opening: A bidder may correct mistakes discovered before the time and date set for bid opening by withdrawing or correcting the bid as provided in Section 15 above.

(B) Mistakes Discovered Before Award

(1) In accordance with General Municipal Law (Section 103, subdivision 11), where a unilateral error or mistake is discovered in a bid, such bid may be withdrawn upon written approval of the Agency Chief Contracting Officer if the following conditions are met:

- (a) The mistake is known or made known to the agency prior to the awarding of the Contract or within 3 days after the opening of the bid, whichever period is shorter; and
- (b) The price bid was based upon an error of such magnitude that enforcement would be unconscionable; and
- (c) The bid was submitted in good faith and the bidder submits credible evidence that the mistake was a clerical error as opposed to a judgment error; and
- (d) The error in the bid is actually due to an unintentional and substantial arithmetic error or an unintentional omission of a substantial quantity of work, labor, material or services made directly in the compilation of the bid, which unintentional arithmetic error or unintentional omission can be clearly shown by objective evidence drawn from inspection of the original work paper, documents, or materials used in the preparation of the bid sought to be withdrawn; and
- (e) It is possible to place the agency in the same position as existed prior to the bid.

(2) Unless otherwise required by law, the sole remedy for a bid mistake in accordance with this Article shall be withdrawal of the bid, and the return of the bid bond, or other security, if any, to the bidder. Thereafter, the agency may, in its discretion, award the Contract to the next lowest bidder or rebid the Contract. Any amendment to or reformation of a bid or a Contract to rectify such an error or mistake

therein is strictly prohibited.

(3) If the mistake and the intended correct bid are clearly evident on the face of the bid document, the bid shall be corrected to the intended correct bid and may not be withdrawn. Examples of mistakes that may be corrected are typographical errors, errors in extending unit prices, transposition errors and arithmetical errors.

20. Low Tie Bids

(A) When two or more low responsive bids from responsible bidders are identical in price, meeting all the requirements and criteria set forth in the Invitation For Bids, the Agency Chief Contracting Officer will break the tie in the following manner and order of priority:

- (1) Award to a certified New York City small, minority or woman-owned business entity bidder;
- (2) Award to a New York City bidder;
- (3) Award to a certified New York State small, minority or woman-owned business bidder;
- (4) Award to a New York State bidder.

(B) If two or more bidders still remain equally eligible after application of paragraph (A) above, award shall be made by a drawing by lot limited to those bidders. The bidders involved shall be invited to attend the drawing. A witness shall be present to verify the drawing and shall certify the results on the bid tabulation sheet.

21. Rejection of Bids

(A) Rejection of Individual Bids: The Agency may reject a bid if:

- (1) The bidder fails to furnish any of the information required pursuant to Section 24 or 28 hereof; or if
- (2) The bidder is determined to be not responsible pursuant to the Procurement Policy Board Rules; or if
- (3) The bid is determined to be non-responsive pursuant to the Procurement Policy Board Rules; or if
- (4) The bid, in the opinion of the Agency Chief Contracting Officer, contains unbalanced bid prices and is thus non-responsive, unless the bidder can show that the prices are not unbalanced for the probable required quantity of items, or if the imbalance is corrected pursuant to Section 15.

(B) Rejection of All Bids: The Agency, upon written approval by the Agency Chief Contracting Officer, may reject all bids and may elect to resolicit bids if in its sole opinion it shall deem it in the best interest of the City so to do.

(C) Rejection of All Bids and Negotiation With All Responsible Bidders: The Agency Head may determine that it is appropriate to cancel the Invitation For Bids after bid opening and before award and to complete the acquisition by negotiation. This determination shall be based on one of the following reasons:

- (1) All otherwise acceptable bids received are at unreasonable prices, or only one bid is received and the Agency Chief Contracting Officer cannot determine the reasonableness of the bid price, or no responsive bid has been received from a responsible bidder; or
- (2) In the judgment of the Agency Chief Contracting Officer, the bids were not independently arrived at in open competition, were collusive, or were submitted in bad faith.

(D) When the Agency has determined that the Invitation for Bids is to be canceled and that use of negotiation is appropriate to complete the acquisition, the contracting officer may negotiate and award the Contract without issuing a new solicitation, subject to the following conditions:

- (1) prior notice of the intention to negotiate and a reasonable opportunity to negotiate have been given by the contracting officer to each responsible bidder that submitted a bid in response to the Invitation for Bids;
- (2) the negotiated price is the lowest negotiated price offered by a responsible bidder; and
- (3) the negotiated price is lower than the lowest rejected bid price of a responsible bidder that submitted a bid in response to the Invitation for Bids.

22. Right to Appeal Determinations of Non-Responsiveness or Non-Responsibility and Right to Protest Solicitations and Award

The bidder has the right to appeal a determination of non-responsiveness or non-responsibility and has the right to protest a solicitation and award. For further information concerning these rights, the bidder is directed to the Procurement Policy Board Rules.

23. Affirmative Action and Equal Employment Opportunity

This Invitation For Bids is subject to applicable provisions of Federal, State and Local Laws and executive orders requiring affirmative action and equal employment opportunity.

24. VENDEX Questionnaires

(A) Requirement: Pursuant to Administrative Code Section 6-116.2 and the PPB Rules, bidders may be obligated to complete and submit VENDEX Questionnaires. Generally, if this bid is \$100,000 or more, or if this bid when added to the sum total of all contracts, concessions and franchises the bidder has received from the City and any subcontracts received from City contractors over the past twelve months, equals or exceeds \$100,000, Vendex Questionnaires must be completed. If required, Vendex Questionnaires must be completed and submitted before any award of contract may be made or before approval is given for a proposed subcontractor. Non-compliance with these submission requirements may result in the disqualification of the bid, disapproval of a subcontractor, subsequent withdrawal of approval for the use of an approved subcontractor, or the cancellation of the contract after its award.

(B) Submission: Vendex Questionnaires must be submitted directly to the Mayor's Office of Contract Services, ATTN: Vendex, 253 Broadway, 9th Floor, New York, New York 10007. In addition, the bidder must submit a Confirmation of Vendex Compliance to the agency. A form for this confirmation is set forth in the Bid Booklet.

(C) Obtaining Forms: Vendex Questionnaires, as well as detailed instructions, may be obtained at www.nyc.gov/vendex. The bidder may also obtain Vendex forms and instructions by contacting the

Agency Chief Contracting Office or the contract person for this contract.

25. Complaints About the Bid Process

The New York City Comptroller is charged with the audit of contracts in New York City. Any vendor who believes that there has been unfairness, favoritism or impropriety in the bid process should inform the Comptroller, Office of Contract Administration, One Centre Street, Room 835, New York, New York; telephone number (212)669-2797.

26. Bid, Performance and Payment Security

(A) Bid Security: Each bid must be accompanied by bid security in an amount and type specified in Attachment 1 (page A-1 of the Bid Booklet). The bid security shall assure the City of New York of the adherence of the bidder to its proposal, the execution of the Contract, and the furnishing of Performance and Payment Bonds by the bidder, if required in Attachment 1. Bid security shall be returned to the bidder as follows:

- (1) Within ten (10) days after the bid opening, the Comptroller will be notified to return the deposits of all but the three (3) lowest bidders. Within five (5) days after the award, the Comptroller will be notified to return the deposits of the remaining two unsuccessful bidders.
- (2) Within five (5) days after the execution of the Contract and acceptance of the Contractor's bonds, the Comptroller will be notified to return the bid security of the successful bidder or, if performance and payment bonds are not required, only after the sum retained under Article 21 of the Contract equals the amount of the bid security.
- (3) Where all bids are rejected, the Comptroller will be notified to return the deposit of the three (3) lowest bidders at the time of rejection.

(B) Performance and Payment Security: Performance and Payment Security must be provided in an amount and type specified in Attachment 1 (page A-1 of the Bid Booklet). The performance and payment security shall be delivered by the contractor prior to or at the time of execution of the Contract. If a contractor fails to deliver the required performance and payment security, its bid security shall be enforced, and an award of Contract may be made to the next lowest responsible and responsive bidder, or the contract may be rebid.

(C) Acceptable Types of Security: Acceptable types of security for bids, performance, and payment shall be limited to the following:

- (1) a one-time bond in a form satisfactory to the City;
- (2) a bank certified check or money order;
- (3) obligations of the City of New York; or
- (4) other financial instruments as determined by the Office of Construction in consultation with the Comptroller.

Whenever the successful bidder deposits obligations of the City of New York as performance and payment security, the Comptroller may sell and use the proceeds thereof for any purpose for which the principal or surety on such bond would be liable under the terms of the Contract. If the money is deposited with the Comptroller, the successful bidder shall not be entitled to receive interest on such money from the City.

(D) Form of Bonds: Security provided in the form of bonds must be prepared on the form of bonds authorized by the City of New York. Forms for bid, performance, and payment bonds are included in the Invitation for Bids Documents. Such bonds must have as surety thereunder such surety company or companies as are: (1) approved by the City of New York; (2) authorized to do business in the State of New York, and (3) approved by the Department of the Treasury of the United States. Premiums for any required bonds must be included in the base bid.

The bidder is advised that submission of a bid bond where the surety on such bond fails to meet the criteria set forth herein, shall result in the rejection of the bid as non-responsive.

The Department of the Treasury of the United States advises that information concerning approved surety companies may be obtained as follows: (1) from the Government Printing Office at 202-512-1800; (2) through the Internet at <http://www.fms.treas.gov/c570/index.html>, and (3) through a computerized public bulletin board, which can be accessed by using your computer modem and dialing 202-874-6887.

(E) Power of Attorney: Attorneys in fact who sign bid, performance, or payment bonds must file with each bond a certified copy of their power of attorney to sign said bonds.

27. Failure to Execute Contract

In the event of failure of the successful bidder to execute the Contract and furnish the required security within ten (10) days after notice of the award of the Contract, the deposit of the successful bidder or so much thereof as shall be applicable to the amount of the award made shall be retained by the City, and the successful bidder shall be liable for and hereby agrees to pay on demand the difference between the price bid and the price for which such Contract shall be subsequently awarded, including the cost of any required reletting and less the amount of such deposit. No plea of mistake in such accepted bid shall be available to the bidder for the recovery of the deposit or as a defense to any action based upon such accepted bid. Further, should the bidder's failure to comply with this Section cause any funding agency, body or group (Federal, State, City, Public, Private, etc.) to terminate, cancel or reduce the funding on this project, the bidder in such event shall be liable also to the City for the amount of actual funding withdrawn by such agency on this project, less the amount of the forfeited deposit.

28. Bidder Responsibilities and Qualifications

(A) Bidders must include with their bids all information necessary for a determination of bidder responsibility, as set forth in the Specifications.

(B) The Agency may require any bidder or prospective bidder to furnish all books of account, records, vouchers, statements or other information concerning the bidder's financial status for examination as may be required by the Agency to ascertain the bidder's responsibility and capability to perform the Contract. If required, a bidder must also submit a sworn statement setting forth such information as the Agency may require concerning present and proposed plant and equipment, the personnel and qualifications of his working organizations, prior experience and performance record.

(C) Oral Examination on Qualifications: In addition thereto, and when directed by the Agency, the bidder, or a responsible officer, agent or employee of the bidder, must submit to an oral examination to be conducted by the Agency in relation to his proposed tentative plan and schedule of

operations, and such other matters as the Agency may deem necessary in order to determine the bidder's ability and responsibility to perform the work in accordance with the Contract. Each person so examined must sign and verify a stenographic transcript of such examination noting thereon such corrections as such person may desire to make.

(D) If the bidder fails or refuses to supply any of the documents or information set forth in paragraph (B) hereof or fails to comply with any of the requirements thereof, the Agency may reject the bid.

29. Employment Report

In accordance with Executive Order No. 50 (1980) as modified by Executive Order 108 (1986), the filing of a completed Employment Report (ER) is a requirement of doing business with the City of New York for construction contractors with contracts of \$1,000,000 or more and subcontractors with construction subcontracts of \$750,000 or more. The required forms and information are included in the Bid Booklet.

30. Labor Law Requirements

(A) General: The successful bidder will be required to comply strictly with all Federal, State and local labor laws and regulations.

(B) New York State Labor Law: This Contract is subject to New York State Labor Law Section 220, which requires that construction workers on the site be paid prevailing wages and supplements. The Contractor is reminded that all wage provisions of this Contract will be enforced strictly and failure to comply will be considered when evaluating performance. Noncompliance may result in the contractor being debarred by the City from future contracts. Complaints filed with the Comptroller may result in decisions which may debar a contractor from bidding contracts with any state governmental entity and other political subdivisions.

(C) Records: The Contractor is expected to submit accurate payroll reports and other required documents and verify attendance and job classifications being utilized in compliance with the law, Contract provisions and agency procedures.

31. Insurance

(A) Bidders are advised that the insurance requirements contained herein are regarded as material terms of the Contract. As required by Article 22 of the Contract, the contractor must effect and maintain with companies licensed and authorized to do business in the State of New York, the types of insurance set forth therein, when required by and in the amounts set forth in Schedule A of the General Conditions. Such required insurance must be provided from the date the contractor is ordered to commence work and up to the date of final acceptance of all required work.

(B) The contractor must, within ten days of receipt of the notice of award, submit the following insurance documentation: (a) original certificate of insurance for general liability in the amount required by Schedule A of the General Conditions, and (b) original certificates of insurance or other proof of coverage for workers' compensation and disability benefits, as required by Section 57 of the New York State Workers' Compensation Law and Section 220 of the Disability Benefits Law.

32. Lump Sum Contracts

(A) Comparison of Bids: Bids on Lump Sum Contracts will be compared on the basis of the lump sum price bid, adjusted for alternate prices bid, if any.

(B) Lump Sum Bids for "General Construction Work" which include excavation shall include all necessary excavation work defined in the Specifications as being included in the lump sum bid. The bidder shall also bid a unit price for the additional cost of excavating material which is defined in the Specifications as excavation for which additional payment will be made. The total estimated additional cost of removing such material will be taken as the quantity set forth in the Engineer's Estimate multiplied by the unit price bid. This total estimated cost of additional excavation shall be added to the lump sum bid for the General Construction Work for the purpose of comparing bids to determine the low bidder.

(C) Variations from Engineer's Estimate: The Engineer's Estimate of the quantity of excavation for which additional payment will be made is approximate only and is given solely to be used as a uniform basis for the comparison of bids and such estimate is not to be considered as part of this contract. The quantities actually required to complete the contract work may be more or less than the quantities in the Engineer's Estimate and, if so, no action for damages or for loss of profits shall accrue to the contractor by reason thereof.

33. Unit Price Contracts

(A) Comparison of Bids: Bids on Unit Price Contracts will be compared on the basis of a total estimated price, arrived at by taking the sum of the estimated quantities of such items, in accordance with the Engineer's Estimate of Quantities set forth in the Bid Schedule, multiplied by the corresponding unit prices, and including any lump sum bids on individual items.

(B) Variations from Engineer's Estimate: Bidders are warned that the Engineer's Estimate of Quantities on the various items of work and materials is approximate only, given solely to be used as a uniform basis for the comparison of bids, and is not be considered part of this contract. The quantities actually required to complete the contract work may be less or more than so estimated, and if so, no action for damages or for loss of profits shall accrue to the contractor by reason thereof.

(C) Overruns: The terms and conditions applicable to overruns of unit price items are set forth in Article 26 of the Contract.

34. Excise Tax

Bidders are referred to the Specifications for information on Federal Excise Tax exemptions.

35. Licenses and Permits

The successful bidder will be required to obtain all necessary licenses and permits necessary to perform the work.

36. Multiple Prime Contractors

If more than one prime contractor will be involved on this project, all contractors are required to examine the Invitation for Bid packages for all other parts of the project.

37. Locally Based Enterprise Requirements (LBE)

This Contract is subject to the requirements of Administrative Code, Section 6-108.1, and the regulations promulgated thereunder. No construction contract will be awarded unless and until these requirements have been complied with in their entirety. The bidder is advised of the provisions set forth below, as well as the provisions with respect to the Locally Based Enterprise Program contained in Article 67 of the Contract. The contractor is advised that:

(A) If any portion of the Contract is subcontracted, not less than ten percent of the total dollar amount of the contract shall be awarded to locally based enterprises ("LBEs"); except, where less than ten percent of the total dollar amount of the Contract is subcontracted, such lesser percentage shall be so awarded.

(B) No contractor shall require performance and payment bonds from LBE subcontractors.

(C) No Contract shall be awarded unless the contractor first identifies in its bid:

- (1) the percentage, dollar amount and type of work to be subcontracted; and
- (2) the percentage, dollar amount and type of work to be subcontracted to LBEs.

(D) Within ten calendar days after notification of low bid, the apparent low bidder shall submit an "LBE Participation Schedule" to the contracting agency. If such schedule does not identify sufficient LBE subcontractors to meet the requirements of Administrative Code Section 6-108.1, the apparent low bidder shall submit documentation of its good faith efforts to meet such requirements.

(1) The "LBE Participation Schedule" shall include:

- (a) the name and address of each LBE that will be given a subcontract,
- (b) the percentage, dollar amount and type of work to be subcontracted to the LBE, and
- (c) the dates when the LBE subcontract work will commence and end.

(2) The following documents shall be attached to the "LBE Participation Schedule":

- (a) verification letters from each subcontractor listed in the "LBE Participation Schedule" stating that the LBE will enter into a formal agreement for work,
- (b) certification documents of any proposed LBE subcontractor which is not on the LBE certified list, and
- (c) copies of the certification letter of any proposed subcontractor which is an LBE.

(3) Documentation of good faith efforts to achieve the required LBE percentage shall include as appropriate but not limited to the following:

- (a) attendance at prebid meetings, when scheduled by the agency, to advise bidders of contract requirements;

- (b) advertisement where appropriate in general circulation media, trade association publications and small business media of the specific subcontracts that would be at least equal to the percentage goal for LBE utilization specified by the contractor;
- (c) written notification to association of small, minority and women contractors soliciting specific subcontractors;
- (d) written notification by certified mail to LBE firms that their interest in the contract is solicited for specific work items and their estimated values;
- (e) demonstration of efforts made to select portions of the work for performance by LBE firms in order to increase the likelihood of achieving the stated goal;
- (f) documented efforts to negotiate with LBE firms for specific subcontracts, including at a minimum:
 - (i) The names, address and telephone numbers of LBE firms that are contacted;
 - (ii) A description of the information provided to LBE firms regarding the plans and specifications for portions of the work to be performed;
 - (iii) Documentation showing that no reasonable price can be obtained from LBE firms;
 - (iv) A statement of why agreements with LBE firms were not reached;
- (g) a statement of the reason for rejecting any LBE firm which the contractor deemed to be unqualified; and
- (h) documentation of efforts made to assist the LBE firms contacted that needed assistance in obtaining required insurance.

(E) Unless otherwise waived by the Commissioner with the approval of the Office of Economic and Financial Opportunity, failure of a proposed contractor to provide the information required by paragraphs (C) and (D) above may render the bid non-responsive and the Contract may not be awarded to the bidder. If the contractor states that it will subcontract a specific portion of the work, but can demonstrate despite good faith efforts it cannot achieve its required LBE percentage for subcontracted work until after award of Contract, the Contract may be awarded, subject to a letter of compliance from the contractor stating that it will comply with Administrative Code Section 6-108.1 and subject to approval by the Commissioner. If the contractor has not met its required LBE percentage prior to award, the contractor shall demonstrate that a good faith effort has been made subsequent to award to obtain LBEs on each subcontract until it meets the required percentage.

(F) When a bidder indicates prior to award that no work will be subcontracted, no work may be subcontracted without the prior written approval of the Commissioner, which shall be granted only if the contractor in good faith seeks LBE subcontractors at least six weeks prior to the start of work.

(G) The contractor may not substitute or change any LBE which was identified prior to award of the contract without the written permission of the Commissioner. The contractor shall make a written application to the Commissioner for permission to make such substitution or change, explaining why the contractor needs to change its LBE subcontractor and how the contractor will meet its LBE subcontracting requirement. Copies of such application must be served on the originally identified LBE by certified mail return receipt requested, as well as the proposed substitute LBE. The Commissioner shall determine whether or not to grant the contractor's request for substitution.

38. Bid Submission Requirements

The Bid Submission Requirements are set forth on page 2 of the Bid Booklet.

39. Comptroller's Certificate

This Contract shall not be binding or of any force unless it is registered by the Comptroller in accordance with Section 328 of the City Charter and the Procurement Policy Board Rules. This Contract shall continue in force only after annual appropriation of funds by the City of New York and certification as hereinabove set forth.

40. Procurement Policy Board Rules

This Invitation For Bids is subject to the Rules of the Procurement Policy Board of the City of New York. In the event of a conflict between said Rules and a provision of this Invitation For Bids, the Rules shall take precedence.

41. DDC Safety Requirements

The DDC Safety Requirements apply to the work to be performed pursuant to the Contract. The DDC Safety Requirements are set forth on the following pages.

CITY OF NEW YORK

DEPARTMENT OF DESIGN AND CONSTRUCTION

SAFETY REQUIREMENTS

THE DDC SAFETY REQUIREMENTS INCLUDE THE FOLLOWING SECTIONS:

- I. POLICY ON SITE SAFETY.....**
- II. PURPOSE**
- III. DEFINITIONS.....**
- IV. RESPONSIBILITIES.....**
- V. SAFETY QUESTIONNAIRE**
- VI. SAFETY PROGRAM AND SITE SAFETY PLAN**
- VII. KICK-OFF/PRE-CONSTRUCTION MEETINGS AND SAFETY REVIEW**
- VIII. EVALUATION DURING WORK IN PROGRESS**
- IX. SAFETY PERFORMANCE EVALUATION.....**

I. POLICY ON SITE SAFETY

The City of New York Department of Design and Construction (DDC) is committed to a policy of injury and illness prevention and risk management for construction work that will ensure the safety and health of the workers engaged in the projects and the protection of the general public. Therefore, it is DDC's policy that work carried out by Contractors on DDC jobsites must, at a minimum, comply with applicable federal, state and city laws, rules and regulations, including without limitation:

- ❑ U. S. Department of Labor 29 Code of Federal Regulations (CFR) Part 1926 and applicable Sub-parts of Part 1910 – U.S. Occupational Safety and Health Administration (OSHA) including, but not limited to “Respiratory Protection” (29 CFR 1910.134), “Permit-Required Confined Spaces” (29 CFR 1910.146), and “Hazard Communication” (29 CFR 1910.1200);
- ❑ New York State Department of Labor Industrial Code Rule 23 – Protection in Construction, Demolition and Excavation;
- ❑ New York City Construction Codes, Title 28
- ❑ NYC Department of Transportation Title 34 Chapter 2 – Highway Rules
- ❑ New York State Department of Labor Industrial Code Rule 753
- ❑ NYC Local Law No. 113 (2005) Noise Control Code

In addition, all regulations promulgated by the NYC Department of Transportation, including requirements for Maintenance and Protection of Traffic (MPT), are applicable when contained in contract specifications. While MPT is a significant component of work in our Infrastructure Division, it does not supersede or exempt Contractors from complying with other applicable health and safety standards (for example, excavating and trenching standards, operation of heavy equipment and compliance with City environmental and noise regulations).

II. PURPOSE

The purpose of this policy is to ensure that Contractors perform their work and supervise their employees in accordance with all applicable federal, state and city rules and regulations. Further, Contractors will be expected to minimize or eliminate jobsite and public hazard, through a planning, inspection, auditing and corrective action process. The goal is to control risks so that injuries, illnesses and accidents to contractors' employees, DDC employees and the general public, as well as damage to city-owned and private property, are reduced to the lowest level feasible.

III. DEFINITIONS

Agency Chief Contracting Officer (ACCO): The ACCO shall mean the person delegated authority by the Commissioner to organize and supervise the procurement activity of subordinate Agency staff in conjunction with the CCPO.

Competent Person: As defined by OSHA, an individual who is capable of identifying existing and predictable hazards in the surroundings or working conditions that are unsanitary, hazardous, or dangerous to employees or the general public, and who has authorization to take prompt corrective measures to eliminate them.

Construction Safety Auditor: A representative of the QACS Construction Safety Unit who provides inspection and assessment services to enhance health and safety on all DDC construction projects. The activities of the Construction Safety Auditor include performing site surveys, reviewing health and safety plans, reviewing construction permits, and rendering technical advice and assistance to DDC Resident Engineers and Project Managers.

City of New York Department of Design and Construction: Safety Requirements
Technical Support Division – Bureau of Quality Assurance and Construction Safety

Construction Safety Unit: A part of QACS within the Division of Technical Support that assesses contractor safety on DDC jobsites and advises responsible parties of needed corrective actions.

Construction Superintendent: A representative of the contractor responsible for overseeing performance of the required construction work. This individual must engage in sound construction practices, and is responsible to maintain a safe work site. In the case of a project involving the demolition, alteration or new construction of buildings, the Construction Superintendent must be licensed by the NYC Department of Buildings.

Contractor: For purposes of these Safety Requirements, the term “Contractor” shall mean any person or entity that enters into a contract for the performance of construction work on a DDC project. The term “Contractor” shall include any person or entity which enters into any of the following types of contracts: (1) a prime construction contract for a specific project, (2) a prime construction contract using the Job Order Contracting System (“JOCS Contract”), and (3) a subcontract with a CM/Builder (“First Tier Subcontract”).

Director - Quality Assurance and Construction Safety (QACS): Responsible for the operations of the QACS Construction Safety Unit and the DDC Site Safety management programs.

Job Hazard Assessment (JHA): A process of identifying site-specific hazards that may be present during construction and establishing the means and methods to reduce or eliminate those hazards.

Jobsite Safety Coordinator: A person designated by the Contractor to be onsite during all activities. This individual shall have received, at a minimum, the OSHA 10-hour construction safety program. Other examples of acceptable training are the 30-hour OSHA Safety and Health Standards for the Construction Industry training program (OSHA 510) or a degree/certificate in a safety and health from a college-level curriculum. This person does not necessarily have to be dedicated full-time to site safety, but must have sufficient experience and authority to undertake corrective action and must qualify to be a competent person. For certain projects, as defined in NYC Construction Codes – Title 28, this person may be required to have a Site Safety Manager’s License issued by the NYC DOB.

Qualified Person: As defined by OSHA, an individual who, by possession of a recognized degree, certificate, license or professional standing, or who by extensive knowledge, training, and experience, has successfully demonstrated his or her ability to solve problems relating to the subject matter, the work, or the project. Qualified Persons are required under regulation to address issues pertaining, but without limit, to fall protection, scaffold design and trenching and shoring, among others.

Resident Engineer (RE) / Construction Project Manager (CPM): Representative of the Commissioner duly designated by the Commissioner to be his/her representative at the site of the work. (The RE/CPM may be a third-party consultant, including a CM, retained by DDC.)

Safety Program: Established by the Contractor that covers all operations of that Contractor and establishes the Contractor’s overall safety policy, regulatory compliance plan and minimum safety standards. The Safety Program must be submitted prior to the commencement of work at the site and is subject to review and acceptance by the Construction Safety Unit.

Safety Questionnaire: Used by DDC to evaluate Contractor’s current and past safety performance. It is required to be completed by all Contractors initially when submitting bids for Construction work, or when being pre-qualified and updated annually or as requested by the DDC.

Site Safety Plan: A site-specific safety plan developed by the Contractor for a specific project. The Site Safety Plan must identify hazards associated with the project, and include specific safety precautions and training appropriate and necessary to complete the work. The Site Safety Plan must be submitted prior to the commencement of work at the site and is subject to review and acceptance by the Construction Safety Unit.

Unsafe or Unhealthy Condition: A condition that could be potentially hazardous to the health and safety of personnel or the public, and/or damaging to equipment, machinery, property or the environment.

Weekly Safety Meetings: Weekly documented jobsite safety meetings, given to all jobsite personnel by contractor, with the purpose of discussing general safety topics and job specific requirements encountered at the DDC work site.

IV. RESPONSIBILITIES

All persons who manage, perform, and provide support for construction projects shall conduct operations in compliance with the requirements identified in this Policy and all applicable governing regulatory agency requirements and guidelines pertaining to safety in construction.

A. Resident Engineer / Construction Project Manager / Construction Manager

- Monitors the issuance of safety-related permits, approvals and drawings and maintains copies on site.
- Monitors construction-related work activities to confirm that they are conducted in accordance with DDC policies and all applicable regulations that pertain to construction safety.
- Maintains documentation and periodically attends weekly safety meeting.
- Notifies the Construction Safety Unit and the ACCO's Insurance and Risk Management Unit of project-related accidents and emergencies, as per DDC's Construction Safety Emergency Protocol.
- Gathers facts related to all accidents and prepares DDC Accident Reports.
- Notifies the Construction Safety Unit of outside regulatory agency inspections and forwards a copy of the inspection report within three days of its receipt.
- Monitors the conditions at the site for conformance with the Site Safety Plan and DDC construction documents.
- Notifies the contractor and DDC in the event that any condition or activity exists that is not in compliance with the Site Safety Plan, applicable federal, state or local codes or any condition that presents a potential risk of injury to the public or workers or possible damage to property.
- Notifies DDC of any emergency condition and directs the contractor to provide such labor, materials, equipment and supervision to abate such conditions.
- Reports gross safety violations to the Construction Safety Unit immediately.

B. Contractors

- Complete a Safety Questionnaire and submit with its bid or as part of a pre-qualification package.
- Provide a Written Job Hazard Assessment (JHA) that identifies expected safety issues of the work to be performed. JHA shall be included with the Site Safety Plan submitted by the contractor.
- Submit a Site Safety Plan and Safety Program within 15 days of issuance of the Notice to Proceed, or as otherwise directed. The Site Safety Plan and Safety Program are subject to review and acceptance by the Construction Safety Unit prior to the commencement of work at the site. The Site Safety Plan shall be revised and updated as necessary.
- Ensure that all employees are aware of the hazards associated with the project through formal and informal training and/or other communications. Conduct and document weekly safety meetings for the duration of the project. Documentation to be provided to the RE/CPM/CM on a monthly basis.
- Name a Construction Superintendent, if required.
- Name a Job Site Safety Coordinator. The Contractor will be required to identify the Job Site Safety Coordinator in the Site Safety Plan.
- Comply with all mandated federal, state and local safety and health rules and regulations.
- Comply with all provisions of the Site Safety Plan.
- As part of the Site Safety Plan, prepare a site specific MPT (if not otherwise provided in the contract documents) and comply with all of its provisions.

City of New York Department of Design and Construction: Safety Requirements
Technical Support Division – Bureau of Quality Assurance and Construction Safety

- Conduct and document site-specific safety orientation for Contractor personnel to review the hazards associated with the project as identified in the Site Safety Plan and the specific safety procedures and controls that will be used to protect workers, the general public and property. The Job Site Safety Coordinator will conduct this training prior to mobilization and provide documentation to the RE/CPM/CM.
- Provide, replace and adequately maintain at or around the project site, suitable and sufficient signage, lights, barricades and enclosures (fences, sidewalk sheds, netting, bracing, etc.).
- Report unsafe conditions or hazards to the DDC RE/CPM/CM as soon as practical, but no more than 24 hours after discovery, and take action to remove or abate such conditions.
- Report any accident involving injuries to workers or the general public, as well as property damage, to the DDC RE/CPM/CM within two (2) hours.
- Notify the DDC RE/CPM/CM within two (2) hours of the start of an inspection by any regulatory agency personnel, including OSHA.
- Maintain all records pertaining to all required compliance documents and accident and injury reports.
- Respond to DDC recommendations on safety, which shall in no way relieve the Contractor of its responsibilities for safety on the project. The Contractor has sole responsibility for safety.

V. SAFETY QUESTIONNAIRE

DDC requires that all Contractors provide information regarding their current and past safety and environmental performance and programs. This will be accomplished by the use of the DDC Safety Questionnaire. As a part of the bid submittal package, the contractor must submit a completed DDC Safety Questionnaire listing their workers' compensation experience modification rating and OSHA Incidence Rates for the three (3) years prior to the date of the bid opening. DDC may request a Contractor to update its Questionnaire at any time or to provide more detailed information. The Contractor must provide the requested update within 30 days.

The following criteria will be used by DDC in reviewing the Contractor's responsibility, which will be based on the information provided on the questionnaire:

- Criteria 1: OSHA Injury and Illness Rates (I&IR) are no greater than the average for the industry (based on the most current Bureau of Labor Statistics data for the Contractors SIC code); and
- Criteria 2: Insurance workers compensation Experience Modification Rate (EMR) equal to or less than 1.0; and
- Criteria 3: Any willful violations issued by OSHA or NYC DOB within the last three years; and
- Criteria 4: A fatality (worker or member of public) experienced on or near Contractor's worksite within the last three (3) years; and
- Criteria 5: An unacceptable rating by QACS based on past performance on DDC projects; and
- Criteria 6: Contractor has in place an acceptable corporate safety program and its employees shall have completed all documented relative safety training; and
- Criteria 7: Contractor shall provide OSHA Injury Records (currently OSHA 300 Log) for the last three (3) years.

If the Contractor fails to meet the basic criteria listed above, the Construction Safety Unit may request, through the ACCO, more detail concerning the Contractor's safety experience. DDC may request the Contractor to provide copies of, among other things, OSHA records, OSHA and DOB citations, EPA citations and written Safety Programs.

VI. SAFETY PROGRAM AND SITE SAFETY PLAN

Within fifteen (15) days of issuance of the Notice to Proceed, or as otherwise directed, the Contractor shall submit the following: (1) Safety Program, and (2) Site Safety Plan. The Safety Program shall set forth the Contractor's overall safety policy, regulatory compliance plan and minimum safety standard, and the Site Safety Plan shall identify hazards associated with the project, and include specific safety precautions and training appropriate and necessary to complete the work. The Safety Program and the Site Safety Plan are subject to review and acceptance by the Construction Safety Unit prior to the commencement of work at the site. Failure by the contractor to submit an acceptable Site Safety Plan and Safety Program shall be grounds for default.

The Site Safety Plan shall apply to all Contractor and subcontractor operations, and shall have at a minimum, the following elements. Each element shall be described in a separate section in the written document. It may be necessary to modify the basic format for certain unique or high-risk projects (such as tunnels or high-rise construction). The basic elements are as follows:

1. **Responsibility and Organization:** Identify the person or persons with authority and responsibility for implementing the Site Safety Plan. Provide an organization chart and define levels of authority and responsibility. Identify the Competent Person, the Construction Superintendent (if required), the Job Safety Coordinator and the Qualified Person required for this project.
2. **Communication:** Establish a system for communicating with employees and subcontractors on matters relating to worker and public safety and health and environmental protection, including provisions designed to encourage employees to inform the employer of hazards at the worksite without fear of reprisal. An emergency response notification protocol is to be established that also includes after hours contact numbers. The plan must also include provisions for weekly safety meetings held by the Job Site Safety Coordinator.
3. **Job Hazard Assessment:** A written document submitted by the contractor, used to identify expected job hazards and public safety risks and state the specific means and methods to reduce, control or eliminate those hazards. This part of the Site Safety Plan must also include how on-going evaluations of those risks and hazards will be carried out, including plans for periodic inspections to identify unsafe conditions, work practices and public safety hazards.
4. **Accident/Exposure Investigation:** Establish a procedure to investigate and report occupational and public injury or illness, property damage, vehicle accidents or other mishaps.
5. **Hazard Correction:** Establish means, methods and/or procedures for correcting unsafe or unhealthy conditions that might be exposing both the public and workers to hazards. Corrective actions must be taken immediately when observed or discovered. Should an imminent hazard exist which cannot be immediately abated without endangering employees, the public and/or property, remove or restrict all exposed persons from the area except those necessary to correct the existing condition. Employees necessary to correct the hazardous condition shall be provided the necessary safeguards. When corrective actions cannot be taken immediately, temporary measures should be taken until such time permanent measures are taken to eliminate the potential risks or hazards.
6. **Training:** Describe site-specific hazard training programs. In addition to the required safety orientation, additional site specific training, in the form of required weekly safety meetings, will be required. Contractors must also initiate training when: a) new employees are hired; b) employees are given new job assignments for which training has not been previously received; c) new substances, processes, procedures or equipment are introduced that might represent a new public or worker hazard; d) the employee is made aware of a new or previously unrecognized hazard; e) new supervisors are assigned to familiarize themselves with the safety and health hazards to which employees under their immediate direction and control may be exposed; and f) after a jobsite incident or accident has occurred.

City of New York Department of Design and Construction: Safety Requirements
Technical Support Division – Bureau of Quality Assurance and Construction Safety

7. Recordkeeping: Establish procedures to maintain records of scheduled and periodic inspections, weekly safety meetings, and training records. Updated records shall be maintained at the jobsite, accessible to the Construction Safety Auditors and/or Quality Assurance Auditors/RE/CPM, and retained in accordance with DDC policy.

The most critical component of the Site Safety Plan is the Job Hazard Assessment section. This section must address specific hazards that are anticipated throughout the project. Each Site Safety Plan must address, at a minimum:

- Public and pedestrian safety
- Fall protection
- Electrical hazards
- Scaffolding
- Fire protection
- Emergency notification & response
- Housekeeping / debris removal
- Dust control
- Maintenance and protection of traffic
- Trenching and excavating
- Heavy equipment operations
- Material / equipment storage
- Environmental contamination
- Sheeting and shoring
- Alcohol and Drug Abuse Policy

The following additional hazards must be addressed, if applicable, based on the contract safety specifications and/or the results of the JHA (the list is not all-inclusive):

- Basic Personal Protective Equipment
- Compressed Air
- Compressed Gas Cylinders
- Cranes, Derricks and Hoists
- Demolition
- Electrical safety
- Excavations and Trenching
- Fall Protection – Floor openings/Stairways
- Fall Protection – Guardrails Toe boards etc
- Fall Protection – Leading Edge
- Fall Protection – Personal Fall Protection Devices
- Fire Protection and Fire Prevention
- Hazard Communication (RIGHT TO KNOW)
- Hazardous Energy & Lock Out / Tag Out
- Housekeeping/ Sanitation
- Maintenance and Protection of Traffic (MPT)
- Man Lifts /Aerial Lifts
- Marine Operations
- Motor Vehicle Safety
- Overhead Power lines
- Permit Required Confined Space
- Portable Ladders
- Powered Actuated Tools
- Powered Material Handling Equipment
- Scaffolds – Mobile
- Scaffolds – Stationary
- Scaffolds – Suspended
- Slings
- Steel Erection

City of New York Department of Design and Construction: Safety Requirements
Technical Support Division – Bureau of Quality Assurance and Construction Safety

- Welding and Cutting (Hot Work)
- Airborne Contaminants – Particulates – General
- Asbestos
- Blood borne Pathogens
- Hearing Protection
- Lead in Construction
- Mercury in Construction
- PCB's
- Respiratory Protection
- Silica
- Thermal Stress
- West Nile Virus
- Rodents and Vermin
- Noise Mitigation Plan

Certain DDC programs, such as Job Order Contracting System (JOCS), may not necessarily require Site Safety Plans. The JOCS contractor will be required to submit a Safety Program. In addition, certain DDC Operating Units may establish program or client-specific safety requirements. The contractor's Site Safety Plan must address such program or client specific safety requirements.

VII. KICK-OFF MEETINGS/PRE-CONSTRUCTION AND SAFETY REVIEW

As part of the construction kick-off meeting, a Site Safety Plan review will be part of the agenda. A QACS representative will participate in this meeting with the contractor prior to the start of the project for the purpose of:

- A. Reviewing the safety issues detailed in the contract.
- B. Reviewing the Site Safety Plan.
- C. Reviewing any new issues or information that was not previously addressed.
- D. Discussing planned inspections and audits of the site by DDC personnel.

VIII. EVALUATION DURING WORK IN PROGRESS

The Contractor's adherence to these Safety Requirements will be monitored throughout the project. This will be accomplished by the following:

- A. Use of a safety checklist by a representative of the Construction Safety Unit or other designated DDC representative or Consultant during regular, unannounced inspections of the job site. Field Exit Conferences will be held with the RE/CPM, Contractor Superintendents or Safety Representatives.
- B. The RE/CPM will continually monitor the safety and environmental performance of the contractor's employees and work methods. Deficiencies shall be brought to the attention of the contractor's representative on site for immediate correction. The DDC representative will maintain a written record of these deficiencies and forward them to the Construction Safety Unit on a weekly basis. Any critical deficiencies shall be immediately reported to QACS phone# (718) 391-1624 or (718) 391-1911.
- C. If the Contractor's safety performance during the project is not up to DDC standards (safety performance measure, accident/incident rate, etc.) the Director- QACS, or designee will meet with the Contractor's safety representative, the DDC project manager, the RE/CPM, or the DDC Environmental Specialist (if environmental issues are involved). The purpose of this meeting is to 1) determine the level of non-compliance; 2) explain and clarify the safety/environmental provisions; 3) agree on a future course of action to correct the deficiencies.

City of New York Department of Design and Construction: Safety Requirements
Technical Support Division – Bureau of Quality Assurance and Construction Safety

- D. If the deficiencies continue to occur with inadequate attention by the contractor, this shall, among other remedies available, be grounds for default.
- E. The contractor shall inform the Construction Safety Unit and ACCO Insurance and Risk Management Unit of all medical injuries or illnesses that require doctors' treatment resulting from an on-the-job incident within 24 hours of the occurrence. The Construction Safety Unit shall also be immediately informed of all fatalities, catastrophic accidents with more than one employee hospitalized, any injuries to members of the general public and major equipment damage (e.g., property damage, equipment rollovers, loads dropped from crane). QACS shall maintain a record of all contractor injuries and illnesses during the project and provide regular reports to the Agency.
- F. The Construction Safety Unit shall be immediately notified at the start of any NYS-DOL/ NYC-COSH/ OSHA/ EPA inspections. The Director of Quality Assurance & Construction Safety shall maintain a log of all contractor OSHA/EPA inspections and citations during the project.

IX. SAFETY PERFORMANCE EVALUATION

The contractor's safety record, including all DDC inspection results, will be considered as part of the Contractor's performance evaluation at the conclusion of the project. Poor safety performance during the course of the project shall be a reason to rate a Contractor unsatisfactory which will be reflected in the City's Vendex system and will be considered for future procurement actions as set forth in the City's Procurement Policy Board Rules.

(NO TEXT ON THIS PAGE)

CITY OF NEW YORK
STANDARD CONSTRUCTION CONTRACT

DECEMBER 2013

(NO TEXT ON THIS PAGE)

**CITY OF NEW YORK
STANDARD CONSTRUCTION CONTRACT**

TABLE OF CONTENTS

**CHAPTER I
THE CONTRACT AND DEFINITIONS**

ARTICLE 1.	THE CONTRACT	1
ARTICLE 2.	DEFINITIONS	1

**CHAPTER II
THE WORK AND ITS PERFORMANCE**

ARTICLE 3.	CHARACTER OF THE WORK	4
ARTICLE 4.	MEANS AND METHODS OF CONSTRUCTION	4
ARTICLE 5.	COMPLIANCE WITH LAWS	5
ARTICLE 6.	INSPECTION	10
ARTICLE 7.	PROTECTION OF WORK AND OF PERSONS AND PROPERTY; NOTICES AND INDEMNIFICATION	11

**CHAPTER III
TIME PROVISIONS**

ARTICLE 8.	COMMENCEMENT AND PROSECUTION OF THE WORK	12
ARTICLE 9.	PROGRESS SCHEDULES	12
ARTICLE 10.	REQUESTS FOR INFORMATION OR APPROVAL	13
ARTICLE 11.	NOTICE OF CONDITIONS CAUSING DELAY AND DOCUMENTATION OF DAMAGES CAUSED BY DELAY	13
ARTICLE 12.	COORDINATION WITH OTHER CONTRACTORS	17
ARTICLE 13.	EXTENSION OF TIME FOR PERFORMANCE	18
ARTICLE 14.	COMPLETION AND FINAL ACCEPTANCE OF THE WORK	21
ARTICLE 15.	LIQUIDATED DAMAGES	22
ARTICLE 16.	OCCUPATION OR USE PRIOR TO COMPLETION	22

**CHAPTER IV
SUBCONTRACTS AND ASSIGNMENTS**

ARTICLE 17.	SUBCONTRACTS	23
ARTICLE 18.	ASSIGNMENTS	25

**CITY OF NEW YORK
STANDARD CONSTRUCTION CONTRACT**

TABLE OF CONTENTS

**CHAPTER V
CONTRACTOR'S SECURITY AND GUARANTY**

ARTICLE 19.	SECURITY DEPOSIT	26
ARTICLE 20.	PAYMENT GUARANTEE	26
ARTICLE 21.	RETAINED PERCENTAGE	29
ARTICLE 22.	INSURANCE	29
ARTICLE 23.	MONEY RETAINED AGAINST CLAIMS	35
ARTICLE 24.	MAINTENANCE AND GUARANTY	36

**CHAPTER VI
CHANGES, EXTRA WORK AND DOCUMENTATION OF CLAIM**

ARTICLE 25.	CHANGES	37
ARTICLE 26.	METHODS OF PAYMENT FOR OVERRUNS AND EXTRA WORK	37
ARTICLE 27.	RESOLUTION OF DISPUTES	40
ARTICLE 28.	RECORD KEEPING FOR EXTRA OR DISPUTED WORK OR WORK ON A TIME & MATERIALS BASIS	44
ARTICLE 29.	OMITTED WORK	45
ARTICLE 30.	NOTICE AND DOCUMENTATION OF COSTS AND DAMAGES; PRODUCTION OF FINANCIAL RECORDS	45

**CHAPTER VII
POWERS OF THE RESIDENT ENGINEER, THE ENGINEER
OR ARCHITECT AND THE COMMISSIONER**

ARTICLE 31.	THE RESIDENT ENGINEER	46
ARTICLE 32.	THE ENGINEER OR ARCHITECT OR PROJECT MANAGER	47
ARTICLE 33.	THE COMMISSIONER	47
ARTICLE 34.	NO ESTOPPEL	48

**CHAPTER VIII
LABOR PROVISIONS**

ARTICLE 35.	EMPLOYEES	48
ARTICLE 36.	NO DISCRIMINATION	50
ARTICLE 37.	LABOR LAW REQUIREMENTS	52
ARTICLE 38.	PAYROLL REPORTS	57
ARTICLE 39.	DUST HAZARDS	58

**CITY OF NEW YORK
STANDARD CONSTRUCTION CONTRACT**

TABLE OF CONTENTS

**CHAPTER IX
PARTIAL AND FINAL PAYMENTS**

ARTICLE 40.	CONTRACT PRICE	58
ARTICLE 41.	BID BREAKDOWN ON LUMP SUM	58
ARTICLE 42.	PARTIAL PAYMENTS	58
ARTICLE 43.	PROMPT PAYMENT	59
ARTICLE 44.	SUBSTANTIAL COMPLETION PAYMENT	59
ARTICLE 45.	FINAL PAYMENT	60
ARTICLE 46.	ACCEPTANCE OF FINAL PAYMENT	61
ARTICLE 47.	APPROVAL BY PUBLIC DESIGN COMMISSION	62

**CHAPTER X
CONTRACTOR'S DEFAULT**

ARTICLE 48.	COMMISSIONER'S RIGHT TO DECLARE CONTRACTOR IN DEFAULT	62
ARTICLE 49.	EXERCISE OF THE RIGHT TO DECLARE DEFAULT	64
ARTICLE 50.	QUITTING THE SITE	64
ARTICLE 51.	COMPLETION OF THE WORK	64
ARTICLE 52.	PARTIAL DEFAULT	64
ARTICLE 53.	PERFORMANCE OF UNCOMPLETED WORK	65
ARTICLE 54.	OTHER REMEDIES	65

**CHAPTER XI
MISCELLANEOUS PROVISIONS**

ARTICLE 55.	CONTRACTOR'S WARRANTIES	66
ARTICLE 56.	CLAIMS AND ACTIONS THEREON	66
ARTICLE 57.	INFRINGEMENT	66
ARTICLE 58.	NO CLAIM AGAINST OFFICERS, AGENTS OR EMPLOYEES	67
ARTICLE 59.	SERVICE OF NOTICES	67
ARTICLE 60.	UNLAWFUL PROVISIONS DEEMED STRICKEN FROM CONTRACT	67
ARTICLE 61.	ALL LEGAL PROVISIONS DEEMED INCLUDED	67
ARTICLE 62.	TAX EXEMPTION	67
ARTICLE 63.	INVESTIGATION(S) CLAUSE	69
ARTICLE 64.	TERMINATION BY THE CITY	71
ARTICLE 65.	CHOICE OF LAW, CONSENT TO JURISDICTION AND VENUE	73

**CITY OF NEW YORK
STANDARD CONSTRUCTION CONTRACT**

TABLE OF CONTENTS

CHAPTER XI (CONT'D)

MISCELLANEOUS PROVISIONS

ARTICLE 66.	PARTICIPATION IN AN INTERNATIONAL BOYCOTT	74
ARTICLE 67.	LOCALLY BASED ENTERPRISE PROGRAM	74
ARTICLE 68.	ANTITRUST	75
ARTICLE 69.	MACBRIDE PRINCIPLES PROVISIONS	75
ARTICLE 70	ELECTRONIC FILING/NYC DEVELOPMENT HUB	77
ARTICLE 71.	PROHIBITION OF TROPICAL HARDWOODS	77
ARTICLE 72.	CONFLICTS OF INTEREST	78
ARTICLE 73.	MERGER CLAUSE	78
ARTICLE 74.	STATEMENT OF WORK	78
ARTICLE 75.	COMPENSATION TO BE PAID TO CONTRACTOR	78
ARTICLE 76:	ELECTRONIC FUNDS TRANSFER	78
ARTICLE 77:	RECORDS RETENTION	79
ARTICLE 78:	PARTICIPATION BY MINORITY-OWNED AND WOMEN-OWNED BUSINESS ENTERPRISES IN CITY PROCUREMENT	79
 SIGNATURES		 87
ACKNOWLEDGMENT BY CORPORATION		88
ACKNOWLEDGMENT BY PARTNERSHIP		88
ACKNOWLEDGMENT BY INDIVIDUAL		88
ACKNOWLEDGMENT BY COMMISSIONER		89
 AUTHORITY		 90
COMPTROLLER'S CERTIFICATE		90
MAYOR'S CERTIFICATE		91
PERFORMANCE BOND #1		92
PERFORMANCE BOND #2		96
PAYMENT BOND		100

WITNESSETH:

The parties, in consideration of the mutual agreements contained herein, agree as follows:

**CHAPTER I
THE CONTRACT AND DEFINITIONS**

ARTICLE 1. THE CONTRACT

1.1 Except for titles, subtitles, headings, running headlines, tables of contents and indices (all of which are printed herein merely for convenience), the following, except for such portions thereof as may be specifically excluded, shall be deemed to be part of this Contract:

1.1.1 All provisions required by law to be inserted in this Contract, whether actually inserted or not;

1.1.2 The Contract Drawings and Specifications;

1.1.3 The General Conditions and Special Conditions, if any;

1.1.4 The Contract;

1.1.5 The Information for Bidders; Request for Proposals; Notice of Solicitation and Proposal For Bids; Bid or Proposal, and, if used, the Bid Booklet;

1.1.6 All Addenda issued prior to the receipt of the bids; the Notice of Award; Performance and Payment Bonds, if required; and the Notice to Proceed or the Order to Work.

1.2 Should any conflict occur in or between the Drawings and Specifications, the Contractor shall be deemed to have estimated the most expensive way of doing the Work, unless the Contractor shall have asked for and obtained a decision in writing from the Commissioner of the Agency that is entering into this Contract, before the submission of its bid, as to what shall govern.

ARTICLE 2. DEFINITIONS

2.1 The following words and expressions, or pronouns used in their stead, shall, wherever they appear in this Contract, be construed as follows, unless a different meaning is clear from the context:

2.1.1 "**Addendum**" or "**Addenda**" shall mean the additional Contract provisions and/or technical clarifications issued in writing by the Commissioner prior to the receipt of bids.

2.1.2 "**Agency**" shall mean a city, county, borough or other office, position, department, division, bureau, board or commission, or a corporation, institution or agency of government, the expenses of which are paid in whole or in part from the City treasury.

2.1.3 "**Agency Chief Contracting Officer**" (**ACCO**) shall mean a person delegated authority by the Commissioner to organize and supervise the procurement activity of subordinate Agency staff in conjunction with the CCPO, or his/her duly authorized representative.

2.1.4 **"Allowance"** shall mean a sum of money which the Agency may include in the total amount of the Contract for such specific contingencies as the Agency believes may be necessary to complete the Work, e.g., lead or asbestos remediation, and for which the Contractor will be paid on the basis of stipulated unit prices or a formula set forth in the Contract or negotiated between the parties provided, however, that if the Contractor is not directed to use the Allowance, the Contractor shall have no right to such money and it shall be deducted from the total amount of the Contract.

2.1.5 **"City"** shall mean the City of New York.

2.1.6 **"City Chief Procurement Officer" (CCPO)** shall mean a person delegated authority by the Mayor to coordinate and oversee the procurement activity of Mayoral agency staff, including the ACCO and any offices which have oversight responsibility for the procurement of construction, or his/her duly authorized representative.

2.1.7 **"Commissioner"** shall mean the head of the Agency that has entered into this Contract, or his/her duly authorized representative.

2.1.8 **"Comptroller"** shall mean the Comptroller of the City of New York.

2.1.9 **"Contract"** or **"Contract Documents"** shall mean each of the various parts of the contract referred to in Article 1 hereof, both as a whole and severally.

2.1.10 **"Contract Drawings"** shall mean only those drawings specifically entitled as such and listed in the Specifications or in any Addendum, or any drawings furnished by the Commissioner, pertaining or supplemental thereto.

2.1.11 **"Contract Work"** shall mean everything required to be furnished and done by the Contractor by any one or more of the parts of the Contract referred to in Article 1, except Extra Work as hereinafter defined.

2.1.12 **"Contractor"** shall mean the entity which executed this Contract, whether a corporation, firm, partnership, joint venture, individual, or any combination thereof, and its, their, his/her successors, personal representatives, executors, administrators, and assigns, and any person, firm, partnership, joint venture, individual, or corporation which shall at any time be substituted in the place of the Contractor under this Contract.

2.1.13 **"Days"** shall mean calendar days, except where otherwise specified.

2.1.14 **"Engineer"** or **"Architect"** or **"Project Manager"** shall mean the person so designated in writing by the Commissioner in the Notice to Proceed or the Order to Work to act as such in relation to this Contract, including a private Architect or Engineer or Project Manager, as the case may be. Subject to written approval by the Commissioner, the Engineer, Architect or Project Manager may designate an authorized representative.

2.1.15 **"Engineering Audit Officer" (EAO)** shall mean the person so designated by the Commissioner to perform responsible auditing functions hereunder.

2.1.16 **"Extra Work"** shall mean Work other than that required by the Contract at the time of award which is authorized by the Commissioner pursuant to Chapter VI of this Contract.

2.1.17 **"Federal-Aid Contract"** shall mean a contract in which the United States (federal) Government provides financial funding as so designated in the Information for Bidders.

2.1.18 "**Final Acceptance**" shall mean final written acceptance of all the Work by the Commissioner, a copy of which shall be sent to the Contractor.

2.1.19 "**Final Approved Punch List**" shall mean a list, approved pursuant to Article 14.2.2, specifying those items of Work to be completed by the Contractor after Substantial Completion and dates for the completion of each item of Work.

2.1.20 "**Law**" or "**Laws**" shall mean the Constitution of the State of New York, the New York City Charter, the New York City Administrative Code, a statute of the United States or of the State of New York, a local law of the City of New York, any ordinance, rule or regulation having the force of law, or common law.

2.1.21 "**Materialman**" shall mean any corporation, firm, partnership, joint venture, or individual, other than employees of the Contractor, who or which contracts with the Contractor or any Subcontractor, to fabricate or deliver, or who actually fabricates or delivers, plant, materials or equipment to be incorporated in the Work.

2.1.22 "**Means and Methods of Construction**" shall mean the labor, materials, temporary structures, tools, plant, and construction equipment, and the manner and time of their use, necessary to accomplish the result intended by this Contract.

2.1.23 "**Notice to Proceed**" or "**Order to Work**" shall mean the written notice issued by the Commissioner specifying the time for commencement of the Work and the Engineer, Architect or Project Manager.

2.1.24 "**Other Contractor(s)**" shall mean any contractor (other than the entity which executed this Contract or its Subcontractors) who or which has a contract with the City for work on or adjacent to the building or Site of the Work.

2.1.25 "**Payroll Taxes**" shall mean State Unemployment Insurance (SUI), Federal Unemployment Insurance (FUI), and payments pursuant to the Federal Insurance Contributions Act (FICA).

2.1.26 "**Project**" shall mean the public improvement to which this Contract relates.

2.1.27 "**Procurement Policy Board**" (**PPB**) shall mean the Agency of the City of New York whose function is to establish comprehensive and consistent procurement policies and rules which shall have broad application throughout the City.

2.1.28 "**Required Quantity**" in a unit price Contract shall mean the actual quantity of any item of Work or materials which is required to be performed or furnished in order to comply with the Contract.

2.1.29 "**Resident Engineer**" shall mean the representative of the Commissioner duly designated by the Commissioner to be his/her representative at the site of the Work.

2.1.30 "**Site**" shall mean the area upon or in which the Contractor's operations are carried on, and such other areas adjacent thereto as may be designated as such by the Engineer.

2.1.31 "**Small Tools**" shall mean items that are ordinarily required for a worker's job function, including but not limited to, equipment that ordinarily has no licensing, insurance

or substantive storage costs associated with it; such as circular and chain saws, impact drills, threaders, benders, wrenches, socket tools, etc.

2.1.32 "**Specifications**" shall mean all of the directions, requirements, and standards of performance applying to the Work as hereinafter detailed and designated under the Specifications.

2.1.33 "**Subcontractor**" shall mean any person, firm or corporation, other than employees of the Contractor, who or which contracts with the Contractor or with its subcontractors to furnish, or actually furnishes labor, or labor and materials, or labor and equipment, or superintendence, supervision and/or management at the Site. Wherever the word Subcontractor appears, it shall also mean sub-Subcontractor.

2.1.34 "**Substantial Completion**" shall mean the written determination by the Engineer that the Work required under this Contract is substantially, but not entirely, complete and the approval of the **Final Approved Punch List**.

2.1.35 "**Work**" shall mean all services required to complete the Project in accordance with the Contract Documents, including without limitation, labor, material, superintendence, management, administration, equipment, and incidentals, and obtaining any and all permits, certifications and licenses as may be necessary and required to complete the Work, and shall include both Contract Work and Extra Work.

CHAPTER II THE WORK AND ITS PERFORMANCE

ARTICLE 3. CHARACTER OF THE WORK

3.1 Unless otherwise expressly provided in the **Contract Drawings, Specifications, and Addenda**, the **Work** shall be performed in accordance with the best modern practice, utilizing, unless otherwise specified in writing, new and unused materials of standard first grade quality and workmanship and design of the highest quality, to the satisfaction of the **Commissioner**.

ARTICLE 4. MEANS AND METHODS OF CONSTRUCTION

4.1 Unless otherwise expressly provided in the **Contract Drawings, Specifications, and Addenda**, the **Means and Methods of Construction** shall be such as the **Contractor** may choose; subject, however, to the **Engineer's** right to reject the **Means and Methods of Construction** proposed by the **Contractor** which in the opinion of the **Engineer**:

4.1.1 Will constitute or create a hazard to the **Work**, or to persons or property; or

4.1.2 Will not produce finished **Work** in accordance with the terms of the **Contract**; or

4.1.3 Will be detrimental to the overall progress of the **Project**.

4.2 The **Engineer's** approval of the **Contractor's Means and Methods of Construction**, or his/her failure to exercise his/her right to reject such means or methods, shall not relieve the **Contractor** of its obligation to complete the **Work** as provided in this **Contract**; nor shall the exercise of such right to reject create a cause of action for damages.

ARTICLE 5. COMPLIANCE WITH LAWS

5.1 The **Contractor** shall comply with all **Laws** applicable to this **Contract** and to the **Work** to be done hereunder.

5.2 Procurement Policy Board Rules: This **Contract** is subject to the Rules of the **PPB** ("**PPB Rules**") in effect at the time of the bid opening for this **Contract**. In the event of a conflict between the **PPB Rules** and a provision of this **Contract**, the **PPB Rules** shall take precedence.

5.3 Noise Control Code provisions.

5.3.1 In accordance with the provisions of Section 24-216(b) of the Administrative Code of the **City** ("**Administrative Code**"), Noise Abatement Contract Compliance, devices and activities which will be operated, conducted, constructed or manufactured pursuant to this **Contract** and which are subject to the provisions of the **City Noise Control Code** shall be operated, conducted, constructed, or manufactured without causing a violation of the **Administrative Code**. Such devices and activities shall incorporate advances in the art of noise control development for the kind and level of noise emitted or produced by such devices and activities, in accordance with regulations issued by the **Commissioner** of the **City Department of Environmental Protection**.

5.3.2 The **Contractor** agrees to comply with Section 24-219 of the Administrative Code and implementing rules codified at 15 Rules of the City of New York ("**RCNY**") Section 28-100 *et seq.* In accordance with such provisions, the **Contractor**, if the **Contractor** is the responsible party under such regulations, shall prepare and post a Construction Noise Mitigation Plan at each **Site**, in which the **Contractor** shall certify that all construction tools and equipment have been maintained so that they operate at normal manufacturers operating specifications. If the **Contractor** cannot make this certification, it must have in place an Alternative Noise Mitigation Plan approved by the **City Department of Environmental Protection**. In addition, the **Contractor's** certified Construction Noise Mitigation Plan is subject inspection by the **City Department of Environmental Protection** in accordance with Section 28-101 of Title 15 of **RCNY**. No **Contract Work** may take place at a **Site** unless there is a Construction Noise Mitigation Plan or approved Alternative Noise Mitigation Plan in place. In addition, the **Contractor** shall create and implement a noise mitigation training program. Failure to comply with these requirements may result in fines and other penalties pursuant to the applicable provisions of the **Administrative Code** and **RCNY**.

5.4 Ultra Low Sulfur Diesel Fuel: In accordance with the provisions of Section 24-163.3 of the **Administrative Code**, the **Contractor** specifically agrees as follows:

5.4.1 Definitions. For purposes of this Article 5.4, the following definitions apply:

5.4.1(a) "**Contractor**" means any person or entity that enters into a Public Works Contract with a **City Agency**, or any person or entity that enters into an agreement with such person or entity, to perform work or provide labor or services related to such Public Works Contract.

5.4.1(b) "**Motor Vehicle**" means any self-propelled vehicle designed for transporting persons or property on a street or highway.

5.4.1(c) "**Nonroad Engine**" means an internal combustion engine (including the fuel system) that is not used in a Motor Vehicle or a vehicle used solely for competition, or that is not subject to standards promulgated under Section 7411 or Section 7521 of

Title 42 of the United States Code, except that this term shall apply to internal combustion engines used to power generators, compressors or similar equipment used in any construction program or project.

5.4.1(d) "Nonroad Vehicle" means a vehicle that is powered by a Nonroad Engine, fifty (50) horsepower and greater, and that is not a Motor Vehicle or a vehicle used solely for competition, which shall include, but not be limited to, excavators, backhoes, cranes, compressors, generators, bulldozers, and similar equipment, except that this term shall not apply to horticultural maintenance vehicles used for landscaping purposes that are powered by a Nonroad Engine of sixty-five (65) horsepower or less and that are not used in any construction program or project.

5.4.1(e) "Public Works Contract" means a contract with a **City Agency** for a construction program or project involving the construction, demolition, restoration, rehabilitation, repair, renovation, or abatement of any building, structure, tunnel, excavation, roadway, park or bridge; a contract with a **City Agency** for the preparation for any construction program or project involving the construction, demolition, restoration, rehabilitation, repair, renovation, or abatement of any building, structure, tunnel, excavation, roadway, park or bridge; or a contract with a **City Agency** for any final work involved in the completion of any construction program or project involving the construction, demolition, restoration, rehabilitation, repair, renovation, or abatement of any building, structure, tunnel, excavation, roadway, park or bridge.

5.4.1(f) "Ultra Low Sulfur Diesel Fuel" means diesel fuel that has a sulfur content of no more than fifteen parts per million (15 ppm).

5.4.2 Ultra Low Sulfur Diesel Fuel

5.4.2(a) All **Contractors** shall use Ultra Low Sulfur Diesel Fuel in diesel-powered Nonroad Vehicles in the performance of this **Contract**.

5.4.2(b) Notwithstanding the requirements of Article 5.4.2(a), **Contractors** may use diesel fuel that has a sulfur content of no more than thirty parts per million (30 ppm) to fulfill the requirements of this Article 5.4.2, where the Commissioner of the **City Department of Environmental Protection** ("DEP Commissioner") has issued a determination that a sufficient quantity of Ultra Low Sulfur Diesel Fuel is not available to meet the needs of **Agencies** and **Contractors**. Any such determination shall expire after six (6) months unless renewed.

5.4.2(c) **Contractors** shall not be required to comply with this Article 5.4.2 where the **City Agency** letting this **Contract** makes a written finding, which is approved, in writing, by the DEP Commissioner, that a sufficient quantity of Ultra Low Sulfur Diesel Fuel, or diesel fuel that has a sulfur content of no more than thirty parts per million (30 ppm) is not available to meet the requirements of Section 24-163.3 of the Administrative Code, provided that such **Contractor** in its fulfillment of the requirements of this **Contract**, to the extent practicable, shall use whatever quantity of Ultra Low Sulfur Diesel Fuel or diesel fuel that has a sulfur content of no more than thirty parts per million (30 ppm) is available. Any finding made pursuant to this Article 5.4.2(c) shall expire after sixty (60) **Days**, at which time the requirements of this Article 5.4.2 shall be in full force and effect unless the **City Agency** renews the finding in writing and such renewal is approved by the DEP Commissioner.

5.4.2(d) **Contractors** may check on determinations and approvals issued by the DEP Commissioner pursuant to Section 24-163.3 of the Administrative Code, if any, at www.dep.nyc.gov or by contacting the **City Agency** letting this **Contract**.

5.4.2(e) The requirements of this Article 5.4.2 do not apply where they are precluded by federal or State funding requirements or where the **Contract** is an emergency procurement.

5.4.3 Best Available Technology

5.4.3(a) All **Contractors** shall utilize the best available technology for reducing the emission of pollutants for diesel-powered Nonroad Vehicles in the performance of this **Contract**. For determinations of best available technology for each type of diesel-powered Nonroad Vehicle, **Contractors** shall comply with the regulations of the **City Department of Environmental Protection**, as and when adopted, Chapter 14 of Title 15 of the Rules of the City of New York (RCNY). The **Contractor** shall fully document all steps in the best available technology selection process and shall furnish such documentation to the **City Agency** or the DEP Commissioner upon request. The **Contractor** shall retain all documentation generated in the best available technology selection process for as long as the selected best available technology is in use.

5.4.3(b) No **Contractor** shall be required to replace best available technology for reducing the emission of pollutants or other authorized technology utilized for a diesel-powered Nonroad Vehicle in accordance with the provisions of this Article 5.4.3 within three (3) years of having first utilized such technology for such vehicle.

5.4.3(c) This Article 5.4.3 shall not apply to any vehicle used to satisfy the requirements of a specific Public Works Contract for fewer than twenty (20) **Days**.

5.4.3(d) The **Contractor** shall not be required to comply with this Article 5.4.3 with respect to a diesel-powered Nonroad Vehicle under the following circumstances:

5.4.3(d)(i) Where the **City Agency** makes a written finding, which is approved, in writing, by the DEP Commissioner, that the best available technology for reducing the emission of pollutants as required by this Article 5.4.3 is unavailable for such vehicle, the **Contractor** shall use whatever technology for reducing the emission of pollutants, if any, is available and appropriate for such vehicle.

5.4.3(d)(ii) Where the DEP Commissioner has issued a written waiver based upon the **Contractor** having demonstrated to the DEP Commissioner that the use of the best available technology for reducing the emission of pollutants might endanger the operator of such vehicle or those working near such vehicle, due to engine malfunction, the **Contractor** shall use whatever technology for reducing the emission of pollutants, if any, is available and appropriate for such vehicle, which would not endanger the operator of such vehicle or those working near such vehicle.

5.4.3(d)(iii) In determining which technology to use for the purposes of Articles 5.4.3(d)(i) and 5.4.3(d)(ii) above, the **Contractor** shall primarily consider the reduction in emissions of particulate matter and secondarily consider the reduction in emissions of nitrogen oxides associated with the use of such

technology, which shall in no event result in an increase in the emissions of either such pollutant.

5.4.3(d)(iv) The **Contractor** shall submit requests for a finding or a waiver pursuant to this Article 5.4.3(d) in writing to the DEP Commissioner, with a copy to the **ACCO** of the **City Agency** letting this **Contract**. Any finding or waiver made or issued pursuant to Articles 5.4.3(d)(i) and 5.4.3(d)(ii) above shall expire after one hundred eighty (180) **Days**, at which time the requirements of Article 5.4.3(a) shall be in full force and effect unless the **City Agency** renews the finding, in writing, and the DEP Commissioner approves such finding, in writing, or the DEP Commissioner renews the waiver, in writing.

5.4.3(e) The requirements of this Article 5.4.3 do not apply where they are precluded by federal or State funding requirements or where the **Contract** is an emergency procurement.

5.4.4 Section 24-163 of the Administrative Code. The **Contractor** shall comply with Section 24-163 of the Administrative Code related to the idling of the engines of motor vehicles while parking.

5.4.5 Compliance

5.4.5(a) The **Contractor's** compliance with Article 5.4 may be independently monitored. If it is determined that the **Contractor** has failed to comply with any provision of Article 5.4, any costs associated with any independent monitoring incurred by the **City** shall be reimbursed by the **Contractor**.

5.4.5(b) Any **Contractor** who violates any provision of Article 5.4, except as provided in Article 5.4.5(c) below, shall be liable for a civil penalty between the amounts of one thousand (\$1,000) and ten thousand (\$10,000) dollars, in addition to twice the amount of money saved by such **Contractor** for failure to comply with Article 5.4.

5.4.5(c) No **Contractor** shall make a false claim with respect to the provisions of Article 5.4 to a **City Agency**. Where a **Contractor** has been found to have done so, such **Contractor** shall be liable for a civil penalty of twenty thousand (\$20,000) dollars, in addition to twice the amount of money saved by such **Contractor** in association with having made such false claim.

5.4.6 Reporting

5.4.6(a) For all Public Works Contracts covered by this Article 5.4, the **Contractor** shall report to the **City Agency** the following information:

5.4.6(a)(i) The total number of diesel-powered Nonroad Vehicles used to fulfill the requirements of this Public Works Contract;

5.4.6(a)(ii) The number of such Nonroad Vehicles that were powered by Ultra Low Sulfur Diesel Fuel;

5.4.6(a)(iii) The number of such Nonroad Vehicles that utilized the best available technology for reducing the emission of pollutants, including a breakdown by vehicle model and the type of technology;

5.4.6(a)(iv) The number of such Nonroad Vehicles that utilized such other authorized technology in accordance with Article 5.4.3, including a breakdown by vehicle model and the type of technology used for each such vehicle;

5.4.6(a)(v) The locations where such Nonroad Vehicles were used; and

5.4.6(a)(vi) Where a determination is in effect pursuant to Article 5.4.2(b) or 5.4.2(c), detailed information concerning the **Contractor's** efforts to obtain Ultra Low Sulfur Diesel Fuel or diesel fuel that has a sulfur content of no more than thirty parts per million (30 ppm).

5.4.6(b) The **Contractor** shall submit the information required by Article 5.4.6(a) at the completion of **Work** under the Public Works Contract and on a yearly basis no later than August 1 throughout the term of the Public Works Contract. The yearly report shall cover **Work** performed during the preceding fiscal year (July 1 - June 30).

5.5 Ultra Low Sulfur Diesel Fuel. In accordance with the Coordinated Construction Act for Lower Manhattan, as amended:

5.5.1 Definitions. For purposes of this Article 5.5, the following definitions apply:

5.5.1(a) "Lower Manhattan" means the area to the south of and within the following lines: a line beginning at a point where the United States pierhead line in the Hudson River as it exists now or may be extended would intersect with the southerly line of West Houston Street in the Borough of Manhattan extended, thence easterly along the southerly side of West Houston Street to the southerly side of Houston Street, thence easterly along the southerly side of Houston Street to the southerly side of East Houston Street, thence northeasterly along the southerly side of East Houston Street to the point where it would intersect with the United States pierhead line in the East River as it exists now or may be extended, including tax lots within or immediately adjacent thereto.

5.5.1(b) "Lower Manhattan Redevelopment Project" means any project in Lower Manhattan that is funded in whole or in part with federal or State funding, or any project intended to improve transportation between Lower Manhattan and the two air terminals in the City known as LaGuardia Airport and John F. Kennedy International Airport, or between Lower Manhattan and the air terminal in Newark known as Newark Liberty International Airport, and that is funded in whole or in part with federal funding.

5.5.1(c) "Nonroad Engine" means an internal combustion engine (including the fuel system) that is not used in a Motor Vehicle or a vehicle used solely for competition, or that is not subject to standards promulgated under Section 7411 or Section 7521 of Title 42 of the United States Code, except that this term shall apply to internal combustion engines used to power generators, compressors or similar equipment used in any construction program or project.

5.5.1(d) "Nonroad Vehicle" means a vehicle that is powered by a Nonroad Engine, fifty (50) horsepower (HP) and greater, and that is not a Motor Vehicle or a vehicle used solely for competition, which shall include, but not be limited to, excavators, backhoes, cranes, compressors, generators, bulldozers, and similar equipment, except

that this terms shall not apply to horticultural maintenance vehicles used for landscaping purposes that are powered by a Nonroad Engine of sixty-five (65) HP or less and that are not used in any construction program or project.

5.5.1(e) "Ultra Low Sulfur Diesel Fuel" means diesel fuel that has a sulfur content of no more than fifteen parts per million (15 ppm).

5.5.2 Requirements. **Contractors** and **Subcontractors** are required to use only Ultra Low Sulfur Diesel Fuel to power the diesel-powered Nonroad Vehicles with engine HP rating of fifty (50) HP and above used on a Lower Manhattan Redevelopment Project and, where practicable, to reduce the emission of pollutants by retrofitting such Nonroad Vehicles with oxidation catalysts, particulate filters, or technology that achieves lowest particulate matter emissions.

5.6 Pesticides. In accordance with Section 17-1209 of the Administrative Code, to the extent that the **Contractor** or any **Subcontractor** applies pesticides to any property owned or leased by the **City**, the **Contractor**, and any **Subcontractor** shall comply with Chapter 12 of the Administrative Code.

5.7 Waste Treatment, Storage, and Disposal Facilities and Transporters. In connection with the **Work**, the **Contractor** and any **Subcontractor** shall use only those waste treatment, storage, and disposal facilities and waste transporters that possess the requisite license, permit or other governmental approval necessary to treat, store, dispose, or transport the waste, materials or hazardous substances.

5.8 Environmentally Preferable Purchasing. The **Contractor** shall ensure that products purchased or leased by the **Contractor** or any **Subcontractor** for the **Work** that are not specified by the **City** or are submitted as equivalents to a product specified by the **City** comply with the requirements of the New York City Environmentally Preferable Purchasing Program contained in Chapter 11 of Title 43 of the RCNY, pursuant to Chapter 3 of Title 6 of the Administrative Code.

ARTICLE 6. INSPECTION

6.1 During the progress of the **Work** and up to the date of **Final Acceptance**, the **Contractor** shall at all times afford the representatives of the **City** every reasonable, safe, and proper facility for inspecting all **Work** done or being done at the **Site** and also for inspecting the manufacture or preparation of materials and equipment at the place of such manufacture or preparation.

6.2 The **Contractor's** obligation hereunder shall include the uncovering or taking down of finished **Work** and its restoration thereafter; provided, however, that the order to uncover, take down and restore shall be in writing, and further provided that if **Work** thus exposed proves satisfactory, and if the **Contractor** has complied with Article 6.1, such uncovering or taking down and restoration shall be considered an item of **Extra Work** to be paid for in accordance with the provisions of Article 26. If the **Work** thus exposed proves unsatisfactory, the **City** has no obligation to compensate the **Contractor** for the uncovering, taking down or restoration.

6.3 Inspection and approval by the **Commissioner**, the **Engineer**, **Project Manager**, or **Resident Engineer**, of finished **Work** or of **Work** being performed, or of materials and equipment at the place of manufacture or preparation, shall not relieve the **Contractor** of its obligation to perform the **Work** in strict accordance with the **Contract**. Finished or unfinished **Work** not found to be in strict accordance with the **Contract** shall be replaced as directed by the **Engineer**, even though such **Work** may have been previously approved and paid for. Such corrective **Work** is **Contract Work** and shall not be deemed **Extra Work**.

6.4 Rejected **Work** and materials shall be promptly taken down and removed from the **Site**, which must at all times be kept in a reasonably clean and neat condition.

**ARTICLE 7. PROTECTION OF WORK AND OF PERSONS
AND PROPERTY; NOTICES AND INDEMNIFICATION**

7.1 During the performance of the **Work** and up to the date of **Final Acceptance**, the **Contractor** shall be under an absolute obligation to protect the finished and unfinished **Work** against any damage, loss, injury, theft and/or vandalism and in the event of such damage, loss, injury, theft and/or vandalism, it shall promptly replace and/or repair such **Work** at the **Contractor's** sole cost and expense, as directed by the **Resident Engineer**. The obligation to deliver finished **Work** in strict accordance with the **Contract** prior to **Final Acceptance** shall be absolute and shall not be affected by the **Resident Engineer's** approval of, or failure to prohibit, the **Means and Methods of Construction** used by the **Contractor**.

7.2 During the performance of the **Work** and up to the date of **Final Acceptance**, the **Contractor** shall take all reasonable precautions to protect all persons and the property of the **City** and of others from damage, loss or injury resulting from the **Contractor's**, and/or its **Subcontractors'** operations under this **Contract**. The **Contractor's** obligation to protect shall include the duty to provide, place or replace, and adequately maintain at or about the **Site** suitable and sufficient protection such as lights, barricades, and enclosures.

7.3 The **Contractor** shall comply with the notification requirements set forth below in the event of any loss, damage or injury to **Work**, persons or property, or any accidents arising out of the operations of the **Contractor** and/or its **Subcontractors** under this **Contract**.

7.3.1 The **Contractor** shall make a full and complete report in writing to the **Resident Engineer** within three (3) **Days** after the occurrence.

7.3.2 The **Contractor** shall also send written notice of any such event to all insurance carriers that issued potentially responsive policies (including commercial general liability insurance carriers for events relating to the **Contractor's** own employees) no later than twenty (20) days after such event and again no later than twenty (20) days after the initiation of any claim and/or action resulting therefrom. Such notice shall contain the following information: the number of the insurance policy, the name of the Named Insured, the date and location of the incident, and the identity of the persons injured or property damaged. For any policy on which the **City** and/or the **Engineer, Architect, or Project Manager** are Additional Insureds, such notice shall expressly specify that "this notice is being given on behalf of the City of New York as Additional Insured, such other Additional Insureds, as well as the Named Insured."

7.3.2(a) Whenever such notice is sent under a policy on which the **City** is an Additional Insured, the **Contractor** shall provide copies of the notice to the **Comptroller**, the **Commissioner** and the **City Corporation Counsel**. The copy to the **Comptroller** shall be sent to the Insurance Unit, NYC Comptroller's Office, 1 Centre Street – Room 1222, New York, New York, 10007. The copy to the **Commissioner** shall be sent to the address set forth in Schedule A of the General Conditions. The copy to the **City Corporation Counsel** shall be sent to Insurance Claims Specialist, Affirmative Litigation Division, New York City Law Department, 100 Church Street, New York, New York 10007.

7.3.2(b) If the **Contractor** fails to provide any of the foregoing notices to any appropriate insurance carrier(s) in a timely and complete manner, the **Contractor** shall indemnify the **City** for all losses, judgments, settlements, and expenses, including reasonable attorneys' fees, arising from an insurer's disclaimer of coverage citing late notice by or on behalf of the **City**.

7.4 To the fullest extent permitted by law, the **Contractor** shall defend, indemnify, and hold the **City**, its employees, and officials (the "Indemnitees") harmless against any and all claims (including but not limited to claims asserted by any employee of the **Contractor** and/or its **Subcontractors**) and costs and expenses of whatever kind (including but not limited to payment or reimbursement of attorneys' fees and disbursements) allegedly arising out of or in any way related to the operations of the **Contractor** and/or its **Subcontractors** in the performance of this **Contract** or from the **Contractor's** and/or its **Subcontractors'** failure to comply with any of the provisions of this **Contract** or of the **Law**. Such costs and expenses shall include all those incurred in defending the underlying claim and those incurred in connection with the enforcement of this Article 7.4 by way of cross-claim, third-party claim, declaratory action or otherwise. The parties expressly agree that the indemnification obligation hereunder contemplates (1) full indemnity in the event of liability imposed against the Indemnitees without negligence and solely by reason of statute, operation of **Law** or otherwise; and (2) partial indemnity in the event of any actual negligence on the part of the Indemnitees either causing or contributing to the underlying claim (in which case, indemnification will be limited to any liability imposed over and above that percentage attributable to actual fault whether by statute, by operation of **Law**, or otherwise). Where partial indemnity is provided hereunder, all costs and expenses shall be indemnified on a pro rata basis.

7.4.1 Indemnification under Article 7.4 or any other provision of the **Contract** shall operate whether or not **Contractor** or its **Subcontractors** have placed and maintained the insurance specified under Article 22.

7.5 The provisions of this Article 7 shall not be deemed to create any new right of action in favor of third parties against the **Contractor** or the **City**.

CHAPTER III TIME PROVISIONS

ARTICLE 8. COMMENCEMENT AND PROSECUTION OF THE WORK

8.1 The **Contractor** shall commence the **Work** on the date specified in the **Notice to Proceed** or the **Order to Work**. The time for performance of the **Work** under the **Contract** shall be computed from the date specified in the **Notice to Proceed** or the **Order to Work**. **TIME BEING OF THE ESSENCE** to the **City**, the **Contractor** shall thereafter prosecute the **Work** diligently, using such **Means and Methods of Construction** as are in accord with Article 4 herein and as will assure its completion not later than the date specified in this **Contract**, or on the date to which the time for completion may be extended.

ARTICLE 9. PROGRESS SCHEDULES

9.1 To enable the **Work** to be performed in an orderly and expeditious manner, the **Contractor**, within fifteen (15) **Days** after the **Notice to Proceed** or **Order to Work**, unless otherwise directed by the **Engineer**, shall submit to the **Engineer** a proposed progress schedule based on the Critical Path Method in the form of a bar graph or in such other form as specified by the **Engineer**, and monthly cash flow requirements, showing:

9.1.1 The anticipated time of commencement and completion of each of the various operations to be performed under this **Contract**; and

9.1.2 The sequence and interrelation of each of these operations with the others and with those of other related contracts; and

9.1.3 The estimated time required for fabrication or delivery, or both, of all materials and equipment required for the **Work**, including the anticipated time for obtaining required approvals pursuant to Article 10; and

9.1.4 The estimated amount in dollars the **Contractor** will claim on a monthly basis.

9.2 The proposed schedule shall be revised as directed by the **Engineer**, until finally approved by the **Engineer**, and after such approval, subject to the provisions of Article 11, shall be strictly adhered to by the **Contractor**.

9.3 If the **Contractor** shall fail to adhere to the approved progress schedule, or to the schedule as revised pursuant to Article 11, it shall promptly adopt such other or additional **Means and Methods of Construction**, at its sole cost and expense, as will make up for the time lost and will assure completion in accordance with the approved progress schedule. The approval by the **City** of a progress schedule which is shorter than the time allotted under the **Contract** shall not create any liability for the **City** if the approved progress schedule is not met.

9.4 The **Contractor** will not receive any payments until the proposed progress schedule is submitted.

ARTICLE 10. REQUESTS FOR INFORMATION OR APPROVAL

10.1 From time to time as the **Work** progresses and in the sequence indicated by the approved progress schedule, the **Contractor** shall submit to the **Engineer** a specific request in writing for each item of information or approval required by the **Contractor**. These requests shall state the latest date upon which the information or approval is actually required by the **Contractor**, and shall be submitted in a reasonable time in advance thereof to provide the **Engineer** a sufficient time to act upon such submissions, or any necessary re-submissions thereof.

10.2 The **Contractor** shall not have any right to an extension of time on account of delays due to the **Contractor's** failure to submit requests for the required information or the required approval in accordance with the above requirements.

ARTICLE 11. NOTICE OF CONDITIONS CAUSING DELAY AND DOCUMENTATION OF DAMAGES CAUSED BY DELAY

11.1 After the commencement of any condition which is causing or may cause a delay in completion of the **Work**, including conditions for which the **Contractor** may be entitled to an extension of time, the following notifications and submittals are required:

11.1.1 Within seven (7) **Days** after the commencement of such condition, the **Contractor** must notify the **Engineer** in writing of the existence, nature and effect of such condition upon the approved progress schedule and the **Work**, and must state why and in what respects, if any, the condition is causing or may cause a delay.

11.1.2 If the **Contractor** shall claim to be sustaining damages for delay as provided for in this Article 11, within forty-five (45) **Days** from the time such damages are first incurred, and every thirty (30) **Days** thereafter for as long as such damages are being incurred, the **Contractor** shall submit to the **Commissioner** verified written statements of the details and the amounts of such damages, together with documentary evidence of such damages, ("statement of delay damages") as further detailed in Article 11.6. The **Contractor** may submit any of the above statements within such additional time as may be granted by the **Commissioner** in writing upon written request therefor. On failure of the **Contractor** to strictly comply with all of the foregoing provisions, such claims shall be deemed waived and no right to recover on such claims shall exist. Damages that the **Contractor** may claim in any action arising under or by reason of this **Contract** shall not be different from or in excess of the statements made and documentation provided pursuant to this Article 11.

11.1.3 Within 60 days of submission of the final verified statement of claims pursuant to Article 44, the **Commissioner** shall make a determination as to whether a compensable delay has occurred and, if so, the amount of compensation due the **Contractor**. Notwithstanding the above, the **Commissioner** may make a determination as to whether a compensable delay has occurred at any time after the **Contractor's** first submission of a statement of delay damages provided, however, that the amount of compensation due to the **Contractor** will not be determined until the **Commissioner** determines that the **Work** is delayed after the date set for substantial completion.

11.2 Failure of the **Contractor** to strictly comply with the requirements of Article 11.1.1 may, in the discretion of the **Commissioner**, be deemed sufficient cause to deny any extension of time on account of delay arising out of such condition. Failure of the **Contractor** to strictly comply with the requirements of Articles 11.1.1 and 11.1.2 shall be deemed a conclusive waiver by the **Contractor** of any and all claims for damages for delay arising from such condition and no right to recover on such claims shall exist.

11.3 When appropriate and directed by the **Engineer**, the progress schedule shall be revised by the **Contractor** until finally approved by the **Engineer**. The revised progress schedule must be strictly adhered to by the **Contractor**.

11.4 Compensable Delays

11.4.1 The **Contractor** agrees to make claim only for additional costs attributable to delay in the performance of this **Contract** necessarily extending the time for completion of the **Work** or resulting from acceleration directed by the **Commissioner** and required to maintain the **Project** schedule, occasioned solely by any act or omission to act of the **City** listed below. The **Contractor** also agrees that delay from any other cause shall be compensated, if at all, solely by an extension of time to complete the performance of the **Work**.

11.4.1.1 The failure of the **City** to take reasonable measures to coordinate and progress the **Work**, except that the **City** shall not be responsible for the **Contractor's** obligation to coordinate and progress the **Work** of its **Subcontractors**.

11.4.1.2 Extended delays attributable to the **City** in the review or issuance of change orders, in shop drawing reviews and approvals or as a result of the cumulative impact of multiple change orders, which have a verifiable impact on **Project** costs.

11.4.1.3 The unavailability of the **Site** for an extended period of time that significantly affects the scheduled completion of the **Contract**.

- 11.4.1.4 The issuance by the **Engineer** of a stop work order relative to a substantial portion of the **Work** for a period exceeding thirty (30) **Days**, that was not brought about through any action or omission of the **Contractor**.
- 11.4.1.5 Differing site conditions that were neither known nor reasonably ascertainable on a pre-bid inspection of the **Site** or review of the bid documents or other publicly available sources, and that are not ordinarily encountered in the **Project's** geographical area or neighborhood or in the type of **Work** to be performed.
- 11.4.1.6 Delays caused by the **City's** bad faith or its willful, malicious, or grossly negligent conduct;
- 11.4.1.7 Delays not contemplated by the parties;
- 11.4.1.8 Delays so unreasonable that they constitute an intentional abandonment of the **Contract** by the **City**; and
- 11.4.1.9 Delays resulting from the **City's** breach of a fundamental obligation of the **Contract**.

11.4.2 No claim may be made for any alleged delay in **Substantial Completion** of the **Work** by a date earlier than the date of **Substantial Completion** provided for in Schedule A unless there is a provision in the **Contract** providing for additional compensation for early completion. No claim may be made for any alleged delay in **Substantial Completion** of the **Work** if the work is substantially completed by the date of **Substantial Completion** provided for in Schedule A unless acceleration has been directed by the **Commissioner** to meet the date of **Substantial Completion** set forth in Schedule A.

11.4.3 The provisions of this Article 11 apply only to claims for additional costs attributable to delay and do not preclude determinations by the **Commissioner** allowing reimbursements for additional costs for **Extra Work** pursuant to Articles 25 and 26 of this **Contract**. To the extent that any cost attributable to delay is reimbursed as part of a change order, no additional claim for compensation under this Article 11 shall be allowed.

11.5 Non-Compensable Delays. The **Contractor** agrees to make no claim for, and is deemed to have included in its bid prices for the various items of the **Contract**, the extra/additional costs attributable to any delays caused by or attributable to the items set forth below. For such items, the **Contractor** shall be compensated, if at all, solely by an extension of time to complete the performance of the **Work**, in accordance with the provisions of Article 13. Such extensions of time will be granted, if at all, pursuant to the grounds set forth in Article 13.3.

11.5.1 The acts or omissions of any third parties, including but not limited to **Other Contractors**, public/ governmental bodies (other than **City Agencies**), utilities or private enterprises, who are disclosed in the **Contract Documents** or are ordinarily encountered or generally recognized as related to the **Work**;

11.5.2 Any situation which was within the contemplation of the parties at the time of entering into the **Contract**, including any delay indicated or disclosed in the **Contract Documents** or generally recognized as related to the nature of the **Work**, and/or the existence of any facility or appurtenance owned, operated or maintained by any third party, as indicated or disclosed in the **Contract Documents** or ordinarily encountered or generally recognized as related to the nature of the **Work**;

11.5.3 Restraining orders, injunctions or judgments issued by a court which were caused by a Contractor's submission, action or inaction or by a Contractor's **Means and Methods of**

Construction, or by third parties, unless such order, injunction or judgment was the result of an action or omission by the **City**;

11.5.4 Any labor boycott, strike, picketing, lockout or similar situation;

11.5.5 Any shortages of supplies or materials, or unavailability of equipment, required by the **Contract Work**;

11.5.6 Climatic conditions, storms, floods, droughts, tidal waves, fires, hurricanes, earthquakes, landslides or other catastrophes or acts of God, or acts of war or of the public enemy or terrorist acts, including the **City's** reasonable responses thereto; and

11.5.7 **Extra Work** which does not significantly affect the overall completion of the **Contract**, reasonable delays in the review or issuance of change orders or field orders and/or in shop drawing reviews or approvals.

11.6 Required Content of Submission of Statement of Delay Damages

11.6.1 In the verified written statement of delay damages required by Article 11.1.2, the following information shall be provided by the **Contractor**:

11.6.1.1 For each delay, the start and end dates of the claimed periods of delay and, in addition, a description of the operations that were delayed, an explanation of how they were delayed, and the reasons for the delay, including identifying the applicable act or omission of the **City** listed in Article 11.4.

11.6.1.2 A detailed factual statement of the claim providing all necessary dates, locations and items of **Work** affected by the claim.

11.6.1.3 The amount of additional compensation sought and a breakdown of that amount into categories as described in Article 26.2, subject to the limitations set forth in Article 11.7.

11.6.1.4 Any additional information requested by the **Commissioner**.

11.7 Recoverable Costs

11.7.1 Delay damages may be recoverable for the following costs actually and necessarily incurred in the performance of the **Work**:

11.7.1.1 Direct labor, including payroll taxes (subject to statutory wage caps) and supplemental benefits, based on time and materials records;

11.7.1.2 Necessary materials (including transportation to the **Site**), based on time and material records;

11.7.1.3 Reasonable rental value of necessary plant and equipment other than small tools, plus fuel/energy costs according to the applicable formula set forth in Articles 26.2.4 and/or 26.2.8, based on time and material records;

11.7.1.4 Insurance and bond costs;

11.7.1.5 Extended field office costs;

11.7.1.6 Extended **Site** overhead; and

11.7.1.7 Extended home office overhead.

11.7.2 Recoverable Subcontractor Costs. When the **Work** is performed by a **Subcontractor**, the **Contractor** may be paid the actual and necessary costs of such subcontracted **Work** as outlined above in Articles 11.7.1.1 through 11.7.1.6, and an

additional overhead of five (5%) percent of the costs outlined in Articles 11.7.1.1 through 11.7.1.3.

11.7.3 Non-Recoverable Costs. The parties agree that the **City** will have no liability for the following items and the **Contractor** agrees it shall make no claim for the following items:

- 11.7.3.1 Profit, or loss of anticipated or unanticipated profit;
- 11.7.3.2 Consequential damages, including but not limited to interest on monies in dispute, including interest which is paid on such monies, loss of bonding capacity, bidding opportunities, or interest in investment, or any resulting insolvency;
- 11.7.3.3 Indirect costs or expenses of any nature;
- 11.7.3.4 Direct or indirect costs attributable to performance of **Work** where the **Contractor**, because of situations or conditions within its control, has not progressed the **Work** in a satisfactory manner; and
- 11.7.3.5 Attorneys' fees and dispute and claims preparation expenses.

11.8 Determinations under this Article 11 are not subject to the jurisdiction of the Contract Dispute Resolution Board pursuant to the dispute resolution process set forth in Article 27.

11.9 If the parties agree, pursuant to Article 11.1.3 above, that a compensable delay has occurred and agree on the amount of compensation, payment may be made pursuant to a written change order. Payment pursuant to such change order is subject to pre-audit by the **Engineering Audit Officer**, and may be post-audited by the **Comptroller** and/or the **Agency**.

ARTICLE 12. COORDINATION WITH OTHER CONTRACTORS

12.1 During the progress of the **Work**, **Other Contractors** may be engaged in performing other work or may be awarded other contracts for additional work on this **Project**. In that event, the **Contractor** shall coordinate the **Work** to be done hereunder with the work of such **Other Contractors** and the **Contractor** shall fully cooperate with such **Other Contractors** and carefully fit its own **Work** to that provided under other contracts as may be directed by the **Engineer**. The **Contractor** shall not commit or permit any act which will interfere with the performance of work by any **Other Contractors**.

12.2 If the **Engineer** determines that the **Contractor** is failing to coordinate its **Work** with the work of **Other Contractors** as the **Engineer** has directed, then the **Commissioner** shall have the right to withhold any payments otherwise due hereunder until the **Contractor** completely complies with the **Engineer's** directions.

12.3 The **Contractor** shall notify the **Engineer** in writing if any **Other Contractor** on this **Project** is failing to coordinate its work with the **Work** of this **Contract**. If the **Engineer** finds such charges to be true, the **Engineer** shall promptly issue such directions to the **Other Contractor** with respect thereto as the situation may require. The **City** shall not, however, be liable for any damages suffered by any **Other Contractor's** failure to coordinate its work with the **Work** of this **Contract** or by reason of the **Other Contractor's** failure to promptly comply with the directions so issued by the **Engineer**, or by reason of any **Other Contractor's** default in performance, it being understood that the **City** does not guarantee the responsibility or continued efficiency of any contractor. The **Contractor** agrees to make no claim against

the **City** for any damages relating to or arising out of any directions issued by the **Engineer** pursuant to this Article 12 (including but not limited to the failure of any **Other Contractor** to comply or promptly comply with such directions), or the failure of the **Engineer** to issue any directions, or the failure of any **Other Contractor** to coordinate its work, or the default in performance of any **Other Contractor**.

12.4 The **Contractor** shall indemnify and hold the **City** harmless from any and all claims or judgments for damages and from costs and expenses to which the **City** may be subjected or which it may suffer or incur by reason of the **Contractor's** failure to comply with the **Engineer's** directions promptly; and the **Comptroller** shall have the right to exercise the powers reserved in Article 23 with respect to any claims which may be made for damages due to the **Contractor's** failure to comply with the **Engineer's** directions promptly. Insofar as the facts and **Law** relating to any claim would preclude the **City** from being completely indemnified by the **Contractor**, the **City** shall be partially indemnified by the **Contractor** to the fullest extent provided by **Law**.

12.5 Should the **Contractor** sustain any damage through any act or omission of any **Other Contractor** having a contract with the **City** for the performance of work upon the **Site** or of work which may be necessary to be performed for the proper prosecution of the **Work** to be performed hereunder, or through any act or omission of a subcontractor of such **Other Contractor**, the **Contractor** shall have no claim against the **City** for such damage, but shall have a right to recover such damage from the **Other Contractor** under the provision similar to the following provisions which apply to this **Contract** and have been or will be inserted in the contracts with such **Other Contractors**:

12.5.1 Should any **Other Contractor** having or who shall hereafter have a contract with the **City** for the performance of work upon the **Site** sustain any damage through any act or omission of the **Contractor** hereunder or through any act or omission of any **Subcontractor** of the **Contractor**, the **Contractor** agrees to reimburse such **Other Contractor** for all such damages and to defend at its own expense any action based upon such claim and if any judgment or claim (even if the allegations of the action are without merit) against the **City** shall be allowed the **Contractor** shall pay or satisfy such judgment or claim and pay all costs and expenses in connection therewith and agrees to indemnify and hold the **City** harmless from all such claims. Insofar as the facts and **Law** relating to any claim would preclude the **City** from being completely indemnified by the **Contractor**, the **City** shall be partially indemnified by the **Contractor** to the fullest extent provided by **Law**.

12.6 The **City's** right to indemnification hereunder shall in no way be diminished, waived or discharged by its recourse to assessment of liquidated damages as provided in Article 15, or by the exercise of any other remedy provided for by **Contract** or by **Law**.

ARTICLE 13. EXTENSION OF TIME FOR PERFORMANCE

13.1 If performance by the **Contractor** is delayed for a reason set forth in Article 13.3, the **Contractor** may be allowed a reasonable extension of time in conformance with this Article 13 and the **PPB Rules**.

13.2 Any extension of time may be granted only by the **ACCO** or by the Board for the Extension of Time (hereafter "Board") (as set forth below) upon written application by the **Contractor**.

13.3 Grounds for Extension: If such application is made, the **Contractor** shall be entitled to an extension of time for delay in completion of the **Work** caused solely:

13.3.1 By the acts or omissions of the **City**, its officials, agents or employees; or

13.3.2 By the act or omissions of **Other Contractors** on this **Project**; or

13.3.3 By supervening conditions entirely beyond the control of either party hereto (such as, but not limited to, acts of God or the public enemy, excessive inclement weather, war or other national emergency making performance temporarily impossible or illegal, or strikes or labor disputes not brought about by any act or omission of the **Contractor**).

13.3.4 The **Contractor** shall, however, be entitled to an extension of time for such causes only for the number of **Days** of delay which the **ACCO** or the Board may determine to be due solely to such causes, and then only if the **Contractor** shall have strictly complied with all of the requirements of Articles 9 and 10.

13.4 The **Contractor** shall not be entitled to receive a separate extension of time for each of several causes of delay operating concurrently, but, if at all, only for the actual period of delay in completion of the **Work** as determined by the **ACCO** or the Board, irrespective of the number of causes contributing to produce such delay. If one of several causes of delay operating concurrently results from any act, fault or omission of the **Contractor** or of its **Subcontractors** or **Materialmen**, and would of itself (irrespective of the concurrent causes) have delayed the **Work**, no extension of time will be allowed for the period of delay resulting from such act, fault or omission.

13.5 The determination made by the **ACCO** or the Board on an application for an extension of time shall be binding and conclusive on the **Contractor**.

13.6 The **ACCO** or the Board acting entirely within their discretion may grant an application for an extension of time for causes of delay other than those herein referred.

13.7 Permitting the **Contractor** to continue with the **Work** after the time fixed for its completion has expired, or after the time to which such completion may have been extended has expired, or the making of any payment to the **Contractor** after such time, shall in no way operate as a waiver on the part of the **City** of any of its rights under this **Contract**.

13.8 Application for Extension of Time:

13.8.1 Before the **Contractor's** time extension request will be considered, the **Contractor** shall notify the **ACCO** of the condition which allegedly has caused or is causing the delay, and shall submit a written application to the **ACCO** identifying:

13.8.1(a) The **Contractor**; the registration number; and **Project** description;

13.8.1(b) Liquidated damage assessment rate, as specified in the **Contract**;

13.8.1(c) Original total bid price;

13.8.1(d) The original **Contract** start date and completion date;

13.8.1(e) Any previous time extensions granted (number and duration); and

13.8.1(f) The extension of time requested.

13.8.2 In addition, the application for extension of time shall set forth in detail:

13.8.2(a) The nature of each alleged cause of delay in completing the **Work**;

13.8.2(b) The date upon which each such cause of delay began and ended and the number of **Days** attributable to each such cause;

13.8.2(c) A statement that the **Contractor** waives all claims except for those delineated in the application, and the particulars of any claims which the **Contractor** does not agree to waive. For time extensions for **Substantial Completion** and final completion payments, the application shall include a detailed statement of the dollar amounts of each element of claim item reserved; and

13.8.2(d) A statement indicating the **Contractor's** understanding that the time extension is granted only for purposes of permitting continuation of **Contract** performance and payment for **Work** performed and that the **City** retains its right to conduct an investigation and assess liquidated damages as appropriate in the future.

13.9 Analysis and Approval of Time Extensions:

13.9.1 For time extensions for partial payments, a written determination shall be made by the **ACCO** who may, for good and sufficient cause, extend the time for the performance of the **Contract** as follows:

13.9.1(a) If the **Work** is to be completed within six (6) months, the time for performance may be extended for sixty (60) **Days**;

13.9.1(b) If the **Work** is to be completed within less than one (1) year but more than six (6) months, an extension of ninety (90) **Days** may be granted;

13.9.1(c) If the **Contract** period exceeds one (1) year, besides the extension granted in Article 13.9.1(b), an additional thirty (30) **Days** may be granted for each multiple of six (6) months involved beyond the one (1) year period; or

13.9.1(d) If exceptional circumstances exist, the **ACCO** may extend the time for performance beyond the extensions in Articles 13.9.1(a), 13.9.1(b), and 13.9.1(c). In that event, the **ACCO** shall file with the Mayor's Office of Contract Services a written explanation of the exceptional circumstances.

13.9.2 For extensions of time for **Substantial Completion** and final completion payments, the **Engineer**, in consultation with the **ACCO**, shall prepare a written analysis of the delay (including a preliminary determination of the causes of delay, the beginning and end dates for each such cause of delay, and whether the delays are excusable under the terms of this **Contract**). The report shall be subject to review by and approval of the Board, which shall have authority to question its analysis and determinations and request additional facts or documentation. The report as reviewed and made final by the Board shall be made a part of the **Agency** contract file. Neither the report itself nor anything contained therein shall operate as a waiver or release of any claim the **City** may have against the **Contractor** for either actual or liquidated damages.

13.9.3 Approval Mechanism for Time Extensions for **Substantial Completion** or Final Completion Payments: An extension shall be granted only with the approval of the Board which is comprised of the **ACCO** of the **Agency**, the **City** Corporation Counsel, and the **Comptroller**, or their authorized representatives.

13.9.4 Neither the granting of any application for an extension of time to the **Contractor** or any **Other Contractor** on this **Project** nor the papers, records or reports related to any application for or grant of an extension of time or determination related thereto shall be referred to or offered in evidence by the **Contractor** or its attorneys in any action or proceeding.

13.10 No Damage for Delay: The **Contractor** agrees to make no claim for damages for delay in the performance of this **Contract** occasioned by any act or omission to act of the **City** or any of its representatives, except as provided for in Article 11.

ARTICLE 14. COMPLETION AND FINAL ACCEPTANCE OF THE WORK

14.1 Date for **Substantial Completion**: The **Contractor** shall substantially complete the **Work** within the time fixed in Schedule A of the General Conditions, or within the time to which such **Substantial Completion** may be extended.

14.2 Determining the Date of **Substantial Completion**: The **Work** will be deemed to be substantially complete when the two conditions set forth below have been met.

14.2.1 Inspection: The **Engineer** has inspected the **Work** and has made a written determination that it is substantially complete.

14.2.2 Approval of **Final Approved Punch List** and Date for **Final Acceptance**: Following inspection of the **Work**, the **Engineer** shall furnish the **Contractor** with a final punch list, specifying all items of **Work** to be completed and proposing dates for the completion of each specified item of **Work**. The **Contractor** shall then submit in writing to the **Engineer** within ten (10) **Days** of the **Engineer** furnishing the final punch list either acceptance of the dates or proposed alternative dates for the completion of each specified item of **Work**. If the **Contractor** proposes alternative dates, then, within a reasonable time after receipt, the **Engineer**, in a written notification to the **Contractor**, shall approve the **Contractor's** completion dates or, if they are unable to agree, the **Engineer** shall establish dates for the completion of each item of **Work**. If the **Contractor** neither accepts the dates nor proposes alternative dates within ten (10) **Days**, the schedule proposed by the **Engineer** shall be deemed accepted. The latest completion date specified shall be the date for **Final Acceptance** of the **Work**.

14.3 Date of **Substantial Completion**. The date of approval of the **Final Approved Punch List**, shall be the date of **Substantial Completion**. The date of approval of the **Final Approved Punch List** shall be either (a) if the **Contractor** approves the final punch list and proposed dates for completion furnished by the **Engineer**, the date of the **Contractor's** approval; or (b) if the **Contractor** neither accepts the dates nor proposes alternative dates, ten (10) **Days** after the **Engineer** furnishes the **Contractor** with a final punch list and proposed dates for completion; or (c) if the **Contractor** proposes alternative dates, the date that the **Engineer** sends written notification to the **Contractor** either approving the **Contractor's** proposed alternative dates or establishing dates for the completion for each item of **Work**.

14.4 Determining the Date of **Final Acceptance**: The **Work** will be accepted as final and complete as of the date of the **Engineer's** inspection if, upon such inspection, the **Engineer** finds that all items on the **Final Approved Punch List** are complete and no further **Work** remains to be done. The **Commissioner** will then issue a written determination of **Final Acceptance**.

14.5 Request for Inspection: Inspection of the **Work** by the **Engineer** for the purpose of **Substantial Completion** or **Final Acceptance** shall be made within ten (10) **Days** after receipt of the **Contractor's** written request therefor.

14.6 Request for Re-inspection: If upon inspection for the purpose of **Substantial Completion** or **Final Acceptance**, the **Engineer** determines that there are items of **Work** still to be performed, the **Contractor** shall promptly perform them and then request a re-inspection. If upon re-inspection, the **Engineer** determines that the **Work** is substantially complete or finally accepted, the date of such re-inspection shall be the date of **Substantial Completion** or **Final Acceptance**. Re-inspection by the **Engineer** shall be made within ten (10) **Days** after receipt of the **Contractor's** written request therefor.

14.7 Initiation of Inspection by the **Engineer**: If the **Contractor** does not request inspection or re-inspection of the **Work** for the purpose of **Substantial Completion** or **Final Acceptance**, the **Engineer** may initiate such inspection or re-inspection.

ARTICLE 15. LIQUIDATED DAMAGES

15.1 In the event the **Contractor** fails to substantially complete the **Work** within the time fixed for such **Substantial Completion** in Schedule A of the General Conditions, plus authorized time extensions, or if the **Contractor**, in the sole determination of the **Commissioner**, has abandoned the **Work**, the **Contractor** shall pay to the **City** the sum fixed in Schedule A of the General Conditions, for each and every **Day** that the time consumed in substantially completing the **Work** exceeds the time allowed therefor; which said sum, in view of the difficulty of accurately ascertaining the loss which the **City** will suffer by reason of delay in the **Substantial Completion** of the **Work** hereunder, is hereby fixed and agreed as the liquidated damages that the **City** will suffer by reason of such delay, and not as a penalty. This Article 15 shall also apply to the **Contractor** whether or not the **Contractor** is defaulted pursuant to Chapter X of this **Contract**. Neither the failure to assess liquidated damages nor the granting of any time extension shall operate as a waiver or release of any claim the **City** may have against the **Contractor** for either actual or liquidated damages.

15.2 Liquidated damages received hereunder are not intended to be nor shall they be treated as either a partial or full waiver or discharge of the **City's** right to indemnification, or the **Contractor's** obligation to indemnify the **City**, or to any other remedy provided for in this **Contract** or by **Law**.

15.3 The **Commissioner** may deduct and retain out of the monies which may become due hereunder, the amount of any such liquidated damages; and in case the amount which may become due hereunder shall be less than the amount of liquidated damages suffered by the **City**, the **Contractor** shall be liable to pay the difference.

ARTICLE 16. OCCUPATION OR USE PRIOR TO COMPLETION

16.1 Unless otherwise provided for in the **Specifications**, the **Commissioner** may take over, use, occupy or operate any part of the **Work** at any time prior to **Final Acceptance**, upon written notification to the **Contractor**. The **Engineer** shall inspect the part of the **Work** to be taken over, used, occupied, or operated, and will furnish the **Contractor** with a written statement of the **Work**, if any, which remains to be performed on such part. The **Contractor** shall not object to, nor interfere with, the **Commissioner's** decision to exercise the rights granted by Article 16. In the event the **Commissioner** takes over, uses, occupies, or operates any part of the **Work**:

16.1.1 the **Engineer** shall issue a written determination of **Substantial Completion** with respect to such part of the **Work**;

16.1.2 the **Contractor** shall be relieved of its absolute obligation to protect such part of the unfinished **Work** in accordance with Article 7;

16.1.3 the **Contractor's** guarantee on such part of the **Work** shall begin on the date of such use by the **City**; and;

16.1.4 the **Contractor** shall be entitled to a return of so much of the amount retained in accordance with Article 21 as it relates to such part of the **Work**, except so much thereof as may be retained under Articles 24 and 44.

CHAPTER IV SUBCONTRACTS AND ASSIGNMENTS

ARTICLE 17. SUBCONTRACTS

17.1 The **Contractor** shall not make subcontracts totaling an amount more than the percentage of the total **Contract** price fixed in Schedule A of the General Conditions, without prior written permission from the **Commissioner**. All subcontracts made by the **Contractor** shall be in writing. No **Work** may be performed by a **Subcontractor** prior to the **Contractor** entering into a written subcontract with the **Subcontractor** and complying with the provisions of this Article 17.

17.2 Before making any subcontracts, the **Contractor** shall submit a written statement to the **Commissioner** giving the name and address of the proposed **Subcontractor**; the portion of the **Work** and materials which it is to perform and furnish; the cost of the subcontract; the VENDEX questionnaire if required; the proposed subcontract if requested by the **Commissioner**; and any other information tending to prove that the proposed **Subcontractor** has the necessary facilities, skill, integrity, past experience, and financial resources to perform the **Work** in accordance with the terms and conditions of this **Contract**.

17.3 In addition to the requirements in Article 17.2, **Contractor** is required to list the **Subcontractor** in the web based Subcontractor Reporting System through the City's Payee Information Portal (PIP), available at www.nyc.gov/pip.¹ For each **Subcontractor** listed, **Contractor** is required to provide the following information: maximum contract value, description of **Subcontractor's** Work, start and end date of the subcontract and identification of the **Subcontractor's** industry. Thereafter, **Contractor** will be required to report in the system the payments made to each **Subcontractor** within 30 days of making the payment. If any of the required information changes throughout the Term of the **Contract**, **Contractor** will be required to revise the information in the system.

Failure of the **Contractor** to list a **Subcontractor** and/or to report **Subcontractor** payments in a timely fashion may result in the **Commissioner** declaring the **Contractor** in default of the **Contract** and will subject **Contractor** to liquidated damages in the amount of \$100 per day for each day that the **Contractor** fails to identify a **Subcontractor** along with the required information about the **Subcontractor** and/or fails to report payments to a **Subcontractor**, beyond the time frames set forth herein or in the notice from the **City**. Article 15 shall govern the issue of liquidated damages.

¹ In order to use the new system, a PIP account will be required. Detailed instructions on creating a PIP account and using the new system are also available at www.nyc.gov/pip. Additional assistance with PIP may be obtained by emailing the Financial Information Services Agency Help Desk at pip@fisa.nyc.gov.

17.4 If an approved **Subcontractor** elects to subcontract any portion of its subcontract, the proposed sub-subcontract shall be submitted in the same manner as directed above.

17.5 The **Commissioner** will notify the **Contractor** in writing whether the proposed **Subcontractor** is approved. If the proposed **Subcontractor** is not approved, the **Contractor** may submit another proposed **Subcontractor** unless the **Contractor** decides to do the **Work**. No **Subcontractor** shall be permitted to enter or perform any work on the **Site** unless approved.

17.6 Before entering into any subcontract hereunder, the **Contractor** shall provide the proposed **Subcontractor** with a complete copy of this document and inform the proposed **Subcontractor** fully and completely of all provisions and requirements of this **Contract** relating either directly or indirectly to the **Work** to be performed and the materials to be furnished under such subcontract, and every such **Subcontractor** shall expressly stipulate that all labor performed and materials furnished by the **Subcontractor** shall strictly comply with the requirements of this **Contract**.

17.7 Documents given to a prospective **Subcontractor** for the purpose of soliciting the **Subcontractor's** bid shall include either a copy of the bid cover or a separate information sheet setting forth the **Project** name, the **Contract** number (if available), the **Agency** (as noted in Article 2.1.6), and the **Project's** location.

17.8 The **Commissioner's** approval of a **Subcontractor** shall not relieve the **Contractor** of any of its responsibilities, duties, and liabilities hereunder. The **Contractor** shall be solely responsible to the **City** for the acts or defaults of its **Subcontractor** and of such **Subcontractor's** officers, agents, and employees, each of whom shall, for this purpose, be deemed to be the agent or employee of the **Contractor** to the extent of its subcontract.

17.9 If the **Subcontractor** fails to maintain the necessary facilities, skill, integrity, past experience, and financial resources (other than due to the **Contractor's** failure to make payments where required) to perform the **Work** in accordance with the terms and conditions of this **Contract**, the **Contractor** shall promptly notify the **Commissioner** and replace such **Subcontractor** with a newly approved **Subcontractor** in accordance with this Article 17.

17.10 The **Contractor** shall be responsible for ensuring that all **Subcontractors** performing **Work** at the **Site** maintain all insurance required by **Law**.

17.11 The **Contractor** shall promptly, upon request, file with the **Engineer** a conformed copy of the subcontract and its cost. The subcontract shall provide the following:

17.11.1 **Payment to Subcontractors:** The agreement between the **Contractor** and its **Subcontractor** shall contain the same terms and conditions as to method of payment for **Work**, labor, and materials, and as to retained percentages, as are contained in this **Contract**.

17.11.2 **Prevailing Rate of Wages:** The agreement between the **Contractor** and its **Subcontractor** shall include the prevailing wage rates and supplemental benefits to be paid in accordance with Labor Law Section 220.

17.11.3 **Section 6-123 of the Administrative Code:** Pursuant to the requirements of Section 6-123 of the Administrative Code, every agreement between the **Contractor** and a **Subcontractor** in excess of fifty thousand (\$50,000) dollars shall include a provision that the **Subcontractor** shall not engage in any unlawful discriminatory practice as defined in Title VIII of the Administrative Code (Section 8-101 *et seq.*).

17.11.4 All requirements required pursuant to federal and/or state grant agreement(s), if applicable to the **Work**.

17.12 The **Commissioner** may deduct from the amounts certified under this **Contract** to be due to the **Contractor**, the sum or sums due and owing from the **Contractor** to the **Subcontractors** according to the terms of the said subcontracts, and in case of dispute between the **Contractor** and its **Subcontractor**, or **Subcontractors**, as to the amount due and owing, the **Commissioner** may deduct and withhold from the amounts certified under this **Contract** to be due to the **Contractor** such sum or sums as may be claimed by such **Subcontractor**, or **Subcontractors**, in a sworn affidavit, to be due and owing until such time as such claim or claims shall have been finally resolved.

17.13 On contracts where performance bonds and payment bonds are executed, the **Contractor** shall include on each requisition for payment the following data: **Subcontractor's** name, value of the subcontract, total amount previously paid to **Subcontractor** for **Work** previously requisitioned, and the amount, including retainage, to be paid to the **Subcontractor** for **Work** included in the requisition.

17.14 On **Contracts** where performance bonds and payment bonds are not executed, the **Contractor** shall include with each requisition for payment submitted hereunder, a signed statement from each and every **Subcontractor** and/or **Materialman** for whom payment is requested in such requisition. Such signed statement shall be on the letterhead of the **Subcontractor** and/or **Materialman** for whom payment is requested and shall (i) verify that such **Subcontractor** and/or **Materialman** has been paid in full for all **Work** performed and/or material supplied to date, exclusive of any amount retained and any amount included on the current requisition, and (ii) state the total amount of retainage to date, exclusive of any amount retained on the current requisition.

ARTICLE 18. ASSIGNMENTS

18.1 The **Contractor** shall not assign, transfer, convey or otherwise dispose of this **Contract**, or the right to execute it, or the right, title or interest in or to it or any part thereof, or assign, by power of attorney or otherwise any of the monies due or to become due under this **Contract**, unless the previous written consent of the **Commissioner** shall first be obtained thereto, and the giving of any such consent to a particular assignment shall not dispense with the necessity of such consent to any further or other assignments.

18.2 Such assignment, transfer, conveyance or other disposition of this **Contract** shall not be valid until filed in the office of the **Commissioner** and the **Comptroller**, with the written consent of the **Commissioner** endorsed thereon or attached thereto.

18.3 Failure to obtain the previous written consent of the **Commissioner** to such an assignment, transfer, conveyance or other disposition, may result in the revocation and annulment of this **Contract**. The **City** shall thereupon be relieved and discharged from any further liability to the **Contractor**, its assignees, transferees or sublessees, who shall forfeit and lose all monies therefor earned under the **Contract**, except so much as may be required to pay the **Contractor's** employees.

18.4 The provisions of this clause shall not hinder, prevent, or affect an assignment by the **Contractor** for the benefit of its creditors made pursuant to the **Laws** of the State of New York.

18.5 This **Contract** may be assigned by the **City** to any corporation, agency or instrumentality having authority to accept such assignment.

**CHAPTER V
CONTRACTOR'S SECURITY AND GUARANTEE**

ARTICLE 19. SECURITY DEPOSIT

19.1 If performance and payment bonds are required, the City shall retain the bid security to ensure that the successful bidder executes the **Contract** and furnishes the required payment and performance security within ten (10) **Days** after notice of the award of the **Contract**. If the successful bidder fails to execute the **Contract** and furnish the required payment and performance security, the City shall retain such bid security as set forth in the Information for Bidders. If the successful bidder executes the **Contract** and furnishes the required payment and performance security, the City shall return the bid security within a reasonable time after the furnishing of such bonds and execution of the **Contract** by the City.

19.2 If performance and payment bonds are not required, the bid security shall be retained by the City as security for the Contractor's faithful performance of the **Contract**. If partial payments are provided, the bid security will be returned to the Contractor after the sum retained under Article 21 equals the amount of the bid security, subject to other provisions of this **Contract**. If partial payments are not provided, the bid security will be released when final payment is certified by the City for payment.

19.3 If the Contractor is declared in default under Article 48 prior to the return of the deposit, or if any claim is made such as referred to in Article 23, the amount of such deposit, or so much thereof as the Comptroller may deem necessary, may be retained and then applied by the Comptroller:

19.3.1 To compensate the City for any expense, loss or damage suffered or incurred by reason of or resulting from such default, including the cost of re-letting and liquidated damages; or

19.3.2 To indemnify the City against any and all claims.

ARTICLE 20. PAYMENT GUARANTEE

20.1 On **Contracts** where one hundred (100%) percent performance bonds and payment bonds are executed, this Article 20 does not apply.

20.2 In the event the terms of this **Contract** do not require the Contractor to provide a payment bond or where the **Contract** does not require a payment bond for one hundred (100%) percent of the **Contract** price, the City shall, in accordance with the terms of this Article 20, guarantee payment of all lawful claims for:

20.2.1 Wages and compensation for labor performed and/or services rendered; and

20.2.2 Materials, equipment, and supplies provided, whether incorporated into the **Work** or not, when demands have been filed with the City as provided hereinafter by any person, firm, or corporation which furnished labor, material, equipment, supplies, or any combination thereof, in connection with the **Work** performed hereunder (hereinafter referred to as the "beneficiary") at the direction of the City or the Contractor.

20.3 The provisions of Article 20.2 are subject to the following limitations and conditions:

20.3.1 If the **Contractor** provides a payment bond for a value that is less than one hundred (100%) percent of the value of the **Contract Work**, the payment bond provided by the **Contractor** shall be primary (and non-contributing) to the payment guarantee provided under this Article 20.

20.3.2 The guarantee is made for the benefit of all beneficiaries as defined in Article 20.2 provided that those beneficiaries strictly adhere to the terms and conditions of Article 20.3.4 and 20.3.5.

20.3.3 Nothing in this Article 20 shall prevent a beneficiary providing labor, services or material for the **Work** from suing the **Contractor** for any amounts due and owing the beneficiary by the **Contractor**.

20.3.4 Every person who has furnished labor or material, to the **Contractor** or to a **Subcontractor** of the **Contractor**, in the prosecution of the **Work** and who has not been paid in full therefor before the expiration of a period of ninety (90) **Days** after the date on which the last of the labor was performed or material was furnished by him/her for which the claim is made, shall have the right to sue on this payment guarantee in his/her own name for the amount, or the balance thereof, unpaid at the time of commencement of the action; provided, however, that a person having a direct contractual relationship with a **Subcontractor** of the **Contractor** but no contractual relationship express or implied with the **Contractor** shall not have a right of action upon the guarantee unless he/she shall have given written notice to the **Contractor** within one hundred twenty (120) **Days** from the date on which the last of the labor was performed or the last of the material was furnished, for which his/her claim is made, stating with substantial accuracy the amount claimed and the name of the party to whom the material was furnished or for whom the labor was performed. The notice shall be served by delivering the same personally to the **Contractor** or by mailing the same by registered mail, postage prepaid, in an envelope addressed to the **Contractor** at any place where it maintains an office or conducts its business; provided, however, that where such notice is actually received by the **Contractor** by other means, such notice shall be deemed sufficient.

20.3.5 Except as provided in Labor Law Section 220-g, no action on this payment guarantee shall be commenced after the expiration of the one-year limitations period set forth in Section 137(4)(b) of the State Finance Law.

20.3.6 The **Contractor** shall promptly forward to the **City** any notice or demand received pursuant to Article 20.3.4. The **Contractor** shall inform the **City** of any defenses to the notice or demand and shall forward to the **City** any documents the **City** requests concerning the notice or demand.

20.3.7 All demands made against the **City** by a beneficiary of this payment guarantee shall be presented to the **Engineer** along with all written documentation concerning the demand which the **Engineer** deems reasonably appropriate or necessary, which may include, but shall not be limited to: the subcontract; any invoices presented to the **Contractor** for payment; the notarized statement of the beneficiary that the demand is due and payable, that a request for payment has been made of the **Contractor** and that the demand has not been paid by the **Contractor** within the time allowed for such payment by the subcontract; and copies of any correspondence between the beneficiary and the **Contractor** concerning such demand. The **City** shall notify the **Contractor** that a demand has been made. The **Contractor** shall inform the **City** of any defenses to the demand and shall forward to the **City** any documents the **City** requests concerning the demand.

20.3.8 The **City** shall make payment only if, after considering all defenses presented by the **Contractor**, it determines that the payment is due and owing to the beneficiary making the demand.

20.3.9 No beneficiary shall be entitled to interest from the **City**, or to any other costs, including, but not limited to, attorneys' fees, except to the extent required by State Finance Law Section 137.

20.4 Upon the receipt by the **City** of a demand pursuant to this Article 20, the **City** may withhold from any payment otherwise due and owing to the **Contractor** under this **Contract** an amount sufficient to satisfy the demand.

20.4.1 In the event the **City** determines that the demand is valid, the **City** shall notify the **Contractor** of such determination and the amount thereof and direct the **Contractor** to immediately pay such amount to the beneficiary. In the event the **Contractor**, within seven (7) **Days** of receipt of such notification from the **City**, fails to pay the beneficiary, such failure shall constitute an automatic and irrevocable assignment of payment by the **Contractor** to the beneficiary for the amount of the demand determined by the **City** to be valid. The **Contractor**, without further notification or other process, hereby gives its unconditional consent to such assignment of payment to the beneficiary and authorizes the **City**, on its behalf, to take all necessary actions to implement such assignment of payment, including without limitation the execution of any instrument or documentation necessary to effectuate such assignment.

20.4.2 In the event that the amount otherwise due and owing to the **Contractor** by the **City** is insufficient to satisfy such demand, the **City** may, at its option, require payment from the **Contractor** of an amount sufficient to cover such demand and exercise any other right to require or recover payment which the **City** may have under **Law** or **Contract**.

20.4.3 In the event the **City** determines that the demand is invalid, any amount withheld pending the **City's** review of such demand shall be paid to the **Contractor**; provided, however, no lien has been filed. In the event a claim or an action has been filed, the terms and conditions set forth in Article 23 shall apply. In the event a lien has been filed, the parties will be governed by the provisions of the Lien Law of the State of New York.

20.5 The provisions of this Article 20 shall not prevent the **City** and the **Contractor** from resolving disputes in accordance with the **PPB** Rules, where applicable.

20.6 In the event the **City** determines that the beneficiary is entitled to payment pursuant to this Article 20, such determination and any defenses and counterclaims raised by the **Contractor** shall be taken into account in evaluating the **Contractor's** performance.

20.7 Nothing in this Article 20 shall relieve the **Contractor** of the obligation to pay the claims of all persons with valid and lawful claims against the **Contractor** relating to the **Work**.

20.8 The **Contractor** shall not require any performance, payment or other bonds of any **Subcontractor** if this **Contract** does not require such bonds of the **Contractor**.

20.9 The payment guarantee made pursuant to this Article 20 shall be construed in a manner consistent with Section 137 of the State Finance Law and shall afford to persons furnishing labor or materials to the **Contractor** or its **Subcontractors** in the prosecution of the **Work** under this **Contract** all of the rights and remedies afforded to such persons by such section, including but not limited to, the right

to commence an action against the City on the payment guarantee provided by this Article 20 within the one-year limitations period set forth in Section 137(4)(b).

ARTICLE 21. RETAINED PERCENTAGE

21.1 If this **Contract** requires one hundred (100%) percent performance and payment security, then as further security for the faithful performance of this **Contract**, the **Commissioner** shall deduct, and retain until the substantial completion of the **Work**, five (5%) percent of the value of **Work** certified for payment in each partial payment voucher.

21.2 If this **Contract** does not require one hundred (100%) percent performance and payment security and if the price for which this **Contract** was awarded does not exceed one million (\$1,000,000) dollars, then as further security for the faithful performance of this **Contract**, the **Commissioner** shall deduct, and retain until the substantial completion of the **Work**, five (5%) percent of the value of **Work** certified for payment in each partial payment voucher.

21.3 If this **Contract** does not require one hundred (100%) percent performance and payment security and if the price for which this **Contract** was awarded exceeds one million (\$1,000,000) dollars, then as further security for the faithful performance of this **Contract**, the **Commissioner** shall deduct, and retain until the substantial completion of the **Work**, up to ten (10%) percent of the value of **Work** certified for payment in each partial payment voucher. The percentage to be retained is set forth in Schedule A of the General Conditions.

ARTICLE 22. INSURANCE

22.1 Types of Insurance: The **Contractor** shall procure and maintain the following types of insurance if, and as indicated, in Schedule A of the General Conditions (with the minimum limits and special conditions specified in Schedule A). Such insurance shall be maintained from the date the **Contractor** is required to provide Proof of Insurance pursuant to Article 22.3.1 through the date of completion of all required **Work** (including punch list work as certified in writing by the **Resident Engineer**), except for insurance required pursuant to Article 22.1.4, which may terminate upon **Substantial Completion** of the **Contract**. All insurance shall meet the requirements set forth in this Article 22. Wherever this Article requires that insurance coverage be "at least as broad" as a specified form (including all ISO forms), there is no obligation that the form itself be used, provided that the **Contractor** can demonstrate that the alternative form or endorsement contained in its policy provides coverage at least as broad as the specified form.

22.1.1 Commercial General Liability Insurance: The **Contractor** shall provide Commercial General Liability Insurance covering claims for property damage and/or bodily injury, including death, which may arise from any of the operations under this **Contract**. Coverage under this insurance shall be at least as broad as that provided by the latest edition of Insurance Services Office ("ISO") Form CG 0001. Such insurance shall be "occurrence" based rather than "claims-made" and include, without limitation, the following types of coverage: premises operations; products and completed operations; contractual liability (including the tort liability of another assumed in a contract); broad form property damage; independent contractors; explosion, collapse and underground (XCU); construction means and methods; and incidental malpractice. Such insurance shall contain a "per project" aggregate limit, as specified in Schedule A, that applies separately to operations under this **Contract**.

22.1.1(a) Such Commercial General Liability Insurance shall name the **City** as an Additional Insured. Coverage for the **City** shall specifically include the **City's** officials and employees, be at least as broad as the latest edition of ISO Form CG 20 10 and provide completed operations coverage at least as broad as the latest edition of ISO Form CG 20 37.

22.1.1(b) Such Commercial General Liability Insurance shall name all other entities designated as additional insureds in Schedule A but only for claims arising from the **Contractor's** operations under this **Contract**, with coverage at least as broad as the latest edition of ISO Form CG 20 26.

22.1.1(c) If the **Work** requires a permit from the Department of Buildings pursuant to 1 RCNY Section 101-08, at http://www.nyc.gov/html/dob/downloads/rules/1_RCNY_101-08.pdf, the **Contractor** shall provide Commercial General Liability Insurance with limits of at least those required by 1 RCNY section 101-08. If the **Work** does not require such a permit, the minimum limits shall be those provided for in Schedule A.

22.1.1(d) If any of the **Work** includes repair of a waterborne vessel owned by or to be delivered to the **City**, such Commercial General Liability shall include, or be endorsed to include, Ship Repairer's Legal Liability Coverage to protect against, without limitation, liability arising from navigation of such vessels prior to delivery to and acceptance by the **City**.

22.1.2 Workers' Compensation Insurance, Employers' Liability Insurance, and Disability Benefits Insurance: The **Contractor** shall provide, and shall cause its **Subcontractors** to provide, Workers Compensation Insurance, Employers' Liability Insurance, and Disability Benefits Insurance in accordance with the **Laws** of the State of New York on behalf of all employees providing services under this **Contract** (except for those employees, if any, for which the **Laws** require insurance only pursuant to Article 22.1.3).

22.1.3 United States Longshoremen's and Harbor Workers Act and/or Jones Act Insurance: If specified in Schedule A of the General Conditions or if required by **Law**, the **Contractor** shall provide insurance in accordance with the United States Longshoremen's and Harbor Workers Act and/or the Jones Act, on behalf of all qualifying employees providing services under this **Contract**.

22.1.4 Builders Risk Insurance: If specified in Schedule A of the General Conditions, the **Contractor** shall provide Builders Risk Insurance on a completed value form for the total value of the **Work** through **Substantial Completion** of the **Work** in its entirety. Such insurance shall be provided on an All Risk basis and include coverage, without limitation, for windstorm (including named windstorm), storm surge, flood and earth movement. Unless waived by the **Commissioner**, it shall include coverage for ordinance and law, demolition and increased costs of construction, debris removal, pollutant clean up and removal, and expediting costs. Such insurance shall cover, without limitation, (a) all buildings and/or structures involved in the **Work**, as well as temporary structures at the **Site**, and (b) any property that is intended to become a permanent part of such building or structure, whether such property is on the **Site**, in transit or in temporary storage. Policies shall name the **Contractor** as Named Insured and list the **City** as both an Additional Insured and a Loss Payee as its interest may appear.

22.1.4(a) Policies of such insurance shall specify that, in the event a loss occurs at an occupied facility, occupancy of such facility is permitted without the consent of the issuing insurance company.

22.1.4(b) Such insurance may be provided through an Installation Floater, at the **Contractor's** option, if it otherwise conforms with the requirements of this Article 22.1.4.

22.1.5 Commercial Automobile Liability Insurance: The **Contractor** shall provide Commercial Automobile Liability Insurance for liability arising out of ownership, maintenance or use of any owned (if any), non-owned and hired vehicles to be used in connection with this **Contract**. Coverage shall be at least as broad as the latest edition of ISO Form CA0001. If vehicles are used for transporting hazardous materials, the Automobile Liability Insurance shall be endorsed to provide pollution liability broadened coverage for covered vehicles (endorsement CA 99 48) as well as proof of MCS 90.

22.1.6 Contractors Pollution Liability Insurance: If specified in Schedule A of the General Conditions, the **Contractor** shall maintain, or cause the **Subcontractor** doing such **Work** to maintain, Contractors Pollution Liability Insurance covering bodily injury and property damage. Such insurance shall provide coverage for actual, alleged or threatened emission, discharge, dispersal, seepage, release or escape of pollutants (including asbestos), including any loss, cost or expense incurred as a result of any cleanup of pollutants (including asbestos) or in the investigation, settlement or defense of any claim, action, or proceedings arising from the operations under this **Contract**. Such insurance shall be in the **Contractor's** name and list the **City** as an Additional Insured and any other entity specified in Schedule A. Coverage shall include, without limitation, (a) loss of use of damaged property or of property that has not been physically injured, (b) transportation, and (c) non-owned disposal sites.

22.1.6(a) Coverage for the **City** as Additional Insured shall specifically include the **City's** officials and employees and be at least as broad as provided to the **Contractor** for this **Project**.

22.1.6(b) If such insurance is written on a claims-made policy, such policy shall have a retroactive date on or before the effective date of this **Contract**, and continuous coverage shall be maintained, or an extended discovery period exercised, for a period of not less than three (3) years from the time the **Work** under this **Contract** is completed.

22.1.7 Marine Insurance:

22.1.7(a) Marine Protection and Indemnity Insurance: If specified in Schedule A of the General Conditions or if the **Contractor** engages in marine operations in the execution of any part of the **Work**, the **Contractor** shall maintain, or cause the **Subcontractor** doing such **Work** to maintain, Marine Protection and Indemnity Insurance with coverage at least as broad as Form SP-23. The insurance shall provide coverage for the **Contractor** or **Subcontractor** (whichever is doing this **Work**) and for the **City** (together with its officials and employees) and any other entity specified in Schedule A as an Additional Insured for bodily injury and property damage arising from marine operations under this **Contract**. Coverage shall include, without limitation, injury or death of crew members (if not fully provided through other insurance), removal of wreck, damage to piers, wharves and other fixed or floating objects and loss of or damage to any other vessel or craft, or to property on such other vessel or craft.

22.1.7(b) Hull and Machinery Insurance: If specified in Schedule A of the General Conditions or if the **Contractor** engages in marine operations in the execution of any part of the **Work**, the **Contractor** shall maintain, or cause the **Subcontractor** doing such **Work** to maintain, Hull and Machinery Insurance with coverage for the **Contractor** or **Subcontractor** (whichever is doing this **Work**) and for the **City** (together with its officials and employees) as Additional Insured at least as broad as the latest edition of American Institute Tug Form for all tugs used under this **Contract** and Collision Liability at least as broad as the latest edition of American Institute Hull Clauses.

22.1.7(c) Marine Pollution Liability Insurance: If specified in Schedule A of the General Conditions or if the **Contractor** engages in marine operations in the execution of any part of the **Work**, the **Contractor** shall maintain, or cause the **Subcontractor** doing such **Work** to maintain, Marine Pollution Liability Insurance covering itself (or the **Subcontractor** doing such **Work**) as Named Insured and the **City** (together with its officials and employees) and any other entity specified in Schedule A as an Additional Insured. Coverage shall be at least as broad as that provided by the latest edition of Water Quality Insurance Syndicate Form and include, without limitation, liability arising from the discharge or substantial threat of a discharge of oil, or from the release or threatened release of a hazardous substance including injury to, or economic losses resulting from, the destruction of or damage to real property, personal property or natural resources.

22.1.8 The **Contractor** shall provide such other types of insurance, at such minimum limits and with such conditions, as are specified in Schedule A of the General Conditions.

22.2 General Requirements for Insurance Coverage and Policies:

22.2.1 All required insurance policies shall be maintained with companies that may lawfully issue the required policy and have an A.M. Best rating of at least A-/VII or a Standard and Poor's rating of at least A, unless prior written approval is obtained from the **City** Corporation Counsel.

22.2.2 The **Contractor** shall be solely responsible for the payment of all premiums for all required policies and all deductibles and self-insured retentions to which such policies are subject, whether or not the **City** is an insured under the policy.

22.2.3 In his/her sole discretion, the **Commissioner** may, subject to the approval of the **Comptroller** and the **City** Corporation Counsel, accept Letters of Credit and/or custodial accounts in lieu of required insurance.

22.2.4 The **City's** limits of coverage for all types of insurance required pursuant to Schedule A of the General Conditions shall be the greater of (i) the minimum limits set forth in Schedule A or (ii) the limits provided to the **Contractor** as Named Insured under all primary, excess, and umbrella policies of that type of coverage.

22.2.5 The **Contractor** may satisfy its insurance obligations under this Article 22 through primary policies or a combination of primary and excess/umbrella policies, so long as all policies provide the scope of coverage required herein.

22.2.6 Policies of insurance provided pursuant to this Article 22 shall be primary and non-contributing to any insurance or self-insurance maintained by the **City**.

22.3 Proof of Insurance:

22.3.1 For all types of insurance required by Article 22.1 and Schedule A, except for insurance required by Articles 22.1.4 and 22.1.7, the **Contractor** shall file proof of insurance in accordance with this Article 22.3 within ten (10) **Days** of award. For insurance provided pursuant to Articles 22.1.4 and 22.1.7, proof shall be filed by a date specified by the **Commissioner** or ten (10) **Days** prior to the commencement of the portion of the **Work** covered by such policy, whichever is earlier.

22.3.2 For Workers' Compensation Insurance provided pursuant to Article 22.1.2, the **Contractor** shall submit one of the following forms: C-105.2 Certificate of Workers' Compensation Insurance; U-26.3 - State Insurance Fund Certificate of Workers' Compensation Insurance; Request for WC/DB Exemption (Form CE-200); equivalent or successor forms used by the New York State Workers' Compensation Board; or other proof of insurance in a form acceptable to the **Commissioner**. For Disability Benefits Insurance provided pursuant to Article 22.1.2, the Contractor shall submit DB-120.1 - Certificate Of Insurance Coverage Under The NYS Disability Benefits Law, Request for WC/DB Exemption (Form CE-200); equivalent or successor forms used by the New York State Workers' Compensation Board; or other proof of insurance in a form acceptable to the **Commissioner**. ACORD forms are not acceptable.

22.3.3 For policies provided pursuant to all of Article 22.1 other than Article 22.1.2, the **Contractor** shall submit one or more Certificates of Insurance on forms acceptable to the **Commissioner**. All such Certificates of Insurance shall certify (a) the issuance and effectiveness of such policies of insurance, each with the specified minimum limits (b) for insurance secured pursuant to Article 22.1.1 that the **City** and any other entity specified in Schedule A is an Additional Insured with coverage at least as broad as the most recent edition of ISO Forms CG 20 10, CG 20 37, and CG 20 26, as applicable; (c) in the event insurance is required pursuant to Article 22.1.6 and/or Article 22.1.7, that the **City** is an Additional Insured thereunder; (d) the company code issued to the insurance company by the National Association of Insurance Commissioners (the NAIC number); and (e) the number assigned to the **Contract** by the **City**. All such Certificates of Insurance shall be accompanied by either a duly executed "Certification by Broker" in the form contained in Part III of Schedule A or copies of all policies referenced in such Certificate of Insurance as certified by an authorized representative of the issuing insurance carrier. If any policy is not available at the time of submission, certified binders may be submitted until such time as the policy is available, at which time a certified copy of the policy shall be submitted.

22.3.4 Documentation confirming renewals of insurance shall be submitted to the **Commissioner** prior to the expiration date of coverage of policies required under this **Contract**. Such proofs of insurance shall comply with the requirements of Articles 22.3.2 and 22.3.3.

22.3.5 The **Contractor** shall be obligated to provide the **City** with a copy of any policy of insurance provided pursuant to this Article 22 upon the demand for such policy by the **Commissioner** or the **City Corporation Counsel**.

22.4 Operations of the Contractor:

22.4.1 The **Contractor** shall not commence the **Work** unless and until all required certificates have been submitted to and accepted by the **Commissioner**. Acceptance by the **Commissioner** of a certificate does not excuse the **Contractor** from securing insurance

consistent with all provisions of this Article 22 or of any liability arising from its failure to do so.

22.4.2 The **Contractor** shall be responsible for providing continuous insurance coverage in the manner, form, and limits required by this **Contract** and shall be authorized to perform **Work** only during the effective period of all required coverage.

22.4.3 In the event that any of the required insurance policies lapse, are revoked, suspended or otherwise terminated, for whatever cause, the **Contractor** shall immediately stop all **Work**, and shall not recommence **Work** until authorized in writing to do so by the **Commissioner**. Upon quitting the **Site**, except as otherwise directed by the **Commissioner**, the **Contractor** shall leave all plant, materials, equipment, tools, and supplies on the **Site**. **Contract** time shall continue to run during such periods and no extensions of time will be granted. The **Commissioner** may also declare the **Contractor** in default for failure to maintain required insurance.

22.4.4 In the event the **Contractor** receives notice, from an insurance company or other person, that any insurance policy required under this Article 22 shall be cancelled or terminated (or has been cancelled or terminated) for any reason, the **Contractor** shall immediately forward a copy of such notice to both the **Commissioner** and the New York City Comptroller, attn: Office of Contract Administration, Municipal Building, One Centre Street, room 1005, New York, New York 10007. Notwithstanding the foregoing, the **Contractor** shall ensure that there is no interruption in any of the insurance coverage required under this Article 22.

22.4.5 Where notice of loss, damage, occurrence, accident, claim or suit is required under an insurance policy maintained in accordance with this Article 22, the **Contractor** shall notify in writing all insurance carriers that issued potentially responsive policies of any such event relating to any operations under this **Contract** (including notice to Commercial General Liability insurance carriers for events relating to the **Contractor's** own employees) no later than 20 days after such event. For any policy where the **City** is an Additional Insured, such notice shall expressly specify that "this notice is being given on behalf of the City of New York as Insured as well as the Named Insured." Such notice shall also contain the following information: the number of the insurance policy, the name of the named insured, the date and location of the damage, occurrence, or accident, and the identity of the persons or things injured, damaged or lost. The **Contractor** shall simultaneously send a copy of such notice to the City of New York c/o Insurance Claims Specialist, Affirmative Litigation Division, New York City Law Department, 100 Church Street, New York, New York 10007.

22.4.6 In the event of any loss, accident, claim, action, or other event that does or can give rise to a claim under any insurance policy required under this Article 22, the **Contractor** shall at all times fully cooperate with the **City** with regard to such potential or actual claim.

22.5 **Subcontractor Insurance:** In the event the **Contractor** requires any **Subcontractor** to procure insurance with regard to any operations under this **Contract** and requires such **Subcontractor** to name the **Contractor** as an **Additional Insured** thereunder, the **Contractor** shall ensure that the **Subcontractor** name the **City**, including its officials and employees, as an Additional Insured with coverage at least as broad as the most recent edition of ISO Form CG 20 26.

22.6 Wherever reference is made in Article 7 or this Article 22 to documents to be sent to the **Commissioner** (e.g., notices, filings, or submissions), such documents shall be sent to the address set forth in Schedule A of the General Conditions. In the event no address is set forth in Schedule A, such documents are to be sent to the **Commissioner's** address as provided elsewhere in this **Contract**.

22.7 Apart from damages or losses covered by insurance provided pursuant to Articles 22.1.2, 22.1.3, or 22.1.5, the **Contractor** waives all rights against the **City**, including its officials and employees, for any damages or losses that are covered under any insurance required under this Article 22 (whether or not such insurance is actually procured or claims are paid thereunder) or any other insurance applicable to the operations of the **Contractor** and/or its employees, agents, or **Subcontractors**.

22.8 In the event the **Contractor** utilizes a self-insurance program to satisfy any of the requirements of this Article 22, the **Contractor** shall ensure that any such self-insurance program provides the **City** with all rights that would be provided by traditional insurance under this Article 22, including but not limited to the defense and indemnification obligations that insurers are required to undertake in liability policies.

22.9 Materiality/Non-Waiver: The **Contractor's** failure to secure policies in complete conformity with this Article 22, or to give an insurance company timely notice of any sort required in this **Contract** or to do anything else required by this Article 22 shall constitute a material breach of this **Contract**. Such breach shall not be waived or otherwise excused by any action or inaction by the **City** at any time.

22.10 Pursuant to General Municipal Law Section 108, this **Contract** shall be void and of no effect unless **Contractor** maintains Workers' Compensation Insurance for the term of this **Contract** to the extent required and in compliance with the New York State Workers' Compensation Law.

22.11 Other Remedies: Insurance coverage provided pursuant to this Article 22 or otherwise shall not relieve the **Contractor** of any liability under this **Contract**, nor shall it preclude the **City** from exercising any rights or taking such other actions available to it under any other provisions of this **Contract** or **Law**.

ARTICLE 23. MONEY RETAINED AGAINST CLAIMS

23.1 If any claim shall be made by any person or entity (including **Other Contractors** with the **City** on this **Project**) against the **City** or against the **Contractor** and the **City** for any of the following:

- (a) An alleged loss, damage, injury, theft or vandalism of any of the kinds referred to in Articles 7 and 12, plus the reasonable costs of defending the **City**, which in the opinion of the **Comptroller** may not be paid by an insurance company (for any reason whatsoever); or
- (b) An infringement of copyrights, patents or use of patented articles, tools, etc., as referred to in Article 57; or
- (c) Damage claimed to have been caused directly or indirectly by the failure of the **Contractor** to perform the **Work** in strict accordance with this **Contract**,

the amount of such claim, or so much thereof as the **Comptroller** may deem necessary, may be withheld by the **Comptroller**, as security against such claim, from any money due hereunder. The **Comptroller**, in his/her discretion, may permit the **Contractor** to substitute other satisfactory security in lieu of the monies so withheld.

23.2 If an action on such claim is timely commenced and the liability of the **City**, or the **Contractor**, or both, shall have been established therein by a final judgment of a court of competent jurisdiction, or if such claim shall have been admitted by the **Contractor** to be valid, the **Comptroller**

shall pay such judgment or admitted claim out of the monies retained by the **Comptroller** under the provisions of this Article 23, and return the balance, if any, without interest, to the **Contractor**.

ARTICLE 24. MAINTENANCE AND GUARANTY

24.1 The **Contractor** shall promptly repair, replace, restore or rebuild, as the **Commissioner** may determine, any finished **Work** in which defects of materials or workmanship may appear or to which damage may occur because of such defects, during the one (1) year period subsequent to the date of **Substantial Completion** (or use and occupancy in accordance with Article 16), except where other periods of maintenance and guaranty are provided for in Schedule A.

24.2 As security for the faithful performance of its obligations hereunder, the **Contractor**, upon filing its requisition for payment on **Substantial Completion**, shall deposit with the **Commissioner** a sum equal to one (1%) percent of the price (or the amount fixed in Schedule A of the General Conditions) in cash or certified check upon a state or national bank and trust company or a check of such bank and trust company signed by a duly authorized officer thereof and drawn to the order of the **Comptroller**, or obligations of the **City**, which the **Comptroller** may approve as of equal value with the sum so required.

24.3 In lieu of the above, the **Contractor** may make such security payment to the **City** by authorizing the **Commissioner** in writing to deduct the amount from the **Substantial Completion** payment which shall be deemed the deposit required above.

24.4 If the **Contractor** has faithfully performed all of its obligations hereunder the **Commissioner** shall so certify to the **Comptroller** within five (5) **Days** after the expiration of one (1) year from the date of **Substantial Completion** and acceptance of the **Work** or within thirty (30) **Days** after the expiration of the guarantee period fixed in the **Specifications**. The security payment shall be repaid to the **Contractor** without interest within thirty (30) **Days** after certification by the **Commissioner** to the **Comptroller** that the **Contractor** has faithfully performed all of its obligations hereunder.

24.5 Notice by the **Commissioner** to the **Contractor** to repair, replace, rebuild or restore such defective or damaged **Work** shall be timely, pursuant to this article, if given not later than ten (10) **Days** subsequent to the expiration of the one (1) year period or other periods provided for herein.

24.6 If the **Contractor** shall fail to repair, replace, rebuild or restore such defective or damaged **Work** promptly after receiving such notice, the **Commissioner** shall have the right to have the **Work** done by others in the same manner as provided for in the completion of a defaulted **Contract**, under Article 51.

24.7 If the security payment so deposited is insufficient to cover the cost of such **Work**, the **Contractor** shall be liable to pay such deficiency on demand by the **Commissioner**.

24.8 The **Engineer's** certificate setting forth the fair and reasonable cost of repairing, replacing, rebuilding or restoring any damaged or defective **Work** when performed by one other than the **Contractor**, shall be binding and conclusive upon the **Contractor** as to the amount thereof.

24.9 The **Contractor** shall obtain all manufacturers' warranties and guaranties of all equipment and materials required by this **Contract** in the name of the **City** and shall deliver same to the **Commissioner**. All of the **City's** rights and title and interest in and to said manufacturers' warranties and guaranties may be assigned by the **City** to any subsequent purchasers of such equipment and materials or lessees of the premises into which the equipment and materials have been installed.

CHAPTER VI
CHANGES, EXTRA WORK, AND DOCUMENTATION OF CLAIM

ARTICLE 25. CHANGES

25.1 Changes may be made to this **Contract** only as duly authorized in writing by the **Commissioner** in accordance with the Law and this **Contract**. All such changes, modifications, and amendments will become a part of the **Contract**. Work so ordered shall be performed by the **Contractor**.

25.2 **Contract** changes will be made only for **Work** necessary to complete the **Work** included in the original scope of the **Contract** and/or for non-material changes to the scope of the **Contract**. Changes are not permitted for any material alteration in the scope of **Work** in the **Contract**.

25.3 The **Contractor** shall be entitled to a price adjustment for **Extra Work** performed pursuant to a written change order. Adjustments to price shall be computed in one or more of the following ways:

25.3.1 By applicable unit prices specified in the **Contract**; and/or

25.3.2 By agreement of a fixed price; and/or

25.3.3 By time and material records; and/or

25.3.4 In any other manner approved by the **CCPO**.

25.4 All payments for change orders are subject to pre-audit by the **Engineering Audit Officer** and may be post-audited by the **Comptroller** and/or the **Agency**.

ARTICLE 26. METHODS OF PAYMENT FOR OVERRUNS AND EXTRA WORK

26.1 **Overrun of Unit Price Item:** An overrun is any quantity of a unit price item which the **Contractor** is directed to provide which is in excess of one hundred twenty-five (125%) percent of the estimated quantity for that item set forth in the bid schedule.

26.1.1 For any unit price item, the **Contractor** will be paid at the unit price bid for any quantity up to one hundred twenty-five (125%) percent of the estimated quantity for that item set forth in the bid schedule. If during the progress of the **Work**, the actual quantity of any unit price item required to complete the **Work** approaches the estimated quantity for that item, and for any reason it appears that the actual quantity of any unit price item necessary to complete the **Work** will exceed the estimated quantity for that item by twenty-five (25%) percent, the **Contractor** shall immediately notify the **Engineer** of such anticipated overrun. The **Contractor** shall not be compensated for any quantity of a unit price item provided which is in excess of one hundred twenty-five (125%) percent of the estimated quantity for that item set forth in the bid schedule without written authorization from the **Engineer**.

26.1.2 If the actual quantity of any unit price item necessary to complete the **Work** will exceed one hundred twenty five (125%) percent of the estimated quantity for that item set forth in the bid schedule, the **City** reserves the right and the **Contractor** agrees to negotiate a new unit price for such item. In no event shall such negotiated new unit price exceed the unit bid price. If the **City** and **Contractor** cannot agree on a new unit price, then the **City** shall order the **Contractor** and the **Contractor** agrees to provide additional quantities of the

item on the basis of time and material records for the actual and reasonable cost as determined under Article 26.2, but in no event at a unit price exceeding the unit price bid.

26.2 Extra Work: For **Extra Work** where payment is by agreement on a fixed price in accordance with Article 25.3.2, the price to be paid for such **Extra Work** shall be based on the fair and reasonable estimated cost of the items set forth below. For **Extra Work** where payment is based on time and material records in accordance with Article 25.3.3, the price to be paid for such **Extra Work** shall be the actual and reasonable cost of the items set forth below, calculated in accordance with the formula specified therein, if any.

26.2.1 Necessary materials (including transportation to the **Site**); plus

26.2.2 Necessary direct labor, including payroll taxes (subject to statutory wage caps) and supplemental benefits; plus

26.2.3 Sales and personal property taxes, if any, required to be paid on materials not incorporated into such **Extra Work**; plus

26.2.4 Reasonable rental value of **Contractor**-owned (or **Subcontractor**-owned, as applicable), necessary plant and equipment other than **Small Tools**, plus fuel/energy costs. Except for fuel costs for pick-up trucks which shall be reimbursed based on a consumption of five (5) gallons per shift, fuel costs shall be reimbursed based on actual costs or, in the absence of auditable documentation, the following fuel consumption formula per operating hour: $(.035) \times (\text{HP rating}) \times (\text{Fuel cost/gallon})$. Reasonable rental value is defined as the lower of either seventy-five percent of the monthly prorated rental rates established in "The AED Green Book, Rental Rates and Specifications for Construction Equipment" published by Equipment Watch (the "Green Book"), or seventy-five percent of the monthly prorated rental rates established in the "Rental Rate Blue Book for Construction Equipment" published by Equipment Watch (the "Blue Book") (the applicable Blue Book rate being for rental only without the addition of any operational costs listed in the Blue Book). The reasonable rental value is deemed to be inclusive of all operating costs except for fuel/energy consumption and equipment operator's wages/costs. For multiple shift utilization, reimbursement shall be calculated as follows: first shift shall be seventy-five (75%) percent of such rental rates; second shift shall be sixty (60%) percent of the first shift rate; and third shift shall be forty (40%) percent of the first shift rate. Equipment on standby shall be reimbursed at one-third (1/3) the prorated monthly rental rate. **Contractor**-owned (or **Subcontractor**-owned, as applicable) equipment includes equipment from rental companies affiliated with or controlled by the **Contractor** (or **Subcontractor**, as applicable), as determined by the **Commissioner**. In establishing cost reimbursement for non-operating **Contractor**-owned (or **Subcontractor**-owned, as applicable) equipment (scaffolding, sheeting systems, road plates, etc.), the **City** may restrict reimbursement to a purchase-salvage/life cycle basis if less than the computed rental costs; plus

26.2.5 Necessary installation and dismantling of such plant and equipment, including transportation to and from the **Site**, if any, provided that, in the case of non-**Contractor**-owned (or non-**Subcontractor**-owned, as applicable) equipment rented from a third party, the cost of installation and dismantling are not allowable if such costs are included in the rental rate; plus

26.2.6 Necessary fees charged by governmental entities; plus

26.2.7 Necessary construction-related service fees charged by non-governmental entities, such as landfill tipping fees; plus

26.2.8 Reasonable rental costs of non-Contractor-owned (or non-Subcontractor-owned, as applicable) necessary plant and equipment other than **Small Tools**, plus fuel/energy costs. Except for fuel costs for pick-up trucks which shall be reimbursed based on a consumption of five (5) gallons per shift, fuel costs shall be reimbursed based on actual costs or, in the absence of auditable documentation, the following fuel consumption formula per hour of operation: $(.035) \times (\text{HP rating}) \times (\text{Fuel cost/gallon})$. In lieu of renting, the City reserves the right to direct the purchase of non-operating equipment (scaffolding, sheeting systems, road plates, etc.), with payment on a purchase-salvage/life cycle basis, if less than the projected rental costs; plus

26.2.9 Workers' Compensation Insurance, and any insurance coverage expressly required by the City for the performance of the **Extra Work** which is different than the types of insurance required by Article 22 and Schedule A of the General Conditions. The cost of Workers' Compensation Insurance is subject to applicable payroll limitation caps and shall be based upon the carrier's Manual Rate for such insurance derived from the applicable class Loss Cost ("LC") and carrier's Lost Cost Multiplier ("LCM") approved by the New York State Department of Financial Services, and with the exception of experience rating, rate modifiers as promulgated by the New York Compensation Insurance Rating Board ("NYCIRB"); plus

26.2.10 Additional costs incurred as a result of the **Extra Work** for performance and payment bonds; plus

26.2.11 Twelve percent (12%) percent of the total of items in Articles 26.2.1 through 26.2.5 as compensation for overhead, except that no percentage for overhead will be allowed on **Payroll Taxes** or on the premium portion of overtime pay or on sales and personal property taxes. Overhead shall include without limitation, all costs and expenses in connection with administration, management superintendence, small tools, and insurance required by Schedule A of the General Conditions other than Workers' Compensation Insurance; plus

26.2.12 Ten (10%) percent of the total of items in Articles 26.2.1 through 26.2.5, plus the items in Article 26.2.11, as compensation for profit, except that no percentage for profit will be allowed on **Payroll Taxes** or on the premium portion of overtime pay or on sales and personal property taxes; plus

26.2.13 Five (5%) percent of the total of items in Articles 26.2.6 through 26.2.10 as compensation for overhead and profit.

26.3 Where the **Extra Work** is performed in whole or in part by other than the Contractor's own forces pursuant to Article 26.2, the Contractor shall be paid, subject to pre-audit by the **Engineering Audit Officer**, the cost of such **Work** computed in accordance with Article 26.2 above, plus an additional allowance of five (5%) percent to cover the Contractor's overhead and profit.

26.4 Where a change is ordered, involving both **Extra Work** and omitted or reduced **Contract Work**, the **Contract** price shall be adjusted, subject to pre-audit by the **EAO**, in an amount based on the difference between the cost of such **Extra Work** and of the omitted or reduced **Work**.

26.5 Where the Contractor and the Commissioner can agree upon a fixed price for **Extra Work** in accordance with Article 25.3.2 or another method of payment for **Extra Work** in accordance with Article

25.3.4, or for **Extra Work** ordered in connection with omitted **Work**, such method, subject to pre-audit by the **EAO**, may, at the option of the **Commissioner**, be substituted for the cost plus a percentage method provided in Article 26.2; provided, however, that if the **Extra Work** is performed by a **Subcontractor**, the **Contractor** shall not be entitled to receive more than an additional allowance of five (5%) percent for overhead and profit over the cost of such **Subcontractor's Work** as computed in accordance with Article 26.2.

ARTICLE 27. RESOLUTION OF DISPUTES

27.1 All disputes between the **City** and the **Contractor** of the kind delineated in this Article 27.1 that arise under, or by virtue of, this **Contract** shall be finally resolved in accordance with the provisions of this Article 27 and the **PPB Rules**. This procedure for resolving all disputes of the kind delineated herein shall be the exclusive means of resolving any such disputes.

27.1.1 This Article 27 shall not apply to disputes concerning matters dealt with in other sections of the **PPB Rules**, or to disputes involving patents, copyrights, trademarks, or trade secrets (as interpreted by the courts of New York State) relating to proprietary rights in computer software.

27.1.2 This Article 27 shall apply only to disputes about the scope of **Work** delineated by the **Contract**, the interpretation of **Contract** documents, the amount to be paid for **Extra Work** or disputed work performed in connection with the **Contract**, the conformity of the **Contractor's Work** to the **Contract**, and the acceptability and quality of the **Contractor's Work**; such disputes arise when the **Engineer**, **Resident Engineer**, **Engineering Audit Officer**, or other designee of the **Commissioner** makes a determination with which the **Contractor** disagrees.

27.2 All determinations required by this Article 27 shall be made in writing clearly stated, with a reasoned explanation for the determination based on the information and evidence presented to the party making the determination. Failure to make such determination within the time required by this Article 27 shall be deemed a non-determination without prejudice that will allow application to the next level.

27.3 During such time as any dispute is being presented, heard, and considered pursuant to this Article 27, the **Contract** terms shall remain in force and the **Contractor** shall continue to perform **Work** as directed by the **ACCO** or the **Engineer**. Failure of the **Contractor** to continue **Work** as directed shall constitute a waiver by the **Contractor** of its claim.

27.4 Presentation of Disputes to **Commissioner**.

Notice of Dispute and Agency Response. The **Contractor** shall present its dispute in writing ("Notice of Dispute") to the **Commissioner** within thirty (30) Days of receiving written notice of the determination or action that is the subject of the dispute. This notice requirement shall not be read to replace any other notice requirements contained in the **Contract**. The Notice of Dispute shall include all the facts, evidence, documents, or other basis upon which the **Contractor** relies in support of its position, as well as a detailed computation demonstrating how any amount of money claimed by the **Contractor** in the dispute was arrived at. Within thirty (30) Days after receipt of the detailed written submission comprising the complete Notice of Dispute, the **Engineer**, **Resident Engineer**, **Engineering Audit Officer**, or other designee of the **Commissioner** shall submit to the **Commissioner** all materials he or she deems pertinent to the dispute. Following initial submissions to the **Commissioner**, either party may demand of the other the production of any document or other material the demanding party believes may be relevant to the dispute. The requested party shall produce all relevant materials that are not otherwise

protected by a legal privilege recognized by the courts of New York State. Any question of relevancy shall be determined by the **Commissioner** whose decision shall be final. Willful failure of the **Contractor** to produce any requested material whose relevancy the **Contractor** has not disputed, or whose relevancy has been affirmatively determined, shall constitute a waiver by the **Contractor** of its claim.

27.4.1 **Commissioner Inquiry.** The **Commissioner** shall examine the material and may, in his or her discretion, convene an informal conference with the **Contractor**, the **ACCO**, and the **Engineer, Resident Engineer, Engineering Audit Officer**, or other designee of the **Commissioner** to resolve the issue by mutual consent prior to reaching a determination. The **Commissioner** may seek such technical or other expertise as he or she shall deem appropriate, including the use of neutral mediators, and require any such additional material from either or both parties as he or she deems fit. The **Commissioner's** ability to render, and the effect of, a decision hereunder shall not be impaired by any negotiations in connection with the dispute presented, whether or not the **Commissioner** participated therein. The **Commissioner** may or, at the request of any party to the dispute, shall compel the participation of any **Other Contractor** with a contract related to the **Work** of this **Contract**, and that **Contractor** shall be bound by the decision of the **Commissioner**. Any **Other Contractor** thus brought into the dispute resolution proceeding shall have the same rights and obligations under this Article 27 as the **Contractor** initiating the dispute.

27.4.2 **Commissioner Determination.** Within thirty (30) **Days** after the receipt of all materials and information, or such longer time as may be agreed to by the parties, the **Commissioner** shall make his or her determination and shall deliver or send a copy of such determination to the **Contractor**, the **ACCO**, and **Engineer, Resident Engineer, Engineering Audit Officer**, or other designee of the **Commissioner**, as applicable, together with a statement concerning how the decision may be appealed.

27.4.3 **Finality of Commissioner's Decision.** The **Commissioner's** decision shall be final and binding on all parties, unless presented to the Contract Dispute Resolution Board pursuant to this Article 27. The **City** may not take a petition to the Contract Dispute Resolution Board. However, should the **Contractor** take such a petition, the **City** may seek, and the Contract Dispute Resolution Board may render, a determination less favorable to the **Contractor** and more favorable to the **City** than the decision of the **Commissioner**.

27.5 **Presentation of Dispute to the Comptroller.** Before any dispute may be brought by the **Contractor** to the Contract Dispute Resolution Board, the **Contractor** must first present its claim to the **Comptroller** for his or her review, investigation, and possible adjustment.

27.5.1 **Time, Form, and Content of Notice.** Within thirty (30) **Days** of its receipt of a decision by the **Commissioner**, the **Contractor** shall submit to the **Comptroller** and to the **Commissioner** a Notice of Claim regarding its dispute with the **Agency**. The Notice of Claim shall consist of (i) a brief written statement of the substance of the dispute, the amount of money, if any, claimed and the reason(s) the **Contractor** contends the dispute was wrongly decided by the **Commissioner**; (ii) a copy of the written decision of the **Commissioner**; and (iii) a copy of all materials submitted by the **Contractor** to the **Agency**, including the Notice of Dispute. The **Contractor** may not present to the **Comptroller** any material not presented to the **Commissioner**, except at the request of the **Comptroller**.

27.5.2 **Response.** Within thirty (30) **Days** of receipt of the Notice of Claim, the **Agency** shall make available to the **Comptroller** a copy of all material submitted by the **Agency** to the **Commissioner** in connection with the dispute. The **Agency** may not present to the

Comptroller any material not presented to the **Commissioner** except at the request of the **Comptroller**.

27.5.3 **Comptroller Investigation.** The **Comptroller** may investigate the claim in dispute and, in the course of such investigation, may exercise all powers provided in Sections 7-201 and 7-203 of the Administrative Code. In addition, the **Comptroller** may demand of either party, and such party shall provide, whatever additional material the **Comptroller** deems pertinent to the claim, including original business records of the **Contractor**. Willful failure of the **Contractor** to produce within fifteen (15) **Days** any material requested by the **Comptroller** shall constitute a waiver by the **Contractor** of its claim. The **Comptroller** may also schedule an informal conference to be attended by the **Contractor**, **Agency** representatives, and any other personnel desired by the **Comptroller**.

27.5.4 **Opportunity of Comptroller to Compromise or Adjust Claim.** The **Comptroller** shall have forty-five (45) **Days** from his or her receipt of all materials referred to in Article 27.5.3 to investigate the disputed claim. The period for investigation and compromise may be further extended by agreement between the **Contractor** and the **Comptroller**, to a maximum of ninety (90) **Days** from the **Comptroller's** receipt of all materials. The **Contractor** may not present its petition to the Contract Dispute Resolution Board until the period for investigation and compromise delineated in this Article 27.5.4 has expired. In compromising or adjusting any claim hereunder, the **Comptroller** may not revise or disregard the terms of the **Contract** between the parties.

27.6 **Contract Dispute Resolution Board.** There shall be a Contract Dispute Resolution Board composed of:

27.6.1 The chief administrative law judge of the Office of Administrative Trials and Hearings (OATH) or his/her designated OATH administrative law judge, who shall act as chairperson, and may adopt operational procedures and issue such orders consistent with this Article 27 as may be necessary in the execution of the Contract Dispute Resolution Board's functions, including, but not limited to, granting extensions of time to present or respond to submissions;

27.6.2 The **CCPO** or his/her designee; any designee shall have the requisite background to consider and resolve the merits of the dispute and shall not have participated personally and substantially in the particular matter that is the subject of the dispute or report to anyone who so participated; and

27.6.3 A person with appropriate expertise who is not an employee of the **City**. This person shall be selected by the presiding administrative law judge from a prequalified panel of individuals, established and administered by OATH with appropriate background to act as decision-makers in a dispute. Such individual may not have a contract or dispute with the **City** or be an officer or employee of any company or organization that does, or regularly represents persons, companies, or organizations having disputes with the **City**.

27.7 **Petition to the Contract Dispute Resolution Board.** In the event the claim has not been settled or adjusted by the **Comptroller** within the period provided in this Article 27, the **Contractor**, within thirty (30) **Days** thereafter, may petition the Contract Dispute Resolution Board to review the **Commissioner's** determination.

27.7.1 **Form and Content of Petition by Contractor.** The **Contractor** shall present its dispute to the Contract Dispute Resolution Board in the form of a petition, which shall

include (i) a brief written statement of the substance of the dispute, the amount of money, if any, claimed, and the reason(s) the **Contractor** contends the dispute was wrongly decided by the **Commissioner**; (ii) a copy of the written Decision of the **Commissioner**; (iii) copies of all materials submitted by the **Contractor** to the Agency; (iv) a copy of the written decision of the **Comptroller**, if any, and (v) copies of all correspondence with, or written material submitted by the **Contractor**, to the **Comptroller**. The **Contractor** shall concurrently submit four (4) complete sets of the Petition: one set to the City Corporation Counsel (Attn: Commercial and Real Estate Litigation Division) and three (3) sets to the Contract Dispute Resolution Board at OATH's offices with proof of service on the City Corporation Counsel. In addition, the **Contractor** shall submit a copy of the written statement of the substance of the dispute, cited in (i) above, to both the **Commissioner** and the **Comptroller**.

27.7.2 **Agency Response.** Within thirty (30) **Days** of its receipt of the Petition by the City Corporation Counsel, the **Agency** shall respond to the brief written statement of the **Contractor** and make available to the Contract Dispute Resolution Board all material it submitted to the **Commissioner** and **Comptroller**. Three (3) complete copies of the **Agency** response shall be provided to the Contract Dispute Resolution Board and one to the **Contractor**. Extensions of time for submittal of the **Agency** response shall be given as necessary upon a showing of good cause or, upon consent of the parties, for an initial period of up to thirty (30) **Days**.

27.7.3 **Further Proceedings.** The Contract Dispute Resolution Board shall permit the **Contractor** to present its case by submission of memoranda, briefs, and oral argument. The Contract Dispute Resolution Board shall also permit the **Agency** to present its case in response to the **Contractor** by submission of memoranda, briefs, and oral argument. If requested by the City Corporation Counsel, the **Comptroller** shall provide reasonable assistance in the preparation of the **Agency's** case. Neither the **Contractor** nor the **Agency** may support its case with any documentation or other material that was not considered by the **Comptroller**, unless requested by the Contract Dispute Resolution Board. The Contract Dispute Resolution Board, in its discretion, may seek such technical or other expert advice as it shall deem appropriate and may seek, on its own or upon application of a party, any such additional material from any party as it deems fit. The Contract Dispute Resolution Board, in its discretion, may combine more than one dispute between the parties for concurrent resolution.

27.7.4 **Contract Dispute Resolution Board Determination.** Within forty-five (45) **Days** of the conclusion of all written submissions and oral arguments, the Contract Dispute Resolution Board shall render a written decision resolving the dispute. In an unusually complex case, the Contract Dispute Resolution Board may render its decision in a longer period, not to exceed ninety (90) **Days**, and shall so advise the parties at the commencement of this period. The Contract Dispute Resolution Board's decision must be consistent with the terms of the **Contract**. Decisions of the Contract Dispute Resolution Board shall only resolve matters before the Contract Dispute Resolution Board and shall not have precedential effect with respect to matters not before the Contract Dispute Resolution Board.

27.7.5 **Notification of Contract Dispute Resolution Board Decision.** The Contract Dispute Resolution Board shall send a copy of its decision to the **Contractor**, the **ACCO**, the **Engineer**, the **Comptroller**, the City Corporation Counsel, the **CCPO**, and the **PPB**. A decision in favor of the **Contractor** shall be subject to the prompt payment provisions of the **PPB Rules**. The Required Payment Date shall be thirty (30) **Days** after the date the parties are formally notified of the Contract Dispute Resolution Board's decision.

27.7.6 Finality of Contract Dispute Resolution Board Decision. The Contract Dispute Resolution

Board's decision shall be final and binding on all parties. Any party may seek review of the Contract Dispute Resolution Board's decision solely in the form of a challenge, filed within four (4) months of the date of the Contract Dispute Resolution Board's decision, in a court of competent jurisdiction of the State of New York, County of New York pursuant to Article 78 of the Civil Practice Law and Rules. Such review by the court shall be limited to the question of whether or not the Contract Dispute Resolution Board's decision was made in violation of lawful procedure, was affected by an error of Law, or was arbitrary and capricious or an abuse of discretion. No evidence or information shall be introduced or relied upon in such proceeding that was not presented to the Contract Dispute Resolution Board in accordance with this Article 27.

27.8 Any termination, cancellation, or alleged breach of the Contract prior to or during the pendency of any proceedings pursuant to this Article 27 shall not affect or impair the ability of the Commissioner or Contract Dispute Resolution Board to make a binding and final decision pursuant to this Article 27.

ARTICLE 28. RECORD KEEPING FOR EXTRA OR DISPUTED WORK OR WORK ON A TIME & MATERIALS BASIS

28.1 While the Contractor or any of its Subcontractors is performing Work on a time and material basis or Extra Work on a time and material basis ordered by the Commissioner under Article 25, or where the Contractor believes that it or any of its Subcontractors is performing Extra Work but a final determination by Agency has not been made, or the Contractor or any of its Subcontractors is performing disputed Work (whether on or off the Site), or complying with a determination or order under protest in accordance with Articles 11, 27, and 30, in each such case the Contractor shall furnish the Resident Engineer daily with three (3) copies of written statements signed by the Contractor's representative at the Site showing:

28.1.1 The name, trade, and number of each worker employed on such Work or engaged in complying with such determination or order, the number of hours employed, and the character of the Work each is doing; and

28.1.2 The nature and quantity of any materials, plant and equipment furnished or used in connection with the performance of such Work or compliance with such determination or order, and from whom purchased or rented.

28.2 A copy of such statement will be countersigned by the Resident Engineer, noting thereon any items not agreed to or questioned, and will be returned to the Contractor within two (2) Days after submission.

28.3 The Contractor and its Subcontractors, when required by the Commissioner, or the Comptroller, shall also produce for inspection, at the office of the Contractor or Subcontractor, any and all of its books, bid documents, financial statements, vouchers, records, daily job diaries and reports, and cancelled checks, and any other documents relating to showing the nature and quantity of the labor, materials, plant and equipment actually used in the performance of such Work, or in complying with such determination or order, and the amounts expended therefor, and shall permit the Commissioner and the Comptroller to make such extracts therefrom, or copies thereof, as they or either of them may desire.

28.4 In connection with the examination provided for herein, the Commissioner, upon demand therefor, will produce for inspection by the Contractor such records as the Agency may have with

respect to such **Extra Work** or disputed **Work** performed under protest pursuant to order of the **Commissioner**, except those records and reports which may have been prepared for the purpose of determining the accuracy and validity of the **Contractor's** claim.

28.5 Failure to comply strictly with these requirements shall constitute a waiver of any claim for extra compensation or damages on account of the performance of such **Work** or compliance with such determination or order.

ARTICLE 29. OMITTED WORK

29.1 If any **Contract Work** in a lump sum **Contract**, or if any part of a lump sum item in a unit price, lump sum, or percentage-bid **Contract** is omitted by the **Commissioner** pursuant to Article 33, the **Contract** price, subject to audit by the EAO, shall be reduced by a pro rata portion of the lump sum bid amount based upon the percent of **Work** omitted subject to Article 29.4. For the purpose of determining the pro rata portion of the lump sum bid amount, the bid breakdown submitted in accordance with Article 41 shall be considered, but shall not be the determining factor.

29.2 If the whole of a lump sum item or units of any other item is so omitted by the **Commissioner** in a unit price, lump sum, or percentage-bid **Contract**, then no payment will be made therefor except as provided in Article 29.4.

29.3 For units that have been ordered but are only partially completed, the unit price shall be reduced by a pro rata portion of the unit price bid based upon the percentage of **Work** omitted subject to Article 29.4.

29.4 In the event the **Contractor**, with respect to any omitted **Work**, has purchased any non-cancelable material and/or equipment that is not capable of use except in the performance of this **Contract** and has been specifically fabricated for the sole purpose of this **Contract**, but not yet incorporated into the **Work**, the **Contractor** shall be paid for such material and/or equipment in accordance with Article 64.2.1(b); provided, however, such payment is contingent upon the **Contractor's** delivery of such material and/or equipment in acceptable condition to a location designated by the **City**.

29.5 The **Contractor** agrees to make no claim for damages or for loss of overhead and profit with regard to any omitted **Work**.

ARTICLE 30. NOTICE AND DOCUMENTATION OF COSTS AND DAMAGES; PRODUCTION OF FINANCIAL RECORDS

30.1 If the **Contractor** shall claim to be sustaining damages by reason of any act or omission of the **City** or its agents, it shall submit to the **Commissioner** within forty-five (45) **Days** from the time such damages are first incurred, and every thirty (30) **Days** thereafter for as long as such damages are incurred, verified statements of the details and the amounts of such damages, together with documentary evidence of such damages. The **Contractor** may submit any of the above statements within such additional time as may be granted by the **Commissioner** in writing upon written request therefor. Failure of the **Commissioner** to respond in writing to a written request for additional time within thirty (30) **Days** shall be deemed a denial of the request. On failure of the **Contractor** to strictly comply with the foregoing provisions, such claims shall be deemed waived and no right to recover on such claims shall exist. Damages that the **Contractor** may claim in any action or dispute resolution procedure arising under or by reason of this **Contract** shall not be different from or in excess of the statements and documentation made pursuant to this Article 30.

30.2 In addition to the foregoing statements, the **Contractor** shall, upon notice from the **Commissioner**, produce for examination at the **Contractor's** office, by the **Engineer, Architect or Project Manager**, all of its books of account, bills, invoices, payrolls, subcontracts, time books, daily reports, bank deposit books, bank statements, check books, and cancelled checks, showing all of its acts and transactions in connection with or relating to or arising by reason of this **Contract**, and submit itself and persons in its employment, for examination under oath by any person designated by the **Commissioner** or **Comptroller** to investigate claims made or disputes against the **City** under this **Contract**. At such examination, a duly authorized representative of the **Contractor** may be present.

30.3 In addition to the statements required under Article 28 and this Article 30, the **Contractor** and/or its **Subcontractor** shall, within thirty (30) **Days** upon notice from the **Commissioner** or **Comptroller**, produce for examination at the **Contractor's** and/or **Subcontractor's** office, by a representative of either the **Commissioner** or **Comptroller**, all of its books of account, bid documents, financial statements, accountant workpapers, bills, invoices, payrolls, subcontracts, time books, daily reports, bank deposit books, bank statements, check books, and cancelled checks, showing all of its acts and transactions in connection with or relating to or arising by reason of this **Contract**. Further, the **Contractor** and/or its **Subcontractor** shall submit any person in its employment, for examination under oath by any person designated by the **Commissioner** or **Comptroller** to investigate claims made or disputes against the **City** under this **Contract**. At such examination, a duly authorized representative of the **Contractor** may be present.

30.4 Unless the information and examination required under Article 30.3 is provided by the **Contractor** and/or its **Subcontractor** upon thirty (30) **Days'** notice from the **Commissioner** or **Comptroller**, or upon the **Commissioner's** or **Comptroller's** written authorization to extend the time to comply, the **City** shall be released from all claims arising under, relating to or by reason of this **Contract**, except for sums certified by the **Commissioner** to be due under the provisions of this **Contract**. It is further stipulated and agreed that no person has the power to waive any of the foregoing provisions and that in any action or dispute resolution procedure against the **City** to recover any sum in excess of the sums certified by the **Commissioner** to be due under or by reason of this **Contract**, the **Contractor** must allege in its complaint and prove, at trial or during such dispute resolution procedure, compliance with the provisions of this Article 30.

30.5 In addition, after the commencement of any action or dispute resolution procedure by the **Contractor** arising under or by reason of this **Contract**, the **City** shall have the right to require the **Contractor** to produce for examination under oath, up until the trial of the action or hearing before the Contract Dispute Resolution Board, the books and documents described in Article 30.3 and submit itself and all persons in its employ for examination under oath. If this Article 30 is not complied with as required, then the **Contractor** hereby consents to the dismissal of the action or dispute resolution procedure.

CHAPTER VII
POWERS OF THE RESIDENT ENGINEER,
THE ENGINEER OR ARCHITECT AND THE COMMISSIONER

ARTICLE 31. THE RESIDENT ENGINEER

31.1 The **Resident Engineer** shall have the power to inspect, supervise, and control the performance of the **Work**, subject to review by the **Commissioner**. The **Resident Engineer** shall not, however, have the power to issue an **Extra Work** order, except as specifically designated in writing by the **Commissioner**.

ARTICLE 32. THE ENGINEER OR ARCHITECT OR PROJECT MANAGER

32.1 The **Engineer** or **Architect** or **Project Manager**, in addition to those matters elsewhere herein delegated to the **Engineer** and expressly made subject to his/her determination, direction or approval, shall have the power, subject to review by the **Commissioner**:

32.1.1 To determine the amount, quality, and location of the **Work** to be paid for hereunder; and

32.1.2 To determine all questions in relation to the **Work**, to interpret the **Contract Drawings, Specifications, and Addenda**, and to resolve all patent inconsistencies or ambiguities therein; and

32.1.3 To determine how the **Work** of this **Contract** shall be coordinated with **Work** of **Other Contractors** engaged simultaneously on this **Project**, including the power to suspend any part of the **Work**, but not the whole thereof; and

32.1.4 To make minor changes in the **Work** as he/she deems necessary, provided such changes do not result in a net change in the cost to the **City** or to the **Contractor** of the **Work** to be done under the **Contract**; and

32.1.5 To amplify the **Contract Drawings**, add explanatory information and furnish additional **Specifications** and drawings, consistent with this **Contract**.

32.2 The foregoing enumeration shall not imply any limitation upon the power of the **Engineer** or **Architect** or **Project Manager**, for it is the intent of this **Contract** that all of the **Work** shall generally be subject to his/her determination, direction, and approval, except where the determination, direction or approval of someone other than the **Engineer** or **Architect** or **Project Manager** is expressly called for herein.

32.3 The **Engineer** or **Architect** or **Project Manager** shall not, however, have the power to issue an **Extra Work** order, except as specifically designated in writing by the **Commissioner**.

ARTICLE 33. THE COMMISSIONER

33.1 The **Commissioner**, in addition to those matters elsewhere herein expressly made subject to his/her determination, direction or approval, shall have the power:

33.1.1 To review and make determinations on any and all questions in relation to this **Contract** and its performance; and

33.1.2 To modify or change this **Contract** so as to require the performance of **Extra Work** (subject, however, to the limitations specified in Article 25) or the omission of **Contract Work**; and

33.1.3 To suspend the whole or any part of the **Work** whenever in his/her judgment such suspension is required:

33.1.3(a) In the interest of the **City** generally; or

33.1.3(b) To coordinate the **Work** of the various contractors engaged on this **Project** pursuant to the provisions of Article 12; or

33.1.3(c) To expedite the completion of the entire **Project** even though the completion of this particular **Contract** may thereby be delayed.

ARTICLE 34. NO ESTOPPEL

34.1 Neither the **City** nor any **Agency**, official, agent or employee thereof, shall be bound, precluded or estopped by any determination, decision, approval, order, letter, payment or certificate made or given under or in connection with this **Contract** by the **City**, the **Commissioner**, the **Engineer**, the **Resident Engineer**, or any other official, agent or employee of the **City**, either before or after the final completion and acceptance of the **Work** and payment therefor:

34.1.1 From showing the true and correct classification, amount, quality or character of the **Work** actually done; or that any such determination, decision, order, letter, payment or certificate was untrue, incorrect or improperly made in any particular, or that the **Work**, or any part thereof, does not in fact conform to the requirements of this **Contract**; and

34.1.2 From demanding and recovering from the **Contractor** any overpayment made to it, or such damages as the **City** may sustain by reason of the **Contractor's** failure to perform each and every part of its **Contract**.

CHAPTER VIII LABOR PROVISIONS

ARTICLE 35. EMPLOYEES

35.1 The **Contractor** and its **Subcontractors** shall not employ on the **Work**:

35.1.1 Anyone who is not competent, faithful and skilled in the **Work** for which he/she shall be employed; and whenever the **Commissioner** shall inform the **Contractor**, in writing, that any employee is, in his/her opinion, incompetent, unfaithful or disobedient, that employee shall be discharged from the **Work** forthwith, and shall not again be employed upon it; or

35.1.2 Any labor, materials or means whose employment, or utilization during the course of this **Contract**, may tend to or in any way cause or result in strikes, work stoppages, delays, suspension of **Work** or similar troubles by workers employed by the **Contractor** or its **Subcontractors**, or by any of the trades working in or about the buildings and premises where **Work** is being performed under this **Contract**, or by **Other Contractors** or their **Subcontractors** pursuant to other contracts, or on any other building or premises owned or operated by the **City**, its **Agencies**, departments, boards or authorities. Any violation by the **Contractor** of this requirement may, upon certification of the **Commissioner**, be considered as proper and sufficient cause for declaring the **Contractor** to be in default, and for the **City** to take action against it as set forth in Chapter X of this **Contract**, or such other article of this **Contract** as the **Commissioner** may deem proper; or

35.1.3 In accordance with Section 220.3-e of the Labor Law of the State of New York (hereinafter "Labor Law"), the **Contractor** and its **Subcontractors** shall not employ on the **Work** any apprentice, unless he/she is a registered individual, under a bona fide program

registered with the New York State Department of Labor. The allowable ratio of apprentices to journey-level workers in any craft classification shall not be greater than the ratio permitted to the **Contractor** as to its work force on any job under the registered program. Any employee listed on a payroll at an apprentice wage rate, who is not registered as above, shall be paid the wage rate determined by the **Comptroller** of the **City** for the classification of **Work** actually performed. The **Contractor** or **Subcontractor** will be required to furnish written evidence of the registration of its program and apprentices as well as all the appropriate ratios and wage rates, for the area of the construction prior to using any apprentices on the **Contract Work**.

35.2 If the total cost of the **Work** under this **Contract** is at least two hundred fifty thousand (\$250,000) dollars, all laborers, workers, and mechanics employed in the performance of the **Contract** on the public work site, either by the **Contractor**, **Subcontractor** or other person doing or contracting to do the whole or a part of the **Work** contemplated by the **Contract**, shall be certified prior to performing any **Work** as having successfully completed a course in construction safety and health approved by the United States Department of Labor's Occupational Safety and Health Administration that is at least ten (10) hours in duration.

35.3 In accordance with Local Law Nos. 30-2012 and 33-2012, codified at sections 6-132 and 12-113 of the Administrative Code, respectively,

35.3.1 The **Contractor** shall not take an adverse personnel action with respect to an officer or employee in retaliation for such officer or employee making a report of information concerning conduct which such officer or employee knows or reasonably believes to involve corruption, criminal activity, conflict of interest, gross mismanagement or abuse of authority by any officer or employee relating to this **Contract** to (a) the Commissioner of the Department of Investigation, (b) a member of the New York City Council, the Public Advocate, or the **Comptroller**, or (c) the **CCPO**, **ACCO**, **Agency** head, or **Commissioner**.

35.3.2 If any of the **Contractor's** officers or employees believes that he or she has been the subject of an adverse personnel action in violation of Article 35.3.1, he or she shall be entitled to bring a cause of action against the **Contractor** to recover all relief necessary to make him or her whole. Such relief may include but is not limited to: (a) an injunction to restrain continued retaliation, (b) reinstatement to the position such employee would have had but for the retaliation or to an equivalent position, (c) reinstatement of full fringe benefits and seniority rights, (d) payment of two times back pay, plus interest, and (e) compensation for any special damages sustained as a result of the retaliation, including litigation costs and reasonable attorney's fees.

35.3.3 The **Contractor** shall post a notice provided by the **City** in a prominent and accessible place on any site where work pursuant to the **Contract** is performed that contains information about:

35.3.3(a) how its employees can report to the New York City Department of Investigation allegations of fraud, false claims, criminality or corruption arising out of or in connection with the **Contract**; and

35.3.3(b) the rights and remedies afforded to its employees under Administrative Code sections 7-805 (the New York City False Claims Act) and 12-113 (the Whistleblower Protection Expansion Act) for lawful acts taken in connection with the reporting of allegations of fraud, false claims, criminality or corruption in connection with the **Contract**.

35.3.4 For the purposes of this Article 35.3, "adverse personnel action" includes dismissal, demotion, suspension, disciplinary action, negative performance evaluation, any action resulting in loss of staff, office space, equipment or other benefit, failure to appoint, failure to promote, or any transfer or assignment or failure to transfer or assign against the wishes of the affected officer or employee.

35.3.5 This Article 35.3 is applicable to all of the **Contractor's Subcontractors** having subcontracts with a value in excess of \$100,000; accordingly, the **Contractor** shall include this rider in all subcontracts with a value a value in excess of \$100,000.

35.4 Article 35.3 is not applicable to this **Contract** if it is valued at \$100,000 or less. Articles 35.3.1, 35.3.2, 35.3.4, and 35.3.5 are not applicable to this **Contract** if it was solicited pursuant to a finding of an emergency.

ARTICLE 36. NO DISCRIMINATION

36.1 The **Contractor** specifically agrees, as required by Labor Law Section 220-e, as amended, that:

36.1.1 In the hiring of employees for the performance of **Work** under this **Contract** or any subcontract hereunder, neither the **Contractor**, **Subcontractor**, nor any person acting on behalf of such **Contractor** or **Subcontractor**, shall by reason of race, creed, color or national origin discriminate against any citizen of the State of New York who is qualified and available to perform the **Work** to which the employment relates;

36.1.2 Neither the **Contractor**, **Subcontractor**, nor any person on its behalf shall, in any manner, discriminate against or intimidate any employee hired for the performance of **Work** under this **Contract** on account of race, creed, color or national origin;

36.1.3 There may be deducted from the amount payable to the **Contractor** by the **City** under this **Contract** a penalty of fifty (\$50.00) dollars for each person for each **Day** during which such person was discriminated against or intimidated in violation of the provisions of this **Contract**; and

36.1.4 This **Contract** may be cancelled or terminated by the **City** and all moneys due or to become due hereunder may be forfeited, for a second or any subsequent violation of the terms or conditions of this Article 36.

36.1.5 This Article 36 covers all construction, alteration and repair of any public building or public work occurring in the State of New York and the manufacture, sale, and distribution of materials, equipment, and supplies to the extent that such operations are performed within the State of New York pursuant to this **Contract**.

36.2 The **Contractor** specifically agrees, as required by Section 6-108 of the Administrative Code, as amended, that:

36.2.1 It shall be unlawful for any person engaged in the construction, alteration or repair of buildings or engaged in the construction or repair of streets or highways pursuant to a **Contract** with the **City** or engaged in the manufacture, sale or distribution of materials, equipment or supplies pursuant to a **Contract** with the **City** to refuse to employ or to refuse to continue in any employment any person on account of the race, color or creed of such person.

36.2.2 It shall be unlawful for any person or any servant, agent or employee of any person, described in Article 36.1.2, to ask, indicate or transmit, orally or in writing, directly or indirectly, the race, color or creed or religious affiliation of any person employed or seeking employment from such person, firm or corporation.

36.2.3 Breach of the foregoing provisions shall be deemed a violation of a material provision of this **Contract**.

36.2.4 Any person, or the employee, manager or owner of or officer of such firm or corporation who shall violate any of the provisions of this Article 36.2 shall, upon conviction thereof, be punished by a fine of not more than one hundred (\$100.00) dollars or by imprisonment for not more than thirty (30) **Days**, or both.

36.3 This **Contract** is subject to the requirements of Executive Order No. 50 (1980) ("E.O. 50"), as revised, and the rules and regulations promulgated thereunder. No contract will be awarded unless and until these requirements have been complied with in their entirety. By signing this **Contract**, the **Contractor** agrees that it:

36.3.1 Will not engage in any unlawful discrimination against any employee or applicant for employment because of race, creed, color, national origin, sex, age, disability, marital status or sexual orientation with respect to all employment decisions including, but not limited to, recruitment, hiring, upgrading, demotion, downgrading, transfer, training, rates of pay or other forms of compensation, layoff, termination, and all other terms and conditions of employment; and

36.3.2 Will not engage in any unlawful discrimination in the selection of **Subcontractors** on the basis of the owner's race, color, creed, national origin, sex, age, disability, marital status or sexual orientation; and

36.3.3 Will state in all solicitations or advertisements for employees placed by or on behalf of the **Contractor** that all qualified applicants will receive consideration for employment without unlawful discrimination based on race, creed, color, national origin, sex, age, citizens status, disability, marital status, sexual orientation, or that it is an equal employment opportunity employer; and

36.3.4 Will send to each labor organization or representative of workers with which it has a collective bargaining agreement or other contract or memorandum of understanding, written notification of its equal employment opportunity commitments under E.O. 50 and the rules and regulations promulgated thereunder; and

36.3.5 Will furnish, before the award of the **Contract**, all information and reports, including an employment report, that are required by E.O. 50, the rules and regulations promulgated thereunder, and orders of the **City** Department of Business Services, Division of Labor Services (**DLS**) and will permit access to its books, records, and accounts by the **DLS** for the purposes of investigation to ascertain compliance with such rules, regulations, and orders.

36.4 The **Contractor** understands that in the event of its noncompliance with the nondiscrimination clauses of this **Contract** or with any of such rules, regulations, or orders, such noncompliance shall constitute a material breach of this **Contract** and noncompliance with E.O. 50 and the rules and regulations promulgated thereunder. After a hearing held pursuant to the rules of the **DLS**, the Director of the **DLS** may direct the **Commissioner** to impose any or all of the following sanctions:

36.4.1 Disapproval of the **Contractor**; and/or

36.4.2 Suspension or termination of the **Contract**; and/or

36.4.3 Declaring the **Contractor** in default; and/or

36.4.4 In lieu of any of the foregoing sanctions, the Director of the **DLS** may impose an employment program.

In addition to any actions taken under this **Contract**, failure to comply with E.O. 50 and the rules and regulations promulgated thereunder, in one or more instances, may result in a **City Agency** declaring the **Contractor** to be non-responsible in future procurements. The **Contractor** further agrees that it will refrain from entering into any **Contract** or **Contract** modification subject to E.O. 50 and the rules and regulations promulgated thereunder with a **Subcontractor** who is not in compliance with the requirements of E.O. 50 and the rules and regulations promulgated thereunder.

36.5 The **Contractor** specifically agrees, as required by Section 6-123 of the Administrative Code, that:

36.5.1 The **Contractor** will not engage in any unlawful discriminatory practice in violation of Title 8 of the Administrative Code; and

36.5.2 Any failure to comply with this Article 36.5 may subject the **Contractor** to the remedies set forth in Section 6-123 of the Administrative Code, including, where appropriate, sanctions such as withholding of payment, imposition of an employment program, finding the **Contractor** to be in default, cancellation of the **Contract**, or any other sanction or remedy provided by **Law** or **Contract**.

ARTICLE 37. LABOR LAW REQUIREMENTS

37.1 The **Contractor** shall strictly comply with all applicable provisions of the Labor Law, as amended. Such compliance is a material term of this **Contract**.

37.2 The **Contractor** specifically agrees, as required by Labor Law Sections 220 and 220-d, as amended, that:

37.2.1 **Hours of Work:** No laborer, worker, or mechanic in the employ of the **Contractor**, **Subcontractor** or other person doing or contracting to do the whole or a part of the **Work** contemplated by this **Contract** shall be permitted or required to work more than eight (8) hours in any one (1) **Day**, or more than five (5) **Days** in any one (1) week, except as provided in the Labor Law and in cases of extraordinary emergency including fire, flood, or danger to life or property, or in the case of national emergency when so proclaimed by the President of the United States of America.

37.2.2 In situations in which there are not sufficient laborers, workers, and mechanics who may be employed to carry on expeditiously the **Work** contemplated by this **Contract** as a result of such restrictions upon the number of hours and **Days** of labor, and the immediate commencement or prosecution or completion without undue delay of the **Work** is necessary for the preservation of the **Site** and/or for the protection of the life and limb of the persons using the same, such laborers, workers, and mechanics shall be permitted or required to

work more than eight (8) hours in any one (1) **Day**; or five (5) **Days** in any one (1) week; provided, however, that upon application of any **Contractor**, the **Commissioner** shall have first certified to the Commissioner of Labor of the State of New York (hereinafter "**Commissioner of Labor**") that such public **Work** is of an important nature and that a delay in carrying it to completion would result in serious disadvantage to the public; and provided, further, that such **Commissioner of Labor** shall have determined that such an emergency does in fact exist as provided in Labor Law Section 220.2.

37.2.3 Failure of the **Commissioner** to make such a certification to the **Commissioner of Labor** shall not entitle the **Contractor** to damages for delay or for any cause whatsoever.

37.2.4 **Prevailing Rate of Wages**: The wages to be paid for a legal day's **Work** to laborers, workers, or mechanics employed upon the **Work** contemplated by this **Contract** or upon any materials to be used thereon shall not be less than the "prevailing rate of wage" as defined in Labor Law Section 220, and as fixed by the **Comptroller** in the attached Schedule of Wage Rates and in updated schedules thereof. The prevailing wage rates and supplemental benefits to be paid are those in effect at the time the **Work** is being performed.

37.2.5 Requests for interpretation or correction in the Information for Bidders includes all requests for clarification of the classification of trades to be employed in the performance of the **Work** under this **Contract**. In the event that a trade not listed in the **Contract** is in fact employed during the performance of this **Contract**, the **Contractor** shall be required to obtain from the **Agency** the prevailing wage rates and supplementary benefits for the trades used and to complete the performance of this **Contract** at the price at which the **Contract** was awarded.

37.2.6 **Minimum Wages**: Except for employees whose wage is required to be fixed pursuant to Labor Law Section 220, all persons employed by the **Contractor** and any **Subcontractor** in the manufacture or furnishing of the supplies, materials, or equipment, or the furnishing of work, labor, or services, used in the performance of this **Contract**, shall be paid, without subsequent deduction or rebate unless expressly authorized by **Law**, not less than the sum mandated by **Law**.

37.3 **Working Conditions**: No part of the **Work**, labor or services shall be performed or rendered by the **Contractor** in any plants, factories, buildings or surroundings or under working conditions which are unsanitary or hazardous or dangerous to the health and safety of employees engaged in the performance of this **Contract**. Compliance with the safety, sanitary, and factory inspection **Laws** of the state in which the **Work** is to be performed shall be prima facie evidence of compliance with this Article 37.3.

37.4 **Prevailing Wage Enforcement**: The **Contractor** agrees to pay for all costs incurred by the **City** in enforcing prevailing wage requirements, including the cost of any investigation conducted by or on behalf of the **Agency** or the **Comptroller**, where the **City** discovers a failure to comply with any of the requirements of this Article 37 by the **Contractor** or its **Subcontractor(s)**. The **Contractor** also agrees that, should it fail or refuse to pay for any such investigation, the **Agency** is hereby authorized to deduct from a **Contractor's** account an amount equal to the cost of such investigation.

37.4.1 The Labor Law Section 220 and Section 220-d, as amended, provide that this **Contract** shall be forfeited and no sum paid for any **Work** done hereunder on a second conviction for willfully paying less than:

37.4.1(a) The stipulated prevailing wage scale as provided in Labor Law section 220, as amended, or

37.4.1(b) The stipulated minimum hourly wage scale as provided in Labor Law section 220-d, as amended.

37.4.2 For any breach or violation of either working conditions (Article 37.3) or minimum wages (Article 37.2.6) provisions, the party responsible therefor shall be liable to the **City** for liquidated damages, which may be withheld from any amounts due on any contracts with the **City** of such party responsible, or may be recovered in actions brought by the **City** Corporation Counsel in the name of the **City**, in addition to damages for any other breach of this **Contract**, for a sum equal to the amount of any underpayment of wages due to any employee engaged in the performance of this **Contract**. In addition, the **Commissioner** shall have the right to cancel contracts and enter into other contracts for the completion of the original contract, with or without public letting, and the original **Contractor** shall be liable for any additional cost. All sums withheld or recovered as deductions, rebates, refunds, or underpayment of wages hereunder, shall be held in a special deposit account and shall be paid without interest, on order of the **Comptroller**, directly to the employees who have been paid less than minimum rates of pay as set forth herein and on whose account such sums were withheld or recovered, provided that no claims by employees for such payments shall be entertained unless made within two (2) years from the date of actual notice to the **Contractor** of the withholding or recovery of such sums by the **City**.

37.4.3 A determination by the **Comptroller** that a **Contractor** and/or its **Subcontractor** willfully violated Labor Law Section 220 will be forwarded to the **City's** five District Attorneys for review.

37.4.4 The **Contractor's** or **Subcontractor's** noncompliance with this Article 37.4 and Labor Law Section 220 may result in an unsatisfactory performance evaluation and the **Comptroller** may also find and determine that the **Contractor** or **Subcontractor** willfully violated the New York Labor Law.

37.4.4(a) An unsatisfactory performance evaluation for noncompliance with this Article 37.4 may result in a determination that the **Contractor** is a non-responsible bidder on subsequent procurements with the **City** and thus a rejection of a future award of a contract with the **City**, as well as any other sanctions provided for by **Law**.

37.4.4(b) Labor Law Section 220-b, as amended, provides that when two (2) final determinations have been rendered against a **Contractor** or **Subcontractor** within any consecutive six (6) year period determining that such **Contractor** or **Subcontractor** has willfully failed to pay the prevailing rate of wages or to provide supplements in accordance with the Labor Law and this Article 37.4, whether such failures were concurrent or consecutive and whether or not such final determinations concerning separate public works projects are rendered simultaneously, such **Contractor** or **Subcontractor** shall be ineligible to submit a bid on or be awarded any public works contract with the **City** for a period of five (5) years from the second final determination. If the final determination involves the falsification of payroll records or the kickback of wages or supplements, the **Contractor** or **Subcontractor** shall be ineligible to submit a bid on or be awarded any public works contract with the **City** for a period of five (5) years from the first final determination.

37.4.4(c) Labor Law Section 220, as amended, provides that the **Contractor** or **Subcontractor** found to have violated this Article 37.4 may be directed to make payment of wages or supplements including interest found to be due, and the **Contractor** or **Subcontractor** may be directed to make payment of a further sum as

a civil penalty in an amount not exceeding twenty-five (25%) percent of the total amount found to be due.

37.5 The **Contractor** and its **Subcontractors** shall within ten (10) **Days** after mailing of a Notice of Award or written order, post in prominent and conspicuous places in each and every plant, factory, building, and structure where employees of the **Contractor** and its **Subcontractors** engaged in the performance of this **Contract** are employed, notices furnished by the **City**, in relation to prevailing wages and supplements, minimum wages, and other stipulations contained in Sections 220 and 220-h of the Labor Law, and the **Contractor** and its **Subcontractors** shall continue to keep such notices posted in such prominent and conspicuous places until **Final Acceptance** of the supplies, materials, equipment, or **Work**, labor, or services required to be furnished or rendered under this **Contract**.

37.6 The **Contractor** shall strictly comply with all of the provisions of Articles 37.6.1 through 37.6.5, and provide for all workers, laborers or mechanics in its employ, the following:

37.6.1 **Notices Posted At Site:** Post, in a location designated by the **City**, schedules of prevailing wages and supplements for this **Project**, a copy of all re-determinations of such schedules for the **Project**, the Workers' Compensation Law Section 51 notice, all other notices required by Law to be posted at the **Site**, the **City** notice that this **Project** is a public works project on which each worker is entitled to receive the prevailing wages and supplements for the occupation at which he or she is working, and all other notices which the **City** directs the **Contractor** to post. The **Contractor** shall provide a surface for such notices which is satisfactory to the **City**. The **Contractor** shall maintain and keep current such notices in a legible manner and shall replace any notice or schedule which is damaged, defaced, illegible or removed for any reason. The **Contractor** shall post such notices before commencing any **Work** on the **Site** and shall maintain such notices until all **Work** on the **Site** is complete; and

37.6.2 **Daily Site Sign-in Sheets:** Maintain daily **Site** sign-in sheets, and require that **Subcontractors** maintain daily **Site** sign-in sheets for its employees, which include blank spaces for an employee's name to be both printed and signed, job title, date started and Social Security number, the time the employee began work and the time the employee left work, until **Final Acceptance** of the supplies, materials, equipment, or **Work**, labor, or services to be furnished or rendered under this **Contract** unless exception is granted by the **Comptroller** upon application by the **Agency**. In the alternative, subject to the approval of the **CCPO**, the **Contractor** and **Subcontractor** may maintain an electronic or biometric sign-in system, which provides the information required by this Article 37.6.2; and

37.6.3 **Individual Employee Information Notices:** Distribute a notice to each worker, laborer or mechanic employed under this **Contract**, in a form provided by the **Agency**, that this **Project** is a public works project on which each worker, laborer or mechanic is entitled to receive the prevailing rate of wages and supplements for the occupation at which he or she is working. If the total cost of the **Work** under this **Contract** is at least two hundred fifty thousand (\$250,000) dollars, such notice shall also include a statement that each worker, laborer or mechanic must be certified prior to performing any **Work** as having successfully completed a course in construction safety and health approved by the United States Department of Labor's Occupational Safety and Health Administration that is at least ten (10) hours in duration. Such notice shall be distributed to each worker before he or she starts performing any **Work** of this **Contract** and with the first paycheck after July first of each year. "Worker, laborer or mechanic" includes employees of the **Contractor** and all **Subcontractors** and all employees of suppliers entering the **Site**. At the time of distribution, the **Contractor** shall have each worker, laborer or mechanic sign a statement, in a form provided by the **Agency**, certifying that the worker has received the notice required by this

Article 37.6.3, which signed statement shall be maintained with the payroll records required by this **Contract**; and

37.6.3(a) The **Contractor** and each **Subcontractor** shall notify each worker, laborer or mechanic employed under this **Contract** in writing of the prevailing rate of wages for their particular job classification. Such notification shall be given to every worker, laborer, and mechanic on their first pay stub and with every pay stub thereafter; and

37.6.4 **Site Laminated Identification Badges:** The **Contractor** shall provide laminated identification badges which include a photograph of the worker's, laborer's or mechanic's face and indicate the worker's, laborer's or mechanic's name, trade, employer's name, and employment starting date (month/day/year). Further, the **Contractor** shall require as a condition of employment on the **Site**, that each and every worker, laborer or mechanic wear the laminated identification badge at all times and that it may be seen by any representative of the **City**. The **Commissioner** may grant a written waiver from the requirement that the laminated identification badge include a photograph if the **Contractor** demonstrates that the identity of an individual wearing a laminated identification badge can be easily verified by another method; and

37.6.5 **Language Other Than English Used On Site:** Provide the **ACCO** notice when three (3) or more employees (worker and/or laborer and/or mechanic) on the **Site**, at any time, speak a language other than English. The **ACCO** will then provide the **Contractor** the notices described in Article 37.6.1 in that language or languages as may be required. The **Contractor** is responsible for all distributions under this Article 37; and

37.6.6 **Provision of Records:** The **Contractor** and **Subcontractor(s)** shall produce within five (5) **Days** on the **Site** of the **Work** and upon a written order of the **Engineer**, the **Commissioner**, the **ACCO**, the **Agency EAO**, or the **Comptroller**, such records as are required to be kept by this Article 37.6; and

37.6.7 The **Contractor** and **Subcontractor(s)** shall pay employees by check or direct deposit. If this **Contract** is for an amount greater than one million (\$1,000,000) dollars, checks issued by the **Contractor** to covered employees shall be generated by a payroll service or automated payroll system (an in-house system may be used if approved by the **Agency**). For any subcontract for an amount greater than seven hundred fifty thousand (\$750,000) dollars, checks issued by a **Subcontractor** to covered employees shall be generated by a payroll service or automated payroll system (an in-house system may be used if approved by the **Agency**); and

37.6.8 The failure of the **Contractor** or **Subcontractor(s)** to comply with the provisions of Articles 37.6.1 through 37.6.7 may result in the **Commissioner** declaring the **Contractor** in default and/or the withholding of payments otherwise due under the **Contract**.

37.7 The **Contractor** and its **Subcontractors** shall keep such employment and payroll records as are required by Section 220 of the Labor Law. The failure of the **Contractor** or **Subcontractor(s)** to comply with the provisions of this Article 37.7 may result in the **Commissioner** declaring the **Contractor** in default and/or the withholding of payments otherwise due under the **Contract**.

37.8 At the time the **Contractor** makes application for each partial payment and for final payment, the **Contractor** shall submit to the **Commissioner** a written payroll certification, in the form provided by this **Contract**, of compliance with the prevailing wage, minimum wage, and other provisions and stipulations required by Labor Law Section 220 and of compliance with the training requirements of

Labor Law Section 220-h set forth in Article 35.2. This certification of compliance shall be a condition precedent to payment and no payment shall be made to the **Contractor** unless and until each such certification shall have been submitted to and received by the **Commissioner**.

37.9 This **Contract** is executed by the **Contractor** with the express warranty and representation that the **Contractor** is not disqualified under the provisions of Section 220 of the Labor Law from the award of the **Contract**.

37.10 Any breach or violation of any of the foregoing shall be deemed a breach or violation of a material provision of this **Contract**, and grounds for cancellation thereof by the **City**.

ARTICLE 38. PAYROLL REPORTS

38.1 The **Contractor** and its **Subcontractor(s)** shall maintain on the **Site** during the performance of the **Work** the original payrolls or transcripts thereof which the **Contractor** and its **Subcontractor(s)** are required to maintain and shall submit such original payrolls or transcripts, subscribed and affirmed by it as true, within thirty (30) **Days** after issuance of its first payroll, and every thirty (30) **Days** thereafter, pursuant to Labor Law Section 220(3-a)(a)(iii). The **Contractor** and **Subcontractor(s)** shall submit such original payrolls or transcripts along with each and every payment requisition. If payment requisitions are not submitted at least once a month, the **Contractor** and its **Subcontractor(s)** shall submit original payrolls and transcripts both along with its payment requisitions and independently of its payment requisitions.

38.2 The **Contractor** shall maintain payrolls or transcripts thereof for six (6) years from the date of completion of the **Work** on this **Contract**. If such payrolls and transcripts are maintained outside of New York City after the completion of the **Work** and their production is required pursuant to this Article 38, the **Contractor** shall produce such records in New York City upon request by the **City**.

38.3 The **Contractor** and **Subcontractor(s)** shall comply with any written order, direction, or request made by the **Engineer**, the **Commissioner**, the **ACCO**, the **Agency EAO**, the **Agency Labor Law Investigator(s)**, or the **Comptroller**, to provide to the requesting party any of the following information and/or records within five (5) **Days** of such written order, direction, or request:

38.3.1 Such original payrolls or transcripts thereof subscribed and affirmed by it as true and the statements signed by each worker pursuant to this Chapter VIII; and/or

38.3.2 Attendance sheets for each **Day** on which any employee of the **Contractor** and/or any of the **Subcontractor(s)** performed **Work** on the **Site**, which attendance sheet shall be in a form acceptable to the **Agency** and shall provide information acceptable to the **Agency** to identify each such employee; and/or

38.3.3 Any other information to satisfy the **Engineer**, the **Commissioner**, the **ACCO**, the **Agency EAO**, the **Agency Labor Law Investigator(s)** or the **Comptroller**, that this Chapter VIII and the Labor Law, as to the hours of employment and prevailing rates of wages and/or supplemental benefits, are being observed.

38.4 The failure of the **Contractor** or **Subcontractor(s)** to comply with the provisions of Articles 38.1 and/or 38.2 may result in the **Commissioner** declaring the **Contractor** in default and/or the withholding of payments otherwise due under the **Contract**.

ARTICLE 39. DUST HAZARDS

39.1 Should a harmful dust hazard be created in performing the **Work** of this **Contract**, for the elimination of which appliances or methods have been approved by the Board of Standards and Appeals of the City of New York, such appliances and methods shall be installed, maintained, and effectively operated during the continuance of such harmful dust hazard. Failure to comply with this provision after notice shall make this **Contract** voidable at the sole discretion of the **City**.

CHAPTER IX PARTIAL AND FINAL PAYMENTS

ARTICLE 40. CONTRACT PRICE

40.1 The **City** shall pay, and the **Contractor** agrees to accept, in full consideration for the **Contractor's** performance of the **Work** subject to the terms and conditions hereof, the lump sum price or unit prices for which this **Contract** was awarded, plus the amount required to be paid for any **Extra Work** ordered by the **Commissioner** under Article 25, less credit for any **Work** omitted pursuant to Article 29.

ARTICLE 41. BID BREAKDOWN ON LUMP SUM

41.1 Within fifteen (15) **Days** after the commencement date specified in the **Notice to Proceed** or **Order to Work**, unless otherwise directed by the **Resident Engineer**, the **Contractor** shall submit to the **Resident Engineer** a breakdown of its bid price, or of lump sums bid for items of the **Contract**, showing the various operations to be performed under the **Contract**, as directed in the progress schedule required under Article 9, and the value of each of such operations, the total of such items to equal the lump sum price bid. Said breakdown must be approved in writing by the **Resident Engineer**.

41.2 No partial payment will be approved until the **Contractor** submits a bid breakdown that is acceptable to the **Resident Engineer**.

41.3 The **Contractor** shall also submit such other information relating to the bid breakdown as directed by the **Resident Engineer**. Thereafter, the breakdown may be used only for checking the **Contractor's** applications for partial payments hereunder, but shall not be binding upon the **City**, the **Commissioner**, or the **Engineer** for any purpose whatsoever.

ARTICLE 42. PARTIAL PAYMENTS

42.1 From time to time as the **Work** progresses satisfactorily, but not more often than once each calendar month (except where the **Commissioner** approves in writing the submission of invoices on a more frequent basis and for invoices relating to **Work** performed pursuant to a change order), the **Contractor** may submit to the **Engineer** a requisition for a partial payment in the prescribed form, which shall contain an estimate of the quantity and the fair value of the **Work** done during the payment period.

42.2 Partial payments may be made for materials, fixtures, and equipment in advance of their actual incorporation in the **Work**, as the **Commissioner** may approve, and upon the terms and conditions set forth in the General Conditions.

42.3 The **Contractor** shall also submit to the **Commissioner** in connection with every application for partial payment a verified statement in the form prescribed by the **Comptroller** setting forth the information required under Labor Law Section 220-a.

42.4 Within thirty (30) **Days** after receipt of a satisfactory payment application, and within sixty (60) **Days** after receipt of a satisfactory payment application in relation to **Work** performed pursuant to a change order, the **Engineer** will prepare and certify, and the **Commissioner** will approve, a voucher for a partial payment in the amount of such approved estimate, less any and all deductions authorized to be made by the **Commissioner** under the terms of this **Contract** or by **Law**.

ARTICLE 43. PROMPT PAYMENT

43.1 The Prompt Payment provisions of the **PPB** Rules in effect at the time of the bid will be applicable to payments made under this **Contract**. The provisions require the payment to the **Contractor** of interest on payments made after the required payment date, except as set forth in the **PPB** Rules.

43.2 The **Contractor** shall submit a proper invoice to receive payment, except where the **Contract** provides that the **Contractor** will be paid at predetermined intervals without having to submit an invoice for each scheduled payment.

43.3 Determination of interest due will be made in accordance with the **PPB** Rules.

43.4 If the **Contractor** is paid interest, the proportionate share(s) of that interest shall be forwarded by the **Contractor** to its **Subcontractor(s)**.

43.5 The **Contractor** shall pay each **Subcontractor** or **Materialman** not later than seven (7) **Days** after receipt of payment out of amounts paid to the **Contractor** by the **City** for **Work** performed by the **Subcontractor** or **Materialman** under this **Contract**.

43.5.1 If **Contractor** fails to make any payment to any **Subcontractor** or **Materialman** within seven (7) **Days** after receipt of payment by the **City** pursuant to this Article 43.5, then the **Contractor** shall pay interest on amounts due to such **Subcontractor** or **Materialman** at the rate of interest in effect on the date such payment is made by the **Contractor** computed in accordance with Section 756-b (1)(b) of the New York General Business Law. Accrual of interest shall commence on the **Day** immediately following the expiration of the seventh **Day** following receipt of payment by the **Contractor** from the **City** and shall end on the date on which payment is made.

43.6 The **Contractor** shall include in each of its subcontracts a provision requiring each **Subcontractor** to make payment to each of its **Subcontractors** or **Materialmen** for **Work** performed under this **Contract** in the same manner and within the same time period set forth above.

ARTICLE 44. SUBSTANTIAL COMPLETION PAYMENT

44.1 The **Contractor** shall submit with the **Substantial Completion** requisition:

44.1.1 A final verified statement of any pending Article 27 disputes in accordance with the **PPB** Rules and this **Contract** and any and all alleged claims against the **City**, in any way connected with or arising out of this **Contract** (including those as to which details may have been furnished pursuant to Articles 11, 27, 28, and 30) setting forth with respect to each

such claim the total amount thereof, the various items of labor and materials included therein, and the alleged value of each item; and if the alleged claim be one for delay, the alleged cause of each such delay, the period or periods of time, giving the dates when the **Contractor** claims the performance of the **Work** or a particular part thereof was delayed, and an itemized statement and breakdown of the amount claimed for each such delay.

44.1.1(a) With respect to each such claim, the **Commissioner**, the **Comptroller** and, in the event of litigation, the **City Corporation Counsel** shall have the same right to inspect, and to make extracts or copies of, the **Contractor's** books, vouchers, records, etc., as is referred to in Articles 11, 27, 28, and 30. Nothing contained in this Article 44.1.1(a) is intended to or shall relieve the **Contractor** from the obligation of complying strictly with Articles 11, 27, 28, and 30. The **Contractor** is warned that unless such claims are completely set forth as herein required, the **Contractor** upon acceptance of the **Substantial Completion** payment pursuant to this Article 44, will have waived any such claims.

44.1.2 A Final Approved Punch List.

44.1.3 Where required, a request for an extension of time to achieve **Substantial Completion** or final extension of time.

44.2 The **Commissioner** shall issue a voucher calling for payment of any part or all of the balance due for **Work** performed under the **Contract**, including monies retained under Article 21, less any and all deductions authorized to be made by the **Commissioner**, under this **Contract** or by **Law**, and less twice the amount the **Commissioner** considers necessary to ensure the completion of the balance of the **Work** by the **Contractor**. Such a payment shall be considered a partial and not a final payment. No **Substantial Completion** payment shall be made under this Article 44 where the **Contractor** failed to complete the **Work** within the time fixed for such completion in the Schedule A of the General Conditions, or within the time to which completion may have been extended, until an extension or extensions of time for the completion of **Work** have been acted upon pursuant to Article 13.

44.3 No further partial payments shall be made to the **Contractor** after **Substantial Completion**, except the **Substantial Completion** payment and payment pursuant to any **Contractor's** requisition that were properly filed with the **Commissioner** prior to the date of **Substantial Completion**; however, the **Commissioner** may grant a waiver for further partial payments after the date of **Substantial Completion** to permit payments for change order **Work** and/or release of retainage and deposits pursuant to Articles 21 and 24. Such waiver shall be in writing.

44.4 The **Contractor** acknowledges that nothing contained in this Article 44 is intended to or shall in any way diminish the force and effect of Article 13.

ARTICLE 45. FINAL PAYMENT

45.1 After completion and **Final Acceptance** of the **Work**, the **Contractor** shall submit all required certificates and documents, together with a requisition for the balance claimed to be due under the **Contract**, less the amount authorized to be retained for maintenance under Article 24. Such submission shall be within 90 days of the date of the **Commissioner's** written determination of **Final Acceptance**, or within such additional time as may be granted by the **Commissioner** in writing. If the **Contractor** fails to submit all required certificates and documents within the time allowed, no payment of the balance claimed shall be made to the **Contractor** and the **Contractor** shall be deemed to have forfeited its right to

payment of any balance claimed. A verified statement similar to that required in connection with applications for partial payments shall also be submitted to the **Commissioner**.

45.2 Amended Verified Statement of Claims: The **Contractor** shall also submit with the final requisition any amendments to the final verified statement of any pending dispute resolution procedures in accordance with the **PPB** Rules and this **Contract** and any and all alleged claims against the **City**, in any way connected with or arising out of this **Contract** (including those as to which details may have been furnished pursuant to Articles 11, 27, 28, and 30) that have occurred subsequent to **Substantial Completion**, setting forth with respect to each such claim the total amount thereof, the various items of labor and materials included therein, and the alleged value of each such item; and if the alleged claim be one for delay, the alleged cause of each such delay, the period or periods of time, giving the dates when the **Contractor** claims the performance of the **Work** or a particular part thereof was delayed, and an itemized statement and breakdown of the amount claimed for each such delay. With reference to each such claim, the **Commissioner**, the **Comptroller** and, in the event of litigation, the **City Corporation Counsel** shall have the same right to inspect, and to make extracts or copies of, the **Contractor's** books, vouchers, records, etc., as is referred to in Articles 11, 27, 28, and 30. Nothing contained in this Article 45.2, is intended to or shall relieve the **Contractor** from the obligation of complying strictly with Articles 11, 27, 28, and 30. The **Contractor** is warned that unless such claims are completely set forth as herein required, the **Contractor**, upon acceptance of the Final Payment pursuant to Article 46, will have waived any such claims.

45.3 Preparation of Final Voucher: Upon determining the balance due hereunder other than on account of claims, the **Engineer** will prepare and certify, for the **Commissioner's** approval, a voucher for final payment in that amount less any and all deductions authorized to be made by the **Commissioner** under this **Contract** or by **Law**. In the case of a lump sum **Contract**, the **Commissioner** shall certify the voucher for final payment within thirty (30) **Days** from the date of completion and acceptance of the **Work**, provided all requests for extensions of time have been acted upon.

45.3.1 All prior certificates and vouchers upon which partial payments were made, being merely estimates made to enable the **Contractor** to prosecute the **Work** more advantageously, shall be subject to correction in the final voucher, and the certification of the **Engineer** thereon and the approval of the **Commissioner** thereof, shall be conditions precedent to the right of the **Contractor** to receive any money hereunder. Such final voucher shall be binding and conclusive upon the **Contractor**.

45.3.2 Payment pursuant to such final voucher, less any deductions authorized to be made by the **Commissioner** under this **Contract** or by **Law**, shall constitute the final payment, and shall be made by the **Comptroller** within thirty (30) **Days** after the filing of such voucher in his/her office.

45.4 The **Contractor** acknowledges that nothing contained in this Article 45 is intended to or shall in any way diminish the force and effect of Article 13.

ARTICLE 46. ACCEPTANCE OF FINAL PAYMENT

46.1 The acceptance by the **Contractor**, or by anyone claiming by or through it, of the final payment, whether such payment be made pursuant to any judgment of any court, or otherwise, shall constitute and operate as a release of the **City** from any and all claims of and liability to the **Contractor** for anything heretofore done or furnished for the **Contractor** relating to or arising out of this **Contract** and the **Work** done hereunder, and for any prior act, neglect or default on the part of the **City** or any of its officials, agents or employees, excepting only a claim against the **City** for the amounts deducted or retained in accordance with the terms and provisions of this **Contract** or by **Law**, and excepting any

claims, not otherwise waived, or any pending dispute resolution procedures which are contained in the verified statement filed with the **Contractor's** substantial and final requisitions pursuant to Articles 44 and 45.

46.2 The **Contractor** is warned that the execution by it of a release, in connection with the acceptance of the final payment, containing language purporting to reserve claims other than those herein specifically excepted from the operation of this Article 46, or those for amounts deducted by the **Commissioner** from the final requisition or from the final payment as certified by the **Engineer** and approved by the **Commissioner**, shall not be effective to reserve such claims, anything stated to the **Contractor** orally or in writing by any official, agent or employee of the **City** to the contrary notwithstanding.

46.3 Should the **Contractor** refuse to accept the final payment as tendered by the **Comptroller**, it shall constitute a waiver of any right to interest thereon.

46.4 The **Contractor**, however, shall not be barred by this Article 46 from commencing an action for breach of **Contract** to the extent permitted by **Law** and by the terms of the **Contract** for any claims that are contained in the verified statement filed with the **Contractor's** substantial and final requisitions pursuant to Articles 44 and 45 or that arose after submission of the final payment requisition, provided that a detailed and verified statement of claim is served upon the contracting **Agency** and **Comptroller** not later than forty (40) **Days** after the making of such final payment by electronic funds transfer (EFT) or the mailing of such final payment. The statement shall specify the items upon which the claim will be based and any such claim shall be limited to such items.

ARTICLE 47. APPROVAL BY PUBLIC DESIGN COMMISSION

47.1 All works of art, including paintings, mural decorations, stained glass, statues, bas-reliefs, and other sculptures, monuments, fountains, arches, and other structures of a permanent character intended for ornament or commemoration, and every design of the same to be used in the performance of this **Contract**, and the design of all bridges, approaches, buildings, gates, fences, lamps, or structures to be erected, pursuant to the terms of this **Contract**, shall be submitted to the Art Commission, d/b/a the Public Design Commission of the City of New York, and shall be approved by the Public Design Commission prior to the erection or placing in position of the same. The final payment shall not become due or payable under this **Contract** unless and until the Public Design Commission shall certify that the design for the **Work** herein contracted for has been approved by the said Public Design Commission, and that the same has been executed in substantial accordance with the design so approved, pursuant to the provisions of Chapter 37, Section 854 of the **City Charter**, as amended.

CHAPTER X CONTRACTOR'S DEFAULT

ARTICLE 48. COMMISSIONER'S RIGHT TO DECLARE CONTRACTOR IN DEFAULT

48.1 In addition to those instances specifically referred to in other Articles herein, the **Commissioner** shall have the right to declare the **Contractor** in default of this **Contract** if:

48.1.1 The **Contractor** fails to commence **Work** when notified to do so by the **Commissioner**; or
if

48.1.2 The **Contractor** shall abandon the **Work**; or if

48.1.3 The **Contractor** shall refuse to proceed with the **Work** when and as directed by the **Commissioner**; or if

48.1.4 The **Contractor** shall, without just cause, reduce its working force to a number which, if maintained, would be insufficient, in the opinion of the **Commissioner**, to complete the **Work** in accordance with the progress schedule; or if

48.1.5 The **Contractor** shall fail or refuse to increase sufficiently such working force when ordered to do so by the **Commissioner**; or if

48.1.6 The **Contractor** shall sublet, assign, transfer, convert or otherwise dispose of this **Contract** other than as herein specified; or sell or assign a majority interest in the **Contractor**; or if

48.1.7 The **Contractor** fails to secure and maintain all required insurance; or if

48.1.8 A receiver or receivers are appointed to take charge of the **Contractor's** property or affairs; or if

48.1.9 The **Commissioner** shall be of the opinion that the **Contractor** is or has been unnecessarily or unreasonably or willfully delaying the performance and completion of the **Work**, or the award of necessary subcontracts, or the placing of necessary material and equipment orders; or if

48.1.10 The **Commissioner** shall be of the opinion that the **Contractor** is or has been willfully or in bad faith violating any of the provisions of this **Contract**; or if

48.1.11 The **Commissioner** shall be of the opinion that the **Work** cannot be completed within the time herein provided therefor or within the time to which such completion may have been extended; provided, however, that the impossibility of timely completion is, in the **Commissioner's** opinion, attributable to conditions within the **Contractor's** control; or if

48.1.12 The **Work** is not completed within the time herein provided therefor or within the time to which the **Contractor** may be entitled to have such completion extended; or if

48.1.13 Any statement or representation of the **Contractor** in the **Contract** or in any document submitted by the **Contractor** with respect to the **Work**, the **Project**, or the **Contract** (or for purposes of securing the **Contract**) was untrue or incorrect when made; or if

48.1.14 The **Contractor** or any of its officers, directors, partners, five (5%) percent shareholders, principals, or other persons substantially involved in its activities, commits any of the acts or omissions specified as the grounds for debarment in the **PPB Rules**.

48.2 Before the **Commissioner** shall exercise his/her right to declare the **Contractor** in default, the **Commissioner** shall give the **Contractor** an opportunity to be heard, upon not less than two (2) **Days** notice.

ARTICLE 49. EXERCISE OF THE RIGHT TO DECLARE DEFAULT

49.1 The right to declare the **Contractor** in default for any of the grounds specified or referred to in Article 48 shall be exercised by sending the **Contractor** a notice, signed by the **Commissioner**, setting forth the ground or grounds upon which such default is declared (hereinafter referred to as a "Notice of Default").

49.2 The **Commissioner's** determination that the **Contractor** is in default shall be conclusive, final, and binding on the parties and such a finding shall preclude the **Contractor** from commencing a plenary action for any damages relating to the **Contract**. If the **Contractor** protests the determination of the **Commissioner**, the **Contractor** may commence an action in a court of competent jurisdiction of the State of New York under Article 78 of the New York Civil Practice Law and Rules.

ARTICLE 50. QUITTING THE SITE

50.1 Upon receipt of such notice the **Contractor** shall immediately discontinue all further operations under this **Contract** and shall immediately quit the **Site**, leaving untouched all plant, materials, equipment, tools, and supplies then on the **Site**.

ARTICLE 51. COMPLETION OF THE WORK

51.1 The **Commissioner**, after declaring the **Contractor** in default, may then have the **Work** completed by such means and in such manner, by contract with or without public letting, or otherwise, as he/she may deem advisable, utilizing for such purpose such of the **Contractor's** plant, materials, equipment, tools, and supplies remaining on the **Site**, and also such **Subcontractors**, as he/she may deem advisable.

51.2 After such completion, the **Commissioner** shall make a certificate stating the expense incurred in such completion, which shall include the cost of re-letting and also the total amount of liquidated damages (at the rate provided for in the **Contract**) from the date when the **Work** should have been completed by the **Contractor** in accordance with the terms hereof to the date of actual completion of the **Work**. Such certificate shall be binding and conclusive upon the **Contractor**, its sureties, and any person claiming under the **Contractor**, as to the amount thereof.

51.3 The expense of such completion, including any and all related and incidental costs, as so certified by the **Commissioner**, and any liquidated damages assessed against the **Contractor**, shall be charged against and deducted out of monies which are earned by the **Contractor** prior to the date of default. Should the expense of such completion, as certified by the **Commissioner**, exceed the total sum which would have been payable under the **Contract** if it had been completed by the **Contractor**, any excess shall be paid by the **Contractor**.

ARTICLE 52. PARTIAL DEFAULT

52.1 In case the **Commissioner** shall declare the **Contractor** in default as to a part of the **Work** only, the **Contractor** shall discontinue such part, shall continue performing the remainder of the **Work** in strict conformity with the terms of this **Contract**, and shall in no way hinder or interfere with any **Other**

Contractor(s) or persons whom the **Commissioner** may engage to complete the **Work** as to which the **Contractor** was declared in default.

52.2 The provisions of this Chapter relating to declaring the **Contractor** in default as to the entire **Work** shall be equally applicable to a declaration of partial default, except that the **Commissioner** shall be entitled to utilize for completion of the part of the **Work** as to which the **Contractor** was declared in default only such plant, materials, equipment, tools, and supplies as had been previously used by the **Contractor** on such part.

ARTICLE 53. PERFORMANCE OF UNCOMPLETED WORK

53.1 In completing the whole or any part of the **Work** under the provisions of this Chapter X, the **Commissioner** shall have the power to depart from or change or vary the terms and provisions of this **Contract**, provided, however, that such departure, change or variation is made for the purpose of reducing the time or expense of such completion. Such departure, change or variation, even to the extent of accepting a lesser or different performance, shall not affect the conclusiveness of the **Commissioner's** certificate of the cost of completion referred to in Article 51, nor shall it constitute a defense to an action to recover the amount by which such certificate exceeds the amount which would have been payable to the **Contractor** hereunder but for its default.

ARTICLE 54. OTHER REMEDIES

54.1 In addition to the right to declare the **Contractor** in default pursuant to this Chapter X, the **Commissioner** shall have the absolute right, in his/her sole discretion and without a hearing, to complete or cause to be completed in the same manner as described in Articles 51 and 53, any or all unsatisfactory or uncompleted punch list **Work** that remains after the completion date specified in the **Final Approved Punch List**. A written notice of the exercise of this right shall be sent to the **Contractor** who shall immediately quit the **Site** in accordance with the provisions of Article 50.

54.2 The expense of completion permitted under Article 54.1, including any and all related and incidental costs, as so certified by the **Commissioner**, shall be charged against and deducted out of monies which have been earned by the **Contractor** prior to the date of the exercise of the right set forth in Article 54.1; the balance of such monies, if any, subject to the other provisions of this **Contract**, to be paid to the **Contractor** without interest after such completion. Should the expense of such completion, as certified by the **Commissioner**, exceed the total sum which would have been payable under the **Contract** if it had been completed by the **Contractor**, any excess shall be paid by the **Contractor**.

54.3 The previous provisions of this Chapter X shall be in addition to any and all other remedies available under **Law** or in equity.

54.4 The exercise by the **City** of any remedy set forth herein shall not be deemed a waiver by the **City** of any other legal or equitable remedy contained in this **Contract** or provided under **Law**.

**CHAPTER XI
MISCELLANEOUS PROVISIONS**

ARTICLE 55. CONTRACTOR'S WARRANTIES

55.1 In consideration of, and to induce, the award of this **Contract** to the **Contractor**, the **Contractor** represents and warrants:

55.1.1 That it is financially solvent, sufficiently experienced and competent to perform the **Work**; and

55.1.2 That the facts stated in its bid and the information given by it pursuant to the Information for Bidders is true and correct in all respects; and

55.1.3 That it has read and complied with all requirements set forth in the **Contract**.

ARTICLE 56. CLAIMS AND ACTIONS THEREON

56.1 Any claim, that is not subject to dispute resolution under the **PPB** Rules or this **Contract**, against the **City** for damages for breach of **Contract** shall not be made or asserted in any action, unless the **Contractor** shall have strictly complied with all requirements relating to the giving of notice and of information with respect to such claims, as herein before provided.

56.2 Nor shall any action be instituted or maintained on any such claims unless such action is commenced within six (6) months after **Substantial Completion**; except that:

56.2.1 Any claims arising out of events occurring after **Substantial Completion** and before **Final Acceptance** of the **Work** shall be asserted within six (6) months of **Final Acceptance** of the **Work**;

56.2.2 Any claims for monies deducted, retained or withheld under the provisions of this **Contract** shall be asserted within six (6) months after the date when such monies otherwise become due and payable hereunder; and

56.2.3 If the **Commissioner** exercises his/her right to terminate the **Contract** pursuant to Article 64, any such action shall be commenced within six (6) months of the date the **Commissioner** exercises said right.

ARTICLE 57. INFRINGEMENT

57.1 The **Contractor** shall be solely responsible for and shall defend, indemnify, and hold the **City** harmless from any and all claims (even if the allegations of the lawsuit are without merit) and judgments for damages and from costs and expenses to which the **City** may be subject to or which it may suffer or incur allegedly arising out of or in connection with any infringement by the **Contractor** of any copyright, trade secrets, trademark or patent rights or any other property or personal right of any third party by the **Contractor** and/or its **Subcontractors** in the performance or completion of the **Work**. Insofar as the facts or **Law** relating to any claim would preclude the **City** from being completely indemnified by the **Contractor**, the **City** shall be partially indemnified by the **Contractor** to the fullest extent permitted by **Law**.

ARTICLE 58. NO CLAIM AGAINST OFFICIALS, AGENTS OR EMPLOYEES

58.1 No claim whatsoever shall be made by the **Contractor** against any official, agent or employee of the **City** for, or on account of, anything done or omitted to be done in connection with this **Contract**.

ARTICLE 59. SERVICE OF NOTICES

59.1 The **Contractor** hereby designates the business address, fax number, and email address specified in its bid, as the place where all notices, directions or other communications to the **Contractor** may be delivered, or to which they may be mailed. Any notice, direction, or communication from either party to the other shall be in writing and shall be deemed to have been given when (i) delivered personally; (ii) sent by certified mail, return receipt requested; (iii) delivered by overnight or same day courier service in a properly addressed envelope with confirmation; or (iv) sent by fax or email and, unless receipt of the fax or e-mail is acknowledged by the recipient by fax or e-mail, deposited in a post office box regularly maintained by the United States Postal Service in a properly addressed, postage pre-paid envelope.

59.2 **Contractor's** notice address, email address, or fax number may be changed at any time by an instrument in writing, executed and acknowledged by the **Contractor**, and delivered to the **Commissioner**.

59.3 Nothing herein contained shall, however, be deemed to preclude or render inoperative the service of any notice, direction or other communication upon the **Contractor** personally, or, if the **Contractor** is a corporation, upon any officer thereof.

ARTICLE 60. UNLAWFUL PROVISIONS DEEMED STRICKEN FROM CONTRACT

60.1 If this **Contract** contains any unlawful provision not an essential part of the **Contract** and which shall not appear to have been a controlling or material inducement to the making thereof, the same shall be deemed of no effect and shall, upon notice by either party, be deemed stricken from the **Contract** without affecting the binding force of the remainder.

ARTICLE 61. ALL LEGAL PROVISIONS DEEMED INCLUDED

61.1 It is the intent and understanding of the parties to this **Contract** that each and every provision of **Law** required to be inserted in this **Contract** shall be and is inserted herein. Furthermore, it is hereby stipulated that every such provision is to be deemed to be inserted herein, and if, through mistake or otherwise, any such provision is not inserted, or is not inserted in correct form, then this **Contract** shall forthwith upon the application of either party be amended by such insertion so as to comply strictly with the **Law** and without prejudice to the rights of either party hereunder.

ARTICLE 62. TAX EXEMPTION

62.1 The **City** is exempt from payment of Federal, State, and local taxes, including sales and compensating use taxes of the State of New York and its cities and counties on all tangible personal property sold to the **City** pursuant to the provisions of this **Contract**. These taxes are not to be included in bids. However, this exemption does not apply to tools, machinery, equipment or other property leased by or to the **Contractor**, **Subcontractor** or **Materialman** or to tangible personal property which, even

though it is consumed, is not incorporated into the completed **Work** (consumable supplies) and tangible personal property that the **Contractor** is required to remove from the **Site** during or upon completion of the **Work**. The **Contractor** and its **Subcontractors** and **Materialmen** shall be responsible for and pay any and all applicable taxes, including sales and compensating use taxes, on such leased tools, machinery, equipment or other property and upon all such consumable supplies and tangible personal property that the **Contractor** is required to remove from the **Site** during or upon completion of the **Work**.

62.2 The **Contractor** agrees to sell and the **City** agrees to purchase all tangible personal property, other than consumable supplies and other tangible personal property that the **Contractor** is required to remove from the **Site** during or upon completion of the **Work**, that is required, necessary or proper for or incidental to the construction of the **Project** covered by this **Contract**. The sum paid under this **Contract** for such tangible personal property shall be in full payment and consideration for the sale of such tangible personal property.

62.2.1 The **Contractor** agrees to construct the **Project** and to perform all **Work**, labor and services rendered, necessary, proper or incidental thereto for the sum shown in the bid for the performance of such **Work**, labor, and services, and the sum so paid pursuant to this **Contract** for such **Work**, labor, and services, shall be in full consideration for the performance by the **Contractor** of all its duties and obligations under this **Contract** in connection with said **Work**, labor, and services.

62.3 20 NYCRR Section 541.3(d) provides that a **Contractor's** purchases of tangible personal property that is either incorporated into real property owned by a governmental entity or purchased for and sold to a governmental entity are exempt from sales and use tax. The **City** shall not pay sales tax for any such tangible personal property that it purchases from the **Contractor** pursuant to the **Contract**. With respect to such tangible personal property, the **Contractor**, at the request of the **City**, shall furnish to the **City** such bills of sale and other instruments as may be required by the **City**, properly executed, acknowledged and delivered assuring to the **City** title to such tangible personal property, free of liens and/or encumbrances, and the **Contractor** shall mark or otherwise identify all such tangible personal property as the property of the **City**.

62.4 Title to all tangible personal property to be sold by the **Contractor** to the **City** pursuant to the provisions of the **Contract** shall immediately vest in and become the sole property of the **City** upon delivery of such tangible personal property to the **Site**. Notwithstanding such transfer of title, the **Contractor** shall have the full and continuing responsibility to install such tangible personal property in accordance with the provisions of this **Contract**, protect it, maintain it in a proper condition and forthwith repair, replace and make good any damage thereto, theft or disappearance thereof, and furnish additional tangible personal property in place of any that may be lost, stolen or rendered unusable, without cost to the **City**, until such time as the **Work** covered by the **Contract** is fully accepted by the **City**. Such transfer of title shall in no way affect any of the **Contractor's** obligations hereunder. In the event that, after title has passed to the **City**, any of the tangible personal property is rejected as being defective or otherwise unsatisfactory, title to all such tangible personal property shall be deemed to have been transferred back to the **Contractor**.

62.5 The purchase by **Subcontractors** or **Materialmen** of tangible personal property to be sold hereunder shall be a purchase or procurement for resale to the **Contractor** (either directly or through other **Subcontractors**) and therefore not subject to the aforesaid sales and compensating use taxes, provided that the subcontracts and purchase agreements provide for the resale of such tangible personal property and that such subcontracts and purchase agreements are in a form similar to this **Contract** with respect to the separation of the sale of consumable supplies and tangible personal property that the **Contractor** is required to remove from the **Site** during or upon completion of the **Work** from the **Work** and labor, services, and any other matters to be provided, and provided further that the subcontracts and

purchase agreements provide separate prices for tangible personal property and all other services and matters. Such separation shall actually be followed in practice, including the separation of payments for tangible personal property from the payments for other **Work** and labor and other things to be provided.

62.6 The **Contractor** and its **Subcontractors** and **Materialmen** shall furnish a **Contractor Exempt Purchase Certificate** to all persons, firms or corporations from which they purchase tangible personal property for the performance of the **Work** covered by this **Contract**.

62.7 In the event any of the provisions of this Article 62 shall be deemed to be in conflict with any other provisions of this **Contract** or create any ambiguity, then the provisions of this Article 62 shall control.

ARTICLE 63. INVESTIGATION(S) CLAUSE

63.1 The parties to this **Contract** agree to cooperate fully and faithfully with any investigation, audit or inquiry conducted by a United States, a State of New York (State) or a **City** governmental agency or authority that is empowered directly or by designation to compel the attendance of witnesses and to examine witnesses under oath, or conducted by the Inspector General of a governmental agency that is a party in interest to the transaction, submitted bid, submitted proposal, contract, lease, permit or license that is the subject of the investigation, audit or inquiry.

63.2 If any person who has been advised that his/her statement, and any information from such statement, will not be used against him/her in any subsequent criminal proceeding refuses to testify before a grand jury or other governmental agency or authority empowered directly or by designation to compel the attendance of witnesses and to examine witnesses under oath concerning the award of or performance under any transaction, agreement, lease, permit, contract, or license entered into with the **City**, the State, or any political subdivision or public authority thereof, or the Port Authority of New York and New Jersey, or any local development corporation within the **City**, or any public benefit corporation organized under the **Laws** of the State of New York, or;

63.3 If any person refuses to testify for a reason other than the assertion of his/her privilege against self incrimination in an investigation, audit or inquiry conducted by a **City** or State governmental agency or authority empowered directly or by designation to compel the attendance of witnesses and to take testimony under oath, or by the Inspector General of the governmental agency that is a party in interest in, and is seeking testimony concerning the award of, or performance under any transaction, agreement, lease, permit, contract, or license entered into with the **City**, the State, or any political subdivision thereof or any local development corporation within the **City**, then;

63.4 The **Commissioner** whose **Agency** is a party in interest to the transaction, submitted bid, submitted proposal, contract, lease, permit, or license shall convene a hearing, upon not less than five (5) **Days'** written notice to the parties involved to determine if any penalties should attach for the failure of a person to testify.

63.5 If any non-governmental party to the hearing requests an adjournment, the **Commissioner** who convened the hearing may, upon granting the adjournment, suspend any contract, lease, permit, or license, pending the final determination pursuant to Article 63.7 without the **City** incurring any penalty or damages for delay or otherwise.

63.6 The penalties which may attach after a final determination by the **Commissioner** may include but shall not exceed:

63.6.1 The disqualification for a period not to exceed five (5) years from the date of an adverse determination for any person, or any entity of which such person was a member at the time the testimony was sought, from submitting bids for, or transacting business with, or entering into or obtaining any contract, lease, permit or license with or from the **City**; and/or

63.6.2 The cancellation or termination of any and all such existing **City** contracts, leases, permits or licenses that the refusal to testify concerns and that have not been assigned as permitted under this **Contract**, nor the proceeds of which pledged, to an unaffiliated and unrelated institutional lender for fair value prior to the issuance of the notice scheduling the hearing, without the **City** incurring any penalty or damages on account of such cancellation or termination; monies lawfully due for goods delivered, work done, rentals, or fees accrued prior to the cancellation or termination shall be paid by the **City**.

63.7 The **Commissioner** shall consider and address in reaching his/her determination and in assessing an appropriate penalty the factors in Articles 63.7.1 and 63.7.2. The **Commissioner** may also consider, if relevant and appropriate, the criteria established in Articles 63.7.3 and 63.7.4, in addition to any other information which may be relevant and appropriate:

63.7.1 The party's good faith endeavors or lack thereof to cooperate fully and faithfully with any governmental investigation or audit, including but not limited to the discipline, discharge, or disassociation of any person failing to testify, the production of accurate and complete books and records, and the forthcoming testimony of all other members, agents, assignees or fiduciaries whose testimony is sought.

63.7.2 The relationship of the person who refused to testify to any entity that is a party to the hearing, including but not limited to, whether the person whose testimony is sought has an ownership interest in the entity and/or the degree of authority and responsibility the person has within the entity.

63.7.3 The nexus of the testimony sought to the subject entity and its contracts, leases, permits or licenses with the **City**.

63.7.4 The effect a penalty may have on an unaffiliated and unrelated party or entity that has a significant interest in an entity subject to penalties under Article 63.6, provided that the party or entity has given actual notice to the **Commissioner** upon the acquisition of the interest, or at the hearing called for in Article 63.4, gives notice and proves that such interest was previously acquired. Under either circumstance the party or entity shall present evidence at the hearing demonstrating the potential adverse impact a penalty will have on such person or entity.

63.8 Definitions:

63.8.1 The term "license" or "permit" as used in this Article 63 shall be defined as a license, permit, franchise or concession not granted as a matter of right.

63.8.2 The term "person" as used in this Article 63 shall be defined as any natural person doing business alone or associated with another person or entity as a partner, director, officer, principal or employee.

63.8.3 The term "entity" as used in this Article 63 shall be defined as any firm, partnership, corporation, association, joint venture, or person that receives monies, benefits, licenses, leases, or permits from or through the **City** or otherwise transacts business with the **City**.

63.8.4 The term "member" as used in this Article 63 shall be defined as any person associated with another person or entity as a partner, director, officer, principal or employee.

63.9 In addition to and notwithstanding any other provision of this **Contract**, the **Commissioner** may in his/her sole discretion terminate this **Contract** upon not less than three (3) **Days**' written notice in the event the **Contractor** fails to promptly report in writing to the **Commissioner** of the Department of Investigations ("DOI") of the **City** any solicitation of money, goods, requests for future employment or other benefit or thing of value, by or on behalf of any employee of the **City** or other person, firm, corporation or entity for any purpose which may be related to the procurement or obtaining of this **Contract** by the **Contractor**, or affecting the performance of this **Contract**.

ARTICLE 64. TERMINATION BY THE CITY

64.1 In addition to termination pursuant to any other article of this **Contract**, the **Commissioner** may, at any time, terminate this **Contract** by written notice to the **Contractor**. In the event of termination, the **Contractor** shall, upon receipt of such notice, unless otherwise directed by the **Commissioner**:

64.1.1 Stop **Work** on the date specified in the notice;

64.1.2 Take such action as may be necessary for the protection and preservation of the **City's** materials and property;

64.1.3 Cancel all cancelable orders for material and equipment;

64.1.4 Assign to the **City** and deliver to the **Site** or another location designated by the **Commissioner**, any non-cancelable orders for material and equipment that is not capable of use except in the performance of this **Contract** and has been specifically fabricated for the sole purpose of this **Contract** and not incorporated in the **Work**;

64.1.5 Take no action which will increase the amounts payable by the **City** under this **Contract**.

64.2 In the event of termination by the **City** pursuant to this Article 64, payment to the **Contractor** shall be in accordance with Articles 64.2.1, 64.2.2 or 64.2.3, to the extent that each respective article applies.

64.2.1 Lump Sum Contracts or Items: On all lump sum **Contracts**, or on lump sum items in a **Contract**, the **City** will pay the **Contractor** the sum of the amounts described in Articles 64.2.1(a) and 64.2.1(b), less all payments previously made pursuant to this **Contract**. On lump sum **Contracts** only, the **City** will also pay the **Contractor** an additional sum as provided in Article 64.2.1(c).

64.2.1(a) For **Work** completed prior to the notice of termination, the **Contractor** shall be paid a pro rata portion of the lump sum bid amount, plus approved change orders, based upon the percent completion of the **Work**, as determined by the **Commissioner**. For the purpose of determining the pro rata portion of the lump sum bid amount to which the **Contractor** is entitled, the bid breakdown submitted in accordance with Article 41 shall be considered, but shall not be dispositive. The **Commissioner's** determination hereunder shall be final, binding, and conclusive.

64.2.1(b) For non-cancelable material and equipment that is not capable of use except in the performance of this **Contract** and has been specifically fabricated for the sole purpose of this **Contract**, but not yet incorporated in the **Work**, the **Contractor** shall be paid the lesser of the following, less salvage value:

64.2.1(b)(i) The Direct Cost, as defined in Article 64.2.4; or

64.2.1(b)(ii) The fair and reasonable value, if less than Direct Cost, of such material and equipment, plus necessary and reasonable delivery costs.

64.2.1(b)(iii) In addition, the **Contractor** shall be paid five (5%) percent of the amount described in Article 64.2.1(b)(i) or Article 64.2.1(b)(ii), whichever applies.

64.2.1(c) Except as otherwise provided in Article 64.2.1(d), on all lump sum **Contracts**, the **Contractor** shall be paid the percentage indicated below applied to the difference between the total lump sum bid amount and the total of all payments made prior to the notice of termination plus all payments allowed pursuant to Articles 64.2.1(a) and 64.2.1(b):

64.2.1(c)(i) Five (5%) percent of the first five million (\$5,000,000) dollars; and

64.2.1(c)(ii) Three (3%) percent of any amount between five million (\$5,000,000) dollars and fifteen million (\$15,000,000) dollars; plus

64.2.1(c)(iii) One (1%) percent of any amount over fifteen million (\$15,000,000) dollars.

64.2.1(d) In the event the **City** terminates a lump sum **Contract** pursuant to this Article 64 within ninety (90) **Days** after registration of the **Contract** with the **Comptroller**, the **Contractor** shall be paid one (1%) percent of the difference between the lump sum bid amount and the total of all payments made pursuant to this Article 64.2.

64.2.2 Unit Price Contracts or Items: On all unit price **Contracts**, or on unit price items in a **Contract**, the **City** will pay the **Contractor** the sum of the amounts described in Articles 64.2.2(a) and 64.2.2(b), less all payments previously made pursuant to this **Contract**:

64.2.2(a) For all completed units, the unit price stated in the **Contract**, and

64.2.2(b) For units that have been ordered but are only partially completed, the **Contractor** will be paid:

64.2.2(b)(i) A pro rata portion of the unit price stated in the **Contract** based upon the percent completion of the unit and

64.2.2(b)(ii) For non-cancelable material and equipment, payment will be made pursuant to Article 64.2.1(b).

64.2.3 Time and Materials Contracts or Items Based on Time and Material Records: On all **Contracts** or items in a **Contract** where payment for the **Work** is based on time and

material records, the **Contractor** shall be paid in accordance with Article 26, less all payments previously made pursuant to this **Contract**.

64.2.4 Direct Costs: Direct Costs as used in this Article 64.2 shall mean:

64.2.4(a) The actual purchase price of material and equipment, plus necessary and reasonable delivery costs,

64.2.4(b) The actual cost of labor involved in construction and installation at the **Site**, and

64.2.4(c) The actual cost of necessary bonds and insurance purchased pursuant to requirements of this **Contract** less any amounts that have been or should be refunded by the **Contractor's** sureties or insurance carriers.

64.2.4(d) Direct Costs shall not include overhead.

64.3 In no event shall any payments under this Article 64 exceed the **Contract** price for such items.

64.4 All payments pursuant to Article 64 shall be in the nature of liquidated damages and shall be accepted by the **Contractor** in full satisfaction of all claims against the **City**.

64.5 The **City** may deduct or set off against any sums due and payable pursuant to this Article 64, any deductions authorized by this **Contract** or by **Law** (including but not limited to liquidated damages) and any claims it may have against the **Contractor**. The **City's** exercise of the right to terminate the **Contract** pursuant to this Article 64 shall not impair or otherwise effect the **City's** right to assert any claims it may have against the **Contractor** in a plenary action.

64.6 Where the **Work** covered by the **Contract** has been substantially completed, as determined in writing by the **Commissioner**, termination of the **Work** shall be handled as an omission of **Work** pursuant to Articles 29 and 33, in which case a change order will be issued to reflect an appropriate reduction in the **Contract** sum, or if the amount is determined after final payment, such amount shall be paid by the **Contractor**.

ARTICLE 65. CHOICE OF LAW, CONSENT TO JURISDICTION AND VENUE

65.1 This **Contract** shall be deemed to be executed in the **City** regardless of the domicile of the **Contractor**, and shall be governed by and construed in accordance with the **Laws** of the State of New York and the **Laws** of the United States, where applicable.

65.2 The parties agree that any and all claims asserted against the **City** arising under this **Contract** or related thereto shall be heard and determined in the courts of the State of New York ("New York State Courts") located in the **City** and County of New York. To effect this **Contract** and intent, the **Contractor** agrees:

65.2.1 If the **City** initiates any action against the **Contractor** in Federal court or in a New York State Court, service of process may be made on the **Contractor** either in person, wherever such **Contractor** may be found, or by registered mail addressed to the **Contractor** at its address as set forth in this **Contract**, or to such other address as the **Contractor** may provide to the **City** in writing; and

65.2.2 With respect to any action between the **City** and the **Contractor** in a New York State Court, the **Contractor** hereby expressly waives and relinquishes any rights it might otherwise have:

65.2.2(a) To move to dismiss on grounds of forum non conveniens;

65.2.2(b) To remove to Federal Court; and

65.2.2(c) To move for a change of venue to a New York State Court outside New York County.

65.2.3 With respect to any action brought by the **City** against the **Contractor** in a Federal Court located in the **City**, the **Contractor** expressly waives and relinquishes any right it might otherwise have to move to transfer the action to a Federal Court outside the **City**.

65.2.4 If the **Contractor** commences any action against the **City** in a court located other than in the **City** and County of New York, upon request of the **City**, the **Contractor** shall either consent to a transfer of the action to a New York State Court of competent jurisdiction located in the **City** and County of New York or, if the Court where the action is initially brought will not or cannot transfer the action, the **Contractor** shall consent to dismiss such action without prejudice and may thereafter reinstate the action in a New York State Court of competent jurisdiction in New York County.

65.3 If any provision(s) of this Article 65 is held unenforceable for any reason, each and all other provision(s) shall nevertheless remain in full force and effect.

ARTICLE 66. PARTICIPATION IN AN INTERNATIONAL BOYCOTT

66.1 The **Contractor** agrees that neither the **Contractor** nor any substantially owned affiliated company is participating or shall participate in an international boycott in violation of the provisions of the Federal Export Administration Act of 1979, as amended, or the regulations of the United States Department of Commerce (Commerce Department) promulgated thereunder.

66.2 Upon the final determination by the Commerce Department or any other agency of the United States as to, or conviction of the **Contractor** or a substantially-owned affiliated company thereof for participation in an international boycott in violation of the provisions of the Export Administration Act of 1979, as amended, or the regulations promulgated thereunder, the **Comptroller** may, at his/her option, render forfeit and void this **Contract**.

66.3 The **Contractor** shall comply in all respects, with the provisions of Section 6-114 of the Administrative Code and the rules and regulations issued by the **Comptroller** thereunder.

ARTICLE 67. LOCALLY BASED ENTERPRISE PROGRAM

67.1 This **Contract** is subject to the requirements of Section 6-108.1 of the Administrative Code and regulations promulgated thereunder. No construction contract shall be awarded unless and until these requirements have been complied with in their entirety; however, compliance with this Article 67 is not required if the Agency sets Subcontractor Participation Goals for Minority- and Women-Owned Business Enterprises (M/WBEs).

67.2 Unless specifically waived by the **Commissioner** with the approval of the Division of Economic and Financial Opportunity of the **City Department of Business Services**, if any portion of the **Contract** is subcontracted, not less than ten (10%) percent of the total dollar amount of the **Contract** shall be awarded to locally based enterprises (LBEs); except that where less than ten (10%) percent of the total dollar amount of the **Contract** is subcontracted, such lesser percentage shall be so awarded.

67.3 The **Contractor** shall not require performance and payment bonds from LBE **Subcontractors**.

67.4 If the **Contractor** has indicated prior to award that no **Work** will be subcontracted, no **Work** shall be subcontracted without the prior approval of the **Commissioner**, which shall be granted only if the **Contractor** makes a good faith effort beginning at least six (6) weeks before the **Work** is to be performed to obtain LBE **Subcontractors** to perform the **Work**.

67.5 If the **Contractor** has not identified sufficient LBE **Subcontractors** prior to award, it shall sign a letter of compliance stating that it complies with Section 6-108.1 of the Administrative Code, recognizes that achieving the LBE requirement is a condition of its **Contract**, and shall submit documentation demonstrating its good faith efforts to obtain LBEs. After award, the **Contractor** shall begin to solicit LBE's to perform subcontracted **Work** at least six (6) weeks before the date such **Work** is to be performed and shall demonstrate that a good faith effort has been made to obtain LBEs on each subcontract until it meets the required percentage.

67.6 Failure of the **Contractor** to comply with the requirements of Section 6-108.1 of the Administrative Code and the regulations promulgated thereunder shall constitute a material breach of this **Contract**. Remedy for such breach may include the imposition of any or all of the following sanctions:

67.6.1 Reducing the **Contractor's** compensation by an amount equal to the dollar value of the percentage of the LBE subcontracting requirement not complied with;

67.6.2 Declaring the **Contractor** in default;

67.6.3 If the **Contractor** is an LBE, de-certifying and declaring the **Contractor** ineligible to participate in the LBE program for a period of up to three (3) years.

ARTICLE 68. ANTITRUST

68.1 The **Contractor** hereby assigns, sells, and transfers to the **City** all right, title, and interest in and to any claims and causes of action arising under the antitrust **Laws** of New York State or of the United States relating to the particular goods or services purchased or procured by the **City** under this **Contract**.

ARTICLE 69. MacBRIDE PRINCIPLES PROVISIONS

69.1 Notice To All Prospective **Contractors**:

69.1.1 Local Law No. 34 of 1991 became effective on September 10, 1991 and added Section 6-115.1 of the Administrative Code. The local **Law** provides for certain restrictions on **City Contracts** to express the opposition of the people of the **City** to employment discrimination practices in Northern Ireland to promote freedom of work-place opportunity.

69.1.2 Pursuant to Section 6-115.1, prospective **Contractors** for **Contracts** to provide goods or services involving an expenditure of an amount greater than ten thousand

(\$10,000.) dollars, or for construction involving an amount greater than fifteen thousand (\$15,000.) dollars, are asked to sign a rider in which they covenant and represent, as a material condition of their **Contract**, that any business operations in Northern Ireland conducted by the **Contractor** and any individual or legal entity in which the **Contractor** holds a ten (10%) percent or greater ownership interest in the **Contractor** will be conducted in accordance with the MacBride Principles of nondiscrimination in employment.

69.1.3 Prospective **Contractors** are not required to agree to these conditions. However, in the case of **Contracts** let by competitive sealed bidding, whenever the lowest responsible bidder has not agreed to stipulate to the conditions set forth in this notice and another bidder who has agreed to stipulate to such conditions has submitted a bid within five (5%) percent of the lowest responsible bid for a **Contract** to supply goods, services or contraction of comparable quality, the **Agency** shall refer such bids to the Mayor, the Speaker or other officials, as appropriate, who may determine, in accordance with applicable **Law**, that it is in the best interest of the **City** that the **Contract** be awarded to other than the lowest responsible pursuant to Section 313(b)(2) of the **City Charter**.

69.1.4 In the case of **Contracts** let by other than competitive sealed bidding, if a prospective **Contractor** does not agree to these conditions, no **Agency**, elected official or the **City Council** shall award the **Contract** to that bidder unless the **Agency** seeking to use the goods, services or construction certifies in writing that the **Contract** is necessary for the **Agency** to perform its functions and there is no other responsible **Contractor** who will supply goods, services or construction of comparable quality at a comparable price.

69.2 In accordance with Section 6-115.1 of the Administrative Code, the **Contractor** stipulates that such **Contractor** and any individual or legal entity in which the **Contractor** holds a ten (10%) percent or greater ownership interest in the **Contractor** either:

69.2.1 Have no business operations in Northern Ireland, or

69.2.2 Shall take lawful steps in good faith to conduct any business operations they have in Northern Ireland in accordance with the MacBride Principles, and shall permit independent monitoring of their compliance with such principles.

69.3 For purposes of this Article, the following terms shall have the following meanings:

69.3.1 "MacBride Principles" shall mean those principles relating to nondiscrimination in employment and freedom of work-place opportunity which require employers doing business in Northern Ireland to:

69.3.1(a) increase the representation of individuals from under-represented religious groups in the workforce, including managerial, supervisory, administrative, clerical and technical jobs;

69.3.1(b) take steps to promote adequate security for the protection of employees from under-represented religious groups both at the work-place and while traveling to and from **Work**;

69.3.1(c) ban provocative religious or political emblems from the workplace;

69.3.1(d) publicly advertise all job openings and make special recruitment efforts to attract applicants from under-represented religious groups;

69.3.1(e) establish layoff, recall, and termination procedures which do not in practice favor a particular religious group;

69.3.1(f) abolish all job reservations, apprenticeship restrictions and different employment criteria which discriminate on the basis of religion;

69.3.1(g) develop training programs that will prepare substantial numbers of current employees from under-represented religious groups for skilled jobs, including the expansion of existing programs and the creation of new programs to train, upgrade, and improve the skills of workers from under-represented religious groups;

69.3.1(h) establish procedures to assess, identify, and actively recruit employees from under-represented religious groups with potential for further advancement; and

69.3.1(i) appoint a senior management staff member to oversee affirmative action efforts and develop a timetable to ensure their full implementation.

69.4 The **Contractor** agrees that the covenants and representations in Article 69.2 are material conditions to this **Contract**. In the event the **Agency** receives information that the **Contractor** who made the stipulation required by this Article 69 is in violation thereof, the **Agency** shall review such information and give the **Contractor** an opportunity to respond. If the **Agency** finds that a violation has occurred, the **Agency** shall have the right to declare the **Contractor** in default and/or terminate this **Contract** for cause and procure supplies, services or **Work** from another source in the manner the **Agency** deems proper. In the event of such termination, the **Contractor** shall pay to the **Agency**, or the **Agency** in its sole discretion may withhold from any amounts otherwise payable to the **Contractor**, the difference between the **Contract** price for the uncompleted portion of this **Contract** and the cost to the **Agency** of completing performance of this **Contract** either itself or by engaging another **Contractor** or **Contractors**. In the case of a requirement **Contract**, the **Contractor** shall be liable for such difference in price for the entire amount of supplies required by the **Agency** for the uncompleted term of **Contractor's Contract**. In the case of a construction **Contract**, the **Agency** shall also have the right to hold the **Contractor** in partial or total default in accordance with the default provisions of this **Contract**, and/or may seek debarment or suspension of the **Contractor**. The rights and remedies of the **Agency** hereunder shall be in addition to, and not in lieu of, any rights and remedies the **Agency** has pursuant to this **Contract** or by operation of Law.

ARTICLE 70. ELECTRONIC FILING/NYC DEVELOPMENT HUB

70.1 The **Contractor** shall electronically file all alteration type-2 and alteration type-3 applications via the New York City Development Hub Web site, except applications for the following types of minor alterations: enlargements, curb cuts, legalizations, fire alarms, builders pavement plans, and jobs filed on Landmark Preservation Commission calendared properties. All such filings must be professionally-certified. Information about electronic filing via the New York City Development Hub is available on the City Department of Buildings Web site at www.nyc.gov/buildings.

ARTICLE 71. PROHIBITION OF TROPICAL HARDWOODS

71.1 Tropical hardwoods, as defined in Section 165 of the New York State Finance Law (Finance Law), shall not be utilized in the performance of this **Contract** except as expressly permitted by Section 165 of the Finance Law.

ARTICLE 72. CONFLICTS OF INTEREST

72.1 Section 2604 of the City Charter and other related provisions of the City Charter, the Administrative Code, and the Penal Law are applicable under the terms of this Contract in relation to conflicts of interest and shall be extended to Subcontractors authorized to perform Work, labor and services pursuant to this Contract and further, it shall be the duty and responsibility of the Contractor to so inform its respective Subcontractors. Notice is hereby given that, under certain circumstances, penalties may be invoked against the donor as well as the recipient of any form of valuable gift.

ARTICLE 73. MERGER CLAUSE

73.1 The written Contract herein, contains all the terms and conditions agreed upon by the parties hereto, and no other agreement, oral or otherwise, regarding the subject matter of this Contract shall be deemed to exist or to bind any of the parties hereto, or to vary any of the terms contained herein.

ARTICLE 74. STATEMENT OF WORK

74.1 The Contractor shall furnish all labor and materials and perform all Work in strict accordance with the Specifications and Addenda thereto, numbered ONE TO SEVEN

ARTICLE 75. COMPENSATION TO BE PAID TO CONTRACTOR

75.1 The City will pay and the Contractor will accept in full consideration for the performance of the Contract, subject to additions and deductions as provided herein, the total sum of: SEE BELOW Dollars, (\$ 11,729,618.00), this said sum being the amount at which the Contractor was awarded to the Contractor at a public letting thereof, based upon the Contractor's bid for the Contract. ELEVEN MILLION, SEVEN HUNDRED TWENTY NINE THOUSAND, SIX HUNDRED EIGHTEEN DOLLARS

ARTICLE 76. ELECTRONIC FUNDS TRANSFER

76.1 In accordance with Section 6-107.1 of the Administrative Code, the Contractor agrees to accept payments under this Contract from the City by electronic funds transfer (EFT). An EFT is any transfer of funds, other than a transaction originated by check, draft or similar paper instrument, which is initiated through an electronic terminal, telephonic instrument or computer or magnetic tape so as to order, instruct or authorize a financial institution to debit or credit an account. Prior to the first payment made under this Contract, the Contractor shall designate one financial institution or other authorized payment agent and shall complete the attached "EFT Vendor Payment Enrollment Form" in order to provide the Commissioner of the City Department of Finance with information necessary for the Contractor to receive electronic funds transfer payments through a designated financial institution or authorized payment agent. The crediting of the amount of a payment to the appropriate account on the books of a financial institution or other authorized payment agent designated by the Contractor shall constitute full satisfaction by the City for the amount of the payment under this Contract. The account information supplied by the Contractor to facilitate the electronic funds transfer shall remain confidential to the fullest extent provided by Law.

76.2 The Commissioner may waive the application of the requirements of this Article 76 to payments on contracts entered into pursuant to Section 315 of the City Charter. In addition, the Commissioner of the Department of Finance and the Comptroller may jointly issue standards pursuant to

which the Agency may waive the requirements of this Article 76 for payment in the following circumstances: (i) for individuals or classes of individuals for whom compliance imposes a hardship; (ii) for classifications or types of checks; or (iii) in other circumstances as may be necessary in the interest of the City.

ARTICLE 77. RECORDS RETENTION

77.1 The Contractor agrees to retain all books, records, and other documents relevant to this Contract for six years after the final payment or termination of this Contract, whichever is later. City, state, and federal auditors and any other persons duly authorized by the City shall have full access to and the right to examine any such books, records, and other documents during the retention period.

ARTICLE 78. PARTICIPATION BY MINORITY-OWNED AND WOMEN-OWNED BUSINESS ENTERPRISES IN CITY PROCUREMENT

NOTICE TO ALL PROSPECTIVE CONTRACTORS

ARTICLE I. M/WBE PROGRAM

Local Law No. 129 of 2005 added and Local Law 1 of 2013 amended Section 6-129 of the Administrative Code of the City of New York (hereinafter "Section 6-129"). Section 6-129 establishes the program for participation in City procurement ("M/WBE Program") by minority-owned business enterprises ("MBEs") and women-owned business enterprises ("WBEs"), certified in accordance with Section 1304 of the New York City Charter. As stated in Section 6-129, the intent of the program is to address the impact of discrimination on the City's procurement process, and to promote the public interest in avoiding fraud and favoritism in the procurement process, increasing competition for City business, and lowering contract costs. The contract provisions contained herein are pursuant to Section 6-129, and the rules of the Department of Small Business Services ("DSBS") promulgated thereunder.

If this Contract is subject to the M/WBE Program established by Section 6-129, the specific requirements of MBE and/or WBE participation for this Contract are set forth in Schedule B of the Contract (entitled the "M/WBE Utilization Plan"), and are detailed below. The Contractor must comply with all applicable MBE and WBE requirements for this Contract.

All provisions of Section 6-129 are hereby incorporated in the Contract by reference and all terms used herein that are not defined herein shall have the meanings given such terms in Section 6-129. Article I, Part A, below, sets forth provisions related to the participation goals for construction, standard and professional services contracts. Article I, Part B, below, sets forth miscellaneous provisions related to the M/WBE Program.

PART A

PARTICIPATION GOALS FOR CONSTRUCTION, STANDARD AND PROFESSIONAL SERVICES CONTRACTS OR TASK ORDERS

1. The MBE and/or WBE Participation Goals established for this Contract or Task Orders issued pursuant to this Contract, ("Participation Goals"), as applicable, are set forth on Schedule B, Part I to this Contract (see Page 1, line 1 Total Participation Goals) or will be set forth on Schedule B, Part I to Task Orders issued pursuant to this Contract, as applicable.

The **Participation Goals** represent a percentage of the total dollar value of the Contract or Task Order, as applicable, that may be achieved by awarding subcontracts to firms certified with New York City Department of Small Business Services as MBEs and/or WBEs, and/or by crediting the participation of prime contractors and/or qualified joint ventures as provided in Section 3 below, unless the goals have been waived or modified by Agency in accordance with Section 6-129 and Part A, Sections 10 and 11 below, respectively.

2. If **Participation Goals** have been established for this Contract or Task Orders issued pursuant to this Contract, Contractor agrees or shall agree as a material term of the Contract that Contractor shall be subject to the **Participation Goals**, unless the goals are waived or modified by Agency in accordance with Section 6-129 and Part A, Sections 10 and 11 below, respectively.

3. If **Participation Goals** have been established for this Contract or Task Order issued pursuant to this Contract, a Contractor that is an MBE and/or WBE shall be permitted to count its own participation toward fulfillment of the relevant **Participation Goal**, provided that in accordance with Section 6-129 the value of Contractor's participation shall be determined by subtracting from the total value of the Contract or Task Order, as applicable, any amounts that the Contractor pays to direct subcontractors (as defined in Section 6-129(c)(13)), and provided further that a Contractor that is certified as both an MBE and a WBE may count its own participation either toward the goal for MBEs or the goal for WBEs, but not both.

A Contractor that is a qualified joint venture (as defined in Section 6-129(c)(30)) shall be permitted to count a percentage of its own participation toward fulfillment of the relevant **Participation Goal**. In accordance with Section 6-129, the value of Contractor's participation shall be determined by subtracting from the total value of the Contract or Task Order, as applicable, any amounts that Contractor pays to direct subcontractors, and then multiplying the remainder by the percentage to be applied to total profit to determine the amount to which an MBE or WBE is entitled pursuant to the joint venture agreement, provided that where a participant in a joint venture is certified as both an MBE and a WBE, such amount shall be counted either toward the goal for MBEs or the goal for WBEs, but not both.

4. A. If **Participation Goals** have been established for this Contract, a prospective contractor shall be required to submit with its bid or proposal, as applicable, a completed Schedule B, M/WBE Utilization Plan, Part II (see Pages 2-4) indicating: (a) whether the contractor is an MBE or WBE, or qualified joint venture; (b) the percentage of work it intends to award to direct subcontractors; and (c) in cases where the contractor intends to award direct subcontracts, a description of the type and dollar value of work designated for participation by MBEs and/or WBEs, and the time frames in which such work is scheduled to begin and end. In the event that this M/WBE Utilization Plan indicates that the bidder or proposer, as applicable, does not intend to meet the **Participation Goals**, the bid or proposal, as applicable, shall be deemed non-responsive, unless Agency has granted the bidder or proposer, as applicable, a pre-award waiver of the Participation Goals in accordance with Section 6-129 and Part A, Section 10 below.

B. (i) If this Contract is for a master services agreement or other requirements type contract that will result in the issuance of Task Orders that will be individually registered ("Master Services Agreement") and is subject to M/WBE **Participation Goals**, a prospective contractor shall be required to submit with its bid or proposal, as applicable, a completed Schedule B, M/WBE Participation Requirements for Master Services Agreements That Will Require Individually Registered Task Orders, Part II (page 2) indicating the prospective contractor's certification and required affirmations to make all reasonable good faith efforts to meet participation goals established on each individual Task Order issued pursuant to this Contract, or if a partial waiver is obtained or such goals are modified by the Agency, to meet the modified **Participation Goals** by soliciting and obtaining the participation of certified MBE and/or WBE firms. In the event that the Schedule B indicates that the bidder or proposer, as applicable, does not intend to meet the **Participation Goals** that may be established on Task Orders issued pursuant to this Contract, the bid or proposal, as applicable, shall be deemed nonresponsive.

(ii) **Participation Goals** on a Master Services Agreement will be established for individual Task Orders issued after the Master Services Agreement is awarded. If **Participation Goals** have been established on a Task Order, a contractor shall be required to submit a Schedule B – M/WBE Utilization Plan For Independently Registered Task Orders That Are Issued Pursuant to Master Services Agreements, Part II (see Pages 2-4) indicating: (a) whether the contractor is an MBE or WBE, or qualified joint venture; (b) the percentage of work it intends to award to direct subcontractors; and (c) in cases where the contractor intends to award direct subcontracts, a description of the type and dollar value of work designated for participation by MBEs and/or WBEs, and the time frames in which such work is scheduled to begin and end. The contractor must engage in good faith efforts to meet the **Participation Goals** as established for the Task Order unless Agency has granted the contractor a pre-award waiver of the Participation Goals in accordance with Section 6-129 and Part A, Section 10 below.

C. THE BIDDER/PROPOSER MUST COMPLETE THE SCHEDULE B INCLUDED HEREIN (SCHEDULE B, PART II). A SCHEDULE B SUBMITTED BY THE BIDDER/PROPOSER WHICH DOES NOT INCLUDE THE VENDOR CERTIFICATION AND REQUIRED AFFIRMATIONS (SEE SECTION V OF PART II) WILL BE DEEMED TO BE NON-RESPONSIVE, UNLESS A FULL WAIVER OF THE PARTICIPATION GOALS IS GRANTED (SCHEDULE B, PART III). IN THE EVENT THAT THE CITY DETERMINES THAT THE BIDDER/PROPOSER HAS SUBMITTED A SCHEDULE B WHERE THE VENDOR CERTIFICATION AND REQUIRED AFFIRMATIONS ARE COMPLETED BUT OTHER ASPECTS OF THE SCHEDULE B ARE NOT COMPLETE, OR CONTAIN A COPY OR COMPUTATION ERROR THAT IS AT ODDS WITH THE VENDOR CERTIFICATION AND AFFIRMATIONS, THE BIDDER/PROPOSER WILL BE NOTIFIED BY THE AGENCY AND WILL BE GIVEN FOUR (4) CALENDAR DAYS FROM RECEIPT OF NOTIFICATION TO CURE THE SPECIFIED DEFICIENCIES AND RETURN A COMPLETED SCHEDULE B TO THE AGENCY. FAILURE TO DO SO WILL RESULT IN A DETERMINATION THAT THE BID/PROPOSAL IS NON-RESPONSIVE. RECEIPT OF NOTIFICATION IS DEFINED AS THE DATE NOTICE IS E-MAILED OR FAXED (IF THE BIDDER/PROPOSER HAS PROVIDED AN E-MAIL ADDRESS OR FAX NUMBER), OR NO LATER THAN FIVE (5) CALENDAR DAYS FROM THE DATE OF MAILING OR UPON DELIVERY, IF DELIVERED.

5. Where an M/WBE Utilization Plan has been submitted, the Contractor shall, within 30 days of issuance by Agency of a notice to proceed, submit a list of proposed persons or entities to which it intends to award subcontracts within the subsequent 12 months. In the case of multiyear contracts, such list shall also be submitted every year thereafter. The Agency may also require the Contractor to report periodically about the contracts awarded by its direct subcontractors to indirect subcontractors (as defined in Section 6-129(c)(22)). **PLEASE NOTE: If this Contract is a public works project subject to GML §101(5) (i.e., a contract valued at or below \$3M for projects in New York City) or if the Contract is subject to a project labor agreement in accordance with Labor Law §222, and the bidder is required to identify at the time of bid submission its intended subcontractors for the Wicks trades (plumbing and gas fitting; steam heating, hot water heating, ventilating and air conditioning (HVAC); and electric wiring), the Contractor must identify all those to which it intends to award construction subcontracts for any portion of the Wicks trade work at the time of bid submission, regardless of what point in the life of the contract such subcontracts will occur. In identifying intended subcontractors in the bid submission, bidders may satisfy any Participation Goals established for this Contract by proposing one or more subcontractors that are MBEs and/or WBEs for any portion of the Wicks trade work. In the event that the Contractor's selection of a subcontractor is disapproved, the Contractor shall have a reasonable time to propose alternate subcontractors.**

6. MBE and WBE firms must be certified by DSBS in order for the Contractor to credit such firms' participation toward the attainment of the **Participation Goals**. Such certification must occur prior to the

firms' commencement of work. A list of MBE and WBE firms may be obtained from the DSBS website at www.nyc.gov/buycertified, by emailing DSBS at buyer@sbs.nyc.gov, by calling (212) 513-6356, or by visiting or writing DSBS at 110 William St., New York, New York, 10038, 7th floor. Eligible firms that have not yet been certified may contact DSBS in order to seek certification by visiting www.nyc.gov/getcertified, emailing MWBE@sbs.nyc.gov, or calling the DSBS certification helpline at (212) 513-6311. A firm that is certified as both an MBE and a WBE may be counted either toward the goal for MBEs or the goal for WBEs, but not both. No credit shall be given for participation by a graduate MBE or graduate WBE, as defined in Section 6-129(c)(20).

7. Where an **M/WBE** Utilization Plan has been submitted, the Contractor shall, with each voucher for payment, and/or periodically as Agency may require, submit statements, certified under penalty of perjury, which shall include, but not be limited to, the total amount the Contractor paid to its direct subcontractors, and, where applicable pursuant to Section 6-129(j), the total amount direct subcontractors paid to indirect subcontractors; the names, addresses and contact numbers of each MBE or WBE hired as a subcontractor by the Contractor, and, where applicable, hired by any of the Contractor's direct subcontractors; and the dates and amounts paid to each MBE or WBE. The Contractor shall also submit, along with its voucher for final payment: the total amount it paid to subcontractors, and, where applicable pursuant to Section 6-129(j), the total amount its direct subcontractors paid directly to their indirect subcontractors; and a final list, certified under penalty of perjury, which shall include the name, address and contact information of each subcontractor that is an MBE or WBE, the work performed by, and the dates and amounts paid to each.

8. If payments made to, or work performed by, MBEs or WBEs are less than the amount specified in the Contractor's **M/WBE** Utilization Plan, Agency shall take appropriate action, in accordance with Section 6-129 and Article II below, unless the Contractor has obtained a modification of its **M/WBE** Utilization Plan in accordance with Section 6-129 and Part A, Section 11 below.

9. Where an **M/WBE** Utilization Plan has been submitted, and the Contractor requests a change order the value of which exceeds the greater of 10 percent of the Contract or Task Order, as applicable, or \$500,000, Agency shall review the scope of work for the Contract or Task Order, as applicable, and the scale and types of work involved in the change order, and determine whether the **Participation Goals** should be modified.

10. Pre-award waiver of the **Participation Goals**. (a) A bidder or proposer, or contractor with respect to a Task Order, may seek a pre-award full or partial waiver of the **Participation Goals** in accordance with Section 6-129, which requests that Agency change one or more **Participation Goals** on the grounds that the **Participation Goals** are unreasonable in light of the availability of certified firms to perform the services required, or by demonstrating that it has legitimate business reasons for proposing a lower level of subcontracting in its **M/WBE** Utilization Plan.

(b) To apply for a full or partial waiver of the **Participation Goals**, a bidder, proposer, or contractor, as applicable, must complete Part III (Page 5) of Schedule B and submit such request no later than seven (7) calendar days prior to the date and time the bids, proposals, or Task Orders are due, in writing to the Agency by email at poped@ddc.nyc.gov or via facsimile at (718) 391-1886. Bidders, proposers, or contractors, as applicable, who have submitted requests will receive an Agency response by no later than two (2) calendar days prior to the due date for bids, proposals, or Task Orders; provided, however, that if that date would fall on a weekend or holiday, an Agency response will be provided by close-of-business on the business day before such weekend or holiday date.

(c) If the Agency determines that the **Participation Goals** are unreasonable in light of the availability of certified firms to perform the services required, it shall revise the solicitation and extend the deadline for bids and proposals, or revise the Task Order, as applicable.

(d) Agency may grant a full or partial waiver of the **Participation Goals** to a bidder, proposer or contractor, as applicable, who demonstrates—before submission of the bid, proposal or Task Order, as applicable—that it has legitimate business reasons for proposing the level of subcontracting in its **M/WBE Utilization Plan**. In making its determination, Agency shall consider factors that shall include, but not be limited to, whether the bidder, proposer or contractor, as applicable, has the capacity and the bona fide intention to perform the Contract without any subcontracting, or to perform the Contract without awarding the amount of subcontracts represented by the **Participation Goals**. In making such determination, Agency may consider whether the **M/WBE Utilization Plan** is consistent with past subcontracting practices of the bidder, proposer or contractor, as applicable, whether the bidder, proposer or contractor, as applicable, has made efforts to form a joint venture with a certified firm, and whether the bidder, proposer, or contractor, as applicable, has made good faith efforts to identify other portions of the Contract that it intends to subcontract.

11. Modification of **M/WBE Utilization Plan**. (a) A Contractor may request a modification of its **M/WBE Utilization Plan** after award of this Contract. **PLEASE NOTE: If this Contract is a public works project subject to GML §101(5) (i.e., a contract valued at or below \$3M for projects in New York City) or if the Contract is subject to a project labor agreement in accordance with Labor Law §222, and the bidder is required to identify at the time of bid submission its intended subcontractors for the Wicks trades (plumbing and gas fitting; steam heating, hot water heating, ventilating and air conditioning (HVAC); and electric wiring), the Contractor may request a Modification of its M/WBE Utilization Plan as part of its bid submission.** The Agency may grant a request for Modification of a Contractor's **M/WBE Utilization Plan** if it determines that the Contractor has established, with appropriate documentary and other evidence, that it made reasonable, good faith efforts to meet the **Participation Goals**. In making such determination, Agency shall consider evidence of the following efforts, as applicable, along with any other relevant factors:

- (i) The Contractor advertised opportunities to participate in the Contract, where appropriate, in general circulation media, trade and professional association publications and small business media, and publications of minority and women's business organizations;
- (ii) The Contractor provided notice of specific opportunities to participate in the Contract, in a timely manner, to minority and women's business organizations;
- (iii) The Contractor sent written notices, by certified mail or facsimile, in a timely manner, to advise MBEs or WBEs that their interest in the Contract was solicited;
- (iv) The Contractor made efforts to identify portions of the work that could be substituted for portions originally designated for participation by MBEs and/or WBEs in the **M/WBE Utilization Plan**, and for which the Contractor claims an inability to retain MBEs or WBEs;
- (v) The Contractor held meetings with MBEs and/or WBEs prior to the date their bids or proposals were due, for the purpose of explaining in detail the scope and requirements of the work for which their bids or proposals were solicited;
- (vi) The Contractor made efforts to negotiate with MBEs and/or WBEs as relevant to perform specific subcontracts, or act as suppliers or service providers;
- (vii) Timely written requests for assistance made by the Contractor to Agency's **M/WBE liaison officer** and to DSBS;
- (viii) Description of how recommendations made by DSBS and Agency were acted upon and an explanation of why action upon such recommendations did not lead to the desired level of participation of MBEs and/or WBEs.

Agency's **M/WBE officer** shall provide written notice to the Contractor of the determination.

(b) The Agency may modify the **Participation Goals** when the scope of the work has been changed by the Agency in a manner that affects the scale and types of work that the Contractor indicated in its **M/WBE Utilization Plan** would be awarded to subcontractors.

12. If this Contract is for an indefinite quantity of construction, standard or professional services or is a requirements type contract and the Contractor has submitted an M/WBE Utilization Plan and has committed to subcontract work to MBEs and/or WBEs in order to meet the **Participation Goals**, the Contractor will not be deemed in violation of the M/WBE Program requirements for this Contract with regard to any work which was intended to be subcontracted to an MBE and/or WBE to the extent that the Agency has determined that such work is not needed.

13. If **Participation Goals** have been established for this Contract or a Task Order issued pursuant to this Contract, at least once annually during the term of the Contract or Task Order, as applicable, Agency shall review the Contractor's progress toward attainment of its M/WBE Utilization Plan, including but not limited to, by reviewing the percentage of work the Contractor has actually awarded to MBE and/or WBE subcontractors and the payments the Contractor made to such subcontractors.

14. If **Participation Goals** have been established for this Contract or a Task Order issued pursuant to this Contract, Agency shall evaluate and assess the Contractor's performance in meeting those goals, and such evaluation and assessment shall become part of the Contractor's overall contract performance evaluation.

PART B: MISCELLANEOUS

1. The Contractor shall take notice that, if this solicitation requires the establishment of an M/WBE Utilization Plan, the resulting contract may be audited by DSBS to determine compliance with Section 6-129. See §6-129(e)(10). Furthermore, such resulting contract may also be examined by the City's Comptroller to assess compliance with the M/WBE Utilization Plan.

2. Pursuant to DSBS rules, construction contracts that include a requirement for an M/WBE Utilization Plan shall not be subject to the law governing Locally Based Enterprises set forth in Section 6-108.1 of the Administrative Code of the City of New York.

3. DSBS is available to assist contractors and potential contractors in determining the availability of MBEs and/or WBEs to participate as subcontractors, and in identifying opportunities that are appropriate for participation by MBEs and/or WBEs in contracts.

4. Prospective contractors are encouraged to enter into qualified joint venture agreements with MBEs and/or WBEs as defined by Section 6-129(c)(30).

5. By submitting a bid or proposal the Contractor hereby acknowledges its understanding of the M/WBE Program requirements set forth herein and the pertinent provisions of Section 6-129, and any rules promulgated thereunder, and if awarded this Contract, the Contractor hereby agrees to comply with the M/WBE Program requirements of this Contract and pertinent provisions of Section 6-129, and any rules promulgated thereunder, all of which shall be deemed to be material terms of this Contract. The Contractor hereby agrees to make all reasonable, good faith efforts to solicit and obtain the participation of MBEs and/or WBEs to meet the required **Participation Goals**.

ARTICLE II. ENFORCEMENT

1. If Agency determines that a bidder or proposer, as applicable, has, in relation to this procurement, violated Section 6-129 or the DSBS rules promulgated pursuant to Section 6-129, Agency may disqualify such bidder or proposer, as applicable, from competing for this Contract and the Agency may revoke such bidder's or proposer's prequalification status, if applicable.

2. Whenever Agency believes that the Contractor or a subcontractor is not in compliance with Section 6-129 or the DSBS rules promulgated pursuant to Section 6-129, or any provision of this Contract that implements Section 6-129, including, but not limited to any **M/WBE** Utilization Plan, Agency shall send a written notice to the Contractor describing the alleged noncompliance and offering the Contractor an opportunity to be heard. Agency shall then conduct an investigation to determine whether such Contractor or subcontractor is in compliance.

3. In the event that the Contractor has been found to have violated Section 6-129, the DSBS rules promulgated pursuant to Section 6-129, or any provision of this Contract that implements Section 6-129, including, but not limited to, any **M/WBE** Utilization Plan, Agency may determine that one of the following actions should be taken:

- (a) entering into an agreement with the Contractor allowing the Contractor to cure the violation;
- (b) revoking the Contractor's pre-qualification to bid or make proposals for future contracts;
- (c) making a finding that the Contractor is in default of the Contract;
- (d) terminating the Contract;
- (e) declaring the Contractor to be in breach of Contract;
- (f) withholding payment or reimbursement;
- (g) determining not to renew the Contract;
- (h) assessing actual and consequential damages;
- (i) assessing liquidated damages or reducing fees, provided that liquidated damages may be based on amounts representing costs of delays in carrying out the purposes of the **M/WBE** Program, or in meeting the purposes of the Contract, the costs of meeting utilization goals through additional procurements, the administrative costs of investigation and enforcement, or other factors set forth in the Contract;
- (j) exercising rights under the Contract to procure goods, services or construction from another contractor and charge the cost of such contract to the Contractor that has been found to be in noncompliance; or
- (k) taking any other appropriate remedy.

4. If an **M/WBE** Utilization Plan has been submitted, and pursuant to this Article II, Section 3, the Contractor has been found to have failed to fulfill its **Participation Goals** contained in its **M/WBE** Utilization Plan or the **Participation Goals** as modified by Agency pursuant to Article I, Part A, Section 11, Agency may assess liquidated damages in the amount of ten percent (10%) of the difference between the dollar amount of work required to be awarded to MBE and/or WBE firms to meet the **Participation Goals** and the dollar amount the Contractor actually awarded and paid, and/or credited, to MBE and/or WBE firms. In view of the difficulty of accurately ascertaining the loss which the City will suffer by reason of Contractor's failure to meet the **Participation Goals**, the foregoing amount is hereby fixed and agreed as the liquidated damages that the City will suffer by reason of such failure, and not as a penalty. Agency may deduct and retain out of any monies which may become due under this Contract the amount of any such liquidated damages; and in case the amount which may become due under this Contract shall be less than the amount of liquidated damages suffered by the City, the Contractor shall be liable to pay the difference.

5. Whenever Agency has reason to believe that an MBE and/or WBE is not qualified for certification, or is participating in a contract in a manner that does not serve a commercially useful function (as defined in Section 6-129(c)(8)), or has violated any provision of Section 6-129, Agency shall notify the Commissioner of DSBS who shall determine whether the certification of such business enterprise should be revoked.

6. Statements made in any instrument submitted to Agency pursuant to Section 6-129 shall be submitted under penalty of perjury and any false or misleading statement or omission shall be grounds for the application of any applicable criminal and/or civil penalties for perjury. The making of a false or fraudulent statement by an MBE and/or WBE in any instrument submitted pursuant to Section 6-129 shall, in addition, be grounds for revocation of its certification.

7. The Contractor's record in implementing its M/WBE Utilization Plan shall be a factor in the evaluation of its performance. Whenever Agency determines that a Contractor's compliance with an M/WBE Utilization Plan has been unsatisfactory, Agency shall, after consultation with the City Chief Procurement Officer, file an advice of caution form for inclusion in VENDEX as caution data.

IN WITNESS WHEREOF, the Commissioner, on behalf of the City of New York, and the Contractor, have executed this agreement in quadruplicate, two parts of which are to remain with the Commissioner, another to be filed with the Comptroller of the City, and the fourth to be delivered to the Contractor.

THE CITY OF NEW YORK

By: 
Deputy Commissioner

CONTRACTOR: P & T II Contracting Corp

By: 
(Member of Firm or Officer of Corporation)

Title: President

(Where Contractor is a Corporation, add):
Attest:

Secretary

(Seal)

ACKNOWLEDGEMENT OF PRINCIPAL, IF A CORPORATION

State of New York County of Queens ss:

On this 3rd day of October, 2015, before me personally came Lenny Pereira to me known who, being by me duly sworn did depose and say that he resides at Smithtown, NY that he is the President of the corporation described in and which executed the foregoing instrument, that he knows the seal of said corporation; that one of the seals affixed to said instrument is such seal; that it was so affixed by order of the directors of said corporation, and that he signed his name thereto by like order.

VICTORIA AYO-VAUGHAN
Notary Public, State of New York
Registration #01AY5014042
Qualified in Queens County
Commission Expires July 15, 2019

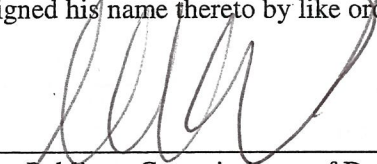

Notary Public or Commissioner of Deeds

ACKNOWLEDGEMENT OF PRINCIPAL, IF A PARTNERSHIP

State of _____ County of _____ ss:

On this ____ day of _____, _____, before me personally appeared _____ to me known, and known to me to be one of the members of the firm of _____ described in and who executed the foregoing instrument; and he acknowledged to me that he executed the same as and for the act and deed of said firm.

Notary Public or Commissioner of Deeds

ACKNOWLEDGEMENT OF PRINCIPAL, IF AN INDIVIDUAL

State of _____ County of _____ ss:

On this ____ day of _____, _____, before me personally appeared _____ to me known, and known to me to be the person described in and who executed the foregoing instrument; and acknowledged that he executed the same.

Notary Public or Commissioner of Deeds

AUTHORITY

MAYOR'S CERTIFICATE NO. CBX
BUDGET DIRECTOR'S CERTIFICATE NO.

DATED
DATED

APPROPRIATION
COMMISSIONER'S CERTIFICATE

In conformity with the provisions of Section 6-101 of the Administrative Code of the City of New York, it is hereby certified that the estimated cost of the work, materials and supplies required by the within Contract, amounting to

Eleven Million, SEVEN HUNDRED
TWENTY NINE THOUSAND, SIX
HUNDRED EIGHTEEN DOLLARS
Dollars (\$ 11,729,618.00)

01/10/13

is chargeable to the fund of the Department of Design and Construction entitled Code

Department of Design and Construction

I hereby certify that the specifications contained herein comply with the terms and conditions of the BUDGET.

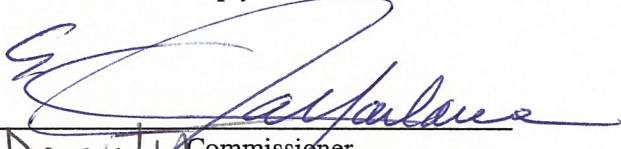
Deputy Commissioner

COMPTROLLER'S CERTIFICATE

The City of New York _____

Pursuant to the provisions of Section 6-101 of the Administrative Code of the City of New York, I hereby certify that there remains unapplied and unexpended a balance of the above mentioned fund applicable to this Contract sufficient to pay the estimated expense of executing the same viz:

\$ _____

Comptroller

ACKNOWLEDGEMENT BY COMMISSIONER

State of New York County of Queens ss:

On this 2nd day of Dec, 2015 before me personally came Eric Macfarlane to me known, and known to be the Deputy Commissioner of the Department of Design and Construction of The City of New York, the person described as such in and who as such executed the foregoing instrument and acknowledged to me that he executed the same as Deputy Commissioner for the purposes therein mentioned.

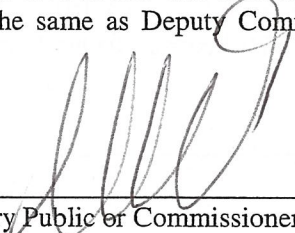

Notary Public or Commissioner of Deeds

VICTORIA AYO-VAUGHAN
Notary Public, State of New York
Registration #01AY5014042
Qualified in Queens County
Commission Expires July 15, 2019

Performance Bond #2 (Pages 82 to 85): Use if the total contract price is more than \$5 Million.

PERFORMANCE BOND #2 (Page 1)

PERFORMANCE BOND #2

Bond #015049223

KNOW ALL PERSONS BY THESE PRESENTS:

That we, P&T II Contracting Corp.

2417 Jericho Tpke., Suite 315

Garden City Park, NY 11040

hereinafter referred to as the "Principal,"

and, Liberty Mutual Insurance Company

1200 MacArthur Blvd.

Mahwah, NJ 07430

hereinafter referred to as the "Surety" ("Sureties") are held and firmly bound to THE CITY OF NEW YORK, hereinafter referred to as the "City" or to its successors and assigns in the penal sum of Eleven Million Seven Hundred Twenty Nine Thousand Six Hundred Eighteen and 01/100

(\$ 11,729,618.01) Dollars, lawful money of the United States for the payment of which said sum of money well and truly to be made, we, and each of us, bind ourselves, our heirs, executors, administrators, successors and assigns, jointly and severally, firmly by these presents.

WHEREAS, the Principal is about to enter, or has entered, into a Contract in writing with the City for

FMS ID: HWQ121B4 - E-PIN: 85015B0135001 - DDC PIN: 8502015HW0021C - Reconstruction

of Lakeview Blvd. East, etc., Boro of Queens

a copy of which Contract is annexed to and hereby made a part of this bond as though herein set forth in full;

NOW, THEREFORE, the conditions of this obligation are such that if the Principal, his or its representatives or assigns, shall well and faithfully perform the said Contract and all modifications, amendments, additions and alterations thereto that may hereafter be made, according to its terms and its true intent and meaning, including repair and or replacement of defective work and guarantees of maintenance for the periods stated in the Contract, and shall fully indemnify and save harmless the City from all cost and damage which it may suffer by reason of the Principal's default of the Contract, and shall fully reimburse and repay the City for all outlay and expense which the City may incur in making



Performance Bond #2 (Pages 82 to 85): Use if the total contract price is more than \$5 Million.

PERFORMANCE BOND #2 (Page 2)

good any such default and shall protect the said City of New York against, and pay any and all amounts, damages, cost and judgments which may or shall be recovered against said City or its officers or agents or which the said City of New York may be called upon to pay any person or corporation by reason of any damages arising or growing out of the Principal's default of the Contract, then this obligation shall be null and void, otherwise to remain in full force and effect.

The Surety (Sureties), for value received, hereby stipulates and agrees, upon written notice from the City that the City has determined that the Principal is in default of the Contract, to either (1) pay the full amount of the above penal sum in complete discharge and exoneration of this bond and of all the liabilities of the Surety relating to this bond, or (2) fully perform and complete the Work to be performed under the Contract, pursuant to the terms, conditions, and covenants thereof. The Surety (Sureties) further agrees, at its option, either to tender the penal sum or to commence and diligently perform the Work specified in the Contract, including physical site work, within twenty-five (25) business days after written notice thereof from the City and to complete all Work within the time set forth in the Contract or such other time as agreed to between the City and Surety in accordance with the Contract. The Surety and the City reserve all rights and defenses each may have against the other; provided, however, that the Surety expressly agrees that its reservation of rights shall not provide a basis for non-performance of its obligation to commence and to complete all Work as provided herein.

The Surety (Sureties), for value received, for itself and its successors and assigns, hereby stipulates and agrees that the obligation of said Surety (Sureties) and its bond shall be in no way impaired or affected by any extension of time, modification, omission, addition, or change in or to the said Contract or the Work to be performed thereunder, or by any payment thereunder before the time required therein, or by any waiver of any provisions thereof, or by any assignment, subletting or other transfer thereof or of any Work to be performed or any moneys due or to become due thereunder; and said Surety (Sureties) does hereby waive notice of any and all of such extensions, modifications, omissions, additions, changes, payments, waivers, assignments, subcontracts and transfers, and hereby expressly stipulates and agrees that any and all things done and omitted to be done by and in relation to assignees, subcontractors, and other transferees shall have the same effect as to said Surety (Sureties) as though done or omitted to be done by or in relation to said Principal.



Performance Bond #2 (Pages 82 to 85): Use if the total contract price is more than \$5 Million.

PERFORMANCE BOND #2 (Page 3)

IN WITNESS WHEREOF, The Principal and the Surety (Sureties) have hereunto set their hands and seals, and such of them as are corporations have caused their corporate seals to be hereunto affixed and these presents to be signed by their proper officers, this

_____ 30th _____ day of _____ September _____ 20 15 _____

(Seal)

_____ P&T II Contracting Corp. _____ (L.S.)

Principal

By: _____

(Seal)

Surety

By: _____

Liberty Mutual Insurance Company

(Seal)

Surety

By: _____

Robert Kempner, Attorney-In-Fact

(Seal)

Surety

By: _____

(Seal)

Surety

By: _____

(Seal)

Surety

By: _____

Bond Premium Rate _____

Bond Premium Cost _____

If the Contractor (Principal) is a partnership, the bond should be signed by each of the individuals who are partners.

If the Contractor (Principal) is a corporation, the bond should be signed in its correct corporate name by a duly authorized officer, agent, or attorney-in-fact.

There should be executed an appropriate number of counterparts of the bond corresponding to the number of counterparts of the Contract.



Performance Bond #2 (Pages 82 to 85): Use if the total contract price is more than \$5 Million.

PERFORMANCE BOND #2 (Page 4)

ACKNOWLEDGMENT OF PRINCIPAL IF A CORPORATION

State of _____ County of _____ ss:

On this _____ day of _____, 20 _____ before me personally came _____ to me known, who, being by me duly sworn did depose and say that he resides at _____

_____ ; that he/she is the _____ of the corporation described in and which executed the foregoing instrument; that he/she signed his/her name to the foregoing instrument by order of the directors of said corporation as the duly authorized and binding act thereof.

Notary Public or Commissioner of Deeds.

ACKNOWLEDGMENT OF PRINCIPAL IF A PARTNERSHIP

State of _____ County of _____ ss:

On this _____ day of _____, 20 _____ before me personally came _____ to me known, who, being by me duly sworn did depose and say that he/she resides at _____

_____ ; that he/she is _____ partner of _____, a limited/general partnership existing under the laws of the State of _____, the partnership described in and which executed the foregoing instrument; and that he/she signed his/her name to the foregoing instrument as the duly authorized and binding act of said partnership.

Notary Public or Commissioner of Deeds

ACKNOWLEDGMENT OF PRINCIPAL IF AN INDIVIDUAL

State of _____ County of _____ ss:

On this _____ day of _____, 20 _____ before me personally came _____ to me known, who, being by me duly sworn did depose and say that he/she resides at _____

_____ and that he/she is the individual whose name is subscribed to the within instrument and acknowledged to me that by his/her signature on the instrument, said individual executed the instrument.

Notary Public or Commissioner of Deeds

Each executed bond should be accompanied by: (a) appropriate acknowledgments of the respective parties; (b) appropriate duly certified copy of Power of Attorney or other certificate of authority where bond is executed by agent, officer or other representative of Principal or Surety; (c) a duly certified extract from By-Laws or resolutions of Surety under which Power of Attorney or other certificate of authority of its agent, officer or representative was issued; and (d) certified copy of latest published financial statement of assets and liabilities of Surety.

Affix Acknowledgments and Justification of Sureties.



ACKNOWLEDGEMENT OF PRINCIPAL, OF A CORPORATION

STATE OF New York

SS:

COUNTY OF Queens

On this 1st day of October, 2015 before me personally came Lenny Pereira to me known, who, being by me duly sworn did depose and say that he resides at Smithtown, NY that he is the President of P+T II Contracting Corp the corporation described in and which executed the foregoing instrument; that he knows the seal of said corporation; that one of the seals affixed to the foregoing instrument is such seal; that it was an affixed by order of the board of directors of said corporation; and that he signed his name thereto by like order.

CLAUDIA J WHITFIELD
NOTARY PUBLIC-STATE OF NEW YORK
No. 01WH5004514
Qualified in Queens County
My Commission Expires November 16, 2018

Claudia J Whitfield
Notary Public

ACKNOWLEDGEMENT OF SURETY

STATE OF New York

SS:

COUNTY OF Nassau

On this 30th day of September, 2015, before me personally came Robert Kempner to me known, who, being by me duly sworn, did depose and say that he is an Attorney-In-Fact of Liberty Mutual Insurance Company the corporation described in and which executed the within instrument; that he knows the corporate seal of said corporation; that the seal affixed to the within instrument is such corporate seal, and that he signed and said instrument and affixed the said seal as Attorney-In-Fact by authority of the Board of Directors of said corporation and by authority of this office under the Standing Resolutions thereof.

LYNN ANN INFANTI
Notary Public, State of New York
No. 01IN8004351
Qualified in Suffolk County
Commission Expires March 23, 2018

My commission expires _____

L

Notary Public



THIS POWER OF ATTORNEY IS NOT VALID UNLESS IT IS PRINTED ON RED BACKGROUND.

This Power of Attorney limits the acts of those named herein, and they have no authority to bind the Company except in the manner and to the extent herein stated.

Certificate No. 7104219

American Fire and Casualty Company
The Ohio Casualty Insurance Company

Liberty Mutual Insurance Company
West American Insurance Company

POWER OF ATTORNEY

KNOWN ALL PERSONS BY THESE PRESENTS: That American Fire & Casualty Company and The Ohio Casualty Insurance Company are corporations duly organized under the laws of the State of New Hampshire, that Liberty Mutual Insurance Company is a corporation duly organized under the laws of the State of Massachusetts, and West American Insurance Company is a corporation duly organized under the laws of the State of Indiana (herein collectively called the "Companies"), pursuant to and by authority herein set forth, does hereby name, constitute and appoint, Joseph Sforzo; Robert Kempner; Robert W. O'Kane

all of the city of Plainview, state of NY each individually if there be more than one named, its true and lawful attorney-in-fact to make, execute, seal, acknowledge and deliver, for and on its behalf as surety and as its act and deed, any and all undertakings, bonds, recognizances and other surety obligations, in pursuance of these presents and shall be as binding upon the Companies as if they have been duly signed by the president and attested by the secretary of the Companies in their own proper persons.

IN WITNESS WHEREOF, this Power of Attorney has been subscribed by an authorized officer or official of the Companies and the corporate seals of the Companies have been affixed thereto this 3rd day of September, 2015.

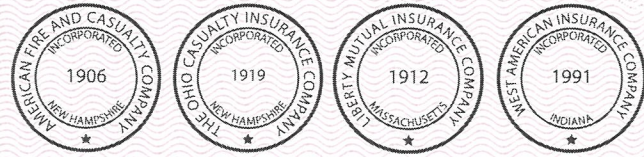

American Fire and Casualty Company
The Ohio Casualty Insurance Company
Liberty Mutual Insurance Company
West American Insurance Company

By: David M. Carey
David M. Carey, Assistant Secretary

STATE OF PENNSYLVANIA ss
COUNTY OF MONTGOMERY

On this 3rd day of September, 2015, before me personally appeared David M. Carey, who acknowledged himself to be the Assistant Secretary of American Fire and Casualty Company, Liberty Mutual Insurance Company, The Ohio Casualty Insurance Company, and West American Insurance Company, and that he, as such, being authorized so to do, execute the foregoing instrument for the purposes therein contained by signing on behalf of the corporations by himself as a duly authorized officer.

IN WITNESS WHEREOF, I have hereunto subscribed my name and affixed my notarial seal at Plymouth Meeting, Pennsylvania, on the day and year first above written.



COMMONWEALTH OF PENNSYLVANIA
Notarial Seal
Teresa Pastella, Notary Public
Plymouth Twp., Montgomery County
My Commission Expires March 28, 2017
Member, Pennsylvania Association of Notaries

By: Teresa Pastella
Teresa Pastella, Notary Public

This Power of Attorney is made and executed pursuant to and by authority of the following By-laws and Authorizations of American Fire and Casualty Company, The Ohio Casualty Insurance Company, Liberty Mutual Insurance Company, and West American Insurance Company which resolutions are now in full force and effect reading as follows:

ARTICLE IV – OFFICERS – Section 12. Power of Attorney. Any officer or other official of the Corporation authorized for that purpose in writing by the Chairman or the President, and subject to such limitation as the Chairman or the President may prescribe, shall appoint such attorneys-in-fact, as may be necessary to act in behalf of the Corporation to make, execute, seal, acknowledge and deliver as surety any and all undertakings, bonds, recognizances and other surety obligations. Such attorneys-in-fact, subject to the limitations set forth in their respective powers of attorney, shall have full power to bind the Corporation by their signature and execution of any such instruments and to attach thereto the seal of the Corporation. When so executed, such instruments shall be as binding as if signed by the President and attested to by the Secretary. Any power or authority granted to any representative or attorney-in-fact under the provisions of this article may be revoked at any time by the Board, the Chairman, the President or by the officer or officers granting such power or authority.

ARTICLE XIII – Execution of Contracts – SECTION 5. Surety Bonds and Undertakings. Any officer of the Company authorized for that purpose in writing by the chairman or the president, and subject to such limitations as the chairman or the president may prescribe, shall appoint such attorneys-in-fact, as may be necessary to act in behalf of the Company to make, execute, seal, acknowledge and deliver as surety any and all undertakings, bonds, recognizances and other surety obligations. Such attorneys-in-fact subject to the limitations set forth in their respective powers of attorney, shall have full power to bind the Company by their signature and execution of any such instruments and to attach thereto the seal of the Company. When so executed such instruments shall be as binding as if signed by the president and attested by the secretary.

Certificate of Designation – The President of the Company, acting pursuant to the Bylaws of the Company, authorizes David M. Carey, Assistant Secretary to appoint such attorneys-in-fact as may be necessary to act on behalf of the Company to make, execute, seal, acknowledge and deliver as surety any and all undertakings, bonds, recognizances and other surety obligations.

Authorization – By unanimous consent of the Company's Board of Directors, the Company consents that facsimile or mechanically reproduced signature of any assistant secretary of the Company, wherever appearing upon a certified copy of any power of attorney issued by the Company in connection with surety bonds, shall be valid and binding upon the Company with the same force and effect as though manually affixed.

I, Gregory W. Davenport, the undersigned, Assistant Secretary, of American Fire and Casualty Company, The Ohio Casualty Insurance Company, Liberty Mutual Insurance Company, and West American Insurance Company do hereby certify that the original power of attorney of which the foregoing is a full, true and correct copy of the Power of Attorney executed by said Companies, is in full force and effect and has not been revoked.

IN TESTIMONY WHEREOF, I have hereunto set my hand and affixed the seals of said Companies this 30th day of September, 2015.

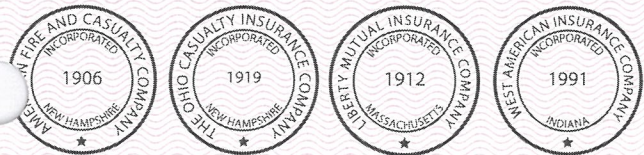

By: Gregory W. Davenport
Gregory W. Davenport, Assistant Secretary

Not valid for mortgage, note, loan, letter of credit, currency rate, interest rate or individual value guarantees.

To confirm the validity of this Power of Attorney call 1-610-832-8240 between 9:00 am and 4:30 pm EST on any business day.





LIBERTY MUTUAL INSURANCE COMPANY
 FINANCIAL STATEMENT — DECEMBER 31, 2014

Assets		Liabilities	
Cash and Bank Deposits.....	\$744,221,142	Unearned Premiums.....	\$6,288,178,795
*Bonds — U.S Government.....	1,718,117,704	Reserve for Claims and Claims Expense.....	16,879,324,618
*Other Bonds.....	11,205,872,087	Funds Held Under Reinsurance Treaties.....	211,983,009
*Stocks.....	9,533,437,819	Reserve for Dividends to Policyholders.....	1,246,547
Real Estate.....	277,742,849	Additional Statutory Reserve.....	40,877,587
Agents' Balances or Uncollected Premiums.....	4,150,041,316	Reserve for Commissions, Taxes and	
Accrued Interest and Rents.....	129,261,358	Other Liabilities.....	<u>2,664,248,124</u>
Other Admitted Assets.....	<u>14,896,464,393</u>	Total.....	<u>\$26,085,858,680</u>
		Special Surplus Funds.....	\$53,954,363
		Capital Stock.....	10,000,000
		Paid in Surplus.....	8,829,117,542
		Unassigned Surplus.....	7,676,228,083
Total Admitted Assets.....	<u>\$42,655,158,668</u>	Surplus to Policyholders.....	<u>16,569,299,988</u>
		Total Liabilities and Surplus.....	<u>\$42,655,158,668</u>



* Bonds are stated at amortized or investment value; Stocks at Association Market Values.
 The foregoing financial information is taken from Liberty Mutual Insurance Company's financial statement filed with the state of Massachusetts Department of Insurance.

I, TIM MIKOLAJEWSKI, Assistant Secretary of Liberty Mutual Insurance Company, do hereby certify that the foregoing is a true, and correct statement of the Assets and Liabilities of said Corporation, as of December 31, 2014, to the best of my knowledge and belief.

IN WITNESS WHEREOF, I have hereunto set my hand and affixed the seal of said Corporation at Seattle, Washington, this 20th day of March, 2015.

TAMikolajewski

Assistant Secretary



Payment Bond (Pages 86 to 89): Use for any contract for which a Payment Bond is required.

PAYMENT BOND (Page 1)

PAYMENT BOND

Bond #015049223

KNOW ALL PERSONS BY THESE PRESENTS, That we, _____

P&T II Contracting Corp.

2417 Jericho Tpke., Suite 315

Garden City Park, NY 11040

hereinafter referred to as the "Principal", and _____

Liberty Mutual Insurance Company

1200 MacArthur Blvd.

Mahwah, NJ 07430

hereinafter referred to as the "Surety" ("Sureties") are held and firmly bound to THE CITY OF NEW YORK, hereinafter referred to as the "City" or to its successors and assigns, in the penal sum of

Eleven Million Seven Hundred Twenty Nine Thousand Six Hundred Eighteen and 01/100

(\$ 11,729,618.01) Dollars, lawful money of the United States, for the payment of which said sum of money well and truly to be made, we, and each of us, bind ourselves, our heirs, executors, administrators, successors and assigns, jointly and severally, firmly by these presents.

WHEREAS, the Principal is about to enter, or has entered, into a Contract in writing with the City for

FMS ID: HWQ121B4 - E-PIN: 85015B0135001 - DDC PIN: 8502015HW0021C - Reconstruction of Lakeview Blvd. East, etc., Boro of Queens

a copy of which Contract is annexed to and hereby made a part of this bond as though herein set forth in full;

NOW, THEREFORE, the conditions of this obligation are such that if the Principal, his or its representatives or assigns and other Subcontractors to whom Work under this Contract is sublet and his or their successors and assigns shall promptly pay or cause to be paid all lawful claims for

(a) Wages and compensation for labor performed and services rendered by all persons engaged in the prosecution of the Work under said Contract, and any amendment or extension thereof or addition thereto, whether such persons be agents servants or employees of the Principal or any such Subcontractor, including all persons so engaged who perform the work of laborers or mechanics at or in the vicinity of the site



Payment Bond (Pages 86 to 89): Use for any contract for which a Payment Bond is required.

PAYMENT BOND (Page 3)

IN WITNESS WHEREOF, the Principal and the Surety (Sureties) have hereunto set their hands and seals, and such of them as are corporations have caused their corporate seals to be hereunto affixed and these presents to be signed by their proper officers, this 30th day of September, 2015.

(Seal)

P&T II Contracting Corp. (L.S.)

Principal

By: 

(Seal)

Liberty Mutual Insurance Company

Surety

By: 

Robert Kempner, Attorney-In-Fact

(Seal)

Surety

By: _____

(Seal)

Surety

By: _____

(Seal)

Surety

By: _____

If the Contractor (Principal) is a partnership, the bond should be signed by each of the individuals who are partners.

If the Contractor (Principal) is a corporation, the bond should be signed in its correct corporate name by a duly authorized officer, agent, or attorney-in-fact.

There should be executed an appropriate number of counterparts of the bond corresponding to the number of counterparts of the Contract.



Payment Bond (Pages 86 to 89): Use for any contract for which a Payment Bond is required.

PAYMENT BOND (Page 4)

ACKNOWLEDGMENT OF PRINCIPAL, IF A CORPORATION

State of _____ County of _____ ss:

On this _____ day of _____, _____, before me personally came _____ to me known, who, being by me duly sworn did depose and say that he resides at _____ that he is the _____ of the corporation described in and which executed the foregoing instrument; that he knows the seal of said corporation; that one of the seals affixed to said instrument is such seal; that it was so affixed by order of the directors of said corporation, and that he signed his name thereto by like order.

Notary Public or Commissioner of Deeds

ACKNOWLEDGMENT OF PRINCIPAL, IF A PARTNERSHIP

State of _____ County of _____ ss:

On this _____ day of _____, _____, before me personally appeared _____ to me known, and known to me to be one of the members of the firm of _____ described in and who executed the foregoing instrument; and he acknowledged to me that he executed the same as and for the act and deed of said firm.

Notary Public or Commissioner of Deeds

ACKNOWLEDGMENT OF PRINCIPAL, IF AN INDIVIDUAL

State of _____ County of _____ ss:

On this _____ day of _____, _____, before me personally appeared _____ to me known, and known to me to be the person described in and who executed the foregoing instrument; and acknowledged that he executed the same.

Notary Public or Commissioner of Deeds

Each executed bond should be accompanied by: (a) appropriate acknowledgments of the respective parties; (b) appropriate duly certified copy of Power of Attorney or other certificate of authority where bond is executed by agent, officer or other representative of Principal or Surety; (c) a duly certified extract from By-Laws or resolutions of Surety under which Power of Attorney or other certificate of authority of its agent, officer or representative was issued, and (d) certified copy of latest published financial statement of assets and liabilities of Surety.

Affix Acknowledgments and Justification of Sureties.



ACKNOWLEDGEMENT OF PRINCIPAL, OF A CORPORATION

STATE OF New York

SS:

COUNTY OF Queens

On this 15th day of October, 2015 before me personally came Lenny Pereira to me known, who, being by me duly sworn did depose and say that he resides at Smithtown, NY that he is the President of P+T II Contracting Corp the corporation described in and which executed the foregoing instrument; that he knows the seal of said corporation; that one of the seals affixed to the foregoing instrument is such seal; that it was an affixed by order of the board of directors of said corporation; and that he signed his name thereto by like order.

CLAUDIA J WHITFIELD
NOTARY PUBLIC-STATE OF NEW YORK
No. 01WH5004514
Qualified in Queens County
My Commission Expires November 16, 2018

Claudia J Whitfield
Notary Public

ACKNOWLEDGEMENT OF SURETY

STATE OF New York

SS:

COUNTY OF Nassau

On this 30th day of September, 2015, before me personally came Robert Kempner to me known, who, being by me duly sworn, did depose and say that he is an Attorney-In-Fact of Liberty Mutual Insurance Company the corporation described in and which executed the within instrument; that he knows the corporate seal of said corporation; that the seal affixed to the within instrument is such corporate seal, and that he signed and said instrument and affixed the said seal as Attorney-In-Fact by authority of the Board of Directors of said corporation and by authority of this office under the Standing Resolutions thereof.

LYNN ANN INFANTI
Notary Public, State of New York
No. 01IN8004351
Qualified in Suffolk County
Commission Expires March 23, 2018

My commission expires _____

L

Notary Public



THIS POWER OF ATTORNEY IS NOT VALID UNLESS IT IS PRINTED ON RED BACKGROUND.

This Power of Attorney limits the acts of those named herein, and they have no authority to bind the Company except in the manner and to the extent herein stated.

Certificate No. 7104218

American Fire and Casualty Company
The Ohio Casualty Insurance Company

Liberty Mutual Insurance Company
West American Insurance Company

POWER OF ATTORNEY

KNOWN ALL PERSONS BY THESE PRESENTS: That American Fire & Casualty Company and The Ohio Casualty Insurance Company are corporations duly organized under the laws of the State of New Hampshire, that Liberty Mutual Insurance Company is a corporation duly organized under the laws of the State of Massachusetts, and West American Insurance Company is a corporation duly organized under the laws of the State of Indiana (herein collectively called the "Companies"), pursuant to and by authority herein set forth, does hereby name, constitute and appoint, Joseph Sforzo; Robert Kempner; Robert W. O'Kane

all of the city of Plainview, state of NY each individually if there be more than one named, its true and lawful attorney-in-fact to make, execute, seal, acknowledge and deliver, for and on its behalf as surety and as its act and deed, any and all undertakings, bonds, recognizances and other surety obligations, in pursuance of these presents and shall be as binding upon the Companies as if they have been duly signed by the president and attested by the secretary of the Companies in their own proper persons.

IN WITNESS WHEREOF, this Power of Attorney has been subscribed by an authorized officer or official of the Companies and the corporate seals of the Companies have been affixed thereto this 3rd day of September, 2015.

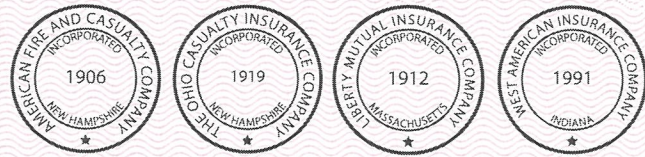

American Fire and Casualty Company
The Ohio Casualty Insurance Company
Liberty Mutual Insurance Company
West American Insurance Company

By: David M. Carey
David M. Carey, Assistant Secretary

STATE OF PENNSYLVANIA ss
COUNTY OF MONTGOMERY

On this 3rd day of September, 2015, before me personally appeared David M. Carey, who acknowledged himself to be the Assistant Secretary of American Fire and Casualty Company, Liberty Mutual Insurance Company, The Ohio Casualty Insurance Company, and West American Insurance Company, and that he, as such, being authorized so to do, execute the foregoing instrument for the purposes therein contained by signing on behalf of the corporations by himself as a duly authorized officer.

IN WITNESS WHEREOF, I have hereunto subscribed my name and affixed my notarial seal at Plymouth Meeting, Pennsylvania, on the day and year first above written.



COMMONWEALTH OF PENNSYLVANIA
Notarial Seal
Teresa Pastella, Notary Public
Plymouth Twp., Montgomery County
My Commission Expires March 28, 2017
Member, Pennsylvania Association of Notaries

By: Teresa Pastella
Teresa Pastella, Notary Public

This Power of Attorney is made and executed pursuant to and by authority of the following By-laws and Authorizations of American Fire and Casualty Company, The Ohio Casualty Insurance Company, Liberty Mutual Insurance Company, and West American Insurance Company which resolutions are now in full force and effect reading as follows:

ARTICLE IV – OFFICERS – Section 12. Power of Attorney. Any officer or other official of the Corporation authorized for that purpose in writing by the Chairman or the President, and subject to such limitation as the Chairman or the President may prescribe, shall appoint such attorneys-in-fact, as may be necessary to act in behalf of the Corporation to make, execute, seal, acknowledge and deliver as surety any and all undertakings, bonds, recognizances and other surety obligations. Such attorneys-in-fact, subject to the limitations set forth in their respective powers of attorney, shall have full power to bind the Corporation by their signature and execution of any such instruments and to attach thereto the seal of the Corporation. When so executed, such instruments shall be as binding as if signed by the President and attested to by the Secretary. Any power or authority granted to any representative or attorney-in-fact under the provisions of this article may be revoked at any time by the Board, the Chairman, the President or by the officer or officers granting such power or authority.

ARTICLE XIII – Execution of Contracts – SECTION 5. Surety Bonds and Undertakings. Any officer of the Company authorized for that purpose in writing by the chairman or the president, and subject to such limitations as the chairman or the president may prescribe, shall appoint such attorneys-in-fact, as may be necessary to act in behalf of the Company to make, execute, seal, acknowledge and deliver as surety any and all undertakings, bonds, recognizances and other surety obligations. Such attorneys-in-fact subject to the limitations set forth in their respective powers of attorney, shall have full power to bind the Company by their signature and execution of any such instruments and to attach thereto the seal of the Company. When so executed such instruments shall be as binding as if signed by the president and attested by the secretary.

Certificate of Designation – The President of the Company, acting pursuant to the Bylaws of the Company, authorizes David M. Carey, Assistant Secretary to appoint such attorneys-in-fact as may be necessary to act on behalf of the Company to make, execute, seal, acknowledge and deliver as surety any and all undertakings, bonds, recognizances and other surety obligations.

Authorization – By unanimous consent of the Company's Board of Directors, the Company consents that facsimile or mechanically reproduced signature of any assistant secretary of the Company, wherever appearing upon a certified copy of any power of attorney issued by the Company in connection with surety bonds, shall be valid and binding upon the Company with the same force and effect as though manually affixed.

I, Gregory W. Davenport, the undersigned, Assistant Secretary, of American Fire and Casualty Company, The Ohio Casualty Insurance Company, Liberty Mutual Insurance Company, and West American Insurance Company do hereby certify that the original power of attorney of which the foregoing is a full, true and correct copy of the Power of Attorney executed by said Companies, is in full force and effect and has not been revoked.

IN TESTIMONY WHEREOF, I have hereunto set my hand and affixed the seals of said Companies this 30th day of September, 2015.



By: Gregory W. Davenport
Gregory W. Davenport, Assistant Secretary

Not valid for mortgage, note, loan, letter of credit, currency rate, interest rate or individual value guarantees.

To confirm the validity of this Power of Attorney call 1-610-832-8240 between 9:00 am and 4:30 pm EST on any business day.





LIBERTY MUTUAL INSURANCE COMPANY
 FINANCIAL STATEMENT — DECEMBER 31, 2014

Assets		Liabilities	
Cash and Bank Deposits	\$744,221,142	Unearned Premiums	\$6,288,178,795
*Bonds — U.S Government	1,718,117,704	Reserve for Claims and Claims Expense	16,879,324,618
*Other Bonds	11,205,872,087	Funds Held Under Reinsurance Treaties	211,983,009
*Stocks	9,533,437,819	Reserve for Dividends to Policyholders	1,246,547
Real Estate	277,742,849	Additional Statutory Reserve	40,877,587
Agents' Balances or Uncollected Premiums	4,150,041,316	Reserve for Commissions, Taxes and	
Accrued Interest and Rents	129,261,358	Other Liabilities	<u>2,664,248,124</u>
Other Admitted Assets	<u>14,896,464,393</u>	Total	<u>\$26,085,858,680</u>
Total Admitted Assets	<u>\$42,655,158,668</u>	Special Surplus Funds	\$53,954,363
		Capital Stock	10,000,000
		Paid in Surplus	8,829,117,542
		Unassigned Surplus	7,676,228,083
		Surplus to Policyholders	<u>16,569,299,988</u>
		Total Liabilities and Surplus	<u>\$42,655,158,668</u>



* Bonds are stated at amortized or investment value; Stocks at Association Market Values.
 The foregoing financial information is taken from Liberty Mutual Insurance Company's financial statement filed with the state of Massachusetts Department of Insurance.

I, TIM MIKOLAJEWSKI, Assistant Secretary of Liberty Mutual Insurance Company, do hereby certify that the foregoing is a true, and correct statement of the Assets and Liabilities of said Corporation, as of December 31, 2014, to the best of my knowledge and belief.

IN WITNESS WHEREOF, I have hereunto set my hand and affixed the seal of said Corporation at Seattle, Washington, this 20th day of March, 2015.

T. Mikolajewski

Assistant Secretary





CERTIFICATE OF LIABILITY INSURANCE

DATE (MM/DD/YYYY)
9/30/2015

THIS CERTIFICATE IS ISSUED AS A MATTER OF INFORMATION ONLY AND CONFERS NO RIGHTS UPON THE CERTIFICATE HOLDER. THIS CERTIFICATE DOES NOT AFFIRMATIVELY OR NEGATIVELY AMEND, EXTEND OR ALTER THE COVERAGE AFFORDED BY THE POLICIES BELOW. THIS CERTIFICATE OF INSURANCE DOES NOT CONSTITUTE A CONTRACT BETWEEN THE ISSUING INSURER(S), AUTHORIZED REPRESENTATIVE OR PRODUCER, AND THE CERTIFICATE HOLDER.

IMPORTANT: If the certificate holder is an ADDITIONAL INSURED, the policy(ies) must be endorsed. If SUBROGATION IS WAIVED, subject to the terms and conditions of the policy, certain policies may require an endorsement. A statement on this certificate does not confer rights to the certificate holder in lieu of such endorsement(s).

PRODUCER Vanguard Coverage Corporation 131 SUNNYSIDE BLVD SUITE 112 PLAINVIEW NY 11803		CONTACT NAME: KELLY GORHAM PHONE (A/C, No, Ext): (516) 349-1333 FAX (A/C, No): (516) 349-8667 E-MAIL ADDRESS: KGORHAM@VANGUARDCOVERAGE.COM															
INSURED P & T II Contracting Corp. 2417 Jericho Tpke Suite 315 Garden City Park NY 11040		<table border="1"> <thead> <tr> <th>INSURER(S) AFFORDING COVERAGE</th> <th>NAIC #</th> </tr> </thead> <tbody> <tr> <td>INSURER A: Travelers Indemnity Company</td> <td>25658</td> </tr> <tr> <td>INSURER B: Travelers P&C Co of America</td> <td>25674</td> </tr> <tr> <td>INSURER C: Starr Indemnity & Liab Co</td> <td>38318</td> </tr> <tr> <td>INSURER D: The Phoenix Insurance Co.</td> <td>25623</td> </tr> <tr> <td>INSURER E: American Guarantee & Liability</td> <td>26247</td> </tr> <tr> <td>INSURER F:</td> <td></td> </tr> </tbody> </table>		INSURER(S) AFFORDING COVERAGE	NAIC #	INSURER A: Travelers Indemnity Company	25658	INSURER B: Travelers P&C Co of America	25674	INSURER C: Starr Indemnity & Liab Co	38318	INSURER D: The Phoenix Insurance Co.	25623	INSURER E: American Guarantee & Liability	26247	INSURER F:	
INSURER(S) AFFORDING COVERAGE	NAIC #																
INSURER A: Travelers Indemnity Company	25658																
INSURER B: Travelers P&C Co of America	25674																
INSURER C: Starr Indemnity & Liab Co	38318																
INSURER D: The Phoenix Insurance Co.	25623																
INSURER E: American Guarantee & Liability	26247																
INSURER F:																	

COVERAGES

CERTIFICATE NUMBER: 15-16 NYCDDC

REVISION NUMBER:

THIS IS TO CERTIFY THAT THE POLICIES OF INSURANCE LISTED BELOW HAVE BEEN ISSUED TO THE INSURED NAMED ABOVE FOR THE POLICY PERIOD INDICATED. NOTWITHSTANDING ANY REQUIREMENT, TERM OR CONDITION OF ANY CONTRACT OR OTHER DOCUMENT WITH RESPECT TO WHICH THIS CERTIFICATE MAY BE ISSUED OR MAY PERTAIN, THE INSURANCE AFFORDED BY THE POLICIES DESCRIBED HEREIN IS SUBJECT TO ALL THE TERMS, EXCLUSIONS AND CONDITIONS OF SUCH POLICIES. LIMITS SHOWN MAY HAVE BEEN REDUCED BY PAID CLAIMS.

INSR LTR	TYPE OF INSURANCE	ADDL INSR	SUBR WVD	POLICY NUMBER	POLICY EFF (MM/DD/YYYY)	POLICY EXP (MM/DD/YYYY)	LIMITS
A	GENERAL LIABILITY			DTINCO1976P458IND15	4/1/2015	4/1/2016	EACH OCCURRENCE \$ 2,000,000
	<input checked="" type="checkbox"/> COMMERCIAL GENERAL LIABILITY						DAMAGE TO RENTED PREMISES (Ea occurrence) \$ 300,000
	<input type="checkbox"/> CLAIMS-MADE <input checked="" type="checkbox"/> OCCUR						MED EXP (Any one person) \$ 10,000
	<input checked="" type="checkbox"/> CONTRACTUAL LIABILITY						PERSONAL & ADV INJURY \$ 2,000,000
	<input checked="" type="checkbox"/> X,C,U						GENERAL AGGREGATE \$ 4,000,000
	GEN'L AGGREGATE LIMIT APPLIES PER:						PRODUCTS - COMP/OP AGG \$ 4,000,000
<input type="checkbox"/> POLICY <input checked="" type="checkbox"/> PROJECT <input type="checkbox"/> LOC							
B	AUTOMOBILE LIABILITY			DT8102467P822PHX15	4/1/2015	4/1/2016	COMBINED SINGLE LIMIT (Ea accident) \$ 1,000,000
	<input checked="" type="checkbox"/> ANY AUTO						BODILY INJURY (Per person) \$
	<input type="checkbox"/> ALL OWNED AUTOS	<input type="checkbox"/> SCHEDULED AUTOS					BODILY INJURY (Per accident) \$
	<input checked="" type="checkbox"/> HIRED AUTOS	<input checked="" type="checkbox"/> NON-OWNED AUTOS					PROPERTY DAMAGE (Per accident) \$
							\$
C	<input checked="" type="checkbox"/> UMBRELLA LIAB	<input checked="" type="checkbox"/> OCCUR		1000021697	4/1/2015	4/1/2016	EACH OCCURRENCE \$ 1,000,000
	<input type="checkbox"/> EXCESS LIAB	<input type="checkbox"/> CLAIMS-MADE					AGGREGATE \$ 2,000,000
	DED <input checked="" type="checkbox"/> RETENTION \$ 10,000						\$
D	WORKERS COMPENSATION AND EMPLOYERS' LIABILITY			DTNUB2467P82215	4/1/2015	4/1/2016	<input checked="" type="checkbox"/> WC STATUTORY LIMITS <input type="checkbox"/> OTHER
	ANY PROPRIETOR/PARTNER/EXECUTIVE OFFICER/MEMBER EXCLUDED? (Mandatory in NH)	<input type="checkbox"/> Y/N	N/A				E.L. EACH ACCIDENT \$ 1,000,000
	If yes, describe under DESCRIPTION OF OPERATIONS below						E.L. DISEASE - EA EMPLOYEE \$ 1,000,000
							E.L. DISEASE - POLICY LIMIT \$ 1,000,000
E	EXCESS LIABILITY			AEC 0113880-00	4/1/2015	4/1/2016	OCCURENCE: \$15,000,000
							AGGREGATE: \$15,000,000

DESCRIPTION OF OPERATIONS / LOCATIONS / VEHICLES (Attach ACORD 101, Additional Remarks Schedule, if more space is required)

RE: EMS ID: HWQ121B4, E-Pin: 85015B0135001, DDC Pin: 8502015HW0021C, Reconstruciton of Lakeview Blvd East, Ect. Borough of Queens.

THE FOLLOWING ARE INCLUDED AS ADDITIONAL INSUREDS WHERE REQUIRED BY WRITTEN CONTRACT: CITY OF NEW YORK, INCLUDING ITS OFFICIALS AND EMPLOYEES. and National Grid.

CERTIFICATE HOLDER**CANCELLATION**

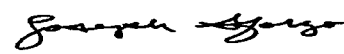
CITY OF NEW YORK DEPARTMENT OF DESIGN AND CONSTRUCTION DIRECTOR, RISK MANAGEMENT AND INSURANCE 30-30 THOMSON AVENUE 4TH FLOOR LONG ISLAND CITY, NY 11101-3045	SHOULD ANY OF THE ABOVE DESCRIBED POLICIES BE CANCELLED BEFORE THE EXPIRATION DATE THEREOF, NOTICE WILL BE DELIVERED IN ACCORDANCE WITH THE POLICY PROVISIONS.
	AUTHORIZED REPRESENTATIVE Joseph Sforzo/DEBBIE 

ACORD 25 (2010/05)

© 1988-2010 ACORD CORPORATION. All rights reserved.

INS025 (201005) 01

The ACORD name and logo are registered marks of ACORD



Schedule A
(GENERAL CONDITIONS TO CONSTRUCTION CONTRACT)
(GENERAL CONDITIONS RELATING TO ARTICLE 22 –
INSURANCE

Part III. BROKER'S CERTIFICATION

[Note to Contracting Agency: Pursuant to Article 22.3.3 of the Contract, every Certificate of the Insurance must be accompanied by either the following certification by broker setting forth the following text and required information and signatures or certified copies of all policies referenced in the Certificate of Insurance.]

CERTIFICATION NY BROKER

The undersigned insurance broker represents to the City of New York that the attached Certificate of Insurance is accurate in all material respects, and that the described insurance is effective as of the date of this Certification.

VANGUARD COVERAGE

[Name of Broker (typewritten)]

131 SUNNYSIDE BLVD. SUITE 112, PLAINVIEW, NY 11803

[Address of Broker (typewritten)]

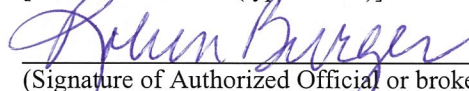

(Signature of Authorized Official or broker)

RBurger@vanguardcoverage.com

[Name and title of authorized official (typewritten)]

516-349-1333

Phone number/Fax number of broker [typewritten)]

Robin Burger, Insurance Operations Manager

[Name and title of authorized official (typewritten)]

State ofNY.....)

)SS:

County ofNassau.....)

Sworn to before me this 30th day of September 2015

Notary Public for the state of NY

Standard Construction Contract Schedule A
December 2013

LYNN ANN INFANTI
Notary Public, State of New York
No. 01IN6004351
Qualified in Suffolk County 2014
Commission Expires March 23, 2015



Faint, illegible text or markings at the bottom left of the page.

STATE OF NEW YORK
WORKERS' COMPENSATION BOARD
CERTIFICATE OF INSURANCE COVERAGE UNDER THE NYS DISABILITY BENEFITS LAW

PART 1. To be completed by Disability Benefits Carrier or Licensed Insurance Agent of that Carrier

1a. Legal Name and Address of Insured (Use street address only) P & T II CONTRACTING CORP. 2417 JERICHO TURNPIKE, SUITE 315 GARDEN CITY PARK, NY 11040	1b. Business Telephone Number of Insured 7182060210 1c. NYS Unemployment Insurance Employer Registration Number of Insured PENDING 1d. Federal Employer Identification Number of Insured or Social Security Number 20-4708892
2. Name and Address of the Entity Requesting Proof of Coverage (Entity Being Listed as the Certificate Holder) CITY OF NEW YORK DEPARTMENT OF DESIGN AND CONSTRUCTION DIRECTOR, RISK MANAGEMENT AND INSURANCE 30-30 THOMSON AVENUE, 4th Floor LONG ISLAND CITY, NY 11101	3a. Name of Insurance Carrier Standard Security Life Insurance Company of New York 3b. Policy Number of entity listed in box "1a": D91505-000 3c. Policy effective period: <u>2/15/2007</u> to <u>9/28/2016</u>

4. Policy covers:

a. All of the employer's employees eligible under the New York Disability Benefits Law

b. Only the following class or classes of the employer's employees:

Under penalty of perjury, I certify that I am an authorized representative or licensed agent of the insurance carrier referenced above and that the named insured has NYS Disability Benefits insurance coverage as described above.

Date Signed 9/30/2015 By *Beth A. Spampin*
Signature of insurance carrier's authorized representative or NYS Licensed Insurance Agent of that insurance carrier)

Telephone Number (212) 355-4141 Title SUPERVISOR-DBL/POLICY SERVICES

IMPORTANT: If box "4a" is checked, and this form is signed by the insurance carrier's authorized representative or NYS Licensed Insurance Agent of that carrier, this certificate is COMPLETE. Mail it directly to the certificate holder.
If box "4b" is checked, this certificate is NOT COMPLETE for purposes of Section 220, Subd. 8 of the Disability Benefits Law. It must be mailed for completion to the Workers' Compensation Board, DB Plans Acceptance Unit, 20 Park Street, Albany, New York 12207.

PART 2. To be completed by NYS Workers' Compensation Board (Only if box "4b" of Part 1 has been checked)

**State Of New York
Workers' Compensation Board**

According to information maintained by the NYS Workers' Compensation Board, the above-named employer has complied with the NYS Disability Benefits Law with respect to all of his/her employees.

Date Signed _____ By _____
(Signature of NYS Workers' Compensation Board Employee)

Telephone Number _____ Title _____

Please Note: Only insurance carriers licensed to write NYS disability benefits insurance policies and NYS licensed insurance agents of those insurance carriers are authorized to issue Form DB-120.1. **Insurance brokers are NOT authorized to issue this form.**



Additional Instructions for Form DB-120.1

By signing this form, the insurance carrier identified in box "3" on this form is certifying that it is insuring the business referenced in box "1a" for disability benefits under the New York State Disability Benefits Law. The Insurance Carrier or its licensed agent will send this Certificate of Insurance to the entity listed as the certificate holder in box "2". ***This Certificate is valid for the earlier of one year after this form is approved by the insurance carrier or its licensed agent, or the policy expiration date listed in box "3c".***

Please Note: Upon the cancellation of the disability benefits policy indicated on this form, if the business continues to be named on a permit, license or contract issued by a certificate holder, the business must provide that certificate holder with a new Certificate of NYS Disability Benefits Coverage or other authorized proof that the business is complying with the mandatory coverage requirements of the New York State Disability Benefits Law.

DISABILITY BENEFITS LAW

§220. Subd. 8

(a) The head of a state or municipal department, board, commission or office authorized or required by law to issue any permit for or in connection with any work involving the employment of employees in employment as defined in this article, and notwithstanding any general or special statute requiring or authorizing the issue of such permits, shall not issue such permit unless proof duly subscribed by an insurance carrier is produced in a form satisfactory to the chair, that the payment of disability benefits for all employees has been secured as provided by this article. Nothing herein, however, shall be construed as creating any liability on the part of such state or municipal department, board, commission or office to pay any disability benefits to any such employee if so employed.

(b) The head of a state or municipal department, board, commission or office authorized or required by law to enter into any contract for or in connection with any work involving the employment of employees in employment as defined in this article, and notwithstanding any general or special statute requiring or authorizing any such contract, shall not enter into any such contract unless proof duly subscribed by an insurance carrier is produced in a form satisfactory to the chair, that the payment of disability benefits for all employees has been secured as provided by this article.



STATE OF NEW YORK
WORKERS' COMPENSATION BOARD

CERTIFICATE OF NYS WORKERS' COMPENSATION INSURANCE COVERAGE

1a. Legal Name & Address of Insured (Use street address only) P & T II CONTRACTING CORP. 2417 JERICHO TPKE. SUITE 315 GARDEN CITY PARK, NY 11040 Work Location of Insured (Only required if coverage is specifically limited to certain locations in New York State, i.e., a Wrap-Up Policy) ALL LOCATIONS	1b. Business Telephone Number of Insured 718-206-0210 1c. NYS Unemployment Insurance Employer Registration Number of Insured 1d. Federal Employer Identification Number of Insured or Social Security Number 204708892
2. Name and Address of the Entity Requesting Proof of Coverage (Entity Being Listed as the Certificate Holder) CITY OF NEW YORK DEPARTMENT OF DESIGN AND CONSTRUCTION DIRECTOR, RISK MANAGEMENT & INSURANCE 30-30 THOMSON AVENUE 4TH FLOOR LONG ISLAND CITY, NY 11101-3045	3a. Name of Insurance Carrier TRAVELERS INDEMNITY COMPANY 3b. Policy Number of entity listed in box "1a" DTNUB2467P82215 3c. Policy effective period 04-01-15 TO 04-01-16 3d. The Proprietor, Partners or Executive Officers are <input checked="" type="checkbox"/> included. (Only check box if all partners/officers included) <input type="checkbox"/> all excluded or certain partners/officers excluded.

This certifies that the insurance carrier indicated above in box "3" insures the business referenced above in box "1a" for workers' compensation under the New York State Workers' Compensation Law. **(To use this form, New York (NY) must be listed under Item 3A on the INFORMATION PAGE of the workers' compensation insurance policy).** The Insurance Carrier or its licensed agent will send this Certificate of Insurance to the entity listed above as the certificate holder in box "2".

The Insurance Carrier will also notify the above certificate holder within 10 days IF a policy is canceled due to nonpayment of premiums or within 30 days IF there are reasons other than nonpayment of premiums that cancel the policy or eliminate the insured from the coverage indicated on this Certificate. (These notices may be sent by regular mail.) Otherwise, this Certificate is valid for one year after this form is approved by the insurance carrier or its licensed agent, or until the policy expiration date listed in box "3c", whichever is earlier.

Please Note: Upon the cancellation of the workers' compensation policy indicated on this form, if the business continues to be named on a permit, license or contract issued by a certificate holder, the business must provide that certificate holder with a new Certificate of Workers' Compensation Coverage or other authorized proof that the business is complying with the mandatory coverage requirements of the New York State Workers' Compensation Law.

Under penalty of perjury, I certify that I am an authorized representative or licensed agent of the insurance carrier referenced above and that the named insured has the coverage as depicted on this form.

Approved by: Robin Burger
(Print name of authorized representative or licensed agent of insurance carrier)

Approved by: _____
(Signature) (Date)

Title: Insurance Operations Manager

Telephone Number of authorized representative or licensed agent of insurance carrier: 516-349-1333

Please Note: Only insurance carriers and their licensed agents are authorized to issue Form C-105.2. Insurance brokers are NOT authorized to issue it.



Section 57. Restriction on issue of permits and the entering into contracts unless compensation is secured.

1. The head of a state or municipal department, board, commission or office authorized or required by law to issue any permit for or in connection with any work involving the employment of employees in a hazardous employment defined by this chapter, and notwithstanding any general or special statute requiring or authorizing the issue of such permits, shall not issue such permit unless proof duly subscribed by an insurance carrier is produced in a form satisfactory to the chair, that compensation for all employees has been secured as provided by this chapter. Nothing herein, however, shall be construed as creating any liability on the part of such state or municipal department, board, commission or office to pay any compensation to any such employee if so employed.

2. The head of a state or municipal department, board, commission or office authorized or required by law to enter into any contract for or in connection with any work involving the employment of employees in a hazardous employment defined by this chapter, notwithstanding any general or special statute requiring or authorizing any such contract, shall not enter into any such contract unless proof duly subscribed by an insurance carrier is produced in a form satisfactory to the chair, that compensation for all employees has been secured as provided by this chapter.



SCHEDULE OF WORKMEN, MECHANICS AND LABORERS

The following is a list of classifications for workmen, mechanics and laborers which are anticipated to be employed in the performance of work under this contract, followed by a schedule of the prevailing wage rates and supplemental benefits for all classifications as established by the Comptroller of the City of New York.

Request for interpretation or correction under Subsection A of Section No. 3 in the Information for Bidders includes all requests for clarification of the classification of trades to be employed in the performance of the work under this contract.

In the event that a trade not listed in the classification of trades required to be used at the time of the award of the contract is in fact employed during the performance of this contract, the Contractor shall be required to obtain from the agency the prevailing wage rates and supplementary benefits for the trades used and to complete the performance of this contract at the price at which the contract was awarded.

<u>CODE</u>	<u>CLASSIFICATION</u>
15 42 001	Rigger
15 42 002	Sign Erector
16 11 001	Gardener
16 11 002	Tree Pruner
16 11 003	Tree Remover
16 11 011	Asphalt Raker (Highway & Paving)
16 11 012	Tamper (Highway & Paving)
16 11 013	Curbsetter (Highway & Paving)
16 11 014	Formsetter (Highway & Paving)
16 11 015	Rammerman (Highway & Paving)
16 11 016	Laborer (Highway & Paving)
16 11 017	ALL OTHER TITLES (Highway & Paving)
16 23 001	Laborer
16 23 002	Operating Engineer (Heavy Construction-Maintenance)
16 23 003	Junior Operating Engineer
16 23 004	Junior Operating Engineer
16 23 005	Junior Operating Engineer
16 23 006	Fireman (Heavy Construction)
16 23 007	Oiler (Heavy Construction)
16 23 051	Surveyor-Heavy Construction
16 23 052	Surveyor-Heavy Construction-Instrument Man
16 23 053	Surveyor-Heavy Construction-Rodman
16 23 057	Surveyor-Land Surveying-Party Chief
16 23 058	Surveyor-Land Surveying-Instrument Man
16 23 059	Surveyor-Land Surveying-Rodman

<u>CODE</u>	<u>CLASSIFICATION</u>
16 23 061	Operating Engineer-Road & Heavy Construction
16 23 062	Operating Engineer-Paving
16 23 063	Operating Engineer-Concrete
16 23 071	Teamster-Heavy Equipment Trailer Driver
16 23 072	Teamster-Dump Truck Driver
16 23 073	Teamster-Flat Bed Trailer Driver (3-Axle)
16 23 074	Teamster-Redi-Mix (Sand and Gravel)
16 29 011	Drill Runners
17 11 001	Plumbers
17 21 001	Painter (Brush & Roller)
17 31 001	Electrician
17 41 001	Bricklayer
17 41 002	Mason Tender
17 41 004	Cement Mason
17 42 002	Metallic Lather
17 51 001	Carpenter
17 51 002	Dock Builder
17 71 001	Cement & Concrete Worker
17 91 001	Structural Iron Worker
17 95 001	Barman
17 96 021	Derrickmen & Riggers
17 99 001	Ornamental Iron Worker
17 99 002	Sandblaster
17 99 005	Pointers (Waterproofer)
17 99 011	Welders

Each classification may include trainees depending upon project staffing schedules and as required by the terms of this contract.

**OFFICE OF THE COMPTROLLER, CITY OF NEW YORK
§220 PREVAILING WAGE SCHEDULE**

LABOR LAW §220 PREVAILING WAGE SCHEDULE

Workers, Laborers and Mechanics employed on a public work project must receive not less than the prevailing rate of wage and benefits for the classification of work performed by each upon such public work. Pursuant to Labor Law §220 the Comptroller of the City of New York has promulgated this schedule solely for Workers, Laborers and Mechanics engaged by private contractors on New York City public work contracts.

This schedule is a compilation of separate determinations of the prevailing rate of wage and supplements made by the Comptroller for each trade classification listed herein pursuant to New York State Labor Law section 220 (5). The source of the wage and supplement rates, whether a collective bargaining agreement, survey data or other, is listed at the end of each classification.

Agency Chief Contracting Officers should contact the Bureau of Labor Law's Classification Unit with any questions concerning trade classifications, prevailing rates or prevailing practices with respect to procurement on New York City public works contracts. Contractors are advised to review the Comptroller's Prevailing Wage Schedule before bidding on public works contracts. Contractors with questions concerning trade classifications, prevailing rates or prevailing practices with respect to public works contracts in the procurement stage must contact the contracting agency responsible for the procurement.

Any error as to compensation under the prevailing wage law or other information as to trade classification, made by the contracting agency in the contract documents or in any other communication, will not preclude a finding against the contractor of prevailing wage violation.

Any questions concerning trade classifications, prevailing rates or prevailing practices on New York City public works contracts that have already been awarded may be directed to the Bureau of Labor Law's Classification Unit by calling (212) 669-7974. All callers must have the agency name and contract registration number available when calling with questions on public works contracts. Please direct all other compliance issues to: Bureau of Labor Law, Attn: Wasyl Kinach, P.E., Office of the Comptroller, 1 Centre Street, Room 1122, New York, N.Y. 10007; Fax (212) 669-4002.

The appropriate schedule of prevailing wages and benefits must be posted at all public work sites pursuant to Labor Law §220 (3-a) (a).

This schedule is applicable to work performed during the effective period, unless otherwise noted. Changes to this schedule are published on our web site www.comptroller.nyc.gov. Contractors must pay the wages and supplements in effect when the worker, laborer, mechanic performs the work. Preliminary schedules for future one-year periods appear in the City Record on or about June 1 each succeeding year. Final schedules appear on or about July 1 in the City Record and on our web site www.comptroller.nyc.gov.

The Comptroller's Office has attempted to include all overtime, shift and night differential, Holiday, Saturday, Sunday or other premium time work. However, this schedule does not set forth every prevailing practice with respect to such rates with which employers must comply. All such practices are nevertheless part of the employer's prevailing wage obligation and contained in the collective bargaining agreements of the prevailing wage unions. These collective bargaining agreements are available for inspection by appointment. Requests for appointments may be made by calling (212) 669-4443, Monday through Friday between the hours of 9 a.m. and 5 p.m.

OFFICE OF THE COMPTROLLER, CITY OF NEW YORK
§220 PREVAILING WAGE SCHEDULE

Prevailing rates and ratios for apprentices are attached to this schedule in the Appendix. Pursuant to Labor Law §220 (3-e), only apprentices who are individually registered in a bona fide program to which the employer contractor is a participant, registered with the New York State Department of Labor, may be employed on a public work project. Workers who are not journey persons or not registered apprentices pursuant to Labor Law §220 (3-e) may not be substituted for apprentices and must be paid as journey persons.

Public Work construction, reconstruction, demolition, excavation, rehabilitation, repair, renovation, alteration, or improvement contracts awarded pursuant to a Project Labor Agreement ("PLA") in accordance with Labor Law section 222 may have different labor standards for shift, premium and overtime work. Please refer to the PLA's pre-negotiated labor agreements for wage and benefit rates applicable to work performed outside of the regular workday. More information is available at the Mayor's Office of Contract Services (MOCS) web page at <http://www.nyc.gov/html/mocs/html/vendors/pla.shtml>.

All the provisions of Labor Law section 220 remain applicable to PLA work including, but not limited to, the enforcement of prevailing wage requirements by the Comptroller; however, we will enforce shift, premium, overtime and other non-standard rates as they appear in a project's pre-negotiated labor agreement.

In order to meet their obligation to provide prevailing supplemental benefits to each covered employee, employers must either:

- 1) Provide bona-fide benefits which cost the employer no less than the prevailing supplemental benefits rate; or
- 2) Supplement the employee's hourly wage by an amount no less than the prevailing supplemental benefits rate; or
- 3) Provide a combination of bona-fide benefits and wage supplements which cost the employer no less than the prevailing supplemental benefits rate in total.

Particular attention should be given to the supplemental benefits requirement. Although in most instances the payment or provision for supplemental benefits is for each hour worked, some classifications require the payment or provision of supplemental benefits for each hour paid. Consequently, some prevailing practices require benefits to be purchased at the overtime, shift differential, Holiday, Saturday, Sunday or other premium time rate.

Benefits are paid for EACH HOUR WORKED unless otherwise noted.

Wasył Kinach, P.E.
Director of Classifications
Bureau of Labor Law

OFFICE OF THE COMPTROLLER, CITY OF NEW YORK
§220 PREVAILING WAGE SCHEDULE

TABLE OF CONTENTS

<u>CLASSIFICATION</u>	<u>PAGE</u>
ASBESTOS HANDLER	5
BLASTER	5
BOILERMAKER.....	7
BRICKLAYER.....	8
CARPENTER - BUILDING COMMERCIAL	9
CARPENTER - HEAVY CONSTRUCTION WORK	10
CEMENT & CONCRETE WORKER.....	11
CEMENT MASON.....	11
CORE DRILLER	12
DERRICKPERSON AND RIGGER	14
DIVER.....	14
DOCKBUILDER - PILE DRIVER.....	15
DRIVER: TRUCK (TEAMSTER)	16
ELECTRICIAN	18
ELECTRICIAN - ALARM TECHNICIAN.....	22
ELECTRICIAN-STREET LIGHTING WORKER	23
ELEVATOR CONSTRUCTOR	24
ELEVATOR REPAIR & MAINTENANCE.....	25
ENGINEER	26
ENGINEER - CITY SURVEYOR AND CONSULTANT.....	31
ENGINEER - FIELD (BUILDING CONSTRUCTION)	32
ENGINEER - FIELD (HEAVY CONSTRUCTION)	33
ENGINEER - FIELD (STEEL ERECTION)	34
ENGINEER - OPERATING	35
FLOOR COVERER.....	42
GLAZIER	43
GLAZIER - REPAIR & MAINTENANCE	44
HEAT AND FROST INSULATOR	45
HOUSE WRECKER	46
IRON WORKER - ORNAMENTAL.....	47
IRON WORKER - STRUCTURAL.....	48
LABORER	48
LANDSCAPING	49
MARBLE MECHANIC.....	51
MASON TENDER	52

**OFFICE OF THE COMPTROLLER, CITY OF NEW YORK
§220 PREVAILING WAGE SCHEDULE**

MASON TENDER (INTERIOR DEMOLITION WORKER).....	53
METALLIC LATHER.....	54
MILLWRIGHT	55
MOSAIC MECHANIC.....	56
PAINTER	57
PAINTER - SIGN.....	57
PAINTER - STRIPER.....	58
PAINTER - STRUCTURAL STEEL.....	59
PAPERHANGER	60
PAVER AND ROADBUILDER	61
PLASTERER	63
PLASTERER - TENDER.....	63
PLUMBER	64
PLUMBER (MECHANICAL EQUIPMENT AND SERVICE).....	65
PLUMBER (RESIDENTIAL RATES FOR 1, 2 AND 3 FAMILY HOME CONSTRUCTION).....	66
PLUMBER: PUMP & TANK.....	67
POINTER - WATERPROOFER, CAULKER MECHANIC (EXTERIOR BUILDING RENOVATION).....	67
ROOFER.....	68
SANDBLASTER - STEAMBLASTER	69
SHEET METAL WORKER.....	70
SHEET METAL WORKER - SPECIALTY	71
SHIPYARD WORKER.....	72
SIGN ERECTOR.....	73
STEAMFITTER	74
STEAMFITTER - REFRIGERATION AND AIR CONDITIONER	75
STONE MASON - SETTER.....	77
TAPER.....	78
TELECOMMUNICATION WORKER	79
TILE FINISHER.....	80
TILE LAYER - SETTER	80
TIMBERPERSON	81
TUNNEL WORKER	82
WELDER.....	84

OFFICE OF THE COMPTROLLER, CITY OF NEW YORK
§220 PREVAILING WAGE SCHEDULE

ASBESTOS HANDLER

(Hazardous Material; Disturbs, removes, encapsulates, repairs, or encloses friable asbestos material)

Asbestos Handler

Effective Period: 7/1/2014 - 6/30/2015

Wage Rate per Hour: \$36.00

Supplemental Benefit Rate per Hour: \$15.45

Overtime

Time and one half the regular rate after an 8 hour day.

Time and one half the regular rate for Sunday.

Time and one half the regular hourly rate after 40 hours in any work week.

Overtime Holidays

Time and one half the regular rate for work on the following holiday(s).

New Year's Day

Good Friday

Memorial Day

Independence Day

Labor Day

Thanksgiving Day

Christmas Day

Easter

Paid Holidays

None

(Local #78 and Local #12A)

BLASTER

Blaster

Effective Period: 7/1/2014 - 6/30/2015

Wage Rate per Hour: \$45.70

Supplemental Benefit Rate per Hour: \$39.69

Blaster (Hydraulic)

Effective Period: 7/1/2014 - 6/30/2015

Wage Rate per Hour: \$46.49

Supplemental Benefit Rate per Hour: \$39.69

OFFICE OF THE COMPTROLLER, CITY OF NEW YORK
§220 PREVAILING WAGE SCHEDULE

Blaster - Trac Drill Hydraulic

Effective Period: 7/1/2014 - 6/30/2015
Wage Rate per Hour: \$41.20
Supplemental Benefit Rate per Hour: \$39.69

Blaster - Wagon: Air Trac: Quarry Bar: Drillrunners

Effective Period: 7/1/2014 - 6/30/2015
Wage Rate per Hour: \$40.44
Supplemental Benefit Rate per Hour: \$39.69

Blaster - Operators of Jack Hammers

Chippers: Spaders: Concrete Breakers: and all other pneumatic tools of like usage: Walk Behind Self Propelled Hydraulic Asphalt and Concrete Breakers: Hydro (Water) Demolition

Effective Period: 7/1/2014 - 6/30/2015
Wage Rate per Hour: \$39.43
Supplemental Benefit Rate per Hour: \$39.69

Blaster - Powder Carriers

Effective Period: 7/1/2014 - 6/30/2015
Wage Rate per Hour: \$35.66
Supplemental Benefit Rate per Hour: \$39.69

Blaster - Hydraulic Trac Drill Chuck Tender

Effective Period: 7/1/2014 - 6/30/2015
Wage Rate per Hour: \$34.42
Supplemental Benefit Rate per Hour: \$39.69

Blaster - Chuck Tender & Nipper

Effective Period: 7/1/2014 - 6/30/2015
Wage Rate per Hour: \$33.69
Supplemental Benefit Rate per Hour: \$39.69

Blaster - Magazine Keepers: (Watch Person)

Effective Period: 7/1/2014 - 6/30/2015
Wage Rate per Hour: \$20.30
Supplemental Benefit Rate per Hour: \$39.69

Overtime Description

Magazine Keepers:

OFFICE OF THE COMPTROLLER, CITY OF NEW YORK
§220 PREVAILING WAGE SCHEDULE

Time and one half for work performed in excess of forty (40) hours per week and for work performed on Saturdays, Sundays and Holidays.

All Other Employees:

Time and one-half for the first eight hours of work on Saturday and for Make-up Time. Double time for all hours over eight Monday through Friday (except make-up hours) and for all hours worked on Sunday and Holidays.

Overtime

Double time the regular rate after an 8 hour day.
Time and one half the regular rate for Saturday.
Double time the regular rate for Sunday.

Overtime Holidays

Double time the regular rate for work on the following holiday(s).

New Year's Day
Memorial Day
Independence Day
Labor Day
Columbus Day
Presidential Election Day
Thanksgiving Day
Christmas Day

Paid Holidays

None

Shift Rates

A single shift shall be 8 hours plus an unpaid lunch, starting at 8:00 A.M (or between 6:00 A.M. and 10:00 A.M. on weekdays). When two (2) shifts are employed, each shift shall be 8 hours plus ½ hour unpaid lunch. When three (3) shifts are employed, each shift will work seven and one-half (7 ½) hours, but will be paid for eight (8) hours, since only one-half (½) hour is allowed for mealtime. When two (2) or more shifts are employed, single time will be paid for each shift. The first 8 hours of any and all work performed Monday through Friday inclusive of any off-shift shall be at the single time rate.

(Local #29)

BOILERMAKER

Boilermaker

Effective Period: 7/1/2014 - 6/30/2015

Wage Rate per Hour: \$50.45

Supplemental Benefit Rate per Hour: \$41.31

Supplemental Note: For time and one half overtime - \$61.37; For double overtime - \$81.43.

Overtime Description

For Repair and Maintenance work:

Time and one half the regular rate after an 8 hour day.
Time and one half the regular rate for Saturday.

OFFICE OF THE COMPTROLLER, CITY OF NEW YORK
§220 PREVAILING WAGE SCHEDULE

Double time the regular rate for Sunday.
For New Construction work:
Double time the regular rate after an 8 hour day.
Double time the regular time rate for Saturday.
Double time the regular rate for Sunday.

Overtime Holidays

Double time the regular rate for work on the following holiday(s).

New Year's Day
President's Day
Memorial Day
Independence Day
Columbus Day
Election Day
Veteran's Day
Thanksgiving Day
Christmas Day

Quadruple time the regular rate for work on the following holiday(s).

Labor Day

Paid Holidays

Good Friday
Day after Thanksgiving
Day before Christmas
Day before New Year's Day

Shift Rates

When shifts are required, the first shift shall work eight (8) hours at the regular straight-time hourly rate. The second shift shall work seven and one-half (7 ½) hours and receive eight hours at the regular straight time hourly rate plus twenty-five cents (\$0.25) per hour. The third shift shall work seven (7) hours and receive eight hours at the regular straight time hourly rate plus fifty cents (\$0.50) per hour. A thirty (30) minute lunch period shall not be considered as time worked. Work in excess of the above shall be paid overtime at the appropriate new construction work or repair work overtime wage and supplemental benefit hourly rate.

(Local #5)

BRICKLAYER

Bricklayer

Effective Period: 7/1/2014 - 6/30/2015

Wage Rate per Hour: \$47.78

Supplemental Benefit Rate per Hour: \$28.03

Overtime

Time and one half the regular rate after a 7 hour day.
Time and one half the regular rate for Saturday.
Double time the regular rate for Sunday.

OFFICE OF THE COMPTROLLER, CITY OF NEW YORK
§220 PREVAILING WAGE SCHEDULE

Saturday may be used as a make-up day at straight time when a day is lost during that week to inclement weather.

Overtime Holidays

Double time the regular rate for work on the following holiday(s).

New Year's Day
Memorial Day
Independence Day
Labor Day
Thanksgiving Day
Christmas Day

Paid Holidays

None

Shift Rates

Overtime rates to be paid outside the regular scheduled work day.

(Bricklayer District Council)

CARPENTER - BUILDING COMMERCIAL

Building Commercial

Effective Period: 7/1/2014 - 6/30/2015

Wage Rate per Hour: \$49.88

Supplemental Benefit Rate per Hour: \$44.10

Overtime

Time and one half the regular rate after an 8 hour day.

Time and one half the regular rate for Saturday.

Double time the regular rate for Sunday.

Saturday may be used as a make-up day at straight time when a day is lost during that week to inclement weather.

Overtime Holidays

Double time the regular rate for work on the following holiday(s).

New Year's Day
Washington's Birthday
Memorial Day
Independence Day
Labor Day
Columbus Day
Presidential Election Day
Thanksgiving Day
Day after Thanksgiving
Christmas Day

OFFICE OF THE COMPTROLLER, CITY OF NEW YORK
§220 PREVAILING WAGE SCHEDULE

Paid Holidays

None

Shift Rates

The second shift will receive one hour at the double time rate of pay for the last hour of the shift; eight hours pay for seven hours of work, nine hours pay for eight hours of work. There must be a first shift in order to work a second shift.

(Carpenters District Council)

CARPENTER - HEAVY CONSTRUCTION WORK
(Construction of Engineering Structures and Building Foundations)

Heavy Construction Work

Effective Period: 7/1/2014 - 6/30/2015

Wage Rate per Hour: \$48.35

Supplemental Benefit Rate per Hour: \$46.12

Overtime

Time and one half the regular rate after an 8 hour day.

Time and one half the regular rate for Saturday.

Double time the regular rate for Sunday.

Saturday may be used as a make-up day at straight time when a day is lost during that week to inclement weather.

Overtime Holidays

Double time the regular rate for work on the following holiday(s).

New Year's Day

President's Day

Memorial Day

Independence Day

Labor Day

Columbus Day

Presidential Election Day

Thanksgiving Day

Christmas Day

Paid Holidays

None

Shift Rates

Off shift work commencing between 5:00 P.M. and 11:00 P.M. shall work eight and one half hours allowing for one half hour for lunch. The wage rate shall be 113% of the straight time hourly wage rate.

OFFICE OF THE COMPTROLLER, CITY OF NEW YORK
§220 PREVAILING WAGE SCHEDULE

(Carpenters District Council)

CEMENT & CONCRETE WORKER

Cement & Concrete Worker

Effective Period: 7/1/2014 - 6/30/2015

Wage Rate per Hour: **\$42.38**

Supplemental Benefit Rate per Hour: **\$26.17**

Supplemental Note: **\$28.92** on Saturdays; **\$31.67** on Sundays & Holidays

Overtime Description

Time and one half the regular rate after 7 hour day (time and one half the regular rate after an 8 hour day when working with Dockbuilders on pile cap forms and for work below street level to the top of the foundation wall, not to exceed 2 feet or 3 feet above the sidewalk-brick shelf, when working on the foundation and structure.)

Overtime

Time and one half the regular rate for Saturday.

Double time the regular rate for Sunday.

Overtime Holidays

Double time the regular rate for work on the following holiday(s).

New Year's Day

President's Day

Good Friday

Memorial Day

Independence Day

Labor Day

Columbus Day

Presidential Election Day

Thanksgiving Day

Christmas Day

Paid Holidays

1/2 day before Christmas Day

1/2 day before New Year's Day

Shift Rates

On shift work extending over a twenty-four hour period, all shifts are paid at straight time.

(Cement Concrete Workers District Council)

CEMENT MASON

Cement Mason

OFFICE OF THE COMPTROLLER, CITY OF NEW YORK
§220 PREVAILING WAGE SCHEDULE

Effective Period: 7/1/2014 - 6/30/2015

Wage Rate per Hour: **\$38.88**

Supplemental Benefit Rate per Hour: **\$39.80**

Supplemental Note: For time and one half overtime - \$49.05; For double overtime - \$58.30

Overtime Description

Time and one-half the regular rate after an 8 hour day, double time the regular rate after 10 hours. Time and one-half the regular rate on Saturday, double time the regular rate after 10 hours. Double time the regular rate on Sunday.

Overtime Holidays

Double time the regular rate for work on the following holiday(s).

New Year's Day

President's Day

Good Friday

Memorial Day

Independence Day

Labor Day

Columbus Day

Presidential Election Day

Thanksgiving Day

Christmas Day

Paid Holidays

Any worker who reports to work on Christmas Eve or New Year's Eve pursuant to his employer's instruction shall be entitled to three (3) hours afternoon pay without working.

Shift Rates

For an off shift day, (work at times other than the regular 7:00 A.M. to 3:30 P.M. work day) a cement mason shall be paid at the regular hourly rate plus a 25% per hour differential. Four Days a week at Ten (10)hour day.

(Local #780)

CORE DRILLER

Core Driller

Effective Period: 7/1/2014 - 6/30/2015

Wage Rate per Hour: **\$35.71**

Supplemental Benefit Rate per Hour: **\$21.69**

Core Driller Helper

Effective Period: 7/1/2014 - 6/30/2015

Wage Rate per Hour: **\$28.60**

Supplemental Benefit Rate per Hour: **\$21.69**

OFFICE OF THE COMPTROLLER, CITY OF NEW YORK
§220 PREVAILING WAGE SCHEDULE

Core Driller Helper(Third year in the industry)

Effective Period: 7/1/2014 - 6/30/2015

Wage Rate per Hour: \$25.74

Supplemental Benefit Rate per Hour: \$21.69

Core Driller Helper (Second year in the industry)

Effective Period: 7/1/2014 - 6/30/2015

Wage Rate per Hour: \$22.88

Supplemental Benefit Rate per Hour: \$21.69

Core Driller Helper (First year in the industry)

Effective Period: 7/1/2014 - 6/30/2015

Wage Rate per Hour: \$20.02

Supplemental Benefit Rate per Hour: \$21.69

Overtime Description

Time and one half the regular rate for work on a holiday plus Holiday pay when worked.

Overtime

Time and one half the regular rate after an 8 hour day.

Time and one half the regular rate for Saturday.

Double time the regular rate for Sunday.

Time and one half the regular rate for work on the following holiday(s).

Paid Holidays

New Year's Day

Memorial Day

Independence Day

Labor Day

Thanksgiving Day

Christmas Day

Shift Rates

The shift day shall be the continuous eight and one-half (8½) hours from 6:00 A.M. to 2:30 P.M. and from 2:30 P.M. to 11:00 P.M., including one-half (½) hour of employees regular rate of pay for lunch. When two (2) or more shifts are employed, single time shall be paid for each shift, but those employees employed on a shift other than from 8:00 A.M. to 5:00 P.M. shall, in addition, receive seventy-five cents (\$0.75) per hour differential for each hour worked. When three (3) shifts are needed, each shift shall work seven and one-half (7 ½) hours paid for eight (8) hours of labor and be permitted one-half (½) hour for mealtime.

(Carpenters District Council)

OFFICE OF THE COMPTROLLER, CITY OF NEW YORK
§220 PREVAILING WAGE SCHEDULE

DERRICKPERSON AND RIGGER

Derrick Person & Rigger

Effective Period: 7/1/2014 - 6/30/2015

Wage Rate per Hour: \$42.25

Supplemental Benefit Rate per Hour: \$47.81

Supplemental Note: The above supplemental rate applies for work performed in Manhattan, Bronx, Brooklyn and Queens. \$49.23 - For work performed in Staten Island.

Overtime Description

The first two hours of overtime on weekdays and the first seven hours of work on Saturdays are paid at time and one half for wages and supplemental benefits. All additional overtimes is paid at double time for wages and supplemental benefits. Deduct \$1.42 from the Staten Island hourly benefits rate before computing overtime.

Overtime

Double time the regular rate for Sunday.

Overtime Holidays

Double time the regular rate for work on the following holiday(s).

New Year's Day

Washington's Birthday

Good Friday

Memorial Day

Independence Day

Labor Day

Thanksgiving Day

Christmas Day

Paid Holidays

1/2 day on Christmas Eve if work is performed in the A.M.

(Local #197)

DIVER

Diver (Marine)

Effective Period: 7/1/2014 - 6/30/2015

Wage Rate per Hour: \$61.30

Supplemental Benefit Rate per Hour: \$46.12

Diver Tender (Marine)

Effective Period: 7/1/2014 - 6/30/2015

Wage Rate per Hour: \$43.45

Supplemental Benefit Rate per Hour: \$46.12

OFFICE OF THE COMPTROLLER, CITY OF NEW YORK
§220 PREVAILING WAGE SCHEDULE

Overtime

Time and one half the regular rate after an 8 hour day.

Time and one half the regular rate for Saturday.

Double time the regular rate for Sunday.

Saturday may be used as a make-up day at straight time when a day is lost during that week to inclement weather.

Overtime Holidays

Double time the regular rate for work on the following holiday(s).

New Year's Day

President's Day

Memorial Day

Independence Day

Labor Day

Columbus Day

Presidential Election Day

Thanksgiving Day

Christmas Day

Paid Holidays

None

Shift Rates

When three shifts are utilized each shift shall work seven and one half-hours (7 1/2 hours) and paid for 8 hours, allowing for one half hour for lunch.

(Carpenters District Council)

DOCKBUILDER - PILE DRIVER

Dockbuilder - Pile Driver

Effective Period: 7/1/2014 - 6/30/2015

Wage Rate per Hour: \$48.35

Supplemental Benefit Rate per Hour: \$46.12

Overtime

Time and one half the regular rate after an 8 hour day.

Time and one half the regular rate for Saturday.

Double time the regular rate for Sunday.

Saturday may be used as a make-up day at straight time when a day is lost during that week to inclement weather.

Overtime Holidays

Double time the regular rate for work on the following holiday(s).

New Year's Day

President's Day

OFFICE OF THE COMPTROLLER, CITY OF NEW YORK
§220 PREVAILING WAGE SCHEDULE

Memorial Day
Independence Day
Labor Day
Columbus Day
Presidential Election Day
Thanksgiving Day
Christmas Day

Paid Holidays

None

Shift Rates

Off shift work commencing between 5:00 P.M. and 11:00 P.M. shall work eight and one half hours allowing for one half hour for lunch. The wage rate shall be 113% of the straight time hourly wage rate.

(Carpenters District Council)

DRIVER: TRUCK (TEAMSTER)

Driver - Dump Truck

Effective Period: 7/1/2014 - 6/30/2015

Wage Rate per Hour: \$38.86

Supplemental Benefit Rate per Hour: \$40.44

Supplemental Note: Over 40 hours worked: time and one half rate \$16.94, double time rate \$22.59

Driver - Tractor Trailer

Effective Period: 7/1/2014 - 6/30/2015

Wage Rate per Hour: \$38.88

Supplemental Benefit Rate per Hour: \$41.70

Supplemental Note: For over 40 hours worked: at time and one half - \$15.90; at double time - \$21.21

Driver - Euclid & Turnapull Operator

Effective Period: 7/1/2014 - 6/30/2015

Wage Rate per Hour: \$39.44

Supplemental Benefit Rate per Hour: \$41.70

Supplemental Note: Over 40 hours worked: time and one half rate \$15.90, double time rate \$21.21

Overtime Description

For Paid Holidays: Holiday pay for all holidays shall be prorated based two hours per day for each day worked in the holiday week, not to exceed 8 hours of holiday pay. For Thanksgiving week, the prorated share shall be 5 1/3 hours of holiday pay for each day worked in Thanksgiving week.

Overtime

Time and one half the regular rate after an 8 hour day.

OFFICE OF THE COMPTROLLER, CITY OF NEW YORK
§220 PREVAILING WAGE SCHEDULE

Time and one half the regular rate for Saturday.
Double time the regular rate for Sunday.

Overtime Holidays

Double time the regular rate for work on the following holiday(s).

New Year's Day
President's Day
Memorial Day
Independence Day
Labor Day
Columbus Day
Veteran's Day
Thanksgiving Day
Day after Thanksgiving
Christmas Day

Paid Holidays

New Year's Day
President's Day
Memorial Day
Independence Day
Labor Day
Columbus Day
Veteran's Day
Thanksgiving Day
Day after Thanksgiving
Christmas Day

Driver Redi-Mix (Sand & Gravel)

Effective Period: 7/1/2014 - 6/30/2015

Wage Rate per Hour: \$36.05

Supplemental Benefit Rate per Hour: \$38.60

Supplemental Note: Over 40 hours worked: time and one half rate \$13.53, double time rate \$18.04

Overtime Description

For Paid Holidays: Employees working two (2) days in the calendar week in which the holiday falls are to paid for these holidays, provided they shape each remaining workday during that calendar week.

Overtime

Time and one half the regular rate after an 8 hour day.

Time and one half the regular rate for Saturday.

Double time the regular rate for Sunday.

Overtime Holidays

Double time the regular rate for work on the following holiday(s).

President's Day
Columbus Day
Veteran's Day

OFFICE OF THE COMPTROLLER, CITY OF NEW YORK
§220 PREVAILING WAGE SCHEDULE

Triple time the regular rate for work on the following holiday(s).

New Year's Day
Memorial Day
Independence Day
Labor Day
Thanksgiving Day
Christmas Day

Paid Holidays

New Year's Day
President's Day
Memorial Day
Independence Day
Labor Day
Columbus Day
Election Day
Thanksgiving Day
Christmas Day

(Local #282)

ELECTRICIAN

(Including all low voltage cabling carrying data; video; and voice in combination with data and or video.)

Electrician "A" (Regular Day)

Effective Period: 7/1/2014 - 5/12/2015

Wage Rate per Hour: \$53.00

Supplemental Benefit Rate per Hour: \$47.54

Effective Period: 5/13/2015 - 6/30/2015

Wage Rate per Hour: \$54.00

Supplemental Benefit Rate per Hour: \$50.03

Electrician "A" (Regular Day Overtime)

Effective Period: 7/1/2014 - 5/12/2015

Wage Rate per Hour: \$79.50

Supplemental Benefit Rate per Hour: \$50.86

Effective Period: 5/13/2015 - 6/30/2015

Wage Rate per Hour: \$81.00

Supplemental Benefit Rate per Hour: \$53.41

OFFICE OF THE COMPTROLLER, CITY OF NEW YORK
§220 PREVAILING WAGE SCHEDULE

Electrician "A" (Day Shift)

Effective Period: 7/1/2014 - 5/12/2015
Wage Rate per Hour: **\$53.00**
Supplemental Benefit Rate per Hour: **\$47.54**

Effective Period: 5/13/2015 - 6/30/2015
Wage Rate per Hour: **\$54.00**
Supplemental Benefit Rate per Hour: **\$50.03**

Electrician "A" (Day Shift Overtime After 8 hours)

Effective Period: 7/1/2014 - 5/12/2015
Wage Rate per Hour: **\$79.50**
Supplemental Benefit Rate per Hour: **\$50.86**

Effective Period: 5/13/2015 - 6/30/2015
Wage Rate per Hour: **\$81.00**
Supplemental Benefit Rate per Hour: **\$53.41**

Electrician "A" (Swing Shift)

Effective Period: 7/1/2014 - 5/12/2015
Wage Rate per Hour: **\$62.19**
Supplemental Benefit Rate per Hour: **\$54.07**

Effective Period: 5/13/2015 - 6/30/2015
Wage Rate per Hour: **\$63.36**
Supplemental Benefit Rate per Hour: **\$56.94**

Electrician "A" (Swing Shift Overtime After 7.5 hours)

Effective Period: 7/1/2014 - 5/12/2015
Wage Rate per Hour: **\$93.29**
Supplemental Benefit Rate per Hour: **\$57.97**

Effective Period: 5/13/2015 - 6/30/2015
Wage Rate per Hour: **\$95.04**
Supplemental Benefit Rate per Hour: **\$60.91**

Electrician "A" (Graveyard Shift)

Effective Period: 7/1/2014 - 5/12/2015
Wage Rate per Hour: **\$69.66**
Supplemental Benefit Rate per Hour: **\$59.59**

Effective Period: 5/13/2015 - 6/30/2015
Wage Rate per Hour: **\$70.97**
Supplemental Benefit Rate per Hour: **\$62.78**

OFFICE OF THE COMPTROLLER, CITY OF NEW YORK
§220 PREVAILING WAGE SCHEDULE

Electrician "A" (Graveyard Shift Overtime After 7 hours)

Effective Period: 7/1/2014 - 5/12/2015

Wage Rate per Hour: \$104.49

Supplemental Benefit Rate per Hour: \$63.96

Effective Period: 5/13/2015 - 6/30/2015

Wage Rate per Hour: \$106.46

Supplemental Benefit Rate per Hour: \$67.23

Overtime

Time and one half the regular rate after a 7 hour day.

Time and one half the regular rate for Saturday.

Time and one half the regular rate for Sunday.

Overtime Holidays

Time and one half the regular rate for work on a holiday.

New Year's Day

Martin Luther King Jr. Day

President's Day

Memorial Day

Independence Day

Labor Day

Columbus Day

Veteran's Day

Thanksgiving Day

Day after Thanksgiving

Christmas Day

Paid Holidays

None

Shift Rates

When so elected by the Employer, one or more shifts of at least five days duration may be scheduled as follows:

Day Shift: 8:00 am to 4:30 pm, Swing Shift 4:30 pm to 12:30 am, Graveyard Shift: 12:30 am to 8:00 am.

For multiple shifts of temporary light and/or power, the temporary light and/or power employee shall be paid for 8 hours at the straight time rate. For three or less workers performing 8 hours temporary light and/or power the supplemental benefit rate is \$23.63. Effective 5/13/2015 - \$24.39.

Electrician "M" (First 8 hours)

"M" rated work shall be defined as jobbing: electrical work of limited duration and scope, also consisting of repairs and/or replacement of electrical and tele-data equipment. Includes all work necessary to retrofit, service, maintain and repair all kinds of lighting fixtures and local lighting controls and washing and cleaning of foregoing fixtures.

OFFICE OF THE COMPTROLLER, CITY OF NEW YORK
§220 PREVAILING WAGE SCHEDULE

Effective Period: 7/1/2014 - 5/12/2015

Wage Rate per Hour: **\$27.00**

Supplemental Benefit Rate per Hour: **\$20.32**

First and Second Year "M" Wage Rate Per Hour - Hired on or before 5/10/07: **\$26.30**

First and Second Year "M" Supplemental Rate- Hired on or before 5/10/07: **\$19.96**

First and Second Year "M" Wage Rate Per Hour - Hired after 5/10/07: **\$22.50**

First and Second Year "M" Supplemental Rate- Hired after 5/10/07: **\$18.06**

Effective Period: 5/13/2015 - 6/30/2015

Wage Rate per Hour: **\$27.50**

Supplemental Benefit Rate per Hour: **\$20.82**

First and Second Year "M" Wage Rate Per Hour - Hired on or before 5/10/07: **\$26.80**

First and Second Year "M" Supplemental Rate- Hired on or before 5/10/07: **\$20.46**

First and Second Year "M" Wage Rate Per Hour - Hired after 5/10/07: **\$23.00**

First and Second Year "M" Supplemental Rate- Hired after 5/10/07: **\$18.56**

Electrician "M" (Overtime After First 8 hours)

"M" rated work shall be defined as jobbing: electrical work of limited duration and scope, also consisting of repairs and/or replacement of electrical and tele-data equipment. Includes all work necessary to retrofit, service, maintain and repair all kinds of lighting fixtures and local lighting controls and washing and cleaning of foregoing fixtures.

Effective Period: 7/1/2014 - 5/12/2015

Wage Rate per Hour: **\$40.50**

Supplemental Benefit Rate per Hour: **\$22.01**

First and Second Year "M" Wage Rate Per Hour - Hired on or before 5/10/07: **\$39.45**

First and Second Year "M" Supplemental Rate- Hired on or before 5/10/07: **\$21.61**

First and Second Year "M" Wage Rate Per Hour - Hired after 5/10/07: **\$33.75**

First and Second Year "M" Supplemental Rate- Hired after 5/10/07: **\$19.47**

Effective Period: 5/13/2015 - 6/30/2015

Wage Rate per Hour: **\$41.25**

Supplemental Benefit Rate per Hour: **\$22.54**

First and Second Year "M" Wage Rate Per Hour - Hired on or before 5/10/07: **\$40.20**

First and Second Year "M" Supplemental Rate- Hired on or before 5/10/07: **\$22.14**

First and Second Year "M" Wage Rate Per Hour - Hired after 5/10/07: **\$34.50**

First and Second Year "M" Supplemental Rate- Hired after 5/10/07: **\$20.00**

Overtime

Time and one half the regular rate after an 8 hour day.

Time and one half the regular rate for Saturday.

Time and one half the regular rate for Sunday.

Overtime Holidays

Time and one half the regular rate for work on the following holiday(s).

New Year's Day

Martin Luther King Jr. Day

President's Day

Memorial Day

Independence Day

Labor Day

OFFICE OF THE COMPTROLLER, CITY OF NEW YORK
§220 PREVAILING WAGE SCHEDULE

Columbus Day
Veteran's Day
Thanksgiving Day
Day after Thanksgiving
Christmas Day

Paid Holidays

None

(Local #3)

ELECTRICIAN - ALARM TECHNICIAN

(Scope of Work - Inspect, test, repair, and replace defective, malfunctioning, or broken devices, components and controls of Fire, Burglar and Security Systems)

Alarm Technician

Effective Period: 7/1/2014 - 6/30/2015

Wage Rate per Hour: **\$30.40**

Supplemental Benefit Rate per Hour: **\$13.90**

Supplemental Note: \$12.40 only after 8 hours worked in a day

Overtime Description

Time and one half the regular rate for work on the following holidays: Columbus Day, Veterans Day, Day after Thanksgiving.

Double time the regular rate for work on the following holidays: New Year's day, Martin Luther King Jr. Day, President's Day, Memorial Day, Independence Day, Labor Day, Thanksgiving Day, Christmas Day.

Overtime

Time and one half the regular rate after an 8 hour day.

Time and one half the regular rate for Saturday.

Double time the regular rate for Sunday.

Paid Holidays

New Year's Day
Martin Luther King Jr. Day
President's Day
Memorial Day
Independence Day
Labor Day
Columbus Day
Veteran's Day
Thanksgiving Day
Day after Thanksgiving
Christmas Day

OFFICE OF THE COMPTROLLER, CITY OF NEW YORK
§220 PREVAILING WAGE SCHEDULE

Shift Rates

Night Differential is based upon a ten percent (10%) differential between the hours of 4:00 P.M. and 12:30 A.M. and a fifteen percent (15%) differential for the hours 12:00 A.M. to 8:00 A.M.

Vacation

At least 1 year of employment.....ten (10) days
5 years or more of employment.....fifteen (15) days
10 years of employment.....twenty (20) days
Plus one Personal Day per year

Sick Days:

One day per Year

(Local #3)

ELECTRICIAN-STREET LIGHTING WORKER

Electrician - Electro Pole Electrician

Effective Period: 7/1/2014 - 5/19/2015
Wage Rate per Hour: \$53.00
Supplemental Benefit Rate per Hour: \$49.34

Effective Period: 5/20/2015 - 6/30/2015
Wage Rate per Hour: \$54.00
Supplemental Benefit Rate per Hour: \$51.86

Electrician - Electro Pole Foundation Installer

Effective Period: 7/1/2014 - 5/19/2015
Wage Rate per Hour: \$40.18
Supplemental Benefit Rate per Hour: \$37.73

Effective Period: 5/20/2015 - 6/30/2015
Wage Rate per Hour: \$40.93
Supplemental Benefit Rate per Hour: \$39.46

Electrician - Electro Pole Maintainer

Effective Period: 7/1/2014 - 5/19/2015
Wage Rate per Hour: \$34.40
Supplemental Benefit Rate per Hour: \$34.00

Effective Period: 5/20/2015 - 6/30/2015
Wage Rate per Hour: \$35.05
Supplemental Benefit Rate per Hour: \$35.51

OFFICE OF THE COMPTROLLER, CITY OF NEW YORK
§220 PREVAILING WAGE SCHEDULE

Overtime Description

Electrician - Electro Pole Electrician: Time and one half the regular rate after a 7 hour day and after 5 consecutive days worked per week.

Electrician - Electro Pole Foundation Installer: Time and one half the regular rate after 8 hours within a 24 hour period and Saturday and Sunday.

Electrician - Electro Pole Maintainer: Time and one half the regular rate after a 7 hour day and after 5 consecutive days worked per week. Saturdays and Sundays may be used as a make-up day at straight time when a day is lost during the week to inclement weather.

Overtime Holidays

Time and one half the regular rate for work on the following holiday(s).

New Year's Day

Martin Luther King Jr. Day

President's Day

Memorial Day

Independence Day

Labor Day

Columbus Day

Veteran's Day

Thanksgiving Day

Day after Thanksgiving

Christmas Day

Paid Holidays

None

(Local #3)

ELEVATOR CONSTRUCTOR

Elevator Constructor

Effective Period: 7/1/2014 - 3/16/2015

Wage Rate per Hour: \$58.23

Supplemental Benefit Rate per Hour: \$29.47

Effective Period: 3/17/2015 - 6/30/2015

Wage Rate per Hour: \$59.55

Supplemental Benefit Rate per Hour: \$31.07

Overtime Description

For New Construction: work performed after 7 or 8 hour day, Saturday, Sunday or between 4:30pm and 7:00am shall be paid at double time rate.

Existing buildings: work performed after an 8 hour day, Saturday, Sunday or between 5:30pm and 7:00 am shall be paid time and one half.

Overtime

OFFICE OF THE COMPTROLLER, CITY OF NEW YORK
§220 PREVAILING WAGE SCHEDULE

Double time the regular rate for work on the following holiday(s).

Paid Holidays

New Year's Day
President's Day
Good Friday
Memorial Day
Independence Day
Labor Day
Columbus Day
Veteran's Day
Thanksgiving Day
Day after Thanksgiving
Christmas Day

Vacation

Employer contributes 8% of regular basic hourly rate as vacation pay for employees with more than 15 years of service, and 6% for employees with 5 to 15 years of service, and 4% for employees with less than 5 years of service.

(Local #1)

ELEVATOR REPAIR & MAINTENANCE

Elevator Service/Modernization Mechanic

Effective Period: 7/1/2014 - 3/16/2015

Wage Rate per Hour: \$46.00

Supplemental Benefit Rate per Hour: \$28.78

Effective Period: 3/17/2015 - 6/30/2015

Wage Rate per Hour: \$46.92

Supplemental Benefit Rate per Hour: \$30.91

Overtime Description

For Service Work: Double time - all work performed on Sundays, Holidays, and between midnight and 7:00am.

Overtime

Time and one half the regular rate after an 8 hour day.

Time and one half the regular rate for Saturday.

Time and one half the regular rate for Sunday.

Time and one half the regular rate for work on a holiday plus the day's pay.

Paid Holidays

New Year's Day
President's Day
Good Friday
Memorial Day
Independence Day

OFFICE OF THE COMPTROLLER, CITY OF NEW YORK
§220 PREVAILING WAGE SCHEDULE

Labor Day
Columbus Day
Veteran's Day
Thanksgiving Day
Day after Thanksgiving
Christmas Day

Shift Rates

For Modernization Work (4pm to 12:30am) - regularly hourly rate plus a (15%) fifteen percent differential.

Vacation

Employer contributes 8% of regular basic hourly rate as vacation pay for employees with more than 15 years of service, and 6% for employees with 5 to 15 years of service, and 4% for employees with less than 5 years of service.

(Local #1)

ENGINEER

Engineer - Heavy Construction Operating Engineer I

Cherry pickers 20 tons and over and Loaders (rubber tired and/or tractor type with a manufacturer's minimum rated capacity of six cubic yards and over).

Effective Period: 7/1/2014 - 6/30/2015

Wage Rate per Hour: \$61.05

Supplemental Benefit Rate per Hour: \$31.93

Supplemental Note: \$57.46 on overtime

Shift Wage Rate: \$97.68

Engineer - Heavy Construction Operating Engineer II

Backhoes, Basin Machines, Groover, Mechanical Sweepers, Bobcat, Boom Truck, Barrier Transport (Barrier Mover) & machines of similar nature. Operation of Churn Drills and machines of a similar nature, Stetco Silent Hoist and machines of similar nature, Vac-Alls, Meyers Machines, John Beam and machines of a similar nature, Ross Carriers and Travel Lifts and machines of a similar nature, Bulldozers, Scrapers and Turn-a-Pulls: Tugger Hoists (Used exclusively for handling excavated material); Tractors with attachments, Hyster and Roustabout Cranes, Cherry pickers. Austin Western, Grove and machines of a similar nature, Scoopmobiles, Monorails, Conveyors, Trenchers: Loaders-Rubber Tired and Tractor: Barber Greene and Eimco Loaders and Eimco Backhoes; Mighty Midget and similar breakers and Tampers, Curb and Gutter Pavers and Motor Patrol, Motor Graders and all machines of a similar nature. Locomotives 10 Tons or under. Mini-Max, Break-Tech and machines of a similar nature; Milling machines, robotic and demolition machines and machines of a similar nature, shot blaster, skid steer machines and machines of a similar nature including bobcat, pile rig rubber-tired excavator (37,000 lbs. and under), 2 man auger.

Effective Period: 7/1/2014 - 6/30/2015

Wage Rate per Hour: \$59.24

Supplemental Benefit Rate per Hour: \$31.93

Supplemental Note: \$57.46 on overtime

Shift Wage Rate: \$94.78

OFFICE OF THE COMPTROLLER, CITY OF NEW YORK
§220 PREVAILING WAGE SCHEDULE

Engineer - Heavy Construction Operating Engineer III

Minor Equipment such as Tractors, Post Hole Diggers, Ditch Witch (Walk Behind), Road Finishing Machines, Rollers five tons and under, Tugger Hoists, Dual Purpose Trucks, Fork Lifts, and Dempsey Dumpers, Fireperson.

Effective Period: 7/1/2014 - 6/30/2015

Wage Rate per Hour: \$56.22

Supplemental Benefit Rate per Hour: \$31.93

Supplemental Note: \$57.46 on overtime

Shift Wage Rate: \$89.95

Engineer - Heavy Construction Maintenance Engineer I

Installing, Repairing, Maintaining, Dismantling and Manning of all equipment including Steel Cutting, Bending and Heat Sealing Machines, Mechanical Heaters, Grout Pumps, Bentonite Pumps & Plants, Screening Machines, Fusion Coupling Machines, Tunnel Boring Machines Moles and Machines of a similar nature, Power Packs, Mechanical Hydraulic Jacks; all drill rigs including but not limited to Churn, Rotary Caisson, Raised Bore & Drills of a similar nature; Personnel, Inspection & Safety Boats or any boats used to perform functions of same, Mine Hoists, Whirlies, all Climbing Cranes, all Tower Cranes, including but not limited to Truck Mounted and Crawler Type and machines of similar nature; Maintaining Hydraulic Drills and machines of a similar nature; Well Point System-Installation and dismantling; Burning, Welding, all Pumps regardless of size and/or motor power, except River Cofferdam Pumps and Wells Point Pumps; Motorized Buggies (three or more); equipment used in the cleaning and televising of sewers, but not limited to jet-rodder/vacuum truck, vacall/vactor, closed circuit television inspection equipment; high powered water pumps, jet pumps; screed machines and concrete finishing machines of a similar nature; vermeers.

Effective Period: 7/1/2014 - 6/30/2015

Wage Rate per Hour: \$58.97

Supplemental Benefit Rate per Hour: \$31.93

Supplemental Note: \$57.46 on overtime

Shift Wage Rate: \$94.35

Engineer - Heavy Construction Maintenance Engineer II

On Base Mounted Tower Cranes

Effective Period: 7/1/2014 - 6/30/2015

Wage Rate per Hour: \$77.30

Supplemental Benefit Rate per Hour: \$31.93

Supplemental Note: \$57.46 on overtime

Shift Wage Rate: \$123.68

Engineer - Heavy Construction Maintenance Engineer III

On Generators, Light Towers

Effective Period: 7/1/2014 - 6/30/2015

Wage Rate per Hour: \$39.10

Supplemental Benefit Rate per Hour: \$31.93

Supplemental Note: \$57.46 on overtime

OFFICE OF THE COMPTROLLER, CITY OF NEW YORK
§220 PREVAILING WAGE SCHEDULE

Shift Wage Rate: \$62.56

Engineer - Heavy Construction Maintenance Engineer IV

On Pumps and Mixers including mud sucking

Effective Period: 7/1/2014 - 6/30/2015

Wage Rate per Hour: \$40.11

Supplemental Benefit Rate per Hour: \$31.93

Supplemental Note: \$57.46 on overtime

Shift Wage Rate: \$64.18

Engineer - Heavy Construction Oilers I

Gradalls, Cold Planer Grader, Concrete Pumps, Driving Truck Cranes, Driving and Operating Fuel and Grease Trucks.

Effective Period: 7/1/2014 - 6/30/2015

Wage Rate per Hour: \$53.22

Supplemental Benefit Rate per Hour: \$31.93

Supplemental Note: \$57.46 on overtime

Shift Wage Rate: \$85.15

Engineer - Heavy Construction Oilers II

All gasoline, electric, diesel or air operated Shovels, Draglines, Backhoes, Keystones, Pavers, Gunit Machine, Battery of Compressors, Crawler Cranes, two-person Trenching Machines.

Effective Period: 7/1/2014 - 6/30/2015

Wage Rate per Hour: \$36.97

Supplemental Benefit Rate per Hour: \$31.93

Supplemental Note: \$57.46 on overtime

Shift Wage Rate: \$59.15

Engineer - Steel Erection Maintenance Engineers

Derrick, Travelers, Tower, Crawler Tower and Climbing Cranes

Effective Period: 7/1/2014 - 6/30/2015

Wage Rate per Hour: \$57.05

Supplemental Benefit Rate per Hour: \$31.93

Supplemental Note: \$57.46 on overtime

Shift Wage Rate: \$91.28

Engineer - Steel Erection Oiler I

On a Truck Crane

Effective Period: 7/1/2014 - 6/30/2015

Wage Rate per Hour: \$53.43

OFFICE OF THE COMPTROLLER, CITY OF NEW YORK
§220 PREVAILING WAGE SCHEDULE

Supplemental Benefit Rate per Hour: \$31.93
Supplemental Note: \$57.46 on overtime
Shift Wage Rate: \$85.49

Engineer - Steel Erection Oiler II

On a Crawler Crane

Effective Period: 7/1/2014 - 6/30/2015
Wage Rate per Hour: \$40.84
Supplemental Benefit Rate per Hour: \$31.93
Supplemental Note: \$57.46 on overtime
Shift Wage Rate: \$65.34

Overtime Description

On jobs of more than one shift, if the next shift employee fails to report for work through any cause over which the employer has no control, the employee on duty who works the next shift continues to work at the single time rate.

Overtime

Double time the regular rate after an 8 hour day.
Double time the regular time rate for Saturday.
Double time the regular rate for Sunday.
Double time the regular rate for work on the following holiday(s).

Paid Holidays

New Year's Day
Lincoln's Birthday
President's Day
Memorial Day
Independence Day
Labor Day
Columbus Day
Veteran's Day
Thanksgiving Day
Day after Thanksgiving
Christmas Day

Employees must work at least one day in the payroll week in which the holiday occurs to receive the paid holiday

Engineer - Building Work Maintenance Engineers I

Installing, repairing, maintaining, dismantling (of all equipment including: Steel Cutting and Bending Machines, Mechanical Heaters, Mine Hoists, Climbing Cranes, Tower Cranes, Linden Peine, Lorain, Liebherr, Mannes, or machines of a similar nature, Well Point Systems, Deep Well Pumps, Concrete Mixers with loading Device, Concrete Plants, Motor Generators when used for temporary power and lights), skid steer machines of a similar nature including bobcat.

Effective Period: 7/1/2014 - 6/30/2015
Wage Rate per Hour: \$54.04

OFFICE OF THE COMPTROLLER, CITY OF NEW YORK
§220 PREVAILING WAGE SCHEDULE

Supplemental Benefit Rate per Hour: \$31.93
Supplemental Note: \$57.46 on overtime

Engineer - Building Work Maintenance Engineers II

On Pumps, Generators, Mixers and Heaters

Effective Period: 7/1/2014 - 6/30/2015
Wage Rate per Hour: \$42.10
Supplemental Benefit Rate per Hour: \$31.93
Supplemental Note: \$57.46 on overtime

Engineer - Building Work Oilers I

All gasoline, electric, diesel or air operated Gradealls: Concrete Pumps, Overhead Cranes in Power Houses: Their duties shall be to assist the Engineer in oiling, greasing and repairing of all machines; Driving Truck Cranes: Driving and Operating Fuel and Grease Trucks, Cherrypickers (hydraulic cranes) over 70,000 GVW, and machines of a similar nature.

Effective Period: 7/1/2014 - 6/30/2015
Wage Rate per Hour: \$51.40
Supplemental Benefit Rate per Hour: \$31.93
Supplemental Note: \$57.46 on overtime

Engineer - Building Work Oilers II

Oilers on Crawler Cranes, Backhoes, Trenching Machines, Guniting Machines, Compressors (three or more in Battery).

Effective Period: 7/1/2014 - 6/30/2015
Wage Rate per Hour: \$38.31
Supplemental Benefit Rate per Hour: \$31.93
Supplemental Note: \$57.46 on overtime

Overtime Description

On jobs of more than one shift, if an Employee fails to report for work through any cause over which the Employer has no control, the Employee on duty will continue to work at the rate of single time.

Overtime

Double time the regular rate after an 8 hour day.
Double time the regular time rate for Saturday.
Double time the regular rate for Sunday.
Double time the regular rate for work on the following holiday(s).

Paid Holidays

New Year's Day
Lincoln's Birthday
President's Day
Memorial Day
Independence Day
Labor Day

OFFICE OF THE COMPTROLLER, CITY OF NEW YORK
§220 PREVAILING WAGE SCHEDULE

Columbus Day
Veteran's Day
Thanksgiving Day
Christmas Day

Employees must work at least one day in the payroll week in which the holiday occurs to receive the paid holiday

Shift Rates

Off Shift: double time the regular hourly rate.

(Local #15)

ENGINEER - CITY SURVEYOR AND CONSULTANT

Party Chief

Effective Period: 7/1/2014 - 6/30/2015

Wage Rate per Hour: **\$35.55**

Supplemental Benefit Rate per Hour: **\$17.65**

Instrument Person

Effective Period: 7/1/2014 - 6/30/2015

Wage Rate per Hour: **\$29.41**

Supplemental Benefit Rate per Hour: **\$17.65**

Rodperson

Effective Period: 7/1/2014 - 6/30/2015

Wage Rate per Hour: **\$25.54**

Supplemental Benefit Rate per Hour: **\$17.65**

Overtime Description

Overtime Benefit Rate - \$23.63 per hour (time & one half) \$29.95 per hour (double time).

Time and one half the regular rate after an 8 hour day, Time and one half the regular rate for Saturday for the first eight hours worked, Double time the regular time rate for Saturday for work performed in excess of eight hours, Double time the regular rate for Sunday and Double time the regular rate for work on a holiday.

Paid Holidays

New Year's Day
Lincoln's Birthday
President's Day
Memorial Day
Independence Day
Labor Day
Columbus Day
Veteran's Day
Thanksgiving Day
Day after Thanksgiving

OFFICE OF THE COMPTROLLER, CITY OF NEW YORK
§220 PREVAILING WAGE SCHEDULE

Christmas Day

Employees must work at least one day in the payroll week in which the holiday occurs to receive the paid holiday

(Operating Engineer Local #15-D)

ENGINEER - FIELD (BUILDING CONSTRUCTION)
(Construction of Building Projects, Concrete Superstructures, etc.)

Field Engineer - BC Party Chief

Effective Period: 7/1/2014 - 6/30/2015

Wage Rate per Hour: **\$55.40**

Supplemental Benefit Rate per Hour: **\$30.62**

Supplemental Note: Overtime Benefit Rate - \$42.73 per hour (time & one half) \$54.84 per hour (double time).

Field Engineer - BC Instrument Person

Effective Period: 7/1/2014 - 6/30/2015

Wage Rate per Hour: **\$43.10**

Supplemental Benefit Rate per Hour: **\$30.62**

Supplemental Note: Overtime Benefit Rate - \$42.73 per hour (time & one half) \$54.84 per hour (double time).

Field Engineer - BC Rodperson

Effective Period: 7/1/2014 - 6/30/2015

Wage Rate per Hour: **\$27.96**

Supplemental Benefit Rate per Hour: **\$30.62**

Supplemental Note: Overtime Benefit Rate - \$42.73 per hour (time & one half) \$54.84 per hour (double time).

Overtime Description

Time and one half the regular rate after a 7 hour work and time and one half the regular rate for Saturday for the first seven hours worked, Double time the regular time rate for Saturday for work performed in excess of seven hours, Double time the regular rate for Sunday and Double time the regular rate for work on a holiday.

Paid Holidays

New Year's Day

President's Day

Good Friday

Memorial Day

Independence Day

Labor Day

Columbus Day

Veteran's Day

Thanksgiving Day

Christmas Day

Employees must work at least one day in the payroll week in which the holiday occurs to receive the paid holiday

OFFICE OF THE COMPTROLLER, CITY OF NEW YORK
§220 PREVAILING WAGE SCHEDULE

(Operating Engineer Local #15-D)

ENGINEER - FIELD (HEAVY CONSTRUCTION)
(Construction of Roads, Tunnels, Bridges, Sewers, Building Foundations,
Engineering Structures etc.)

Field Engineer - HC Party Chief

Effective Period: 7/1/2014 - 6/30/2015

Wage Rate per Hour: **\$62.61**

Supplemental Benefit Rate per Hour: **\$30.62**

Supplemental Note: Overtime benefit rate - \$42.73 per hour (time & one half), \$54.84 per hour (double time).

Field Engineer - HC Instrument Person

Effective Period: 7/1/2014 - 6/30/2015

Wage Rate per Hour: **\$46.00**

Supplemental Benefit Rate per Hour: **\$30.62**

Supplemental Note: Overtime benefit rate - \$42.73 per hour (time & one half), \$54.84 per hour (double time).

Field Engineer - HC Rodperson

Effective Period: 7/1/2014 - 6/30/2015

Wage Rate per Hour: **\$38.61**

Supplemental Benefit Rate per Hour: **\$30.62**

Supplemental Note: Overtime benefit rate - \$42.73 per hour (time & one half), \$54.84 per hour (double time).

Overtime Description

Time and one half the regular rate after an 8 hour day, Time and one half the regular rate for Saturday for the first eight hours worked, Double time the regular time rate for Saturday for work performed in excess of eight hours, Double time the regular rate for Sunday and Double time the regular rate for work on a holiday.

Paid Holidays

New Year's Day

Lincoln's Birthday

President's Day

Memorial Day

Independence Day

Labor Day

Columbus Day

Veteran's Day

Thanksgiving Day

Christmas Day

Employees must work at least one day in the payroll week in which the holiday occurs to receive the paid holiday

OFFICE OF THE COMPTROLLER, CITY OF NEW YORK
§220 PREVAILING WAGE SCHEDULE

(Operating Engineer Local #15-D)

ENGINEER - FIELD (STEEL ERECTION)

Field Engineer - Steel Erection Party Chief

Effective Period: 7/1/2014 - 6/30/2015

Wage Rate per Hour: \$58.50

Supplemental Benefit Rate per Hour: \$30.62

Supplemental Note: Overtime benefit rate - \$42.73 per hour (time & one half), \$54.84 per hour (double time).

Field Engineer - Steel Erection Instrument Person

Effective Period: 7/1/2014 - 6/30/2015

Wage Rate per Hour: \$45.53

Supplemental Benefit Rate per Hour: \$30.62

Supplemental Note: Overtime benefit rate - \$42.73 per hour (time & one half), \$54.84 per hour (double time).

Field Engineer - Steel Erection Rodperson

Effective Period: 7/1/2014 - 6/30/2015

Wage Rate per Hour: \$30.43

Supplemental Benefit Rate per Hour: \$30.62

Supplemental Note: Overtime benefit rate - \$42.73 per hour (time & one half), \$54.84 per hour (double time).

Overtime Description

Time and one half the regular rate for Saturday for the first eight hours worked.

Double time the regular rate for Saturday for work performed in excess of eight hours.

Overtime

Time and one half the regular rate after an 8 hour day.

Double time the regular rate for Sunday.

Double time the regular rate for work on the following holiday(s).

Paid Holidays

New Year's Day

Lincoln's Birthday

President's Day

Memorial Day

Independence Day

Labor Day

Columbus Day

Veteran's Day

Thanksgiving Day

Christmas Day

Employees must work at least one day in the payroll week in which the holiday occurs to receive the paid holiday

OFFICE OF THE COMPTROLLER, CITY OF NEW YORK
§220 PREVAILING WAGE SCHEDULE

(Operating Engineer Local #15-D)

ENGINEER - OPERATING

Operating Engineer - Road & Heavy Construction I

Back Filling Machines, Cranes, Mucking Machines and Dual Drum Paver.

Effective Period: 7/1/2014 - 6/30/2015

Wage Rate per Hour: **\$67.70**

Supplemental Benefit Rate per Hour: **\$28.60**

Supplemental Note: \$51.75 overtime hours

Shift Wage Rate: **\$108.32**

Operating Engineer - Road & Heavy Construction II

Backhoes, Power Shovels, Hydraulic Clam Shells, Steel Erection, Moles and machines of a similar nature.

Effective Period: 7/1/2014 - 6/30/2015

Wage Rate per Hour: **\$70.10**

Supplemental Benefit Rate per Hour: **\$28.60**

Supplemental Note: 51.75 overtime hours

Shift Wage Rate: **\$112.16**

Operating Engineer - Road & Heavy Construction III

Mine Hoists, Cranes, etc. (Used as Mine Hoists)

Effective Period: 7/1/2014 - 6/30/2015

Wage Rate per Hour: **\$72.34**

Supplemental Benefit Rate per Hour: **\$28.60**

Supplemental Note: \$51.75 overtime hours

Shift Wage Rate: **\$115.74**

Operating Engineer - Road & Heavy Construction IV

Gradealls, Keystones, Cranes on land or water (with digging buckets), Bridge Cranes, Vermeer Cutter and machines of a similar nature, Trenching Machines.

Effective Period: 7/1/2014 - 6/30/2015

Wage Rate per Hour: **\$70.63**

Supplemental Benefit Rate per Hour: **\$28.60**

Supplemental Note: \$51.75 overtime hours

Shift Wage Rate: **\$113.01**

Operating Engineer - Road & Heavy Construction V

OFFICE OF THE COMPTROLLER, CITY OF NEW YORK
§220 PREVAILING WAGE SCHEDULE

Pile Drivers & Rigs (employing Dock Builder foreperson): Derrick Boats, Tunnel Shovels.

Effective Period: 7/1/2014 - 6/30/2015

Wage Rate per Hour: \$69.23

Supplemental Benefit Rate per Hour: \$28.60

Supplemental Note: \$51.75 overtime hours

Shift Wage Rate: \$110.77

Operating Engineer - Road & Heavy Construction VI

Mixers (Concrete with loading attachment), Concrete Pavers, Cableways, Land Derricks, Power Houses (Low Air Pressure Units).

Effective Period: 7/1/2014 - 6/30/2015

Wage Rate per Hour: \$65.76

Supplemental Benefit Rate per Hour: \$28.60

Supplemental Note: \$51.75 overtime hours

Shift Wage Rate: \$105.22

Operating Engineer - Road & Heavy Construction VII

Barrier Movers , Barrier Transport and Machines of a Similar Nature.

Effective Period: 7/1/2014 - 6/30/2015

Wage Rate per Hour: \$53.08

Supplemental Benefit Rate per Hour: \$28.60

Supplemental Note: \$51.75 overtime hours

Shift Wage Rate: \$84.93

Operating Engineer - Road & Heavy Construction VIII

Utility Compressors

Effective Period: 7/1/2014 - 6/30/2015

Wage Rate per Hour: \$41.18

Supplemental Benefit Rate per Hour: \$28.60

Supplemental Note: \$51.75 overtime hours

Shift Wage Rate: \$51.93

Operating Engineer - Road & Heavy Construction IX

Horizontal Boring Rig

Effective Period: 7/1/2014 - 6/30/2015

Wage Rate per Hour: \$62.53

Supplemental Benefit Rate per Hour: \$28.60

Supplemental Note: \$51.75 overtime hours

Shift Wage Rate: \$100.05

OFFICE OF THE COMPTROLLER, CITY OF NEW YORK
§220 PREVAILING WAGE SCHEDULE

Operating Engineer - Road & Heavy Construction X

Elevators (manually operated as personnel hoist).

Effective Period: 7/1/2014 - 6/30/2015

Wage Rate per Hour: **\$57.46**

Supplemental Benefit Rate per Hour: **\$28.60**

Supplemental Note: **\$51.75** overtime hours

Shift Wage Rate: **\$91.94**

Operating Engineer - Road & Heavy Construction XI

Compressors (Portable 3 or more in battery), Driving of Truck Mounted Compressors, Well-point Pumps, Tugger Machines Well Point Pumps, Churn Drill.

Effective Period: 7/1/2014 - 6/30/2015

Wage Rate per Hour: **\$44.63**

Supplemental Benefit Rate per Hour: **\$28.60**

Supplemental Note: **\$51.75** overtime hours

Shift Wage Rate: **\$71.41**

Operating Engineer - Road & Heavy Construction XII

All Drills and Machines of a similar nature.

Effective Period: 7/1/2014 - 6/30/2015

Wage Rate per Hour: **\$66.45**

Supplemental Benefit Rate per Hour: **\$28.60**

Supplemental Note: **\$51.75** overtime hours

Shift Wage Rate: **\$106.32**

Operating Engineer - Road & Heavy Construction XIII

Concrete Pumps, Concrete Plant, Stone Crushers, Double Drum Hoist, Power Houses (other than above).

Effective Period: 7/1/2014 - 6/30/2015

Wage Rate per Hour: **\$64.34**

Supplemental Benefit Rate per Hour: **\$28.60**

Supplemental Note: **\$51.75** overtime hours

Shift Wage Rate: **\$102.94**

Operating Engineer - Road & Heavy Construction XIV

Concrete Mixer

Effective Period: 7/1/2014 - 6/30/2015

Wage Rate per Hour: **\$61.53**

Supplemental Benefit Rate per Hour: **\$28.60**

Supplemental Note: **\$51.75** overtime hours

Shift Wage Rate: **\$98.45**

OFFICE OF THE COMPTROLLER, CITY OF NEW YORK
§220 PREVAILING WAGE SCHEDULE

Operating Engineer - Road & Heavy Construction XV

Compressors (Portable Single or two in Battery, not over 100 feet apart), Pumps (River Cofferdam) and Welding Machines, Push Button Machines, All Engines Irrespective of Power (Power-Pac) used to drive auxiliary equipment, Air, Hydraulic, etc.

Effective Period: 7/1/2014 - 6/30/2015

Wage Rate per Hour: **\$41.44**

Supplemental Benefit Rate per Hour: **\$28.60**

Supplemental Note: **\$51.75** overtime hours

Shift Wage Rate: **\$66.30**

Operating Engineer - Road & Heavy Construction XVI

Concrete Breaking Machines, Hoists (Single Drum), Load Masters, Locomotives (over ten tons) and Dinkies over ten tons, Hydraulic Crane-Second Engineer.

Effective Period: 7/1/2014 - 6/30/2015

Wage Rate per Hour: **\$58.74**

Supplemental Benefit Rate per Hour: **\$28.60**

Supplemental Note: **\$51.85** overtime hours

Shift Wage Rate: **\$93.98**

Operating Engineer - Road & Heavy Construction XVII

On-Site concrete plant engineer, On-site Asphalt Plant Engineer, and Vibratory console.

Effective Period: 7/1/2014 - 6/30/2015

Wage Rate per Hour: **\$59.21**

Supplemental Benefit Rate per Hour: **\$28.60**

Supplemental Note: **\$51.75** overtime hours

Shift Wage Rate: **\$94.74**

Operating Engineer - Road & Heavy Construction XVIII

Tower Crane

Effective Period: 7/1/2014 - 6/30/2015

Wage Rate per Hour: **\$85.00**

Supplemental Benefit Rate per Hour: **\$28.60**

Supplemental Note: **\$51.75** overtime hours

Shift Wage Rate: **\$136.00**

Operating Engineer - Paving I

Asphalt Spreaders, Autogrades (C.M.I.), Roto/Mil

Effective Period: 7/1/2014 - 6/30/2015

Wage Rate per Hour: **\$65.76**

OFFICE OF THE COMPTROLLER, CITY OF NEW YORK
§220 PREVAILING WAGE SCHEDULE

Supplemental Benefit Rate per Hour: \$28.60
Supplemental Note: \$51.75 overtime hours
Shift Wage Rate: \$105.22

Operating Engineer - Paving II

Asphalt Roller

Effective Period: 7/1/2014 - 6/30/2015
Wage Rate per Hour: \$64.04
Supplemental Benefit Rate per Hour: \$28.60
Supplemental Note: \$51.75 overtime hours
Shift Wage Rate: \$102.46

Operating Engineer - Paving III

Asphalt Plants

Effective Period: 7/1/2014 - 6/30/2015
Wage Rate per Hour: \$54.17
Supplemental Benefit Rate per Hour: \$28.60
Supplemental Note: \$51.75 overtime hours
Shift Wage Rate: \$86.67

Operating Engineer - Concrete I

Cranes

Effective Period: 7/1/2014 - 6/30/2015
Wage Rate per Hour: \$70.32
Supplemental Benefit Rate per Hour: \$28.60
Supplemental Note: \$51.75 overtime hours

Operating Engineer - Concrete II

Compressors

Effective Period: 7/1/2014 - 6/30/2015
Wage Rate per Hour: \$41.76
Supplemental Benefit Rate per Hour: \$28.60
Supplemental Note: \$51.75 overtime hours

Operating Engineer - Concrete III

Micro-traps (Negative Air Machines), Vac-All Remediation System.

Effective Period: 7/1/2014 - 6/30/2015
Wage Rate per Hour: \$56.16
Supplemental Benefit Rate per Hour: \$28.60
Supplemental Note: \$51.75 overtime hours

OFFICE OF THE COMPTROLLER, CITY OF NEW YORK
§220 PREVAILING WAGE SCHEDULE

Operating Engineer - Steel Erection I

Three Drum Derricks

Effective Period: 7/1/2014 - 6/30/2015

Wage Rate per Hour: \$73.37

Supplemental Benefit Rate per Hour: \$28.60

Supplemental Note: \$51.75 overtime hours

Shift Wage Rate: \$117.39

Operating Engineer - Steel Erection II

Cranes, 2 Drum Derricks, Hydraulic Cranes, Fork Lifts and Boom Trucks.

Effective Period: 7/1/2014 - 6/30/2015

Wage Rate per Hour: \$70.50

Supplemental Benefit Rate per Hour: \$28.60

Supplemental Note: \$51.75 overtime hours

Shift Wage Rate: \$112.80

Operating Engineer - Steel Erection III

Compressors, Welding Machines.

Effective Period: 7/1/2014 - 6/30/2015

Wage Rate per Hour: \$41.84

Supplemental Benefit Rate per Hour: \$28.60

Supplemental Note: \$51.75 overtime hours

Shift Wage Rate: \$66.94

Operating Engineer - Steel Erection IV

Compressors - Not Combined with Welding Machine.

Effective Period: 7/1/2014 - 6/30/2015

Wage Rate per Hour: \$39.85

Supplemental Benefit Rate per Hour: \$28.60

Supplemental Note: \$51.75 overtime hours

Shift Wage Rate: \$63.76

Operating Engineer - Building Work I

Forklifts, Plaster (Platform machine), Plaster Bucket, Concrete Pump and all other equipment used for hoisting material.

Effective Period: 7/1/2014 - 6/30/2015

Wage Rate per Hour: \$57.82

Supplemental Benefit Rate per Hour: \$28.60

Supplemental Note: \$51.75 overtime hours

OFFICE OF THE COMPTROLLER, CITY OF NEW YORK
§220 PREVAILING WAGE SCHEDULE

Operating Engineer - Building Work II

Compressors, Welding Machines (Cutting Concrete-Tank Work), Paint Spraying, Sandblasting, Pumps (with the exclusion of Concrete Pumps), All Engines irrespective of Power (Power-Pac) used to drive Auxiliary Equipment, Air, Hydraulic, Jacking System, etc.

Effective Period: 7/1/2014 - 6/30/2015

Wage Rate per Hour: **\$43.28**

Supplemental Benefit Rate per Hour: **\$28.60**

Supplemental Note: \$51.75 overtime hours

Operating Engineer - Building Work III

Double Drum

Effective Period: 7/1/2014 - 6/30/2015

Wage Rate per Hour: **\$65.83**

Supplemental Benefit Rate per Hour: **\$28.60**

Supplemental Note: \$51.75 overtime hours

Operating Engineer - Building Work IV

Stone Derrick, Cranes, Hydraulic Cranes Boom Trucks.

Effective Period: 7/1/2014 - 6/30/2015

Wage Rate per Hour: **\$69.74**

Supplemental Benefit Rate per Hour: **\$28.60**

Supplemental Note: \$51.75 overtime hours

Operating Engineer - Building Work V

Dismantling and Erection of Cranes, Relief Engineer.

Effective Period: 7/1/2014 - 6/30/2015

Wage Rate per Hour: **\$64.26**

Supplemental Benefit Rate per Hour: **\$28.60**

Supplemental Note: \$51.75 overtime hours

Operating Engineer - Building Work VI

4 Pole Hoist, Single Drum Hoists.

Effective Period: 7/1/2014 - 6/30/2015

Wage Rate per Hour: **\$63.58**

Supplemental Benefit Rate per Hour: **\$28.60**

Supplemental Note: \$51.75 overtime hours

Operating Engineer - Building Work VII

OFFICE OF THE COMPTROLLER, CITY OF NEW YORK
§220 PREVAILING WAGE SCHEDULE

Rack & Pinion and House Cars

Effective Period: 7/1/2014 - 6/30/2015

Wage Rate per Hour: **\$50.53**

Supplemental Benefit Rate per Hour: **\$28.60**

Supplemental Note: **\$51.75** overtime hours

For New House Car projects started after 7/1/11 only: Wage Rate per Hour **\$40.31**

Overtime Description

On jobs of more than one shift, if an Employee fails to report for work through any cause over which the Employer has no control, the Employee on duty will continue to work at the rate of single time.

For House Cars and Rack & Pinion only: Overtime paid at time and one-half for all hours in excess of eight hours in a day, Saturday, Sunday and Holidays worked.

Overtime

Double time the regular rate after an 8 hour day.

Double time the regular time rate for Saturday.

Double time the regular rate for Sunday.

Double time the regular rate for work on the following holiday(s).

Paid Holidays

New Year's Day

Lincoln's Birthday

President's Day

Memorial Day

Independence Day

Labor Day

Columbus Day

Veteran's Day

Thanksgiving Day

Day after Thanksgiving

Christmas Day

Employees must work at least one day in the payroll week in which the holiday occurs to receive the paid holiday

Shift Rates

For Steel Erection Only: Shifts may be worked at the single time rate at other than the regular working hours (8:00 A.M. to 4:30 P.M.) on the following work ONLY: Heavy construction jobs on work below the street level, over railroad tracks and on building jobs.

(Operating Engineer Local #14)

FLOOR COVERER

(Interior vinyl composition tile, sheath vinyl linoleum and wood parquet tile including site preparation and synthetic turf not including site preparation)

Floor Coverer

OFFICE OF THE COMPTROLLER, CITY OF NEW YORK
§220 PREVAILING WAGE SCHEDULE

Effective Period: 7/1/2014 - 6/30/2015

Wage Rate per Hour: **\$49.88**

Supplemental Benefit Rate per Hour: **\$44.10**

Overtime

Time and one half the regular rate after an 8 hour day.

Time and one half the regular rate for Saturday.

Double time the regular rate for Sunday.

Overtime Holidays

Double time the regular rate for work on the following holiday(s).

New Year's Day

President's Day

Memorial Day

Independence Day

Labor Day

Columbus Day

Presidential Election Day

Thanksgiving Day

Day after Thanksgiving

Christmas Day

Paid Holidays

1/2 day on Christmas Eve if work is performed in the A.M.

1/2 day on New Year's Eve if work is performed in the A.M.

Shift Rates

Two shifts may be utilized with the first shift working 8:00 A.M. to the end of the shift at the straight time of pay. The second shift will receive one hour at double time rate for the last hour of the shift. (eight for seven, nine for eight).

(Carpenters District Council)

GLAZIER

(New Construction, Remodeling, and Alteration)

Glazier

Effective Period: 7/1/2014 - 10/31/2014

Wage Rate per Hour: **\$42.50**

Supplemental Benefit Rate per Hour: **\$35.09**

Supplemental Note: Supplemental Benefit Overtime Rate: **\$43.59**

Effective Period: 11/1/2014 - 6/30/2015

Wage Rate per Hour: **\$42.85**

Supplemental Benefit Rate per Hour: **\$35.59**

OFFICE OF THE COMPTROLLER, CITY OF NEW YORK
§220 PREVAILING WAGE SCHEDULE

Supplemental Note: Supplemental Benefit Overtime Rate: \$44.09

Overtime Description

An optional 8th hour can be worked at straight time rate. If 9th hour is worked, then both hours or more (8th & 9th or more) will be at the double time rate of pay.

Overtime

Double time the regular rate after a 7 hour day.
Double time the regular time rate for Saturday.
Double time the regular rate for Sunday.

Overtime Holidays

Double time the regular rate for work on the following holiday(s).

New Year's Day
President's Day
Memorial Day
Independence Day
Labor Day
Thanksgiving Day
Day after Thanksgiving
Christmas Day

Paid Holidays

None

Shift Rates

Shifts shall be any 7 hours beyond 4:00 P.M. for which the glazier shall receive 8 hours pay for 7 hours worked.

(Local #1281)

GLAZIER - REPAIR & MAINTENANCE

(For the Installation of Glass - All repair and maintenance work on a particular building, whenever performed, where the total cumulative contract value is under \$105,000. Except where enumerated (i.e. plate glass windows) does not apply to non-residential buildings.)

Craft Jurisdiction for repair, maintenance and fabrication

Plate glass replacement, Residential glass replacement, Residential mirrors and shower doors, Storm windows and storm doors, Residential replacement windows, Herculite door repairs, Door closer repairs, Retrofit apartment house (non commercial buildings), Glass tinting.

Effective Period: 7/1/2014 - 6/30/2015

Wage Rate per Hour: \$23.60

Supplemental Benefit Rate per Hour: \$19.04

OFFICE OF THE COMPTROLLER, CITY OF NEW YORK
§220 PREVAILING WAGE SCHEDULE

Overtime

Time and one half the regular rate after an 8 hour day.
Double time the regular rate for Sunday.
Time and one half the regular hourly rate after 40 hours in any work week.

Paid Holidays

New Year's Day
President's Day
Memorial Day
Independence Day
Labor Day
Thanksgiving Day
Day after Thanksgiving
Christmas Day

(Local #1281)

HEAT AND FROST INSULATOR

Heat & Frost Insulator

Effective Period: 7/1/2014 - 6/30/2015

Wage Rate per Hour: **\$56.98**

Supplemental Benefit Rate per Hour: **\$34.81**

Overtime Description

Double time shall be paid for supplemental benefits during overtime work.
8th hour paid at time and one half.

Overtime

Double time the regular rate after an 8 hour day.
Double time the regular time rate for Saturday.
Double time the regular rate for Sunday.

Overtime Holidays

Double time the regular rate for work on the following holiday(s).

New Year's Day
Martin Luther King Jr. Day
President's Day
Memorial Day
Independence Day
Columbus Day
Veteran's Day
Thanksgiving Day
Day after Thanksgiving
Christmas Day

Triple time the regular rate for work on the following holiday(s).
Labor Day

OFFICE OF THE COMPTROLLER, CITY OF NEW YORK
§220 PREVAILING WAGE SCHEDULE

Paid Holidays

None

Shift Rates

The first shift shall work seven hours at the regular straight time rate. The second and third shift shall work seven hours the regular straight time hourly rate plus a fourteen percent wage and benefit premium. Off hour work in occupied or retail buildings may be worked on weekdays with an increment of \$1.00 per hour and eight hours pay for seven (7) hours worked. Double time will apply for over seven (7) hours worked on weekdays, weekends or holidays.

(Local #12)

**HOUSE WRECKER
(TOTAL DEMOLITION)**

House Wrecker - Tier A

On all work sites the first, second, eleventh and every third House Wrecker thereafter will be Tier A House Wreckers (i.e. 1st, 2nd, 11th, 14th etc). Other House Wreckers may be Tier B House Wreckers.

Effective Period: 7/1/2014 - 6/30/2015

Wage Rate per Hour: **\$34.51**

Supplemental Benefit Rate per Hour: **\$25.59**

House Wrecker - Tier B

Effective Period: 7/1/2014 - 6/30/2015

Wage Rate per Hour: **\$24.02**

Supplemental Benefit Rate per Hour: **\$19.12**

Overtime

Time and one half the regular rate after an 8 hour day.

Time and one half the regular rate for Saturday.

Double time the regular rate for Sunday.

Overtime Holidays

Double time the regular rate for work on the following holiday(s).

New Year's Day

President's Day

Memorial Day

Independence Day

Labor Day

Thanksgiving Day

Christmas Day

OFFICE OF THE COMPTROLLER, CITY OF NEW YORK
§220 PREVAILING WAGE SCHEDULE

Paid Holidays

None

(Mason Tenders District Council)

IRON WORKER - ORNAMENTAL

Iron Worker - Ornamental

Effective Period: 7/1/2014 - 6/30/2015

Wage Rate per Hour: **\$42.70**

Supplemental Benefit Rate per Hour: **\$45.77**

Supplemental Note: Supplemental benefits are to be paid at the applicable overtime rate when overtime is in effect.

Overtime Description

Time and one half the regular rate after a 7 hour day for a maximum of two hours on any regular work day (the 8th and 9th hour) and double time shall be paid for all work on a regular work day thereafter, time and one half the regular rate for Saturday for the first seven hours of work and double time shall be paid for all work on a Saturday thereafter.

Overtime

Double time the regular rate for Sunday.

Overtime Holidays

Double time the regular rate for work on the following holiday(s).

New Year's Day

President's Day

Memorial Day

Independence Day

Labor Day

Thanksgiving Day

Christmas Day

Paid Holidays

None

Shift Rates

For off shift work - 8 hours pay for 7 hours of work. When two or three shifts are employed on a job, Monday through Friday, the workday for each shift shall be seven hours and paid for ten and one-half hours at the single time rate. When two or three shifts are worked on Saturday, Sunday or holidays, each shift shall be seven hours and paid fifteen and three-quarters hours.

(Local #580)

OFFICE OF THE COMPTROLLER, CITY OF NEW YORK
§220 PREVAILING WAGE SCHEDULE

IRON WORKER - STRUCTURAL

Iron Worker - Structural

Effective Period: 7/1/2014 - 6/30/2015

Wage Rate per Hour: \$47.75

Supplemental Benefit Rate per Hour: \$65.35

Supplemental Note: Supplemental benefits are to be paid at the applicable overtime rate when overtime is in effect.

Overtime Description

Monday through Friday- the first eight hours are paid at straight time, the 9th and 10th hours are paid at time and one-half the regular rate, all additional weekday overtime is paid at double the regular rate. Saturdays- the first eight hours are paid at time and one-half the regular rate, double time thereafter. Sunday-all shifts are paid at double time.

Overtime

Time and one half the regular rate after an 8 hour day.

Time and one half the regular rate for Saturday.

Double time the regular rate for Sunday.

Overtime Holidays

Double time the regular rate for work on the following holiday(s).

New Year's Day

Good Friday

Memorial Day

Independence Day

Labor Day

Thanksgiving Day

Christmas Day

Paid Holidays

1/2 day on Christmas Eve if work is performed in the A.M.

1/2 day on New Year's Eve if work is performed in the A.M.

Shift Rates

Monday through Friday - First Shift: First eight hours are paid at straight time, the 9th & 10th hours are paid at time and a half, double time paid thereafter. Second and third Shifts: First eight hours are paid at time and one-half, double time thereafter. Saturdays: All shifts, first eight hours paid at time and one-half, double time thereafter. Sunday all shifts are paid at double time.

(Local #40 & #361)

LABORER

(Foundation, Concrete, Excavating, Street Pipe Layer and Common)

OFFICE OF THE COMPTROLLER, CITY OF NEW YORK
§220 PREVAILING WAGE SCHEDULE

Laborer

Excavation and foundation work for buildings, heavy construction, engineering work, and hazardous waste removal in connection with the above work. Landscaping tasks in connection with heavy construction work, engineering work and building projects. Projects include, but are not limited to pollution plants, sewers, parks, subways, bridges, highways, etc.

Effective Period: 7/1/2014 - 6/30/2015

Wage Rate per Hour: **\$39.85**

Supplemental Benefit Rate per Hour: **\$34.88**

Overtime

Time and one half the regular rate after an 8 hour day.

Time and one half the regular rate for Saturday.

Double time the regular rate for Sunday.

Overtime Holidays

Double time the regular rate for work on the following holiday(s).

New Year's Day

Memorial Day

Independence Day

Labor Day

Columbus Day

Presidential Election Day

Thanksgiving Day

Christmas Day

Paid Holidays

Labor Day

Thanksgiving Day

Shift Rates

When two shifts are employed, single time rate shall be paid for each shift. When three shifts are found necessary, each shift shall work seven and one half hours (7 ½), but shall be paid for eight (8) hours of labor, and be permitted one half hour for lunch.

(Local #731)

LANDSCAPING

(Landscaping tasks, as well as tree pruning, tree removing, spraying and maintenance in connection with the planting of street trees and the planting of trees in city parks but not when such activities are performed as part of, or in connection with, other construction or reconstruction projects.)

Landscaper (Above 6 years experience)

OFFICE OF THE COMPTROLLER, CITY OF NEW YORK
§220 PREVAILING WAGE SCHEDULE

Effective Period: 7/1/2014 - 6/30/2015
Wage Rate per Hour: **\$25.75**
Supplemental Benefit Rate per Hour: **\$13.80**

Landscaper (3 - 6 years experience)

Effective Period: 7/1/2014 - 6/30/2015
Wage Rate per Hour: **\$24.75**
Supplemental Benefit Rate per Hour: **\$13.80**

Landscaper (up to 3 years experience)

Effective Period: 7/1/2014 - 6/30/2015
Wage Rate per Hour: **\$22.25**
Supplemental Benefit Rate per Hour: **\$13.80**

Groundperson

Effective Period: 7/1/2014 - 6/30/2015
Wage Rate per Hour: **\$22.25**
Supplemental Benefit Rate per Hour: **\$13.80**

Tree Remover / Pruner

Effective Period: 7/1/2014 - 6/30/2015
Wage Rate per Hour: **\$30.75**
Supplemental Benefit Rate per Hour: **\$13.80**

Landscaper Sprayer (Pesticide Applicator)

Effective Period: 7/1/2014 - 6/30/2015
Wage Rate per Hour: **\$20.75**
Supplemental Benefit Rate per Hour: **\$13.80**

Watering - Plant Maintainer

Effective Period: 7/1/2014 - 6/30/2015
Wage Rate per Hour: **\$15.75**
Supplemental Benefit Rate per Hour: **\$13.80**

Overtime Description

For all overtime work performed, supplemental benefits shall include an additional seventy-five (\$0.75) cents per hour.

Overtime

Time and one half the regular rate after an 8 hour day.
Time and one half the regular rate for Saturday.
Double time the regular rate for Sunday.
Time and one half the regular rate for work on a holiday plus the day's pay.

OFFICE OF THE COMPTROLLER, CITY OF NEW YORK
§220 PREVAILING WAGE SCHEDULE

Paid Holidays

New Year's Day
Memorial Day
Independence Day
Labor Day
Thanksgiving Day
Christmas Day

Shift Rates

Work performed on a 4pm to 12am shift has a 15% differential. Work performed on a 12am to 8am shift has a 20% differential.

(Local #175)

MARBLE MECHANIC

Marble Setter

Effective Period: 7/1/2014 - 12/31/2014

Wage Rate per Hour: **\$50.85**

Supplemental Benefit Rate per Hour: **\$34.21**

Effective Period: 1/1/2015 - 6/30/2015

Wage Rate per Hour: **\$51.15**

Supplemental Benefit Rate per Hour: **\$34.87**

Marble Finisher

Effective Period: 7/1/2014 - 12/31/2014

Wage Rate per Hour: **\$39.99**

Supplemental Benefit Rate per Hour: **\$33.34**

Effective Period: 1/1/2015 - 6/30/2015

Wage Rate per Hour: **\$40.26**

Supplemental Benefit Rate per Hour: **\$33.90**

Marble Polisher

Effective Period: 7/1/2014 - 12/31/2014

Wage Rate per Hour: **\$35.96**

Supplemental Benefit Rate per Hour: **\$25.92**

Effective Period: 1/1/2015 - 6/30/2015

Wage Rate per Hour: **\$36.25**

Supplemental Benefit Rate per Hour: **\$26.28**

OFFICE OF THE COMPTROLLER, CITY OF NEW YORK
§220 PREVAILING WAGE SCHEDULE

Overtime Description

Supplemental Benefit contributions are to be made at the applicable overtime rates. Time and one half the regular rate after a 7 hour day or time and one half the regular rate after an 8 hour day - chosen by Employer at the start of the project and then would last for the full duration of the project.

Overtime

Time and one half the regular rate for Saturday.
Double time the regular rate for Sunday.

Overtime Holidays

Double time the regular rate for work on the following holiday(s).

New Year's Day
President's Day
Good Friday
Memorial Day
Independence Day
Labor Day
Columbus Day
Veteran's Day
Thanksgiving Day
Day after Thanksgiving
Christmas Day

Paid Holidays

None

(Local #7)

MASON TENDER

Mason Tender

Effective Period: 7/1/2014 - 6/30/2015

Wage Rate per Hour: \$36.05

Supplemental Benefit Rate per Hour: \$26.74

Overtime

Time and one half the regular rate after an 8 hour day.
Time and one half the regular rate for Saturday.
Double time the regular rate for Sunday.
Saturday may be used as a make-up day at straight time when a day is lost during that week to inclement weather.

Overtime Holidays

Double time the regular rate for work on the following holiday(s).
New Year's Day
President's Day

OFFICE OF THE COMPTROLLER, CITY OF NEW YORK
§220 PREVAILING WAGE SCHEDULE

Memorial Day
Independence Day
Labor Day
Thanksgiving Day
Christmas Day

Paid Holidays

None

Shift Rates

The Employer may work two (2) shifts with the first shift at the straight time wage rate and the second shift receiving eight (8) hours paid for seven (7) hours work at the straight time wage rate.

(Local #79)

MASON TENDER (INTERIOR DEMOLITION WORKER)

(The erection, building, moving, servicing and dismantling of enclosures, scaffolding, barricades, protection and site safety structures etc., on Interior Demolition jobs.)

Mason Tender Tier A

Effective Period: 7/1/2014 - 6/30/2015

Wage Rate per Hour: **\$34.99**

Supplemental Benefit Rate per Hour: **\$21.10**

Mason Tender Tier B

On Interior Demolition job sites 33 1/3 % of the employees shall be classified as Tier A Interior Demolition Workers and 66 2/3 % shall be classified as Tier B Interior Demolition Workers; provided that the employer may employ more than 33 1/3 % Tier A Interior Demolition Workers on the job site. Where the number of employees on a job site is not divisible by 3, the first additional employee (above the number of employees divisible by three) shall be a Tier B Interior Demolition Worker, and the second additional employee shall be a Tier A Interior Demolition Worker.

Effective Period: 7/1/2014 - 6/30/2015

Wage Rate per Hour: **\$24.18**

Supplemental Benefit Rate per Hour: **\$15.42**

Overtime

Time and one half the regular rate after an 8 hour day.

Time and one half the regular rate for Sunday.

Overtime Holidays

Double time the regular rate for work on the following holiday(s).

New Year's Day

OFFICE OF THE COMPTROLLER, CITY OF NEW YORK
§220 PREVAILING WAGE SCHEDULE

President's Day
Memorial Day
Independence Day
Labor Day
Thanksgiving Day
Christmas Day

Paid Holidays

None

(Local #79)

METALLIC LATHER

Metallic Lather

Effective Period: 7/1/2014 - 6/30/2015

Wage Rate per Hour: \$42.03

Supplemental Benefit Rate per Hour: \$41.07

Supplemental Note: Supplemental benefits for overtime are paid at the appropriate overtime rate.

Overtime Description

Overtime would be time and one half the regular rate after a seven (7) or eight (8) hours workday, which would be set at the start of the job.

Overtime

Time and one half the regular rate for Saturday.

Double time the regular rate for Sunday.

Overtime Holidays

Double time the regular rate for work on the following holiday(s).

New Year's Day
Washington's Birthday
Good Friday
Memorial Day
Independence Day
Labor Day
Columbus Day
Presidential Election Day
Thanksgiving Day
Christmas Day

Paid Holidays

1/2 day on Christmas Eve if work is performed in the A.M.
1/2 day on New Year's Eve if work is performed in the A.M.

Shift Rates

OFFICE OF THE COMPTROLLER, CITY OF NEW YORK
§220 PREVAILING WAGE SCHEDULE

There shall be either two (2) or three (3) shifts, each shift shall be eight (8) hours with nine (9) hours pay, including one half (½) hour for lunch. Off-Hour Start shall commence after 3:30 P.M. and shall conclude by 6:00 A.M. The first consecutive seven (7) hours shall be at straight time with a differential of twelve dollars (\$12.00) per hour. Fringes shall be paid at the straight time rate.

(Local #46)

MILLWRIGHT

Millwright

Effective Period: 7/1/2014 - 6/30/2015

Wage Rate per Hour: **\$48.44**

Supplemental Benefit Rate per Hour: **\$50.52**

Overtime

Time and one half the regular rate after an 8 hour day.

Time and one half the regular rate for Saturday.

Double time the regular rate for Sunday.

Saturday may be used as a make-up day at straight time when a day is lost during that week to inclement weather.

Overtime Holidays

Double time the regular rate for work on the following holiday(s).

New Year's Day

President's Day

Good Friday

Memorial Day

Independence Day

Labor Day

Columbus Day

Presidential Election Day

Thanksgiving Day

Christmas Day

Paid Holidays

1/2 day on Christmas Eve if work is performed in the A.M.

1/2 day on New Year's Eve if work is performed in the A.M.

Shift Rates

The first shift shall receive the straight time rate of pay. The second shift receives the straight time rate of pay plus fifteen (15%) per cent. Members of the second shift shall be allowed one half hour to eat, with this time being included in the hours of the workday established. There must be a first shift to work a second shift. All additional hours worked shall be paid at the time and one-half rate of pay plus fifteen (15%) per cent for weekday hours.

(Local #740)

MOSAIC MECHANIC

Mosaic Mechanic - Mosaic & Terrazzo Mechanic

Effective Period: 7/1/2014 - 6/30/2015

Wage Rate per Hour: \$45.23

Supplemental Benefit Rate per Hour: \$36.59

Supplemental Note: Supplemental benefits for overtime to be paid at the rate of \$47.56 per hour.

Mosaic Mechanic - Mosaic & Terrazzo Finisher

Effective Period: 7/1/2014 - 6/30/2015

Wage Rate per Hour: \$43.63

Supplemental Benefit Rate per Hour: \$36.57

Supplemental Note: Supplemental benefits for overtime to be paid at the rate of \$47.54 per hour.

Mosaic Mechanic - Machine Operator Grinder

Effective Period: 7/1/2014 - 6/30/2015

Wage Rate per Hour: \$43.63

Supplemental Benefit Rate per Hour: \$36.57

Supplemental Note: Supplemental benefits for overtime to be paid at the rate of \$47.54 per hour.

Overtime

Time and one half the regular rate after a 7 hour day.

Time and one half the regular rate for Saturday.

Double time the regular rate for Sunday.

Overtime Holidays

Double time the regular rate for work on the following holiday(s).

New Year's Day

Washington's Birthday

Good Friday

Independence Day

Labor Day

Columbus Day

Veteran's Day

Thanksgiving Day

Day after Thanksgiving

Christmas Day

Paid Holidays

None

(Local #7)

OFFICE OF THE COMPTROLLER, CITY OF NEW YORK
§220 PREVAILING WAGE SCHEDULE

PAINTER

Painter - Brush & Roller

Effective Period: 7/1/2014 - 6/30/2015

Wage Rate per Hour: **\$39.50**

Supplemental Benefit Rate per Hour: **\$26.12**

Supplemental Note: **\$30.75** on overtime

Spray & Scaffold / Decorative / Sandblast

Effective Period: 7/1/2014 - 6/30/2015

Wage Rate per Hour: **\$42.50**

Supplemental Benefit Rate per Hour: **\$26.12**

Supplemental Note: **\$30.75** on overtime

Overtime

Time and one half the regular rate after a 7 hour day.

Time and one half the regular rate for Saturday.

Time and one half the regular rate for Sunday.

Overtime Holidays

Time and one half the regular rate for work on the following holiday(s).

New Year's Day

President's Day

Memorial Day

Independence Day

Labor Day

Columbus Day

Thanksgiving Day

Christmas Day

Paid Holidays

None

(District Council of Painters #9)

PAINTER - SIGN

Designer

Effective Period: 7/1/2014 - 6/30/2015

Wage Rate per Hour: **\$36.15**

Supplemental Benefit Rate per Hour: **\$9.66**

Journey person

OFFICE OF THE COMPTROLLER, CITY OF NEW YORK
§220 PREVAILING WAGE SCHEDULE

Effective Period: 7/1/2014 - 6/30/2015
Wage Rate per Hour: **\$33.62**
Supplemental Benefit Rate per Hour: **\$9.66**

Overtime

Time and one half the regular rate after an 8 hour day.
Time and one half the regular rate for Saturday.
Time and one half the regular rate for Sunday.
Double time the regular rate for work on the following holiday(s).

Paid Holidays

New Year's Day
President's Day
Memorial Day
Independence Day
Labor Day
Columbus Day
Election Day
Thanksgiving Day
Day after Thanksgiving
Christmas Day

Shift Rates

All work performed outside the regular 8 hour work day (either 7:00 A.M to 3:30 P.M or 8:00 A.M. to 4:30 P.M) shall be paid at time and one half the regular hourly rate.

(Local #8A-28A)

PAINTER - STRIPER

Striper (paint)

Effective Period: 7/1/2014 - 6/30/2015
Wage Rate per Hour: **\$34.00**
Supplemental Benefit Rate per Hour: **\$12.60**
Supplemental Note: Overtime Supplemental Benefit rate - \$8.35 New Hire Rate (0-3 months) - \$0.00

Lineperson (thermoplastic)

Effective Period: 7/1/2014 - 6/30/2015
Wage Rate per Hour: **\$38.00**
Supplemental Benefit Rate per Hour: **\$12.60**
Supplemental Note: Overtime Supplemental Benefit rate - \$8.35; New Hire Rate (0-3 months) - \$0.00

Overtime

Time and one half the regular rate after an 8 hour day.
Time and one half the regular rate for Saturday.

OFFICE OF THE COMPTROLLER, CITY OF NEW YORK
§220 PREVAILING WAGE SCHEDULE

Double time the regular rate for Sunday.
Time and one half the regular rate for work on the following holiday(s).

Paid Holidays

New Year's Day
Good Friday
Memorial Day
Independence Day
Labor Day
Columbus Day
Presidential Election Day
Thanksgiving Day
Day after Thanksgiving
Christmas Day

Shift Rates

Employees hired before April 1, 2003: 15% night shift premium differential for work commenced at 9:00 PM or later.

Vacation

Employees with one to two years service shall accrue vacation based on hours worked: 250 hours worked - 1 day vacation; 500 hours worked - 2 days vacation; 750 hours worked - 3 days vacation; 900 hours worked - 4 days vacation; 1,000 hours worked - 5 days vacation. Employees with two to five years service receive two weeks vacation. Employees with five to twenty years service receive three weeks vacation. Employees with twenty to twenty-five years service receive four weeks vacation. Employees with 25 or more years service receive five weeks vacation. Vacation must be taken during winter months. 2 Personal Days except employees hired after 4/1/12 who do not have 2 years of service.

(Local #917)

PAINTER - STRUCTURAL STEEL

Painters on Structural Steel

Effective Period: 7/1/2014 - 9/30/2014
Wage Rate per Hour: \$47.00
Supplemental Benefit Rate per Hour: \$33.58

Effective Period: 10/1/2014 - 6/30/2015
Wage Rate per Hour: \$48.75
Supplemental Benefit Rate per Hour: \$34.58

Painter - Power Tool

Effective Period: 7/1/2014 - 9/30/2014
Wage Rate per Hour: \$53.00
Supplemental Benefit Rate per Hour: \$33.58

Effective Period: 10/1/2014 - 6/30/2015

OFFICE OF THE COMPTROLLER, CITY OF NEW YORK
§220 PREVAILING WAGE SCHEDULE

Wage Rate per Hour: **\$54.75**

Supplemental Benefit Rate per Hour: **\$34.58**

Overtime Description

Supplemental Benefits shall be paid for each hour worked, up to forty (40) hours per week for the period of May 1st to November 15th or up to fifty (50) hours per week for the period of November 16th to April 30th.

Overtime

Time and one half the regular rate after a 7 hour day.

Time and one half the regular rate for Saturday.

Time and one half the regular rate for Sunday.

Overtime Holidays

Double time the regular rate for work on the following holiday(s).

New Year's Day

Memorial Day

Independence Day

Labor Day

Thanksgiving Day

Christmas Day

Paid Holidays

None

Shift Rates

Regular hourly rates plus a ten per cent (10%) differential

(Local #806)

PAPERHANGER

Paperhanger

Effective Period: 7/1/2014 - 6/30/2015

Wage Rate per Hour: **\$41.08**

Supplemental Benefit Rate per Hour: **\$29.23**

Supplemental Note: Supplemental benefits are to be paid at the appropriate straight time and overtime rate.

Overtime

Time and one half the regular rate after a 7 hour day.

Time and one half the regular rate for Saturday.

Time and one half the regular rate for Sunday.

Overtime Holidays

Time and one half the regular rate for work on the following holiday(s).

New Year's Day

President's Day

OFFICE OF THE COMPTROLLER, CITY OF NEW YORK
§220 PREVAILING WAGE SCHEDULE

Memorial Day
Independence Day
Labor Day
Thanksgiving Day
Day after Thanksgiving
Christmas Day

Paid Holidays

None

Shift Rates

Evening shift - 4:30 P.M. to 12:00 Midnight (regular rate of pay); any work performed before 7:00 A.M. shall be at time and one half the regular base rate of pay.

(District Council of Painters #9)

PAVER AND ROADBUILDER

Paver & Roadbuilder - Formsetter

Effective Period: 7/1/2014 - 6/30/2015

Wage Rate per Hour: **\$44.19**

Supplemental Benefit Rate per Hour: **\$35.15**

Paver & Roadbuilder - Laborer

Paving and road construction work, regardless of material used, including but not limited to preparation of job sites, removal of old surfaces, asphalt and/or concrete, by whatever method, including but not limited to milling; laying of concrete; laying of asphalt for temporary, patchwork, and utility paving (but not production paving); site preparation and incidental work before the installation of rubberized materials and similar surfaces; installation and repair of temporary construction fencing; slurry seal coating, maintenance of safety surfaces; play equipment installation, and other related work.

Effective Period: 7/1/2014 - 6/30/2015

Wage Rate per Hour: **\$40.32**

Supplemental Benefit Rate per Hour: **\$35.15**

Production Paver & Roadbuilder - Screed Person

(Production paving is asphalt paving when using a paving machine or on a project where a paving machine is traditionally used)

Adjustment of paving machinery on production paving jobs.

Effective Period: 7/1/2014 - 6/30/2015

Wage Rate per Hour: **\$45.24**

Supplemental Benefit Rate per Hour: **\$35.15**

OFFICE OF THE COMPTROLLER, CITY OF NEW YORK
§220 PREVAILING WAGE SCHEDULE

Production Paver & Roadbuilder - Raker

Effective Period: 7/1/2014 - 6/30/2015

Wage Rate per Hour: **\$44.73**

Supplemental Benefit Rate per Hour: **\$35.15**

Production Paver & Roadbuilder - Shoveler

General laborer (except removal of surfaces - see Paver and Roadbuilder-Laborer) including but not limited to tamper, AC paint and liquid tar work.

Effective Period: 7/1/2014 - 6/30/2015

Wage Rate per Hour: **\$41.44**

Supplemental Benefit Rate per Hour: **\$35.15**

Overtime Description

Veteran's Day is a Paid Holiday for employees working on production paving.

If an employee works New Year's Day or Christmas Day, they receive the single time rate plus 25%.

Employees who work on a holiday listed below receive the straight time rate plus one day's pay for the holiday.

Overtime

Time and one half the regular rate after an 8 hour day.

Time and one half the regular rate for Saturday.

Double time the regular rate for Sunday.

Paid Holidays

Memorial Day

Independence Day

Labor Day

Presidential Election Day

Thanksgiving Day

Shift Rates

When two shifts are employed, the work period for each shift shall be a continuous eight (8) hours. When three shifts are employed, each shift will work seven and one half (7 ½) hours but will be paid for eight (8) hours since only one half (1/2) hour is allowed for meal time.

When two or more shifts are employed, single time will be paid for each shift.

Night Work - On night work, the first eight (8) hours of work will be paid for at the single time rate, except that production paving work shall be paid at 15% over the single time rate for the screed person, rakers and shovelers directly involved only. All other workers will be exempt. Hours worked over eight (8) hours during said shift shall be paid for at the time and one-half rate.

(Local #1010)

OFFICE OF THE COMPTROLLER, CITY OF NEW YORK
\$220 PREVAILING WAGE SCHEDULE

PLASTERER

Plasterer

Effective Period: 7/1/2014 - 6/30/2015

Wage Rate per Hour: \$42.43

Supplemental Benefit Rate per Hour: \$27.95

Overtime

Time and one half the regular rate after a 7 hour day.

Time and one half the regular rate for Saturday.

Double time the regular rate for Sunday.

Saturday may be used as a make-up day at straight time when a day is lost during that week to inclement weather.

Overtime Holidays

Double time the regular rate for work on the following holiday(s).

New Year's Day

Martin Luther King Jr. Day

President's Day

Good Friday

Memorial Day

Independence Day

Labor Day

Columbus Day

Presidential Election Day

Thanksgiving Day

Christmas Day

Paid Holidays

None

Shift Rates

When it is not possible to conduct alteration work during regular work hours, in a building occupied by tenants, said work shall proceed on a shift basis: however work over seven (7) hours in any twenty four (24) hour period, the time after seven (7) hours shall be considered overtime.

The second shift shall start at a time between 3:30 p.m. and 7:00 p.m. and shall consist of seven (7) working hours and shall receive eight (8) hours of wages and benefits at the straight time rate. The workers on the second shift shall be allowed one-half (1/2) hour to eat with this time being included in the seven (7) hours of work.

(Local #530)

PLASTERER - TENDER

Plasterer - Tender

Effective Period: 7/1/2014 - 6/30/2015

OFFICE OF THE COMPTROLLER, CITY OF NEW YORK
§220 PREVAILING WAGE SCHEDULE

Wage Rate per Hour: **\$35.53**
Supplemental Benefit Rate per Hour: **\$26.31**

Overtime

Time and one half the regular rate after an 8 hour day.
Time and one half the regular rate for Saturday.
Double time the regular rate for Sunday.
Saturday may be used as a make-up day at straight time when a day is lost during that week to inclement weather.

Overtime Holidays

Double time the regular rate for work on the following holiday(s).
New Year's Day
Washington's Birthday
Memorial Day
Independence Day
Labor Day
Presidential Election Day
Thanksgiving Day
Christmas Day

Paid Holidays

None

Shift Rates

When work commences outside regular work hours, workers receive an hour additional (differential) wage and supplement payment. Eight hours pay for seven hours work or nine hours pay for eight hours work.

(Mason Tenders District Council)

PLUMBER

Plumber

Effective Period: 7/1/2014 - 6/30/2015
Wage Rate per Hour: **\$65.27**
Supplemental Benefit Rate per Hour: **\$25.78**
Supplemental Note: Overtime supplemental benefit rate per hour: **\$40.78**

Plumber - Temporary Services

Temporary Services - When there are no Plumbers on the job site, there may be three shifts designed to cover the entire twenty-four hour period, including weekends if necessary, at the following rate straight time.

Effective Period: 7/1/2014 - 6/30/2015
Wage Rate per Hour: **\$52.24**
Supplemental Benefit Rate per Hour: **\$20.20**

OFFICE OF THE COMPTROLLER, CITY OF NEW YORK
§220 PREVAILING WAGE SCHEDULE

Overtime Description

Double time the regular rate after a 7 hour day - unless for new construction site work where the plumbing contract price is \$1.5 million or less, the hours of labor can be 8 hours per day at the employers option. On Alteration jobs when other mechanical trades at the site are working an eighth hour at straight time, then the plumber shall also work an eighth hour at straight time.

Overtime

Double time the regular time rate for Saturday.
Double time the regular rate for Sunday.

Overtime Holidays

Double time the regular rate for work on the following holiday(s).
New Year's Day
President's Day
Memorial Day
Independence Day
Labor Day
Columbus Day
Veteran's Day
Thanksgiving Day
Day after Thanksgiving
Christmas Day

Shift Rates

Shift work, when directly specified in public agency or authority documents where plumbing contract is \$8 million or less, will be permitted. 30% shift premium shall be paid for wages and fringe benefits for 4:00 pm and midnight shifts Monday to Friday. 50% shift premium shall be paid for wages and fringe benefits for 4:00 pm and midnight shift work performed on weekends. For shift work on holidays, double time wages and fringe benefits shall be paid.

(Plumbers Local #1)

PLUMBER (MECHANICAL EQUIPMENT AND SERVICE)
(Mechanical Equipment and Service work shall include any repair and/or replacement of the present plumbing system.)

Plumber

Effective Period: 7/1/2014 - 6/30/2015

Wage Rate per Hour: \$38.27

Supplemental Benefit Rate per Hour: \$12.84

Overtime

Time and one half the regular rate after an 8 hour day.

Time and one half the regular rate for Saturday.

Time and one half the regular rate for Sunday.

PUBLISH DATE: 7/1/2014

EFFECTIVE PERIOD: JULY 1, 2014 THROUGH JUNE 30, 2015

Page 65 of 84

OFFICE OF THE COMPTROLLER, CITY OF NEW YORK
§220 PREVAILING WAGE SCHEDULE

Overtime Holidays

Time and one half the regular rate for work on the following holiday(s).

New Year's Day
President's Day
Memorial Day
Independence Day
Thanksgiving Day
Day after Thanksgiving
Christmas Day

Paid Holidays

None

(Plumbers Local # 1)

**PLUMBER (RESIDENTIAL RATES FOR 1, 2 AND 3 FAMILY HOME
CONSTRUCTION)**

Effective Period: 7/1/2014 - 6/30/2015

Wage Rate per Hour: \$45.19

Supplemental Benefit Rate per Hour: \$18.79

Overtime

Double time the regular rate after an 8 hour day.
Double time the regular time rate for Saturday.
Double time the regular rate for Sunday.

Overtime Holidays

Double time the regular rate for work on the following holiday(s).

New Year's Day
President's Day
Memorial Day
Independence Day
Labor Day
Columbus Day
Veteran's Day
Thanksgiving Day
Day after Thanksgiving
Christmas Day

Paid Holidays

None

Shift Rates

30% shift premium shall be paid for wages and fringe benefits for 4:00 pm and midnight shifts Monday to Friday.
50% shift premium shall be paid for wages and fringe benefits for 4:00 pm and midnight shift work performed on weekends. For shift work on holidays, double time wages and fringe benefits shall be paid.

OFFICE OF THE COMPTROLLER, CITY OF NEW YORK
§220 PREVAILING WAGE SCHEDULE

(Plumbers Local #1)

PLUMBER: PUMP & TANK
Oil Trades (Installation and Maintenance)

Plumber - Pump & Tank

Effective Period: 7/1/2014 - 6/30/2015

Wage Rate per Hour: \$62.83

Supplemental Benefit Rate per Hour: \$21.37

Overtime

Time and one half the regular rate after an 8 hour day.

Time and one half the regular rate for Saturday.

Time and one half the regular rate for Sunday.

Overtime Holidays

Time and one half the regular rate for work on the following holiday(s).

New Year's Day

President's Day

Memorial Day

Independence Day

Labor Day

Columbus Day

Veteran's Day

Thanksgiving Day

Day after Thanksgiving

Christmas Day

Paid Holidays

None

Shift Rates

All work outside the regular workday (8:00 A.M. to 3:30 P.M.) is to be paid at time and one half the regular hourly rate

(Plumbers Local #1)

POINTER - WATERPROOFER, CAULKER MECHANIC (EXTERIOR BUILDING RENOVATION)

Pointer - Waterproofer, Caulker Mechanic

OFFICE OF THE COMPTROLLER, CITY OF NEW YORK
§220 PREVAILING WAGE SCHEDULE

Effective Period: 7/1/2014 - 6/30/2015

Wage Rate per Hour: \$47.41

Supplemental Benefit Rate per Hour: \$24.40

Overtime

Time and one half the regular rate after an 8 hour day.

Time and one half the regular rate for Saturday.

Time and one half the regular rate for Sunday.

Saturday may be used as a make-up day at straight time when a day is lost during that week to inclement weather.

Overtime Holidays

Time and one half the regular rate for work on the following holiday(s).

New Year's Day

Martin Luther King Jr. Day

President's Day

Memorial Day

Independence Day

Labor Day

Thanksgiving Day

Christmas Day

Paid Holidays

None

Shift Rates

All work outside the regular work day (an eight hour workday between the hours of 6:00 A.M. and 4:30 P.M.) is to be paid at time and one half the regular rate.

(Bricklayer District Council)

ROOFER

Roofer

Effective Period: 7/1/2014 - 6/30/2015

Wage Rate per Hour: \$40.70

Supplemental Benefit Rate per Hour: \$28.67

Overtime

Time and one half the regular rate after an 8 hour day.

Time and one half the regular rate for Saturday.

Time and one half the regular rate for Sunday.

Overtime Holidays

Time and one half the regular rate for work on the following holiday(s).

New Year's Day

OFFICE OF THE COMPTROLLER, CITY OF NEW YORK
\$220 PREVAILING WAGE SCHEDULE

President's Day
Memorial Day
Independence Day
Labor Day
Presidential Election Day
Thanksgiving Day
Christmas Day

Paid Holidays

None

Shift Rates

Second shift - Regular hourly rate plus a 10% differential. Third shift - Regular hourly rate plus a 15% differential.

(Local #8)

SANDBLASTER - STEAMBLASTER
(Exterior Building Renovation)

Sandblaster / Steamblaster

Effective Period: 7/1/2014 - 6/30/2015

Wage Rate per Hour: \$47.41

Supplemental Benefit Rate per Hour: \$24.40

Overtime

Time and one half the regular rate after an 8 hour day.

Time and one half the regular rate for Saturday.

Time and one half the regular rate for Sunday.

Saturday may be used as a make-up day at straight time when a day is lost during that week to inclement weather.

Overtime Holidays

Time and one half the regular rate for work on the following holiday(s).

New Year's Day

Martin Luther King Jr. Day

President's Day

Memorial Day

Independence Day

Labor Day

Thanksgiving Day

Christmas Day

Paid Holidays

None

Shift Rates

OFFICE OF THE COMPTROLLER, CITY OF NEW YORK
§220 PREVAILING WAGE SCHEDULE

All work outside the regular work day (an eight hour workday between the hours of 6:00 A.M. and 4:30 P.M.) is to be paid at time and one half the regular rate.

(Bricklayer District Council)

SHEET METAL WORKER

Sheet Metal Worker

Effective Period: 7/1/2014 - 6/30/2015

Wage Rate per Hour: **\$46.21**

Supplemental Benefit Rate per Hour: **\$43.89**

Supplemental Note: Supplemental benefit contributions are to be made at the applicable overtime rates.

Sheet Metal Worker - Fan Maintenance

(The temporary operation of fans or blowers in new or existing buildings for heating and/or ventilation, and/or air conditioning prior to the completion of the project.)

Effective Period: 7/1/2014 - 6/30/2015

Wage Rate per Hour: **\$36.97**

Supplemental Benefit Rate per Hour: **\$43.89**

Sheet Metal Worker - Duct Cleaner

Effective Period: 7/1/2014 - 6/30/2015

Wage Rate per Hour: **\$12.90**

Supplemental Benefit Rate per Hour: **\$8.07**

Overtime

Time and one half the regular rate after a 7 hour day.

Time and one half the regular rate for Saturday.

Double time the regular rate for Sunday.

Overtime Holidays

Double time the regular rate for work on the following holiday(s).

New Year's Day
Martin Luther King Jr. Day
President's Day
Memorial Day
Independence Day
Labor Day
Columbus Day
Veteran's Day
Thanksgiving Day
Day after Thanksgiving
Christmas Day

OFFICE OF THE COMPTROLLER, CITY OF NEW YORK
§220 PREVAILING WAGE SCHEDULE

Paid Holidays

None

Shift Rates

Work that can only be performed outside regular working hours (seven hours of work between 7:30 A.M. and 3:30 P.M.) - First shift (work between 3:30 P.M. and 11:30 P.M.) - 10% differential above the established hourly rate.
Second shift (work between 11:30 P.M. and 7:30 A.M.) - 15% differential above the established hourly rate.

For Fan Maintenance: On all full shifts of fan maintenance work the straight time hourly rate of pay will be paid for each shift, including nights, Saturdays, Sundays, and holidays. No journey person engaged in fan maintenance shall work in excess of forty (40) hours in any work week.

(Local #28)

**SHEET METAL WORKER - SPECIALTY
(Decking & Siding)**

Sheet Metal Specialty Worker

The first worker to perform this work must be paid at the rate of the Sheet Metal Worker. The second and third workers shall be paid the Specialty Worker Rate. The ratio of One Sheet Metal Worker, then Two Specialty Workers shall be utilized thereafter.

Effective Period: 7/1/2014 - 6/30/2015

Wage Rate per Hour: \$40.78

Supplemental Benefit Rate per Hour: \$23.38

Supplemental Note: Supplemental benefit contributions are to be made at the applicable overtime rates.

Overtime

Time and one half the regular rate after an 8 hour day.

Time and one half the regular rate for Saturday.

Double time the regular rate for Sunday.

Overtime Holidays

Double time the regular rate for work on the following holiday(s).

New Year's Day

Martin Luther King Jr. Day

President's Day

Memorial Day

Independence Day

Labor Day

Columbus Day

Veteran's Day

Thanksgiving Day

Christmas Day

Paid Holidays

OFFICE OF THE COMPTROLLER, CITY OF NEW YORK
§220 PREVAILING WAGE SCHEDULE

None

(Local #28)

SHIPYARD WORKER

Shipyard Mechanic - First Class

Effective Period: 7/1/2014 - 6/30/2015
Wage Rate per Hour: \$23.83
Supplemental Benefit Rate per Hour: \$2.87

Shipyard Mechanic - Second Class

Effective Period: 7/1/2014 - 6/30/2015
Wage Rate per Hour: \$15.44
Supplemental Benefit Rate per Hour: \$2.54

Shipyard Laborer - First Class

Effective Period: 7/1/2014 - 6/30/2015
Wage Rate per Hour: \$19.28
Supplemental Benefit Rate per Hour: \$2.69

Shipyard Laborer - Second Class

Effective Period: 7/1/2014 - 6/30/2015
Wage Rate per Hour: \$12.36
Supplemental Benefit Rate per Hour: \$2.43

Shipyard Dockhand - First Class

Effective Period: 7/1/2014 - 6/30/2015
Wage Rate per Hour: \$22.68
Supplemental Benefit Rate per Hour: \$2.82

Shipyard Dockhand - Second Class

Effective Period: 7/1/2014 - 6/30/2015
Wage Rate per Hour: \$14.22
Supplemental Benefit Rate per Hour: \$2.50

Overtime Description

Work performed on holiday is paid double time the regular hourly wage rate plus holiday pay.

OFFICE OF THE COMPTROLLER, CITY OF NEW YORK
§220 PREVAILING WAGE SCHEDULE

Overtime

Time and one half the regular rate after an 8 hour day.
Time and one half the regular rate for Saturday.
Double time the regular rate for Sunday.
Time and one half the regular hourly rate after 40 hours in any work week.

Paid Holidays

New Year's Day
Martin Luther King Jr. Day
President's Day
Good Friday
Memorial Day
Independence Day
Labor Day
Thanksgiving Day
Day after Thanksgiving
Christmas Day

Based on Survey Data

SIGN ERECTOR
(Sheet Metal, Plastic, Electric, and Neon)

Sign Erector

Effective Period: 7/1/2014 - 6/30/2015
Wage Rate per Hour: **\$44.20**
Supplemental Benefit Rate per Hour: **\$44.10**

Overtime

Time and one half the regular rate after a 7 hour day.
Time and one half the regular rate for Saturday.
Time and one half the regular rate for Sunday.
Time and one half the regular rate for work on the following holiday(s).

Paid Holidays

New Year's Day
Washington's Birthday
Memorial Day
Independence Day
Labor Day
Columbus Day
Election Day
Thanksgiving Day
Day after Thanksgiving
Christmas Day

OFFICE OF THE COMPTROLLER, CITY OF NEW YORK
§220 PREVAILING WAGE SCHEDULE

Shift Rates

Time and one half the regular hourly rate is to be paid for all hours worked outside the regular workday either (7:00 A.M. through 2:30 P.M.) or (8:00 A.M. through 3:30 P.M.)

(Local #137)

STEAMFITTER

Steamfitter I

Effective Period: 7/1/2014 - 6/30/2015

Wage Rate per Hour: \$53.25

Supplemental Benefit Rate per Hour: \$51.04

Supplemental Note: Overtime supplemental benefit rate: \$101.34

Overtime

Double time the regular rate after a 7 hour day.

Double time the regular time rate for Saturday.

Double time the regular rate for Sunday.

Overtime Holidays

Double time the regular rate for work on the following holiday(s).

New Year's Day

President's Day

Memorial Day

Independence Day

Labor Day

Columbus Day

Veteran's Day

Thanksgiving Day

Day after Thanksgiving

Christmas Day

Paid Holidays

None

Shift Rates

Work performed between 3:30 P.M. and 7:00 A.M. and on Saturdays, Sundays and Holidays shall be at double time the regular hourly rate and paid at the overtime supplemental benefit rate above.

Steamfitter II

For heating, ventilation, air conditioning and mechanical public works contracts with a dollar value not to exceed \$15,000,000 and for fire protection/sprinkler public works contracts not to exceed \$1,500,000.

OFFICE OF THE COMPTROLLER, CITY OF NEW YORK
§220 PREVAILING WAGE SCHEDULE

Effective Period: 7/1/2014 - 6/30/2015

Wage Rate per Hour: \$53.25

Supplemental Benefit Rate per Hour: \$51.04

Supplemental Note: Overtime supplemental benefit rate: \$101.34

Overtime

Double time the regular rate after an 8 hour day.

Double time the regular time rate for Saturday.

Double time the regular rate for Sunday.

Overtime Holidays

Double time the regular rate for work on the following holiday(s).

New Year's Day

President's Day

Memorial Day

Independence Day

Labor Day

Columbus Day

Veteran's Day

Thanksgiving Day

Day after Thanksgiving

Christmas Day

Paid Holidays

None

Shift Rates

May be performed outside of the regular workday except Saturday, Sunday and Holidays. A shift shall consist of eight working hours. All work performed in excess of eight hours shall be paid at double time. No shift shall commence after 7:00 P.M. on Friday or 7:00 P.M. the day before holidays. All work performed after 12:01 A.M. Saturday or 12:01 A.M. the day before a Holiday will be paid at double time. When shift work is performed the wage rate for regular time worked is a thirty percent premium together with fringe benefits.

On Transit Authority projects, where work is performed in the vicinity of tracks all shift work on weekends and holidays may be performed at the regular shift rates.

Local #638

STEAMFITTER - REFRIGERATION AND AIR CONDITIONER (Maintenance and Installation Service Person)

Refrigeration and Air Conditioner Mechanic

Effective Period: 7/1/2014 - 6/30/2015

Wage Rate per Hour: \$38.30

Supplemental Benefit Rate per Hour: \$12.76

OFFICE OF THE COMPTROLLER, CITY OF NEW YORK
§220 PREVAILING WAGE SCHEDULE

Refrigeration and Air Conditioner Service Person V

Effective Period: 7/1/2014 - 6/30/2015
Wage Rate per Hour: \$31.47
Supplemental Benefit Rate per Hour: \$11.55

Refrigeration and Air Conditioner Service Person IV

Effective Period: 7/1/2014 - 6/30/2015
Wage Rate per Hour: \$26.07
Supplemental Benefit Rate per Hour: \$10.52

Refrigeration and Air Conditioner Service Person III

Filter changing and maintenance thereof, oil and greasing, tower and coil cleaning, scraping and painting, general housekeeping, taking of water samples.

Effective Period: 7/1/2014 - 6/30/2015
Wage Rate per Hour: \$22.38
Supplemental Benefit Rate per Hour: \$9.76

Refrigeration and Air Conditioner Service Person II

Filter changing and maintenance thereof, oil and greasing, tower and coil cleaning, scraping and painting, general housekeeping, taking of water samples.

Effective Period: 7/1/2014 - 6/30/2015
Wage Rate per Hour: \$18.56
Supplemental Benefit Rate per Hour: \$9.06

Refrigeration and Air Conditioner Service Person I

Filter changing and maintenance thereof, oil and greasing, tower and coil cleaning, scraping and painting, general housekeeping, taking of water samples.

Effective Period: 7/1/2014 - 6/30/2015
Wage Rate per Hour: \$13.57
Supplemental Benefit Rate per Hour: \$8.30

Overtime

Time and one half the regular rate after an 8 hour day.
Time and one half the regular rate for Saturday.
Double time the regular rate for Sunday.

Overtime Holidays

Double time the regular rate for work on the following holiday(s).
New Year's Day
Independence Day
Labor Day
Veteran's Day

OFFICE OF THE COMPTROLLER, CITY OF NEW YORK
§220 PREVAILING WAGE SCHEDULE

Thanksgiving Day
Christmas Day

Double time and one half the regular rate for work on the following holiday(s).

Martin Luther King Jr. Day
President's Day
Memorial Day
Columbus Day

Paid Holidays

New Year's Day
Martin Luther King Jr. Day
President's Day
Memorial Day
Independence Day
Labor Day
Columbus Day
Veteran's Day
Thanksgiving Day
Christmas Day

(Local #638B)

STONE MASON - SETTER

Stone Mason - Setters

Effective Period: 7/1/2014 - 6/30/2015

Wage Rate per Hour: \$46.56

Supplemental Benefit Rate per Hour: \$36.40

Overtime

Time and one half the regular rate after a 7 hour day.

Time and one half the regular rate for Saturday.

Double time the regular rate for Sunday.

Overtime Holidays

Double time the regular rate for work on the following holiday(s).

New Year's Day
Washington's Birthday
Good Friday
Memorial Day
Independence Day
Labor Day
Thanksgiving Day
Christmas Day

Paid Holidays

1/2 day on Christmas Eve if work is performed in the A.M.

OFFICE OF THE COMPTROLLER, CITY OF NEW YORK
§220 PREVAILING WAGE SCHEDULE

Shift Rates

For all work outside the regular workday (8:00 A.M. to 3:30 P.M. Monday through Friday), the pay shall be straight time plus a ten percent (10%) differential.

(Bricklayers District Council)

TAPER

Drywall Taper

Effective Period: 7/1/2014 - 12/30/2014

Wage Rate per Hour: \$45.32

Supplemental Benefit Rate per Hour: \$22.66

Effective Period: 12/31/2014 - 6/30/2015

Wage Rate per Hour: \$45.82

Supplemental Benefit Rate per Hour: \$22.66

Overtime

Time and one half the regular rate after a 7 hour day.

Time and one half the regular rate for Saturday.

Time and one half the regular rate for Sunday.

Overtime Holidays

Time and one half the regular rate for work on the following holiday(s).

New Year's Day

Martin Luther King Jr. Day

President's Day

Good Friday

Memorial Day

Independence Day

Labor Day

Columbus Day

Thanksgiving Day

Christmas Day

Paid Holidays

Any worker who reports to work on Christmas Eve or New Year's Eve pursuant to his employer's instruction shall be entitled to three (3) hours afternoon pay without working.

Shift Rates

Time and one half the regular rate outside the regular work hours (8:00 A.M. through 3:30 P.M.)

(Local #1974)

OFFICE OF THE COMPTROLLER, CITY OF NEW YORK
§220 PREVAILING WAGE SCHEDULE

**TELECOMMUNICATION WORKER
(Voice Installation Only)**

Telecommunication Worker

Effective Period: 7/1/2014 - 6/30/2015

Wage Rate per Hour: **\$39.18**

Supplemental Benefit Rate per Hour: **\$13.19**

Supplemental Note: The above rate applies for Manhattan, Bronx, Brooklyn, Queens. \$12.64 for Staten Island only.

Overtime

Time and one half the regular rate after a 7 hour day.

Time and one half the regular rate for Saturday.

Time and one half the regular rate for Sunday.

Overtime Holidays

Time and one half the regular rate for work on the following holiday(s).

New Year's Day

Lincoln's Birthday

Washington's Birthday

Memorial Day

Independence Day

Labor Day

Columbus Day

Election Day

Veteran's Day

Thanksgiving Day

Christmas Day

Paid Holidays

New Year's Day

Lincoln's Birthday

Washington's Birthday

Memorial Day

Independence Day

Labor Day

Columbus Day

Election Day

Veteran's Day

Thanksgiving Day

Christmas Day

Employees have the option of observing either Martin Luther King's Birthday or the day after Thanksgiving instead of Lincoln's Birthday

Shift Rates

For any workday that starts before 8A.M. or ends after 6P.M. there is a 10% differential for the applicable worker's hourly rate.

OFFICE OF THE COMPTROLLER, CITY OF NEW YORK
§220 PREVAILING WAGE SCHEDULE

Vacation

After 6 months.....one week.
After 12 months but less than 7 years.....two weeks.
After 7 or more but less than 15 years.....three weeks.
After 15 years or more but less than 25 years.....four weeks.

(C.W.A.)

TILE FINISHER

Tile Finisher

Effective Period: 7/1/2014 - 6/30/2015
Wage Rate per Hour: \$38.80
Supplemental Benefit Rate per Hour: \$28.03

Overtime

Time and one half the regular rate after a 7 hour day.
Time and one half the regular rate for Saturday.
Double time the regular rate for Sunday.

Overtime Holidays

Double time the regular rate for work on the following holiday(s).
New Year's Day
President's Day
Good Friday
Memorial Day
Independence Day
Labor Day
Columbus Day
Veteran's Day
Thanksgiving Day
Day after Thanksgiving
Christmas Day

Paid Holidays

None

Shift Rates

Off shift work day (work performed outside the regular 8:00 A.M. to 3:30 P.M. workday): shift differential of one and one quarter (1¼) times the regular straight time rate of pay for the seven hours of actual off-shift work.

(Local #7)

TILE LAYER - SETTER

OFFICE OF THE COMPTROLLER, CITY OF NEW YORK
§220 PREVAILING WAGE SCHEDULE

Tile Layer - Setter

Effective Period: 7/1/2014 - 6/30/2015

Wage Rate per Hour: **\$49.88**

Supplemental Benefit Rate per Hour: **\$32.36**

Overtime

Time and one half the regular rate after a 7 hour day.

Time and one half the regular rate for Saturday.

Double time the regular rate for Sunday.

Overtime Holidays

Double time the regular rate for work on the following holiday(s).

New Year's Day

President's Day

Good Friday

Memorial Day

Independence Day

Labor Day

Columbus Day

Veteran's Day

Thanksgiving Day

Day after Thanksgiving

Christmas Day

Shift Rates

Off shift work day (work performed outside the regular 8:00 A.M. to 3:30 P.M. workday): shift differential of one and one quarter (1¼) times the regular straight time rate of pay for the seven hours of actual off-shift work.

(Local #7)

TIMBERPERSON

Timberperson

Effective Period: 7/1/2014 - 6/30/2015

Wage Rate per Hour: **\$44.33**

Supplemental Benefit Rate per Hour: **\$45.39**

Overtime

Time and one half the regular rate after an 8 hour day.

Time and one half the regular rate for Saturday.

Double time the regular rate for Sunday.

Saturday may be used as a make-up day at straight time when a day is lost during that week to inclement weather.

Time and one half the regular hourly rate after 40 hours in any work week.

Overtime Holidays

OFFICE OF THE COMPTROLLER, CITY OF NEW YORK
§220 PREVAILING WAGE SCHEDULE

Double time the regular rate for work on the following holiday(s).

New Year's Day
President's Day
Memorial Day
Independence Day
Labor Day
Columbus Day
Presidential Election Day
Thanksgiving Day
Christmas Day

Paid Holidays

None

Shift Rates

Off shift work commencing between 5:00 P.M. and 11:00 P.M. shall work eight and one half hours allowing for one half hour for lunch. The wage rate shall be 113% of the straight time hourly wage rate.

(Local #1536)

TUNNEL WORKER

Blasters, Mucking Machine Operators (Compressed Air Rates)

Effective Period: 7/1/2014 - 6/30/2015
Wage Rate per Hour: \$54.20
Supplemental Benefit Rate per Hour: \$48.20

Tunnel Workers (Compressed Air Rates)

Effective Period: 7/1/2014 - 6/30/2015
Wage Rate per Hour: \$52.31
Supplemental Benefit Rate per Hour: \$46.59

Top Nipper (Compressed Air Rates)

Effective Period: 7/1/2014 - 6/30/2015
Wage Rate per Hour: \$51.35
Supplemental Benefit Rate per Hour: \$45.78

Outside Lock Tender, Outside Gauge Tender, Muck Lock Tender (Compressed Air Rates)

Effective Period: 7/1/2014 - 6/30/2015
Wage Rate per Hour: \$50.42
Supplemental Benefit Rate per Hour: \$44.91

OFFICE OF THE COMPTROLLER, CITY OF NEW YORK
§220 PREVAILING WAGE SCHEDULE

Bottom Bell & Top Bell Signal Person: Shaft Person (Compressed Air Rates)

Effective Period: 7/1/2014 - 6/30/2015
Wage Rate per Hour: \$50.42
Supplemental Benefit Rate per Hour: \$44.92

Changehouse Attendant: Powder Watchperson (Compressed Air Rates)

Effective Period: 7/1/2014 - 6/30/2015
Wage Rate per Hour: \$43.94
Supplemental Benefit Rate per Hour: \$42.55

Blasters (Free Air Rates)

Effective Period: 7/1/2014 - 6/30/2015
Wage Rate per Hour: \$51.72
Supplemental Benefit Rate per Hour: \$46.03

Tunnel Workers (Free Air Rates)

Effective Period: 7/1/2014 - 6/30/2015
Wage Rate per Hour: \$49.48
Supplemental Benefit Rate per Hour: \$44.06

All Others (Free Air Rates)

Effective Period: 7/1/2014 - 6/30/2015
Wage Rate per Hour: \$45.73
Supplemental Benefit Rate per Hour: \$40.75

Microtunneling (Free Air Rates)

Effective Period: 7/1/2014 - 6/30/2015
Wage Rate per Hour: \$39.58
Supplemental Benefit Rate per Hour: \$35.25

Overtime Description

For Repair-Maintenance Work on Existing Equipment and Facilities - Time and one half the regular rate after a 7 hour day, or for Saturday, or for Sunday. Double time the regular rate for work on a holiday.
For Small-Bore Micro Tunneling Machines - Time and one-half the regular rate shall be paid for all overtime.

Overtime

Double time the regular rate after an 8 hour day.
Double time the regular time rate for Saturday.
Double time the regular rate for Sunday.
Double time the regular rate for work on the following holiday(s).

Paid Holidays

New Year's Day

OFFICE OF THE COMPTROLLER, CITY OF NEW YORK
§220 PREVAILING WAGE SCHEDULE

Lincoln's Birthday
President's Day
Memorial Day
Independence Day
Labor Day
Columbus Day
Election Day
Veteran's Day
Thanksgiving Day
Christmas Day

(Local #147)

**WELDER
TO BE PAID AT THE RATE OF THE JOURNEYPERSON IN THE TRADE
PERFORMING THE WORK.**

OFFICE OF THE COMPTROLLER

CITY OF NEW YORK

220 APPRENTICESHIP PREVAILING WAGE SCHEDULE

APPENDIX

Pursuant to Labor Law §220 (3-e), only apprentices who are individually registered in a bona fide program to which the employer contractor is a participant and registered with the New York State Department of Labor, may be employed on a public work project.

Any employee listed on a payroll at an apprentice wage rate, who is not registered as above, shall be paid the journey person wage rate for the classification of work he actually performed.

Apprentice ratios are established to ensure the proper safety, training and supervision of apprentices. A ratio establishes the number of journey workers required for each apprentice in a program and on a job site. Ratios are interpreted as follows: in the case of a 1:1, 1:4 ratio, there must be one journey worker for the first apprentice, and four additional journey workers for each subsequent apprentice.

TABLE OF CONTENTS

<u>CLASSIFICATION</u>	<u>PAGE</u>
ASBESTOS HANDLER.....	3
BOILERMAKER.....	3
BRICKLAYER.....	4
CARPENTER.....	5
CEMENT MASON.....	6
CEMENT AND CONCRETE WORKER.....	6
DERRICKPERSON & RIGGER (STONE).....	7
DOCKBUILDER/PILE DRIVER.....	8
ELECTRICIAN.....	8
ELEVATOR CONSTRUCTOR.....	11
ELEVATOR REPAIR & MAINTENANCE.....	12
ENGINEER.....	13
ENGINEER - OPERATING.....	14
FLOOR COVERER.....	14
GLAZIER.....	15
HEAT & FROST INSULATOR.....	16
HOUSE WRECKER.....	17
IRON WORKER - ORNAMENTAL.....	17
IRON WORKER - STRUCTURAL.....	18
LABORER (FOUNDATION, CONCRETE, EXCAVATING, STREET PIPE LAYER & COMMON)....	19
MARBLE MECHANICS.....	19
MASON TENDER.....	21
METALLIC LATHER.....	21
MILLWRIGHT.....	22
PAVER AND ROADBUILDER.....	23
PAINTER.....	24
PAINTER - STRUCTURAL STEEL.....	24
PLASTERER.....	25
PLUMBER.....	26
POINTER - WATERPROOFER, CAULKER MECHANIC (EXTERIOR BUILDING RENOVATION) .	27
ROOFER.....	27
SHEET METAL WORKER.....	28
SIGN ERECTOR.....	29
STEAMFITTER.....	31
STONE MASON - SETTER.....	31
TAPER.....	32
TILE LAYER - SETTER.....	33
TIMBERPERSON.....	33

ASBESTOS HANDLER

(Ratio of Apprentice Journeyman: 1 to 1, 1 to 3)

Asbestos Handler (First 1000 Hours)

Effective Period: 7/1/2014 - 6/30/2015
Wage Rate Per Hour: 78% of Journeyman's rate
Supplemental Benefit Rate Per Hour: \$15.45

Asbestos Handler (Second 1000 Hours)

Effective Period: 7/1/2014 - 6/30/2015
Wage Rate Per Hour: 80% of Journeyman's rate
Supplemental Benefit Rate Per Hour: \$15.45

Asbestos Handler (Third 1000 Hours)

Effective Period: 7/1/2014 - 6/30/2015
Wage Rate Per Hour: 83% of Journeyman's rate
Supplemental Benefit Rate Per Hour: \$15.45

Asbestos Handler (Fourth 1000 Hours)

Effective Period: 7/1/2014 - 6/30/2015
Wage Rate Per Hour: 89% of Journeyman's rate
Supplemental Benefit Rate Per Hour: \$15.45

(Local #78)

BOILERMAKER

(Ratio of Apprentice to Journeyman: 1 to 1, 1 to 3)

Boilermaker (First Year)

Effective Period: 7/1/2014 - 6/30/2015
Wage Rate Per Hour: 65% of Journeyman's rate
Supplemental Benefit Rate Per Hour: \$29.74

Boilermaker (Second Year: 1st Six Months)

Effective Period: 7/1/2014 - 6/30/2015
Wage Rate Per Hour: 75% of Journeyman's rate
Supplemental Benefit Rate Per Hour: \$31.40

OFFICE OF THE COMPTROLLER, CITY OF NEW YORK
§220 APPRENTICESHIP PREVAILING WAGE SCHEDULE

Boilermaker (Second Year: 2nd Six Months)

Effective Period: 7/1/2014 - 6/30/2015
Wage Rate Per Hour: 75% of Journeyperson's rate
Supplemental Benefit Rate Per Hour: \$33.05

Boilermaker (Third Year: 1st Six Months)

Effective Period: 7/1/2014 - 6/30/2015
Wage Rate Per Hour: 80% of Journeyperson's rat
Supplemental Benefit Rate Per Hour: \$34.69

Boilermaker (Third Year: 2nd Six Months)

Effective Period: 7/1/2014 - 6/30/2015
Wage Rate Per Hour: 85% of Journeyperson's rate
Supplemental Benefit Rate Per Hour: \$36.34

Boilermaker (Fourth Year: 1st Six Months)

Effective Period: 7/1/2014 - 6/30/2015
Wage Rate Per Hour: 90% of Journeyperson's rate
Supplemental Benefit Rate Per Hour: \$38.00

Boilermaker (Fourth Year: 2nd Six Months)

Effective Period: 7/1/2014 - 6/30/2015
Wage Rate Per Hour: 95% of Journeyperson's rate
Supplemental Benefit Rate Per Hour: \$39.65

(Local #5)

BRICKLAYER

(Ratio of Apprentice to Journeyperson: 1 to 1, 1 to 4)

Bricklayer (First 750 Hours)

Effective Period: 7/1/2014 - 6/30/2015
Wage Rate Per Hour: 50% of Journeyperson's rate
Supplemental Benefit Rate Per Hour: \$17.10

Bricklayer (Second 750 Hours)

Effective Period: 7/1/2014 - 6/30/2015
Wage Rate Per Hour: 60% of Journeyperson's rate

OFFICE OF THE COMPTROLLER, CITY OF NEW YORK
\$220 APPRENTICESHIP PREVAILING WAGE SCHEDULE

Supplemental Benefit Rate Per Hour: \$17.10

Bricklayer (Third 750 Hours)

Effective Period: 7/1/2014 - 6/30/2015
Wage Rate Per Hour: 70% of Journeyperson's rate
Supplemental Benefit Rate Per Hour: \$17.10

Bricklayer (Fourth 750 Hours)

Effective Period: 7/1/2014 - 6/30/2015
Wage Rate Per Hour: 80% of Journeyperson's rate
Supplemental Benefit Rate Per Hour: \$17.10

Bricklayer (Fifth 750 Hours)

Effective Period: 7/1/2014 - 6/30/2015
Wage Rate Per Hour: 90% of Journeyperson's rate
Supplemental Benefit Rate Per Hour: \$17.10

Bricklayer (Sixth 750 Hours)

Effective Period: 7/1/2014 - 6/30/2015
Wage Rate Per Hour: 95% of Journeyperson's rate
Supplemental Benefit Rate Per Hour: \$17.10

(Bricklayer District Council)

CARPENTER

(Ratio of Apprentice to Journeyperson: 1 to 1, 1 to 4)

Carpenter (First Year)

Effective Period: 7/1/2014 - 6/30/2015
Wage Rate Per Hour: 40% of Journeyperson's rate
Supplemental Benefit Rate Per Hour: \$30.25

Carpenter (Second Year)

Effective Period: 7/1/2014 - 6/30/2015
Wage Rate Per Hour: 50% of Journeyperson's rate
Supplemental Benefit Rate Per Hour: \$30.25

Carpenter (Third Year)

Effective Period: 7/1/2014 - 6/30/2015

OFFICE OF THE COMPTROLLER, CITY OF NEW YORK
\$220 APPRENTICESHIP PREVAILING WAGE SCHEDULE

Wage Rate Per Hour: 65% of Journeyman's rate
Supplemental Benefit Rate Per Hour: \$30.25

Carpenter (Fourth Year)

Effective Period: 7/1/2014 - 6/30/2015
Wage Rate Per Hour: 80% of Journeyman's rate
Supplemental Benefit Rate Per Hour: \$30.25

(Carpenters District Council)

CEMENT MASON

(Ratio of Apprentice to Journeyman: 1 to 1, 1 to 4)

Cement Mason (First Year)

Effective Period: 7/1/2014 - 6/30/2015
Wage and Supplemental Rate Per Hour: 50% of Journeyman's Rate

Cement Mason (Second Year)

Effective Period: 7/1/2014 - 6/30/2015
Wage and Supplemental Rate Per Hour: 60% of Journeyman's Rate

Cement Mason (Third Year)

Effective Period: 7/1/2014 - 6/30/2015
Wage and Supplemental Rate Per Hour: 70% of Journeyman's Rate

(Local #780)

CEMENT AND CONCRETE WORKER

(Ratio of Apprentice to Journeyman: 1 to 1, 1 to 3)

Cement & Concrete Worker (0 - 500 hours)

Effective Period: 7/1/2014 - 6/30/2015
Wage Rate Per Hour: 50% of Journeyman's rate
Supplemental Benefit Rate Per Hour: \$18.04

Cement & Concrete Worker (501 - 1000 hours)

OFFICE OF THE COMPTROLLER, CITY OF NEW YORK
\$220 APPRENTICESHIP PREVAILING WAGE SCHEDULE

Effective Period: 7/1/2014 - 6/30/2015
Wage Rate Per Hour: 65% of Journeyperson's rate
Supplemental Benefit Rate Per Hour: \$18.87

Cement & Concrete Worker (1001 - 2000 hours)

Effective Period: 7/1/2014 - 6/30/2015
Wage Rate Per Hour: 65% of Journeyperson's rate
Supplemental Benefit Rate Per Hour: \$24.25

Cement & Concrete Worker (2001 - 4000 hours)

Effective Period: 7/1/2014 - 6/30/2015
Wage Rate Per Hour: 80% of Journeyperson's rate
Supplemental Benefit Rate Per Hour: \$25.07

(Cement Concrete Workers District Council)

**DERRICKPERSON & RIGGER (STONE)
(Ratio of Apprentice to Journeyperson: 1 to 1, 1 to 4)**

Derrickperson & Rigger (stone) - First Year

Effective Period: 7/1/2014 - 6/30/2015
Wage Rate Per Hour: 50% of Journeyperson's rate
Supplemental Benefit Rate Per Hour: 50% of Journeyperson's rate

Derrickperson & Rigger (stone) - Second Year: 1st Six Months

Effective Period: 7/1/2014 - 6/30/2015
Wage Rate Per Hour: 70% of Journeyperson's rate
Supplemental Benefit Rate Per Hour: 75% of Journeyperson's rate

Derrickperson & Rigger (stone) - Second Year: 2nd Six Months

Effective Period: 7/1/2014 - 6/30/2015
Wage Rate Per Hour: 80% of Journeyperson's rate
Supplemental Benefit Rate Per Hour: 75% of Journeyperson's rate

Derrickperson & Rigger (stone) - Third Year

Effective Period: 7/1/2014 - 6/30/2015
Wage Rate Per Hour: 90% of Journeyperson's rate
Supplemental Benefit Rate Per Hour: 75% of Journeyperson's rate

OFFICE OF THE COMPTROLLER, CITY OF NEW YORK
§220 APPRENTICESHIP PREVAILING WAGE SCHEDULE

(Local #197)

DOCKBUILDER/PILE DRIVER
(Ratio of Apprentice to Journeyman: 1 to 1, 1 to 6)

Dockbuilder/Pile Driver (First Year)

Effective Period: 7/1/2014 - 6/30/2015
Wage Rate Per Hour: 40% of Journeyman's rate
Supplemental Benefit Rate Per Hour: \$31.26

Dockbuilder/Pile Driver (Second Year)

Effective Period: 7/1/2014 - 6/30/2015
Wage Rate Per Hour: 50% of Journeyman's rate
Supplemental Benefit Rate Per Hour: \$31.26

Dockbuilder/Pile Driver (Third Year)

Effective Period: 7/1/2014 - 6/30/2015
Wage Rate Per Hour: 65% of Journeyman's rate
Supplemental Benefit Rate Per Hour: \$31.26

Dockbuilder/Pile Driver (Fourth Year)

Effective Period: 7/1/2014 - 6/30/2015
Wage Rate Per Hour: 80% of Journeyman's rate
Supplemental Benefit Rate Per Hour: \$31.26

(Carpenters District Council)

ELECTRICIAN
(Ratio of Apprentice to Journeyman: 1 to 1, 1 to 3)

Electrician (First Term: 0-6 Months)

Effective Period: 7/1/2014 - 5/12/2015
Wage Rate per Hour: \$12.50
Supplemental Benefit Rate per Hour: \$11.10
Overtime Supplemental Rate Per Hour: \$11.93

OFFICE OF THE COMPTROLLER, CITY OF NEW YORK
\$220 APPRENTICESHIP PREVAILING WAGE SCHEDULE

Effective Period: 5/13/2015 - 6/30/2015
Wage Rate per Hour: \$13.00
Supplemental Benefit Rate per Hour: \$11.61
Overtime Supplemental Rate Per Hour: \$12.47

Electrician (First Term: 7-12 Months)

Effective Period: 7/1/2014 - 5/12/2015
Wage Rate per Hour: \$13.50
Supplemental Benefit Rate per Hour: \$11.62
Overtime Supplemental Rate Per Hour: \$12.51

Effective Period: 5/13/2015 - 6/30/2015
Wage Rate per Hour: \$14.00
Supplemental Benefit Rate per Hour: \$12.12
Overtime Supplemental Rate Per Hour: \$13.04

Electrician (Second Term: 0-6 Months)

Effective Period: 7/1/2014 - 5/12/2015
Wage Rate per Hour: \$14.50
Supplemental Benefit Rate per Hour: \$12.13
Overtime Supplemental Rate Per Hour: \$13.08

Effective Period: 5/13/2015 - 6/30/2015
Wage Rate per Hour: \$15.00
Supplemental Benefit Rate per Hour: \$12.63
Overtime Supplemental Rate Per Hour: \$13.62

Electrician (Second Term: 7-12 Months)

Effective Period: 7/1/2014 - 5/12/2015
Wage Rate per Hour: \$15.50
Supplemental Benefit Rate per Hour: \$12.64
Overtime Supplemental Rate Per Hour: \$13.66

Effective Period: 5/13/2015 - 6/30/2015
Wage Rate per Hour: \$16.00
Supplemental Benefit Rate per Hour: \$13.14
Overtime Supplemental Rate Per Hour: \$14.19

Electrician (Third Term: 0-6 Months)

Effective Period: 7/1/2014 - 5/12/2015
Wage Rate per Hour: \$16.50
Supplemental Benefit Rate per Hour: \$13.15
Overtime Supplemental Rate Per Hour: \$14.23

Effective Period: 5/13/2015 - 6/30/2015
Wage Rate per Hour: \$17.00

OFFICE OF THE COMPTROLLER, CITY OF NEW YORK
§220 APPRENTICESHIP PREVAILING WAGE SCHEDULE

Supplemental Benefit Rate per Hour: \$13.65
Overtime Supplemental Rate Per Hour: \$14.77

Electrician (Third Term: 7-12 Months)

Effective Period: 7/1/2014 - 5/12/2015
Wage Rate per Hour: \$17.50
Supplemental Benefit Rate per Hour: \$13.65
Overtime Supplemental Rate Per Hour: \$14.81

Effective Period: 5/13/2015 - 6/30/2015
Wage Rate per Hour: \$18.00
Supplemental Benefit Rate per Hour: \$14.16
Overtime Supplemental Rate Per Hour: \$15.34

Electrician (Fourth Term: 0-6 Months)

Effective Period: 7/1/2014 - 5/12/2015
Wage Rate per Hour: \$18.50
Supplemental Benefit Rate per Hour: \$14.16
Overtime Supplemental Rate Per Hour: \$15.38

Effective Period: 5/13/2015 - 6/30/2015
Wage Rate per Hour: \$19.00
Supplemental Benefit Rate per Hour: \$14.67
Overtime Supplemental Rate Per Hour: \$15.92

Electrician (Fourth Term: 7-12 Months)

Effective Period: 7/1/2014 - 5/12/2015
Wage Rate per Hour: \$20.50
Supplemental Benefit Rate per Hour: \$15.18
Overtime Supplemental Rate Per Hour: \$16.53

Effective Period: 5/13/2015 - 6/30/2015
Wage Rate per Hour: \$21.00
Supplemental Benefit Rate per Hour: \$15.68
Overtime Supplemental Rate Per Hour: \$17.07

Electrician (Fifth Term: 0-12 Months - Hired on or after 5/10/07)

Effective Period: 7/1/2014 - 5/12/2015
Wage Rate per Hour: \$22.50
Supplemental Benefit Rate per Hour: \$18.06
Overtime Supplemental Rate Per Hour: \$19.47

Effective Period: 5/13/2015 - 6/30/2015
Wage Rate per Hour: \$23.00
Supplemental Benefit Rate per Hour: \$18.56
Overtime Supplemental Rate Per Hour: \$20.00

OFFICE OF THE COMPTROLLER, CITY OF NEW YORK
§220 APPRENTICESHIP PREVAILING WAGE SCHEDULE

Electrician (Fifth Term: 13-18 Months - Hired on or after 5/10/07)

Effective Period: 7/1/2014 - 5/12/2015

Wage Rate per Hour: \$27.00

Supplemental Benefit Rate per Hour: \$20.32

Overtime Supplemental Rate Per Hour: \$22.01

Effective Period: 5/13/2015 - 6/30/2015

Wage Rate per Hour: \$27.50

Supplemental Benefit Rate per Hour: \$20.82

Overtime Supplemental Rate Per Hour: \$22.54

Electrician (Fifth Term: 0-18 Months - Hired before 5/10/07)

Effective Period: 7/1/2014 - 5/12/2015

Wage Rate per Hour: \$26.30

Supplemental Benefit Rate per Hour: \$19.96

Overtime Supplemental Rate Per Hour: \$21.61

Effective Period: 5/13/2015 - 6/30/2015

Wage Rate per Hour: \$26.80

Supplemental Benefit Rate per Hour: \$20.46

Overtime Supplemental Rate Per Hour: \$22.14

Overtime Description

Overtime Wage paid at time and one half the regular rate

For "A" rated Apprentices (work in excess of 7 hours per day)

For "M" rated Apprentices (work in excess of 8 hours per day)

(Local #3)

ELEVATOR CONSTRUCTOR

(Ratio of Apprentice to Journeyman: 1 to 1, 1 to 2)

Elevator (Constructor) - First Year

Effective Period: 7/1/2014 - 3/16/2015

Wage Rate Per Hour: 50% of Journeyman's rate

Supplemental Rate Per Hour: \$25.46

Effective Period: 3/17/2015 - 6/30/2015

Wage Rate Per Hour: 50% of Journeyman's rate

Supplemental Rate Per Hour: \$26.94

OFFICE OF THE COMPTROLLER, CITY OF NEW YORK
§220 APPRENTICESHIP PREVAILING WAGE SCHEDULE

Elevator (Constructor) - Second Year

Effective Period: 7/1/2014 - 3/16/2015
Wage Rate Per Hour: 55% of Journeyperson's rate
Supplemental Rate Per Hour: \$25.86

Effective Period: 3/17/2015 - 6/30/2015
Wage Rate Per Hour: 55% of Journeyperson's rate
Supplemental Rate Per Hour: \$27.35

Elevator (Constructor) - Third Year

Effective Period: 7/1/2014 - 3/16/2015
Wage Rate Per Hour: 65% of Journeyperson's rate
Supplemental Rate Per Hour: \$26.66

Effective Period: 3/17/2015 - 6/30/2015
Wage Rate Per Hour: 65% of Journeyperson's rate
Supplemental Rate Per Hour: \$28.17

Elevator (Constructor) - Fourth Year

Effective Period: 7/1/2014 - 3/16/2015
Wage Rate Per Hour: 75% of Journeyperson's rate
Supplemental Rate Per Hour: \$27.46

Effective Period: 3/17/2015 - 6/30/2015
Wage Rate Per Hour: 75% of Journeyperson's rate
Supplemental Rate Per Hour: \$29.00

(Local #1)

**ELEVATOR REPAIR & MAINTENANCE
(Ratio of Apprentice to Journeyperson: 1 to 1, 1 to 2)**

Elevator Service/Modernization Mechanic (First Year)

Effective Period: 7/1/2014 - 3/16/2015
Wage Rate Per Hour: 50% of Journeyperson's rate
Supplemental Benefit Per Hour: \$24.85

Effective Period: 3/17/2015 - 6/30/2015
Wage Rate Per Hour: 50% of Journeyperson's rate
Supplemental Benefit Per Hour: \$26.87

Elevator Service/Modernization Mechanic (Second Year)

OFFICE OF THE COMPTROLLER, CITY OF NEW YORK
\$220 APPRENTICESHIP PREVAILING WAGE SCHEDULE

Effective Period: 7/1/2014 - 3/16/2015
Wage Rate Per Hour: 55% of Journeyman's rate
Supplemental Benefit Per Hour: \$25.24

Effective Period: 3/17/2015 - 6/30/2015
Wage Rate Per Hour: 55% of Journeyman's rate
Supplemental Benefit Per Hour: \$27.27

Elevator Service/Modernization Mechanic (Third Year)

Effective Period: 7/1/2014 - 3/16/2015
Wage Rate Per Hour: 65% of Journeyman's rate
Supplemental Benefit Per Hour: \$26.02

Effective Period: 3/17/2015 - 6/30/2015
Wage Rate Per Hour: 65% of Journeyman's rate
Supplemental Benefit Per Hour: \$28.08

Elevator Service/Modernization Mechanic (Fourth Year)

Effective Period: 7/1/2014 - 3/16/2015
Wage Rate Per Hour: 75% of Journeyman's rate
Supplemental Benefit Per Hour: \$26.81

Effective Period: 3/17/2015 - 6/30/2015
Wage Rate Per Hour: 75% of Journeyman's rate
Supplemental Benefit Per Hour: \$28.89

(Local #1)

ENGINEER
(Ratio of Apprentice to Journeyman: 1 to 1, 1 to 5)

Engineer - First Year

Effective Period: 7/1/2014 - 6/30/2015
Wage Rate per Hour: \$22.49
Supplemental Benefit Rate per Hour: \$20.68

Engineer - Second Year

Effective Period: 7/1/2014 - 6/30/2015
Wage Rate per Hour: \$28.11
Supplemental Benefit Rate per Hour: \$20.68

Engineer - Third Year

OFFICE OF THE COMPTROLLER, CITY OF NEW YORK
§220 APPRENTICESHIP PREVAILING WAGE SCHEDULE

Effective Period: 7/1/2014 - 6/30/2015
Wage Rate per Hour: \$20.92
Supplemental Benefit Rate per Hour: \$20.68

Engineer - Fourth Year

Effective Period: 7/1/2014 - 6/30/2015
Wage Rate per Hour: \$33.73
Supplemental Benefit Rate per Hour: \$20.68

(Local #15)

ENGINEER - OPERATING
(Ratio of Apprentice to Journeyman: 1 to 1, 1 to 5)

Operating Engineer - First Year

Effective Period: 7/1/2014 - 6/30/2015
Wage Rate Per Hour 40% of Journeyman's Rate
Supplemental Benefit Per Hour: \$18.60

Operating Engineer - Second Year

Effective Period: 7/1/2014 - 6/30/2015
Wage Rate Per Hour: 50% of Journeyman's Rate
Supplemental Benefit Per Hour: \$18.60

Operating Engineer - Third Year

Effective Period: 7/1/2014 - 6/30/2015
Wage Rate Per Hour: 60% of Journeyman's Rate
Supplemental Benefit Per Hour: \$18.60

(Local #14)

FLOOR COVERER
(Ratio of Apprentice to Journeyman: 1 to 1, 1 to 4)

Floor Coverer (First Year)

OFFICE OF THE COMPTROLLER, CITY OF NEW YORK
§220 APPRENTICESHIP PREVAILING WAGE SCHEDULE

Effective Period: 7/1/2014 - 6/30/2015
Wage Rate Per Hour: 40% of Journeyperson's rate
Supplemental Rate Per Hour: \$30.25

Floor Coverer (Second Year)

Effective Period: 7/1/2014 - 6/30/2015
Wage Rate Per Hour: 50% of Journeyperson's rate
Supplemental Rate Per Hour: \$30.25

Floor Coverer (Third Year)

Effective Period: 7/1/2014 - 6/30/2015
Wage Rate Per Hour: 65% of Journeyperson's rate
Supplemental Rate Per Hour: \$30.25

Floor Coverer (Fourth Year)

Effective Period: 7/1/2014 - 6/30/2015
Wage Rate Per Hour: 80% of Journeyperson's rate
Supplemental Rate Per Hour: \$30.25

(Carpenters District Council)

GLAZIER

(Ratio of Apprentice to Journeyperson: 1 to 1, 1 to 3)

Glazier (First Year)

Effective Period: 7/1/2014 - 10/31/2014
Wage Rate Per Hour: 40% of Journeyperson's rate
Supplemental Rate Per Hour: \$12.97

Effective Period: 11/1/2014 - 6/30/2015
Wage Rate Per Hour: 40% of Journeyperson's rate
Supplemental Rate Per Hour: \$13.12

Glazier (Second Year)

Effective Period: 7/1/2014 - 6/30/2015
Wage Rate Per Hour: 50% of Journeyperson's rate
Supplemental Rate Per Hour: \$22.25

Glazier (Third Year)

OFFICE OF THE COMPTROLLER, CITY OF NEW YORK
§220 APPRENTICESHIP PREVAILING WAGE SCHEDULE

Effective Period: 7/1/2014 - 10/31/2014
Wage Rate Per Hour: 60% of Journeyman's rate
Supplemental Rate Per Hour: \$24.75

Effective Period: 11/1/2014 - 6/30/2015
Wage Rate Per Hour: 60% of Journeyman's rate
Supplemental Rate Per Hour: \$25.10

Glazier (Fourth Year)

Effective Period: 7/1/2014 - 10/31/2014
Wage Rate Per Hour: 80% of Journeyman's rate
Supplemental Rate Per Hour: \$29.87

Effective Period: 11/1/2014 - 6/30/2015
Wage Rate Per Hour: 80% of Journeyman's rate
Supplemental Rate Per Hour: \$30.02

(Local #1281)

**HEAT & FROST INSULATOR
(Ratio of Apprentice to Journeyman: 1 to 1, 1 to 4)**

Heat & Frost Insulator (First Year)

Effective Period: 7/1/2014 - 6/30/2015
Wage and Supplemental Rate Per Hour: 40% of Journeyman's rate

Heat & Frost Insulator (Second Year)

Effective Period: 7/1/2014 - 6/30/2015
Wage and Supplemental Rate Per Hour: 60% of Journeyman's rate

Heat & Frost Insulator (Third Year)

Effective Period: 7/1/2014 - 6/30/2015
Wage and Supplemental Rate Per Hour: 70% of Journeyman's rate

Heat & Frost Insulator (Fourth Year)

Effective Period: 7/1/2014 - 6/30/2015
Wage and Supplemental Rate Per Hour: 80% of Journeyman's rate

(Local #12)

**HOUSE WRECKER
(TOTAL DEMOLITION)
(Ratio of Apprentice to Journeyman: 1 to 1, 1 to 3)**

House Wrecker - First Year

Effective Period: 7/1/2014 - 6/30/2015
Wage Rate per Hour: \$20.52
Supplemental Benefit Rate per Hour: \$16.60

House Wrecker - Second Year

Effective Period: 7/1/2014 - 6/30/2015
Wage Rate per Hour: \$21.67
Supplemental Benefit Rate per Hour: \$16.60

House Wrecker - Third Year

Effective Period: 7/1/2014 - 6/30/2015
Wage Rate per Hour: \$23.27
Supplemental Benefit Rate per Hour: \$16.60

House Wrecker - Fourth Year

Effective Period: 7/1/2014 - 6/30/2015
Wage Rate per Hour: \$25.83
Supplemental Benefit Rate per Hour: \$16.60

(Mason Tenders District Council)

**IRON WORKER - ORNAMENTAL
(Ratio of Apprentice to Journeyman: 1 to 1, 1 to 4)**

Iron Worker (Ornamental) - 1st Ten Months

Effective Period: 7/1/2014 - 6/30/2015
Wage Rate Per Hour: 50% of Journeyman's rate
Supplemental Rate Per Hour: \$35.15

Iron Worker (Ornamental) - 11 -16 Months

OFFICE OF THE COMPTROLLER, CITY OF NEW YORK
§220 APPRENTICESHIP PREVAILING WAGE SCHEDULE

Effective Period: 7/1/2014 - 6/30/2015
Wage Rate Per Hour: 55% of Journeyperson's rate
Supplemental Rate Per Hour: \$36.21

Iron Worker (Ornamental) - 17 - 22 Months

Effective Period: 7/1/2014 - 6/30/2015
Wage Rate Per Hour: 60% of Journeyperson's rate
Supplemental Rate Per Hour: \$37.27

Iron Worker (Ornamental) - 23 - 28 Months

Effective Period: 7/1/2014 - 6/30/2015
Wage Rate Per Hour: 70% of Journeyperson's rate
Supplemental Rate Per Hour: \$39.40

Iron Worker (Ornamental) - 29 - 36 Months

Effective Period: 7/1/2014 - 6/30/2015
Wage Rate Per Hour: 80% of Journeyperson's rate
Supplemental Rate Per Hour: \$41.52

(Local #580)

IRON WORKER - STRUCTURAL
(Ratio of Apprentice to Journeyperson: 1 to 1, 1 to 6)

Iron Worker (Structural) - 1st Six Months

Effective Period: 7/1/2014 - 6/30/2015
Wage Rate per Hour: \$24.98
Supplemental Benefit Rate per Hour: \$45.53

Iron Worker (Structural) - 7- 18 Months

Effective Period: 7/1/2014 - 6/30/2015
Wage Rate per Hour: \$25.58
Supplemental Benefit Rate per Hour: \$45.53

Iron Worker (Structural) - 19 - 36 months

Effective Period: 7/1/2014 - 6/30/2015
Wage Rate per Hour: \$26.18
Supplemental Benefit Rate per Hour: \$45.53

OFFICE OF THE COMPTROLLER, CITY OF NEW YORK
\$220 APPRENTICESHIP PREVAILING WAGE SCHEDULE

(Local #40 and #361)

LABORER (FOUNDATION, CONCRETE, EXCAVATING, STREET PIPE LAYER & COMMON)

(Ratio Apprentice to Journeyman: 1 to 1, 1 to 3)

Laborer (Foundation, Concrete, Excavating, Street Pipe Layer & Common) - First 1000 hours

Effective Period: 7/1/2014 - 6/30/2015
Wage Rate Per Hour: 50% of Journeyman's rate
Supplemental Rate Per Hour: \$34.88

Laborer (Foundation, Concrete, Excavating, Street Pipe Layer & Common) - Second 1000 hours

Effective Period: 7/1/2014 - 6/30/2015
Wage Rate Per Hour: 60% of Journeyman's rate
Supplemental Rate Per Hour: \$34.88

Laborer (Foundation, Concrete, Excavating, Street Pipe Layer & Common) - Third 1000 hours

Effective Period: 7/1/2014 - 6/30/2015
Wage Rate Per Hour: 75% of Journeyman's rate
Supplemental Rate Per Hour: \$34.88

Laborer (Foundation, Concrete, Excavating, Street Pipe Layer & Common) - Fourth 1000 hours

Effective Period: 7/1/2014 - 6/30/2015
Wage Rate Per Hour: 90% of Journeyman's rate
Supplemental Rate Per Hour: \$34.88

(Local #731)

MARBLE MECHANICS

(Ratio of Apprentice to Journeyman: 1 to 1, 1 to 4)

OFFICE OF THE COMPTROLLER, CITY OF NEW YORK
§220 APPRENTICESHIP PREVAILING WAGE SCHEDULE

Cutters & Setters - First 750 Hours

Effective Period: 7/1/2014 - 6/30/2015

Wage and Supplemental Rate Per Hour: 50% of Journeyman's rate

NO BENEFITS PAID DURING THE FIRST TWO MONTHS (PROBATIONARY PERIOD)

Cutters & Setters - Second 750 Hours

Effective Period: 7/1/2014 - 6/30/2015

Wage and Supplemental Rate Per Hour: 55% of Journeyman's rate

Cutters & Setters - Third 750 Hours

Effective Period: 7/1/2014 - 6/30/2015

Wage and Supplemental Rate Per Hour: 65% of Journeyman's rate

Cutters & Setters - Fourth 750 Hours

Effective Period: 7/1/2014 - 6/30/2015

Wage and Supplemental Rate Per Hour: 75% of Journeyman's rate

Cutters & Setters - Fifth 750 Hours

Effective Period: 7/1/2014 - 6/30/2015

Wage and Supplemental Rate Per Hour: 85% of Journeyman's rate

Cutters & Setters - Sixth 750 Hours

Effective Period: 7/1/2014 - 6/30/2015

Wage and Supplemental Rate Per Hour: 95% of Journeyman's rate

Polishers & Finishers - First 750 Hours

Effective Period: 7/1/2014 - 6/30/2015

Wage and Supplemental Rate Per Hour: 50% of Journeyman's rate

NO BENEFITS PAID DURING THE FIRST TWO MONTHS (PROBATIONARY PERIOD)

Polishers & Finishers - Second 750 Hours

Effective Period: 7/1/2014 - 6/30/2015

Wage and Supplemental Rate Per Hour: 60% of Journeyman's rate

Polishers & Finishers - Third 750 Hours

Effective Period: 7/1/2014 - 6/30/2015

Wage and Supplemental Rate Per Hour: 75% of Journeyman's rate

Polishers & Finishers - Fourth 750 Hours

OFFICE OF THE COMPTROLLER, CITY OF NEW YORK
§220 APPRENTICESHIP PREVAILING WAGE SCHEDULE

Effective Period: 7/1/2014 - 6/30/2015

Wage and Supplemental Rate Per Hour: 90% of Journeyperson's rate

(Local #7)

MASON TENDER

(Ratio of Apprentice to Journeyperson: 1 to 1, 1 to 3)

Mason Tender - First Year

Effective Period: 7/1/2014 - 6/30/2015

Wage Rate per Hour: \$20.99

Supplemental Benefit Rate per Hour: \$17.86

Mason Tender - Second Year

Effective Period: 7/1/2014 - 6/30/2015

Wage Rate per Hour: \$22.14

Supplemental Benefit Rate per Hour: \$17.86

Mason Tender - Third Year

Effective Period: 7/1/2014 - 6/30/2015

Wage Rate per Hour: \$23.84

Supplemental Benefit Rate per Hour: \$17.86

Mason Tender - Fourth Year

Effective Period: 7/1/2014 - 6/30/2015

Wage Rate per Hour: \$26.50

Supplemental Benefit Rate per Hour: \$17.86

(Local #79)

METALLIC LATHER

(Ratio of Apprentice to Journeyperson: 1 to 1, 1 to 3)

Metallic Lather (First Year -Called Prior to 6/29/11)

OFFICE OF THE COMPTROLLER, CITY OF NEW YORK
§220 APPRENTICESHIP PREVAILING WAGE SCHEDULE

Effective Period: 7/1/2014 - 6/30/2015
Wage Rate per Hour: \$28.11
Supplemental Benefit Rate per Hour: \$22.79

Metallic Lather (Second Year - Called Prior to 6/29/11)

Effective Period: 7/1/2014 - 6/30/2015
Wage Rate per Hour: \$32.71
Supplemental Benefit Rate per Hour: \$24.44

Metallic Lather (Third Year - Called Prior to 6/29/11)

Effective Period: 7/1/2014 - 6/30/2015
Wage Rate per Hour: \$37.77
Supplemental Benefit Rate per Hour: \$25.59

Metallic Lather (First Year -Called On Or After 6/29/11)

Effective Period: 7/1/2014 - 6/30/2015
Wage Rate per Hour: \$17.71
Supplemental Benefit Rate per Hour: \$19.85

Metallic Lather (Second Year - Called On Or After 6/29/11)

Effective Period: 7/1/2014 - 6/30/2015
Wage Rate per Hour: \$22.81
Supplemental Benefit Rate per Hour: \$19.85

Metallic Lather (Third Year - Called On Or After 6/29/11)

Effective Period: 7/1/2014 - 6/30/2015
Wage Rate per Hour: \$27.91
Supplemental Benefit Rate per Hour: \$19.85

(Local #46)

MILLWRIGHT
(Ratio of Apprentice to Journeyman: 1 to 1, 1 to 4)

Millwright (First Year)

Effective Period: 7/1/2014 - 6/30/2015
Wage Rate per Hour: \$26.64

OFFICE OF THE COMPTROLLER, CITY OF NEW YORK
§220 APPRENTICESHIP PREVAILING WAGE SCHEDULE

Supplemental Benefit Rate per Hour: **\$32.84**

Millwright (Second Year)

Effective Period: 7/1/2014 - 6/30/2015

Wage Rate per Hour: **\$31.49**

Supplemental Benefit Rate per Hour: **\$36.18**

Millwright (Third Year)

Effective Period: 7/1/2014 - 6/30/2015

Wage Rate per Hour: **\$36.33**

Supplemental Benefit Rate per Hour: **\$40.66**

Millwright (Fourth Year)

Effective Period: 7/1/2014 - 6/30/2015

Wage Rate per Hour: **\$46.02**

Supplemental Benefit Rate per Hour: **\$46.24**

(Local #740)

PAVER AND ROADBUILDER

(Ratio of Apprentice to Journeyman: 1 to 1, 1 to 3)

Paver and Roadbuilder - First Year (Minimum 1000 hours)

Effective Period: 7/1/2014 - 6/30/2015

Wage Rate per Hour: **\$26.61**

Supplemental Benefit Rate per Hour: **\$16.50**

Paver and Roadbuilder - Second Year (Minimum 1000 hours)

Effective Period: 7/1/2014 - 6/30/2015

Wage Rate per Hour: **\$28.22**

Supplemental Benefit Rate per Hour: **\$16.50**

(Local #1010)

OFFICE OF THE COMPTROLLER, CITY OF NEW YORK
§220 APPRENTICESHIP PREVAILING WAGE SCHEDULE

PAINTER

(Ratio of Apprentice to Journeyman: 1 to 1, 1 to 3)

Painter - Brush & Roller - First Year

Effective Period: 7/1/2014 - 6/30/2015

Wage Rate per Hour: \$15.80

Supplemental Benefit Rate per Hour: \$11.88

Painter - Brush & Roller - Second Year

Effective Period: 7/1/2014 - 6/30/2015

Wage Rate per Hour: \$19.75

Supplemental Benefit Rate per Hour: \$15.73

Painter - Brush & Roller - Third Year

Effective Period: 7/1/2014 - 6/30/2015

Wage Rate per Hour: \$23.70

Supplemental Benefit Rate per Hour: \$18.64

Painter - Brush & Roller - Fourth Year

Effective Period: 7/1/2014 - 6/30/2015

Wage Rate per Hour: \$31.60

Supplemental Benefit Rate per Hour: \$24.02

(District Council of Painters)

PAINTER - STRUCTURAL STEEL

(Ratio of Apprentice to Journeyman: 1 to 1, 1 to 3)

Painters - Structural Steel (First Year)

Effective Period: 7/1/2014 - 6/30/2015

Wage and Supplemental Rate Per Hour: 40% of Journeyman's rate

Painters - Structural Steel (Second Year)

Effective Period: 7/1/2014 - 6/30/2015

Wage and Supplemental Rate Per Hour: 60% of Journeyman's rate

OFFICE OF THE COMPTROLLER, CITY OF NEW YORK
\$220 APPRENTICESHIP PREVAILING WAGE SCHEDULE

Painters - Structural Steel (Third Year)

Effective Period: 7/1/2014 - 6/30/2015

Wage and Supplemental Rate Per Hour: 80% of Journeyman's rate

(Local #806)

PLASTERER

(Ratio of Apprentice to Journeyman: 1 to 1, 1 to 3)

Plasterer - First Year: 1st Six Months

Effective Period: 7/1/2014 - 6/30/2015

Wage Rate Per Hour: 40% of Journeyman's rate

Supplemental Rate Per Hour: \$15.76

Plasterer - First Year: 2nd Six Months

Effective Period: 7/1/2014 - 6/30/2015

Wage Rate Per Hour: 45% of Journeyman's rate

Supplemental Rate Per Hour: \$16.24

Plasterer - Second Year: 1st Six Months

Effective Period: 7/1/2014 - 6/30/2015

Wage Rate Per Hour: 55% of Journeyman's rate

Supplemental Rate Per Hour: \$18.21

Plasterer - Second Year: 2nd Six Months

Effective Period: 7/1/2014 - 6/30/2015

Wage Rate Per Hour: 60% of Journeyman's rate

Supplemental Rate Per Hour: \$19.29

Plasterer - Third Year: 1st Six Months

Effective Period: 7/1/2014 - 6/30/2015

Wage Rate Per Hour: 70% of Journeyman's rate

Supplemental Rate Per Hour: \$21.46

Plasterer - Third Year: 2nd Six Months

Effective Period: 7/1/2014 - 6/30/2015

Wage Rate Per Hour: 75% of Journeyman's rate

Supplemental Rate Per Hour: \$22.54

OFFICE OF THE COMPTROLLER, CITY OF NEW YORK
§220 APPRENTICESHIP PREVAILING WAGE SCHEDULE

(Local #530)

PLUMBER

(Ratio of Apprentice to Journeyman: 1 to 1, 1 to 3)

Plumber - First Year: 1st Six Months

Effective Period: 7/1/2014 - 6/30/2015

Wage Rate per Hour: \$14.00

Supplemental Benefit Rate per Hour: \$0.71

Plumber - First Year: 2nd Six Months

Effective Period: 7/1/2014 - 6/30/2015

Wage Rate per Hour: \$14.00

Supplemental Benefit Rate per Hour: \$2.96

Plumber - Second Year

Effective Period: 7/1/2014 - 6/30/2015

Wage Rate per Hour: \$23.87

Supplemental Benefit Rate per Hour: \$11.46

Plumber - Third Year

Effective Period: 7/1/2014 - 6/30/2015

Wage Rate per Hour: \$25.97

Supplemental Benefit Rate per Hour: \$11.46

Plumber - Fourth Year

Effective Period: 7/1/2014 - 6/30/2015

Wage Rate per Hour: \$28.82

Supplemental Benefit Rate per Hour: \$11.46

Plumber - Fifth Year: 1st Six Months

Effective Period: 7/1/2014 - 6/30/2015

Wage Rate per Hour: \$30.22

Supplemental Benefit Rate per Hour: \$11.46

Plumber - Fifth Year: 2nd Six Months

OFFICE OF THE COMPTROLLER, CITY OF NEW YORK
\$220 APPRENTICESHIP PREVAILING WAGE SCHEDULE

Effective Period: 7/1/2014 - 6/30/2015

Wage Rate per Hour: \$42.29

Supplemental Benefit Rate per Hour: \$11.46

(Plumbers Local #1)

**POINTER - WATERPROOFER, CAULKER MECHANIC (EXTERIOR BUILDING
RENOVATION)**

(Ratio of Apprentice to Journeyman: 1 to 1, 1 to 4)

Pointer - Waterproofer, Caulker Mechanic - First Year

Effective Period: 7/1/2014 - 6/30/2015

Wage Rate per Hour: \$25.01

Supplemental Benefit Rate per Hour: \$4.75

Pointer - Waterproofer, Caulker Mechanic - Second Year

Effective Period: 7/1/2014 - 6/30/2015

Wage Rate per Hour: \$27.25

Supplemental Benefit Rate per Hour: \$9.70

Pointer - Waterproofer, Caulker Mechanic - Third Year

Effective Period: 7/1/2014 - 6/30/2015

Wage Rate per Hour: \$32.24

Supplemental Benefit Rate per Hour: \$12.45

Pointer - Waterproofer, Caulker Mechanic - Fourth Year

Effective Period: 7/1/2014 - 6/30/2015

Wage Rate per Hour: \$38.66

Supplemental Benefit Rate per Hour: \$12.45

(Bricklayer District Council)

ROOFER

(Ratio of Apprentice to Journeyman: 1 to 1, 1 to 2)

OFFICE OF THE COMPTROLLER, CITY OF NEW YORK
§220 APPRENTICESHIP PREVAILING WAGE SCHEDULE

Roofer - First Year

Effective Period: 7/1/2014 - 6/30/2015
Wage and Supplemental Rate Per Hour: 35% of Journeyperson's Rate

Roofer - Second Year

Effective Period: 7/1/2014 - 6/30/2015
Wage and Supplemental Rate Per Hour: 50% of Journeyperson's Rate

Roofer - Third Year

Effective Period: 7/1/2014 - 6/30/2015
Wage and Supplemental Rate Per Hour: 60% of Journeyperson's Rate

Roofer - Fourth Year

Effective Period: 7/1/2014 - 6/30/2015
Wage and Supplemental Rate Per Hour: 75% of Journeyperson's Rate

(Local #8)

SHEET METAL WORKER
(Ratio of Apprentice to Journeyperson: 1 to 1, 1 to 3)

Sheet Metal Worker (0-6 Months)

Effective Period: 7/1/2014 - 6/30/2015
Wage Rate Per Hour: 25% of Journeyperson's rate
Supplemental Rate Per Hour: \$6.15

Sheet Metal Worker (7-18 Months)

Effective Period: 7/1/2014 - 6/30/2015
Wage Rate Per Hour: 35% of Journeyperson's rate
Supplemental Rate Per Hour: \$16.21

Sheet Metal Worker (19-30 Months)

Effective Period: 7/1/2014 - 6/30/2015
Wage Rate Per Hour: 45% of Journeyperson's rate
Supplemental Rate Per Hour: \$22.23

Sheet Metal Worker (31-36 Months)

OFFICE OF THE COMPTROLLER, CITY OF NEW YORK
\$220 APPRENTICESHIP PREVAILING WAGE SCHEDULE

Effective Period: 7/1/2014 - 6/30/2015
Wage Rate Per Hour: 55% of Journeyperson's rate
Supplemental Rate Per Hour: \$26.16

Sheet Metal Worker (37-42 Months)

Effective Period: 7/1/2014 - 6/30/2015
Wage Rate Per Hour: 60% of Journeyperson's rate
Supplemental Rate Per Hour: \$28.13

Sheet Metal Worker (43-48 Months)

Effective Period: 7/1/2014 - 6/30/2015
Wage Rate Per Hour: 70% of Journeyperson's rate
Supplemental Rate Per Hour: \$32.09

Sheet Metal Worker (49-54 Months)

Effective Period: 7/1/2014 - 6/30/2015
Wage Rate Per Hour: 75% of Journeyperson's rate
Supplemental Rate Per Hour: \$34.07

Sheet Metal Worker (55-60 Months)

Effective Period: 7/1/2014 - 6/30/2015
Wage Rate Per Hour: 80% of Journeyperson's rate
Supplemental Rate Per Hour: \$36.03

(Local #28)

SIGN ERECTOR

(Ratio of Apprentice to Journeyperson: 1 to 1, 1 to 4)

Sign Erector - First Year: 1st Six Months

Effective Period: 7/1/2014 - 6/30/2015
Wage Rate Per Hour: 35% of Journeyperson's rate
Supplemental Rate Per Hour: \$5.96

Sign Erector - First Year: 2nd Six Months

Effective Period: 7/1/2014 - 6/30/2015
Wage Rate Per Hour: 40% of Journeyperson's rate
Supplemental Rate Per Hour: \$6.75

Sign Erector - Second Year: 1st Six Months

OFFICE OF THE COMPTROLLER, CITY OF NEW YORK
§220 APPRENTICESHIP PREVAILING WAGE SCHEDULE

Effective Period: 7/1/2014 - 6/30/2015
Wage Rate Per Hour: 45% of Journeyperson's rate
Supplemental Rate Per Hour: \$7.55

Sign Erector - Second Year: 2nd Six Months

Effective Period: 7/1/2014 - 6/30/2015
Wage Rate Per Hour: 50% of Journeyperson's rate
Supplemental Rate Per Hour: \$8.34

Sign Erector - Third Year: 1st Six Months

Effective Period: 7/1/2014 - 6/30/2015
Wage Rate Per Hour: 55% of Journeyperson's rate
Supplemental Rate Per Hour: \$9.13

Sign Erector - Third Year: 2nd Six Months

Effective Period: 7/1/2014 - 6/30/2015
Wage Rate Per Hour: 60% of Journeyperson's rate
Supplemental Rate Per Hour: \$9.92

Sign Erector - Fourth Year: 1st Six Months

Effective Period: 7/1/2014 - 6/30/2015
Wage Rate Per Hour: 65% of Journeyperson's rate
Supplemental Rate Per Hour: \$10.72

Sign Erector - Fourth Year: 2nd Six Months

Effective Period: 7/1/2014 - 6/30/2015
Wage Rate Per Hour: 70% of Journeyperson's rate
Supplemental Rate Per Hour: \$11.51

Sign Erector - Fifth Year

Effective Period: 7/1/2014 - 6/30/2015
Wage Rate Per Hour: 75% of Journeyperson's rate
Supplemental Rate Per Hour: \$12.30

Sign Erector - Sixth Year

Effective Period: 7/1/2014 - 6/30/2015
Wage Rate Per Hour: 80% of Journeyperson's rate
Supplemental Rate Per Hour: \$12.30

(Local #137)

STEAMFITTER

(Ratio of Apprentice to Journeyman: 1 to 1, 1 to 3)

Steamfitter - First Year

Effective Period: 7/1/2014 - 6/30/2015

Wage Rate and Supplemental Per Hour: 40% of Journeyman's rate

Steamfitter - Second Year

Effective Period: 7/1/2014 - 6/30/2015

Wage Rate and Supplemental Rate Per Hour: 50% of Journeyman's rate.

Steamfitter - Third Year

Effective Period: 7/1/2014 - 6/30/2015

Wage Rate and Supplemental Rate per Hour: 65% of Journeyman's rate.

Steamfitter - Fourth Year

Effective Period: 7/1/2014 - 6/30/2015

Wage Rate and Supplemental Rate Per Hour: 80% of Journeyman's rate.

Steamfitter - Fifth Year

Effective Period: 7/1/2014 - 6/30/2015

Wage Rate and Supplemental Rate Per Hour: 85% of Journeyman's rate.

(Local #638)

STONE MASON - SETTER

(Ratio Apprentice of Journeyman: 1 to 1, 1 to 2)

Stone Mason - Setters - First 750 Hours

Effective Period: 7/1/2014 - 6/30/2015

Wage and Supplemental Rate Per Hour: 50% of Journeyman's rate

Stone Mason - Setters - Second 750 Hours

Effective Period: 7/1/2014 - 6/30/2015

Wage Rate Per Hour: 60% of Journeyman's rate

OFFICE OF THE COMPTROLLER, CITY OF NEW YORK
§220 APPRENTICESHIP PREVAILING WAGE SCHEDULE

Supplemental Rate Per Hour: 50% of Journeyperson's rate

Stone Mason - Setters - Third 750 Hours

Effective Period: 7/1/2014 - 6/30/2015

Wage Rate Per Hour: 70% of Journeyperson's rate

Supplemental Rate Per Hour: 50% of Journeyperson's rate

Stone Mason - Setters - Fourth 750 Hours

Effective Period: 7/1/2014 - 6/30/2015

Wage Rate Per Hour: 80% of Journeyperson's rate

Supplemental Rate Per Hour: 50% of Journeyperson's rate

Stone Mason - Setters - Fifth 750 Hours

Effective Period: 7/1/2014 - 6/30/2015

Wage Rate Per Hour: 90% of Journeyperson's rate

Supplemental Rate Per Hour: 50% of Journeyperson's rate

Stone Mason - Setters - Sixth 750 Hours

Effective Period: 7/1/2014 - 6/30/2015

Wage Rate Per Hour: 100% of Journeyperson's rate

Supplemental Rate Per Hour: 50% of Journeyperson's rate

(Bricklayers District Council)

TAPER

(Ratio of Apprentice to Journeyperson: 1 to 1, 1 to 4)

Drywall Taper - First Year

Effective Period: 7/1/2014 - 6/30/2015

Wage and Supplemental Rate Per Hour: 40% of Journeyperson's rate

Drywall Taper - Second Year

Effective Period: 7/1/2014 - 6/30/2015

Wage and Supplemental Rate Per Hour: 60% of Journeyperson's rate

Drywall Taper - Third Year

Effective Period: 7/1/2014 - 6/30/2015

Wage and Supplemental Rate Per Hour: 80% of Journeyperson's rate

OFFICE OF THE COMPTROLLER, CITY OF NEW YORK
§220 APPRENTICESHIP PREVAILING WAGE SCHEDULE

(Local #1974)

TILE LAYER - SETTER
(Ratio of Apprentice to Journeyman: 1 to 1, 1 to 4)

Tile Layer - Setter - First 750 Hours

Effective Period: 7/1/2014 - 6/30/2015
Wage and Supplemental Rate Per Hour: 50% of Journeyman's rate

Tile Layer - Setter - Second 750 Hours

Effective Period: 7/1/2014 - 6/30/2015
Wage and Supplemental Rate Per Hour: 55% of Journeyman's rate

Tile Layer - Setter - Third 750 Hours

Effective Period: 7/1/2014 - 6/30/2015
Wage and Supplemental Rate Per Hour: 65% of Journeyman's rate

Tile Layer - Setter - Fourth 750 Hours

Effective Period: 7/1/2014 - 6/30/2015
Wage and Supplemental Rate Per Hour: 75% of Journeyman's rate

Tile Layer - Setter - Fifth 750 Hours

Effective Period: 7/1/2014 - 6/30/2015
Wage and Supplemental Rate Per Hour: 85% of Journeyman's rate

Tile Layer - Setter - Sixth 750 Hours

Effective Period: 7/1/2014 - 6/30/2015
Wage and Supplemental Rate Per Hour: 95% of Journeyman's rate

(Local #7)

TIMBERPERSON
(Ratio of Apprentice to Journeyman: 1 to 1, 1 to 6)

OFFICE OF THE COMPTROLLER, CITY OF NEW YORK
§220 APPRENTICESHIP PREVAILING WAGE SCHEDULE

Timberperson - First Year

Effective Period: 7/1/2014 - 6/30/2015
Wage Rate Per Hour: 40% of Journeyperson's rate
Supplemental Rate Per Hour: \$30.89

Timberperson - Second Year

Effective Period: 7/1/2014 - 6/30/2015
Wage Rate Per Hour: 50% of Journeyperson's rate
Supplemental Rate Per Hour: \$30.89

Timberperson - Third Year

Effective Period: 7/1/2014 - 6/30/2015
Wage Rate Per Hour: 65% of Journeyperson's rate
Supplemental Rate Per Hour: \$30.89

Timberperson - Fourth Year

Effective Period: 7/1/2014 - 6/30/2015
Wage Rate Per Hour: 80% of Journeyperson's rate
Supplemental Rate Per Hour: \$30.89

(Local #1536)

OFFICE OF THE COMPTROLLER, CITY OF NEW YORK
§6-109 PREVAILING WAGE SCHEDULE

NYC ADMINISTRATIVE CODE § 6-109 SCHEDULE OF "LIVING WAGES"

Contractors who provide the following services to the City of New York must post a copy of this Living Wage Schedule at their work site(s) as required by New York City Administrative Code § 6-109:

- Building Services,
- Day Care Services,
- Food Services,
- Head Start Services,
- Homecare Services,
- Services to Persons with Cerebral Palsy, and
- Temporary Services.

In accordance with NYC Administrative Code § 6-109, the Comptroller of the City of New York promulgated this schedule of living wages for the above services on contracts for non-emergency work in excess of the small purchase limit set by the Procurement Policy Board; contracting agencies must annex this schedule to such contracts.

This schedule is a compilation of separate determinations of the prevailing rate of wage and supplements made by the Comptroller for each trade classification listed herein pursuant to New York City Administrative Code section 6-109. The source of the wage and supplement rates, whether a collective bargaining agreement, survey data or other, is listed at the end of each classification.

A city service contractor or subcontractor that provides homecare services, day care services, head start services or services to persons with cerebral palsy must pay its covered employees that directly render such services in performance of the city service contract or subcontract no less than the living wage and must provide its employees health benefits (supplemental benefits) or must supplement their hourly wage rate by an amount no less than the health benefits supplement rate. This requirement applies for each hour that the employee works performing the city service contract or subcontract.

A city service contractor or subcontractor that provides building services, food services or temporary services must pay its employees that are engaged in performing the city service contract or subcontract no less than the living wage or the prevailing wage, whichever is greater. Where the living wage is greater than the prevailing wage, the city service contractor or subcontractor must either provide its employees health benefits or must supplement their hourly wage rate by an amount no less than the health benefits supplement rate. Where the prevailing wage is greater than the living wage, the city service contractor or subcontractor must provide its employees the prevailing wage and supplements. These requirements apply for each hour that the employee works performing the city service contract or subcontract.

The appropriate schedule of living wages must be posted at all work sites pursuant to NYC Administrative Code 6-109.

OFFICE OF THE COMPTROLLER, CITY OF NEW YORK
§6-109 PREVAILING WAGE SCHEDULE

The schedule is applicable for work performed during the effective period, unless otherwise noted. You will be notified of any changes to this schedule by addenda published on our web site www.comptroller.nyc.gov. Schedules for future one-year periods will be published annually in the City Record on or about July 1st of each succeeding year and on our web site www.comptroller.nyc.gov.

The living wage rate and the health benefit supplement rate are known through June 30 of each year and those rates are listed in this schedule.

The living wage rates listed in this schedule may not include all hourly wage calculations for overtime, shift differential, Holiday, Saturday, Sunday or other premium time work. Similarly, this schedule does not set forth every living wage practice with which employers must comply.

Some of the rates in this schedule are based on collective bargaining agreements. These agreements are available for inspection by appointment. Requests for appointments may be made by calling (212) 669-4443, Monday through Friday between the hours of 9 a.m. and 5 p.m.

Answers to questions concerning prevailing wage practices may be obtained from the Classification Unit by calling (212) 669-7974. Please direct all other compliance issues to; Bureau of Labor Law, Attn: Wasyl Kinach, P.E., Office of the Comptroller, 1 Centre Street, Room 1122, New York, N.Y. 10007; Fax (212) 669-4002.

Contractors are solely responsible for maintaining original payroll records, which delineate, among other things, the hours each employee worked within a given classification. Contractors using rates and/or classifications not promulgated by the Comptroller do so at their own risk. Additionally, prior to bid, an agency's chief contracting officer must contact the Bureau of Labor Law to obtain a wage determination for a work classification not published in this schedule.

The information listed below is intended to assist you in meeting your living wage and prevailing wage obligation. Contractors are advised to review the Comptroller's Living Wage Schedule prior to submitting a bid for City work. Any wage rate error made by the contracting agency in the contract documents will not preclude a finding against the contractor for an underpayment of the applicable living wage or the applicable prevailing wage.

This schedule sets forth the living wage and benefit rates required to be annexed to and form part of the contract specifications for work covered by New York City Administrative Code § 6-109. Contractors performing such work are required to pay not less than the rates specified in this schedule for the applicable trade or occupation.

Benefits are paid for EACH HOUR WORKED unless otherwise noted.

Wasyl Kinach, P.E.
Director of Classifications
Bureau of Labor Law

OFFICE OF THE COMPTROLLER, CITY OF NEW YORK
§6-109 PREVAILING WAGE SCHEDULE

TABLE OF CONTENTS

<u>CLASSIFICATION</u>	<u>PAGE</u>
BUILDING CLEANER AND MAINTAINER (OFFICE).....	4
BUILDING CLEANER AND MAINTAINER (RESIDENTIAL).....	4
CLEANER (PARKING GARAGE)	4
DAY CARE SERVICES.....	4
FOOD SERVICE EMPLOYEES	4
GARDENER.....	5
HEAD START SERVICES	5
HOMECARE SERVICES	6
SECURITY GUARD (ARMED).....	6
SECURITY GUARD (UNARMED)	6
SERVICES TO PERSONS WITH CEREBRAL PALSY.....	6
TEMPORARY OFFICE SERVICES	7
WINDOW CLEANER	8

OFFICE OF THE COMPTROLLER, CITY OF NEW YORK
§6-109 PREVAILING WAGE SCHEDULE

BUILDING CLEANER AND MAINTAINER (OFFICE)

For the above building service classification, see the Labor Law Section 230 Schedule.

BUILDING CLEANER AND MAINTAINER (RESIDENTIAL)

For the above building service classification, see the Labor Law Section 230 Schedule.

CLEANER (PARKING GARAGE)

For the above building service classification, see the Labor Law Section 230 Schedule.

DAY CARE SERVICES

Day Care Services

'Day Care Services' means provision of day care services through the city's center-based day care program administered under contract with the city's Administration for Children's Services. No other day care programs shall be covered, including family-based day care programs administered by city-contracted day care centers.

Effective Period: 7/1/2014 - 6/30/2015

Wage Rate per Hour: \$10.00

Supplemental Benefit Rate per Hour: \$1.50

(NYC Administrative Code §6-109)

FOOD SERVICE EMPLOYEES

Cook

Effective Period: 7/1/2014 - 6/30/2015

Wage Rate per Hour: \$16.35

Supplemental Benefit Rate per Hour: \$1.63

Cafeteria Attendant

OFFICE OF THE COMPTROLLER, CITY OF NEW YORK
§6-109 PREVAILING WAGE SCHEDULE

Effective Period: 7/1/2014 - 6/30/2015
Wage Rate per Hour: \$10.41
Supplemental Benefit Rate per Hour: \$1.63

Counter Attendant

Effective Period: 7/1/2014 - 6/30/2015
Wage Rate per Hour: \$11.00
Supplemental Benefit Rate per Hour: \$1.63

Kitchen Helper / Dishwasher

Effective Period: 7/1/2014 - 6/30/2015
Wage Rate per Hour: \$9.99
Supplemental Benefit Rate per Hour: \$1.63

Overtime

Time and one half the regular hourly rate after 40 hours in any work week.

(Based on data from NYS Department of Labor Occupational Employment Statistics and US Department of Labor Bureau of Labor Statistics)

GARDENER

For the above building service classification, see the Labor Law Section 230 Schedule.

HEAD START SERVICES

Head Start Services

'Head Start Services' means provision of head start services through the city's center-based head start program administered under contract with the city's Administration for Children's Services. No other head start programs shall be covered.

Effective Period: 7/1/2014 - 6/30/2015
Wage Rate per Hour: \$10.00
Supplemental Benefit Rate per Hour: \$1.50

(NYC Administrative Code §6-109)

OFFICE OF THE COMPTROLLER, CITY OF NEW YORK
§6-109 PREVAILING WAGE SCHEDULE

HEMECARE SERVICES

Home Care Services

'Homecare Services' means the provision of homecare services under the city's Medicaid Personal Care/Home Attendant or Housekeeping Programs, including but not limited to the In-Home Services for the Elderly Programs administered by the Department for the Aging.

For homecare services provided under the Personal Care Services program, the wage and supplemental benefit rate above shall apply only as long as the state and federal government maintain their combined aggregate proportionate share of funding and approved rates for homecare services in effect as of the date of the enactment of this section.

For contractors or subcontractors providing homecare services, the supplemental benefit rate may be waived by the terms of a bona fide collective bargaining agreement with respect to employees who have never worked a minimum of eighty (80) hours per month for two consecutive months for that covered employer, but such provision may not be waived for any employee once a minimum of eighty (80) hours for two consecutive months has been achieved.

Effective Period: 7/1/2014 - 6/30/2015

Wage Rate per Hour: \$10.00

Supplemental Benefit Rate per Hour: \$1.50

(NYC Administrative Code §6-109)

SECURITY GUARD (ARMED)

For the above building service classification, see the Labor Law Section 230 Schedule.

SECURITY GUARD (UNARMED)

For the above building service classification, see the Labor Law Section 230 Schedule.

SERVICES TO PERSONS WITH CEREBRAL PALSY

Services To Person With Cerebral Palsy

'Services to Persons with Cerebral Palsy' means provision of services which enable persons with cerebral palsy and related disabilities to lead independent and productive lives through an agency that provides health care, education, employment, housing and technology resources to such persons under contract with the city or the department of education.

Effective Period: 7/1/2014 - 6/30/2015

Wage Rate per Hour: \$10.00

OFFICE OF THE COMPTROLLER, CITY OF NEW YORK
§6-109 PREVAILING WAGE SCHEDULE

Supplemental Benefit Rate per Hour: \$1.50

(NYC Administrative Code §6-109)

TEMPORARY OFFICE SERVICES

Administrative Assistant

Effective Period: 7/1/2014 - 6/30/2015

Wage Rate per Hour: \$33.29

Supplemental Benefit Rate per Hour: None

Cashier

Effective Period: 7/1/2014 - 6/30/2015

Wage Rate per Hour: \$11.50

Supplemental Benefit Rate per Hour: None

Clerk (various)

Effective Period: 7/1/2014 - 6/30/2015

Wage Rate per Hour: \$14.82

Supplemental Benefit Rate per Hour: None

Computer Assistant

Effective Period: 7/1/2014 - 6/30/2015

Wage Rate per Hour: \$19.94

Supplemental Benefit Rate per Hour: None

Data Entry Operator

Effective Period: 7/1/2014 - 6/30/2015

Wage Rate per Hour: \$16.44

Supplemental Benefit Rate per Hour: None

Receptionist

Effective Period: 7/1/2014 - 6/30/2015

Wage Rate per Hour: \$15.03

Supplemental Benefit Rate per Hour: None

Secretary (various)

Effective Period: 7/1/2014 - 6/30/2015

Wage Rate per Hour: \$19.31

OFFICE OF THE COMPTROLLER, CITY OF NEW YORK
§6-109 PREVAILING WAGE SCHEDULE

Supplemental Benefit Rate per Hour: None

Word Processor

Effective Period: 7/1/2014 - 6/30/2015

Wage Rate per Hour: **\$18.49**

Supplemental Benefit Rate per Hour: None

Overtime

Time and one half the regular hourly rate after 40 hours in any work week.

(Based on data from NYS Department of Labor Occupational Employment Statistics and US Department of Labor Bureau of Labor Statistics or NYC Administrative Code §6-109)

WINDOW CLEANER

For the above building service classification, see the Labor Law Section 230 Schedule.



Leonard A. Mancusi
SENIOR ASSISTANT COMPTROLLER

THE CITY OF NEW YORK
OFFICE OF THE COMPTROLLER
1 CENTRE STREET ROOM 1120
NEW YORK, N.Y. 10007-2341

TELEPHONE: (212) 669-362
FAX NUMBER: (212) 669-845

ALAN G. HEVESI
COMPTROLLER

MEMORANDUM

November 6, 2000

To Agency Chief Contracting Officers

From: Leonard A. Mancusi

Re: Security at Construction Sites

Prior to the enactment of Administrative Code §6-109, security guards on construction sites were not subject to prevailing wages. Security guards under the New York State labor law are covered under §230 which provides that prevailing wages are to be paid for security guards in existing buildings. §6-109 of the Administrative Code which was enacted in 1996 closed this loophole by including all security guards working pursuant to a city contract as a prevailing wage trade.

Although some construction contract boilerplate language has been amended to include §6-109, sub-contractors performing security services have advised us that they were not aware of this provision and, since traditionally, security guards were not a covered trade on construction sites, and they were not advised by a prime contractor that they would have to pay prevailing wages, they have not been doing so.

To avoid the possibility of issuing stop payments against prime contractors for the failure of their security service sub-contractors to pay

prevailing wages, we suggest that you write to all your existing security guard sub-contractors and their primes and in the future, upon approval of a security guard sub-contractor, advise the contractors of their obligation to pay prevailing wages under §6-109 of the Administrative Code.

As always, your cooperation is appreciated.

LAM:er
ACCO.SECURITY AT SITES





**Department of
Design and
Construction**

**INFRASTRUCTURE DIVISION
BUREAU OF DESIGN**

VOLUME 2 OF 3

PROJECT ID:HWQ121B4

RECONSTRUCTION OF LAKEVIEW BOULEVARD EAST

LAKEVIEW LANE - FROM BAISLEY BOULEVARD TO 122ND AVENUE
122ND AVENUE - FROM LAKEVIEW LANE TO LAKEVIEW BOULEVARD EAST
LAKEVIEW BOULEVARD EAST - FROM 122ND AVENUE TO 118TH AVENUE
118TH AVENUE - FROM LAKEVIEW BOULEVARD EAST TO LONG STREET

NEW STORM AND SANITARY SEWERS (SEQ200436) IN:

LAKEVIEW LANE - FROM BAISLEY BOULEVARD TO 122ND AVENUE
122ND AVENUE - FROM LAKEVIEW LANE TO LAKEVIEW BOULEVARD EAST
LAKEVIEW BOULEVARD EAST - FROM 122ND AVENUE TO 118TH AVENUE
119TH AVENUE - FROM LONG STREET TO 164TH STREET
164TH STREET - FROM 119TH AVENUE TO 120TH AVENUE

CAPITAL PROJECT WM-1

WATER MAIN WORK IN:

LAKEVIEW LANE - FROM BAISLEY BOULEVARD TO 122ND AVENUE
122ND AVENUE - FROM LAKEVIEW LANE TO LAKEVIEW BOULEVARD EAST
LAKEVIEW BOULEVARD EAST - FROM 122ND AVENUE TO 118TH AVENUE
118TH AVENUE - FROM LAKEVIEW BOULEVARD EAST TO LONG STREET
119TH AVENUE - FROM LONG STREET TO 164TH STREET
164TH STREET - FROM 119TH AVENUE TO 120TH AVENUE

INCLUDING STREET LIGHTING AND TRAFFIC WORK

Together With All Work Incidental Thereto

**BOROUGH OF QUEENS
CITY OF NEW YORK**

P&T II CONTRACTING CORP
85D15B0135001 / 85D2015H10024C Contractor.
Dated October 2, 2015

**APPROVED AS TO FORM
CERTIFIED AS TO LEGAL AUTHORITY**

[Signature]
Acting Corporation Counsel *S. 11. 15*

Dated May 11, 2015



**Department of
Design and
Construction**

**THE CITY OF NEW YORK
DEPARTMENT OF DESIGN AND CONSTRUCTION
DIVISION OF INFRASTRUCTURE**

30-30 THOMSON AVENUE
LONG ISLAND CITY, NEW YORK 11101-3045
TELEPHONE (718) 391-1000
WEBSITE www.nyc.gov/buildnyc

VOLUME 3 OF 3

**SCHEDULE A
ADDENDA NOS. 1 TO 6**

FOR FURNISHING ALL LABOR AND MATERIALS NECESSARY AND REQUIRED FOR:

PROJECT ID: HWQ121B4

RECONSTRUCTION OF LAKEVIEW BOULEVARD EAST

LAKEVIEW LANE - FROM BAISLEY BOULEVARD TO 122ND AVENUE
122ND AVENUE - FROM LAKEVIEW LANE TO LAKEVIEW BOULEVARD EAST
LAKEVIEW BOULEVARD EAST - FROM 122ND AVENUE TO 118TH AVENUE
118TH AVENUE - FROM LAKEVIEW BOULEVARD EAST TO LONG STREET

NEW STORM AND SANITARY SEWERS (SEQ200436) IN:

LAKEVIEW LANE - FROM BAISLEY BOULEVARD TO 122ND AVENUE
122ND AVENUE - FROM LAKEVIEW LANE TO LAKEVIEW BOULEVARD EAST
LAKEVIEW BOULEVARD EAST - FROM 122ND AVENUE TO 118TH AVENUE
119TH AVENUE - FROM LONG STREET TO 164TH STREET
164TH STREET - FROM 119TH AVENUE TO 120TH AVENUE

CAPITAL PROJECT WM-1

WATER MAIN WORK IN:

LAKEVIEW LANE - FROM BAISLEY BOULEVARD TO 122ND AVENUE
122ND AVENUE - FROM LAKEVIEW LANE TO LAKEVIEW BOULEVARD EAST
LAKEVIEW BOULEVARD EAST - FROM 122ND AVENUE TO 118TH AVENUE
118TH AVENUE - FROM LAKEVIEW BOULEVARD EAST TO LONG STREET
119TH AVENUE - FROM LONG STREET TO 164TH STREET
164TH STREET - FROM 119TH AVENUE TO 120TH AVENUE

INCLUDING STREET LIGHTING AND TRAFFIC WORK

Together With All Work Incidental Thereto

**BOROUGH OF QUEENS
CITY OF NEW YORK**

FOR THE DEPARTMENT OF TRANSPORTATION
PREPARED BY
AKRF Engineering P.C., & HAZEN AND SAWYER

January 30, 2015



05-148



SPECIFICATIONS AND STANDARDS OF NEW YORK CITY

The following New York City Department of Transportation (NYCDOT) reference documents are available on-line at:

http://www.nyc.gov/html/ddc/html/pubs/pubs_infrastdts.shtml or for purchase between 9:00 A.M. and 3:00 P.M. at 55 Water St., Ground Floor, NYC, N.Y. 10041. Contact: Ms Vivian Valdez, Tel. (212) 839-9434

1. NYCDOT Standard Highway Specifications, November 1, 2010
2. NYCDOT Standard Highway Details of Construction, July 1, 2010
3. NYCDOT Division of Street Lighting Specifications
4. NYCDOT Division of Street Lighting Standard Drawings
5. NYCDOT Standard Specifications for Traffic Signals
6. NYCDOT Standard Drawings for Traffic Signals

The following reference documents for New York City Department of Environmental Protection (NYCDEP) are available on-line at:

http://www.nyc.gov/html/ddc/html/pubs/pubs_infrastdts.shtml or for pick up between 8:00 A.M. and 4:00 P.M. at 30-30 Thomson Avenue, 3rd Floor, Division of Infrastructure, Long Island City, N.Y. 11101. Contact: Mr. Waqar Ahmad, Tel. (718) 391-2056

1. NYCDEP Standard Sewer and Water Main Specifications, July 1, 2014
2. NYCDEP Instructions for Concrete Specifications, Jan. 92
3. NYCDEP General Specification 11-Concrete, November 1991
4. NYCDEP Sewer Design Standards, (September 2007) Revised January 2009

The following reference documents for New York City Department of Environmental Protection (NYCDEP) are available on-line at:

http://www.nyc.gov/html/ddc/html/pubs/pubs_infrastdts.shtml or for pick up between 8:00 A.M. and 4:00 P.M. at 30-30 Thomson Avenue, 3rd Floor, Division of Infrastructure, Long Island City, N.Y. 11101. Contact: Mr. Robert Kuhlmann, Tel. (718) 391-2145

1. NYCDEP Water Main Standard Drawings
2. Specifications for Trunk Main Work, dated July 2014
3. Standards for Green Infrastructure, latest version, available only on-line at: http://www.nyc.gov/html/dep/pdf/green_infrastructure/bioswales-standard-designs.pdf

Water main work material specifications are available at the Department of Environmental Protection, 59-17 Junction Boulevard, 3rd Floor Low-Rise Building, Flushing, N.Y. 11373-5108.

Contact: Mr. Tarlock Sahansra, P.E., Tel. (718) 595-5302
E-mail: TSAHANSRA@DEP.NYC.GOV

Standard Specifications and Drawings for Fire Department Communications facilities of New York City are available at 87 Union Street, Engineering Office, Brooklyn, N.Y. 11231-1416.

Contact: Mr. Ed Durkin, Tel. (718) 624-3752

Tree Planting Standards of the City of New York Parks & Recreation are available at the following Department of Parks & Recreation website:

<http://www.nycgovparks.org/pagefiles/53/Tree-Planting-Standards.pdf>

SPECIFICATIONS AND STANDARDS OF PRIVATE UTILITIES

The Following reference document for Private Utility Work is available for pick up between 8:30 A.M. and 4:00 P.M. at 30-30 Thomson Avenue, First Floor Bid Procurement Room, L.I.C., N.Y. 11101.

1. CET SPECIFICATIONS AND SKETCHES dated November 2010

(NO TEXT ON THIS PAGE)

SCHEDULE A**(GENERAL CONDITIONS TO CONSTRUCTION CONTRACT
(INCLUDING GENERAL CONDITIONS RELATED TO ARTICLE 22 – INSURANCE)****PART I. REQUIRED INFORMATION**

<p align="center"><u>INFORMATION FOR BIDDERS SECTION 26</u> <u>BID SECURITY</u></p> <p>The Contractor shall obtain a bid security in the amount indicated to the right.</p>	See Attachment 1 (page A-1 of the Bid Booklet).
<p align="center"><u>INFORMATION FOR BIDDERS SECTION 26</u> <u>PERFORMANCE AND PAYMENT BONDS</u></p> <p>The Contractor shall obtain performance and payment bonds in the amount indicated to the right.</p>	See Attachment 1 (page A-1 of the Bid Booklet).
<p align="center"><u>CONTRACT ARTICLE 14.</u> <u>DATE FOR SUBSTANTIAL COMPLETION</u></p> <p>The Contractor shall substantially complete the Work in the number of calendar days indicated to the right.</p>	See Page SA-4
<p align="center"><u>CONTRACT ARTICLE 15.</u> <u>LIQUIDATED DAMAGES</u></p> <p>If the Contractor fails to substantially complete the Work within the time fixed for substantial completion plus authorized time extensions or if the Contractor, in the sole determination of the Commissioner, has abandoned the Work, the Contractor shall pay to the City the amount indicated to the right.</p>	\$ <u>900.</u> for each consecutive calendar day over substantial completion time
<p align="center"><u>CONTRACT ARTICLE 17.</u> <u>SUB-CONTRACTOR</u></p> <p>The Contractor shall not make subcontracts totaling an amount more than the percentage of the total Contract price indicated to the right.</p>	Not to exceed <u>50</u> % of the Contract price
<p align="center"><u>CONTRACT ARTICLE 21.</u> <u>RETAINAGE</u></p> <p>The Commissioner shall deduct and retain until the substantial completion of the Work the percent value of the Work indicated to the right.</p>	<u>5</u> % of the value of the Work

<p align="center"><u>CONTRACT ARTICLE 22.</u> <u>(Per Directions Below)</u></p>	See pages SA-5 through SA-10
<p align="center"><u>CONTRACT ARTICLE 24.</u> <u>DEPOSIT GUARANTEE</u></p> <p>As security for the faithful performance of its obligations, the Contractor, upon filing its requisition for payment on Substantial Completion, shall deposit with the Commissioner a sum equal to the percentage of the Contract price indicated to the right.</p>	1% of Contract price
<p align="center"><u>CONTRACT ARTICLE 24.</u> <u>PERIOD OF GUARANTEE</u></p> <p>Periods of maintenance and guarantee other than the period set forth in Article 24.1 are indicated to the right.</p>	Eighteen (18) Months, excluding Trees Twenty-four (24) Months for Tree Planting
<p align="center"><u>CONTRACT ARTICLE 74.</u> <u>STATEMENT OF WORK</u></p> <p>The Contractor shall furnish all labor and materials and perform all Work in strict accordance with the Contract Drawings, Specifications, and all Addenda thereto.</p>	See Contract Article 74
<p align="center"><u>CONTRACT ARTICLE 75.</u> <u>COMPENSATION TO BE PAID TO CONTRACTOR</u></p> <p>The City shall pay and the Contractor shall accept in full consideration for the performance of the Contract, subject to additions and deductions as provided in Contract Article 75, this said sum being the amount at which the Contract was awarded to the Contractor at a public letting thereof, based upon the Contractor's bid for the Contract.</p>	See Contract Article 75
<p align="center"><u>CONTRACT ARTICLE 78.</u> <u>PARTICIPATION BY MINORITY-OWNED AND</u> <u>WOMEN-OWNED BUSINESS ENTERPRISES IN CITY</u> <u>PROCUREMENT</u></p>	See M/WBE Utilization Plan in the Bid Booklet

<p align="center"><u>STANDARD HIGHWAY SPECIFICATIONS</u> <u>SECTION 6.40</u> <u>LIQUIDATED DAMAGES FOR</u> <u>ENGINEER'S FIELD OFFICE</u></p> <p>If the Contractor fails to satisfactorily provide the field office and all equipment specified in Section 6.40 - Engineer's Field Office, and/or if a cited deficiency exceed seventy two (72) hours after notice from the Engineer in writing, or is permitted to recur, liquidated damages will be assessed in the amount specified herein for each subsequent calendar day or part thereof that a cited deficiency resulting in nonpayment, as described in Section 6.40.5, is not corrected.</p>	<p>\$ <u>250.00</u> for each calendar day of deficiency</p>
<p align="center"><u>STANDARD HIGHWAY SPECIFICATIONS</u> <u>SECTION 6.70</u> <u>LIQUIDATED DAMAGES FOR</u> <u>MAINTENANCE AND PROTECTION OF TRAFFIC</u></p>	<p>\$ <u>250.00</u> for each instance of failure to comply with the Maintenance and Protection of Traffic requirements within three (3) hours after written notice from the Engineer</p> <p>\$ <u>500.00</u> for each and every hour of failing to open the entire width of roadway to traffic the morning following a night/weekend work operation</p>
<p align="center"><u>STANDARD HIGHWAY SPECIFICATIONS</u> <u>SECTION 7.13</u> <u>LIQUIDATED DAMAGES FOR</u> <u>MAINTENANCE OF SITE</u></p> <p>If the Contractor fails to comply, within three (3) consecutive hours after written notice from the Engineer, with the requirements of Section 7.13 - Maintenance of Site, the Contractor shall pay to the City of New York, until such notice has been complied with or rescinded, the sum specified above per calendar day, for each instance of such failure, as liquidated damages and not as a penalty, for such default.</p>	<p>\$ <u>250.00</u> for each calendar day, for each occurrence</p>

Date for Substantial Completion (Reference: Article 14)

The Contractor shall substantially complete the Work within the Final Contract Duration determined in accordance with the terms and conditions set forth herein.

The Base Contract Duration for this project is 730 consecutive calendar days (“ccds”).

The Final Contract Duration shall be the Base Contract Duration when a check mark is indicated before the word “NO”, below, and shall be the Base Contract Duration adjusted by the table set forth below when a check mark is indicated before the word “YES”, below.

YES NO

When the Final Contract Duration is indicated above to be adjusted by the table below, the table may increase the Base Contract Duration depending on the date of scheduled substantial completion to avoid a scheduled substantial completion of the Work during the winter months. The date of scheduled substantial completion shall be determined by adding the Base Contract Duration to the date specified to commence work in the written Notice to Proceed. The Final Contract Duration shall then be determined as follows:

- (a) Find the row that corresponds to the month of substantial completion based on the Base Contract Duration added to the date specified to commence work in the written Notice to Proceed.
- (b) Find the number of days to be added to the Base Contract Duration in the table below. Add that number of days to the Base Contract Duration to obtain the Final Contract Duration in consecutive calendar days.

Month of Substantial Completion based on the Base Contract Duration	Number of Days of adjustment
January	150
February	120
March	90
April	60
May	30
June	0
July	0
August	0
September	0
October	0
November –December 15	0
December 16 – December 31	180

In addition, should Item No. 9.30, “Storm Water Pollution Prevention,” exist in the Contract and the required Storm Water Pollution Prevention Plan (SWPPP) does not conform to NYSDEC’s recommended Standards, an additional 60 ccd shall be added to the above Final Contract Duration.

(GENERAL CONDITIONS RELATING TO ARTICLE 22 – INSURANCE)

PART II. TYPES OF INSURANCE, MINIMUM LIMITS AND SPECIAL CONDITIONS

Note: All certificate(s) of insurance submitted pursuant to Contract Article 22.3.3 must be accompanied by a Certification by Broker consistent with Part III below and include the following information:

- For each insurance policy, the name and NAIC number of issuing company, number of policy, and effective dates;
- Policy limits consistent with the requirements listed below;
- Additional insureds or loss payees consistent with the requirements listed below; and
- The number assigned to the Contract by the City (in the “Description of Operations” field).

Insurance indicated by a blackened box (■) or by X in a □ to left will be required under this contract

Types of Insurance (per Article 22 in its entirety, including listed paragraph)	Minimum Limits and Special Conditions
<p>■ Commercial General Liability Art. 22.1.1</p>	<p>The minimum limits shall be \$ <u>3,000,000</u> per occurrence and \$ <u>6,000,000</u> per project aggregate applicable to this Contract.</p> <p>Additional Insureds:</p> <ol style="list-style-type: none"> 1. City of New York, including its officials and employees, with coverage at least as broad as ISO Form CG 20 10 and CG 20 37, and 2. All person(s) or organization(s), if any, that Article 22.1.1(b) of the Contract requires to be named as Additional Insured(s), with coverage at least as broad as ISO Form CG 20 26. The Additional Insured endorsement shall either specify the entity’s name, if known, or the entity’s title (e.g., Project Manager). 3. National Grid.

<p><input checked="" type="checkbox"/> Workers' Compensation Art. 22.1.2</p> <p><input checked="" type="checkbox"/> Disability Benefits Insurance Art. 22.1.2</p> <p><input checked="" type="checkbox"/> Employers' Liability Art. 22.1.2</p> <p><input type="checkbox"/> Jones Act Art. 22.1.3</p> <p><input type="checkbox"/> U.S. Longshoremen's and Harbor Workers Compensation Act Art. 22.1.3</p>	<p>Workers' Compensation, Employers' Liability, and Disability Benefits Insurance: Statutory per New York State law without regard to jurisdiction.</p> <p>Note: The following forms are acceptable: (1) New York State Workers' Compensation Board Form No. C-105.2, (2) State Insurance Fund Form No. U-26.3, (3) New York State Workers' Compensation Board Form No. DB-120.1 and (4) Request for WC/DB Exemption Form No. CE-200. The City will not accept an ACORD form as proof of Workers' Compensation or Disability Insurance.</p> <p>Jones Act and U.S. Longshoremen's and Harbor Workers' Compensation Act: Statutory per U.S. Law.</p>
<p><input type="checkbox"/> Builders' Risk Art. 22.1.4</p>	<p>100 % of total value of Work</p> <p>Contractor the Named Insured; the City both an Additional Insured and one of the loss payees as its interests may appear.</p> <p>If the Work does not involve construction of a new building or gut renovation work, the Contractor may provide an installation floater in lieu of Builders Risk insurance.</p> <p>Note: Builders Risk Insurance may terminate upon Substantial Completion of the Work in its entirety.</p>
<p><input checked="" type="checkbox"/> Commercial Auto Liability Art. 22.1.5</p>	<p>\$ <u>2,000,000</u> per accident combined single limit</p> <p>If vehicles are used for transporting hazardous materials, the Contractor shall provide pollution liability broadened coverage for covered vehicles (endorsement CA 99 48) as well as proof of MCS 90</p> <p>Additional Insureds:</p> <p>(1) City of New York, including its officials and employees, and</p>

<input type="checkbox"/> Contractors Pollution Liability Art. 22.1.6	<p>\$ <u>5,000,000</u> per occurrence \$ <u>5,000,000</u> aggregate</p> <p>Additional Insureds: 1. City of New York, including its officials and employees, and 2. _____ 3. _____</p>
<input type="checkbox"/> Marine Protection and Indemnity Art. 22.1.7(a)	<p>\$ _____ each occurrence \$ _____ aggregate</p> <p>Additional Insureds: 1. City of New York, including its officials and employees, and 2. _____ 3. _____</p>
<input type="checkbox"/> Hull and Machinery Insurance Art. 22.1.7(b)	<p>\$ _____ per occurrence \$ _____ aggregate</p> <p>Additional Insureds: 1. City of New York, including its officials and employees, and 2. _____ 3. _____</p>
<input type="checkbox"/> Marine Pollution Liability Art. 22.1.7(c)	<p>\$ <u>1,000,000</u> per occurrence \$ <u>1,000,000</u> aggregate</p> <p>Additional Insureds: 1. City of New York, including its officials and employees, and 2. _____ 3. _____</p>

[OTHER]

Art. 22.1.8

Railroad Protection Liability Policy

(ISO-RIMA or equivalent form) approved by Permitter covering the work to be performed at the designated site and affording protection for damages arising out of bodily injury or death, physical damage to or destruction of property, including damage to the Insured's own property and conforming to the following:

- Policy Endorsement CG 28 31 - Pollution Exclusion Amendment is required to be endorsed onto the policy when environmental-related work and/or exposures exist.
- Indicate the Name and address of the Contractor to perform the work, the Contract # and the name of the railroad property where the work is being performed and the Agency Permit.
- Evidence of Railroad Protective Liability Insurance, must be provided in the form of the Original Policy. A detailed Insurance Binder (ACORD or Manuscript Form) will be accepted pending issuance of the Original Policy, which must be provided within 30 days of the Binder Approval.

\$ 2,000,000 per occurrence

\$ 6,000,000 annual aggregate

Named Insureds:

1. New York City Transit Authority (NYCTA), the Manhattan and Bronx Surface Transit Operation Authority (MaBSTOA), the Staten Island Rapid Transit Operation Authority (SIRTOA), MTA Capital Construction Co., the Metropolitan Transportation Authority (MTA) including its subsidiaries and affiliates, and the City of New York (as Owner) and all other indemnified parties.

[OTHER]

Art. 22.1.8

Professional Liability

- A. The Contractor's Professional Engineer shall maintain and submit evidence of Professional Liability Insurance in the minimum amount of \$1,000,000 per claim. The policy or policies shall include an endorsement to cover the liability assumed by the Contractor under this Contract arising out of the negligent performance of professional services or caused by an error, omission or negligent act of the Contractor's Professional Engineer or anyone employed by the Contractor's Professional Engineer.

- B. Claims-made policies will be accepted for Professional Liability Insurance. All such policies shall have an extended reporting period option or automatic coverage of not less than two (2) years. If available as an option, the Contractor's Professional Engineer shall purchase extended reporting period coverage effective on cancellation or termination of such insurance unless a new policy is secured with a retroactive date, including at least the last policy year.

[OTHER]

Art. 22.1.8

Engineer's Field Office

Section 6.40, Standard Highway Specifications

Fire insurance, extended coverage and vandalism, malicious mischief and burglary, and theft insurance coverage in the amount of \$40,000

SCHEDULE A

(GENERAL CONDITIONS TO CONSTRUCTION CONTRACT)

PART IV. ADDRESS OF COMMISSIONER

Wherever reference is made in Article 7 or Article 22 to documents to be sent to the **Commissioner** (e.g., notices, filings, or submissions), such documents shall be sent to the address set forth below or, in the absence of such address, to the **Commissioner's** address as provided elsewhere in this **Contract**.

DDC Director, Insurance Risk Manager

30 – 30 Thomson Avenue, 4th Floor (IDCNY Building)

Long Island City, NY 11101

(NO TEXT ON THIS PAGE)

ATTACH TO CONTRACT DOCUMENTS
THE CITY OF NEW YORK
DEPARTMENT OF DESIGN AND CONSTRUCTION
INFRASTRUCTURE DIVISION
BUREAU OF DESIGN
PROJECT ID:HWQ121B4

RECONSTRUCTION OF LAKEVIEW BOULEVARD EAST

LAKEVIEW LANE - FROM BAISLEY BOULEVARD TO 122ND AVENUE
122ND AVENUE - FROM LAKEVIEW LANE TO LAKEVIEW BOULEVARD EAST
LAKEVIEW BOULEVARD EAST - FROM 122ND AVENUE TO 118TH AVENUE
118TH AVENUE - FROM LAKEVIEW BOULEVARD EAST TO LONG STREET

NEW STORM AND SANITARY SEWERS (SEQ200436) IN:

LAKEVIEW LANE - FROM BAISLEY BOULEVARD TO 122ND AVENUE
122ND AVENUE - FROM LAKEVIEW LANE TO LAKEVIEW BOULEVARD EAST
LAKEVIEW BOULEVARD EAST - FROM 122ND AVENUE TO 118TH AVENUE
119TH AVENUE - FROM LONG STREET TO 164TH STREET
164TH STREET - FROM 119TH AVENUE TO 120TH AVENUE

CAPITAL PROJECT WM-1
WATER MAIN WORK IN:

LAKEVIEW LANE - FROM BAISLEY BOULEVARD TO 122ND AVENUE
122ND AVENUE - FROM LAKEVIEW LANE TO LAKEVIEW BOULEVARD EAST
LAKEVIEW BOULEVARD EAST - FROM 122ND AVENUE TO 118TH AVENUE
118TH AVENUE - FROM LAKEVIEW BOULEVARD EAST TO LONG STREET
119TH AVENUE - FROM LONG STREET TO 164TH STREET
164TH STREET - FROM 119TH AVENUE TO 120TH AVENUE

INCLUDING STREET LIGHTING AND TRAFFIC WORK

Together With All Work Incidental Thereto

BOROUGH OF QUEENS
CITY OF NEW YORK

ADDENDUM NO. 1

DATED: February 24, 2014

THIS ADDENDUM IS HEREBY MADE A PART OF THE CONTRACT DOCUMENTS

The New York City Department of Transportation Standard Highway Specifications, dated November 1, 2010, (which include, but are not limited to, "General Conditions", "Basic Materials of Construction", "Combined Materials of Construction", "Construction Methods", "Inspection and Testing of Materials, Adjustments for Deficiencies, and Maintenance", and "Supplemental Construction Methods"), as modified by addenda issued prior to the opening of bids, shall apply to and become a part of the contract.

All references contained herein are to the New York City Department of Transportation, Standard Highway Specifications, dated November 1, 2010. The said Specifications are hereby revised. Included hereunder are the following REVISIONS:

1. Amendments to Standard Highway Specifications, Volume I
2. Amendments to Standard Highway Specifications, Volume II, including Section 7.88 (Revised) and new Sections 6.44 PO and 6.52 CG.
3. New Sections
4. Special Provisions

1. AMENDMENTS TO STANDARD HIGHWAY SPECIFICATIONS, VOLUME I

The following amendments to the Contract Requirements shall become a part of and apply to the contract:

[Added 12-09-2010]

1. Refer to Page 15, **Subsection 1.06.23.(C) CONFORMANCE WITH FEDERAL, STATE AND CITY AGENCIES;**

Add the following new paragraphs:

"The Contractor is notified that all vehicles that are owned, leased or operated by the Contractor or its subcontractors and used in connection with the Project shall comply with the following requirement:

Every truck, tractor, and tractor-trailer or semitrailer combination, having a gross vehicle weight rating of twenty-six thousand pounds or more, and a conventional cab configuration in which more than half of the engine length is forward of the foremost point of the windshield base, and the steering wheel hub is in the forward quarter of the vehicle length shall be equipped with a convex mirror on the front of such vehicle or combination of vehicles. Such convex mirror shall be adjusted so as to enable the operator of such vehicle or combination of vehicles to see all points on an imaginary horizontal line which is three feet above the road, is one foot directly forward from the midpoint of the front of such vehicle or combination of vehicles, and extends the full width of the front of such vehicle or combination of vehicles.

Any vehicle that does not comply with this provision may be prohibited from entering the Project site and/or supplying equipment or materials to the Project. The Contractor shall not be entitled to any damages as a result of such prohibition."

[Added 01-09-2011]

2. Refer to Page 240, **Subsection 4.16.5.(B) STUMP REMOVAL;**
Delete **Subsection 4.16.5.(B) STUMP REMOVAL,** in its entirety;
Substitute the following revised **Subsection 4.16.5.(B) :**

"(B) STUMP REMOVAL

1. Tree stumps designated to be removed and their roots shall be completely excavated to a minimum depth of three (3) feet below the existing grade. A portable stump cutter may be required in some locations. It may be necessary to remove concrete, asphalt, pavers, and/or other types of material surrounding the base of the stump. All excess debris, including chips from tree stumps, shall be removed and disposed of by the Contractor, away from the site prior to backfilling and the area shall be restored by completion of the workday, to the satisfaction of the Engineer. The disposal of tree stumps by burning in open fires will not be permitted.

2. All voids and excavations left after the removal of the stump and roots shall be backfilled to grade with clean earth fill. Fill shall be placed and compacted to a minimum of 95 percent of Standard Proctor Maximum Density by acceptable methods to the satisfaction of the Engineer. Where paving blocks exist, they are to be reset to the existing grade as directed.

3. Maximum safety and care must be used by Contractor during stump removal. The Contractor shall carefully protect against damage all existing trees, plants, curbs, sidewalks and utilities and other features to remain. The Contractor is responsible for locating and protecting underground utilities from damage during stump removal procedures. During stump grinding operations, plywood must be used to protect adjacent vehicles, real property, and pedestrians. If, when removing stumps, existing sidewalks or curbs are disturbed, the Contractor shall restore and/or reset these sidewalks and curbs, at no additional cost to the City. Restoration work shall be done to match the existing, to the satisfaction of the Engineer. All damaged trees, curbs, sidewalks, real property, vehicles and utilities must be addressed within three (3) days."

[Added 04-18-2011]

3. Refer to Pages 218 and 219, **Subsection 4.13.4.(H) PIGMENT;**
Delete the first three (3) paragraphs on page 219:
Substitute the following revised three (3) paragraphs:

"Where the color of the concrete is required to simulate the color of dark gray bluestone, the concrete shall be integrally pigmented to produce a gray color equivalent to: Davis Colors No. 884-3%; Lansco Color No. 437 "Strong Black" 5 lbs. per 94 lbs. Light Grey Portland Cement and 3 parts sand; L.M. Scofield "Cool Black No. 4"; Bayferrox Limestone 330, 2 lbs. per 94 lbs. Light Gray Portland Cement; or an approved equivalent, unless otherwise specified.

Where the color of the concrete is required to simulate the color of light to medium gray granite, the concrete shall be integrally pigmented to produce a gray color equal to: Davis Colors No. 884-1%; Lansco Color No. 437 "Strong Black" 2.5 lbs. per 94 lbs. Light Grey Portland Cement and 3 parts sand; L.M. Scofield "Cool Black No. 1"; Bayferrox Silver 330, 1 lb. per 94 lbs. Light Gray Portland Cement; or an approved equivalent, unless otherwise specified.

Where the sidewalk is designated to have a saw cut joint finish the color of the concrete shall be integrally pigmented to produce a gray color equivalent to L.M. Scofield "Landmarks Grey" K-157-4; L.M. Scofield "Cool Black No. 4"; Davis Colors No. 884-3%; Lansco Color No. 437 "Strong Black" 5 lbs. per 94 lbs. Light Grey Portland Cement and 3 parts sand; Bayferrox NYC Landmark Commission Gray, 3.5 lbs. per 94 lbs. Light Gray Portland Cement; or an approved equivalent, unless otherwise specified."

[Added 07-01-2011]

4. Refer to Page 14, **Subsection 1.06.23.(A) PERMITS;**
Delete line (b) under the first paragraph;
Substitute the following text:

"(b) Any planned work requiring a DOT Construction Permit that may potentially be within 100 feet of a bridge structure will be placed on a Bridge Hold. If any proposed work is within 100 feet of a bridge structure, permittees must submit a scaled drawing showing the work and exact location, along with the following:

- Plan layout of the project area.
- The scope of work.
- The contractor's means and methods.
- Indicate if work will be done on the bridge itself or its abutments, and the type of work.

If the work is more than 100 feet away from the bridge structure, permittees may send a certification by e-mail stating so. Either response must be sent to the Division of Bridges at bridgeshold@dot.nyc.gov for review and release prior to commencing work. Emergency work will not be placed on hold and shall proceed in accordance with the New York City Highway Rules, section 2-11 (g);

(c) Permits from the Department of Sanitation for use of City landfills;"

[Added 07-27-2011]

5. Refer to Page 37, **Subsection 1.06.46.(A) 6. Sign Graphics;**
Delete article "a." beginning with the words "All visual components of the sign are in an Adobe *.pdf file, . . ." and ending with the words ". . . DDC to the Contractor (on a CD or via E-mail) for printing.", in its entirety;
Substitute the following revised article "a":

"a. All visual components of the sign are in an Adobe *.pdf file, which is provided by the Commissioner's representative. The file is not to be altered for composition, type font or image from the version provided by DDC. The Commissioner's representative shall provide a complete file with data and image. The digital file shall be provided by DDC to the Contractor (on a CD or via E-mail) for printing."

[Added 09-27-2012]

6. Refer to Page 36, **Subsection 1.06.46. Project Sign;**
Delete the words "Unless otherwise specified in the Special Provisions of the contract, the following shall apply:";
Substitute the following revised text:

"The Contractor is notified that he shall be required to furnish, install, maintain, and remove, when directed, Construction Project Information Signs (CPIS) as per Sec. 2-02(c)(4) and (5) of the NYC DOT Highway Rule and the cost shall be deemed included under all scheduled items of the contract. In addition, unless otherwise specified in the Special Provisions of the contract, the following Project Sign shall also apply:"

[Added 04-08-2013]

7. Refer to Page 200, **Subsection 4.11.2.(B), first paragraph, sixth line;**
Delete the word "porcelain,".
8. Refer to Page 201, **Subsection 4.11.3.(B) FILL AND BACKFILL, second and third paragraphs;**
Delete the second and third paragraphs under Subsection 4.11.3.(B), in their entirety;
Substitute the following revised two paragraphs:

"Glass or Recycled Porcelain Aggregate (RPA) from recycling facilities that meets the requirements of **Subsection 4.11.3.(E)** for Glass and **Subsection 4.11.3.(F)** for RPA shall be considered suitable material for mixing with fill provided the Contractor maintains the gradations specified herein. However, glass shall not be placed in contact with synthetic liners, geogrids, geotextiles or other geosynthetics.

Glass and/or RPA incorporated into fill shall be thoroughly mixed with other suitable material so that glass, RPA or combination of both constitutes no more than 30 percent by volume anywhere in the fill as visually determined by the Engineer."

9. Refer to Page 202, **Subsection 4.11.3.(E) GLASS;**
Add the following new **Subsection 4.11.3.(F) RECYCLED PORCELAIN
AGGREGATE (RPA) :**

“(F) RECYCLED PORCELAIN AGGREGATE (RPA)

All porcelain to be used as RPA shall be crushed by a New York City Department of Environmental Protection (NYCDEP) approved recycling facility to a maximum particle size of 3/8 inch and graded to meet the gradation specified above for use in either fill, backfill or select fill, as may be required. RPA from any other source will not be permitted. The NYCDEP approved recycling facility will also certify that the RPA being furnished is free from organic material and other unsuitable material.

Should the Contractor desire to use RPA in his fill or backfill material, he shall contact Mr. Vasyl Kravchyk at NYCDEP (Tel. No. 718-595-7512) to determine the availability of RPA and from which recycling facility it can be obtained.

The Contractor shall be required to make arrangement with the recycling plant, at least two (2) weeks in advance of when he would need the material, to schedule the time, date and quantity available for pickup. The Contractor shall be required to furnish the recycling facility with a complete list of his trucks involved in transporting the material, which shall include the name of the registered owner (Contractor), Consumer Affairs or DOS Permit numbers, body license plate number, and truck volume. This information must be supplied to the facility prior to the start of picking up the RPA.

Weight ticket receipt slips given by the recycling facility to each truck driver picking up RPA shall be collected by the Contractor and given to the Engineer upon delivering fill or backfill material to the site that contains RPA, and the Contractor agrees and warrants that in obtaining the RPA that such material has originated only from a NYCDEP approved recycling plant and it has not been mixed with porcelain material from any other source.

The Contractor shall be required to transport said material from the approved recycling facility to his yard for storage and mixing with his fill material; however, there is not guarantee that the material will actually be available.

The Contractor is advised that there is no guarantee that RPA will in fact be available for his use from a NYCDEP approved recycling plant and he shall make no claim against the City for loss of anticipated profits should the material not be available upon request by the Contractor.

All excess RPA not used in the fill or backfill shall remain the property of the DDC Contractor.

The Contractor must comply with all rules and regulations of the Department of Transportation and the Department of Environmental Protections governing the use of RPA in its fill and backfill material.”

10. Refer to Pages 218 and 219, **Subsection 4.13.4.(H) PIGMENTING,**
first four paragraphs;

Delete the first four paragraphs under Subsection 4.13.4.(H), in
their entirety;

Substitute the following revised four paragraphs:

“Where pigmenting is specified, the concrete sidewalks shall be pigmented with an admixture complying with the requirements of **Section 2.19** and the following requirements:

‘Commercial Gray’: In commercial districts C4–4 through C4–7, C5 and C6, as defined in the Zoning Resolution of the City of New York, and in areas under the jurisdiction of the Lower Manhattan Development Corporation the color of the concrete shall be integrally pigmented to produce a gray color equivalent to L.M. Scofield ‘Landmarks Grey’ K-157-4; L.M. Scofield ‘Cool Black No. 4’; Davis Colors No. 884-3%; Lansco Color No. 437 ‘Strong Black’ 5 lbs. per 94 lbs. Light Grey Portland Cement and 3 parts sand; Bayferrox NYC Landmark Commission Gray, 3.5 lbs. per 94 lbs. Light Grey Portland Cement; or an approved equivalent, unless otherwise specified.

'Bluestone': Where the color of the concrete is required to simulate the color of dark gray bluestone, the concrete shall be integrally pigmented to produce a gray color equivalent to: Davis Colors No. 884-3%; Lansco Color No. 437 'Strong Black' 5 lbs. per 94 lbs. Light Grey Portland Cement and 3 parts sand; L.M. Scofield 'Cool Black No. 4'; Bayferrox Limestone 330, 2 lbs. per 94 lbs. Light Gray Portland Cement; or an approved equivalent, unless otherwise specified.

'Granite': Where the color of the concrete is required to simulate the color of light to medium gray granite, the concrete shall be integrally pigmented to produce a gray color equal to: Davis Colors No. 884-1%; Lansco Color No. 437 'Strong Black' 2.5 lbs. per 94 lbs. Light Grey Portland Cement and 3 parts sand; L.M. Scofield 'Cool Black No. 1'; Bayferrox Silver 330, 1 lb. per 94 lbs. Light Gray Portland Cement; or an approved equivalent, unless otherwise specified."

[Added 05-24-2013]

11. Refer to Page 14, **Subsection 1.06.23. (A) PERMITS**, first paragraph as modified by Article 4 on page A1-1b;
Add the following new text:

"(d) All necessary permits from the Department of Environmental Protection which may include, but are not limited to, permits for use of City water."

12. Refer to Page 14, **Subsection 1.06.23. (A) PERMITS**, second paragraph;
Add the following as the third paragraph:

"No fee permits for use of City water necessary to complete roadway pavement reconstruction project in conjunction with installation of sewers and/or water mains, will be issued by the Department of Environmental Protection. However, for all other type projects (such as installation of sidewalks, installation of pedestrian ramps, pavement milling, resurfacing, rehabilitation of retaining walls, and bridge reconstruction type projects) the Contractor will be required to obtain the water use permit at its own cost."

[Added 08-05-2013]

13. Refer to page 116, second paragraph up from the bottom of the page, first line;
Change the words "Concrete of Type IA and IIA shall have..." to read "Concrete of Type IA, IIA and IIIA shall have..."

[Added 09-04-2013]

14. Refer to page 100, **Subsection 3.01.3. (C) 1. (c)**;
Delete the last two lines of text beginning with the words "The proportion of reclaimed asphalt pavement permitted within each mix...";
Substitute the following sentence: "The proportion of reclaimed asphalt pavement permitted within each mix shall be not less than 30 percent for the top and bottom courses as per Local Law #71 of 2011."
15. Refer to page 110, **Subsection 3.05.2. (A)**, **Table 3.05-I**;
Insert the following text at the bottom of **Table 3.05-I**:

"Note: The above proportions shown for non-High-Early mixes shall be modified by pozzolan substitutes as per **Subsection 3.05.4.**"

16. Refer to page 112, **Subsection 3.05.3.(C)**, second paragraph;
Delete the second paragraph in its entirety;
Substitute the following paragraph:

"Water shall be potable and drawn from municipal water mains."

17. Refer to page 113, first line of text, beginning with the words
"condition making up one (1) cubic yard of concrete.";
Insert the following sentence between the words "condition making up one
(1) cubic yard of concrete." and "The range of water-cement ratio within which the . . .":

"The calculated yield of the mix shall be within \pm 2% of the Theoretical (1) cubic yard."

18. Refer to Page 113, second paragraph beginning with the words "The
Contractor may substitute Portland cement . . .";
Delete the second paragraph under **Subsection 3.05.4.**, in its
entirety;
Substitute the following revised paragraph:

"With the exception of high-early strength concrete, the Contractor shall be required to substitute Portland cement with pozzolans (Fly Ash or GGBFS) such that the maximum amount of Portland cement per cubic yard of concrete does not exceed 400 pounds, and with the use of an approved non-corrosive, non-chloride admixture as required to obtain a minimum compressive strength of 3,000 psi in seven (7) days. For high-early strength concrete the Contractor may substitute Portland cement with pozzolans (Fly Ash or GGBFS), pound for pound, up to 20% (or up to 25% for tidal/sea water spray areas) of the weight of cement specified for any concrete mixture provided the Contractor can obtain a minimum compressive strength of 3,000 p.s.i. in three (3) days. The Contractor, immediately following but not later than eight weeks after the date of the Contractor's Notice to Proceed, shall file with the Engineer, Age-Strength data of the job mix he proposes to use for the various ambient temperatures anticipated during the period of concrete placement. This data shall be presented in both tabular and graphical form for those various ambient temperatures with a maximum setting period of seven (7) days for Class B-32 concrete or seventy-two (72) hours for High-Early Strength Concrete."

19. Refer to Page 115, **TABLE 3.05-III - INGREDIENT MATERIALS**;
Change in the third row, second column, the type of Portland
Cement from "Type III*" to read "Type II or Type III*"

20. Refer to page 132, **Subsection 3.06.3.(D)**;
Change the words "Water shall be drawn from mains owned by The City of New York." to
read "Water shall be potable and drawn from municipal water mains."

21. Refer to page 133, **Subsection 3.07.3.(D)**;
Change the words "Water shall be drawn from mains owned by or supplying water to The
City of New York." to read "Water shall be potable and drawn from municipal water
mains."

22. Refer to page 134, **Subsection 3.08.4.(D)**;
Change the words "Water shall be drawn from mains owned by or supplying water to The
City of New York." to read "Water shall be potable and drawn from municipal water
mains."

23. Refer to Page 166, **Subsection 4.05.2. (A)** ;
Delete **Subsection 4.05.2. (A)** , in their entirety;
Substitute the following revised **Subsection 4.05.2. (A)** :

“(A) Concrete Pavement shall be of the following types:

- Type 1--Non-reinforced
- Type 2--Reinforced (Unpigmented or pigmented if specified)
- Type 3--High Early Strength Reinforced (Unpigmented or pigmented if specified)

Type 2 and Type 3 pavements shall consist of a concrete surface course, which shall be unpigmented or pigmented if specified, laid on a concrete base course, which may or may not be pigmented at the Contractor's option, while the base course is still plastic, of the thickness shown on the Contract Drawings, with reinforcement placed between the surface and base courses.”

24. Refer to Page 166, **Subsection 4.05.3. (A)** ;
Insert the following new **Subsection 4.05.3. (A1)** :

“(A1) PIGMENTING

Where pigmenting is specified, the surface course of the concrete bus pad shall be pigmented with an admixture complying with Section 2.19 and the following requirements:

Where the color of the concrete is required to simulate the red color of the Red Bus Lane Pavement Overlay (Item 6.44 POR in Section 6.44 PO), the surface course concrete shall be integrally pigmented to produce a red color equivalent to Scofield's quarry red.

Except for the use of an air-entraining agent complying with ASTM Designation C 260 and water reducing admixtures complying with ASTM Designation C 494 used in combination with the Pigment Admixture as per the pigment manufacturer's instruction, no other admixtures (including, but not limited to, calcium chloride) shall be used unless stated in writing by the manufacturer of the Pigment Admixture to be of no consequence to the colorfastness of the concrete mixture and is approved by the Engineer.

All pigmented concrete at different locations shall be identical, unless otherwise directed. Variations in color/tint/hue will not be acceptable. Therefore, the same brand and type of cement and the same source and type of aggregate shall be used throughout the project.

Prior to the mix design being made, the cement intended for use shall be checked to determine that its lightness/darkness is similar to the cement used in the original approved sample. The Pigmented Admixture shall be added in the standard proportion specified by the manufacturer.”

25. Refer to Page 170, **Subsection 4.05.5. (A) GENERAL** ;
Insert the following two new paragraphs:

“For pigmented concrete, the Contractor shall within eight weeks of the notice to proceed, submit the name of its proposed roadway installer upon which his bid is based, along with their respective work history experience in placing pigmented concrete. The installer shall have documented experience in working with pigmented concrete.

Prior to making any field samples and the placing of any pigmented concrete, the Contractor, its concrete supplier, installer, cement producer, laboratory, the pigmented admixture's representative, and the Engineer shall meet and agree on the specifications and methods of handling the pigmented concrete.”

26. Refer to Page 183, **Subsection 4.05.9. PRICES TO COVER**, 4th line;
Insert in the fourth line, the words "pigment when specified" between the
words "specifications, including, but not limited to," and "furnishing and installing...":

27. Refer to Page 183, **Subsection 4.05.9. PRICES TO COVER**;
Insert the following two new Items to the list of Item Nos. at the
bottom of **Subsection 4.05.9**:

"4.05 ACP REINFORCED CONCETE PAVEMENT (BUS STOPS)(PIGMENTED) C.Y.

4.05 AXP HIGH-EARLY STRENGTH REINFORCED CONCRETE PAVEMENT
(BUS STOPS)(PIGMENTED) C.Y."

2. AMENDMENTS TO STANDARD HIGHWAY SPECIFICATIONS, VOLUME II

[Added 01-25-2012]

1. Refer to Pages 365 and 366, **Subsection 6.40.2.(C)(c)(1) Personal Computer(s) - Workstation Configuration;**

Delete the text under **Subsections (a), (b), (c), (d), (h), (i), and (m),** in their entirety;

Substitute the following revised text:

- “(a) Make and Model: Dell; HP; Gateway; Acer; or, an approved equivalent. (Note: an approved equivalent requires written approval of the Assistant Commissioner of ITS.)
- (b) Processor: i5-2400 (6MB Cache, 3.1GHz) or faster computer - Single Processor.
- (c) System Ram: Minimum of 4GB (Gigabytes) Dual Channel DDR3 SDRAM at 1333MHz – 2 DIMMSs
- (d) Hard Disk Drive(s): 500 GB (Gigabytes) Serial ATA (7200RPM) w/DataBurst Cache, or larger.”
- “(h) Video Display Card: HD Graphics (VGA, HDMI) with a minimum of 64 MB of RAM.
- (i) Monitor: 22" W, 23.0 Inch VIS, Widescreen, VGA/DVI LCD Monitor.”
- “(m) Software Requirements: Microsoft Windows 7 Professional SP1, 64 bit; Microsoft Office Professional 2010; Microsoft Project 2010; Adobe Acrobat reader; Anti-Virus software package with 2 year updates subscription; and, either Auto Cad 2012 LT or Microsoft Visio 2010 Standard Edition, as directed by the Engineer.”

2. Refer to Page 366, **Subsection 6.40.2.(C)(c)(2)(b);**
Delete the text under **Subsection (b),** which begins with the words
“(b) One (1) 600 DPI HP Laser Jet . . .”, in its entirety;
Substitute the following revised text:

- “(b) One (1) 600 DPI HP Color Laser Jet all-in-one Printer/Scanner/Copier/Fax (twelve (12) pages per minute or faster) with one (1) Extra Paper Tray (Legal Size) networked to all office computers.”

3. Refer to Page 367, **Subsection 6.40.3. SPECIFIC REQUIREMENTS FOR ENGINEERS FIELD OFFICE (TYPE A, B, C, CU, D OR DU)**, first paragraph;
Delete the text in the first paragraph of **Subsection 6.40.3.**, in its entirety;
Substitute the following revised text:

6.40.3. SPECIFIC REQUIREMENTS FOR ENGINEER'S FIELD OFFICE (TYPE A, B, C, CU, D, OR DU). In addition to the general requirements, each type of Field Office shall have the minimum floor area indicated in Table 6.40-I calculated based on usable area only, excluding any loss factors. Loss factors are defined as those areas such as lobby, sidewalk window ledge, elevator shafts and stairways. The Contractor shall provide and maintain furnishings for each type of Field Office in the quantity specified in Table 6.40-I. The furnishings shall be new or used equipment satisfactory to the Engineer:

4. Refer to Page 368, TABLE 6.40-I, ADDITIONAL REQUIREMENTS SPECIFIC REQUIREMENTS;
Delete the requirements for a Photocopy Machine shown in the 15th row of TABLE 6.40-I, in its entirety;
Substitute the following revised requirements:

Photocopying Machine – Stand-alone, heavy duty, electric, dry-process color photocopying type with a minimum production rate of 70 pages per minute and an adequate supply of copy paper, toner, etc. The machine shall be capable of duplex copying paper sizes of 8-1/2 x 11 inches, 8-1/2 x 14 inches and 11 x 17 inches, and have separate trays for each paper size. It shall have a document feeder, collator, stapler, and the capability to reduce/enlarge copies between each paper size. The supply of each size copy paper, toner, etc. shall be replenished and the machines shall be maintained for the duration of the contract by the Contractor as required by the Engineer. Make and model can be Minolta, Canon, IBM, Epson, or an approved equivalent, and shall be networked to the office computers.	1	1	1	1	1	1
---	---	---	---	---	---	---

5. Refer to Page 368, TABLE 6.40-I, ADDITIONAL REQUIREMENTS SPECIFIC REQUIREMENTS;
Insert the following two additional requirements:

Heavy duty commercial grade diamond cut shredder with automatic start. The shredder shall be able to receive 8-1/2 inch wide paper and shred a minimum of 15 sheets simultaneously along with CDs and staples.	1	1	1	1	1	1
Projector – 1080p LCD with a min. of 2200 ANSI Lumens, 1920 x 1080, 16:9, 40,000:1 contrast ratio, HDMI, VGA, USB, and a 10 feet diagonal, 16:9 Projection Screen.	-	-	1	1	1	1

6. Refer to Page 496, Subsection **7.20.4. METHODS**, last paragraph beginning with the words "When directed by the Engineer, due to the original conditions . . .";
Add the following sentence to the end of the last paragraph under **Subsection 7.20.4:**

"However, if the owner at his own expense supplies the replacement frame and doors or hatch covers the Contractor shall install the replacement frame and doors or hatch covers under this Item 7.20, as a basement access reset, in lieu of the steel safety closure plate."

[Added 07-16-2012]

7. Refer to Page 365, **Subsection 6.40.2.(C)(c)(1) "Personal Computer(s) - Workstation Configuration"**;
Delete the text under **Subsections (g) and (k)**, in their entirety;
Substitute the following revised text:

- (g) I/O Ports: Must have at least one (1) Serial Port, one (1) Parallel Port, and three (3) USB Ports.
- (k) Network Interface: Integrated 10/100/1000 Ethernet card."

8. Refer to Page 366, **Subsection 6.40.2.(C)(c)(2) "All field offices requiring computers shall be provided with the following:"**;
Delete the text under **Subsection (a)**, in its entirety;
Substitute the following revised text:

- "(a) One (1) broad-band internet service account. Wideband Internet connectivity at a minimum throughput of 15 Mbps download and 5 Mbps upload is required at each field office location with 1-5 staffers. For larger field offices see table below for minimum required upload speeds. Telephone service should be bundled together with Internet connectivity. Because of throughput requirements Verizon FIOS is the preferred connectivity provider where available.

Office Personnel #	Upload Speeds (Minimum)
1 - 5	5 Mbps
6 - 10	10 Mbps
11 - 15	15 Mbps
16 - 20 ...	20 Mbps

This account will be active for the life of the project. The e-mail name for the account shall be the DDC Field Office/project Id (e.g. FLD K HWK666 McGuinness@earthlink.com)."

[Added 08-09-2012]

9. Refer to Page 366, **Subsection 6.40.2.(C)(c)(2)(b)**, as amended by Article 2 on page A1-2 of this Addendum;
Delete the text under **Subsection (b)**, in its entirety;
Substitute the following words: "**(b) (No Text).**"

10. Refer to Page 368, TABLE 6.40-I, ADDITIONAL REQUIREMENTS SPECIFIC REQUIREMENTS;
Delete the requirements for a Photocopy Machine shown in the 15th row of TABLE 6.40-I, as modified by Article 4 on page A1-2a of this Addendum, in its entirety;
Substitute the following revised requirements:

Photocopying Machine – Stand-alone, heavy duty, electric, dry-process color photocopying type with color scan and send capability via e-mail, a minimum production rate of 70 pages per minute and an adequate supply of copy paper, toner, etc. The machine shall be capable of duplex copying paper sizes of 8-1/2 x 11 inches, 8-1/2 x 14 inches and 11 x 17 inches, and have separate trays for each paper size. It shall have a document feeder, collator, stapler, and the capability to reduce/enlarge copies between each paper size. The supply of each size copy paper, toner, etc. shall be replenished and the machines shall be maintained for the duration of the contract by the Contractor as required by the Engineer. Make and model can be Minolta, Canon, IBM, Epson, or an approved equivalent, and shall be networked to the office computers.	1	1	1	1	1	1
--	---	---	---	---	---	---

[Added 11-26-2012]

11. Refer to Pages 504 through 508, **SECTION 7.88 - Rodent and Waterbug Pest Control**;
Delete **Section 7.88**, in its entirety;
Substitute SECTION 7.88 (Revised), as contained on the following pages A1-2d through A1-2i.

[Added 02-08-2013]

12. (NO TEXT)

SECTION 7.88 (Revised)
Rodent and Waterbug Pest Control

7.88.1. DESCRIPTION. The Contractor shall provide all labor, materials, plant and equipment, and incidentals required to survey and monitor rodent activity and control any infestation or outbreak of rodents and waterbugs (American cockroaches) within the project limit.

7.88.2. MATERIALS. All materials shall be approved by the New York State Department of Environmental Conservation and comply with the New York City Health Code for the intended usage.

Rodenticide weatherproof bait blocks shall be multiple dose anticoagulants such as Chlorophacinone or Dephacinone, or single feed rodenticides such as ContraMeal, ContractBait block, Quintox pellets or TalonG pellets, or an approved equivalent.

Tamper proof bait station boxes shall be designed to exclude other mammals and shall be used with poisoned bait to attract rats. Information on "tamper proof bait station boxes" is available from the NYC Bureau of Regulatory & Environmental Health Services, Pest Control Office (718-956-7103/4).

Live traps shall be of proper dimensions for trapping rats and shall not be used with poisoned bait.

Insecticide bait shall be a residual type such as phenol methyl carbamate (2%) bait or an approved equivalent.

(A) SUBMITTALS

Prior to commencement of construction activities the Contractor shall submit to the Engineer manufacturer's installation instructions for all materials required for rodent and waterbug pest control work and product data which shall include illustrations, catalog data, product characteristics, typical use, performance, and limitation criteria of all rodent and waterbug pest control materials required.

7.88.3. PERSONNEL. The Contractor shall employ two independent licensed exterminators: one to engage in survey and monitoring work to establish the level of infestation of rodents and insects and provide recommendations for specific Integrated Pest Management (IPM) actions, and one to execute the rodent and waterbug pest control work to deal with such infestations. All pest control personnel employed by each exterminator company must be supervised by an exterminator licensed in categories 7A & 8. The Contractor shall submit the names and license credentials of the two exterminator companies to the Engineer for approval prior to the commencement of any work under this section.

7.88.4. METHODS. Application and dosage of all materials shall be done in strict compliance with the manufacturer's recommendations. All surveying, monitoring, baiting, and/or live trapping work shall be performed in the presence of the Engineer, without which no payment will be made under this Section.

(A) GENERAL

The Contractor's construction activity is expected to disturb any established rodent and/or waterbug population that may exist within the project limits, possibly causing their dispersion. The Contractor shall take all appropriate action to eliminate and/or control these populations within the construction corridor: the construction corridor shall be defined as being the full width of streets under the contract and intersecting streets up to the limits of construction, from property line to property line, excluding buildings and under sidewalk building vaults.

Under the Maintenance of Site requirements for the contract, any unsanitary conditions, such as uncollected garbage or debris, resulting from the Contractor's activities which will provide food and shelter to the resident rodent population shall be corrected by the Contractor immediately after notification of such condition by the Engineer. Non-compliance shall be subject to the application of the "Nonconformance" provisions of the Item for Maintenance of Site, and no payment will be made for any additional application of rodenticide or insecticide needed to control resultant infestations.

(B) SURVEY AND MONITORING WORK

(1) Prior to Construction - The Contractor's designated survey and monitoring exterminator shall execute a survey of the project area and estimate the level of rodent (Norway rat, House mouse) infestation and the waterbug population within the construction corridor. An appropriate sample of utility manholes (sewer, electrical, telephone, etc.) and catch basins should be opened and surveyed to the satisfaction of the Engineer. Contractor shall maintain all survey records in the manner described in 7.88.6., Records and Reports.

(2) During Construction - The Contractor shall monitor the rodent activity through trapping (snap, glue traps or live traps), fecal count methods, and inspection of the conditions of all installed baits every week during construction activity or as otherwise directed by the Engineer. Contractor shall maintain all monitoring records in the manner described in 7.88.6., Records and Reports.

(C) RODENT CONTROL WORK

(1) Wetlands, Woodlands and Areas Within Seventy-five (75') feet of a Stream. In wetlands, woodlands and areas adjacent to a stream, special precautions must be taken to protect water quality and to ensure the safety of other wildlife. To prevent poisoned bait from entering streams, no poisoned bait shall be used in areas within seventy-five (75') feet of either streambank. Live traps must be used in these seventy-five (75') feet buffer zone areas and within wetland and woodland areas.

(2) Outside Wetland Areas, Woodland Areas and Beyond Seventy-five (75') feet of a Stream. In areas outside the seventy-five foot zone of protection adjacent to streams, and areas outside wetlands and woodlands, tamper proof bait stations with poisoned bait shall be established during the period of construction and any consumed or decomposed bait shall be replenished as directed.

Rodent control shall be achieved in two stages as follows:

Stage I. At least one month prior to initiation of the construction work, and periodically thereafter, live traps and/or rodenticide bait, as directed above, shall be placed at locations [e.g., burrows, utility manholes (sewer, electrical, phone, etc.), and catch basins] that are inaccessible to pets, human beings, children and other non-target species, particularly wildlife (e.g., birds) in the construction corridor. Locations of initial bait placement and quantities of bait shall be determined by the survey and monitoring exterminator's written report of his survey and monitoring results, or as otherwise directed by the Engineer.

Stage II. During Construction - Infested sites as determined by the survey and monitoring exterminator's monitoring report shall be baited and/or rebaited, and live traps shall be collected and replaced, the rates and quantities of which shall be determined by the written monitoring reports submitted weekly or as otherwise directed by the Engineer in consultation with the City's Office of Pest Control.

The baiting exterminator shall be responsible for collecting and disposing of all trapped and poisoned rodents found in live traps and tamper proof bait stations. The baiting exterminator shall also be responsible for posting and maintaining signs announcing the baiting of each particular location.

The Contractor, under his maintenance of site operations, shall be responsible for the immediate collection and disposal of any visible rodent remains found on streets or sidewalk within the project limits. Any visible remains shall be placed into double plastic bags. No more than five (5) carcasses shall be placed into each bag. Each bag shall be a minimum of 3 mils thick, black plastic. No additional payment will be made for this work.

It is anticipated that public complaints will be addressed to the Engineer's Field Office. The Contractor, where directed by the Engineer, shall take appropriate Integrated Pest Management (IPM) actions, such as baiting, trapping, proofing, etc., to remedy the source of a complaint within the next six (6) hours of normal working time, which is defined herein, for the purposes of this section, as 7 A.M. to 6 P.M. on Mondays through Saturdays.

(D) WATERBUG (AMERICAN COCKROACH) CONTROL

Infested sites (e.g., sewers) shall be baited at least 2 times per month with insecticides, or as directed by the Engineer in consultation with the exterminator monitoring the work and the City's Office of Pest Control.

7.88.5. EDUCATION & TRAINING. The Contractor shall post notices in all Construction Bulletin Boards advising workers, employees, and residents to call the Engineer's Field Office to report rodent and waterbug infestations. The Contractor shall provide and distribute literature pertaining to IPM techniques of rodent control to affected businesses and superintendents of nearby residential buildings to ensure their participation in maintaining their establishments free of unsanitary conditions, harborage removal and rodent proofing.

Prior to application of any chemicals, the Contractor shall furnish copies or sample labels for each pesticide, antidote information, and Material Data Safety Sheets (MSDS) for each chemical used.

7.88.6. RECORDS AND REPORTS.

(A) GENERAL

The Contractor shall be responsible for assigning within the construction corridor an identifying number to each manhole, catch basin, and other location where bait and/or live trap placement and/or waterbug control work is proposed by the survey and monitoring exterminator. The Contractor shall then provide that list of locations and corresponding reference numbers along with a drawing showing the locations, as a reference for the exterminator(s) performing the work, to indicate locations of bait placement and waterbug control work and rodent and waterbug activity (droppings, bait consumed, dead rodents, etc.).

(B) SURVEY AND MONITORING WORK

(1) Prior to Construction – Contractor shall submit to the Engineer, for approval, a written survey report including proposed IPM procedures, including specific materials, quantities, locations, methods, and time schedule for the implementation of the exterminating work. The written report shall also include a survey with a drawing (provided by the Contractor) marked with locations indicating all signs of rodent (Norway rat, House mouse) infestation and waterbug activity discovered during the execution of the survey indicating that rodent and waterbug pest control work is necessary.

(2) During Construction - Based on monitoring results, Contractor shall submit to the Engineer a weekly written monitoring report identifying all locations and conditions of installed bait and/or other rodent control work. The monitoring report shall also include any other recommended IPM techniques, such as baiting, trapping, proofing, etc., proposed for rodent and waterbug pest control.

The survey and monitoring exterminator shall keep a record of all rodent and waterbug infestation surveys s/he has conducted. The Contractor shall be required to submit a copy of all survey and monitoring reports to the Engineer each week, prior to payment.

(C) RODENT AND WATERBUG CONTROL WORK

The baiting exterminator shall maintain records of all locations baited along with the type and quantity of rodenticide and insecticide bait used. These records will be kept by the City Inspector. A weekly report shall be prepared, signed and certified by the approved licensed exterminator, and such reports shall be submitted to the Engineer each week, prior to payment.

7.88.7. NONCONFORMANCE. If the Contractor fails to perform as directed to control the rodent and/or waterbug population at any location within the project limits for a period of more than one week, the Engineer will correct the adverse conditions by any means he deems appropriate, including but not limited to, the use of “outside services” and shall deduct the cost of the corrective work from any monies due to the Contractor. The deducted cost of this work shall be in addition to the non-payment for rodent and waterbug pest control.

7.88.8. MEASUREMENT.

(A) RODENT INFESTATION SURVEY AND MONITORING

The quantity to be measured for payment under Item No. 7.88 AA, RODENT INFESTATION SURVEY AND MONITORING, shall be a Lump Sum measurement.

(B) RODENT BAIT STATIONS

The quantity to be measured for payment under Item No. 7.88 AB, RODENT BAIT STATIONS, shall be the number of tamper-proof rodent bait station boxes and/or live traps satisfactorily installed or reinstalled after inspection within the construction corridor, as approved by the Engineer. However, the initial baiting, and subsequent rebaiting as may be required, of any bait station will be paid for under Item 7.88 AC.

(C) BAITING OF RODENT BAIT STATIONS

The quantity to be measured for payment under Item No. 7.88 AC, BAITING OF RODENT BAIT STATIONS, shall be the number of tamper-proof rodent bait station boxes, utility manholes, catch basins, or other locations approved by the Engineer, satisfactorily baited or rebaited to replenish consumed or decomposed bait within the construction corridor, as approved by the Engineer.

(D) WATERBUG BAIT APPLICATION

The quantity to be measured for payment under Item No. 7.88 AD, WATERBUG BAIT APPLICATIONS, shall be the number of blocks satisfactorily treated with insecticide bait within the construction corridor, as approved by the Engineer. A block shall be defined as the area of street, measured between property lines, from intersection to intersection. Each rebaiting of any block shall be considered as a new block for measurement purposes.

7.88.9. PRICES TO COVER.

(A) RODENT INFESTATION SURVEY AND MONITORING

Payment will be made at the lump sum price bid for RODENT INFESTATION SURVEY AND MONITORING which shall include the cost of furnishing all the labor, materials, plant, equipment (traps, etc.), insurance, and other incidentals required, including but not limited to providing all required maintenance of traffic equipment, to perform a rodent infestation survey of the project area and then monitor the site each week for rodent activity, all in accordance with the specifications and the directions of the Engineer.

Ten (10%) percent of the lump sum price bid will be paid when the initial survey of the project area has been completed and the written survey report has been submitted to the satisfaction of the Engineer. The remainder will be paid in proportion to the percentage of contract completion.

(B) RODENT BAIT STATIONS

The Contract price bid for RODENT BAIT STATIONS shall be a unit price per each tamper proof bait station box and/ or live trap installed or reinstalled after inspection and shall cover the cost of furnishing all labor, materials, plant, equipment (bait stations, etc.), insurance, and other incidentals, including but not limited to providing all required maintenance of traffic equipment, required to control the rodent population found within the project limits in accordance with the specifications and the directions of the Engineer.

In addition to the payment for Rodent Bait Stations installed or reinstalled under this Item 7.88 AB, the Contractor will also be paid for each baiting or rebaiting, when required, of each bait station, under Item No. 7.88 AC.

(C) BAITING OF RODENT BAIT STATIONS

The Contract price bid for BAITING OF RODENT BAIT STATIONS shall be a unit price per each bait station, utility manhole, catch basin or other location approved by the Engineer satisfactorily baited or rebaited, when required, and shall cover the cost of furnishing all labor, materials, plant, equipment (bait), insurance, and other incidentals, in accordance with the specifications and directions of the Engineer. Installation or resetting of the bait station will be paid for under Item 7.88 AB.

(D) WATERBUG BAIT APPLICATION

The Contract price bid for WATERBUG BAIT APPLICATION shall be a unit price per block treated by the exterminator and shall include the cost of furnishing all the labor, materials, plant, equipment (bait, etc.), insurance, and other incidentals, including but not limited to providing all required maintenance of traffic equipment, necessary to control the waterbug population found within the project limits for the duration of the contract in accordance with the specifications and the directions of the Engineer.

Payment will be made under:

Item No.	Item	Pay Unit
7.88 AA	RODENT INFESTATION SURVEY AND MONITORING	L.S.
7.88 AB	RODENT BAIT STATIONS	EACH
7.88 AC	BAITING OF RODENT BAIT STATIONS	EACH
7.88 AD	WATERBUG BAIT APPLICATION	BLOCK

[Added 05-24-2013]

13. Refer to Page 366, **Subsection 6.40.2.(C)(c)(1)(m) Software Requirements**, as modified by Article 1 on page A1-2;
Delete the text under **Subsection (m)**, in its entirety;
Substitute the following revised text:

“(m) **Software Requirements:** Microsoft Windows 7 Professional SP1, 32 bit; Microsoft Office Professional 2010; Microsoft Project 2010; Adobe Acrobat reader; Anti-Virus software package with 2 year updates subscription; and, either Auto Cad LT or Microsoft Visio Standard Edition, as directed by the Engineer.”

[Added 09-04-2013]

14. Refer to Page 384, the end of **Section 6.44 - White and Yellow Thermoplastic ReflectORIZED Pavement Markings**;
Insert new **SECTION 6.44 PO**, after **Section 6.44**, as contained on the following pages A1-2k through A1-2m.

[Added 02-10-2014]

15. Refer to Pages 393 and 394, **SECTION 6.52 - Uniformed Full-Time Flagperson**;
Delete **Section 6.52** on pages 393 and 394, but do not delete examples on pages 395 and 396;
Substitute **SECTION 6.52 CG**, as contained on the following pages A1-2n and A1-2o.

SECTION 6.44 PO
Lane Pavement Overlay

6.44PO.1. DESCRIPTION. This section describes the furnishing and application of an approved Green Asphalt Pavement Color Scheme along designated bicycle lanes and Brick-Red Asphalt Pavement Color Scheme matching Quest's StreetBondCL Terracotta color along designated Select Bus Service (SBS) lanes, as indicated in the Contract Drawings or as directed by the Engineer.

6.44PO.2. REFERENCES.

- A. ASTM D-4541 Standard Test Method for Pull-Off Strength of Coatings Using Portable Adhesion Tester.
- B. ASTM D-4060 Test Method for Abrasion Resistance of Organic Coatings by the Taber Abrasion.
- C. ASTM D-522-93A Standard Test Method for Mandrel Bend Test of Attached Organic Coatings.
- D. ASTM G-155 QUV Accelerated Weathering Environment. Standard Practice for Operating Fluorescent Light Apparatus for UV Exposure of Nonmetallic Materials.
- E. ASTM D-2486 MEK rub test for chemical resistance.
- F. ASTM D-570 Standard Test Method for water absorption of plastics.
- G. ASTM E-303 British Pendulum test for friction.
- H. EPA 24 ASTM D3960-05 Volatile Organic Compounds.

6.44PO.3. SUBMITTALS.

- A. A copy of the current year accreditation certificate available from the Contractor or subcontractor who will be performing this work, or written verification from the coating supplier that the Contractor or subcontractor is qualified to perform this Work.
- B. Written and published specification for the application of the selected asphalt pavement coating.
- C. Confirmation of coating color.
- D. Proof of coating performance through a Certificate of Analysis or equivalent document as provided by the Contractor or the coating supplier.

6.44PO.4. MATERIALS.

The following table outlines minimum performance properties of a typical asphalt pavement coating.

Characteristic	Test Specification	Measured result
Durability: Taber Abrasion resistance	ASTM D-4060 7 day cure, H-10 wheel (wet test)	< 5.0 g/1000
Water sensitivity	ASTM D-570 Water absorption after 9 days: Remaining absorption after 1 hour of recovery:	< 10% < 1.0%
Color stability	ASTM G-155 QUV 2,000 hours (CIE units)	New York City Bike Lane Green $\Delta E < 1.5$
Color stability	ASTM G-155 QUV 2,000 hours (CIE units)	Brick color $\Delta E < 1.5$

Flexibility: Mandrel Bend	ASTM D-522-93A Flexibility as measured by Mandrel bend 0.5mm thick sample passes 10 mm at 21°C 0.5mm thick sample passes 125mm at -18°C	
Chemical resistance	ASTM D-2486 Modified MEK scrubs 16 dry mils, number of scrubs until 50% substrate exposed	>5000
Adhesion to Asphalt	ASTM D-4541	Substrate Failure
Friction Wet	ASTM E-303 British Pendulum Tester	>55
Environmental Sensitivity	EPA 24 ASTM D-3960-05 Volatile Organic Compounds	VOC < 150

These properties shall be evidenced by Certificates of Analysis produced by an independent qualified testing facility.

Green Bicycle and Red Bus Lane Pavement Overlays furnished by the following manufacturers, or approved equivalent, are acceptable for use in this contract:

Ennis Paint, Inc.
1509 S. Kaufman Street
Ennis, TX 75119

Integrated Pavement Concepts, Inc.
102-17957 55th Avenue
Surrey, BC Canada V3S 6C4

Crafco, Inc.
420 N. Roosevelt Avenue
Chandler, AZ 85226

6.44PO.5. METHODS. The asphalt pavement coating system shall be applied to the pavement in accordance with the manufacturer's specification. In its hardened state the color shall be as specified, and as approved by the Engineer. The material shall present a marking whose color and chemical resistance will not degrade under normal exposure to calcium chloride, sodium chloride or automotive oils and fuels. Color pigments used shall remain stable under exposure to ultra violet light. A minimum of four (4) layers of coating material shall be applied to the pavement surface.

The Contractor shall be required to use the proper equipment in the application of the asphalt pavement coating, as per the recommendation of the coating supplier, and as approved by the Engineer.

Asphalt pavement must be stable, well compacted and generally in excellent condition for the application of the asphalt pavement coating to be successful. The Engineer shall make the final determination as to the suitability of the existing asphalt pavement.

The asphalt pavement surface shall be dry and free from all foreign matter, including but not limited to dirt, dust, de-icing materials, and chemical residue.

The asphalt pavement coating shall only be applied in the correct environmental conditions as instructed by the coating supplier, and as approved by the Engineer.

Refer to the instructions provided by the coating supplier regarding when the painted lane may be opened to traffic. Wait time is typically a function of the dry rate of the coating, and climate conditions.

The Engineer may, at his discretion, require the Contractor to remove all extraneous marks on the pavement made by the agents or employees of the Contractor, or made by others due to improper control or protection of the work area by the Contractor, his agents or employees. Any installation which, in the opinion of the Engineer, is not acceptable, whether by reason of poor workmanship, poor appearance, poor performance, poor materials, improper width or improper alignment, shall be reworked by the Contractor at no cost to the City. The Contractor shall replace rejected installation as directed by the Engineer, within fifteen (15) days after receiving written notification of the rejection of such completed work.

6.44PO.6. MEASUREMENT. The quantities to be measured for payment shall be the number of square yards of Lane Pavement Overlay, of each color, placed as specified to the satisfaction of the Engineer.

6.44PO.7. PRICES TO COVER. The unit prices bid per square yard of Green Bicycle Lane Pavement Overlay and Red Bus Lane Pavement Overlay shall cover the cost of all labor, materials, plant, equipment, insurance, and necessary incidentals required including, but not limited to, testing, cleaning, preparation of surfaces, and application of the lane pavement overlay materials, all in accordance with the contract plans and specifications, and as directed by the Engineer.

Payment will be made under:

Item No.	Item	Pay Unit
6.44 POG	GREEN BICYCLE LANE PAVEMENT OVERLAY	S.Y.
6.44 POR	RED BUS LANE PAVEMENT OVERLAY	S.Y.

SECTION 6.52 CG

Crossing Guard

6.52CG.1. INTENT. This section describes the employment of full-time uniformed crossing guards to direct and detour traffic.

6.52CG.2. DESCRIPTION. The Contractor shall furnish an adequate number of competent crossing guards to control vehicular and pedestrian traffic when it is necessary to maintain alternating one-way traffic in one lane of a two-way roadway, and at all other locations where construction operations, construction vehicles and equipment, and temporary traffic patterns related to the construction operations require positive temporary traffic control for safe, efficient traffic operations.

6.52CG.3. METHODS. All crossing guards, whether paid for under this item or not, shall be proficient in speaking, writing and reading English and adequately trained in controlling vehicular and pedestrian traffic by a recognized training program such as that provided by the American Traffic Safety Services Association, the National Safety Council, unions or construction industry associations, or by an individual who holds a current certification as a flagger training instructor from such a program.

All crossing guards, whether paid for under this item or not, their apparel, hand-signaling devices, and procedures to be used by them shall be in compliance with the requirements of Chapter 6E. FLAGGER CONTROL, in the Federal "Manual on Uniform Traffic Control Devices for Streets and Highways" 2009 Edition, or later edition, and shall each be equipped with an active two-way radio.

Prior to the start of crossing guard operations, the Contractor shall provide to the Engineer a list of certified crossing guards to be used in the contract, identifying the source of crossing guard training for each individual. When requested by the Engineer, crossing guards shall demonstrate their competency in crossing guard procedures. Crossing guards not competent in controlling vehicular and pedestrian traffic procedures to the satisfaction of the Engineer shall be retrained or replaced at once. Each crossing guard paid under this item must be a full-time crossing guard. If any worker performing services under this item is also assigned the task of directing construction equipment (as per attached Example #2, worker acting as a flagperson 'A') or any laborer tasks, then such worker shall be deemed to be subject to the provisions of Labor Law §220 Prevailing Wage Schedule and will not be paid for under this Item.

6.52CG.4. MEASUREMENT. The quantity to be measured for payment shall be the number of person-hours of uniformed crossing guard service actually performed, as authorized by the Engineer. Laborers who are not full-time crossing guard will not be measured for payment as crossing guards under this or any other item. Each uniformed crossing guard shall be required to work a minimum of eight (8) hours a day and the Contractor will be given a minimum of twelve (12) hours advanced notice by the Engineer as to when to furnish a crossing guard.

6.52CG.5. PRICE TO COVER. The contract price per person-hour shall cover the cost of all labor, materials, equipment, and insurance necessary to employ a uniformed full-time crossing guard, and equip him/her with safety vests, hard hats, and signaling devices, including all other incidental costs necessary to control and detour traffic, as shown on the Contract Drawings, the Examples #1 and #2 on pages 395 and 396 (excluding worker acting as a flagperson "A" in Example #2), or as directed by the Engineer.

Payment for flagperson "A" in Example #2, shall be deemed to be included under other items of work, as appropriate.

Where there is no scheduled item for Crossing Guard, the cost of furnishing Crossing Guards as required shall be deemed included in the unit price bid for the Maintenance and Protection of Traffic item.

Payment will be made under:

Item No.	Item	Pay Unit
6.52 CG	CROSSING GUARD	PERSON-HOUR (P/HR)

[Added 02-24-2014]

16. Refer to Pages 480 and 481, **Subsection 7.13.2.(B) MAINTENANCE OF STREETS**, 4th paragraph, beginning with the words "The Contractor shall maintain the traveled way . . . ;
Delete the 4th paragraph, in its entirety;
Substitute the following text:

"The Contractor shall maintain the traveled way in such a condition and conduct operations in such a manner that snow and ice may be readily removed by others as and when necessary, and in such a manner that proper drainage is provided for the melting of snow in the banks resulting from normal plowing. However, the Contractor will not be responsible for snow or ice removal on the pavement or traveled way opened for public usage, except within the limits of the work zone(s) which may include, but is not be limited to, stairways, promenades, esplanade areas, and sidewalk, including those fronting his office and the Engineer's field office all of which will be the responsibility of the Contractor."

3. NEW SECTIONS

SECTION 4.18 RP - Root Pruning

4.18RP.1. INTENT. Under this section, this work shall consist of cleanly pruning, existing tree roots severed during construction operations, typically related to linear excavation, as shown in the contract documents and as directed by the Engineer.

4.18RP.2. DESCRIPTION. The Contractor shall root prune designated trees in accordance with the specifications and as directed by the Engineer, under permit issued by the New York City Department of Parks and Recreation (D.P.R.) which may be obtained from the Borough's Forestry Office.

4.18RP.3. MATERIALS AND METHODS.

(A) GENERAL

All root pruning procedures must be performed in the presence of the Tree Consultant (Item 4.21). The work shall be performed where shown on the plans and as directed by the Engineer. Prior to any tree root pruning work, the Tree Consultant (Item 4.21) shall visually inspect each tree. Prior to pruning tree roots greater than 2 inches in diameter or tree roots within the tree critical root zone, Contractor shall contact the Borough Forester for approval. Pruning shall be performed in such a manner so as to avoid damage to other parts of the tree or other vegetation within proximity of the tree being pruned. The Contractor shall carefully protect from damage all existing vegetation, site features, and all other property which is to remain.

Existing tree roots greater than 1 inch in diameter, measured at the edge of excavation, shall be pruned within 24 hours of the time they have been damaged by construction activity. The severed root shall be pruned at the edge of excavation, or 1 inch beyond the entire damaged portion of the tree root if damaged root extends beyond the edge of excavation into undisturbed soil.

The excavated area around the existing tree roots shall be backfilled as soon as construction activities permit with the specified or approved materials. If the excavated area around the existing tree roots is not backfilled within 24 hours, all roots shall be kept moist, with burlap covered with white plastic to prevent desiccation. Burlap shall be checked a minimum of two times a day, once in the morning and once in the afternoon, for a minimum of 48 hours until backfill is complete as directed by the Agency. If directed, soaker hoses shall be installed to facilitate properly moist conditions of excavated areas.

(B) EQUIPMENT

Pruning shall be in accordance with ANSI A300 Part 1 *Standard Practices Pruning and ANSI Z133.1 Arboricultural Operations Safety*. All cuts shall be cleanly made with sharp tools. All tools used and methods employed shall be as approved by the Engineer prior to the start of work. The cutting surfaces of all tools, ladders, ropes, soles of workers shoes and other objects coming into contact with the tree roots shall be washed with a disinfectant at the start of any work on a tree to prevent the spread of plant diseases.

(C) ROOT PRUNING

Certain trees should not be root pruned, such as trees in poor condition or trees that are leaning. In addition, some species do not respond well to root pruning, such as tulip tree (*Liriodendron tulipifera*), Chinese evergreen elm (*Ulmus parvifolia*), and callery pear (*Pyrus calleryana*). To minimize root pruning impacts, a tree assessment shall be conducted by the Tree Consultant (Item 4.21) and the root pruning contractor or subcontractor, prior to pruning. Both tree and site conditions need to be evaluated to determine the potential for injury and structural stability loss. The tree assessment shall list the species

proposed for root pruning, the size in caliper of each tree and their locations, and shall be provided to the Engineer for his approval.

Root pruning of the tree shall be performed where directed by the Engineer, in consultation with the Tree Consultant (Item 4.21). At the conclusion of root pruning, the Contractor shall fertilize the tree with a fertilizer recommended by the Tree Consultant (Item 4.21) (Arborist) to stimulate root growth, and thoroughly water the tree. The Contractor shall further water the tree weekly for three months following the root pruning operations, then twice a month for the next three months, and finally, on a monthly bases for the next three months. The Contractor's responsibilities for watering the tree shall end after nine (9) months.

The Contractor shall be liable for any and all damage caused by root pruning operations to adjacent or nearby trees, plants and other growth, features and other real property. All damaged trees, plants, other growth features and other real property, and vehicles shall be replaced or restored or provided for to their original condition to the satisfaction of the Engineer.

(D) CLEANING AND DISPOSAL

All pruned materials and all other debris shall be removed from the site within 24 hours, and disposed of as directed by the Engineer.

4.18RP.4. MEASUREMENT. The quantity to be measured for payment shall be the number of trees actually root pruned to the satisfaction of the Engineer.

4.18RP.5. PRICE TO COVER. The contract price for Root Pruning shall be a unit price per each tree root pruned and shall cover the cost of all labor, materials, plant equipment, inspection, insurance and incidentals required to complete the work including, but not limited to, watering and fertilizing the tree, all in accordance with the Contract Drawings, the specifications and the directions of the Engineer.

Maintenance Tree Pruning and the Transplanting of Trees shall be paid under separate items.

Payment will be made under:

Item No.	Item	Pay Unit
4.18 R	TREE ROOT PRUNING (UNDER 12" Caliper)	EACH
4.18 RP	ROOT PRUNING (12" Caliper and Larger)	EACH

**SECTION 6.02 P
PNEUMATIC EXCAVATION AND BACKFILLING AROUND TREES**

6.02-P.1. INTENT.

The intent of this section is to perform pneumatic excavation and backfilling work at locations where trees exist within the work area and are required to remain, requires the protection of tree roots during excavation and backfilling, and implements, as needed, a temporary excavation support system. Work covered under this section shall be performed at the locations indicated on the Plans, in accordance with the contract documents, and as directed by the Engineer.

6.02-P.2. CONSTRUCTION DETAILS.

The work shall be in accordance with the Plans, and as directed by the Engineer. Prior to any pneumatic excavation work, the following shall be performed:

(A) WORK SITE SAFETY

Pneumatic excavation shall be performed in compliance with all applicable OSHA regulations and the manufacturer's operating instructions. Adequate eye and ear protective equipment shall be worn by all crew members present at the work site. The Contractor shall be responsible to provide adequate equipment and perform pneumatic excavation techniques properly to preclude movement of any air-borne soils onto adjacent roadways or other areas beyond the designated work zone limits. Failure to contain and/or collect the excavated soil will result in the immediate termination of pneumatic excavation until soil containment and/or collection procedures are determined adequate by the Engineer. The Contractor shall keep the public at a safe distance from the work zone at all times by means approved by the Engineer.

(B) OPERATOR QUALIFICATIONS

The excavating tool shall be utilized only by personnel having at least one year of experience operating the pneumatic excavation tool. The Contractor shall submit to the Engineer written certification from the equipment manufacturer or supplier of the operator's training and experience in the use of the pneumatic excavation tool.

(C) CERTIFIED ARBORIST

Unless otherwise directed by the Engineer, all pneumatic excavation work shall be performed under the direction of the Tree Consultant (Item 4.21) and approved by the New York City Department of Parks and Recreation (NYCDPR).

(D) PRE-PNEUMATIC EXCAVATION MEETING

Prior to the start of such excavation, the Contractor and its approved Operator for pneumatic excavation shall attend a meeting arranged by the Engineer, Certified Arborist and other parties as appropriate, to review the requirements of this item including the schedule of operations, the mandatory presence of the Arborist, safety measures, reporting, etc. The contractor is required to submit a schedule of his anticipated pneumatic excavations at this meeting.

(E) SUBMITTAL OF SHOP DRAWINGS

Where required, the Contractor shall submit design shop drawings for any temporary excavation support system to be used during the pneumatic excavation work. The shop drawings shall be prepared, signed, and sealed by a Professional Engineer currently licensed in the State of New York. The shop drawings shall be submitted to the Engineer at least two (2) weeks before commencement of excavation. Excavation work may not commence until the shop drawings are approved by the Engineer.

6.02-P.3. RESPONSIBILITIES OF THE CONTRACTOR.

Prior to bidding, the Contractor shall examine the site and available information, and formulate methods of construction that will not result in any damage to existing trees during excavation and backfilling. In any

event, the Contractor will be held liable for irreparable and/or irreversible damage to any trees harmed due to the Contractor's methods.

6.02-P.4. MATERIALS.

Materials shall meet the following requirements, as modified by any supplemental landscape specifications or special notes included in the contract documents. Where indicated, refer to the latest revision/edition of the New York State Department of Transportation Standard Specifications (NYSDOT SS):

(1) PNEUMATIC EXCAVATING TOOL. Excavation shall be performed through the use of a pneumatic excavation tool with the following requirements:

(a) The high air velocity excavation tool shall be specifically designed to fracture, pulverize, and displace porous and semi-porous soils without harming or causing damage to tree roots, existing subsurface utilities or other non-porous objects.

(b) The Contractor shall submit catalog cuts from the manufacturer verifying that the Pneumatic excavation tool meets the following criteria:

Rated Operating Pressure: 6.2 – 7.0 bar (101.5 psi)

Air Stream Velocity at Cutting Head: 2,200 – 2,500 km/hr (2,000 – 2,275 ft/sec)

Air Displacement: 2,800 – 5,000 liter/min (100 – 180 ft³/min)

(2) AIR COMPRESSOR. The air compressor may be either a portable or truck-mounted unit and shall be adequately sized as required to power the pneumatic excavation tool in accordance with the manufacturer's recommendations for the pneumatic excavating tool.

(3) VACUUM TRUCK. A vacuum truck should be used to collect excavated spoil directly from the trench or pit.

(4) CONTAINMENT STRUCTURE. To prevent the spread of excavated soil onto adjacent roadways and areas beyond the designated work zone limits, the Contractor shall provide a mobile structure or barrier to contain the material dislodged by the pneumatic excavation tool from the trench or pit. Timber or corrugated metal shields, tents supported on tubular frames or other structures as approved by the engineer may be used.

(5) ROOT PROTECTION. The following are required for root protection:

<u>Item</u>	<u>NYSDOT SS Section</u>
Burlap	711-06

(6) BACKFILL. The following are required for backfill material in landscape areas unless otherwise indicated on the plans in accordance with the contract documents, and as directed by the Engineer:

<u>Item</u>	<u>NYSDOT SS Section</u>
Topsoil	713-01
Limestone	713-02
Fertilizer	713-03
Organic Material	713-15

For backfill material in hardscape areas, see locations indicated on the Plans in accordance with the contract documents, and as directed by the Engineer.

6.02-P.5. EXCAVATION PROCEDURES.

The Contractor shall meet all requirements of this section, including transmitting any required submittals.

(A) DUST CONTROL

The work area shall be watered thoroughly at least twenty-four (24) hours in advance of, but no more than forty-eight (48) hours prior to the start of any pneumatic excavation to reduce the incidence of airborne dust resulting from the pneumatic excavation operation.

(B) EXCAVATION – GENERAL

All excavation using the pneumatic excavation tool shall be performed in accordance with the manufacturer's recommendations to remove soil without damage to the roots of trees, buried structures, and/or utilities either in or adjacent to the excavation. The Contractor shall excavate within limits designated for pneumatic excavation shown on the Contract Plans, or as directed by the Engineer, using the pneumatic excavating tool. When working near utilities, the Contractor shall be responsible to locate underground facilities as required under 16 NYCRR Part 753.

(C) EXCAVATION – TEMPORARY EXCAVATION SUPPORT SYSTEM

Approved sheeting and bracing shall be used where necessary to support the sides of the excavation, in order to: prevent damage to subsurface structures and adjacent buildings; safeguard persons and property; minimize inconvenience to traffic and the public; protect the structure to be installed; support the adjacent tree(s); and provide suitable and safe working conditions. Except as otherwise provided, deviations from the above will be permitted only where, in the judgment of the Engineer, such exception will not result in any of the hazards described above.

In cases where sheeting and bracing will not adequately protect adjacent structures from damage and settlement, the Contractor will be required to use such measures as are necessary to safely support and maintain adjacent and abutting property and structures, support the tree without causing damage to the tree, and to maintain the work safe to life, limb, and property.

All sheeting and bracing systems that the Contractor elects to use or that are ordered to use by the Engineer of the Department shall comply with the requirements of Section 40.05, "SHEETING AND BRACING," of the NYC Department of Design and Construction, Division of Infrastructure, Standard Sewer and Water main Specifications, and must receive the approvals stated therein.

Unless otherwise specified in the Contract Drawings or these Specifications or specifically permitted in writing by the Engineer, the Contractor shall be required to withdraw and remove all sheeting and bracing simultaneously with the backfilling of trenches and excavations.

(D) ROOT PROTECTION

The Contractor shall place wet burlap or cotton mats upon both the fibrous and structural roots immediately after they have been exposed by the pneumatic excavating tool. The burlap or cotton covering may be removed to perform inspection or utility installation operations, but the Contractor shall be required to keep the burlap or cotton towels wet and the roots moist until backfilling is complete.

The Engineer shall be immediately informed of any damaged tree roots. No tree roots may be pruned except as specifically authorized by the Arborist. In the case that the concentration of roots obstructs the placement of utilities, footings, or other structures, limited pruning may be necessary as directed by the Arborist. Tree roots in excess of one (1) inch in diameter, measured at the edge of the excavation, shall be cut cleanly at the edge of excavation using a sharp cutting tool. All root pruning shall be performed under the direction of the ISA Certified Arborist.

(E) UTILITY INSTALLATION

Utilities shall be installed as shown on the drawings, including bedding materials. In order to facilitate backfilling on an expedited basis, the Contractor shall install the materials for utilities in a continuous operation along with the pneumatic excavation operations to allow for backfilling of the trench within the same work shift.

Exposed root systems may impede utility installation within an open trench. Therefore, workers shall pass each individual item of utility construction carefully through the root system for placement and assembly within the excavated trench.

(F) BACKFILLING OPERATIONS

Excavations containing exposed tree roots shall be backfilled immediately after the Engineer inspects and approves the required construction work. The Contractor shall provide adequate work crews to backfill the excavated area within twenty-four (24) hours of excavation. Upon completion of inspection of installation work, the Contractor shall remove the burlap or cotton matting and commence backfilling operations.

Suitable excavated material may be used as backfill up to a depth of twelve (12) inches below finished grade. The existing soil shall be amended with humus, peat, peat moss, or source-separated compost in the ratio of one part organic to seven parts excavated soil. If required, provide additional clean backfill material. The Contractor shall properly dispose of excess and unsuitable excavated materials.

Backfilling shall be performed with care not to damage the exposed roots. The Contractor shall compact the backfill material under the direction of the ISA Certified Arborist. The Contractor shall compact the backfill material to be commensurate with the density of the undisturbed adjacent soils unless otherwise directed by the ISA Certified Arborist. Surface restoration including backfilling the twelve (12) inches of the excavation with approved topsoil, shall be performed separately under the appropriate items.

(G) TREE CONDITION REPORT

The Contractor shall supply the ISA Certified Arborist with information as needed for the Arborist to prepare periodic reports to the Engineer summarizing the number, type, and condition of trees adjacent to each area of pneumatic excavation; indicating the duration of open excavation; and identifying any root damage and actions taken.

6.02-P.6. PRICE TO COVER.

The contract price for "PNEUMATIC EXCAVATION AND BACKFILLING AROUND TREES" shall be the unit price bid to perform the work described herein, at the locations and to the limits indicated on the Plans. The unit price shall include the cost of all labor, materials, plant, equipment, professional engineering design services, and insurance needed to perform the work, including all other work incidental thereto all in accordance with the specifications and as directed by the Engineer. Disposal of excess and unsuitable materials shall be included in the unit price bid for Item 6.02 PA "PNEUMATIC EXCAVATION AROUND TREES."

Should Sheeting and Bracing be required, the cost of such work shall be deemed included in the prices bid for the respective items of the contract.

No separate payment will be made for replacement trees required by NYCDPR that the Contractor shall acquire and plant as a result of damage to trees caused by the Contractor's excavation and/or backfilling methods.

Payment will be made under:

Item No.	Item	Pay Unit
6.02 PA	PNEUMATIC EXCAVATION AROUND TREES	C.Y.
6.02 PB	BACKFILLING AROUND TREES	C.Y.

SECTION 6.74 B - Steel Edging Strip**6.74B.1. DESCRIPTION.**

Under this section, the Contractor shall furnish all labor, material, plant, equipment, and incidentals necessary to furnish and install steel edging strip as shown on the plans, and in accordance with specifications and the directions of the Engineer.

6.74B.2. MATERIALS.

Steel edge shall consist of lengths of hot rolled steel sections, one quarter (1/4") inch thick by five (5") inches in depth by twenty (20') feet in length. Tapered steel stakes, eighteen (18") inches long, shall be spaced thirty (30") inches on center along the length of the edging. Joints between edging strips shall be overlapped as indicated on the plans. All edging and stakes shall be shop painted with weather resistant paint. Color of paint is to be green as approved by the Engineer. Steel edging shall be "Ryerson Steel Edge" as manufactured by Ryerson-Thypin Steel Co., Eastern, PA.; "Steel Landscape Edging" by Border Concepts, Charlotte, NC; "Landscape and Driveway Edging" by Fisher Bros. Steel Corp., Englewood, NJ; or, approval equivalent.

6.74B.3. CONSTRUCTION METHODS.

The steel edging shall be installed true to line and grade in accordance with the designs indicated on the plans. All bends and curves shall be smooth and uniform. Where bends or curves are of such radius as to make field bending impracticable, they shall be made in the shop. All joints shall be welded as shown on the plans.

6.74B.4. MEASUREMENT.

The quantities to be measured for payment shall be the total number of linear feet of steel edging strip actually installed to the satisfaction of the Engineer. No additional measurement will be made for laps.

6.74B.5. PRICE TO COVER.

The contract price bid per linear foot for Steel Edging Strip shall cover the cost of all labor, material, plant, equipment, insurance, and incidentals required to furnish and install steel edging strip including, but not limited to, stakes as required, all in accordance with the plans, the specifications and the directions of the Engineer.

Payment will be made under:

Item No.	Item	Pay Unit
6.74 B	STEEL EDGING STRIP	L.F.

SECTION 7.68 A Geogrid

7.68A.1. INTENT. This section describes the installation of Geogrid in tree root zones that will receive structural soil backfill for the purpose of preventing roots from heaving nearby walls and pavements.

7.28A.2. DESCRIPTION. Under this section, the Contractor shall furnish and install biaxial geogrid in the manner shown on the Contract Drawings. The purpose of the geogrid is to prevent roots from heaving nearby walls and pavements by spreading the force of upward root pressure over wider area and beyond.. The geogrid shall be installed in accordance with the Contract Drawings, the specifications and the directions of the Engineer and ISA Certified Arborist.

7.68A.3. DEFINITIONS.

- (A) Geogrid: A biaxial polymeric grid formed by a regular network of integrally connected tensile elements with apertures of sufficient size to allow interlocking with surrounding soil, rock, or earth to function primarily as reinforcement.
- (B) Minimum Average Roll Value (MARV): Property value calculated as typical, minus two standard deviations. Statistically it yields a 97.7 percent degree of confidence that any sample taken during quality assurance testing will exceed value reported.

7.68A.4. SUBMITTALS.

Certification: The Contractor shall provide to the Engineer a certificate stating the name of the manufacturer, product name, style number, chemical composition and other pertinent product information to fully describe the geogrid. The certification shall state that the furnished geogrid meets MARV requirements of the specification as evaluated under the Manufacturer's quality control program. The certification shall be attested to by a person having legal authority to bind the Manufacturer.

7.68A.5. QUALITY ASSURANCE.

- (A) Geogrids shall be subject to sampling and testing to verify conformance with this specification. Verification shall be based on manufacturer's certifications as a result of testing by the manufacturer of quality assurance samples obtained using the ASTM D4354 Procedure "B" for Sampling for Manufacturer's Quality Assurance (MQA) Testing. A lot size shall be considered to be the shipment quantity of the given product or a truckload of the given product, whichever is smaller.
- (B) Geogrid labeling, shipment and storage shall follow ASTM D4873. Product labels shall clearly show the manufacturer or supplier name, style and roll number.
- (C) Each geogrid roll shall be wrapped with a material that will protect the geosynthetic fabric from damage due to shipment, water, sunlight, and contaminants.
- (D) During storage, geogrid rolls shall be elevated off the ground and adequately covered to protect them from the following: site construction damage, precipitation, extended ultraviolet radiation including sunlight, chemicals that are strong acids or strong bases, flames including welding sparks, excess temperatures, and any other environmental conditions that may damage the physical property values of the geogrid.

7.68A.6. MATERIALS.

- (A) Reinforcement Geogrid
 - 1. Polymers used in the manufacture of geogrids shall consist of multiple layers of high strength, extruded, biaxially oriented, polypropylene geogrids. The layers shall be rolled and stitched or

welded together without superimposing the grids, creating a geogrid with random sized apertures designed to accommodate a variety of fill materials.

2. The random aperture geometry, many tensile elements and multiple layers of the geogrid will enhance soil/geogrid interactions. "Punched and drawn" products shall not be acceptable.
3. The following geogrids and manufacturers, or an approved equal, may be incorporated into the work:
 - a. BaseGrid 22 by US Fabrics Inc., Cincinnati, OH
 - b. Tenax MS 220 by Syntec, Baltimore, MD
 - c. MacGrid EB2 by Maccaferri Inc., Williamsport, MD
4. The geogrid shall meet the requirements of Table 1. All numeric values in Table 1 represent MARV in the specified direction.

TABLE 1 – GEOGRIDS TECHNICAL CHARACTERISTICS

TECHNICAL CHARACTERISTICS	TEST METHOD	UNIT	MD	TD	NOTES
Strengths and Load Capacity: Peak Tensile Strength	ASTM D 6637	lb/ft (kN/m)	925 (13.5)	1,400 (20.5)	a,c,e
True Tensile Strength in Use: @ 2% Strain @ 5% Strain	ASTM D 6637	lb/ft (kN/m)	301 (4.4) 616 (9.0)	450 (6.57) 920 (13.42)	a,c,e
True Initial Modulus in Use	ASTM D 6637	lb/ft (kN/m)	15,508 (226)	24,667 (360)	a,c,e
Tensile Modulus: @ 2% Strain @ 5% Strain	ASTM D 6637	lb/ft (kN/m)	15,050 (220) 12,320 (180)	22,500 (328) 18,400 (269)	a,c,e
Structural Integrity: Junction Tensile Strength: @ 1% Strain @ 2% Strain	GRI&GG2	lb/ft (kN/m)	170 (2.48) 235 (3.44)	200 (2.92) 300 (4.38)	b,e
Junction Tensile Modulus: @1% Strain @ 2% Strain	GRI&GG2	lb/ft (kN/m)	17,000 (248) 11,780 (172)	20,000 (292) 15,000 (219)	b,e
Junction: Strength Efficiency	GRI&GG2	lb/ft (kN/m) %	835 (12.2) 90	1,315 (19.2) 90	a,e
Flexural Rigidity	ASTM D 1388	mg-cm	250,000	250,000	b
Pullout Coefficient of Interaction	ASTM D 6707		> 1.0	> 1.0	d
Durability: Resistance to Installation Damage	ASTM D 5818	%SC/% SW/%GP	>90/>90/90	>90/>90/90	f

Notes:

a. 95% lower confidence limit values, ISO 2602
b. Typical value
c. Tests performed using extensometers

d. Single layer value
e. MD: Machine direction (longitudinal to the roll)
TD: Transversal direction (across the roll width)

f. Tenax report GRID-TE-4: "Construction Damage Tests of Geogrids"

- (B) Manufacturing Quality Control: Testing shall be performed at a laboratory accredited by The Geosynthetic Accreditation Institute-Laboratory Accreditation Program (GAI-LAP) and American Association for Laboratory Accreditation (A2LA) for test required for the geosynthetic at a frequency meeting or exceeding ASTM D 4354.

7.68A.7. METHODS.

(A) Preparation

The installation site shall be prepared by clearing, grubbing and removal of vegetation, stumps and other organic material, along with any large boulders and sharp objects. After the ground has been prepared, the geogrid shall be placed over the entire area that is to be covered by the aggregate as shown in the drawing plans or as directed by the ISA Certified Arborist.

(B) Installation

1. Unroll geogrid as smooth as possible on the non-woven separation fabric and prepared sub-grade, in the direction of pavement. Install the geogrid in the longest continuous practical length, free from tension, stress, folds, wrinkles and creases.
2. All seams shall be overlapped a minimum twelve (12") inches. No equipment, materials or machinery shall be placed on or be transported over exposed geogrid. Broken stone shall then be carefully placed to prevent dislocation of the geogrid.
3. Tie adjacent rolls with joint fasteners in accordance to the manufacturer's recommendations.
4. Construction vehicles are not permitted directly on the geogrid.
5. Prior to covering, the geogrid shall be inspected by the Engineer to ensure that the geogrid has not been damaged during installation. Damaged geogrid, as identified by the Engineer, shall be repaired immediately. If the geogrid is damaged during installation, the rupture shall be removed and the damaged area shall be covered with a new geogrid patch which will overlap the undamaged fabric a minimum twelve (12") inches in all directions. All repaired geogrid surface costs will be deemed part of the price bid.
6. If placement of the backfill material causes damage to the geogrid, the damaged area shall be repaired as previously described above. The placement procedure shall then be modified to eliminate further damage from taking place.

7.68A.8. MEASUREMENT. The quantity to be measured for payment shall be the number of square yards of geogrid satisfactorily installed, computed between the limits specified by the Engineer. No quantity will be included for material used for repair of tears or for material used at the overlaps.

7.68A.9. PRICE TO INCLUDE. The unit price bid per square yard for Geogrid shall include the cost of furnishing all labor, materials, plant, equipment, insurance and incidentals necessary to complete the work of furnishing and installing the geogrid, all in accordance with the plans, the specifications and the directions of the Engineer.

Payment will be made under:

Item No.	Item	Pay Unit
7.68 A	GEOGRID	S.Y.

**SECTION 8.32
Bark Chip Mulch**

8.32.1. DESCRIPTION. Under this section, the Contractor shall furnish and place Bark Chip Mulch in accordance with the plans and specifications and as directed by the Engineer.

8.32.2. MATERIAL. Bark Chip Mulch shall be a natural forest product of 98% bark containing less than 2% wood or other debris. It shall be of white or Red Fir and/or Pine bark of a uniform grade with no additives or any other treatment. Size of bark shall be from 5/8" to 1-1/4". The ph factor should range from 5.8 to 6.2.

8.32.3. METHODS. Bark Chip Mulch shall be applied where required on the plans or directed by Engineer as a ground cover to the surface of beds and tree pits after the planting is completed. Mulch shall be applied to a uniform depth of three (3") inches and shall be so distributed as to create a smooth, level cover over the exposed soil. Plants shall not be covered.

8.32.4. MEASUREMENT. The quantity of Bark Chip Mulch to be paid for will be the number of square yards of ground surface area that has been satisfactorily covered with bark chip mulch within limits of enlarged tree pits surrounding existing trees as indicated on the Contract Drawings and where directed by the Engineer.

8.32.5. PRICE TO COVER. The unit price bid per square yard for Bark Chip Mulch shall cover the cost of all labor, materials, plant, equipment, insurance, and incidentals necessary to complete the work under this section in accordance with the Contract Drawings, the specifications and the directions of the Engineer.

No payment will be made under this item for furnishing and placing mulch in tree pits around newly planted or transplanted trees.

Payment will be made under:

Item No.	Item	Pay Unit
8.32	BARK CHIP MULCH	S.Y.

ITEM NYC-610.0112 - APPLYING MYCORRHIZAL FUNGI

NYC-610.0112.1. DESCRIPTION.

This item covers the materials requirements for mycorrhizal fungi.

NYC-610.0112.2. MATERIALS

Mycorrhizal fungi shall be commercially available products suited to and labeled for the intended purpose.

Products for turf establishment shall be granular (when mixed directly with soil), or soluble powder or liquid (when mixed with seeds for drill seeding or hydroseeding) and shall typically include:

- Endomycorrhizal fungi. Live propagules (spores, colonized roots, hyphae) of vesicular arbuscular (VA) fungi including Glomus intraradices and at least two other Glomus species shown to be biologically adapted to grass.

Products for planting pits, beds and Tree Root Zone Treatment (Radial Trenching/Aeration) shall typically be granular and shall typically include:

- Endomycorrhizal fungi. Live propagules (spores, colonized roots, hyphae) of vesicular arbuscular (VA) fungi including Glomus intraradices and at least two other Glomus species.
- Ectomycorrhizal fungi. Live spores of Pisolithus tinctorius and at least four Rhizopogon species.

Products may also include any or all of:

- Biostimulants such as Dry soluble yucca extract (yucca schidigera), soluble sea kelp extract (ascophylum, nodosum) and humic acid (leonardite humates)
- Amino acids, vitamins, enzymes, beneficial bacteria, microbial metabolites, trichoderma fungi.
- Water management gels/polymers (for planting pits, beds and Tree Root Zone Treatment – typically not for turf applications).

NYC-610.0112.3. CONSTRUCTION DETAILS

Packaging: Mycorrhizal fungi shall be delivered in the manufacturer’s standard containers. Containers shall include a label stating the name of the material, species, propagule counts, application rates, expiration date, the net weight of the contents, and the manufacturer’s name.

NYC-610.0112.4. METHOD OF MEASUREMENT

The quantity of Mycorrhizal fungi shall to be paid for under this Item shall be the number of pounds applied in accordance with the plans, specifications, and directions of the Engineer.

NYC-610.0112.5. BASIS OF PAYMENT.

Mycorrhizal fungi will be accepted on the basis of the manufacturer’s label or material certification indicating compliance with these specifications. The City reserves the right to reject any material that has become caked or otherwise damaged. Material that has expired will be rejected. There is no additional payment for this item.

Payment will be made under:

Item No.	Item	Pay Unit
NYC-610.0112	APPLYING MYCORRHIZAL FUNGHI	LBS.

ITEM NYC-610.01940082 - APPLYING COMPOST

NYC-610.01940082.1. DESCRIPTION.

This work includes supplying compost and incorporating it into the soil in areas where turf will be seeded and in other areas as directed by the contract documents or the Engineer.

NYC-610.01940082.2. MATERIALS.

Compost shall meet the requirements of NYSDOT Standard Specification Section 713-15 wherein it is referred, Organic Material, "Source-separated compost" and/or "Composted Sewage Sludge" which has been collected, composted, treated, and/or handled in such a way that it contains no soil-borne diseases or viable weed seeds, root stalks, rhizomes, or stolons.

Shop Drawings - For Shop Drawing Requirements, See Section 1.06 of the NYCDOT Standard Highway Specifications.

NYC-610.01940082.3. CONSTRUCTION DETAILS.

The Contractor shall provide the Engineer with a complete written description of the compost to be used including source, composition, and treatment or processing procedures used by the supplier. Compost shall be evenly spread to a depth of 2 inches over all areas where turf will be seeded unless directed otherwise by the contract documents or the Engineer. The compost shall be thoroughly mixed with the top 4 inches of existing soil to create a total seed bed depth of 6 inches unless directed otherwise by the contract documents or the Engineer. Mixing may occur by any method which does not compact the soil and may occur at any time when the soil is not frozen and is not too wet to work. The soil is too wet to work when a handful of it, squeezed together, will not crumble or break apart when released.

NYC-610.01940082.4. MEASUREMENT.

Applying Compost will be measured as the number of cubic yards, measured to the nearest whole cubic yard, of approved compost which has been incorporated into the soil as directed by the contract documents or the Engineer.

NYC-610.01940082.5. BASIS OF PAYMENT.

The unit price bid shall include the cost of all labor, materials, equipment, insurance and necessary incidentals required to complete the work as specified.

Payment will be made under:

Item No.	Item	Pay Unit
NYC-610.01940082	APPLYING COMPOST	CUBIC YARD

Revised for HWQ121B4
Dated: 03/09/2015

4. SPECIAL PROVISIONS

The following shall become a part of and apply to the Contract:

A. LINES AND GRADES. The Contractor shall furnish lines and grades in accordance with Section 1.06.27 of the Standard Specifications, except that survey controls established for this project may no longer exist and the Contractor shall be required to re-establish the survey control information using official Borough Survey Control Monuments and Bench Marks, where they exist. The Contractor shall check with Topographic Section of the Borough President's Office as to the reliability and accuracy of the data to be used for lines and grades.

In addition, under Item No. 6.41 the Contractor shall be required to establish lines and grades and stake out and layout the work. Stake outs shall be maintained and/or reset, as directed by the Engineer, throughout the entire duration of the project. At the completion of the work the Contractor shall survey the entire work site area to provide the Engineer with as-built elevations and locations of top of curb, at ends of construction, at all street hardware, and breaks in grades.

B. SPECIFIC TRAFFIC STIPULATIONS. Under this contract, the Contractor shall perform the work in strict accordance with the requirements of Section 6.70 in the Standard Highway Specifications, specific traffic stipulations as called for on the plans, OCMC Traffic Stipulations attached to the end of these Special Provisions, and the directions of the Engineer. In case of a conflict, the Engineer's decision shall be final.

In addition, the cost of compliance with requirements of the OCMC Traffic Stipulations, unless otherwise provided for, shall be deemed included in the prices bid for all scheduled items.

C. HOLIDAY CONSTRUCTION EMBARGO. A special Holiday Construction Embargo shall be in effect on the Friday of the week preceding Thanksgiving Day week from 6:00 AM to 11:59 PM and again from the Monday of Thanksgiving Day week from 6:00 AM through January 2, at 11:59 PM. Roadway and sidewalk construction activities will be restricted during the embargo period on the streets listed below*.

Any permits issued prior to the date of this notice, for work during this embargo period on the streets listed below which do not already have the permit stipulation "410" are hereby suspended for the period noted above. All permittees must comply with this embargo unless a special waiver is granted by OCMC. Waiver requests must be filed at least thirteen days before Thanksgiving Day, in the Permit During "Embargo Periods" and submitting supporting documentation.

-
- * Please note that this embargo only applies to NYCDOT construction permits.
 - * List of street and maps of the affected locations are available by borough on the Department of Transportation's website at:
<http://www.nyc.gov/html/dot/html/motorist/trafalrt.shtml>

Waiver requests should only be submitted for critical reasons for a specific project. If a waiver is granted, the applicant will be notified so they can apply for the approved permits. Waivers **are not** required for ongoing Building Construction Activity Permits which already include the "410" permit stipulation. Waiver request forms may be obtained at any Permit Office or on the Department of Transportation's website at:

<http://www.nyc.gov/html/dot/downloads/pdf/holidayembapp.pdf>

Prior to this embargo period all necessary measures must be taken so that all roadways and sidewalks are in proper condition to allow for the expeditious and safe movement of vehicular, bicycle and pedestrian traffic. Tool carts, cable reels, containers, and material stored on roadways must be removed during the embargo period.

The opening of utility access covers is prohibited on any of the streets noted below between the hours of 6:00 AM and midnight unless the utility or Contractor files for an Emergency Authorization Number as required by section 2-07 of the Department of Transportation's Highway Rules. The planned opening of utility access covers may occur during the hours of 12:01 AM and 5:59 AM where no authorization number is required.

Temporary restoration of the streets and sidewalks and removal thereof, if required for the Holiday Embargo period, will be paid for under the appropriate scheduled items.

No extension of time due to the shutdown period will be granted to the Contractor for completion of the work.

D. DISPOSAL OF EXCESS EXCAVATED MATERIAL. All excess excavated material, with the exception of contaminated material, shall become the property of the Contractor and shall be properly disposed of away from the site, at the Contractor's expense. Contaminated material shall be disposed of separately in accordance with contract requirements.

E. CONTRACT ITEMS THAT INCLUDE BACKFILL AS A PART OF THEIR WORK. The following shall pertain to all contract items that have backfill as a part of their work: Backfilling shall comply with Subsection 4.11.3 of the Standard Specifications and no additional payment will be made for any Highway or Street Lighting work item requiring Contractor to furnish additional fill material to meet these requirements when backfilling.

F. SCHEDULING PRESENTATION. The Contractor shall submit construction schedule in the form of a bar chart using "Microsoft Project 2010", or in an approved equivalent program which shall be directly and fully translatable into Microsoft Project 2010 format, within seven days of the initial Pre-Construction Meeting. Each bar in the chart shall show dates the Contractor plans to start and complete each construction activity after the initial Pre-Construction Meeting. Bar chart shall show the order and interdependence of all activities necessary to complete the work and the sequence in which activity is to be accomplished as planned by the Contractor and in accordance with all

subcontractors or suppliers whose work shall be shown on the bar chart. The Contractor shall submit the bar chart for the Engineer's review and revise it, if required, until approved by the Engineer.

The Contractor shall submit weekly progress status update reports or as otherwise directed by the Engineer. The Contractor shall submit updated bar chart every month. The revised bar chart shall be made in the same form and detail as the original submittal and shall be accompanied by an explanation of the reasons for the revisions all of which shall be subject to approval by the Engineer.

G. ACCELERATED PROJECT SCHEDULE AND COMBINATION OF STAGES.

Contractor shall plan and/or stage his/her work schedule using all hours/days available. Contractor is advised that all applicable unit prices shall include, for the purpose of this contract, all overtime costs, premium time costs, shift differentials required to complete construction within the specified "Time(s) of Completion" stipulated in this contract.

Contractor shall be permitted to accelerate this project, to combine stages and/or work sequences. Any such changes shall be shown in the construction schedule, to be furnished in accordance with the General Provisions of the Standard Specifications and the above "SCHEDULING PRESENTATION" Article, and shall be submitted for approval of the Engineer.

H. NO EXTENSION OF TIME FOR WINTER SHUT-DOWN. Where the Contractor's approved work schedule for installing sidewalk, curb, roadway base and/or pavement falls within the winter period of December 1st through April 1st, the Contractor will NOT be granted an extension of time for completion of this contract due to the winter shut-down period, unless otherwise provided in Schedule A.

I. PRIVATE UTILITY HARDWARE ADJUSTMENTS will be performed by the owning utility company or its agent, at its expense. The Contractor shall notify the utility company 72 hours prior to start of work at each location where it's hardware requires adjustment.

J. SURVEY MONUMENTS. When working in the vicinity of survey monument the Contractor shall hand excavate per Item 8.02 A and 8.02 B at City Survey Monuments, for a distance of five (5) feet around each monument, as directed by the Engineer.

K. RESTORATION OF ADJACENT AREAS. The Contractor shall be required to remove all form work. In planting strip areas, the Contractor shall be required to restore areas damaged as a result of its operations, to the satisfaction of the Engineer, with sod. The Contractor shall also, as directed by the Engineer, make safe adjacent areas to its work, such as: restoring missing or damaged pavement markings that were removed or damaged as a result of the Contractor's operations (as per requirements of Section 6.44 in the Standard Specifications); resetting granite blocks in tree pits; and, applying asphaltic concrete mixture (Item 4.02 CB) where badly broken sidewalk

or curb may create a dangerous condition just outside his area of operation, where and when directed by the Engineer.

All restoration work shall be done to the satisfaction of the Engineer.

L. THE CONTRACTOR IS NOTIFIED that wherever the Item No. "6.52" and words "flagger" and "flagperson" are used in the Contract Documents and Drawings it shall mean the Item No. "6.52 CG" and the words "Crossing Guard".

The Contractor is advised that until the Comptroller of the City of New York sets a prevailing wage rate for crossing guards, there are no prevailing wage rates for crossing guards.

M. THE CONTRACTOR IS NOTIFIED that for use of City water under this project the Contractor shall be required to obtain all necessary permits from the Department of Environmental Protection, at no cost to the Contractor in accordance with the NYC Department of Environmental Protection, Standard Sewer and Water Main Specifications, dated July 1, 2014, Section 12.04 "TEMPORARY USE OF CITY WATER ON CONSTRUCTION PROJECTS".

N. THE CONTRACTOR IS NOTIFIED that the fuel cost per gallon used in the formula under Sub-Article 26.2.8 of the Standard Construction Contract for Extra Work will be derived from the fuel price index for the United States East Coast published weekly by the United States Energy Information Administration ("USEIA"), and available on its website at <http://www.eia.gov/petroleum/gasdiesel/>. The USEIA-published cost per gallon for the applicable fuel on the East Coast for the week in which the first day of each calendar quarter during the contract term occurs (i.e., January 1st, April 1st, July 1st and September 1st) will be used in the reimbursement formula for all Extra Work invoiced that was performed during that calendar quarter. Should the USEIA stop publishing this fuel price index, the fuel cost per gallon will be determined by reference to a substitute index to be agreed upon by the Contractor and the City.

O. START OF CONTRACT WORK. The Contractor is notified that a Notice To Proceed (NTP) date will be issued for work to commence within 21 to 30 Days of Contract Registration.

P. PRICES TO INCLUDE. No direct payment will be made for costs incurred in complying with the foregoing Special Provisions, unless otherwise provided. Said costs will be deemed to have been included in the prices bid for all the scheduled contract items.



Department of Transportation

JANETTE SADIK-KHAN, Commissioner

OCMC TRAFFIC STIPULATIONS

April 17, 2013

OCMC FILE NO: QEC 13-155
CONTRACT NO: HWQ121B4
PROJECT: ROADWAY, SIDEWALK, CURB, STREET LIGHTING AND TRAFFIC SIGNAL. INSTALLATION OF STORM/SANITARY SEWERS AND WATER MAIN

LOCATION(S): VARIOUS LOCATIONS

PERMISSION IS HEREBY GRANTED TO THE **NEW YORK CITY DEPARTMENT OF DESIGN AND CONSTRUCTION** AND ITS DULY AUTHORIZED AGENT, TO ENTER UPON AND RESTRICT THE FLOW OF TRAFFIC AT THE ABOVE LOCATION AND ITS LOCAL ADJACENT STREETS FOR THE PURPOSE OF CARRYING OUT THE ABOVE NOTED PROJECT, SUBJECT TO THE STIPULATIONS, AS NOTED BELOW:

A. SPECIAL STIPULATIONS

1. **EMBARGOES** – A CONSTRUCTION EMBARGO WILL APPLY TO THOSE LOCATIONS BELOW WHICH FALL WITHIN THE **HOLIDAY EMBARGO** OR ANY OTHER SPECIAL EVENT EMBARGOES SUCH AS PUBLISHED BY THE BUREAU OF PERMIT MANAGEMENT AND CONSTRUCTION CONTROL.
2. **BIKE LANES** – IF WORK IS IN OR AFFECTING A BIKE LANE, THE CONTRACTOR MUST POST ADVANCE WARNING SIGNS 350 FEET AND 200 FEET PRIOR TO THE WORK ZONE STATING "**CONSTRUCTION IN BIKE LANE AHEAD PROCEED WITH CAUTION**", AND ALSO POST A SIGN AT THE WORK ZONE STATING "**CONSTRUCTION IN BIKE LANE PROCEED WITH CAUTION**". SUCH SIGNS SHALL BE ORANGE, 3' X 3', DIAMOND-SHAPED WITH 4" BLACK LETTERING. SIGNS SHALL BE POSTED IN ACCORDANCE WITH THE FEDERAL MANUAL ON UNIFORM TRAFFIC CONTROL DEVICES (MUTCD).
3. **BUS STOPS** – THE CONTRACTOR SHALL PROVIDE WRITTEN NOTICE TO NYC DOT OCMC AND NEW YORK CITY TRANSIT (NYCT) A MINIMUM OF FIVE (5) WEEKS IN ADVANCE FOR LANE/STREET CLOSURES THAT AFFECT BUS ROUTES/BUS STOPS.
4. **METERS** – THE CONTRACTOR MAY NOT REMOVE OR RELOCATE PARKING METERS WITHOUT FIRST OBTAINING APPROVAL FROM NYCDOT PARKING METER DIVISION AT 718-894-8651.
5. **ACCESS TO ABUTTING PROPERTIES** – THE CONTRACTOR SHALL COORDINATE ALL ACTIVITIES WITH ABUTTING PROPERTY OWNERS TO ENSURE ACCESS IS PROVIDED TO/FROM ENTRANCES/DRIVEWAYS AT ALL TIMES.
6. **AUTHORIZED PARKING** – PRIOR TO PERFORMING WORK WHICH IMPACTS AUTHORIZED PARKING, THE CONTRACTOR SHALL SUBMIT IN WRITING, AND COPY OCMC-STREETS, A REQUEST TO OCCUPY SPACE CURRENTLY USED BY AUTHORIZED VEHICLES. APPROVAL MUST BE RECEIVED FROM AUTHORIZED PARKING PRIOR TO OCCUPYING THESE AREAS.
7. **NOTIFICATION** – THE CONTRACTOR MUST AT LEAST TWO (2) WORKING DAYS BEFORE THE START OF CONSTRUCTION NOTIFY THE NYC FIRE DEPARTMENT, NYC POLICE DEPARTMENT, NYC EMS, LOCAL COMMUNITY BOARD, BOROUGH PRESIDENT'S OFFICE-CHIEF ENGINEER, NYCDOT OCMC OFFICE, AND ALL ABUTTING PROPERTY OWNERS.
8. **ENHANCED MITIGATIONS**
 - o "**NO STANDING ANYTIME-TEMPORARY CONSTRUCTION**" SIGNS AND TEMPORARY PAVEMENT MARKINGS SHALL BE INSTALLED AND MAINTAINED AS WARRANTED BY THE MAINTENANCE AND PROTECTION OF TRAFFIC (MPT) REQUIRED TO FACILITATE TRAFFIC MOVEMENTS THROUGH THE WORK ZONE. ALL TEMPORARY SIGNS AND PAVEMENT MARKINGS SHALL BE REMOVED UPON COMPLETION OF THE PROJECT.
 - o **COMMUNITY OUTREACH** SHALL BE PROVIDED FOR THE DURATION OF THE PROJECT.

NYC Department of Transportation
 Bureau of Permit Management and Construction Control
 55 Water Street - 7th Floor, New York, NY 10041
 T: 212.839.9621 F: 212.839.8970
 www.nyc.gov/dot

OCMC FILE NO: QEC 13-155
 CONTRACT NO: HWQ121B4
 PROJECT: ROADWAY, SIDEWALK, CURB, STREET LIGHTING AND TRAFFIC SIGNAL. INSTALLATION OF STORM/SANITARY SEWERS AND WATER MAIN

B. MAINTENANCE AND PROTECTION OF TRAFFIC

118TH AVENUE BETWEEN GUY R BREWER BOULEVARD AND LAKEVIEW BOULEVARD EAST

119TH AVENUE BETWEEN LAKEVIEW BOULEVARD EAST AND 165TH STREET

119TH ROAD BETWEEN 177TH PLACE AND 180TH STREET

122ND AVENUE BETWEEN LAKEVIEW BOULEVARD EAST AND LONG STREET

LAKEVIEW LANE BETWEEN 122ND AVENUE AND BAISLEY BOULEVARD

LAKEVIEW BOULEVARD EAST BETWEEN 118TH AVENUE AND 122ND AVENUE

164TH STREET BETWEEN FOCH BOULEVARD 122ND AVENUE

- Work hours shall be as follows: 7:00 AM to 6:00 PM, Monday – Friday
- The contractor must maintain one 12 foot lane for local and emergency traffic during working hours.
- The contractor shall restore all travel lanes after working hours.
- The contractor shall maintain 5-foot clear sidewalk for pedestrians at all times.

INTERSECTION OF 118TH AVENUE AND LONG STREET

INTERSECTION OF 118TH AVENUE AND LAKEVIEW BOULEVARD EAST

INTERSECTION OF 119TH AVENUE AND LAKEVIEW BOULEVARD EAST

INTERSECTION OF 119TH AVENUE AND LONG STREET

INTERSECTION OF 119TH AVENUE AND 164TH STREET

INTERSECTION OF 119TH AVENUE AND 165TH STREET

INTERSECTION OF 119TH ROAD AND 177TH PLACE

INTERSECTION OF 119TH ROAD AND 178TH STREET

INTERSECTION OF 119TH ROAD AND 178TH PLACE

INTERSECTION OF 119TH ROAD AND 179TH STREET

INTERSECTION OF 119TH ROAD AND 180TH STREET

INTERSECTION OF 122ND AVENUE AND LAKEVIEW BOULEVARD EAST

INTERSECTION OF 122ND AVENUE AND LAKEVIEW LANE

INTERSECTION OF 122ND AVENUE AND LONG STREET

INTERSECTION OF LAKEVIEW LANE AND 122ND AVENUE

INTERSECTION OF LAKEVIEW BOULEVARD EAST AND 118TH ROAD

INTERSECTION OF LAKEVIEW BOULEVARD EAST AND 119TH ROAD

INTERSECTION OF LAKEVIEW BOULEVARD EAST AND 119TH DRIVE

INTERSECTION OF LAKEVIEW BOULEVARD EAST AND 120TH AVENUE

INTERSECTION OF LAKEVIEW BOULEVARD EAST AND 121ST AVENUE

INTERSECTION OF 164TH STREET AND FOCH BOULEVARD

INTERSECTION OF 164TH STREET AND 119TH STREET

INTERSECTION OF 164TH STREET AND 120TH AVENUE

INTERSECTION OF 164TH STREET AND 122ND AVENUE

- Work hours shall be as follows: 7:00 AM to 6:00 PM, Monday – Friday
- The contractor must maintain one 12 foot lane for local and emergency traffic during working hours.
- The contractor must restore the full width of the roadway after working hours.
- The contractor shall maintain 5-foot clear sidewalk for pedestrians at all times.

INTERSECTION OF 119TH AVENUE AND GUY R BREWER BOULEVARD

INTERSECTION OF LAKEVIEW LANE AND BAISLEY BOULEVARD

- Work hours shall be as follows: 7:00 AM to 6:00 PM, Monday – Friday
- The contractor shall maintain on Baisley Boulevard and Guy R Brewer Boulevard two lanes for traffic, 1 lane in each direction and on cross streets one 12 foot lane for local and emergency traffic.
- The contractor must restore the full width of the roadway after working hours.
- The contractor shall maintain 5-foot clear sidewalk for pedestrians at all times.

C. GENERAL NOTES

1. **THIS IS NOT A PERMIT.** THIS STIPULATION SHEET MUST BE SUBMITTED WITH ALL REQUESTS FOR PERMITS PERTAINING TO THE ABOVE CONTRACT AND PRESENT AT THE WORK SITE ALONG WITH ALL ACTIVE CONSTRUCTION PERMITS WHEN THE APPROVED WORK IS BEING PERFORMED.
2. ALL RELOCATION WORK BY THE UTILITIES SUCH AS; CON EDISON, TELEPHONE, GAS AND CABLE COMPANIES SHALL PRECEDE THE CONTRACTORS' START OF WORK ON ALL AFFECTED ROADWAYS IN THE IMPACTED CONTRACT AREA.
3. THE CONTRACTOR IS ADVISED THAT OTHER CONTRACTORS MAY BE WORKING IN THE GENERAL AREA DURING THE TERM OF THIS STIPULATION. IN WHICH EVENT, THE CONTRACTOR MAY REQUIRE MODIFICATIONS BY THE OCMC-STREETS.
4. THE PERMITTEE IS NOT AUTHORIZED TO ENTER, OCCUPY OR USE ANY PUBLICLY-OWNED OR PRIVATELY OWNED, NON-PAVED, LANDSCAPE OR NON-LANDSCAPED LOCATION WITHOUT SPECIFIC WRITTEN PERMISSION. WHEN THE LOCATION IS WITHIN THE RIGHT-OF-WAY OF A LIMITED-ACCESS ARTERIAL HIGHWAY, WRITTEN APPROVAL FROM THE NYCDOT OCMC-HIGHWAYS IS REQUIRED. WHEN THE LOCATION IS WITHIN THE RIGHT-OF-

OCMC FILE NO: GEC 13-155
CONTRACT NO: HWQ121B4
PROJECT: ROADWAY, SIDEWALK, CURB, STREET LIGHTING AND TRAFFIC SIGNAL. INSTALLATION OF STORM/SANITARY SEWERS AND WATER MAIN

WAY OF A PUBLIC STREET OR PUBLIC PARK, WRITTEN APPROVAL FROM THE NEW YORK CITY DEPARTMENT OF TRANSPORTATION OR NEW YORK CITY DEPARTMENT OF PARKS AND RECREATION IS REQUIRED. WHEN THE LOCATION IS WITHIN THE RIGHT-OF-WAY OF ANY OTHER JURISDICTION SUCH AS PRIVATE PROPERTY, STATE, FEDERAL ETC., IT IS THE PERMITEE'S RESPONSIBILITY TO DETERMINE THE PROPERTY OWNER AND OBTAIN THE WRITTEN APPROVAL.

5. THE PERMITEE SHALL ADHERE TO THE NYCDOT BUREAU OF BRIDGES' SPECIAL PROVISIONS FOR LANDSCAPE PROTECTION, MAINTENANCE AND RESTORATION, ITEMS 1.18.15 THROUGH 1.18.19, WHENEVER AND WHEREVER ANY OF THE PERMITEE'S ACTIVITIES OCCUR WITHIN A LIMITED ACCESS ARTERIAL HIGHWAY RIGHT-OF-WAY.
6. NO DEVIATION OR DEPARTURE FROM THESE STIPULATIONS WILL BE PERMITTED WITHOUT THE PRIOR WRITTEN APPROVAL FROM THE OCMC-STREETS. REQUEST FOR SUCH MODIFICATIONS SHALL BE SUBMITTED TO THE OFFICE OF THE OCMC-STREETS, NEW YORK CITY DEPARTMENT OF TRANSPORTATION, A MINIMUM OF TWENTY (20) DAYS IN ADVANCE FOR CONSIDERATION.
7. FOR THIS PROJECT THE CONTRACTOR SHALL FURNISH, INSTALL AND MAINTAIN ALL NECESSARY ADVANCE WARNING AND DETOUR SIGNS, TEMPORARY CONTROL DEVICES, BARRICADES, LIGHTS AND FLASHING ARROW BOARDS IN ACCORDANCE WITH THE "MANUAL ON UNIFORM TRAFFIC CONTROL DEVICES," THE TYPICAL SCHEMES INCLUDED IN THIS SPECIFICATION; AND AS ORDERED BY THE ENGINEER-IN-CHARGE AND THE OCMC-STREETS.
8. THE CONTRACTOR SHALL BE RESPONSIBLE FOR IDENTIFYING HIS CONSTRUCTION SIGNAGE. THE IDENTIFICATION SHALL INCLUDE THE CONTRACTOR'S NAME, SPONSORING AGENCY NAME AND THE CONTRACT NUMBER. THE IDENTIFICATION SHALL BE PLACED ON THE BACK OF THE SIGN. THE LETTERING SHALL BE THREE (3) INCHES HIGH.
9. THE OCMC-STREETS RESERVES THE RIGHT TO VOID OR MODIFY THESE STIPULATIONS SHOULD CONSTRUCTION FAIL TO COMMENCE WITHIN TWO (2) YEARS OF THE SIGNED DATE OF THESE STIPULATIONS.
10. THE CONTRACTOR MUST COMPLY WITH ALL CONSTRUCTION EMBARGOS ISSUED BY THE NYCDOT INCLUDING THE HOLIDAY EMBARGO.

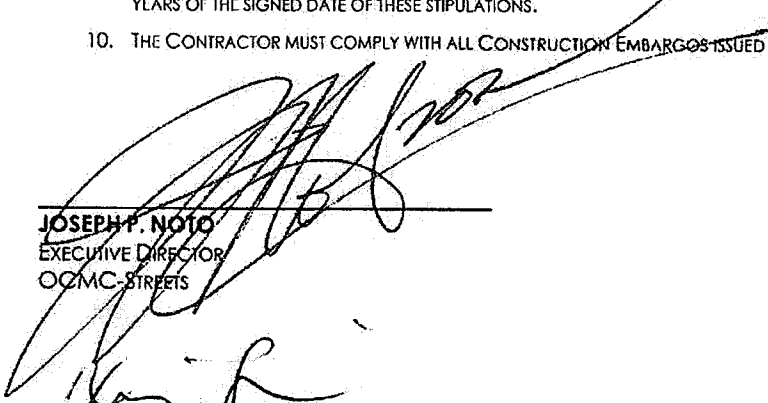

JOSEPH P. NOTO
EXECUTIVE DIRECTOR
OCMC-STREETS



XIOMARA AGUILERA
PROJECT MANAGER
OCMC-STREETS

JPN/db



THE CITY OF NEW YORK Department of Sanitation

S. ELIZABETH SEARLE
Assistant Commissioner
for Legal Affairs

Bureau of Legal Affairs
44 Beaver Street
New York, NY 10004
Telephone (212) 837-8110
FAX (212) 837-8243

Department of Sanitation Rules and Regulations Governing Non-Putrescible Solid Waste Transfer Stations

INTERPRETIVE MEMORANDUM # 2 February 14, 1995

*Subject: Temporary Storage and Processing of Construction and Demolition Debris
by New York City Agency Contractors*

Contractors performing construction work for New York City agencies may be required to excavate dirt, concrete, rock, gravel and similar materials ("construction materials") from a contract site or to remove from a contract site construction materials resulting from construction, demolition, alteration, repair or renovation of structures, streets or buildings. On street construction projects, construction materials required to be excavated or removed may also include asphalt. The purpose of this Interpretive Memorandum is to (a) define the circumstances under which the Department of Sanitation (the "Department") will not deem its Rules and Regulations Governing Non-Putrescible Solid Waste Transfer Stations (the "Rules") to apply to the temporary storage, processing and/or stockpiling (collectively, "stockpiling") of such construction materials and (b) the procedure for ensuring such exemption. It is the responsibility of the contracting agency to oversee its contractors' compliance with the Rules and with this Interpretive Memorandum.

1. When No Transfer Station Permit is Required

Where a City contractor has:

- (a) set aside an area of a contract site for stockpiling construction materials excavated from and/or intended for that site; or
- (b) received written approval from the contracting agency for an off-site stockpiling location,

the Department will not deem such stockpiling location a transfer station and will not require the contractor to obtain a transfer station permit so long as: -

- (c) no construction materials or debris from off the contract site are received at the designated location for subsequent transfer to another location (other than the contract site); and
- (d) the temporary stockpiling location is clearly described as such in the contract or clearly approved by the construction agency and designated as such in writing to the Department by the agency; and
- (e) the construction agency represents in writing to the Department that such agency will monitor the temporary stockpiling location and ensure its clean-up and restoration pursuant to the procedures set out in this memorandum.

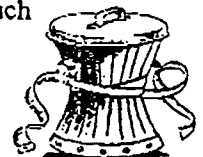

Help Reduce
New York's Waste.

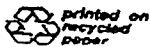

Example: Street Construction Projects

As part of a contract for street construction, the contractor may be working at one end of a street and using an area at the other end of the street for the temporary stockpiling of construction materials. Both ends of the street are part of the construction contract site. In addition, the contractor may have leased an off-site location for temporary stockpiling of materials, which, following processing, will be reincorporated into the contract site, with some portion of the remainder designated for delivery to a Department disposal facility. Neither location will be regulated by the Department as a transfer station so long as the procedures set out in this memorandum are followed.

2. Procedure for Exception.

Upon a City construction agency's approval of any location to be designated as a temporary processing, storage or stockpiling area, that agency must determine that (a) its contract with the contractor provides for clean-up and restoration of such area by, for example, the contractor's posting of a restoration bond and/or by contractual set-off and (b) the agency has adequate procedures for monitoring the designated area to ensure that it does not violate the provisions set forth in this memorandum and that such location is cleaned up and restored at the completion of the contract work.

The City construction agency must submit an official letter to the Department acknowledging compliance with both (a) and (b) immediately above and representing that the agency will ensure the contractor's compliance. The letter to be submitted must be in substantially the following form, addressed to the Director, Bureau of Waste Disposal, Department of Sanitation, 125 Worth Street, Room 726, New York, NY 10013:

"The New York City Department of _____ (the "Agency") has awarded a construction contract to _____ (Contractor) _____ (the "Contractor") for work to be performed at _____ (Contract Site) _____ .

a. This Agency has approved the following locations to be used by the Contractor for the temporary storage, processing and/or stockpiling of construction materials (the "Stockpiling Locations") excavated from the construction site or intended for the construction site:

b. The terms of the contract require the Contractor to clean up and restore the Stockpiling Locations, whether on or off the contract site, at or before the completion of the contract work.

c. This Agency assumes responsibility for the monitoring of Stockpiling Locations to ensure that only materials received from and/or intended for the construction site are stockpiled at such locations and we will enforce clean-up and restoration of such Locations at the end of their use for temporary stockpiling or at the termination of the contract, whichever occurs earlier, through restoration

bonding requirements and/or contractual set-off provisions such that the costs of clean-up and restoration will not become a charge to the Department or the City. "

3. When a Transfer Station Permit is Required

A transfer station permit will be required under any circumstances other than those outlined above. Except in the specifically defined circumstances set forth in this memorandum, any operator of a location or facility which receives, processes, stores or stockpiles construction and demolition debris or fill material for purposes of transfer to another location, including to a New York City Department of Sanitation facility, and whether or not under contract to the Department for the delivery of such materials, will be fully subject to the Department's transfer station rules and liable for enforcement for violations.

(NO TEXT ON THIS PAGE)

ATTACH TO CONTRACT DOCUMENTS

**THE CITY OF NEW YORK
DEPARTMENT OF DESIGN AND CONSTRUCTION
INFRASTRUCTURE DIVISION
BUREAU OF DESIGN**

PROJECT ID: HWQ121B4

RECONSTRUCTION OF LAKEVIEW BOULEVARD EAST

**LAKEVIEW LANE - FROM BAISLEY BOULEVARD TO 122ND AVENUE
122ND AVENUE – FROM LAKEVIEW LANE TO LAKEVIEW BOULEVARD EAST
LAKEVIEW BOULEVARD EAST – FROM 122ND AVENUE TO 118 TH AVENUE
118TH AVENUE – FROM LAKEVIEW BOULEVARD EAST TO LONG STREET**

NEW STORM AND SANITARY SEWERS (SEQ200436) IN:

**LAKEVIEW LANE - FROM BAISLEY BOULEVARD TO 122ND AVENUE
122ND AVENUE – FROM LAKEVIEW LANE TO LAKEVIEW BOULEVARD EAST
LAKEVIEW BOULEVARD EAST – FROM 122ND AVENUE TO 118 TH AVENUE
119 TH AVENUE - FROM LONG STREET TO 164TH STREET
164 TH STREET - FROM 119TH AVENUE TO 120TH AVENUE**

**CAPITAL PROJECT WM-1
WATER MAIN WORK IN:**

**LAKEVIEW LANE - FROM BAISLEY BOULEVARD TO 122ND AVENUE
122ND AVENUE – FROM LAKEVIEW LANE TO LAKEVIEW BOULEVARD EAST
LAKEVIEW BOULEVARD EAST – FROM 122ND AVENUE TO 118 TH AVENUE
118TH AVENUE – FROM LAKEVIEW BOULEVARD EAST TO LONG STREET
119 TH AVENUE - FROM LONG STREET TO 164TH STREET
164 TH STREET - FROM 119TH AVENUE TO 120TH AVENUE**

INCLUDING STREET LIGHTING AND TRAFFIC WORK

**Together With All Work Incidental Thereto
BOROUGH OF QUEENS**

ADDENDUM NO. 2

DATED: February 26, 2015

This Addendum is issued for the purpose of amending the requirements of the contract documents and is hereby made part of said contract documents to the same extent as if it was originally included therein.

The Standard Sewer And Water Main Specifications of the Department of Environmental Protection (dated July 1, 2014), Sewer Design Standards of the Department of Environmental Protection (dated (September 2007) Revised January 2009), Water Main Standard Drawings of the Department of Environmental Protection (latest revisions), Specifications For Trunk Main Work of the Department of Environmental Protection (dated July 2014) and the Standard Highway Specifications (Volumes I and II) of the Department of Transportation (dated November 1, 2010) of The City of New York, shall be included as part of the contract documents. These said specifications and standard drawings are hereby revised under the following section headings:

- A. NOTICE TO BIDDERS
- B. AMENDMENTS TO THE STANDARD HIGHWAY SPECIFICATIONS
- C. AMENDMENTS TO THE STANDARD SEWER AND WATER MAIN SPECIFICATIONS
- D. AMENDMENTS TO THE SPECIFICATIONS FOR TRUNK MAIN WORK

A. NOTICE TO BIDDERS

- (1) (A) The Contractor is advised that copies of the Standard Sewer And Water Main Specifications (dated July 1, 2014), Sewer Design Standards (dated (September 2007) Revised January 2009), Specifications For Trunk Main Work (dated July 2014) and Water Main Standard Drawings (latest revisions) are available to all prospective bidders at no cost upon presentation of receipt of purchase of Bid Package at the following location:

Department of Design and Construction
Division of Infrastructure
Design Services, Specifications, 3rd Floor
30-30 Thomson Avenue
Long Island City, NY 11101

- (B) The Contractor is advised that copies of the Standard Highway Specifications (Volume I and II) (dated November 1, 2010), Standard Highway Details of Construction (latest revisions), Division of Street Lighting Specifications (latest revisions), Division of Street Lighting Standard Drawings (latest revisions), Standard Specifications for Traffic Signals (latest revisions), and Standard Drawings for Traffic Signals (latest revisions) are available to all prospective bidders for a fee at the following location:

Department of Transportation
55 Water Street, Ground Floor
New York City, NY 10041

- (2) The Contractor is notified that a Notice To Proceed (NTP) date will be issued for work to commence within twenty-one (21) to thirty (30) days of Contract Registration.
- (3) The Contractor shall furnish, install, maintain and subsequently remove temporary Protective Tree Barriers. Protective Tree Barriers shall be Type B, unless otherwise directed by the Engineer, and shall be constructed and installed as shown on the Protective Tree Barrier sketch in Department Of Transportation, Standard Highway Details Of Construction, Drawing No. H-1046A, as directed by the Engineer, and in accordance with Department of Parks and Recreation requirements.
- (4) All utility locations and invert elevations are not guaranteed, nor is there any guarantee that all existing utilities, whether functional or abandoned within the project area are shown.
- (5) All existing house connections shall be maintained and supported during construction. The Contractor shall replace any existing house connection damaged as a result of the Contractor's construction operations as ordered by the Engineer at no cost to the City.
- (6) The Contractor is advised that any City owned light poles, traffic signals, street name signs, traffic signs and encumbrances including, but not limited to, underground conduit displaced as the result of the installation of the new sewers, water mains, catch basins, catch basin connections and appurtenances shall be replaced in kind and as directed by the Engineer. The cost of such work shall be deemed included in the prices bid for all items of work under this contract.
- (7) The Contractor is notified that Victaulic Style 77 Coupling is no longer acceptable for use in any steel water main work. All reference to Victaulic Style 77 Coupling within the Standard Sewer And Water Main Specifications of the Department of Environmental Protection (dated July 1, 2014), the Water Main Standard Drawings of the Department of Environmental Protection (latest revisions), the Specifications For Trunk Main Work (dated July 2014), and the contract drawings, shall be replaced with Bolted Split-Sleeve Restrained Coupling.
- (8) The Contractor is notified that wherever the Item No. "6.52" and words "flagger", "flagperson" and "flagman" are used in the contract documents and drawings it shall mean the Item No. "6.52 CG" and the words "Crossing Guard", respectively.

(9) The Contractor is notified that the fuel cost per gallon used in the formula under **Sub-Article 26.2.8** of the Standard Construction Contract for **Extra Work** will be derived from the fuel price index for the United States East Coast published weekly by the United States Energy Information Administration ("USEIA"), and available on its website at <http://www.eia.gov/petroleum/gasdiesel/> . The USEIA published cost per gallon for the applicable fuel on the East Coast for the week in which the first day of each calendar quarter during the contract term occurs (i.e., January 1st, April 1st, July 1st and September 1st) will be used in the reimbursement formula for all **Extra Work** invoiced that was performed during that calendar quarter. Should the USEIA stop publishing this fuel price index, the fuel cost per gallon will be determined by reference to a substitute index to be agreed upon by the Contractor and the City.

(10)The Contractor is responsible for any damage to the existing street and traffic signal equipment, including underground conduits and the safety of both pedestrian and vehicular traffic for the duration of the contract.

Should any conduits, cables or foundations need repair due to the Contractor's negligent operations during construction, all work shall be performed according to NYCDOT Bureau of Traffic's Standard Drawings and Specifications at the sole expense of the Contractor.

It is the Contractor's responsibility to secure an approved electrical contractor to perform all traffic signal work (if any). For list of approved electrical contractors, contact Mr. Michael R. LeFosse of New York City Department of Transportation at (718) 786-2236.

(11)The Contractor is advised that where the existing roadway pavement is designated to be replaced from curb to curb, then no full depth saw cutting of pavement for sewer and water main trenches will be required, except at the limits of full width pavement restoration. No separate or additional payment will be made for any saw cutting.

(12)The Contractor is advised that the cost of sheeting for 16 inch Ductile Iron Pipe shall be deemed included for the price bid for item No. 70.91SW20 – FURNISHING AND PLACING SHEETING AND BRACING IN TRENCH FOR WATER MAIN PIPE 20-INCH IN DIAMETER.

B. AMENDMENTS TO THE STANDARD HIGHWAY SPECIFICATIONS

(NO TEXT)

C. AMENDMENTS TO THE STANDARD SEWER AND WATER MAIN SPECIFICATIONS

- (1) **Refer to Subsection 10.15 - Notice To Utility Companies, Etc., To Remove Structures Occupying Place Of Sewers, Water Mains Or Appurtenances, Page I-11:**

Add the following to **Subsection 10.15:**

- (1) CONSOLIDATED EDISON COMPANY OF NEW YORK (CON EDISON)

There are CON EDISON facilities in the area of construction. The Contractor shall notify CON EDISON at least seventy-two (72) hours prior to the start of construction by contacting Mr. Noel Leon at (718) 802-3013.

- (2) NATIONAL GRID

There are NATIONAL GRID facilities in the area of construction. The Contractor shall notify NATIONAL GRID at least seventy-two (72) hours prior to the start of construction by contacting Mr. Neville Jacobs Jr. at (718) 963-5612.

- (3) VERIZON

There are VERIZON facilities in the area of construction. The Contractor shall notify VERIZON at least seventy-two (72) hours prior to the start of construction by contacting Mr. Emilio C. Barcelona at (718) 977-8138.

- (4) TIME WARNER CABLE OF NEW YORK CITY

There are TIME WARNER CABLE facilities in the area of construction. The Contractor shall notify TIME WARNER CABLE at least seventy-two (72) hours prior to the start of construction by contacting Mr. John Devine at (718) 888-4242.

- (2) **Refer to Subsection 10.21 - Contractor To Notify City Departments, Page I-13:**

Add the following to **Subsection 10.21:**

- (1) N.Y.C. D.E.P., BUREAU OF WATER AND SEWERS OPERATIONS

The Contractor shall notify Mr. James Garin, P.E., Director, Engineering at the Department of Environmental Protection, 59-17 Junction Blvd., 3rd floor low rise, Corona N.Y. 11368, at least thirty (30) days prior to the start of construction.

- (2) NEW YORK CITY FIRE DEPARTMENT

The Contractor shall notify the Bureau of Fire Communications at least thirty (30) days prior to the start of construction by contacting Mr. Ed Durkin at (718) 624-4194 or (718) 624-3752.

- (3) N.Y.C. DEPARTMENT OF TRANSPORTATION

The Contractor shall notify Mr. Steve Galgano, P.E. Chief of Signal/Street Lighting Operations, 34-02 Queens Blvd., Long Island City, N.Y. 11101 at (718) 786-3550, at least seventy-two (72) hours prior to the start of construction.

- (4) N.Y.C. DEPARTMENT OF PARKS AND RECREATION

The Contractor shall notify the Parks Department at least seventy-two (72) hours prior to the start of construction by contacting Mr. James Cruickshank at (718) 965-7739.

- (5) N.Y.C. TRANSIT AUTHORITY

The Contractor is advised that bus routes as well as bus stops, within the scope of this project may be affected during construction operations. The Contractor shall notify the Transit Authority at least two (2) weeks prior to the start of construction, in order to make the necessary arrangements.

Arrangements shall be made through:

Ms. Sarah Wyss
 Director Of Short Range, Bus Service Planning (SRB)
 New York City Transit
 2 Broadway, 17th Floor
 New York, N.Y. 10004
 Telephone No. (646) 252-5517
 sarah.wyss@nyct.com

- (3) **Refer to Subsection 10.30 - Contractor To Provide For Traffic**, Page I-15:
Add the following to **Subsection 10.30**:

- (1) Traffic Stipulations:

The Contractor shall refer to Traffic Stipulations identified in the maintenance of traffic requirements under Highway Contract No. HWQ121B4.

- (4) **Refer to Subsection 71.41.4 - Specific Pavement Restoration Provisions**, Page VII-67:
Add the following to **Subsection 71.41.4**:

- (E) Specific Pavement Restoration Provisions:

- (1) Within the limits of the highway reconstruction the restoration shall be accomplished and paid for in accordance with Highway Construction Plans, Details and Specifications for Highway Project ID. HWQ121B4
- (2) In street areas requiring sewer and water main work outside the limits of highway reconstruction (in 119th Avenue between Long Street and 164th Street and 164th Street between 119th Avenue and 120th Avenue) the restoration shall be as follows:

- (A) In Streets Requiring Overlay:

- (a) The permanent restoration over the **trench width and cutbacks only** shall consist of a top course of one and one-half (1-1/2) inches of binder mixture on a base course of a minimum of four and one-half (4-1/2) inches of binder mixture, or a top course of a minimum of three (3) inches of binder mixture on a base course of a minimum of six (6) inches of concrete, to match the existing pavement as directed by the Engineer.
- (b) Finally an overlay of two (2) inches of asphaltic concrete wearing course shall be installed over the entire width of the roadway from **curb to curb** or **edge to edge** of existing roadway.

- (B) In Streets Not Requiring Overlay:

- (a) The permanent restoration over the **trench width and cutbacks only** shall consist of a top course of one and one-half (1-1/2) inches of asphaltic concrete wearing course on a base course of a minimum of four and one-half (4-1/2) inches of binder mixture, or a top course of one and one-half (1-1/2)

inches of asphaltic concrete wearing course on a minimum of one and one-half (1-1/2) inches of binder mixture on a base course of a minimum of six (6) inches of concrete, to match the existing pavement as directed by the Engineer.

- (3) The following requirements apply to sub-section (2) above only:
 - (a) Before the top course is installed, an additional width of asphalt beyond the edge of new base course shall be saw-cut and removed from all edges of trenches to a depth to accommodate the specified top course and the entire area restored. This additional removal shall be in accordance with paragraph (b) below.
 - (b) Pavement excavation along with saw cutting of pavements for sewer and water main trenches shall be in accordance with **Section 71.21 - Pavement Excavation** of the Standard Sewer And Water Main Specifications.
 - (c) At locations requiring the installation of a concrete base course, a reflective cracking membrane shall be installed over joints prior to restoration, the cost of which shall be deemed included in the prices bid for all pavement restoration items. Additionally, appropriate pavement keys as described below shall be used.
 - (d) Pavement keys **Type B-1** shall be used to insure a desired four (4) inch curb reveal (two and one-half (2-1/2) inch absolute minimum). Pavement key **Type A** shall be used in all intersections. Both keys are to be per Bureau of Highways Operations Specifications and Standard Details of Construction.
 - (e) Unless otherwise specified, the cost for Proctor analyses, in-place soil density tests, tack coating, eradication of temporary roadway markings, stripping or milling of pavement keys and adjustment of city-owned castings for all roadway work shall be deemed included in the prices bid for all pavement restoration items.
 - (f) Payment for placement of temporary pavement marking shall be made under Item No. 6.49 - TEMPORARY PAVEMENT MARKINGS (4" WIDE).
 - (g) Payment for removal of existing pavement markings shall be made under Item No. 6.53 - REMOVE EXISTING LANE MARKINGS (4"WIDE).
 - (h) Payment for placement of permanent pavement marking with thermoplastic reflectorized pavement markings (crosswalk and lane dividers) shall be made under Item No. 6.44 - THERMOPLASTIC REFLECTORIZED PAVEMENT MARKINGS (4" WIDE).
 - (i) Payment for pavement restoration shall be made under the following items:

<u>Item No.</u>	<u>Item</u>	<u>Payment Description</u>
4.02 AB-R	Asphaltic Concrete Wearing Course, 1-1/2" Thick	(For asphaltic concrete wearing course top course when <u>no</u> overlay is required.)
4.02 AF-R	Asphaltic Concrete Wearing Course, 2" Thick	(For 2" asphaltic concrete wearing course overlay from curb to curb or edge to edge.)
4.02 CA	Binder Mixture	(For binder mixture base course over trenches and cutbacks; binder mixture top filler course under asphaltic concrete wearing course when <u>no</u> overlay is required; binder mixture top course when overlay is required; binder mixture in Type A and B Keys; and binder mixture to fill in roadway depressions and to

4.04 H Concrete Base For Pavement,
Variable Thickness For Trench
Restoration, (High-Early
Strength)

provide a leveling course prior to overlay
where ordered.)

(For concrete base course over trenches
and cutbacks.)



D. AMENDMENTS TO THE SPECIFICATIONS FOR TRUNK MAIN WORK

- 1) **Refer** to Part 1 – Furnishing And Delivering Steel Pipes And Appurtenances 30 Inches In Diameter And Larger, Paragraph 13. Special Fittings:, Page 5;
Add the following to Paragraph 13:

The steel reducer shall have a length of seven (7) feet for every twelve (12) inches reduction in diameter.

END OF ADDENDUM NO. 2
This Addendum consists of nine (9) pages.

NO TEXT ON THIS PAGE

ATTACH TO CONTRACT DOCUMENTS

**THE CITY OF NEW YORK
DEPARTMENT OF DESIGN AND CONSTRUCTION
INFRASTRUCTURE DIVISION
BUREAU OF DESIGN**

PROJECT ID: HWQ121B4

RECONSTRUCTION OF LAKEVIEW BOULEVARD EAST

**LAKEVIEW LANE - FROM BAISLEY BOULEVARD TO 122ND AVENUE
122ND AVENUE - FROM LAKEVIEW LANE TO LAKEVIEW BOULEVARD EAST
LAKEVIEW BOULEVARD EAST - FROM 122ND AVENUE TO 118TH AVENUE
118TH AVENUE - FROM LAKEVIEW BOULEVARD EAST TO LONG STREET**

NEW STORM AND SANITARY SEWERS (SEQ200436) IN:

**LAKEVIEW LANE - FROM BAISLEY BOULEVARD TO 122ND AVENUE
122ND AVENUE - FROM LAKEVIEW LANE TO LAKEVIEW BOULEVARD EAST
LAKEVIEW BOULEVARD EAST - FROM 122ND AVENUE TO 118TH AVENUE
119TH AVENUE - FROM LONG STREET TO 164TH STREET
164TH STREET - FROM 119TH AVENUE TO 120TH AVENUE**

**CAPITAL PROJECT WM-1
WATER MAIN WORK IN:**

**LAKEVIEW LANE - FROM BAISLEY BOULEVARD TO 122ND AVENUE
122ND AVENUE - FROM LAKEVIEW LANE TO LAKEVIEW BOULEVARD EAST
LAKEVIEW BOULEVARD EAST - FROM 122ND AVENUE TO 118TH AVENUE
118TH AVENUE - FROM LAKEVIEW BOULEVARD EAST TO LONG STREET
119TH AVENUE - FROM LONG STREET TO 164TH STREET
164TH STREET - FROM 119TH AVENUE TO 120TH AVENUE**

INCLUDING STREET LIGHTING AND TRAFFIC WORK

Together With All Work Incidental Thereto

**BOROUGH OF QUEENS
CITY OF NEW YORK**

ADDENDUM NO. 3

DATED: April 23, 2015

This Addendum is issued for the purpose of amending the requirements of the Contract Documents and is hereby made part of said Contract Documents to the same extent as if it was originally included therein.

GAS COST SHARING (EP-7) STANDARD SPECIFICATIONS

EP-7 GAS COST SHARING STANDARD SPECIFICATIONS

TABLE OF CONTENT

I - NOTICE TO ALL BIDDERS; GAS COST SHARING WORK

II - GENERAL PROVISIONS; GAS COST SHARING WORK

1. General
2. Gas Interferences And Accommodations
 - 2a. Water Main Accommodations
 - 2b. Sewer Accommodations
3. Quantity Overruns, EP-7 Funded Bid Items
4. Changes And Extra Work
5. Excavation
6. Backfilling And Street Restoration
7. Non-Responsive Bids
8. Minimum Clearances
9. Work By Facility Operator
10. Materials Furnished By Facility Operator
11. Liability And Insurance
12. Width And Depth Of Excavation
13. Depth And Crossing Angles Of Gas Facilities
14. Maintenance Of Traffic For Gas Work
15. Relocated Gas And Temporary Systems Installation
16. Role Of Company Inspector
17. Coordination With Gas Company

III - TECHNICAL SECTION

- SECTION 6.01 - Trench Crossings; Support And Protection Of Gas Facilities And Services.
- SECTION 6.02 - Extra Excavation For The Installation Of Catch Basin Sewer Drain Pipes With Gas Interferences.
- SECTION 6.02.1 - Extra Excavation For The Installation Of Catch Basin Sewer Drain Pipes With Upstream Inverts Greater Than Six (6) Feet.
- SECTION 6.03 - Removal Of Abandoned Gas Facilities. All Sizes.
- SECTION 6.03.1 - Removal Of Abandoned Gas Facilities With Possible Coal Tar Wrap. All Sizes. (For National Grid Work Only)
- SECTION 6.03.1a - Removal Of Abandoned Gas Facilities With Possible Coal Tar Wrap. All Sizes. (For Con Edison Work Only)
- SECTION 6.04 - Adjust Hardware To Grade Using Spacer Rings/Adaptors. (Street Repaving.)
- SECTION 6.05 - Adjust Hardware To Grade By Resetting. (Road Reconstruction.)
- SECTION 6.06 - Special Care Excavation And Backfilling.
- SECTION 6.07 - Test Pits For Gas Facilities.

IV - STANDARD SKETCHES; GAS COST SHARING WORK

- NO. 1 - Support Requirements For Gas Mains And Services Crossing Excavation Greater Than 4'-0" Wide At Any Angle
- NO. 1A - Support Requirements For Gas Mains Over 16" Diameter Up To And Including 48" Diameter Crossing Excavation At Any Angle
- NO. 2 - Typical Methods Of Measurement For Gas Crossings
- NO. 3 - Utility Crossings During Catch Basin Chute Connection Pipe Installation
- NO. 4 - Utility Crossings During Catch Basin Chute Connection Pipe Installation (Extra Depth)
- NO. 5 - Gas Main Encroachment On And/Or Parallel To Excavation Of Unsheeted Trench

V - PRELIMINARY GAS WORK TO BE PERFORMED BY FACILITY OPERATOR

VI - LISTING OF APPROXIMATE LOCATIONS OF EP-7 BID ITEMS QUANTITIES

I - NOTICE TO ALL BIDDERS; GAS COST SHARING WORK

All prospective bidders are hereby advised that, pursuant to the "Gas Facility Cost Allocation Act", ("the Act"), the City of New York has entered into an agreement ("the Agreement") with the gas companies (Con Edison or National Grid (formerly KeySpan Energy Delivery)) operating in their respective areas of the City to "share" the cost of facility relocation and/or support and protection of facilities disturbed by proposed water and/or sewer and related City work specified in this contract. Therefore, bid items, specifications and estimated quantities for the incremental costs of support and protection of certain gas facilities have been included in this contract. The low bid for this contract shall be determined by examining each bid for all work to be performed under this contract including any work of support and protection of gas facilities to be performed. The Contractor shall not seek additional compensation from gas companies except as specifically set forth in its contract.

II - GENERAL PROVISIONS; GAS COST SHARING WORK

1. General:

The Contractor shall perform City work with interferences from existing live and abandoned gas facilities. This shall be defined as utility work. Therefore, this contract includes bid items, specifications and estimated quantities designed to fully compensate him/her for the incremental costs of supporting, protecting, providing accommodations and, avoiding disturbing gas facilities located in the streets shown on the contract drawings. In the event that any other provisions of this contract related to gas facilities (or private utilities) conflict with these provisions, these provisions shall supersede and govern all work related to gas facilities owned by the companies operating in the project area. All utility work, as defined in these specifications, including changes and additions thereto shall be paid solely by the City except when specified otherwise in this contract. Contractor hereby agrees that the facility operator shall not be liable to pay him/her for any work performed including extra utility work. Contractor agrees that its bid prices include all compensation for loss of productivity and efficiency, idle time, delays (including any delays occasioned by negotiation of a contract change), change in operations, mobilization, demobilization, remobilization, added cost or expense, lost of profit, other damages or impact costs that may be suffered by or because of utility work, or the presence of gas facilities in the proximity of City work and that it will not seek additional compensation for these items. All disputes shall be resolved as specified in the contract.

Pursuant to the Act, Agreement, and the New York City Administrative Code, the gas company(ies) has been directed by the Commissioner and is required to perform all maintenance, repairs, replacement, shifting, alteration, relocation, and/or removal work that are not part of this contract. By having bid on this contract, the Contractor understands and agrees that the Commissioner has preasserted any right the City has to require, including the issuance of any directives or so called "order outs" under the New York City Administrative Code, any or all gas companies to maintain, repair, replace, protect, support, shift, alter, relocate, and/or remove all gas facilities that are about to be disturbed by the City contract work. The issuance of additional such directives during the performance of the contract work, where necessary in the sole judgment of the Commissioner, shall be initiated by such Commissioner as set forth in the relevant sections of the Act and Agreement. Contractor further agrees to insert such requirements as set forth herein above into any contracts with its approved subcontractors so that its subcontractors also understand and agree to such contract requirements.

2. Gas Interferences And Accommodations:

During the performance of sewer and water main work funded by the New York City Department of Environmental Protection (NYCDEP), as instructed by the Engineer, the use of any applicable contract bid item is allowed in order to resolve and accommodate all gas facilities interferences with such City work, including the removal of contaminated soil in associated trench excavation. This is in addition to the specified EP-7 bid items in the contract. Payment for such accommodation shall be funded by EP-7 bid item "UTL-GCS-2WS - GAS INTERFERENCES AND ACCOMMODATIONS" (F.S. Fixed Sum). The value of such accommodation shall be computed by multiplying the appropriate unit prices bid to the quantity of work performed, as determined by the Engineer, and applying the total amount thus to be paid

to EP-7 bid item "UTL-GCS-2WS - GAS INTERFERENCES AND ACCOMMODATIONS". When EP-7 bid item "UTL-GCS-2WS - GAS INTERFERENCES AND ACCOMMODATIONS" does not exist, such additional accommodation work shall be at no cost to the City but shall be a matter of adjustment between gas facility operator and Contractor. Private facilities, other than gas, that become in interference due to gas interferences accommodations shall also be accommodated, if so directed by the Resident Engineer, at no additional cost to the City and, provided that its owner agrees to be responsible for all additional costs to Contractor, otherwise, such facility shall be ordered by the City to be maintained, shifted, relocated or replaced by its owner at his/her expenses.

2a. Water Main Accommodations:

When water main construction is to be performed in this contract, Contractor shall be required, if warranted by field conditions, and at locations designated by the Resident or Borough Engineer, to change the vertical or horizontal alignment of water mains including but not limited to all additional labor, material, work method accommodations, furnishing, delivering and laying offset fittings and pipes, etc., necessary in order to complete water main installation and, avoid gas interferences in the project area, including street intersections. Typical work method accommodations shall include, but not be limited to, pier and plate, installation of filter fabric and select fill, etc. Such work shall be performed as directed by the Engineer and in accordance with contract specifications and latest edition of water mains standards and specifications.

2b. Sewer Accommodations:

When sewer construction is to be performed in this contract, Contractor shall be required, if warranted by field conditions, and at locations designated by the Resident or Borough Engineer, to change the horizontal alignment of sewer facilities (if possible) including but not limited to all additional labor, material, work method accommodations, furnishing, delivering and construction of additional manholes or modification of manholes/catch basins, extending chute connections, house connections, using alternate materials and methods, poured-in-place structures, etc., necessary in order to complete sewer installation and, avoid gas interferences in the project area, including street intersections. The term sewer facility shall include, but not be limited to, all sewer pipe and appurtenances, manholes, catch basins, catch basin chutes, etc. Such work shall be performed as directed by the Engineer and in accordance with contract specifications and latest edition of sewer standards and specifications.

3. Quantity Overruns, EP-7 Funded Bid Items:

No quantity overrun, in excess of one hundred twenty five (125) percent, shall be permitted for EP-7 funded bid items (gas) included in this contract, except when Resident Engineer determines that such overruns are caused by field modifications to planned City work, or approved construction methods, or contract scope changes. Overruns not paid by City shall be negotiated and paid to Contractor by gas facility operator who then shall be entitled to reimbursement by NYCDEP under established cost sharing procedures.

4. Changes And Extra Work:

This section is not applicable to work defined under "Emergency Reconstruction Contracts" or so-called "Where and When Contracts" since these projects, by definition, inherently encounter unanticipated gas facilities and cannot be pre-engineered. In all other cases, any contract changes proposed for City work shall also cover and include all associated changes to support and protection of gas facilities affected by such changes to City work. In all other cases where the Contractor finds that City work cannot be performed as planned and specified and/or, as approved because of a need to support, protect and/or alleviate interferences from gas facilities that were not listed and/or shown, or incorrectly shown in contract plans and specifications, he shall immediately notify the Resident Engineer and the facility operators' representative of his findings. Resident Engineer shall promptly examine such claims and determine whether or not such work is covered by contract bid items and /or specifications (contract bid items and specifications shall include city contract items as well as EP-7 items). The Resident Engineer shall also examine the claim to determine if the application of EP-7 bid item "UTL-GCS-2WS - GAS INTERFERENCES AND ACCOMMODATIONS" is appropriate to resolve the claim. If upon examination, the Engineer determines that such field conditions were unanticipated (not shown and/or listed, or incorrectly shown in contract documents) and are not covered by bid items and contract specifications, he shall then direct the Contractor and the affected facility operator to negotiate the cost of supporting and

protecting, and/or alleviating the impact on City work caused by such unanticipated gas facilities with each other with the understanding that the performance of City work shall continue during negotiations. If a cost agreement is reached, the Contractor and facility operator shall adjust such costs between themselves at no additional costs to the City contract. If the Contractor and affected facility operator do not reach an agreement concerning the price to be paid for the extra work within five (5) business days of the Engineer's directive to engage into such negotiations and, after considering: public safety and inconvenience, requirements of laws and regulations applicable to private utilities, integrity of all utility systems, including but not limited to sewer and water, gas, electric, telephone and, cable TV facilities, sound engineering practices, cost (long and short term) to all affected parties, and potential City work delays, then the Resident Engineer, depending on nature and severity of interferences with City work, shall either, direct the facility operator to relocate or replace its facilities at its own discretion and cost, reimbursable by NYCDEP under established gas cost sharing procedures or, direct the Contractor to perform the utility work on actual time, material and equipment costs basis pursuant to relevant contract requirements and amendments. Contract bid prices for any applicable items of work involved shall be applied, or converted to an allowance for time and material charges. Changes shall be for affected portions of utility work and, shall be processed with EP-7 funds.

5. Excavation:

All excavators shall notify the NYC/LI One Call Center at 1-800-272-4480 at least two (2) working days, not including the day of the call, but not more than ten (10) working days in advance of the start of any excavation work. The gas company(ies) will mark out its facilities within the project limits and provide Construction Inspector(s) during all excavation work in close proximity (within twelve (12) inches) to gas facilities. The Contractor shall exercise extreme caution when excavating in the vicinity of any gas facilities. Hand excavation shall be performed within twelve (12) inches of gas facilities. The Contractor prior to excavating underneath these facilities shall adequately support all gas facilities. Standard support details for gas facilities have been included in the specifications. Any damage to gas facilities shall be reported immediately to the gas company(ies). The Contractor shall be responsible for all cost associated with repairs made necessary by damages caused by his operations.

6. Backfilling And Street Restoration:

Backfilling operations and street restorations shall be in accordance with contract requirements.

7. Non-Responsive Bids:

Every gas (EP-7) bid item has a suggested "Not less than" value per unit indicated on contract bid sheet. Bids resulting in cost of less than suggested for EP-7 items are hereby prohibited and if submitted shall be considered NON-RESPONSIVE.

8. Minimum Clearances:

Clearance requirements for City work shall govern and supersede any clearance requirement of gas facility operator. Therefore, a minimum of twelve (12) inches clearance between private utilities and City water mains, sewers or related structures to be installed in this contract shall be maintained. When this clearance is not attainable, the Resident Engineer may allow a minimum of four (4) inches clearance. With less than twelve (12) inches clearance a neoprene/polyethylene shield (to be provided by facility operator) shall be installed as part of all work item specifications. However, if Resident Engineer determines that City work cannot be performed within allowable clearance and no reasonable City accommodation (no-cost change to City work) is possible, the City shall direct the facility operator to remove, relocate, shift, or alter their facility(ies) pursuant to the New York City Administrative Code.

9. Work By Facility Operator:

The facility operator may find it necessary to perform the following types of work during performance of City work: accommodating a contractor's request for gas facilities modifications (in order to facilitate City contractor's proposed construction method) or, remedial and emergency work on gas facilities proper with their own resources and materials if an approved method of construction for City work causes unanticipated disturbances to gas facilities or, replacing defective gas facilities when they are exposed by the Contractor and their actual conditions are observable by the facility operator. Also included in the above category of defective gas facilities are: the presence of environmental contaminants attributable to

the gas facility in or around gas facilities. If such work is deemed required by the facility operator or if facility operator is directed by the City to address such deficiencies at any time during the course of construction, the Contractor shall modify the construction schedule at no cost to the City and allow the facility operator five (5) business days to perform such work without interferences. Additional costs to the facility operator (in cases of accommodations) or, Contractor (in cases of defective gas facilities) due to such gas work, if any, shall be the responsibility of the parties involved and not of the City. Such costs shall be a matter of adjustment between the Contractor and the facility operator.

10. Materials Furnished By Facility Operator:

It shall be the Contractor's responsibility to inspect material to be installed by him immediately upon delivery and advise the facility operator through its authorized representative, of all damaged materials. The Contractor at no additional costs to the City or the facility operator shall replace any material that is damaged or lost after the Contractor's inspection.

11. Liability And Insurance:

Notwithstanding the provisions of this contract, the existing division of liabilities to third parties shall remain the same as between the City and the company. Therefore, it is specifically agreed by the City, company and Contractor (by bidding on this contract) that for the purpose of any liabilities to third parties, that the City contractor performing work directly and physically relating to gas company facilities in this project, shall be deemed an agent of the company and not an agent of the City, the New York City Municipal Water Finance Authority, or the New York City Water Board. Contractor shall include the company as an additional insured on all insurance policies maintained to comply with the City's insurance requirements.

12. Width And Depth Of Excavation:

Contractor shall not be authorized to deliberately change trench or excavation widths and/or depth specified without Engineer's approval. Enlargement of any side of excavation up to eighteen (18) inches beyond pay limits (or inside face of sheeting) requested by the Contractor for the installation of certain types of sheeting may be granted. However, such enlargements or those greater than allowable shall not be approved when, in the sole judgment of the City, field conditions allow the water mains and sewer work to be performed within the limits specified and, the sole purpose of such enlargement request is to impact adjacent utilities (public or private) whose support and protection are part of this contract. Any approval shall be given at no additional cost to the City contract, including EP-7 funding, and all costs associated with unauthorized enlargements shall be the sole responsibility of the Contractor.

13. Depth And Crossing Angles Of Gas Facilities:

Where gas facilities are shown (or specified as) crossing proposed alignment of sewers, water mains, catch basins and chute connections or any other proposed excavations at specific angles (as measured off plans or sketches or specified in contract), it shall be understood that actual field measurements may deviate (plus or minus) forty-five (45) degrees from those shown or specified. The cover, or depth from street surface to top of facilities, shall be as shown or specified in contract documents, no deviation is to be assumed. Where gas facilities are not shown on contract documents, but their support and protection are otherwise included in this contract then, all references to facilities crossing at "various angles and depth" in the gas sections shall mean that such facilities are crossing sewer, water, catch basin and, catch basin chute, and other excavations at a ninety (90) degree angle to the proposed sheeting line or side of excavation (for unsheeted trenches) with an allowable deviation of forty-five (45) degrees in any direction, except for catch basin chute excavation where the allowable deviation shall be sixty (60) degrees. Where the cover is not noted or specified, the bottom face of such facilities shall be assumed to be crossing catch basin chutes at a depth of three (3) foot eight (8) inches or less from the street surface. Paragraph No. 2 above shall apply in cases of distribution water main construction. Appropriate bid items and specifications are provided for cases where angle and depth are greater than stated above. This section also applies to work defined in "Emergency Reconstruction Contracts" or so-called "Where and When Contracts". These contracts are not pre-engineered and consequently have no drawings, sketches or determined locations and so, gas facilities encountered will be crossing existing and proposed sewer, water, catch basin/catch basin chutes and all appurtenances at various angles and depths.

14. Maintenance Of Traffic For Gas Work:

All work pertaining to gas bid items and specifications shall be performed within the contract maintenance of traffic plan as specified in the contract document. The bid price for the Maintenance and Protection of Traffic shall cover all work pertaining to gas items. The City shall make compensation for additional maintenance and protection of traffic items in connection with gas item of work only when such additional work is deemed reasonable and necessary by the Resident Engineer and is approved by him prior to its performance.

15. Relocated Gas And Temporary Systems Installation:

In cases where the Contractor is allowed to select the location for temporary construction such as, installation of dewatering headers, wells, well points, etc., he shall not disturb any gas facilities shown on sketches provided in this section. The only exception shall be, if the affected gas company agrees to such relocation and provided that the cost of such relocation is a matter of adjustment between the company and Contractor, and at no cost to the City.

16. Role Of Company Inspector:

In any case in which the City elects to perform some or all support and protection work with its own employees, personnel or contractors, the facility operator shall provide onsite inspectors to approve and certify such support and protection work (exclusive of City accommodations) performed by the City's own employees, personnel, and contractors. Facility operator's inspectors are not authorized to direct City contractor during the performance of contract work. They shall act through the City Resident Engineer and provide him/her required approvals and certifications, prior to preparing partial payments of EP-7 items, in a format and frequency to be prescribed by the appropriate City Head of Construction.

17. Coordination With Gas Company:

The Contractor shall be required to notify the gas company(ies), in writing, at least two (2) weeks prior to the start of final paving in order to allow companies to complete any unfinished gas work located within the area to be paved. Every effort shall be made to maintain gas service with minimum inconvenience to the public.

III - TECHNICAL SECTION

SECTION 6.01 - Trench Crossings; Support And Protection Of Gas Facilities And Services.

1. Description:

Under this section, the Contractor shall provide all labor, materials, equipment, and incidentals required to support and/or protect the integrity of gas mains, services and appurtenances of any sizes, configurations, and operating pressures crossing trench excavations above subgrade for planned construction of sewers and water mains facilities. A gas service shall be defined as a gas pipe of three (3) inches in diameter or less branching from the main to a customer pick up point or property valve box. A gas main may be any size pipe that is part of a distribution or transmission network other than services described above. Crossings shall be defined as gas facilities spanning the width of excavation (one side to the other side). These crossings may be at various angles and depth as shown on "Gas Cost Sharing Work Standard Sketches Nos. 1 and 1A", and as specified in "General Provisions; Gas Cost Sharing Work Paragraph No. 13" and, at the locations shown or listed in contract documents. The gas company operating in the area, (facility operator), owns these facilities. The work shall be performed in accordance with contract specifications, plans, and at the directions of the Resident Engineer in consultation with the authorized representatives of the facility operator.

2. Method Of Construction:

- A. Protection: In general, the gas facilities shall be protected as required by New York State Industrial Code 753. In particular, the Contractor shall use hand excavation methods (pick and shovel or hand held power tools) directly below the pavement base to expose the gas facilities (marked out by facility operators) and to ascertain the clearances and cover of the facilities with respect to the proposed excavation. Upon exposing the affected facilities sufficiently, at the discretion of the Resident Engineer, to ascertain the foregoing, Contractor shall be permitted to proceed with a combination of hand and machine excavation, as appropriate, outside a zone of protection whose limit shall be defined as a perimeter located twelve (12) inches from the outside face of each gas facility crossings (See "Gas Cost Sharing Work Standard Sketch No. 2"). If the facilities are in direct interference with City work, meaning that "Minimum Clearances" described in "General Provisions; Gas Cost Sharing Work Paragraph No. 8" cannot be maintained, and excavation has to be temporarily or permanently abandoned then this particular location shall become a test pit and dealt with as specified in Section 6.07, and "General Provisions; Gas Cost Sharing Work Paragraphs Nos. 2 and 8".
- B. Support: Gas mains or services crossing excavations equal or less than four (4) feet wide are generally self supporting, unless field conditions as determined by the Resident Engineer require otherwise. The support requirements for gas mains and services crossing excavations greater than four (4) feet wide shall be as shown on the attached "Gas Cost Sharing Work Standard Sketch No. 1" and Contractor shall use sheeting methods that permit the maintenance of gas facilities in their existing locations and configurations. Alternate methods equivalent to those shown on the sketch or accommodations by the facility operator proposed by the Contractor in order to facilitate the execution of the specified work shall be allowable, provided that prior approval is obtained by the Contractor from the Engineer and the facility operator. The support and protection of gas facilities crossings shown on plans, drawings, listings or otherwise identified in this contract shall not be circumvented with the issuance of so called "order outs".

3. Method Of Measurement:

The Contractor shall be paid for supporting and/or protecting gas facilities crossing trench excavations under the appropriate bid items covered by this section. The Contractor shall be directly responsible to the facility operator for the total cost of using any alternate method requiring the use of resources owned by the facility operator. Regardless of the method used, the City shall pay the bid price for the appropriate support and/or protect item of work. The average rate charged by the facility operator for alternate support and protection work such as, disconnecting and reconnecting gas services is listed in attached "Schedule GCS-A".

4. Payment Restrictions:

These items shall not be paid for: gas services crossing unsheeted water main trench excavation; abandoned gas main/services identified by facility operator; gas mains/services crossing trench excavations for fire hydrant branch connections pipes, catch basins and/or chutes (sewer drain pipe), house sewer and/or water services; gas facilities encroaching any face of excavation for sewer and/or water construction, all of which are covered under other contract sections. Also this item shall not be paid for new gas mains and services crossing water trenches when trenching for such new facilities has been performed by the Contractor in common with trench excavation for City work (overlapping trench limits). The cost of supporting and protecting such gas facilities crossings shall be deemed included in the cost of trench excavation for the new gas facilities. This payment restriction shall apply even if such common trench gas excavation is not part of the contract. The prices bid for items covered by this section represent full compensation to Contractor to completely perform the work described. No other bid items shall be combined with these items in order to pay for gas main and/or services crossing excavations specified herein.

5. Method Of Payment:

Each (Ea.) gas facility crossing trench excavation as described in these specifications shall be counted for payment.

6. Price To Cover:

The cost of timber/steel supports installed for gas facilities shall be included in the bid price. The bid price for each crossing shall also cover all additional supervision, labor, material (except those provided by the facility operator), equipment and insurance necessary to completely maintain the gas facilities without disruption of service to the customers and in accordance with contract plans, specifications and facility operator standards. The price shall also include: changes of method of operations; sheeting modifications where necessary to accommodate the gas facilities crossings; installation and removal of water pipe under gas facilities (so called "snaking"); extra care during excavation (including hand excavation under existing single and multiple gas facilities); extra backfilling and compaction around, over and under gas facilities; installation and removal of sheeting around gas facilities; associated maintenance and protection of traffic; barricades; and traffic plates that may be required to temporarily close and/or complete the work.

SECTION 6.02 - Extra Excavation For The Installation Of Catch Basin Sewer Drain Pipes With Gas Interferences.

1. Description:

Under this item, the Contractor shall provide all labor, materials, equipment, insurance, and incidentals for the extra excavation associated with the installation of catch basin sewer drain pipes (chute) under gas facilities of various sizes crossing the trench excavation at various angles and depth at the locations shown in the contract documents and also, for the support and protection of these facilities during associated excavation and backfill operations. The gas company operating in the area, (facility operator), owns these facilities.

2. Method Of Measurement:

The bid price shall be per location (Each) where extra excavation is required when catch basin sewer drain pipes are installed at an upstream invert depth lower than four (4) feet (up to a maximum of six (6) feet) from the proposed pavement grade because the bottom faces of interfering gas mains and appurtenances are located at a depth greater than three (3) foot eight (8) inches from proposed pavement surface (See "Gas Cost Sharing Work Standard Sketch No. 4").

3. Method Of Construction:

Incremental cost responsibility for chute excavation is determined by the first private facility encountered starting from catch basin structure proper and that prevents the installation of the chute connection at an upstream cover less than or equal to three (3) feet or any other minimum cover required to avoid City facilities (e.g. water, sewer, etc.) as directed by the Resident Engineer.

4. Payment Restrictions:

This item shall not apply and related bid item shall not be paid in cases where:

- A. Upstream invert chute is more than six (6) feet deep because of gas facilities.
- B. Chute cannot be installed above existing gas facilities because of interferences with other private facilities that are not otherwise covered under this contract, regardless of upstream invert depth.

The above cases shall be at no cost to the City, but shall be a matter of adjustment between the Contractor and the facility operator(s).

5. Price To Cover:

The bid price shall cover the additional cost of all additional supervision, labor, materials, equipment and insurance, to complete the installation of catch basins and associated sewer connections in accordance with the contract plans and specifications. The price shall include: excavation by hand around and under single and multiple gas facilities; locating, supporting and protecting gas facilities; backfilling and all other items necessary to perform all work incidental thereto including: installation and removal of drain pipe under gas facilities ("snaking"); widening of trenches to facilitate the above work; subsequent additional

backfill and pavement restoration; modifying precast catch basin window to accommodate connection; changing sheeting method and configuration to accommodate gas facility crossings; maintenance and protection of traffic; barricades; and installation of traffic plates that may be required to temporarily close and/or complete the work. The price shall not include removal of ledge rock and/or excavation of boulders in open cut.

SECTION 6.02.1 - Extra Excavation For The Installation Of Catch Basin Sewer Drain Pipes With Upstream Inverts Greater Than Six (6) Feet.

1. Description:

Under this item, the Contractor shall provide all labor, materials, equipment, insurance and incidentals for the extra excavation of catch basin chutes where the upstream invert is greater than six (6) feet under gas facilities of various sizes crossing the trench excavation at various angles and depth at the locations shown in the contract documents or as determined by field conditions and also, for the support and protection of these facilities during the associated excavation, sheeting and backfilling operations.

2. Method Of Measurement:

The bid price shall be per location (Each) where extra excavation and sheeting is required when the catch basin chute installed at an upstream invert depth lower than six (6) feet from the proposed pavement grade because the bottom faces of the interfering gas mains and appurtenances are located at a greater depth than three foot eight inches from the proposed pavement surface only.

3. Method Of Construction:

Incremental cost responsibility for chute excavation is determined by the first private facility encountered during such excavation when initiated from catch basin structure and that prevents the installation of the chute at an upstream cover less than or equal to three (3) feet or any other cover required to avoid City facilities as directed by the Resident Engineer.

4. Payment Restriction:

This item shall not apply and related bid item shall not be paid in cases where:

Upstream invert chute is less than or equal to six (6) feet deep because of gas facilities. Section 6.02 shall be paid.

5. Price To Cover:

The bid price shall cover the additional cost of all supervision, labor, materials, equipment and insurance to complete the installation of catch basin and associated sewer connections in accordance with the contract plans and specifications. The price shall include: excavation by hand around and under single and multiple gas facilities; locating, supporting and protecting gas facilities incidental thereto; widening of trenches to facilitate the above work; subsequent additional backfilling and pavement restoration; modifying pre-cast basin window to accommodate connection; the installation of catch basin with deeper sumps as specified; additional sheeting and changes in sheeting method and configuration to accommodate gas facility crossings; maintenance and protection of traffic; barricades; and installation of traffic plates that may be required to temporarily close and/or complete the work.

SECTION 6.03 - Removal Of Abandoned Gas Facilities. All Sizes.

1. Description:

Under this section the Contractor shall provide all labor, materials, equipment, insurance and, incidentals required for the removal of abandoned gas mains, services, or appurtenances thereof, located within the street shown on the contract plans, owned by gas company operating in the project area (facility operator), used or to be used for or in connection with or to facilitate the conveying, transportation, distribution or

furnishing of gas (natural or manufactured or mixture of both) for light, heat, or power, but does not include property used solely for or in connection with business of selling, distributing or furnishing of gas in enclosed containers. Such removal shall include only abandoned gas facilities that interfere with (i.e. cause additional work) City work.

2. Determination Of Operating Status Of Gas Facilities:

The Contractor shall notify facility operator, as required by New York State Industrial Code 753. Gas facilities shall not be removed without the approval of the facility operator whose authorized representative shall certify in writing (specific facility or area wide facilities certification) and in a timely manner acceptable to the Resident Engineer that abandoned facilities are free of combustible gas and any other environmental contaminants prior to removal. The Resident Engineer shall rely on facility operator's certification. The facility operator may request the excavation of test pits (See Section 6.07) for this determination ahead of City work and, Contractor shall provide safe access, facilitate and permit facility operator to enter test pit excavations for the purpose of testing gas facilities to be removed by the Contractor. However, facility operator may prefer to make this test during performance of City work, in order to issue the above certification. This shall be permitted provided that it is agreed that additional costs, if any resulting from this choice shall be a matter of adjustment between the Contractor and facility operator only, and at no cost to the City.

3. Restrictions:

The facility operator shall be solely responsible for its contaminated gas facilities, surrounding contaminated soil and their disposal and abatement procedures, unless contract bid items are applicable and provided for such work. In such cases, the quantity removed shall be charged to EP-7 bid item "UTL-GCS-2WS - GAS INTERFERENCES AND ACCOMMODATIONS" at the City bid prices.

4. Method Of Measurement:

Abandoned gas pipeline removal shall be measured for payment per linear foot of pipe and appurtenances removed.

5. Price To Cover:

The price shall cover all additional cost of supervision, labor, materials, equipment, and insurance necessary to complete this work in accordance with the contract plans and specifications, including excavation by hand around and under other City and facility operator owned properties and, where necessary, support and protection of such properties. The price shall also cover breaking, cutting, and/or burning of abandoned gas pipes and their disposal from the site; sealing open ends remaining in the excavation with concrete or caps (caps to be provided by the facility operator) and backfilling of the area where the pipeline has been removed with clean backfill. The price shall also include any required dump charges. This item does not include any type of extra excavation, backfilling, compaction, pavement removal and restoration associated with abandoned gas facilities removal, all of which are covered under Section 6.06.

**SECTION 6.03.1 - Removal Of Abandoned Gas Facilities With Possible Coal Tar Wrap.
All Sizes. (For National Grid Work Only)**

1. Description:

Under this section the Contractor shall provide all labor, materials, equipment, insurance and, incidentals required for the removal of abandoned gas mains, services or appurtenances thereof, located within the street shown on the contract plans, owned by the gas company operating in the project area (facility operator), used or to be used for or in connection with or to facilitate the conveying, transportation, distribution or furnishing of gas (natural or manufactured or mixture of both) for light, heat, or power, but does not include property used solely for or in connection with business of selling, distributing or furnishing of gas in enclosed containers. Such removal shall include only abandoned gas facilities that interfere with (i.e. cause additional work) City work. These gas facilities may be coated with Coal Tar Wrap and so, may require special handling and disposal methods as specified in National Grid Standard Operating Procedure 12-2, Coal Tar Wrap Handling and 12NYCRR56.

2. Determination Of Operating Status Of Gas Facilities:

The Contractor shall notify facility operator, as required by New York State Industrial Code 753. Gas facilities shall not be removed without the approval of the facility operator whose authorized representative shall certify in writing (specific facility or area wide facilities certification) and in a timely manner acceptable to the Resident Engineer that abandoned facilities are free of combustible gas and any other environmental contaminants prior to removal. The Resident Engineer shall rely on the facility operator's certification. The facility operator may request the excavation of test pits (See Section 6.07) for this determination ahead of City work and, the Contractor shall provide safe access, facilitate and permit facility operator to enter test pit excavations for the purpose of testing gas facilities to be removed by the Contractor. However, the facility operator may prefer to make this test during performance of City work, in order to issue the above certification. This shall be permitted provided that it is agreed that additional costs, if any, resulting from this choice shall be a matter of adjustment between the Contractor and the facility operator only, and at no cost to the City contract. Should such investigation result in the determination that the abandoned gas facilities do not contain Coal Tar Wrap then the removal of said facilities shall be covered under separate item (See Section 6.03).

3. Requirements:

The City Contractor shall excavate abandoned gas facility sufficiently, either in its entirety, or at locations determined by Contractor to allow the removal of Coal Tar Wrap (if present on the abandoned gas facility) and to facilitate the safe extraction of manageable lengths of abandoned pipe without damage to adjacent facilities, utilities or City structures either parallel to or crossing above or below abandoned gas facility. The Contractor is to allow access to the designated cutting points within the Contractor's trench by authorized National Grid personnel who will remove the Coal Tar Wrap as per National Grid procedures. This work by National Grid personnel shall be performed in a timely fashion and shall not unduly impede the Contractor's progress and/or productivity. Upon completion of the coating removal, the Contractor shall be allowed to cut, burn or grind the gas facility and remove the section of abandoned pipe. The Contractor at a site designated by the Contractor shall stockpile the removed pipe. The facility operator will be responsible to provide trucking and disposal services with its own personnel and shall remove the stockpiled pipes during off hours or during such time as agreed to by the Contractor. Since the pipe removed will remain the property of the facility operator and is to be disposed of by the facility operator, the facility operator shall be responsible for any required notifications, filings, dump charges and incidentals associated with the disposal of abandoned gas facilities found to contain Coal Tar Wrap.

4. Method Of Measurement:

Abandoned gas pipeline removal shall be measured for payment per linear foot of pipe and appurtenances removed.

5. Price To Cover:

The price shall cover all additional cost of supervision, labor, materials, equipment and insurance necessary to complete this work in accordance with the contract plans and specifications, including excavation by hand around and under other City and facility operator owned properties and, where necessary, the support and protection of such properties. The cost shall also include hand excavation in the area(s) of proposed abandoned pipe cut(s), cutting and/or burning of abandoned gas pipes and stockpile of removed sections of abandoned pipe and associated maintenance and protection of traffic, blocking and temporary fencing if required. The unit price shall also cover sealing open ends remaining in the excavation with concrete or end caps (end caps to be provided by the facility operator) and backfilling of the area where the abandoned pipeline has been removed with clean backfill material. This item does not include any type of extra excavation, backfilling, compaction, pavement removal and/or restoration (temporary and permanent) associated with abandoned pipe removal ("lost trench"), all of which are covered under separate Section 6.06. The price shall also include allowance for any loss of productivity by the Contractor due to required facility operator work to remove pipe coating and prepare pipe for cutting as well as any change in Contractor's excavation method, additional trucking and/or stockpiling costs.

SECTION 6.03.1a - Removal Of Abandoned Gas Facilities With Possible Coal Tar Wrap. All Sizes. (For Con Edison Work Only)

1. Description:

Under this section the Contractor shall provide all labor, material, equipment, insurance and, incidentals required to prepare abandoned gas mains, services and appurtenances thereof located within the street shown on contract plans, owned by the gas company operating in the project area (facility operator), for removal due to interference with proposed City work. These abandoned gas facilities were, at one time, used for or in connection with or to facilitate the conveying, transportation, distribution or furnishing of gas (natural, manufactured or a combination of both) for light, heat, or power, but does not include property used solely for or in connection with business of selling, distribution or furnishing of gas in enclosed containers. Such preparation for removal shall include only abandoned gas facilities that interfere with (i.e. cause additional work) City work. These gas facilities may be coated with Coal Tar Wrap which may contain asbestos or PCB's and so, may require special handling and disposal methods as specified in Con Edison - ASBESTOS MANAGEMENT MANUAL, CHAPTER 6 - ASBESTOS WORK PROCEDURES, SECTION 06.04 - COAL TAR WRAP REMOVAL. For under 25' (feet) in length and an approved NYC-DEP variance for over 25' (feet).

2. Determination Of Operating Status Of Gas Facilities:

The Contractor shall notify facility operator, as required by New York State Industrial Code 753. Gas Facilities shall not be removed without the approval of the facility operator whose authorized representative shall certify in writing (specific facility or area wide facilities certification) and in a timely manner acceptable to the Resident Engineer that abandoned facilities are free of combustible gas and any other environmental contaminants prior to removal. The Resident Engineer shall rely on the facility operator's certification. The facility operator may request the excavation of test pits (See Section 6.07) for this determination ahead of City work and Contractor shall provide safe access, facilitate and permit facility operator to enter test pit excavations for the purpose of testing gas facilities. However, the facility operator may prefer to make this test during performance of City work in order to issue the above certification. This shall be permitted provided that it is agreed that additional costs, if any, resulting from this choice shall be a matter of adjustment between the Contractor and the facility operator only, and at no cost the City contract. Should such investigation result in the determination that the abandoned gas facilities do not contain Coal Tar Warp then the removal of said facilities shall be covered under separate item (See Section 6.03).

3. Requirements:

The Contractor shall excavate abandoned gas facility sufficiently, either in it's entirety, or at locations determined by Contractor to allow the removal of Coal Tar Wrap (if present on the abandoned gas facility) and to facilitate the safe extraction of manageable lengths of abandoned pipe without damage to adjacent facilities, utilities or city structures either parallel to or crossing above or below abandoned gas facility. The Contractor is to allow access to the designated cutting points within the Contractors trench by authorized Con Edison personnel who will remove the Coal Tar Wrap as per Con Edison and/or NYC-DEP approved procedures. This access shall conform to all applicable codes, rules & regulations. This work by Con Edison personnel shall be performed in a timely fashion and shall not unduly impede the Contractors progress and/or productivity. Upon completion of the coating removal, the Contractor shall be allowed to cut, burn or grind the gas facility and remove the section of abandoned pipe. Contractor shall designate a specific site to stockpile those removed pipes. The facility operator will be responsible to provide trucking and disposal services with its own personnel and shall remove the stockpiled pipes during off hours or during such time as agreed to by the Contractor. Since the pipe removed will remain the property of the facility operator and is to be disposed of by the facility operator, the facility operator shall be responsible for any required notifications, filings, dump charges and incidentals associated with the disposal of abandoned gas facilities found to contain Coal Tar Wrap.

4. Method Of Measurement:

Abandoned gas facility removal shall be measured for payment per linear foot of pipe and appurtenances removed.

5. Price To Cover:

The price shall cover all additional cost of supervision, labor, materials, equipment and insurance necessary to complete this work in accordance with the plans and specifications, including, but not limited to, excavation by hand around and under other City and facility operator owned properties and, where necessary, the support and protection of such properties. The cost shall also include hand excavation in the area(s) of proposed abandoned pipe cut(s), cutting and/or burning of abandoned gas pipes and stockpile of removed sections of abandoned pipe and associated maintenance of traffic, blocking and temporary fencing if required. The unit price shall also cover sealing open ends remaining in the excavation with concrete or end caps (end caps to be supplied by facility operator) and backfilling of the area where the abandoned pipeline has been removed with clean backfill material. This item does not include any type of extra excavation, backfilling, compaction, pavement removal and/or restoration (temporary and permanent) associated with abandoned pipe removal ("lost trench"), all of which are covered under separate Section 6.06. The price shall also include allowance for any loss of productivity by the Contractor due to required facility operator work to remove pipe coating and prepare pipe for cutting as well as any change in Contractor excavation method, additional trucking and/or stockpiling costs.

SECTION 6.04 - Adjust Hardware To Grade Using Spacer Rings/Adaptors. (Street Repaving.)

1. Description:

Under this section, the Contractor shall provide all labor, supervision, materials, equipment, insurance and incidentals required to adjust to final grade gas street surface hardware located within the contract area boundaries shown on the plans. The gas company operating in the area, (facility operator), owns these facilities. The work shall be performed in accordance with the contract plans, specifications and at the directions of the Resident Engineer in concurrence with authorized representative of the facility operator.

2. Materials:

The facility operator shall furnish and deliver all prefabricated hardware parts required. These include adaptors for the grade adjustment proper and new street hardware if existing ones are found to be defective, all in accordance with the facility operator standards and City rules and regulations. The Contractor shall notify the facility operator of the installation schedule at least three (3) business days before materials are required on the site. Should the facility operator fail to deliver the necessary material according to any schedule mutually agreed upon by the Contractor and facility operator, the City shall not be responsible for any delays attributable thereto, nor for the failure of delivery of such materials. On project where material storage is not permitted on site, the facility operator shall deliver the required material to the Contractor's yard and it shall be the Contractor's responsibility to transport the material to the work site when needed for installation. It shall also be the Contractor's responsibility to inspect the materials to be installed by him immediately upon delivery and advise the facility operator through its authorized representative, of all damaged materials. The Contractor at no additional expense to the City or the facility operator shall replace any material that is damaged or lost after the Contractor's inspection.

3. Method Of Measurement:

The Contractor shall be paid for each six (6) inch round box and/or nine (9) inch square box adjusted to grade regardless of adjustment height requirements.

4. Price To Cover:

The unit price bid for this item shall include all additional labor, supervision, insurance, equipment and material (except those to be provided by the facility operator), required to adjust each box to grade as required in the contract plans and specifications. The bid price shall also include the removal of existing frames and covers from existing facilities to be salvaged and returned to the facility operator and, all material transportation from the Contractor's material storage yard to the work site. In addition the bid price shall include "chipping" around existing box using appropriate means and methods where grinding is required.

SECTION 6.05 - Adjust Hardware To Grade By Resetting. (Road Reconstruction.)

1. Description:

Under this item, the Contractor shall provide all labor, supervision, materials, equipment, insurance and incidentals required to adjust to the proposed grade gas street surface hardware located within the contract area boundaries shown on the plans. The gas company operating in the area, (facility operator), owns these facilities. The work shall consist of either building up or lowering or resetting the casting by removing the existing frame and cover building up or decreasing the existing installation, replacing the frame and/or cover if damaged or worn out, as determined by the Resident Engineer, with a new frame and/or cover furnished by the owner, and setting the frame and cover to new elevation. The work shall be performed in accordance with the contract plans, specifications and at the directions of the Resident Engineer.

2. Materials:

The facility operator shall furnish and deliver all new hardware parts required. The Contractor shall furnish materials such as mortar, bricks and concrete in compliance with contract requirements. At locations where high-early strength concrete is required under this contract to be placed adjacent to gas facilities, then the requirement for concrete shall be high-early strength complying with the current New York State Department of Transportation, Standard Specifications for Class F concrete. Existing castings may be replaced as required and deemed necessary by the Engineer and by City rules and regulations. The Contractor shall install the new castings of various sizes furnished by the facility operator. The Contractor shall notify the facility operator of the installation schedule at least three (3) business days before materials are required on the site and, shall provide off-loading services to the facility operator. Should the facility operator fail to deliver the necessary material according to any schedule mutually agreed upon by the Contractor and facility operator, the City shall not be responsible for any delays attributable thereto, nor for the failure of delivery of such materials. Such delays shall be a matter of adjustment between the Contractor and the facility operator. On project where material storage is not permitted on site, the facility operator shall deliver the required material to the Contractor's yard and it shall be the Contractor's responsibility to transport the material to the work site when needed for installation. It shall also be the Contractor's responsibility to inspect the materials to be installed by him, immediately upon delivery and advise the facility operator through its authorized representative, of all damaged materials. The Contractor at no additional expense to the City or the facility operator shall replace any material that is damaged or lost after the Contractor's inspection.

3. Methods Of Construction:

The Contractor shall remove and reinstall existing castings or install new castings to the proposed grade. Setting and resetting the castings shall be done with mortar and brick according to the standards of the facility operator. Work shall be performed in a workmanlike manner. Castings that are deemed unacceptable for resetting shall remain the property of the facility operator and he shall be responsible for their removal and proper disposal from site. No traffic shall be allowed on adjusted street hardware until permitted by the Engineer.

4. Method Of Measurement:

The Contractor shall be paid for each gas hardware adjusted to grade regardless of size or adjustment height requirements (up or down).

5. Price To Cover:

The unit price bid for this item shall include all additional labor, supervision, insurance, equipment and material (except those to be provided by the facility operator), required to adjust each gas hardware to grade as required in the contract plans and specifications. The bid price shall also include the removal of existing frames and covers from existing facilities; building up the existing installations with bricks and mortar, or lowering the existing installation by removing bricks and mortar; replacing damaged frames and/or covers with new frames and/or covers furnished by the facility operator; setting the frames and covers to the new elevations; protect existing installations; repair minor structural damages to existing installations prior to resetting frames; unloading of furnished castings at the Contractor's yard and transporting castings from the Contractor's yard to the job site as required; completing the work in

accordance with the contract plans, specifications and, at the directions of the Engineer. In addition the bid price shall include "chipping" around existing gas facilities using appropriate means and methods where grinding is required.

SECTION 6.06 - Special Care Excavation And Backfilling.

1. Description:

Under this section, the Contractor shall provide all labor, materials, equipment, insurance and incidentals required to support and protect the integrity of live gas facilities including mains, services, related structures and appurtenances during excavations. The gas company operating in the area, (facility operator), owns these facilities. The work shall be performed in accordance with the contract plans, specifications and at the directions of the Resident Engineer in consultation with authorized representatives of the facility operator.

2. Applicability Of Section:

This section shall apply to live gas facilities of various sizes located within two (2) feet of any face of unsheeted excavation, (unsheeted excavation refers to any excavation performed for city work and includes excavations performed that are to be subsequently sheeted using approved methods) and paralleling or, encroaching any face of excavation. Also, for crossings greater than forty-five (45) degrees and/or located at a cover depth greater than five (5) feet from existing street surface. Parallel facilities are not exposed at any time during excavation (See "Gas Cost Sharing Work Standard Sketch No. 5"). Encroaching facilities are partially exposed inside the limit of excavation (See "Gas Cost Sharing Work Standard Sketch No. 5"). This section shall also apply to gas facilities crossing catch basins excavation, and catch basins sewer connections (chutes) trench excavation only when extra depth (covered in other section), is not required for chutes installations because of such utilities interferences (See "Gas Cost Sharing Work Standard Sketch No. 3"). This section shall also apply to gas services (if shown or otherwise listed in contract documents) crossing unsheeted excavations for water mains, gas facilities crossing fire hydrant branch connections, house sewer and/or water service connections excavations. This section shall also apply for so called "loss trench", as described further, and for additional excavation (pavement and/or soil), backfilling, compaction, roadway base and pavement restoration due to abandoned gas facilities, only if removed by Contractor. If operating status of gas facilities cannot be determined prior to excavation then such facilities shall be considered live and this section shall fully apply. The excavation around fully exposed live gas facilities along and within limits of excavation (not crossings) shall be covered by this section also (not shown on "Gas Cost Sharing Work Standard Sketch No. 5"), however the support requirement, if any is required, of such facilities is beyond the scope of these specifications and therefore shall be the responsibility of facility operator to determine and prescribe, at no cost to the City contract, but shall be a matter of adjustment between the Contractor and facility operator.

3. Payment Restriction:

No special care excavation shall be paid for abandoned gas facilities paralleling and/or encroaching excavation and therefore are not in direct interference with City work. Except as allowed in this section, the bid item specified under this section shall not be used in combination with items covered under other sections for work done due to a particular gas facility. This item shall not be paid for new gas facilities when trenching for such new facilities has been performed by the Contractor of record in common with trench excavation for City Work (overlapping trench limits). The cost of excavating with care as defined in this section shall be deemed included in the cost of trench excavation for the new gas facilities. This restriction shall apply even if such gas common trench excavation is not part of the contract. If facilities are in direct interference with City work, meaning that "Minimum Clearances" described in "General Provisions; Gas Cost Sharing Work Paragraph No. 8" cannot be maintained and excavation has to be temporarily or permanently abandoned then this particular location shall become a test pit and dealt with as specified in Section 6.07 and "General Provisions; Gas Cost Sharing Work Paragraphs Nos. 2 and 8".

4. Method Of Construction:

All excavation in the vicinity of gas facilities shall be as required by NYS Industrial Code 753. Where these facilities are paralleling and located two (2) feet or less from the limits of the proposed excavation, the Contractor shall use hand excavation methods (pick and shovel or hand held power tools) to ascertain

the clearances of these facilities with respect to the proposed excavation. Once the location of these facilities with respect to the proposed excavation is verified to the satisfaction of the Resident Engineer, the Contractor shall then proceed with a combination of hand and machine excavation as required preserving the integrity of the facilities. The installation of timber supports or underpinning, when soil foundation cannot fully support partially exposed pipes, may be required to prevent pipe movement as directed by the Resident Engineer.

5. Method Of Payment:

The unit price for this work item shall be based on cubic yard (CY) of average excavation with care and, is to be considered as an incremental cost for performing City work with gas facilities interferences.

6. Method Of Measurement:

- A. For Paralleling Facilities: Volume calculated as: Depth as measured from existing street surface to the bottom of unsheeted trench excavation allowable by OSHA regulations, multiplied by, the width measured as one (1) foot from the face of excavation toward the center of excavation, multiplied by the length of parallel facility, divided by twenty-seven (27) cubic feet per cubic yard (See "Gas Cost Sharing Work Standard Sketch No. 5"). The gas facility is no longer considered to be in interference once sheeting has been installed, therefore no further compensation for paralleling facilities as described above will be made.
- B. For Encroaching Facilities: Volume calculated as: Depth of trench as allowable by OSHA, maximum up to five (5) feet multiplied by, the width of partially exposed pipe plus one (1) foot, multiplied by the length of facility encroachment, divided by twenty-seven (27) cubic feet per cubic yard (See "Gas Cost Sharing Work Standard Sketch No. 5").
- C. Fully Exposed Gas Facilities: (Not shown on "Gas Cost Sharing Work Standard Sketch No. 5") along and inside trench and/or crossing trench at an angle greater than forty-five (45) degrees and/or a cover depth greater than five (5) feet from the existing street surface. The volume shall be measured as the depth of trench excavation multiplied by the distance measured along the sheeting line between two (2) points of intersections of the gas facilities and the sides of trench excavation, multiplied by the width of trench excavation.
- D. For Additional Excavation And Restoration Due To So Called "Loss Trench", When The Integrity Of Pavement And Soil Above And Around Existing Live Gas Facilities Cannot Be Maintained Due To Its Lack Of Cohesiveness: Volume shall be calculated as: Depth of unsheeted trench excavation multiplied by width measured as distance of facility from closest edge of unsheeted excavation plus, width of facility proper plus, one (1) foot or a maximum width of three (3) feet multiplied by length of facility fully exposed divided by, twenty-seven (27) cubic feet per cubic yard (not shown on "Gas Cost Sharing Work Standard Sketch No. 5").
- E. For Facilities Crossing Excavation For Catch Basins, Or Chutes Installations (When NYCDEP Funded) Or Fire Hydrant Branch Connections, Or Unsheeted Water Main Trench, Or House Sewer And/Or Water Services: Volume calculated as: Depth as measured from existing street surface to the bottom of the trench excavation multiplied by, the width taken as the outside diameter of pipe or the width of structure plus one (1) foot on either side (two (2) feet), multiplied by, the length of exposed facility crossing the trench, divided by twenty-seven (27) cubic feet per cubic yard (not shown on "Gas Cost Sharing Work Standard Sketch No. 5").

Overlapping volume dimensions measured as described above may occur when multiple facilities are paralleling excavations, encroaching excavations or crossing catch basins and catch basin chute installations. In such cases, all such facilities shall be counted as one limited by the extreme pipes, faces (See "Gas Cost Sharing Work Standard Sketch No. 2"). The volume shall then be calculated as described above.

7. Price To Cover:

The bid price shall also cover all additional supervision, labor, material, equipment and insurance necessary to excavate while protecting and maintaining (excluding supports for fully exposed live gas) gas facilities without disruption of service to the public and in accordance with contract specifications. The

price shall also include, changes of sheeting method and excavation width configuration where necessary to accommodate gas facilities in their existing locations; difficulties during the installation of catch basins, chute connections, hydrant branch, and house sewer and water connections under or over gas facilities; loss of productivity due to slower rate of excavation (special care) during excavation, including the use of such methods as: hand excavation around existing single and multiple facilities, extra excavation and backfilling due to lost trench because of existing and adjacent gas facilities, compaction, removal of sheeting from the facilities, extra roadway base restoration and temporary pavement, associated maintenance and protection of traffic, barricades, and traffic plates that may be required to temporarily close and/or complete the work.

SECTION 6.07 - Test Pits For Gas Facilities.

1. Description:

Under this section, the Contractor shall furnish all labor, materials, insurance, equipment and appliances necessary to excavate, sheet and, maintain test pits at locations approved by the Resident Engineer in consultation with the facility operator. Test pits shall be dug in order to ascertain exact locations, cover and invert elevations, clearances, alignment and operating status (live or dead) of existing gas facilities. The Contractor shall inspect jointly with the Resident Engineer and facility operator, gas facilities and other structures uncovered, take all relevant measurements and elevations as directed by the Resident Engineer. Tests to determine operating status of gas facilities shall be performed by facility operator. The pits shall be covered with steel plates during daytime nonworking hours, and uncovered, as required, until the inspection work is completed. Testing of gas facilities may require a maximum of four (4) hours. Then, the pits shall be backfilled with clean fill, and resurfaced with temporary pavement. All traffic shall be maintained and all safety measures as stipulated shall be complied with.

2. Methods Of Construction:

A. Excavation: Existing pavement to be removed shall be neatly cut along lines of removal with a saw or other approved equipment which leaves a neat straight joint line along the juncture with subsequently replaced pavement. Excavation in the vicinity of utilities and other structures shall be performed using hand tools. Use of hand operated pneumatic and electric jackhammers will be permitted only for breaking pavement and removal of masonry, concrete and boulders, or as otherwise directed by the Resident Engineer. The Contractor shall properly dispose of all materials excavated from test pits away from site. Test pits shall be excavated at locations shown on the contract drawings or as directed by the Resident Engineer. Additional test pits may be required and shall be excavated where required, as ordered by the Resident Engineer. All test pits shall be excavated to a depth and size necessary to locate the existing facilities. Sheeting shall be used when depth of excavation exceeds five (5) feet. The sheeting required shall be furnished and installed in full compliance with the State of New York and Federal Safety Codes requirements and as specified in contract, whichever is more stringent. Care shall be taken that no existing gas facilities or other structures are broken or damaged. All broken or damaged facilities shall be reported immediately to facility operator who shall decide whether such facilities shall be repaired or replaced by company forces or by City contractor and in conformance with "General Provisions; Gas Cost Sharing Work Paragraph No. 9". Contractor shall excavate all material encountered, including large masses of concrete, cemented masonry and boulders, as directed by the Resident Engineer. Any type of excavation protection used, shall satisfy the following:

- (a) Industrial Code Rule 753.
- (b) Prevent injury to workers and the public, and avoid damage to existing water, sewer, and gas pipes or other structures, and to pavements and their foundations, through caving or sliding of the banks of the excavation.

Should it become necessary, as determined by the Resident Engineer, to enlarge any test pit in any dimension after sheeting has been placed, the Contractor shall remove portions of the sheeting, as necessary, enlarge the test pits as directed, and replace the sheeting without additional compensation for this work other than for the additional volume of material excavated.

B. Maintenance Of Test Pits: Excavated test pits shall be maintained free of debris and kept dry by the Contractor in order to permit the inspection and measurements and to determine the locations of

facilities. In order to accomplish this, Contractor shall, upon completion of excavation and placement of sheeting (if depth greater than five (5) feet), furnish and install adequate steel plates and posting over the excavated pits and shall temporarily remove all equipment debris and workers, and relocate barricades in order to open the full width of street to traffic during nonworking hours. The Contractor shall then, at no additional cost, relocate such barricades, barrels, cones and other warning devices and remove steel plates, as and when directed by the Resident Engineer to facilitate the inspection of exposed facilities. When work is being performed and the pits are not covered with steel plates, the Contractor shall provide complete and safe access to the test pits as may be required, and he shall provide construction barricades and maintain traffic at all times as shown or as directed by the Resident Engineer. Upon completion of test pit inspection by the Resident Engineer, the pit shall be backfilled by the Contractor as specified in contract, except that backfill material shall conform to contract specifications for such purpose.

- C. Pavement And Sidewalk Restoration: After backfilling is completed, the Contractor shall construct a temporary pavement consisting of a minimum of four (4) inches thick asphaltic concrete mixture in roadway areas or a two (2) inches thick asphaltic concrete mixture in sidewalk areas in order to maintain existing pedestrian and vehicular traffic. This temporary pavement shall be maintained until permanent pavement and sidewalk replacement is constructed as specified in contract.

3. Measurements:

The quantity to be measured for payment shall be the number of cubic yards of material removed from within the limits of the pit dimensions as directed by the Resident Engineer. The volume occupied by existing pipes or other structures remaining within the maximum payment lines will not be deducted from the total volume measured except, where the cross sectional area of these facilities exceeds four (4) square feet. As determined by the Resident Engineer, the quantity measured for payment may be proportionate to a fair and reasonable estimate of gas responsibility in the total volume excavated.

4. Price To Cover:

The contract price bid per cubic yard for test pits shall cover all additional costs of labor, material, insurance, equipment, appliances and incidentals required to excavate test pits, including removal and disposal of excavated materials, sheeting, steel plating, backfill, compaction and temporary pavement and sidewalk restoration all in accordance with the specifications and as directed by the Resident Engineer. The price shall also include the cost of providing safe access to the excavation by facility operator for the performance of certain test to determine operating status of gas facilities prior to City work. The price shall also include support and protection of all gas facilities crossing excavation, paralleling and/or encroaching any face of excavation.

GAS COST SHARING STANDARD SPECIFICATIONS
SCHEDULE GCS-A

Average rate charged by utility companies to Disconnect and Reconnect Gas Services:

1. National Grid - \$586.90 per Service/and Visit
2. Con Edison - \$524.00 per Service/and Visit

IV - STANDARD SKETCHES; GAS COST SHARING WORK

Hereinafter attached are the following Standard Sketches for Gas Cost Sharing Work:

- Sketch No. 1 - Support Requirements For Gas Mains And Services Crossing Excavation Greater Than 4' - 0" Wide At Any Angle
- Sketch No. 1A - Support Requirements For Gas Mains Over 16" Diameter Up To And Including 48" Diameter Crossing Excavation At Any Angle
- Sketch No. 2 - Typical Methods Of Measurement For Gas Crossings
- Sketch No. 3 - Utility Crossings During Catch Basin Chute Connection Pipe Installation
- Sketch No. 4 - Utility Crossings During Catch Basin Chute Connection Pipe Installation (Extra Depth)
- Sketch No. 5 - Gas Main Encroachment On And/Or Parallel To Excavation Of Unsheeted Trench

GAS COST SHARING WORK (SKETCH NO. 1)

SUPPORT REQUIREMENTS FOR GAS MAINS AND SERVICES CROSSING EXCAVATION GREATER THAN 4'-0" WIDE AT ANY ANGLE

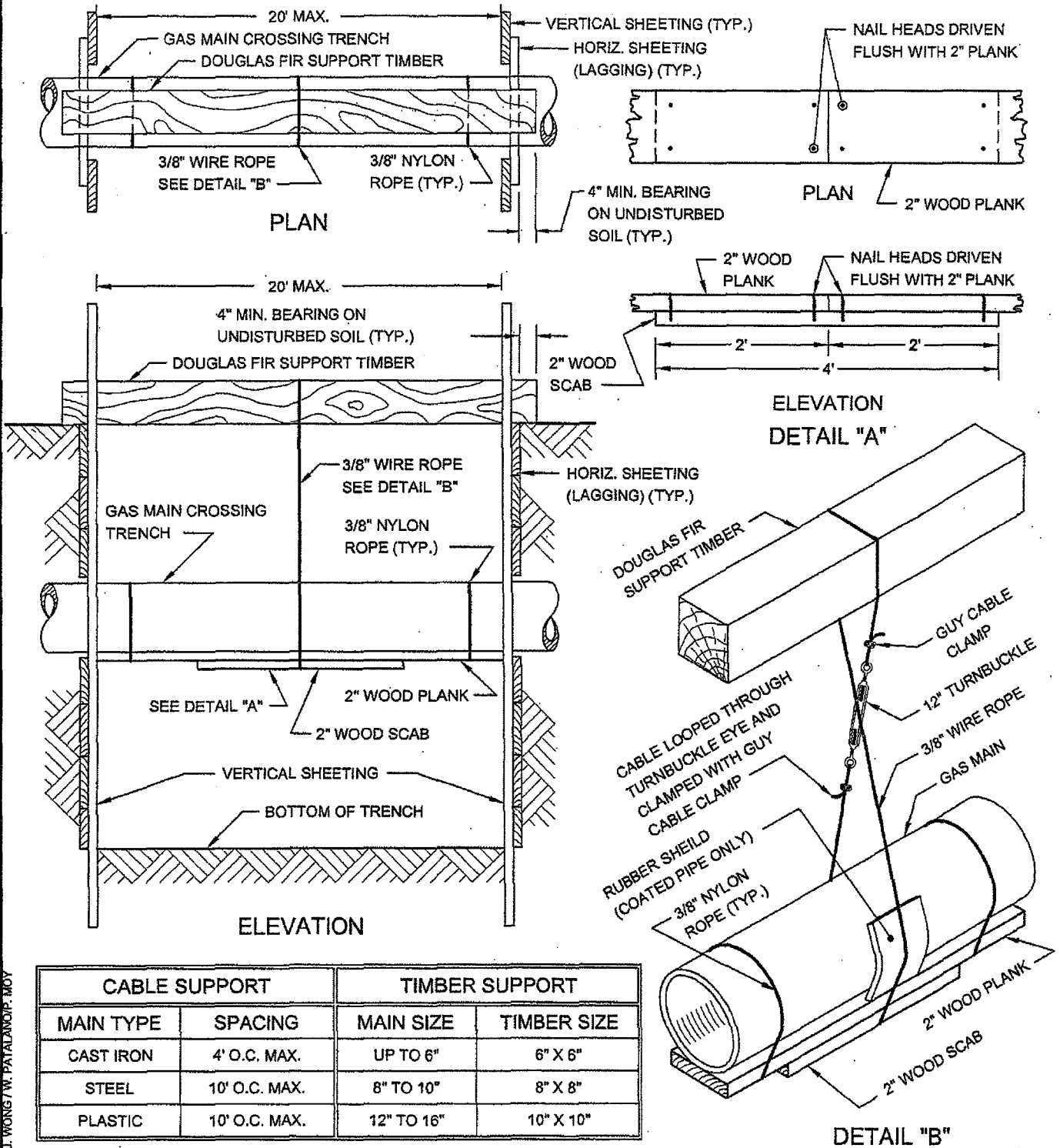

CABLE SUPPORT		TIMBER SUPPORT	
MAIN TYPE	SPACING	MAIN SIZE	TIMBER SIZE
CAST IRON	4' O.C. MAX.	UP TO 6"	6" X 6"
STEEL	10' O.C. MAX.	8" TO 10"	8" X 8"
PLASTIC	10' O.C. MAX.	12" TO 16"	10" X 10"

REVISED OCT. 2004 - L. ADRIEN
REVISED JUNE 1988 - L. WONG / W. PATAJANOP. MOY

GAS COST SHARING WORK (SKETCH NO. 1A)

SUPPORT REQUIREMENTS FOR GAS MAINS OVER 16" DIAMETER UP TO AND INCLUDING 48" DIAMETER CROSSING EXCAVATION AT ANY ANGLE

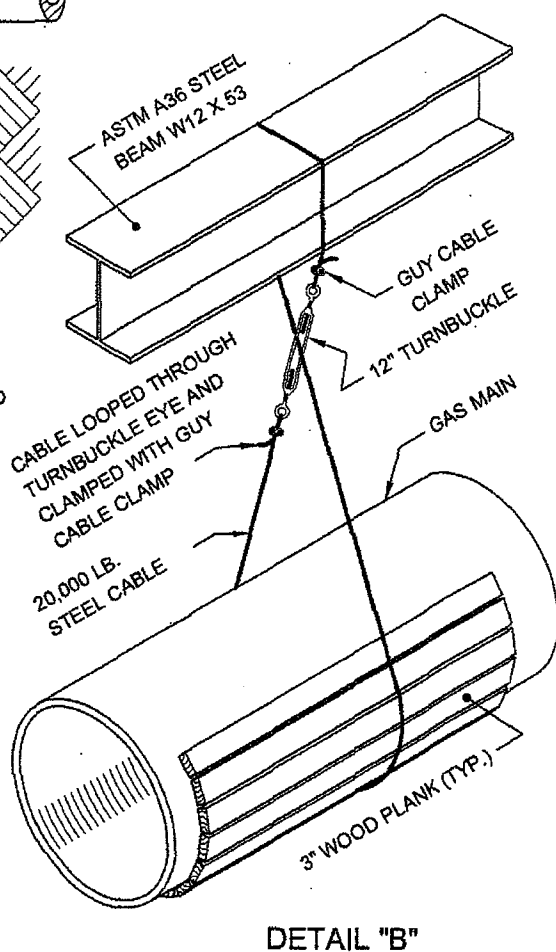
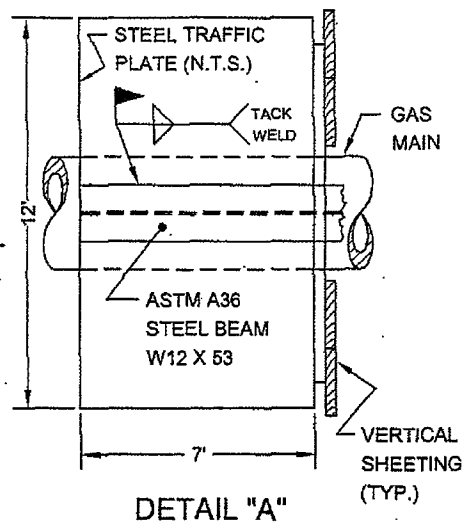
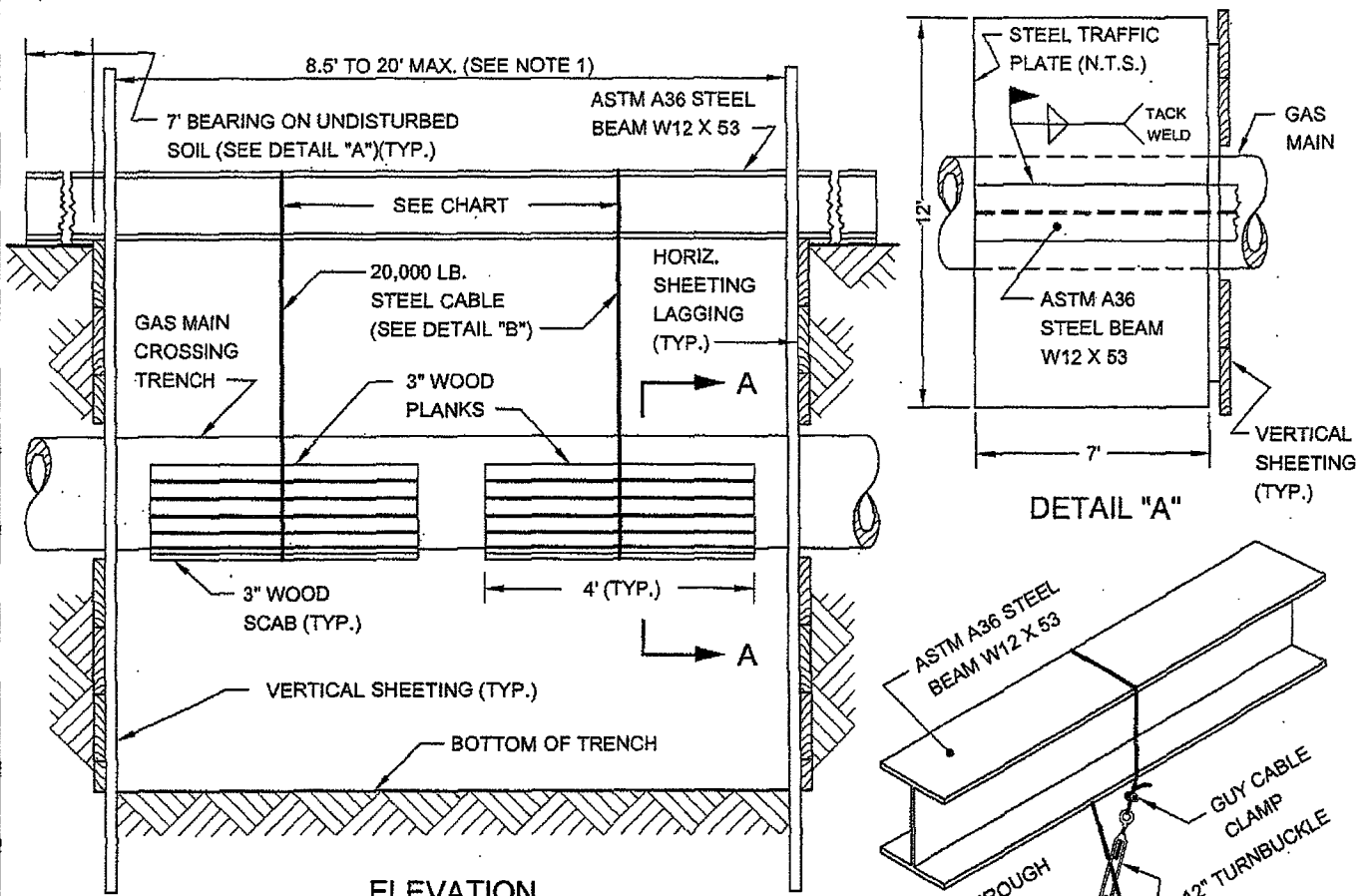

ELEVATION

CABLE SUPPORT	
MAIN TYPE	SPACING
CAST IRON	4' O.C. MAX.
STEEL	10' O.C. MAX.

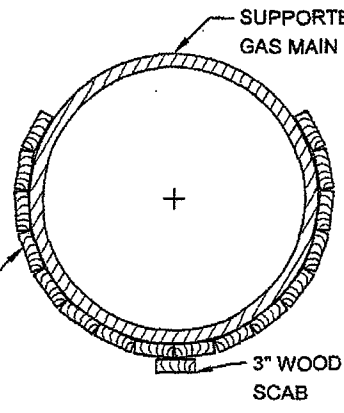

SECTION A-A

NOTES:

- (1) NO SUPPORT IS REQUIRED FOR GAS MAINS OVER 16" DIA. UP TO AND INCLUDING 48" DIA. CROSSING TRENCHES LESS THAN 8.5' WIDE.
- (2) UNDERMINE A MAXIMUM OF 8.5 L.F. OF CAST IRON GAS MAIN AT A TIME.
- (3) SET STEEL CABLE OVER 3" WOOD PROTECTIVE PLANKS AND PLACE AN ADDITIONAL 3" SCAB ON THE BOTTOM OF THE GAS MAIN.
- (4) ADJUST STEEL CABLE UNTIL DEAD WEIGHT OF THE UNDERMINED GAS MAIN HAS BEEN TAKEN UP BY THE OVERHEAD STEEL BEAM SUPPORT.
- (5) ALL SUPPORTS AND STEEL CABLES CAN BE REMOVED ONLY AFTER THE REQUIRED BACKFILL (AROUND AND BELOW GAS MAIN) HAS BEEN COMPACTED IN ACCORDANCE WITH NEW YORK CITY STANDARDS AND AT THE DIRECTIONS OF THE ENGINEER.

REVISION 2004 - J. ADRIEN
 REVISED JUNE 1998 - J. WONG / W. PATALANO/ P. MOY

GAS COST SHARING WORK (SKETCH NO. 2)

TYPICAL METHODS OF MEASUREMENT FOR GAS CROSSINGS

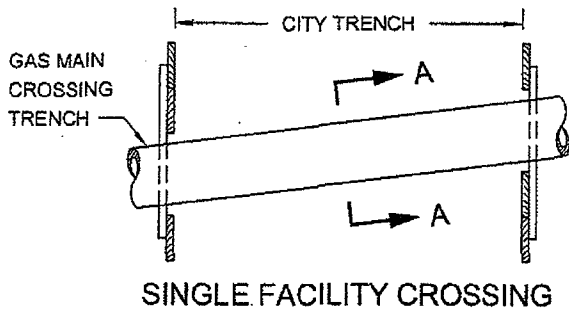

SINGLE FACILITY CROSSING

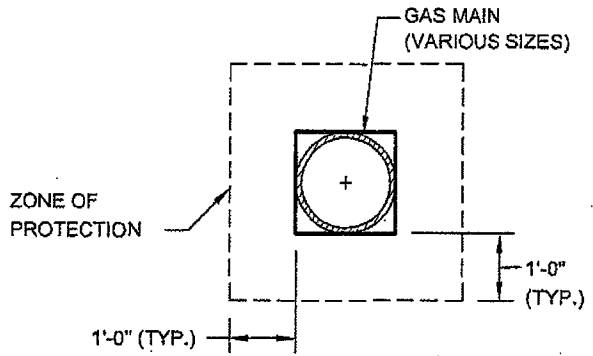

SECTION A-A

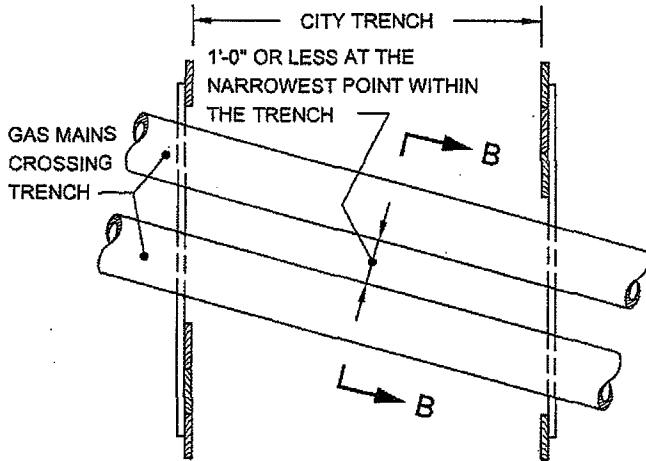

**MULTIPLE FACILITIES
(GAS MAINS AT SAME ELEVATION)**

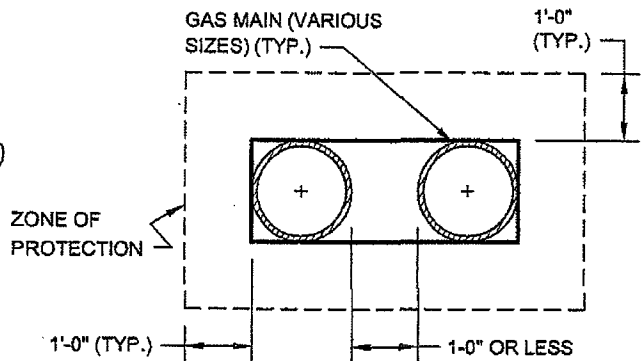

SECTION B-B

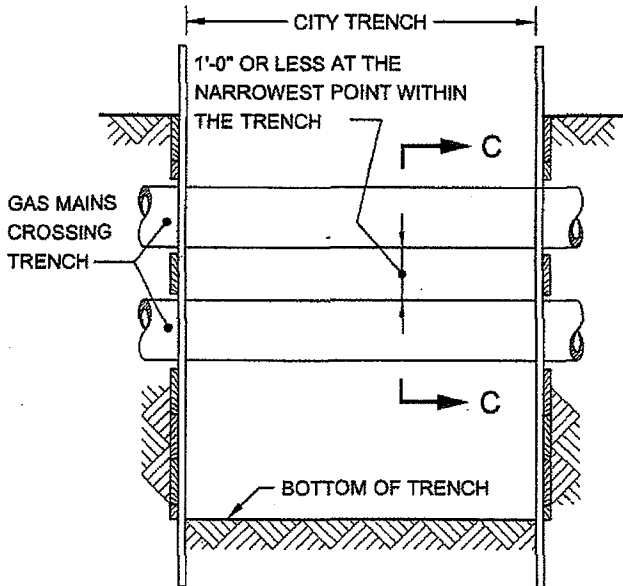

**MULTIPLE FACILITIES
(ONE CROSSING AT DIFFERENT ELEVATIONS)**

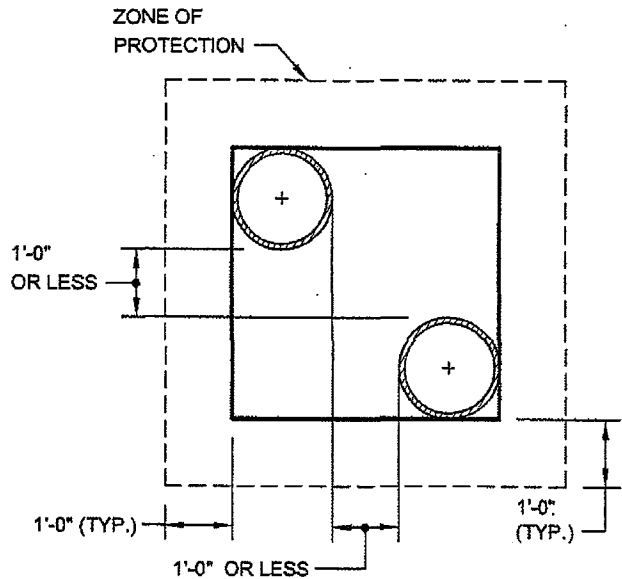

SECTION C-C

NOTE:

GAS MAINS MAY OR MAY NOT BE PARALLEL TO EACH OTHER.

REVISED SEPT. 2004 - L. ADRIEN
REVISED SEPT. 2004 - J. WONG/W. PATALANO/P. MOY

GAS COST SHARING WORK (SKETCH NO. 3)
UTILITY CROSSINGS DURING CATCH BASIN CHUTE
CONNECTION PIPE INSTALLATION

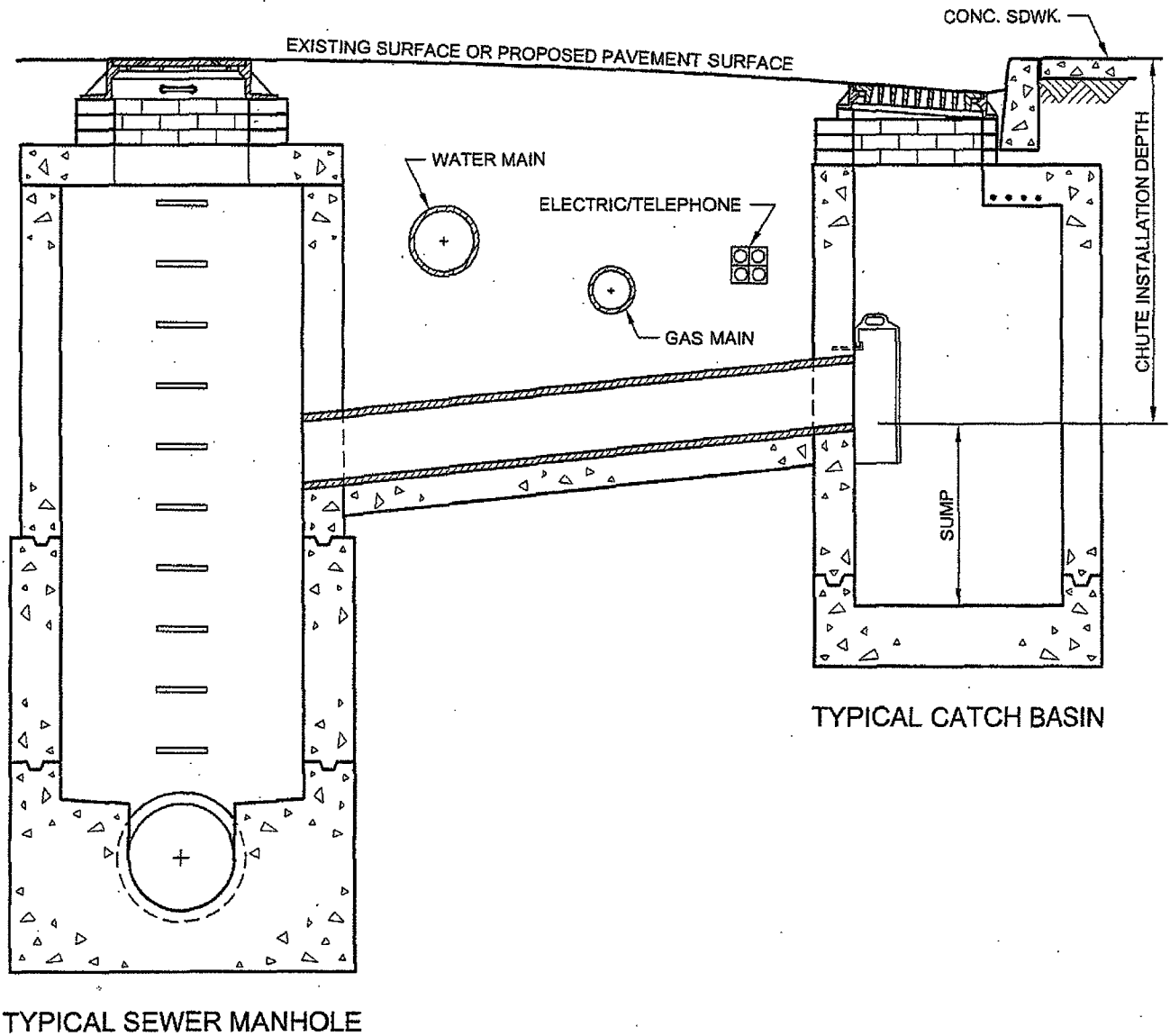

REVISED OCT. 1998 - J. WONG/W. PATALANOP, MOY
OCT. 2004 - L. ADRIEN

GAS COST SHARING WORK (SKETCH NO. 4)
UTILITY CROSSINGS DURING CATCH BASIN CHUTE
CONNECTION PIPE INSTALLATION (EXTRA DEPTH)

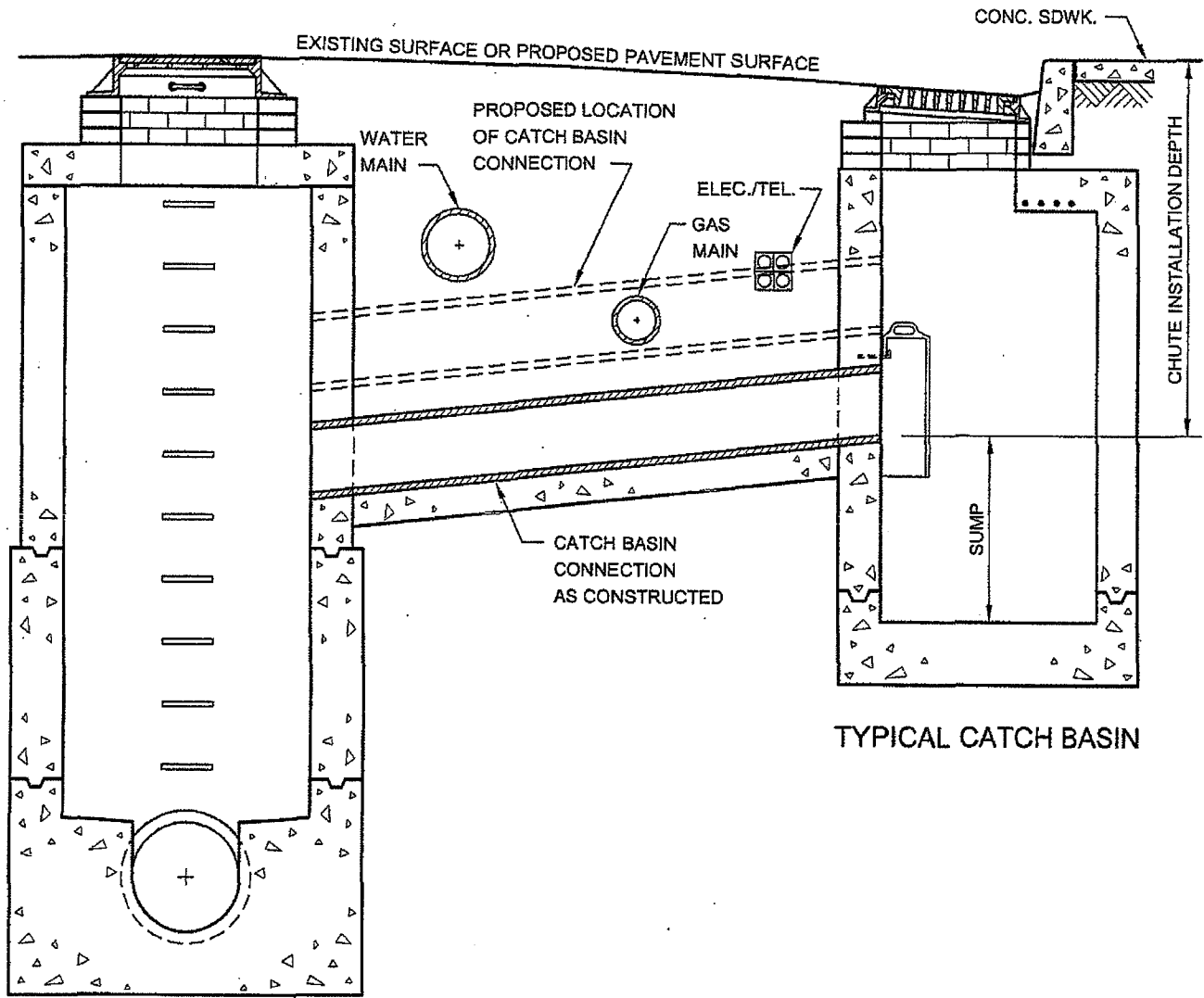

TYPICAL SEWER MANHOLE

TYPICAL CATCH BASIN

REVISED OCT. 2004 - L. ADRIEN
 REVISED OCT. 1998 - J. WONG/W. PATALANO/P. MOY

GAS COST SHARING WORK (SKETCH NO. 5)
GAS MAIN ENCROACHMENT ON AND/OR PARALLEL
TO EXCAVATION OF UNSHEETED TRENCH

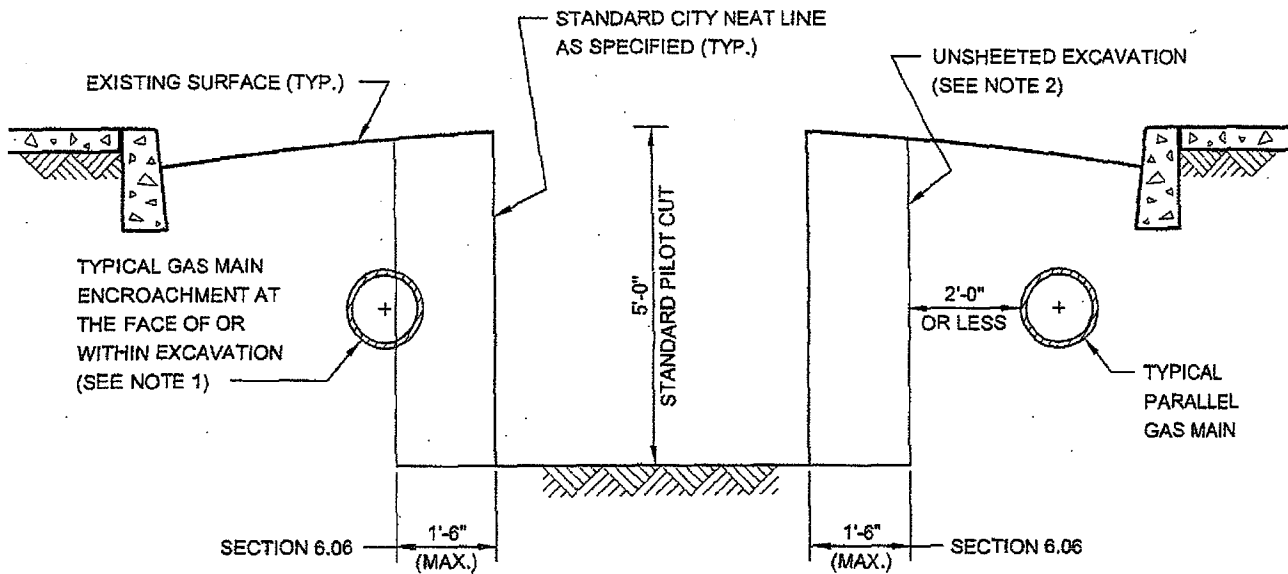

NOTES:

- (1) GAS MAIN LOCATED AS SHOWN MAY HAVE TO BE REMOVED BY THE FACILITY OPERATOR PRIOR TO THE START OF CITY EXCAVATION, OTHERWISE, THE CONTRACTOR WILL BE PAID UNDER SECTION 6.06 FOR THE SAID WORK. IF GAS MAIN IS ABANDONED THEN SECTION 6.03 SHALL APPLY.
- (2) EIGHTEEN (18) INCHES FROM STANDARD NEAT LINE IS THE MAXIMUM ALLOWABLE WIDTH OF AREA THAT MAY BE DISTURBED OR EXCAVATED DURING INSTALLATION OF CERTAIN TYPES OF SHEETING SYSTEMS THAT MEET THE REQUIREMENTS OF THE STANDARD SPECIFICATIONS OF THE DEPARTMENT OF DESIGN AND CONSTRUCTION OF THE CITY OF NEW YORK.

REVISED OCT. 1998 - J. WONG/W. PATALANO/P. MOY
 OCT. 2004 - J. ADRIEN

**V - PRELIMINARY GAS WORK TO BE PERFORMED BY
FACILITY OPERATOR**

APPLICABLE TO ALL GAS DRAWINGS:

- ALL RELOCATION WORK SHOWN IN THIS ADDENDUM IS TO BE PERFORMED BY FACILITY OPERATOR.
- ALL SUPPORT AND PROTECTION WORK TO BE PERFORMED BY CITY CONTRACTOR
- IF ADDITIONAL INFORMATION IS NEEDED REGARDING THE FACILITY OPERATOR RELOCATION WORK, THE CONTRACTOR IS ADVISED TO CONTACT THE GAS COMPANY REPRESENTATIVE:

NATIONAL GRID
287 MASPETH AVENUE
BROOKLYN, NY 11211
TEL.: 718-963-5506

(NO TEXT IN THIS AREA, TURN PAGE)

nationalgrid

PROJECT: HWQ121B4

SHEET 1 OF 2

ITEM#	SHEET	ON STREET	SIZE	PRESSURE	MATERIAL	LENGTH	REIM / NON-REIM	ACTIVITY
1	2	LAKEVIEW LANE	6"	6WC	PE	285	REIMB.	INSTALL
2	2	LAKEVIEW LANE	6"	6WC	ST	241	REIMB.	RETIRE
3	2,4	122 AVE.	6"	6WC	PE	550	REIMB.	INSTALL
4	2	122 AVE.	6"	6WC	PE	28	REIMB.	RETIRE
5	2,4	122 AVE.	6"	6WC	ST	491	REIMB.	RETIRE
6	6	120 AVE.	6"	6WC	PE	25	REIMB.	RETIRE
7	6	LAKEVIEW BLVD. EAST	6"	6WC	ST	135	REIMB.	RETIRE
8	6	LAKEVIEW BLVD. EAST	6"	6WC	PE	140	REIMB.	INSTALL
9	7	119 DRIVE	6"	6WC	PE	35	REIMB.	RETIRE
10	7	LAKEVIEW BLVD. EAST	4"	6WC	ST	137	REIMB.	RETIRE
11	7	LAKEVIEW BLVD. EAST	6"	6WC	PE	145	REIMB.	INSTALL
12	8	119 ROAD	6"	6WC	PE	38	REIMB.	RETIRE
13	8,9,10	LAKEVIEW BLVD. EAST	6"	6WC	ST	560	REIMB.	RETIRE
14	6,9,10	LAKEVIEW BLVD. EAST	6"	6WC	PE	732	REIMB.	INSTALL
15	9	119 1VE.	6"	6WC	ST	71	REIMB.	RETIRE
16	9	119 AVE.	6"	6WC	CI	7	REIMB.	RETIRE
17	10	118 ROAD	6"	6WC	PE	23	REIMB.	RETIRE
18	10	119 ROAD	6"	6WC	ST	58	REIMB.	RETIRE

A3-22A

nationalgrid

PROJECT: HWQ121B4

SHEET 2 OF 2

ITEM#	SHEET	ON STREET	SIZE	PRESSURE	MATERIAL	LENGTH	REIM / NON-REIM	ACTIVITY
19	9,12	119 AVE.	6"	6WC	PE	584	REIMB.	INSTALL
20	9	119 AVE.	6"	6WC	ST	45	REIMB.	RETIRE
21	9	119 AVE.	6"	6WC	PE	18	REIMB.	RETIRE
22	9	119 AVE.	6"	6WC	ST	17	REIMB.	RETIRE
23	12	119 AVE.	6"	6WC	PE	411	REIMB.	RETIRE
24	12	119 AVE.	6"	6WC	CI	35	REIMB.	RETIRE
25	12	GUY BREWER BLVD.	12"	6WC	CI	280	REIMB.	RETIRE
26	12,13	119 AVE.	6"	6WC	CI	316	REIMB.	RETIRE
27	12	GUY BREWER BLVD.	12"	6WC	PE	460	REIMB.	INSTALL
28	12,13	119 AVE.	6"	6WC	PE	410	REIMB.	INSTALL
29	13,15	164 ST.	6"	6WC	PE	565	REIMB.	INSTALL
30	13	164 ST.	6"	6WC	CI	210	REIMB.	RETIRE
31	13	164 ST.	6"	6WC	PE	40	REIMB.	RETIRE
32	13,15	164 ST.	6"	6WC	CI	415	REIMB.	RETIRE
33	15	164 ST.	6"	6WC	PE	30	REIMB.	RETIRE

A3-22B

31 2011 2011.02

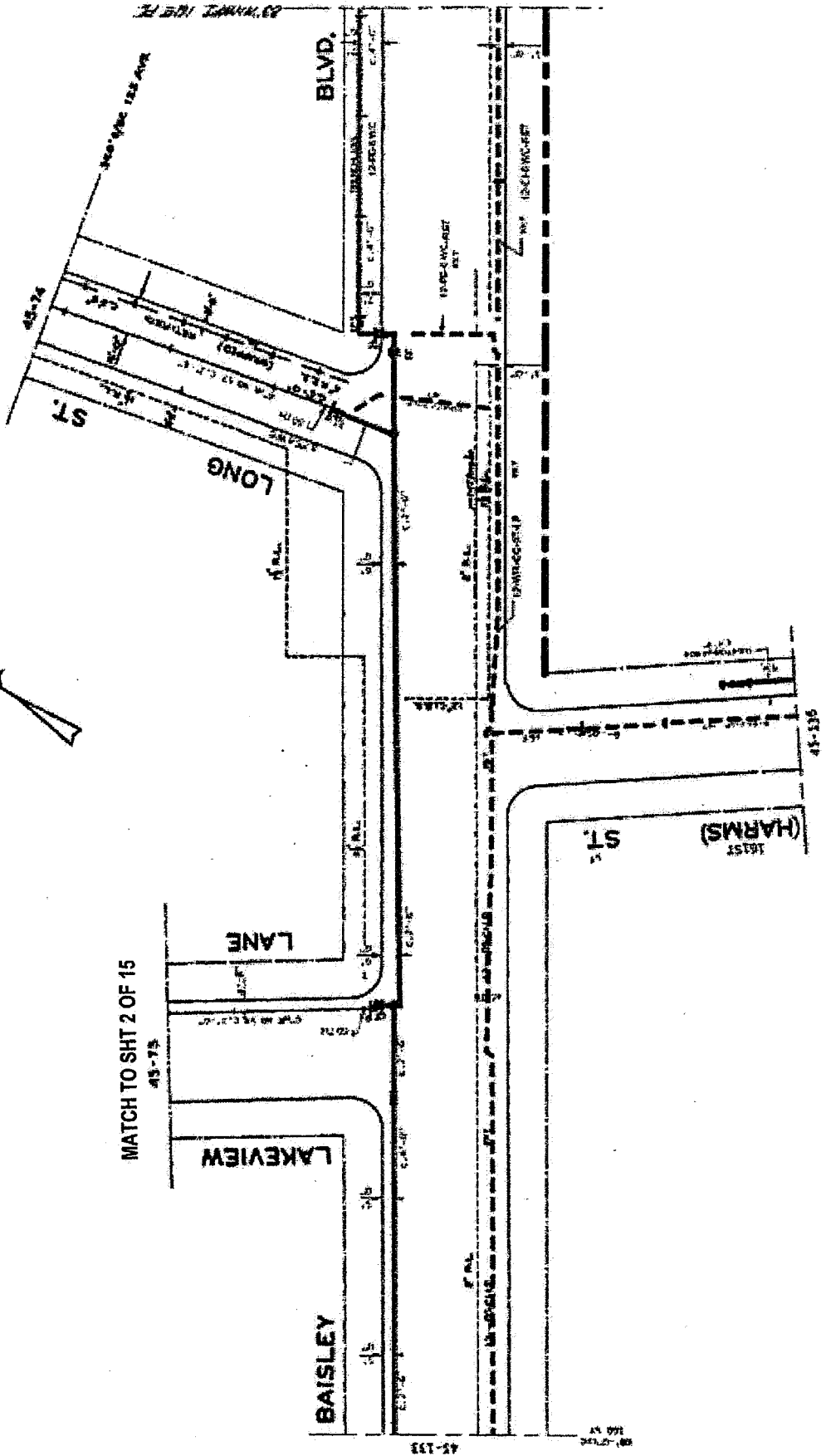
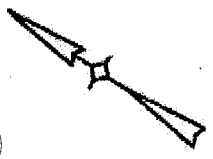

MATCH TO SHT 2 OF 15

A3-22C

nationalgrid	
HWQ121B4	
Queens	45-134 SHT 1 OF 15

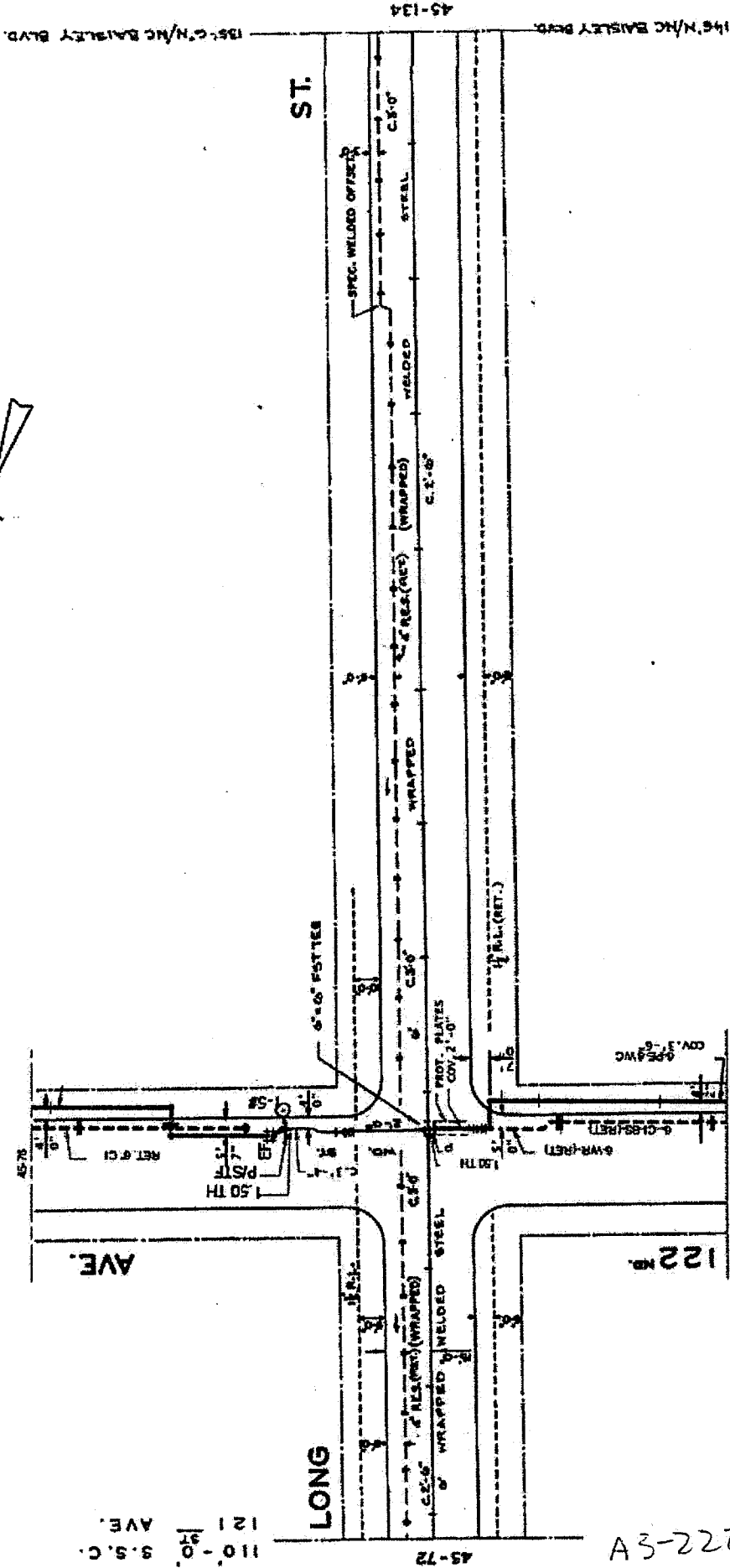
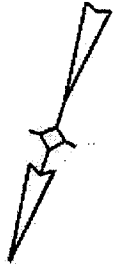

nationalgrid	
HWQ121B4	
Queens	45-74 SHT 3 OF 15

A3-22E

MATCH TO SHT 3 OF 15

110'-30" 3. S. C. AVE.
121'-30" AVE.

45-75 ST. E/SEPT LAKEVIEW LA

156' N/NC BAILEY BLVD. 45-134

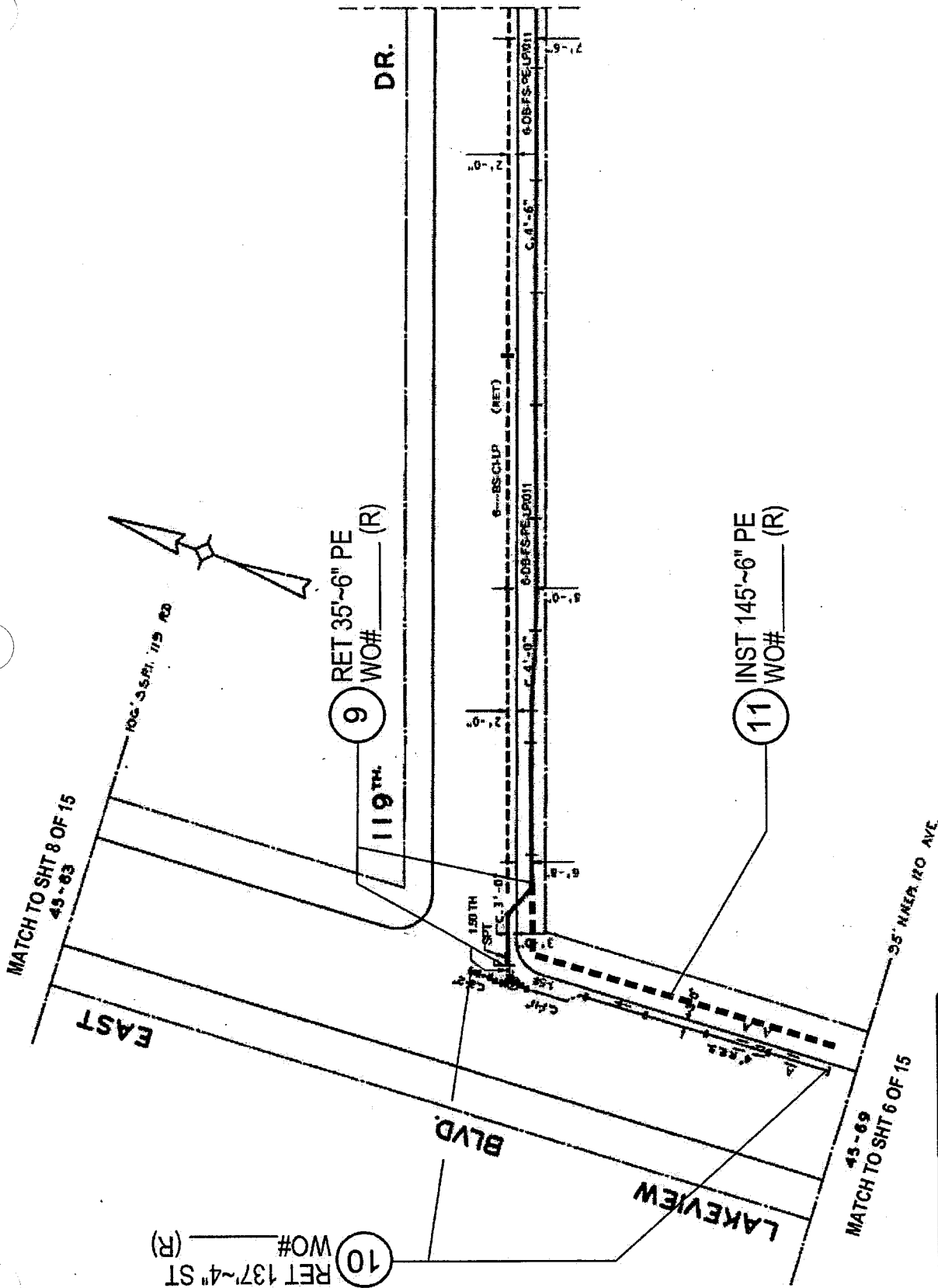

I 22-24 A

nationalgrid	
HWQ121B4	
Queens	45-65
	SHT 7 OF 15

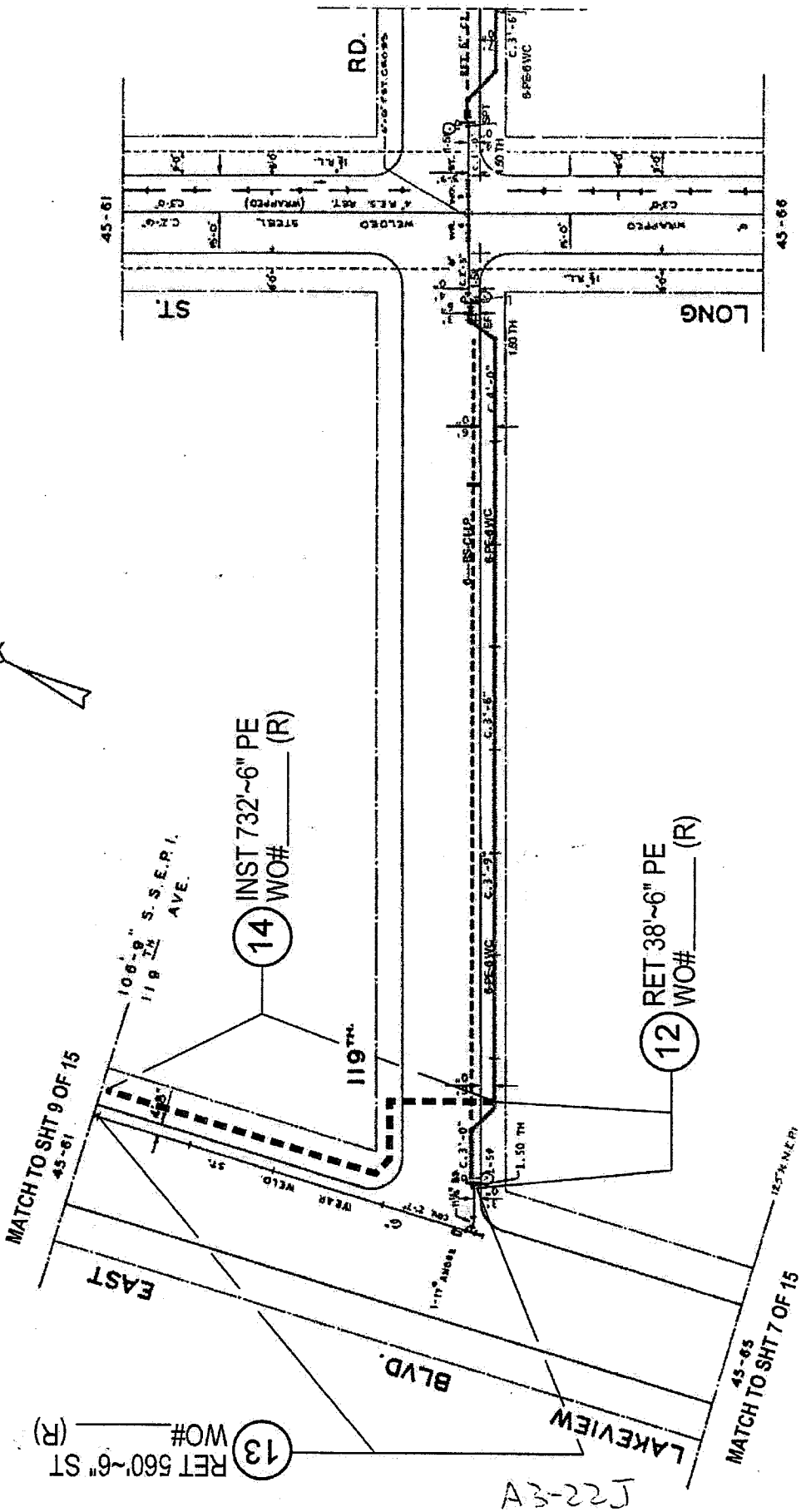
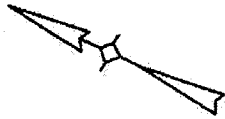

106'-8"
 118' S.S.E.R.I.
 AVE.
 119 TH.
 14 INST 732~6" PE
 WO# _____ (R)

12 RET 38~6" PE
 WO# _____ (R)

13 RET 560~6" ST
 WO# _____ (R)

A3-22J

nationalgrid	
HWQ121B4	
Queens	45-63
SHT 8 OF 15	

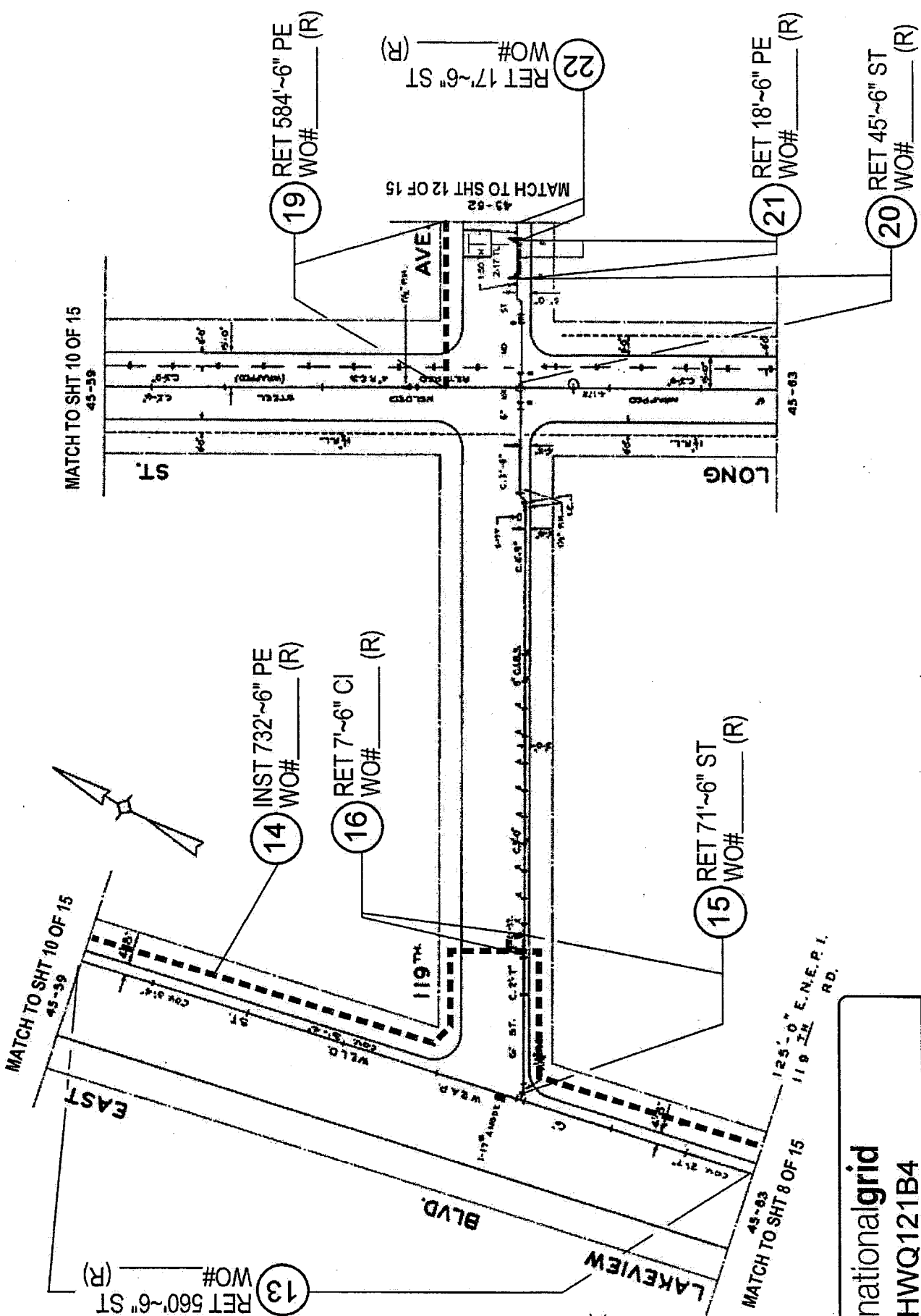

A3-22K

nationalgrid	
HWQ121B4	
Queens	45-61
SHT 9 OF 15	

MATCH TO SHT 11 OF 15
45-57

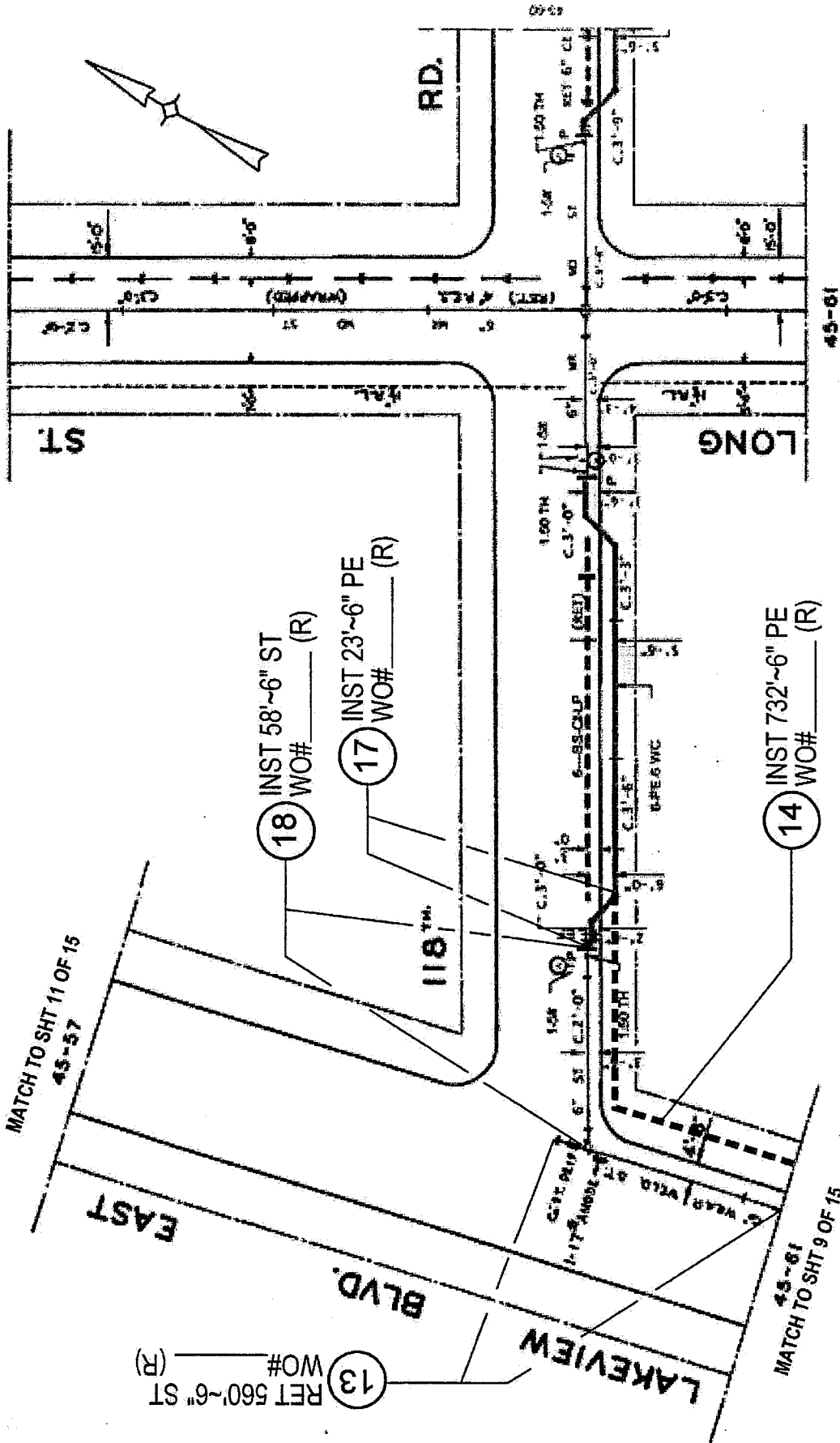

A3-22L

nationalgrid	
HWQ121B4	
Queens	45-59
SHT 10 OF 15	

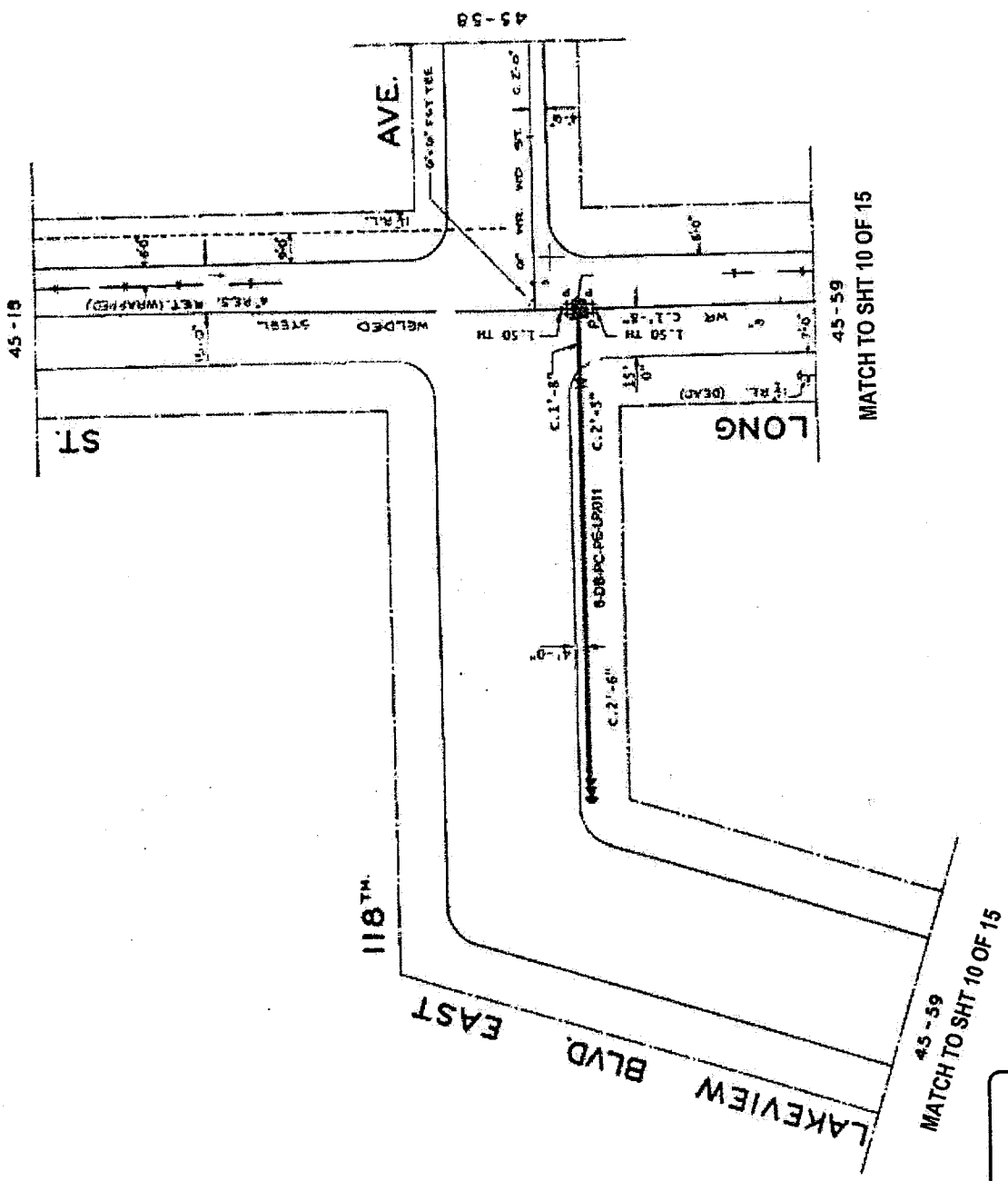

A3-22M

nationalgrid	
HWQ121B4	
Queens	45-57 SHT 11 OF 15

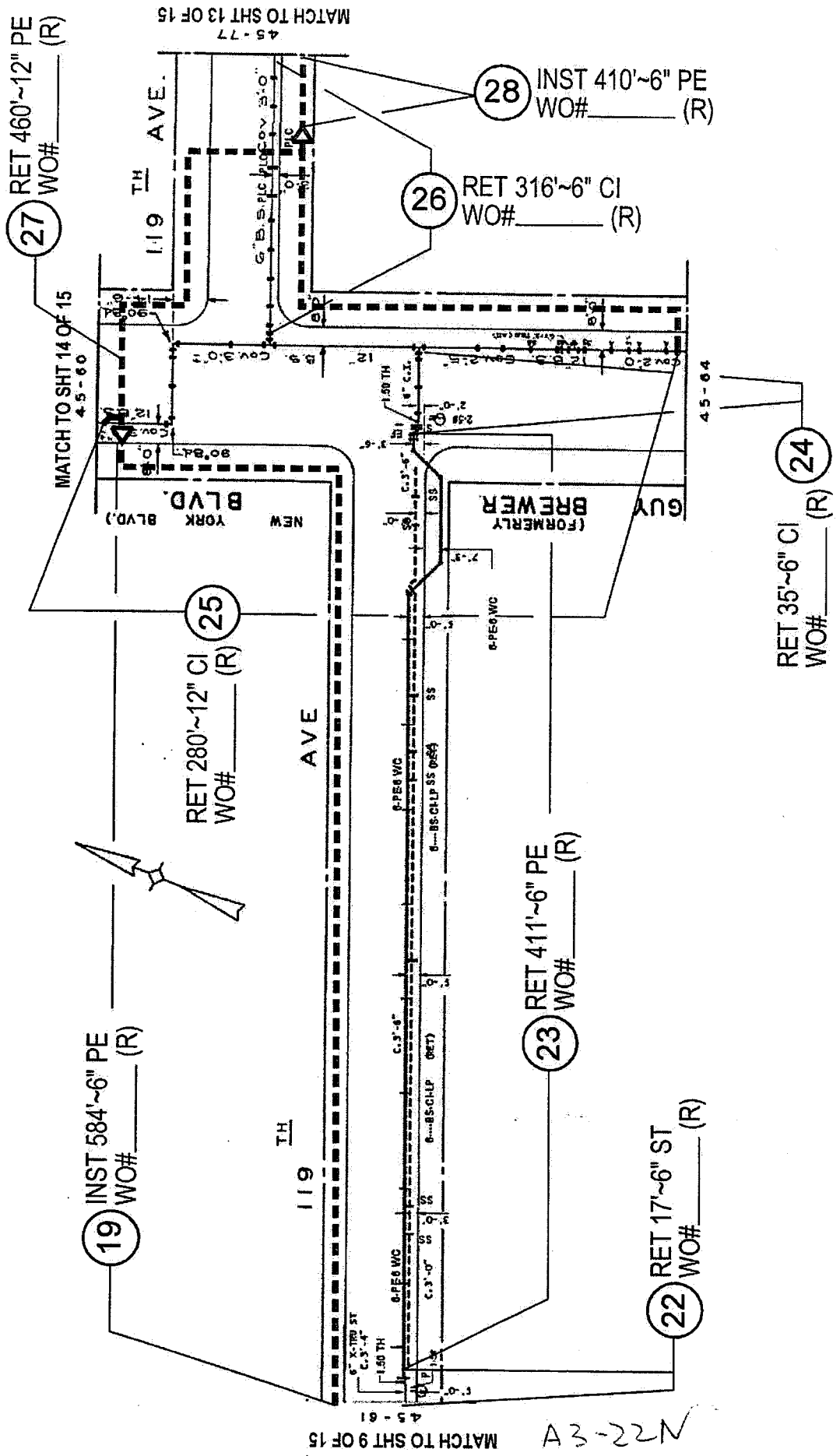

nationalgrid	
HWQ121B4	
Queens	45-62 SHT 12 OF 15

MATCH TO SHT 9 OF 15
A3-22N

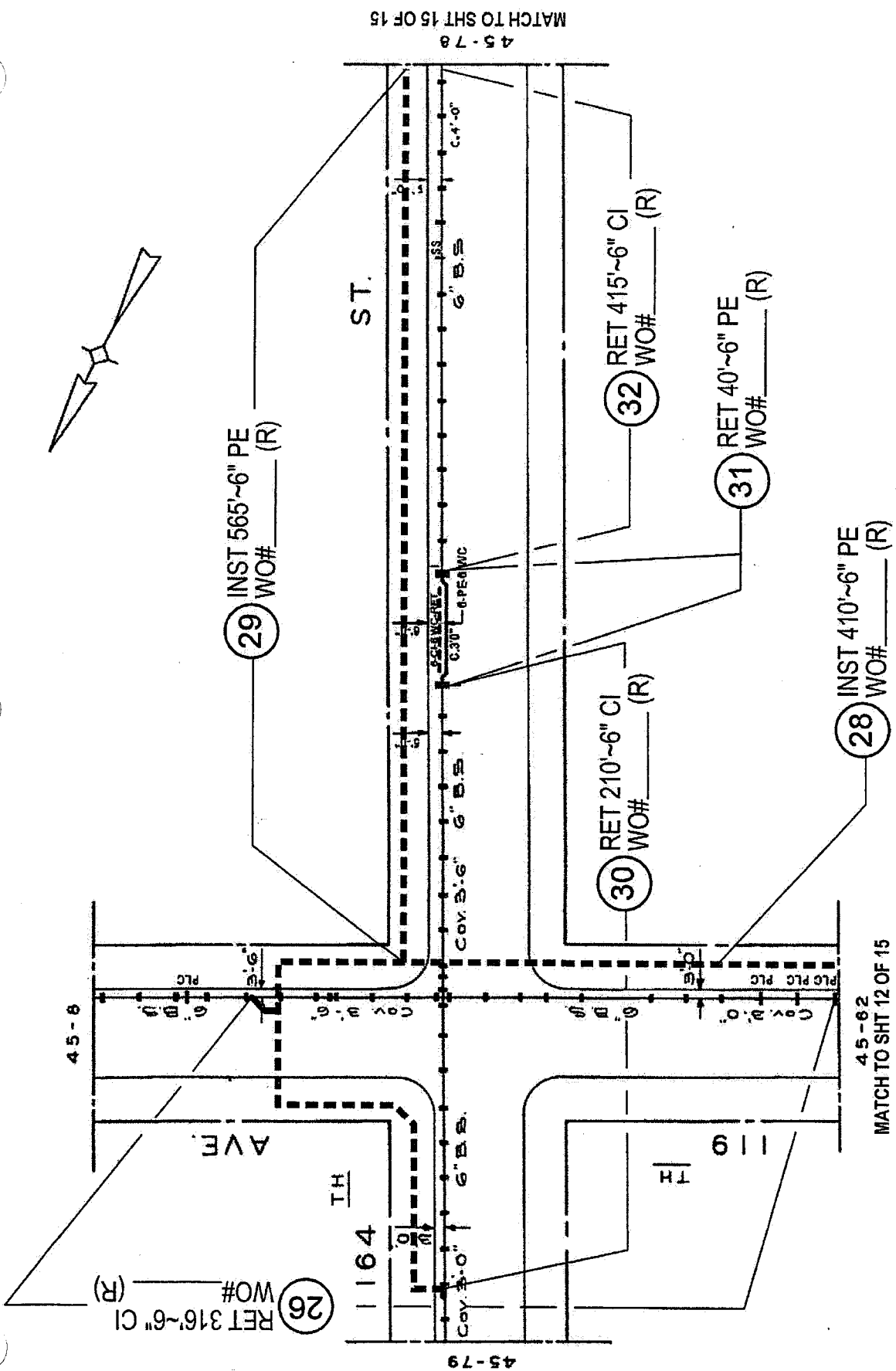

45-78
MATCH TO SHT 15 OF 15

45-82
MATCH TO SHT 12 OF 15

0 22-2 A

nationalgrid	
HWQ121B4	
Queens	45-77 SHT 13 OF 15

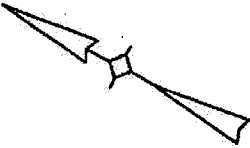

45-58

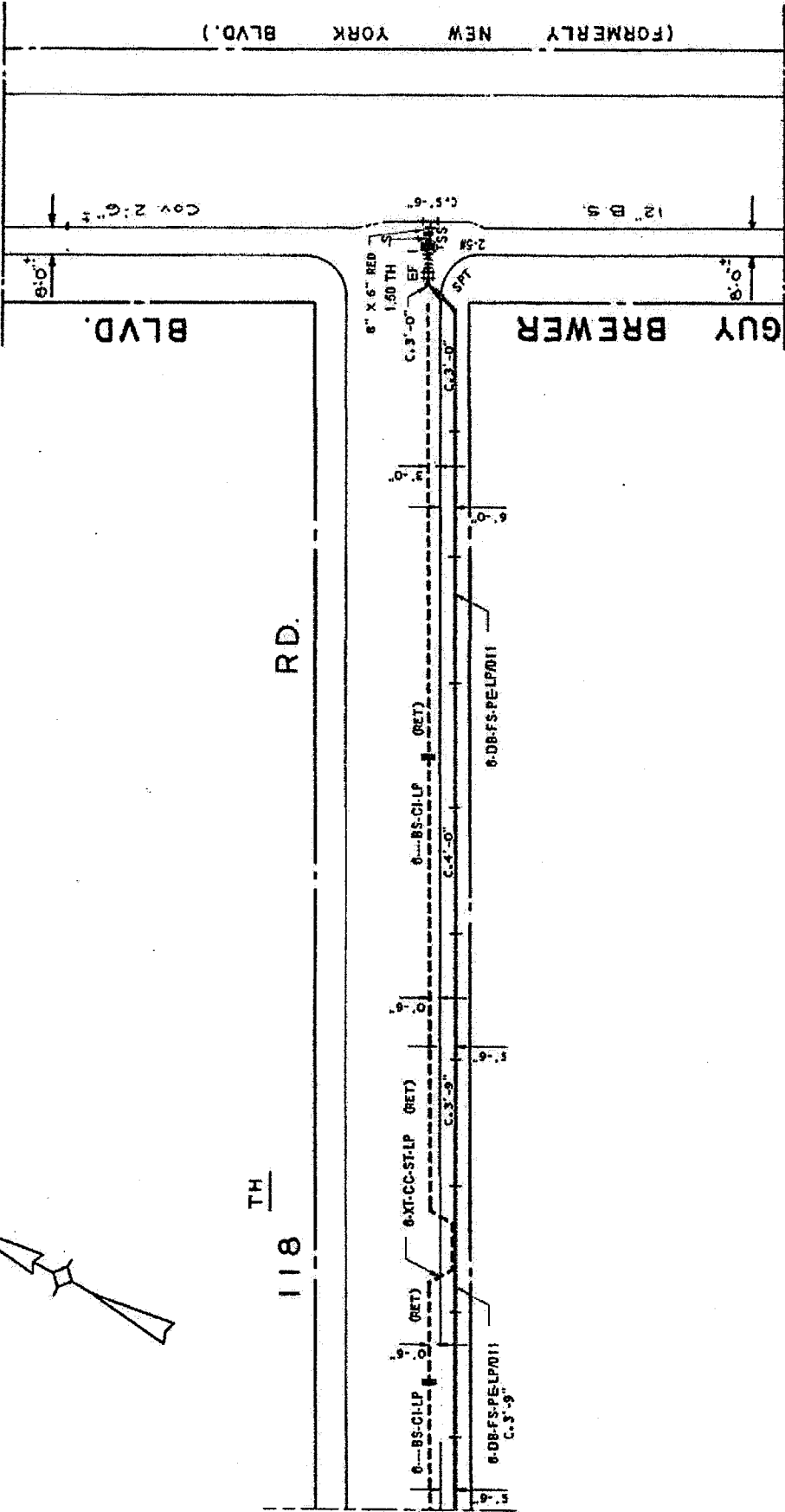

45-62
MATCH TO SHT 12 OF 15

A3-22 P

nationalgrid	
HWQ121B4	
Queens	45-60 SHT 14 OF 15

**VI - LISTING OF APPROXIMATE LOCATIONS OF EP-7 BID
ITEMS QUANTITIES**

(NO TEXT IN THIS AREA, TURN PAGE)

**SCOPE OF WORK
SUPPORT AND PROTECTION
FOR CONTRACT NUMBER HWQ-121B4**

The City of New York Department of Design and Construction is planning to install sewers and/or water mains and all appurtenances in various locations in The City of New York along with all work incidental thereto.

6.01.1 - Support & Protect Gas Main Crossing Sewer Up To 24" In Diameter (Ea.)

2 in 119 Ave. @ 164 St.

1 in 119 Ave. Bet. Guy R. Brewer Blvd. & 164 St.

6.01.2 - Support & Protect Gas Main Crossing Sewer 30" In Diameter (Ea.)

1 in 122 Ave. @ Lakeview Blvd. East

6.01.2A- Support & Protect Gas Main Crossing 38"Wx24"H H.E.R.C.P. Sewer (Ea.)

1 in 122 Ave. @ Lakeview Lane

6.01.2B- Support & Protect Gas Main Crossing 30"Wx19"H H.E.R.C.P. Sewer (Ea.)

1 in 122 Ave. @ Lakeview Lane

6.01.9 - Support & Protect Gas Main Crossing Water Main Up To 20" In Diameter (Ea.)

1 in 164 St. @ 119 Ave.

1 in 119 Ave. Bet. 164 St. & 165 St.

1 in Guy R. Brewer Blvd. Bet. 119 Ave. & 118 Rd.

1 in 122 Ave. @ Lakeview Blvd. East

6.02 - Extra Excavation For The Installation Of Catch Basin Sewer Drain Pipes With Gas Interferences (Ea.)

2 in Various Locations As Required

6.03 - Removal Of Abandoned Gas Facilities. All Sizes (L.F.)

2500 in Various Locations As Required

6.03.1 - Removal Of Abandoned Gas Facilities With Possible Coal Tar Wrap. All Sizes. (For National Grid Work Only) (L.F.)

200 in Various Locations As Required

**SCOPE OF WORK
SUPPORT AND PROTECTION
FOR CONTRACT NUMBER HWQ-121B4**

The City of New York Department of Design and Construction is planning to install sewers and/or water mains and all appurtenances in various locations in The City of New York along with all work incidental thereto.

6.04 - Adjust Hardware To Grade Using Spacer Rings / Adaptor (Street Repaving) (Ea.)

20 in Various Locations As Required

6.05 - Adjust Hardware To Grade By Resetting (Road Reconstruction) (Ea.)

20 in Various Locations As Required

6.06 - Special Care Excavation & Backfilling (C.Y.)

500 CY In Various Locations As Required, Including But Not Limited To All Gas Services Crossing Unsheeted Water Main Trenches.

6.07 - Test Pits For Gas Facilities (C.Y.)

20 in Various Locations As Required.

END OF ADDENDUM NO. 3
This addendum consists of forty-eight (48) pages.

ATTACH TO CONTRACT DOCUMENTS

**THE CITY OF NEW YORK
DEPARTMENT OF DESIGN AND CONSTRUCTION
INFRASTRUCTURE DIVISION
BUREAU OF DESIGN**

PROJECT ID: HWQ121B4

RECONSTRUCTION OF LAKEVIEW BOULEVARD EAST

**LAKEVIEW LANE - FROM BAISLEY BOULEVARD TO 122ND AVENUE
122ND AVENUE - FROM LAKEVIEW LANE TO LAKEVIEW BOULEVARD EAST
LAKEVIEW BOULEVARD EAST - FROM 122ND AVENUE TO 118TH AVENUE
118TH AVENUE - FROM LAKEVIEW BOULEVARD EAST TO LONG STREET**

NEW STORM AND SANITARY SEWERS (SEQ200436) IN:

**LAKEVIEW LANE - FROM BAISLEY BOULEVARD TO 122ND AVENUE
122ND AVENUE - FROM LAKEVIEW LANE TO LAKEVIEW BOULEVARD EAST
LAKEVIEW BOULEVARD EAST - FROM 122ND AVENUE TO 118TH AVENUE
119TH AVENUE - FROM LONG STREET TO 164TH STREET
164TH STREET - FROM 119TH AVENUE TO 120TH AVENUE**

**CAPITAL PROJECT WM-1
WATER MAIN WORK IN:**

**LAKEVIEW LANE - FROM BAISLEY BOULEVARD TO 122ND AVENUE
122ND AVENUE - FROM LAKEVIEW LANE TO LAKEVIEW BOULEVARD EAST
LAKEVIEW BOULEVARD EAST - FROM 122ND AVENUE TO 118TH AVENUE
118TH AVENUE - FROM LAKEVIEW BOULEVARD EAST TO LONG STREET
119TH AVENUE - FROM LONG STREET TO 164TH STREET
164TH STREET - FROM 119TH AVENUE TO 120TH AVENUE**

INCLUDING STREET LIGHTING AND TRAFFIC WORK

Together With All Work Incidental Thereto

**BOROUGH OF QUEENS
CITY OF NEW YORK
ADDENDUM NO. 4**

DATED: February 28, 2015

This Addendum is issued for the purpose of amending the requirements of the contract documents and is hereby made part of said contract documents to the same extent as if it was originally included therein.

**SPECIFICATIONS FOR CONSTRUCTION OF
BEST MANAGEMENT PRACTICE (BMP) AND MITIGATION AREA**

NO TEXT ON THIS PAGE

DIVISION VII - DETAILED SPECIFICATIONS –

CONTRACT SEQ200436 / HWQ121B4

**BAISLEY POND PARK AREA INFRASTRUCTURE IMPROVEMENTS,
QUEENS NY**

SPECIFICATIONS FOR

CONTRACT HWQ121B4 / SEQ200436

**Construction of Best Management Practice (BMP)
And Mitigation Area**

December 2014

Prepared for the NYC Department of Design and Construction

By Hazen and Sawyer, P.C.

DIVISION VII - DETAILED SPECIFICATIONS –

CONTRACT SEQ200436 / HWQ121B4

TABLE OF CONTENTS

CONSTRUCTION OF BEST MANAGEMENT PRACTICES

SPECIFIC PROVISIONS

<u>Section No.</u>	<u>Title</u>	<u>Page No.</u>
7.01	Location of Work.....	A6-10
7.02	Work Included.....	A6-10
7.03	Inspection Before Bidding and Mandatory Pre-Bid Conference.....	A6-14
7.04	Standard Sewer Specifications.....	A6-14
7.05	Inspection by the City, State and Federal Government.....	A6-15
7.06	Existing Utilities.....	A6-15
7.07	Permits Required.....	A6-15
7.08	Land for Contractor’s Use.....	A6-16
7.09	Licensed Surveyor (for Engineer’s Use).....	A6-16
7.10	Construction – Special Requirement.....	A6-17
7.11	Transportation and Handling of Materials and Equipment.....	A6-22
7.12	Protection of Materials and Equipment at the Site.....	A6-25
7.13	Final Cleaning.....	A6-25
7.14	OSHA Requirements.....	A6-26
7.15	No Separate Payments.....	A6-26
7.16	Bid Breakdown.....	A6-26
7.17	Detailed Work Description of BMP.....	A6-27

DIVISION VII - DETAILED SPECIFICATIONS –

CONTRACT SEQ200436 / HWQ121B4

STRUCTURES AND MISCELLANEOUS EQUIPMENT

<u>Section No.</u>	<u>Title</u>	<u>Page No.</u>
7.101	Work Included.....	A6-30
7.102	Dewatering.....	A6-31
7.103	Concrete.....	A6-38
7.104	Steel Reinforcement.....	A6-54
7.105	Welding.....	A6-59
7.107-B	Rip-Rap Stone/Angular Natural Field Stone.....	A6-66
7.109	Geotextile Fabric.....	A6-70
7.110	Sheeting and Bracing.....	A6-71
7.117	Graffiti Resistant Coating.....	A6-80
7.129	Concrete Structures.....	A6-99

DIVISION VII - DETAILED SPECIFICATIONS --

CONTRACT SEQ200436 / HWQ121B4

MORTARTED STONE WALL

<u>Section No.</u>	<u>Title</u>	<u>Page No.</u>
7.201	Work Included	A6-101
7.202	Masonry Mortar	A6-102
7.203	Masonry Accessories	A6-106
7.204	PA Colonial Field Stone	A6-108

DIVISION VII - DETAILED SPECIFICATIONS –

CONTRACT SEQ200436 / HWQ121B4

EARTHWORK AND GRADING

<u>Section No.</u>	<u>Title</u>	<u>Page No.</u>
7.300	Work Included.....	A6-113
7.304-A	Excavation.....	A6-117
7.305	Crushed Stone.....	A6-120
7.307-A	Grading.....	A6-122
7.308	Fill On-Site.....	A6-124

DIVISION VII - DETAILED SPECIFICATIONS –

CONTRACT SEQ200436 / HWQ121B4

LANDSCAPING AND RESTORATION

<u>Section No.</u>	<u>Title</u>	<u>Page No.</u>
7.400	Work Included.....	A6-131
7.401	Landscaping.....	A6-132
7.403	Top Soil for Restored Area.....	A6-154
7.404-A	Restoration Specialist (Construction Monitor).....	A6-159
7.404-B	Erosion and Sediment Control Licensed/Certified Professional.....	A6-163
7.407-A	Erosion Control Mat – Straw.....	A6-170
7.407-B	Erosion Control Mat – Curled Wood or Coconut Fiber.....	A6-172
7.408	Herbicide Application.....	A6-174
7.413	Temporary Goose Exclusion Fence.....	A6-181
7.414	BMP As-Built Plans.....	A6-183
7.417	Debris Exclusion Fence.....	A6-188

DIVISION VII - DETAILED SPECIFICATIONS –

CONTRACT SEQ200436 / HWQ121B4

EROSION AND SEDIMENTATION CONTROL MEASURES

<u>Section No.</u>	<u>Title</u>	<u>Page No.</u>
7.500	Soil Erosion and Sedimentation Control Measures.....	A6-190
7.501	Maintenance of Erosion Control Measures.....	A6-193
7.504	Reinforced Silt Fence.....	A6-196
7.509-A	Stabilized Construction Entrance.....	A6-203
7.510	Portable Sediment Tanks.....	A6-206
7.516	Turbidity Curtain.....	A6-213

DIVISION VII - DETAILED SPECIFICATIONS -

CONTRACT SEQ200436 / HWQ121B4

PERIMETER SITE SECURITY/ACCESS CONTROL MEASURES

<u>Section No.</u>	<u>Title</u>	<u>Page No.</u>
7.600	Work Included.....	A6-216
7.606	Permanent Accessway with Concrete Pavers or Gravel.....	A6-222

DIVISION VII - DETAILED SPECIFICATIONS –

CONTRACT SEQ200436 / HWQ121B4

STREAMBANK STABILIZATION

<u>Section No.</u>	<u>Title</u>	<u>Page No.</u>
7.700	Work Included.....	A6-225
7.710	Reno Mattress.....	A6-235

DIVISION VII - DETAILED SPECIFICATIONS –
CONTRACT SEQ200436 / HWQ121B4
CONTRACT SER200436 / HWQ121B4
CONSTRUCTION OF BEST MANAGEMENT PRACTICES

DIVISION VII
SPECIFIC PROVISIONS

7.01 LOCATION OF WORK

Work under this Contract is to be performed in two locations along the shore of Baisley Pond in Baisley Pond Park in the southeast area of Queens, New York. Specifically, the BMP work will occur along Lakeview Boulevard East from 118th Avenue to 122nd Avenue. The mitigation work will occur along 155th Street near the intersection with 119th Avenue. The two sites are on property owned and regulated by the City of New York. The properties are regulated by the New York State Department of Environmental Conservation (NYSDEC) as freshwater wetlands.

7.02 WORK INCLUDED

The work under this Contract includes the installation of new storm and sanitary sewers, replacement of water mains and a new outfall which includes a Best Management Practice (BMP). The work under this Contract also includes excavation to remove approximately 4,970 square feet of invasive Phragmites to mitigate impacts associated with the BMP work. The following descriptions of work included under this Contract are general descriptions only and shall not be construed as a complete description of the work to be performed.

A. The principal items of work include:

1. Storm Sewer and Sanitary Sewer Networks

This entails excavation of trenches and layout of storm sewer and sanitary pipelines. The specifications and plans for this work are included elsewhere in these Contract Documents, not in this Addendum.

2. Best Management Practices (BMP) Construction

This will entail the construction of hydraulic features necessary to treat and convey stormwater runoff at 119th Drive where the storm sewer system discharges into Baisley Pond. BMP construction at

DIVISION VII - DETAILED SPECIFICATIONS –
CONTRACT SEQ200436 / HWQ121B4

this site includes the installation of an outlet stilling basin. Specifications and plans for landscaping and erosion and sediment control are included in this Addendum. The specifications and plans for the outfall are included elsewhere in these Contract Documents, not in this Addendum.

3. Site Restoration

The entire BMP Project site will be restored upon project completion. The site restoration will include proper grading for permanent access and development of the BMP stormwater management facilities. Cleared areas will all be replanted with emphasis on the use of native plantings with the site layout designed to minimize the disturbance on the existing trees and plants. Boundaries will be established with the use of buffer areas where appropriate. The guide rail and pathway disturbed during construction will be replaced in kind.

4. Mitigation

This entails excavation and fill with clean fill material to the grades shown in the Contract Drawings. This item also includes grading and wetland landscaping along the shoreline as shown on the Contract Documents. The mitigation site shall be landscaped as directed by the Restoration Specialist and approved by the Engineer. Cleared areas will all be replanted with emphasis on the use of native plantings, with the site layout designed to minimize the disturbance on the existing adjacent wetland areas. A debris exclusion fence will also be installed.

B. Involved Agencies and Firms

Before bidding, the contractor shall become familiar with the following involved agencies and firms and their respective responsibilities in the project:

1. New York City Department of Design and Construction (NYCDDC)

The NYCDDC completed the designs for the storm sewer and sanitary components of the project. They will administer and inspect the Contractor's work with regard to the installation of the storm sewers and all other aspects of the project, including managing the overall project schedule, construction sequencing of

DIVISION VII - DETAILED SPECIFICATIONS –
CONTRACT SEQ200436 / HWQ121B4

the culvert construction. The NYCDDC will handle permit compliance in relation to sewer construction. Whenever reference is made in these specifications to "the Engineer", it means the Resident Engineer on site, hired by NYCDDC.

2. New York City Department of Environmental Protection (DEP)

This City agency will maintain the facilities where the BMP is to be constructed under this project.

3. New York City Department of Parks and Recreation (NYCDPR)

This City agency owns and will maintain the channel within Parks land. The NYCDPR along with the NYCDDC will be responsible for management of all construction within the Park's boundary.

4. New York State Department of Environmental Conservation (NYSDEC)

This State Agency has issued a freshwater wetland permit authorizing work in regulated areas to be performed under this Contract. This Agency has the regulatory authority to inspect the work site in order to ensure that permit requirements are not violated.

5. Hazen and Sawyer, P.C.

This engineering firm is the design consultant for all the work contained in these specifications. They are engaged by NYCDDC.

6. United States Army Corp of Engineers

This Federal Agency issues permits for all work within Federal jurisdiction wetlands. This agency has the regulatory authority to inspect the work site in order to ensure that permit requirements are not violated.

7. Restoration Specialist (Construction Monitor)

The Restoration Specialist shall be retained by the Contractor. The Restoration Specialist shall also serve as the Construction Monitor for the construction of the culvert and final site restoration. The

DIVISION VII - DETAILED SPECIFICATIONS –
CONTRACT SEQ200436 / HWQ121B4

individual or firm filling this position shall be responsible for overall oversight of the complete culvert installation. This individual or firm shall also focus on erosion control for the entire culvert site, and for overseeing all work in wetland areas and ensuring that the work adheres to permit requirements. The Restoration Specialist is responsible for compliance with the permit as it relates to culvert construction. The exact powers of the Restoration Specialist (Construction Monitor) are stipulated in the wetland permit.

C. Qualifications of Contractor/Subcontractor

1. The Contractor or its proposed subcontractor shall have performed at least three (3) projects similar in scope and type within the last five years that involved the restoration and/or creation of freshwater wetland systems.

To support the Contractor's contention that the Contractor or its proposed subcontractor is qualified to perform work involving the creation or restoration of freshwater wetlands the Contractor must provide the following information in a Statement of Qualifications within three (3) days upon request by the City:

Provide specific details on projects (i.e., location, size, cost, client, plant species, time of planting, etc.). Provide client contact person's name and telephone number. Describe any problems encountered during construction and corrective action taken to remedy the problem. Describe any violations issued by NYSDEC or any other regulatory agency. How were the violations resolved? Enclose copies of applicable wetland permits. Provide chronological photos recording the progress of the restoration and/or creation efforts, including preconstruction through completion. Include any required sign-offs from client and provide a list of all plants replaced on site.

2. The Contractor shall have performed at least three (3) contracts that involved the installation and maintenance of soil erosion and sediment control devices during construction of a project.

To support the Contractor's contention that he/she is qualified, the Contractor shall be able to provide the following information in a Statement of Qualifications, as detailed in the paragraph below.

Provide specific details on the projects (i.e., location, size cost, client, etc.). Provide client contact person's name and telephone number.

DIVISION VII - DETAILED SPECIFICATIONS –
CONTRACT SEQ200436 / HWQ121B4

Describe regulatory requirements of the erosion control devices. Describe any problems encountered during construction and operation of the devices. Discuss corrective actions taken to remedy the problem. Describe any violations issued by regulatory agencies. How were the violations resolved? Provide chronological photos recording the progress of construction and operation of the erosion control devices, including preconstruction through operation during site construction and restoration after construction.

Within three (3) days upon request by the City the Contractor shall identify a Certified Professional in Erosion and Sediment Control who will be responsible for implementation of this aspect of the project. The certification of professionals is cosponsored by the International Erosion Control Association and the Soil and Water Conservation Society. The Contractor shall also provide a copy of the certification for the person so identified.

The Contractor must be able to complete and submit to DCC the Statement of Qualifications described in this Section within three (3) calendar days after requested to do so by DCC.

7.03 INSPECTION BEFORE BIDDING AND MANDATORY PRE-BID CONFERENCE

Before bidding the Contractor shall visit the site of the work. The Contractor shall obtain all necessary information, and make his own determinations of any and all conditions which may affect in any way the performance of his work and his bid prices under these Contracts. All pertinent data and dimensions with regard to existing construction shall be verified by the Contractor.

Access to the site for inspection purposes prior to bidding is on a continual basis, since the site is a public property.

All bidders are required to attend a mandatory pre-bid conference, if one should be scheduled. Exact time and place meeting place is to be announced later.

7.04 STANDARD SEWER SPECIFICATIONS

Unless otherwise specified, all work, materials, and equipment shall conform to the applicable sections of the New York City Department of Design and Construction Standard Sewer Specifications.

DIVISION VII - DETAILED SPECIFICATIONS –
CONTRACT SEQ200436 / HWQ121B4

7.05 INSPECTION BY THE CITY, STATE AND FEDERAL GOVERNMENT

The Contractor shall provide proper facilities for inspection and access to the work at all times, whenever it is in preparation and progress, for authorized representatives of the City, State and Federal Governments, the latter two in the presence of the Engineer.

7.06 EXISTING UTILITIES

All subsurface utility and structure information shown on the Contract Drawings were obtained from various plans and maps and field investigations, however, it is not guaranteed to be complete or accurate. It shall be the Contractor's responsibility to locate all such necessary utilities or structures by the digging of test pits prior to the start of construction and/or by contracting the Joint Underground Locating Service (JULS). No separate payment will be made for test pits or any other work related to locating existing utilities. During the progress of the work, the Contractor shall protect from damage any existing utilities or services within the work areas until, if required, they have been re-routed, disconnected or capped off.

7.07 PERMITS REQUIRED

A. Permits To Be Acquired By Contractor

The Contractor is advised that the Department of Design and Construction has filed a joint application for permit with the New York State Department of Environmental Conservation (NYSDEC), the United States Army Corps of Engineers (USACE), and the New York State Department of State (NYSDOS). No work shall commence until the above-mentioned permit has been obtained for this project. As the application is being processed, it shall be the Contractor's responsibility to obtain and update the said permit.

The Contractor shall also become familiar with the following permits:

- U.S. Army Corps of Engineers Section 404 and Nationwide Permits,
- DEC Freshwater Wetlands Permit pursuant to 6NYCRR Parts 622 and 633, and water quality certification (Protection of Waters, Public Law 95-200) pursuant to the

DIVISION VII - DETAILED SPECIFICATIONS –
CONTRACT SEQ200436 / HWQ121B4

procedures of Section 401 certification for Federal Wetland Permit, and

- New York City Planning Commission Waterfront Revitalization (Coastal Zone) Consistency Determination.

The Contractor shall obtain all necessary permits as outlined in NYCDOT Standard Specifications, Section 1.06.23.

The Contractor is responsible for performing all work in compliance with all permit requirements, including the 5-year monitoring requirement required by the NYSDEC/USACE permits. No separate or additional payment shall be made to the Contractor for complying with the above requirements, and obtaining and updating of said permits. The cost of such work shall be deemed included in the prices bid for all contract items of work.

7.08 LAND FOR CONTRACTOR'S USE

It is the responsibility of the Contractor to acquire land for staging area and/or use as a construction equipment and material storage yard. Staging area, stock pile sites, and other storage locations shall be protected from erosion and stormwater runoff.

7.09 LICENSED SURVEYOR FOR ENGINEER'S USE

A. Work Included

The Contractor shall engage the services of a New York State licensed surveyor as approved by the Engineer and reporting directly to the Engineer to make such surveys, BMP as-builts, soundings, cross sections or other measurements as may be required by the Engineer for BMP construction and mitigation. Surveying services included in the item are for the sole use of the Engineer. The surveyor may be used by the Engineer to verify grades, but surveying services needed for layout of the BMP site and activities not related to BMP construction is the responsibility of the Contractor and is not provided under this item.

The Contractor for this Contract shall include in his total bid a per diem cost for the services performed by the Licensed Surveyor. This cost shall be shown on the Bid Schedule of Prices as Item No. BMP-7.09.

The cost proposals shall include unit prices on a per diem basis and shall include all necessary equipment, including vehicles for the Surveyors.

DIVISION VII - DETAILED SPECIFICATIONS –
CONTRACT SEQ200436 / HWQ121B4

The cost proposals shall be submitted to the Engineer for evaluation and selection.

B. Measurement and Payment

Measurement for payment shall be on a per diem basis. One day shall consist of any eight (8) hour time period from 7:00 AM to 6:00 PM Monday through Friday plus travel time, not including holidays. The per diem rate shall include the services of a three man surveying crew. The Engineer shall be present during the progress of Work and the Engineer shall deem as to whether a full eight hour period had been employed in completing the Work, and as to whether the Contractor has utilized his crew at the productivity output required to complete the Work as anticipated. The surveyor will submit invoices to the Engineer, which will be forwarded to the Contractor for prompt payment. Payments shall be made for invoiced costs only, with no payment for overhead and profit.

7.10 CONSTRUCTION - SPECIAL REQUIREMENTS

A. Field Measurements

The Contractor shall take all necessary measurements in the field to determine the exact dimensions for all work and verify all pertinent data and dimensions shown on the Contract Drawings.

B. Excavated Material

Unsuitable excavated material shall be removed from the site together with all debris encountered in the excavations and the costs of such removal and disposal shall be included in the unit price bid for the applicable items in this Contract.

C. Access Requirements

The Contractor is advised that he shall provide access to the sites of the work for all other Contractors and that access to the sites of the work performed under all contracts shall be closely coordinated and scheduled with all other Contractors at the various sites during the life of this Contract.

D. Connections to Existing Piping

Connections to existing piping shall be made to permit ready disconnection of equipment with minimum disturbance of adjoining piping and equipment. The Contractor shall be responsible for the exact

DIVISION VII - DETAILED SPECIFICATIONS –
CONTRACT SEQ200436 / HWQ121B4

alignment of all piping with the existing piping and associated equipment and under no circumstances will pipe springing be allowed.

E. Noise Control

The Contractor shall implement noise control measures during construction including limits on the hours of operation and compliance with sound level standards. Those measures will comply with NYC and Federal noise requirements. The Contractor shall comply with the NYC Noise Code. No separate payment shall be made for this work; the cost thereof shall be included in the bid price for other items.

F. Dust Control

During construction, all appropriate fugitive dust control, including watering of exposed areas and using dust covers for trucks shall be employed. These measures include satisfying Section 1402.2-9.11 of the New York City Air Pollution Code. To prevent fugitive dust from construction activities from becoming airborne, the following measures are proposed:

- Use of water or surfactant to control dust in the construction operations and during the clearing and grading of land;
- Application of water to dirt paths, materials, stockpiles, and other surfaces that can generate airborne dust over extended periods. Construction of accessways would be built with properly sized stone or concrete equivalent over filtering material;
- Covering open-body trucks transporting materials likely to generate airborne dust at all times when in motion; and
- Prompt removal of earth or other material from paved streets where earth or other material has been deposited by trucking or earth-moving equipment, erosion by water, or other means.

No separate payment shall be made for this work; the cost thereof shall be included in the bid price for other items.

G. Protection of Archeological Resources

NO TEXT

H. Suggested Sequence of Construction for BMP Site

DIVISION VII - DETAILED SPECIFICATIONS –
CONTRACT SEQ200436 / HWQ121B4

All work shall be completed in accordance with the Contract Drawings, and upon approval of the Engineer. All work shall be done in a manner to minimize disturbance to the adjacent natural area and adjacent existing vegetation. Stake out and receive approval from the Restoration Specialist for the limits of work before beginning any clearing. The Restoration Specialist shall identify all trees to receive tree guards and give approval for all trees identified for removal before removal operations begin.

Landscaping is not included in the suggested sequence of construction. The Contractor must receive approval for all landscaping work from the Restoration Specialist prior to construction.

1. No construction for the BMP shall begin until all perimeter erosion control measures have been installed as shown on the Contract Drawings. Install perimeter erosion control measures, including reinforced silt fence, turbidity curtain and tree guards, within and around the project area as shown on the Contract Drawings and/or as directed by the Engineer. Reinforced silt fence shall be placed along the existing edge of water. If clearing is required for installation of a particular measure, all measures not requiring clearing shall be installed first. Clearing of the necessary land for installation of the particular measure may then proceed. All construction materials, including debris, sediments and fresh concrete, shall be prevented from entering the waterways.
2. Demolish the section of existing guide rail and asphalt pathway, as shown on the Contract Drawings.
3. Install the stabilized construction entrance from Lakeview Boulevard East, as shown on the Contract Drawings. The Contractor shall prevent the deposition of materials on the public roadway. All materials deposited onto the public roadway shall be removed immediately.
4. Install approved dewatering measures. A portable sediment tank, or approved equal, shall be used to treat dewatering effluent prior to discharge. The Contractor shall receive approval from the Engineer prior to placement of the portable sediment tank, or approved equal. The work area shall not contain standing water and all work below the permanent pool elevation shall be conducted within the confines of the cofferdam, or other approved method. The top of the cofferdam shall be above the permanent pool elevation (approximately El +5 Queens Datum).
5. Perform site clearing, grubbing, demolition of existing curb along the pond's edge, and debris removal.

DIVISION VII - DETAILED SPECIFICATIONS –
CONTRACT SEQ200436 / HWQ121B4

6. Install the storm sewer from Lakeview Boulevard East to the outlet (see Sewer Drawings for the 42” concrete storm sewer layout).
7. Construct headwall and perform grading of outlet stilling basin.
8. Excavate the site according to the Contract Drawings, or as directed by the Engineer. Excavated material containing rhizomes and root mass from Phragmites and other plants shall be removed from the site and disposed of at an approved disposal site.
9. Backfill site with approved fill material to the elevations shown on the Contract Drawings.
10. Perform site grading below the permanent pool elevation within the confines of the cofferdam.
11. Perform grading of the pond edge. Remove the reinforced silt fence along El 5 Queens Datum to complete grading to tie into the pond. Replace the reinforced silt fence upon completion of a section of grading along the pond edge.
12. Remove the dewatering measures and restore the dewatering area, as necessary and as directed by the Engineer. All dewatered areas shall be restored to pre-construction conditions as approved by the Engineer.
13. Perform site grading and restoration above the permanent pool elevation. Install permanent site stabilization measures, including erosion control mat, or equivalent, on sloped areas and as directed by the Engineer. Seed all graded areas.
14. Once permanent stabilization is complete, remove temporary perimeter erosion and sediment control measures. Stabilize any areas within temporary erosion and sediment control measure footprints.

Suggested Sequence of Construction for Mitigation Site

All work shall be completed in accordance with the Contract Drawings, and upon approval of the Engineer. All work shall be done in a manner to minimize disturbance to the adjacent natural area and adjacent existing vegetation. Stake out and receive approval from the Restoration Specialist for the limits of work before beginning any clearing. The Restoration Specialist shall identify all trees to receive tree guards and give approval for all trees identified for removal before removal operations begin.

Landscaping is not included in the suggested sequence of construction. The Contractor must receive approval for all landscaping work from the Restoration Specialist prior to construction.

1. No construction for the BMP shall begin until all perimeter erosion control measures have been installed as shown on the Contract

DIVISION VII - DETAILED SPECIFICATIONS –
CONTRACT SEQ200436 / HWQ121B4

Drawings. Install perimeter erosion control measures, including reinforced silt fence and turbidity curtain, within and around the project area as shown on the Contract Drawings and/or as directed by the Engineer. Reinforced silt fence shall be placed along the existing edge of water. If clearing is required for installation of a particular measure, all measures not requiring clearing shall be installed first. Clearing of the necessary land for installation of the particular measure may then proceed. All construction materials, including debris, sediments and fresh concrete, shall be prevented from entering the waterways.

2. Install the stabilized construction entrance from Lakeview Boulevard East, as shown on the Contract Drawings. The Contractor shall prevent the deposition of materials on the public roadway. All materials deposited onto the public roadway shall be removed immediately.
3. Install approved dewatering measures. A portable sediment tank, or approved equal, shall be used to treat dewatering effluent prior to discharge. The Contractor shall receive approval from the Engineer prior to placement of the portable sediment tank, or approved equal. The work area shall not contain standing water and all work below the permanent pool elevation shall be conducted within the confines of the cofferdam, or other approved method. The top of the cofferdam shall be above the permanent pool elevation (approximately El +6.6 NAVD88).
4. Perform site clearing and grubbing. Clearing and grubbing along the existing outfall pipe, headwall, and path shall be done with hand tools to avoid impacts to existing infrastructure. Any infrastructure impacted shall be replaced in kind by the Contractor at no additional cost to the City.
5. Excavate the site to such a depth as to remove all Phragmites root rhizomes and root mass on site, as directed by the Engineer and Restoration Specialist. Excavated material containing rhizomes and root mass shall be removed from the site and disposed of at an approved disposal site. All excavation along the existing outfall pipe, headwall, and path shall be done with hand tools to avoid impacts to existing infrastructure. Any existing infrastructure impacted shall be replaced in kind by the Contractor at no additional expense to the City. Remove sections of reinforced silt fence along the pond edge as necessary for excavation. Replace the reinforced silt fence upon completion of a section of excavation along the pond edge. Any existing wetlands outside the limits of

DIVISION VII - DETAILED SPECIFICATIONS –
CONTRACT SEQ200436 / HWQ121B4

construction shall not be disturbed or destabilized during excavation.

6. Backfill site with approved, clean fill and rip-rap, as per Contract Specifications, to the elevations shown on the Contract Drawings. Remove sections of reinforced silt fence along the pond edge as necessary for backfilling. Replace the reinforced silt fence up completion of a section of backfilling along the pond edge.
7. Perform site grading below the permanent pool elevation within the confines of the cofferdam.
8. Perform grading of the pond edge. Remove the reinforced silt fence along El 5 Queens Datum to complete grading to tie into the pond. Replace the reinforced silt fence upon completion of a section of grading along the pond edge.
9. Remove the dewatering measures and restore the dewatering area, as necessary and as directed by the Engineer. All dewatered areas shall be restored to pre-construction conditions as approved by the Engineer.
10. Perform site grading and restoration above the permanent pool elevation. Install permanent site stabilization measures, including erosion control mat, or equivalent, on sloped areas and as directed by the Engineer. Seed all graded areas.
11. Once permanent stabilization is complete, remove temporary perimeter erosion and sediment control measures. Stabilize any areas within temporary erosion and sediment control measure footprints.

7.11 TRANSPORTATION AND HANDLING OF MATERIALS AND EQUIPMENT

A. General

1. Contractor shall make all arrangements for transportation, delivery, handling and rigging of equipment and materials required for prosecution and completion of the work.
2. Working space on the site is limited. Equipment shall not be delivered to the site until it can be moved directly to the area where it will be utilized.
3. If necessary to move stored materials and equipment during construction, the Contractor shall move or cause to be moved materials and equipment without any additional compensation.

DIVISION VII - DETAILED SPECIFICATIONS –
CONTRACT SEQ200436 / HWQ121B4

4. The Contractor shall take all necessary provisions to prevent inadvertent deposition and spillage of excavated soils or other materials that are being transported from the project site. The Contractor must employ the use of the truck tracing pad, wheel washing stations or other equipment deemed necessary to prevent spillage and deposition from vehicles from other construction equipment.

B. Delivery

1. The Contractor shall arrange deliveries of products in accordance with construction schedules and in ample time to facilitate inspection prior to installation.
2. Coordinate deliveries to avoid conflict with work and conditions at the site and to accommodate the following:
 - a. Work of other Contractors.
 - b. Limitations of storage space.
 - c. Availability of equipment and personnel for handling products.
3. Do not have products delivered to project site until related Working Drawings have been approved by the Engineer.
4. Do not have products delivered to site until required storage facilities have been provided.
5. Do not have products delivered to site until the manufacturer's recommended storage instructions have been submitted and approved.
6. Have products delivered to site in manufacturer's original, unopened, labeled containers. Keep Engineer informed of delivery of all equipment to be incorporated in the work.
7. Partial deliveries of component parts of equipment shall be clearly marked to identify the equipment, to permit easy accumulation of parts and to facilitate assembly.
8. Immediately upon delivery, inspect shipments to assure:
 - a. Product complies with requirements of Contract Documents and approved submittals.

DIVISION VII - DETAILED SPECIFICATIONS –
CONTRACT SEQ200436 / HWQ121B4

- b. Quantities are correct.
- c. Containers and packages are intact, labels are legible.
- d. Products are properly protected and undamaged.

C. Product Handling

- 1. The Contractor shall provide equipment and personnel necessary to handle products by methods to prevent soiling or damage to products or packaging.
- 2. Provide additional protection during handling as necessary to prevent scraping, marring or otherwise damaging products or surrounding surfaces.
- 3. Handle products by methods to prevent bending or overstressing.
- 4. Lift heavy components only at designated lifting points.
- 5. Materials and equipment shall at all times be handled in a safe manner and as recommended by manufacturer or supplier so that no damage will occur to them. Do not drop, roll or skid products off delivery vehicles. Hand carry or use suitable materials handling equipment.

D. Removing and Hauling Equipment and Materials

- 1. The Contractor shall inspect all items including all boxes, crates and packages containing equipment and materials for damage that may have occurred during shipment prior to its removal from the truck or other conveyance. Any damage shall be reported immediately to the Engineer.
- 2. The Contractor shall then carefully remove the equipment and materials from the truck or trucks on which it is shipped. The equipment and materials shall then be transported to the place of installation at the job site. The Contractor shall be liable for loss or damage to the equipment and materials that may occur while being unloaded, transported, stored or installed.
- 3. All equipment that arrives at the job site during normal working hours shall be unloaded as soon as practicable.

DIVISION VII - DETAILED SPECIFICATIONS –
CONTRACT SEQ200436 / HWQ121B4

7.12 PROTECTION OF MATERIALS AND EQUIPMENT AT THE SITE

The Contractor shall make every effort to minimize extended storage periods of materials and equipment at the Site by judiciously scheduling deliveries to coincide with construction needs.

Storage of any mechanical or electrical equipment out of doors at any time is absolutely prohibited regardless of the protection furnished. Storage of mechanical and electrical equipment within structures at the Site will not be permitted unless the structures are enclosed.

All mechanical equipment shall be coated, wrapped and otherwise protected from snow, rain, drippings of any sort, dust, mud, condensed water vapor, etc. during shipment, storage, and installation and until placed in service.

Should storage of mechanical equipment become necessary before it can be stored at the Site, the Contractor shall provide storage in a weatherproof warehouse.

Materials may be stored out of doors if supported above ground surface on wood runners and protected with approved, effective and durable covers.

All storage and protection of materials and equipment at the Site shall be subjected to the approval of the Engineer.

All costs for equipment protection including warehousing or other work to meet the scheduled completion date shall be deemed to be included under the Contract and no additional payment will be made.

7.13 FINAL CLEANING

A. Final Cleaning Under This Contract

1. At the completion of the work, the Contractor for this Contract shall remove all rubbish from and about the site of the work, and all temporary structures, construction signs, tools, scaffolding, materials, supplies and equipment which he or any of his subcontractors may have used in the performance of the work. The Contractor shall broom clean paved surfaces and rake clean other surfaces of grounds.
2. The Contractor shall thoroughly clean all materials, equipment and structures installed under this Contract; all marred surfaces shall be touched up to match adjacent surfaces.

DIVISION VII - DETAILED SPECIFICATIONS –
CONTRACT SEQ200436 / HWQ121B4

3. The Contractor shall clean all landscaped areas of all debris and any objectionable material, as determined by the Engineer, and shall remove all such debris off-site.
4. The Contractor shall remove all temporary erosion control measures and replace with final features as shown on the plans and other Contract Documents contained herein, as directed by the Engineer.

B. Cleaning Materials and Methods

The Contractor shall:

1. Use only cleaning materials recommended by manufacturer of surface to be cleaned.
2. Use each type of cleaning material on only those surfaces recommended by the cleaning material manufacturer.
3. Use only materials which will not create hazards to health or property.
4. The Contractor shall only use cleaning methods approved by the Engineer.

C. Payment for Final Cleaning

No separate payment will be made for the aforementioned work, the cost thereof shall be included in the price bid for other items of this Contract.

7.14 OSHA REQUIREMENTS

The Contractor shall comply with all applicable OSHA rules and regulations regarding hazardous materials. The Contractor's specific attention is called to OSHA Regulation 29 CFR, Part 1920.120.

7.15 NO SEPARATE PAYMENT

No separate payment shall be made for the work specified in the Specific Provisions. All costs shall be included in the various Contract items unless otherwise specified.

7.16 BID BREAKDOWN

DIVISION VII - DETAILED SPECIFICATIONS –
CONTRACT SEQ200436 / HWQ121B4

The Contractor shall submit a breakdown of the bid prices of this Contract within 15 days after the commencement date specified in the Notice to Proceed. The bid breakdown shall be by reference to every detailed specification section listed for the Contract Item, including physical quantities, material costs, unit costs, and installation costs, where applicable. In addition, separate amounts for the following shall be included in the bid breakdown:

Bond, Insurance and Mobilization
Final Working Drawings, Record Drawings

7.17

DETAILED WORK DESCRIPTION OF BMPBaisley Pond Park

The BMP is located to the southwest of the intersection of 119th Drive and Lakeview Boulevard East within a City park, Baisley Pond Park. The BMP site totals 0.14 acres and consists of the installation of a headwall and outlet stilling basin. The proposed project also involves the installation of new stormwater collection sewers (a total of about 3,500 linear feet of storm sewer). This BMP will provide stormwater velocity attenuation and water quality improvements.

The mitigation for the BMP project is located on the western shore of Baisley Pond, northeast of the intersection of 119th Avenue and 155th Street. The Phragmites area to be mitigated is approximately 0.12 acres. The site will be excavated to removal all Phragmites plant, rhizome and root material and will be planted with aquatic, emergent wetland, and adjacent pond vegetation.

Specific Provisions

7.09 Licensed Surveyor

Structures and Equipment

7.101 Work Included
7.102 Dewatering
7.103 Concrete
7.104 Steel Reinforcement
7.105 Welding
7.107-B Rip Rap Stone/Angular Natural Field Stone
7.109 Geotextile Fabric
7.110 Sheeting and Bracing
7.117 Graffiti Resistant Coating

DIVISION VII - DETAILED SPECIFICATIONS –
CONTRACT SEQ200436 / HWQ121B4

7.129 Concrete Structures

Mortared Stone Wall

- 7.201 Work Included
- 7.202 Masonry Mortar
- 7.203 Masonry Accessories
- 7.204 PA Colonial Field Stone

Earthwork and Grading

- 7.300 Work Included
- 7.304-A Excavation
- 7.305 Crushed Stone
- 7.307-A Grading
- 7.308 Fill On-Site

Landscape and Restoration Work

- 7.400 Work Included
- 7.401 Landscaping for Terrestrial Zone and Wetland Zone
- 7.403 Top Soil for Restored Area
- 7.404-A Restoration Specialist (Construction Monitor)
- 7.404-B Erosion and Sediment Control Licensed/Certified Professional
- 7.407-A Erosion and Control Mat - Straw
- 7.407-B Erosion and Control Mat – Curled Wood or Coconut Fiber
- 7.408 Herbicide Application
- 7.413 Temporary Goose Exclusion Fence
- 7.417 Debris Exclusion Fence
- 7.414 BMP As-Built Plans

Erosion and Soil Control Measures

- 7.500 Soil Erosion and Sedimentation Control Measures
- 7.501 Maintenance of Erosion Control Measures
- 7.504 Reinforced Silt Fence
- 7.509-A Stabilized Construction Entrance
- 7.510 Portable Sediment Tank
- 7.516 Turbidity Curtain

Perimeter Site Control/Access Control Measure

- 7.600 Work Included
- 7.606 Permanent Accessway with Concrete Pavers or Gravel

DIVISION VII - DETAILED SPECIFICATIONS -
CONTRACT SEQ200436 / HWQ121B4

Streambank Stabilization

- 7.700 Work Included
- 7.710 Reno Mattress

DIVISION VII - DETAILED SPECIFICATIONS –
CONTRACT SEQ200436 / HWQ121B4

STRUCTURES AND EQUIPMENT

7.101 WORK INCLUDED

Under structures and equipment work, Contractor shall furnish all labor, materials and equipment and shall do all work as specified herein and as shown on the Contract Drawings, including all incidental and appurtenant work required for a complete job.

The work shall include items of work specified under the following sections:

<u>Section No.</u>	<u>Title</u>
7.102	Dewatering
7.103	Concrete
7.104	Steel Reinforcement
7.105	Welding
7.107-B	Rip Rap Stone/Angular Natural Field Stone
7.109	Geotextile Fabric
7.110	Sheeting and Bracing
7.117	Graffiti Resistant Coating
7.129	Concrete Structures

* * * * *

DIVISION VII - DETAILED SPECIFICATIONS –
CONTRACT SEQ200436 / HWQ121B4

7.102 DEWATERINGA. Description of Work

The Contractor shall furnish, install, operate and maintain dewatering equipment as required, for BMP work as specified herein. The dewatering equipment shall include, but not be limited to, the following equipment items:

1. Pumps
2. Piping
3. Accessories
4. Wells.

B. General Requirements

1. General Specifications - Work performed under this Section shall be in conformance with the Standard Sewer Specifications.
2. Examination of the Sites - The Contractor shall take all steps that he considers necessary to familiarize himself with the surface and subsurface conditions at the site, and shall obtain the data that is required to analyze the water and soil conditions at the site.
3. Shop Drawings - The Contractor shall submit to the Engineer for approval shop drawings and any other material required to substantiate conformance with the requirements set forth in the specifications. Shop drawings shall include a detailed plan of operations.

C. Dewatering

1. General Information - The Contractor shall perform dewatering activities to insure that all construction is performed under dry conditions. If a well point system is proposed, the Contractor shall utilize a licensed well driller. The Contractor shall always drill down to sand or gravel layer when available and when it is below the lowest excavated invert.

The Contractor shall operate the dewatering pumps continuously, a day before and during construction until all associated work within the influence zone of the well point have been completed.

DIVISION VII - DETAILED SPECIFICATIONS –
CONTRACT SEQ200436 / HWQ121B4

2. Care and Disposal of Water - Care of water shall be in accordance with Section 15 - 15.25 of the Environmental Conservation Law.

Water from open cut and/or sheeted excavations, manholes, structures, trenches, or from whatever source, shall be disposed of strictly in accordance with methods approved by the Engineer.

The Contractor shall submit proposed dewatering methods to the New York State Department of Environmental Conservation for the required permits. If a well point dewatering system is proposed, the Contractor shall utilize a licensed well driller. Contractor shall contact NYSDEC a minimum of two (2) weeks in advance of dewatering system startup.

When required by the Engineer, such water shall be passed through a settling basin and tank of acceptable size and shape and equipped with an overflow. Each settling basin shall be cleaned as required and as ordered by the Engineer.

Sufficient water to flush all sewers and drains shall be provided by the Contractor when necessary. If any sewer, drain, catch basin, inlet or gutter, that receives dirty water attributable to the Site, should become filled or partially filled with sediment or debris, the Contractor shall promptly and satisfactorily remove such deposits.

D. Design Criteria

1. Provide dewatering system which will effectively reduce hydrostatic pressure and lower groundwater levels below excavation levels as necessary for safe and proper prosecution of the work and which will result in obtaining stable, substantially dry subgrade for prosecution of subsequent operations.
2. Design dewatering methods so that the effluent discharge from the sediment control measures (sump pit, sediment tank) does not impact surface water using the following protocol which was developed to monitor dewatering effluent discharge:
 - a. Monitoring of Dewatering Operations

Prior to the start of dewatering operations, a visual inspection of the installation of the sediment control measure(s) such as a dewatering sump pit and/or a portable sediment tank shall be made by the Engineer. Upon commencement of dewatering effluent discharge from the sediment control measures, at least three turbidity

DIVISION VII - DETAILED SPECIFICATIONS –
CONTRACT SEQ200436 / HWQ121B4

measurements of the effluent shall be conducted over a 15 minute-period using the following methodology. If the arithmetic mean of these three turbidity measurements is greater than three (3) times the ambient turbidity level or 50 NTUs, whichever is less, all dewatering operations shall be discontinued until the Engineer is consulted regarding additional control measures. If the ambient turbidity level is greater than 50 NTUs, the dewatering effluent discharge shall not exceed the ambient turbidity level unless otherwise directed by the Engineer.

b. Determination of Ambient Turbidity

Ambient turbidity levels of surface waters shall be determined using a Hanna Instruments HI 93703 Portable Microprocessor Turbidity Meter available from Hanna Instruments, Inc., Woonsocket, RI or Orbeco Hellige Portable Turbidity or LaMotte Portable Turbidimeter or equivalent approved by the Engineer. Ambient turbidity measurements shall be collected under dry weather conditions. Dry weather conditions are defined as no precipitation in the preceding 48 hours. A minimum of three turbidity measurements shall be collected using as follows:

- Water samples shall be collected a minimum of 20 feet upstream of the work area prior to commencement of any construction activity.
- Water samples shall be collected without disturbing stream bank or stream bed sediments.
- The turbidity measurements shall be conducted according to the instructions provided in the unit's Operational Guide which are summarized below.
- After the meter has been turned on, fill a clean cuvet up to one quarter inch from its rim with thoroughly agitated sample.
- Allow sufficient time for bubbles to escape before securing the cap.
- Wipe the outside of the cuvet thoroughly with a lint-free tissue.

DIVISION VII - DETAILED SPECIFICATIONS –
CONTRACT SEQ200436 / HWQ121B4

- Place the cuvet into the cell of the meter.
- Press the Read key and the LCD will display a blinking "SIP" (Sampling in Process). The turbidity value will appear after approximately 25 second.

The arithmetic means of the three dry weather upstream turbidity measurements shall be the ambient turbidity level. Turbidity shall be measured in Nephelometric Turbidity Units (NTUs).

E. Submittals

Submit the following for approval:

1. Working Drawings
 - a. Type of dewatering system proposed, showing arrangement, location and depths of proposed system, complete description of equipment and materials to be used, procedure to be followed, standby equipment, standby power supply and proposed location(s) of points of discharge of water.
 - b. Obtain approval from the Engineer and appropriate regulatory agencies prior to installation of system.

F. Job Conditions

1. Subsurface Conditions
 - a. Subsurface investigations and groundwater level determinations shall be conducted by the Contractor prior to implementation as specified herein.
2. Responsibilities
 - a. Select and install dewatering system to accomplish groundwater control as specified.
 - b. Monitor quality of discharge from dewatering system to determine if soil particles are being removed by system.

DIVISION VII - DETAILED SPECIFICATIONS –
CONTRACT SEQ200436 / HWQ121B4

- c. Measure to ascertain if movement is caused in adjacent areas by dewatering operations; take approved measures to minimize such movement.
- d. Take measures to prevent damage to property.
- e. Repair as approved damage, disruption or interference resulting directly or indirectly from dewatering operations.
- f. Remove sediments from all intercepted groundwater or surface water as specified herein and approved by the Engineer and the jurisdictional agency concerned. Under no circumstances shall the Contractor directly discharge, without treatment, into the drainage channel or creek.

G. Sump Pit

The Contractor, at the direction of the Engineer shall provide a stone filled pit with perforated standpipe/nozzle wrapped with filter fabric in which intercepted groundwater is pumped to an approved location.

The size and shape of the sump pit will vary due to site conditions. The size of pump should be determined from manufacturer's specifications.

1. The standpipe shall be a perforated 12"-24" diameter corrugated or PVC pipe.
2. A base of 2" aggregate shall be placed in the pit to a depth of 12". After installing the standpipe, the pit surrounding the standpipe shall then be backfilled with 2" aggregate.
3. The standpipe shall extend 12"-18" above the lip of the pit.
4. The standpipe shall be wrapped with filter cloth before installation. If desired, 1/2" x 1/2" hardware cloth may be placed around the standpipe, prior to attaching the filter cloth. This will increase the rate of water seepage into the pipe.

H. Surface Drainage

1. Intercept and divert surface drainage away from BMP or other excavations, wells by use of dikes, ditches, swales, open stone lined channel, temporary diversion pipes which could be either on the surface or buried, sumps or other means. To properly install buried diversion pipe the contractor may be required to excavate.

DIVISION VII - DETAILED SPECIFICATIONS –
CONTRACT SEQ200436 / HWQ121B4

2. Design surface drainage systems to prevent erosion on or off the site or unwanted water flow.
3. Remove surface drainage system when no longer required.
4. Remove debris and restore site(s) to original conditions.

I. Drainage Of Excavated Areas

1. Provide and maintain ditches of adequate size to collect surface and subsurface water and seepage which may enter excavations and divert water into sump so that it can be drained or pumped into drainage channels as approved by the Engineer and the jurisdictional agency concerned.
2. Install settling basins or other approved apparatus as necessary to reduce amount of fine particles carried by water diverted away from excavation.
3. When no longer necessary, backfill and seal drainage ditches, sumps and settling basins with approved material.

J. Execution

1. Install dewatering system as specified and with the approval of the Engineer.
2. Demonstrate by approved methods that no soil particles are present in water after 12 hours of initial pumping or draining and additionally as directed.
3. Dispose of precipitation and subsurface water away and clear of the work area. Keep excavation dry.
4. Maintain continuous and complete effectiveness of the installation.
5. Maintain water level at such elevation that no damage to structure or plant material can occur because of excessive hydrostatic pressure. In any event, maintain water level two feet minimum below bottom of subgrade until sufficient concentrate work or backfilling or both has been completed to adequately offset uplift pressures.

K. Dewatering System Removal

DIVISION VII - DETAILED SPECIFICATIONS –
CONTRACT SEQ200436 / HWQ121B4

1. Remove and dispose of all stone, filter fabric and piping that comprise curtain drains and/or sump pits used in dewatering in accordance with Federal, State and local regulations at a permitted site.
2. Backfill remaining space as necessary to restore surface and subsurface to its original or proposed condition in accordance with the Engineer's approval.

L. No Separate Payment

Dewatering work shall be performed by the Contractor only as directed by the Engineer. The cost for all labor, materials and equipment required for the Dewatering shall be deemed included in the bid price for other Contract Items. No separate payment shall be made for Dewatering.

* * * * *

DIVISION VII - DETAILED SPECIFICATIONS –
CONTRACT SEQ200436 / HWQ121B4

7.103 CONCRETEA. Work Included

Description - The Contractor shall furnish, and place all structural and nonstructural concrete as indicated on the Contract Drawings and as specified herein. Nonstructural concrete does not include steel reinforcement and is used for stone embedment, sidewalks, pedestrian ramps, curbs, concrete cores, mud mats, cradles and fill concrete or as noted on the Contract Drawings.

B. General Requirements

1. General Specifications - The General Specification: 11-Concrete (Dated November 1991) of the Department of Environmental Protection (DEP) and Standard Sewer Specifications of the Department of Design and Construction (NYCDDC) is declared to be part of this specification, the same as it is fully set forth elsewhere herein. Copies of this specification may be obtained from the Department. Concrete work shall conform to all requirements of that specification except as modified by this Detailed Specification.

2. Submittals

The Contractor shall submit to the Engineer for approval shop drawings and other materials required in accordance with the requirements set forth on the Contract Drawings and the Specifications in accordance with the Standard Sewer Specifications. Submittals shall also include all material required under the "Submittals" section of the chapters of General Specification 11, Concrete, and any additional submittals hereinafter specified.

C. Detailed Requirements

The reference numbers in this Detailed Specification are keyed to the chapters and section numbers of General Specification 11; the first number(s) to the left of the first decimal designates the chapter and the subsequent numbers to the right of the first decimal designate the sections within the chapter. The Detailed Specifications herein shall take precedence over the Sewer Specifications, December 1996.

1.4.1.6 The Engineer shall be responsible for all concrete inspections (including semi-controlled inspection).

DIVISION VII - DETAILED SPECIFICATIONS –
CONTRACT SEQ200436 / HWQ121B4

- 2.1 Coarse and Fine Aggregates for Concrete shall be well graded in accordance with 2.6.1.1. Maximum size of course aggregate shall be 3/4". All sieve sizes (1-1/2" to No. 200) shall be used in determining grading of both coarse and fine aggregates.
- 2.2.4 Contractor shall submit to the Engineer for approval a minimum of two (2) suppliers of aggregate he proposes to use.
- 2.2.5 Contractor shall furnish confirmation to the Engineer that he can obtain 100% of the needed aggregates from one area prior to approval to place concrete.
- 2.3 Maximum cementitious material factor shall be 680 lbs/cu. yd of concrete for 4000 psi concrete.

For concrete mixed with only Portland Cement, the total alkalis in the cement (calculated as the percentage of NA_2O plus 0.658 times the percentage of K_2O) shall not exceed 0.40%.

For concrete mixed with Portland Cement and an appropriate amount of fly ash, the total alkalis in the Portland Cement (calculated as the percentage of NA_2O plus 0.658 times the percentage of K_2O) shall not exceed 0.85%.

An approved mineral admixture Type F (Fly Ash) shall be substituted for cement in the ratio of 20% by weight

- 2.4 All concrete, unless noted otherwise on the Contract Drawings, shall be air entrained and contain a water reducing or high range water reducing admixture. For proportioning of air content and admixtures, see Chapter 3, Sections 3.5, 3.6 and 3.8.
- 3.3 All concrete shall be Class 40, 4000 psi based on 28 day compressive test. All concrete shall be proportioned and tested in accordance with Section 1.4.3 of the General Specifications 11 - Concrete, unless noted otherwise.
- 3.4 All concrete shall be normal weight. Lightweight Concrete shall not be used unless noted otherwise.
- 3.6 Slump:
1. Slump for all concrete shall be 3 +/- 1 inches, unless indicated otherwise.

DIVISION VII - DETAILED SPECIFICATIONS –
CONTRACT SEQ200436 / HWQ121B4

2. Where high range water reducing admixture is used, the specified water-cementitious material ratio shall be reduced by 0.02 and concrete shall be proportioned for no higher than 3-inch slump. The slump after addition of the high range water reducing admixture shall not exceed 8 inches when measured at the point of placement.
 3. A tolerance of up to 2 inch above the maximum indicated slump shall be allowed for one batch in any five consecutive batches tested provided that it can be demonstrated that the specified water-cementitious material ratio is not exceeded.
- 3.5.1.1 When the above tolerances are exceeded, the condition shall be immediately investigated and corrective action taken. Corrective action may include modification of the mix as required by the NYC Building Code. A report of the condition and the remedial action taken shall be filed with the Engineer designated for Controlled Inspection within 48 hours.
- 4.3.7.1 Form ties for all structures containing or resisting liquid pressure shall have water stops at mid-thickness of the wall.
- 5.3 Deformed billet steel bars shall comply with the requirements of ASTM A615, grade 60.
- 6.4 Expansion Joints
- 6.4.1 General Information - Expansion joints with joint fillers and joint sealants shall be constructed where shown and as indicated on the Contract Drawings.
- 6.4.2 Materials and Installation
- 6.4.2.1 Joint Fillers - Expansion joint filler shall conform to ASTM D1752, Type 1. The joint sealant shall be separated from the filler by a suitable bond breaker of polyethylene film or tape as recommended by the sealant manufacturer.
- 6.4.2.2 Joint Sealants
- a. A two component thiokol polysulfide base synthetic rubber sealant such as Pecora Synthacalk GC-2, Sonneborn-DeSoto Sonolastic 2-part, or approved equal shall be used in all expansion joints in concrete and

DIVISION VII - DETAILED SPECIFICATIONS –
CONTRACT SEQ200436 / HWQ121B4

masonry and wherever else specified or shown on the Contract Drawings.

It shall be furnished in pour grade or gun grade depending on installation requirements. Primers shall be used as called for by the manufacturer. The sealant shall be furnished in colors as directed by the Engineer.

- b. A two component pourable polyurethane sealant such as Pecora NR-300, Sonneborn-DeSoto Sonolastic Paving Joint Sealant SL-2, or approved equal shall be used in all concrete floors subject to heavy traffic and wherever else specified or shown on the Contract Drawings.

- 6.4.2.3 Installation of Joint Fillers and Sealants - Joint fillers and sealants shall be installed in accordance with manufacturer's recommended procedures and as shown on the Contract Drawings. Adhesive for holding sponge rubber joint filler to concrete shall be Scotchgrip Cement No. 1300 as manufactured by Minnesota Mining and Manufacturing Co, or W.R. Meadows, Inc., or approved equal.

Joint filler that will be exposed after removal of forms shall be cut and trimmed to ensure a neat appearance and shall completely fill the joint except for the space required for the sealant. The filler shall be held securely in place and no concrete shall be allowed to enter the joint or the space for the sealant and destroy the proper functions of the joint.

A bond breaker of polyethylene film shall be used between filler and sealant. The joint shall be thoroughly clean and free from dirt and debris before the primer and the sealant are applied. Where the finished joint will be visible, masking of the adjoining surfaces shall be carried out to avoid their discoloration.

The sealant shall be neatly tooled into place and its finished surface shall present a clean and even appearance.

6.5 Waterstops

6.5.1 Work Included

- 6.5.1.1 Description - The Contractor shall furnish and install all waterstops for expansion and construction joints as indicated on the Contract Drawing, specified herein or required for a complete installation.

DIVISION VII - DETAILED SPECIFICATIONS –
CONTRACT SEQ200436 / HWQ121B4

6.5.1.2 General Requirements

1. General Specifications - Waterstops shall be manufactured from virgin polyvinylchloride and shall meet or exceed all requirements set forth in the U.S. Corps of Engineers Specification CRD C572.
2. Samples - The Contractor shall submit to the Engineer one (1) sample of each type of PVC waterstop. Each sample is to include a splice.

- 6.5.2.1 General Information - Prior to installation, the Contractor shall submit layout drawings for approval, showing diagrammatically or otherwise the extent of the waterstop installations that are proposed to ensure that all construction and expansion joints will be watertight. The drawings shall include elevations, sections, etc. and all details to show that a continuous watertight installation shall be provided.

Construction joints made in other than positions shown on the Contract Drawings for the convenience of the Contractor are subject to the Engineer's approval and shall have water stops installed in these non-indicated construction joints at no additional cost to the City.

6.5.2.2 Materials and Installation

1. Materials - All waterstops shall be of polyvinylchloride extruded from an elastomeric plastic compound of which the basis resin shall be polyvinylchloride. The compound shall contain any additional resins, plasticizers, stabilizers or other materials needed to ensure qualities which will meet the requirements herein specified.

The required minimum physical characteristics for this material are per ASTM D-638:

Tensile strength	-	1,750 psi
Ultimate elongation	-	not less than 280%

No reclaimed PVC shall be used for the manufacture of the waterstops. The Contractor shall furnish certification that the proposed waterstops meet the above requirements.

DIVISION VII - DETAILED SPECIFICATIONS –
CONTRACT SEQ200436 / HWQ121B4

Waterstops for construction joints shall be flat ribbed type, 6 inches wide with a minimum thickness at any point of 3/8 inches.

Waterstops for expansion joints shall be ribbed with a center bulb, 9 inches wide with a minimum thickness at any point of 3/8 inches. Center bulb shall have an outside minimum diameter of 1 inch and an inside minimum diameter of 1/2 inch.

2. Installation - Waterstops shall be installed in the work so that they are embedded to an equal depth in concrete on both sides of the joint and the waterstops shall be kept free from oil, grease, mortar or other foreign matter. Waterstops shall be adequately secured against movement during the pouring of concrete. Forms adjacent to waterstops shall be rigidly constructed and braced to prevent the concrete from leaching through joints and the displacement of waterstops due to power vibrating of the concrete. Concrete adjacent to waterstops shall be placed in 12 inch lifts and power vibrated to prevent honeycombing, voids and separation of aggregates at the surfaces of concrete separation joints.
 - a. Splices - Splices at the intersection of runs of waterstops shall be made by heat sealing the adjacent surfaces in accordance with the manufacturer's recommendations using a thermostatically controlled electric source of heat. Only straight butt joint splices will be allowed in the field. At least three satisfactory field splices shall be made as samples on site. The Engineer may require tests on these splices by an approved laboratory, at the Contractor's expense, to certify the tensile strength of the joint. The strength attained shall be at least 80% of the unspliced material before any is used in the work.
 - b. Defective Work - Defective work, as determined by the Engineer, shall be remedied by cutting and rebuilding the concrete walls and slabs, replacing the waterstop assemblies or remedied by other methods as approved by the Engineer.
 - c. Responsibility - The final responsibility for constructing a watertight condition at expansion

DIVISION VII - DETAILED SPECIFICATIONS –
CONTRACT SEQ200436 / HWQ121B4

joints and construction joints remains with the Contractor as part of the work under this Contract.

6.6.2.1 The Contractor shall coordinate and/or provide for the installation of anchor bolts, pipes, sleeves, inserts, chases, recesses, and all other embedded items, required in the work.

6.6.5.3 The Contractor shall submit equipment pad layout drawings.

6.7 Precast Concrete

A. The Contractor shall furnish and install all precast items shown or specified in the Contract Documents, including all appurtenances necessary to make a complete installation. This section does not include prestressed or postensioned concrete.

B. Without limiting the generality of other requirements of these specifications all work hereunder shall conform to the applicable requirements of the referenced portions of the following documents, to the extent that the requirements therein are not in conflict with the provisions of this Section.

1. Precast Prestressed Concrete Institute Standard MNL -117.
2. ASTM C478 Specification for Precast Reinforced Concrete Manhole Sections.
3. ACI 318 Building Code Requirements for Reinforced Concrete.
4. ACI 350 R - Concrete Sanitary Engineering Structures.

C. Submittals

1. The Contractor shall submit shop drawings for all precast concrete items. Submitted drawings shall show all dimensions, location and type of lifting inserts, and details of reinforcement and the method of anchorage of surrounding work.

DIVISION VII - DETAILED SPECIFICATIONS –
CONTRACT SEQ200436 / HWQ121B4

2. For all precast items which are manufactured, the Contractor shall also submit a list of the design criteria used by the manufacturer.
 - a. For all precast items which are manufactured, and which have a clear dimension, in any direction, greater than or equal to 4'-0", the Contractor shall submit design calculations per criteria stated on contract drawings. The precast concrete calculations shall be stamped and signed by a Professional Engineer registered in the State of New York.
3. The Contractor shall submit approved ICBO reports for all lifting inserts, showing allowable design loads on the inserts.

D. Quality Assurance

1. Precast concrete units shall be made by an experienced manufacturer and shall be constructed as shown on the Drawings and specified herein and shall be free of defects, checks and cracks. Care shall be taken in the mixing of materials, casting, curing and shipping to avoid any of the above.
2. The Contractor shall notify the Engineer a minimum of 24 hours prior to casting and when the units have been fabricated and await the Engineer's consent prior to shipping to the site.
3. The Engineer may elect to examine the units at the casting yard or upon arrival of same at the site. The Engineer shall have the option of rejecting any or all of the precast work if it does not meet with requirements shown on the Drawings or specified herein. All rejected work shall be replaced at no additional cost to the City.

E. Products

1. The joint sealing compound shall be Quik-Seal, a preformed, cold applied, ready to use plastic joint sealing compound as supplied by Quikset Utility

DIVISION VII - DETAILED SPECIFICATIONS –
CONTRACT SEQ200436 / HWQ121B4

Vaults, Santa Ana, California; Ram-Nick by K.T. Snyder Company; or approved equal.

2. Mortar used between the sections of precast concrete manholes and vaults shall be as recommended by the manhole section manufacturer.
3. Non-shrink grout shall be used where grouting is required.

F. Design

1. The precast concrete units shall be designed for the dead load of the units plus a minimum superimposed horizontal Truck load of H20 for the spans shown on the Drawings unless shown or noted otherwise on Drawings.
2. Deflection shall not exceed 1/360 of span at design load.

G. Fabrication

1. All precast items shall be fabricated in accordance with PCI Manual for Quality Control for Plants and Production of Architectural Precast Concrete Product.

H. Installation

1. Required pads, plates and reinforcing bars shall be furnished for casting and anchorage in the adjoining work. The precast concrete units shall be installed with the units tight and at right angles to the supporting beams or walls. The units shall be aligned and leveled in accordance with the procedures recommended by the manufacturer. Units shall be grouted by a mixture of not less than one part cement to three parts fine sand, care being taken to see that joints are filled. Damp grout that may have seeped through shall be removed before it hardens.
2. All openings in the precast units shall be made by the Contractor and are the responsibility of the

DIVISION VII - DETAILED SPECIFICATIONS –
CONTRACT SEQ200436 / HWQ121B4

Contractor. Where details for an opening are not shown on the Drawings, the opening shall be made in accordance with the recommendation of the manufacturer.

- a. For precast planks, when an opening causes a loss in carrying capacity of the unit, the adjacent units shall be designed to carry the additional dead and superimposed load transferred from the unit with the opening. The Contractor shall provide saddle headers to transfer the load to adjacent members.
3. Damaged units shall be replaced at no additional cost to the City.

8.7.6 Connecting Concrete to Existing Structures

- A. Where new concrete work is to be made integral with existing concrete work, the Contractor shall proceed as follows and as shown or specified.
 1. Roughen surface of existing concrete by chipping.
 2. Cut existing concrete where required or as indicated on the contract drawings.
 3. Where it is necessary to expose existing reinforcement, the reinforcing rods shall be cleaned by wire brushing and new reinforcement shall be hooked into existing reinforcement and lapped, drilled into existing concrete and set with an approved adhesive, or welded as directed. Proper preheating shall be required prior to welding. Clearance around each bar shall be in accordance to ACI 318 requirements.
 4. Where expansion anchors are shown, holes shall be drilled in the existing concrete as indicated on the contract documents and to the minimum depths as recommended by manufacture so as to provide a minimum bond strength of 125% of yield.

DIVISION VII - DETAILED SPECIFICATIONS –
CONTRACT SEQ200436 / HWQ121B4

5. Waterstops to be set into existing concrete shall be as shown on the Contract Drawings.
 6. Thoroughly wash all surfaces and install waterstops and reinforcing steel as required.
 7. Apply bonding compound in strict conformance with the manufacturer's instructions.
 8. Apply new concrete in strict conformance with bonding compound manufacturer's recommendations.
- B. Where portions of existing concrete structures or masonry bulkheads are to be removed and where the remaining concrete is to be finished smooth, the Contractor shall do the following as a minimum:
1. Remove concrete or masonry to the depths shown on contract drawings or required by the Engineer.
 2. Cut off projecting reinforcement to a depth of at least 2 inches measured from the finished concrete surface. Where shown, reinforcement shall be bent across cut face and covered with new concrete.
 3. Thoroughly coat the roughened concrete surfaces by applying bonding compound in strict conformance with the manufacturer's instructions.
 4. Cement mortar shall be placed to a thickness slightly in excess of the finished surface and shall be steel-trowel-finished, flush with the adjacent surfaces.
 5. The color of new concrete in the exposed surfaces shall match the color of the existing adjoining concrete as closely as possible.
 6. Cement mortar shall consist of one part Portland cement and two parts of sand by volume.

Whenever new concrete is connected to existing concrete, the existing concrete shall be coated with bonding compound. Surface preparation, application and curing

DIVISION VII - DETAILED SPECIFICATIONS –
CONTRACT SEQ200436 / HWQ121B4

shall be done in strict accordance with the manufacturer's directions.

8.7.7 Cutting and Patching Opening for Pipe and Other Penetrations in Existing Concrete

- A. The Contractor shall cut the existing concrete within the limits required, expose the existing reinforcement, and perform the work in such manner to prevent damage to the existing adjacent concrete and/or equipment. Unless otherwise permitted, line drilling is required. The exposed reinforcement shall be cleaned by wire brushing, then cut and bent to permit the installation and finally bent around the new pipe or thimble. Additional reinforcement shall be provided as shown on the Contract Drawings. When reinforcing is required to be welded to structural members, the work shall be done by approved and licensed welders using size and length of beads shown on the Contract Drawings.
- B. Coating of the existing concrete shall be as previously specified under Section 8.7.6. Non-shrinking grout shall be used for setting wall casting, sleeves and wherever called for into existing concrete.
- C. Dowels and anchors shall be set with an approved epoxy adhesive in strict accordance with manufacturer requirements.
- D. Openings shall be provided with keyed joints meeting the Engineer's approval prior to coating and patching.
- E. Where such work will be visible in the completed work, the adjacent surfaces shall be made to match as closely as possible.

8.10.5 Non-Shrink Grout - Non-shrink, non-staining grout shall be "Euco N-S" by the Euclid Chemical Company, or "Masterflow 713" by Master Builders, or approved equal. Non-shrink grout shall be mixed and placed in strict accordance with the directions of the manufacturer.

Non-shrink grout shall be used for setting the structural items where as noted on the Contract Drawings.

8.12 Concrete Sealer

DIVISION VII - DETAILED SPECIFICATIONS –
CONTRACT SEQ200436 / HWQ121B4

Concrete sealer shall be a one (1) part polyurethane sealer and dustproofer, "Eucothane" as manufactured by the Euclid Chemical Company, or approved equal.

Concrete sealer shall be applied on all equipment pads.

8.13 Pigmented Admixture

This section describes Pigmented Admixture for coloring Portland cement mixtures.

It shall be certified by the manufacturer that the Pigmented Admixture shall comply with the requirements of ACI 212.3R.-10, Section 6.1., as water-reducing admixtures, and that their water reducing components have been tested for compliance with ASTM C-494 (Specification for Chemical Admixtures for Concrete). It shall be certified by the manufacturer that the Pigmented Admixture shall consist of pure synthetic mineral oxide only, and shall comply with ASTM Designation C979. It shall also be certified by the manufacturer that the Pigmented Admixture shall be single-component admixture, complying with both ASTM C494 and ASTM C979, not as a combination of two or more additives or admixtures.

The pigmented Admixture shall produce a color equal to the standards on file at the office of the New York City Department of Transportation, Bureau of Highways, Division of Roadway Engineering, 40 Worth Street, New York, NY 10013 and The Landmarks Commission, 225 Broadway, 23rd Floor, New York, NY 10007. The color shall be approved by the Engineer.

The Pigmented Admixture manufacturer shall certify that when used at the recommended dosage, the pigmented admixture has no effect on or increases the compressive strength of the concrete by 5-10% when compared with a control batch of the same mix design and slump but without the Pigmented Admixture. Testing shall be done at 28 days after depositing, and shall be measured in pounds per square inch. The test results shall be an average of at least three (3) cores of cylinders per test.

Calcium Chloride shall not be used in the composition of the admixture nor in the composition of the concrete.

The Pigmented Admixture shall be packaged by the manufacturer in incremental amounts by weight for a single

DIVISION VII - DETAILED SPECIFICATIONS –
CONTRACT SEQ200436 / HWQ121B4

cubic yard of concrete, with the designated dosage clearly marked on each package.

Air entraining agent complying with ASTM Designation C260 shall be used in combination with the Pigmented Admixture.

No other agents or admixtures shall be used with the Pigmented Admixture in the concrete, unless stated in writing by the manufacturer of the Pigmented Admixture to be of no consequence to the colorfastness of the concrete mixture.

The Pigmented Admixtures shall be mixed and delivered in accordance with ASTM Designation C 94.

The same type and brand of cement, source of sand and water/cement ration shall be maintained for each load of concrete used in the entire project.

The slump of the concrete shall remain consistent throughout the project at four inches. If held-back water is added at the job site, the concrete should be mixed at mixing speed for an additional five minutes after addition of the water and before depositing.

The Contractor shall furnish for approval and on site a concrete sample for each color specified using the Pigmented Admixture. The sample shall be at least 4' x 4' x 4" and shall be given the specified surface texture and cured with the methods specified for the concrete installation. The Contractor shall not order the admixture until the samples are approved by the Engineer. Once approved, the samples shall be used for assessing color conformance of pigmented concrete installed.

Water must not be sprinkled or otherwise added to the surface of the slab during finishing. Evaporation retardants may be fog-sprayed provided they are not detrimental to the finished color of the concrete.

8.13.1 Curing Membrane

If the concrete is pigmented as per this Section, the curing membrane shall be of the liquid-membrane forming type and shall be color-matched to the pigmented concrete. Additionally, the curing membrane shall be of a type recommended by the Pigmented Ad mixture manufacturer and shall conform to both ASTM C309 and all local, State, and Federal regulations concerning volatile organic compounds (VOC). Plastic sheeting,

DIVISION VII - DETAILED SPECIFICATIONS –
CONTRACT SEQ200436 / HWQ121B4

burlap, paper, or other unspecified material shall not be used as a curing membrane.

Prior to making any field samples and the placing of any colored concrete, the Contractor, concrete supplier, engineer-in-charge, and/or city representative shall meet and discuss methods of handling the colored concrete.

8.13.2 Measurement and Payment

The quantity to be measured for payment under this Section shall be the total number of cubic yards of approved additional or requested concrete placed as directed by the Engineer.

The contract price per cubic yard of approved structural and nonstructural concrete shall be as indicated on the BID SCHEDULE OF PRICES, Item No. BMP-7.103-A (Non-Structural). The bid price shall constitute full compensation for all labor, materials, equipment and work incidental thereto, necessary to complete this item in accordance with the plans and specifications to the satisfaction of the Engineer.

10.4 Rubbed Finishes

The following shall be produced on concrete which has met the requirements of smooth form finish (Section 10.3.2).

10.4.1 Smooth Rubbed: Where this finish is required, it shall be applied no later than one day following form removal. No rubbing shall be done before the concrete is thoroughly hardened and the mortar used for patching is firmly set. A smooth, uniform surface shall be obtained by wetting the surface and rubbing it with a carborundum brick or other abrasive to eliminate irregularities until uniform color and texture are produced. Unless the nature of the irregularities requires it, the general surface of the concrete shall not be cut into. Corners and edges shall be slightly rounded by the use of the carborundum brick. Brush finishing or painting with grout or neat cement will not be permitted.

10.5.2 Smooth Rubbed Finish (Section 10.4.1) - for all other exterior surfaces and interior vertical surfaces.

10.5.3 Smooth Form Finish (Section 10.3.2) - for all other interior overhead surfaces exposed to public view and interior walls of tanks/culverts.

DIVISION VII - DETAILED SPECIFICATIONS –
CONTRACT SEQ200436 / HWQ121B4

10.5.4 Grout Cleaned Finish (Section 10.4.2) - for all exposed surfaces to be painted.

* * * * *

DIVISION VII - DETAILED SPECIFICATIONS –
CONTRACT SEQ200436 / HWQ121B4

7.104 STEEL REINFORCEMENTA. Description of Work

1. The Contractor shall furnish and install all reinforcing steel as indicated on the Contract Drawings and specified herein.

2. General Requirements

- a. General Specifications - Steel reinforcement, electrically welded mesh and steel wire shall conform to the requirements of Chapter 5 - General Specification 11, - Concrete, November 1991 and the Standard Sewer Specifications, December 1996.

Metal chairs, ties or wires shall not extend to the concrete surfaces. Approved form ties shall provide deep recesses which shall be carefully filled with grout after forms are stripped.

- b. Shop Drawings - The Contractor shall submit to the Engineer for approval, shop drawings and other material required to substantiate conformance with the requirements set forth on the Contract Drawings and the Specifications. Shop drawings shall include, but not be limited to the requirements of General Specification 11 - Concrete.

Detailed placing and shop fabricating drawings, prepared in accordance with ACI 315 shall be furnished for all concrete reinforcement. These drawings shall be made to such a scale as to clearly show construction joint locations, openings, the arrangement, spacing and splicing of the bars. No materials shall be cut or fabricated until related drawings have been approved by the Engineer.

- c. Submittals - The Contractor shall also submit the following:

- 1) Mill test certificates.
- 2) A description and sample of the reinforcing steel manufacturer's marking pattern.

DIVISION VII - DETAILED SPECIFICATIONS –
CONTRACT SEQ200436 / HWQ121B4

- 3) Request to use mechanical couplers along with manufacturer's literature on mechanical couplers with instructions for installation, and certified test reports on the couplers capacity.

B. Execution

1. General Information - The Contractor shall install under this Section of the Detailed Specifications all steel reinforcement required for a complete installation for the structural work of this Contract. Bar sizes shall be as indicated on the Contract Drawings except as otherwise ordered or approved by the Engineer.
2. Materials and Installation - The steel reinforcement shall conform to the requirements as hereinbefore specified and to General Specification 11 – Concrete, Chapter 5 - Reinforcement. Reinforcing bars shall be deformed new billet steel bars conforming to ASTM A615, Grade 60. Wire mesh reinforcement shall conform to ASTM A185.
3. Welding - Wherever welding of reinforcing rods to other reinforcement or structural shapes is indicated, the welding of reinforcing steel shall conform to General Specification 11 – Concrete, Chapter 5.
4. Coiled Reinforcing – Shall not be permitted.
5. Mechanical Couplers – Hot-forged sleeve type couplers shall not be used.
6. Dowel Adhesive System - Where shown on the Drawings, reinforcing bars anchored into hardened concrete with a dowel adhesive system shall use a two-component adhesive mix which shall be injected with a static mixing nozzle following manufacturer's instructions. Thoroughly clean drill holes of all debris and drill dust with wire brush prior to installation of adhesive and reinforcing bar. The embedment depth of the bar shall be per manufacturer's recommendations, so as to provide a minimum allowable bond strength that is equal to 125 percent of the yield strength of the bar, unless noted otherwise on the Drawings. Engineer's approval is required for use of this system in locations other than those shown on the Drawings.
7. Delivery, Storage and Handling

DIVISION VII - DETAILED SPECIFICATIONS –
CONTRACT SEQ200436 / HWQ121B4

- a. All reinforcing shall be neatly bundled and tagged for placement when delivered to the job site. Bundles shall be properly identified for coordination with mill test reports.
- b. Reinforcing steel shall be stored above ground on platforms or other supports and shall be protected from the weather at all times by suitable covering. It shall be stored in an orderly manner and plainly marked to facilitate identification.
- c. Reinforcing steel shall at all times be protected from conditions conducive to corrosion until concrete is placed around it.

8. Placing

- a. Reinforcing steel shall be accurately positioned as shown on the Drawings and shall be supported and wired together to prevent displacement, using annealed iron wire ties or suitable clips at intersections. All reinforcing steel shall be supported by concrete, plastic or metal supports, spacers or metal hangers which are strong and rigid enough to prevent any displacement of the reinforcing steel. Where concrete is to be placed on the ground, supporting concrete blocks (or dobies) shall be used in sufficient numbers to support the reinforcing bars without settlement. In no case shall concrete block supports be continuous.
- b. The portions of all accessories in contact with the formwork shall be made of plastic or steel coated with a 1/8 inch minimum thickness of plastic which extends at least 1/2 inch from the concrete surface. Plastic shall be gray in color.
- c. Tie wires shall be bent away from the forms in order to provide the specified concrete coverage.
- d. Reinforcing bars additional to those shown on the Drawings, which may be found necessary or desirable by the Contractor for the purpose of securing reinforcing in position, shall be provided by the Contractor at no additional cost to the City.

DIVISION VII - DETAILED SPECIFICATIONS –
CONTRACT SEQ200436 / HWQ121B4

- e. Reinforcing placing, spacing, and protection tolerances shall be within the limits specified in ACI 318 except where in conflict with the Building Code, unless otherwise specified.
- f. Reinforcing bars may be moved within one bar diameter as necessary to avoid interference with other concrete reinforcing, conduits, or embedded items. If bars are moved more than one bar diameter, or enough to exceed placing tolerances, the resulting arrangement of bars shall be as acceptable to the Engineer.
- g. Welded wire fabric shall be supported on slab bolsters spaced not less than 30 inches on centers, extending continuously across the entire width of the reinforcing mat and supporting the reinforcing mat in the plane shown on the Drawings.
- h. Bars with kinks or bends not shown on the Drawings shall not be used.

9. Splicing

- a. The length of lap for reinforcing bars, unless otherwise shown on the Drawings shall be in accordance with ACI 318 for a class B splice.
- b. Laps of welded wire fabric shall be in accordance with ACI 318. Adjoining sheets shall be securely tied together with No. 14 tie wire, one tie for each 2 running feet. Wires shall be staggered and tied in such a manner that they cannot slip.
- c. Mechanical splices shall be used only where shown on the drawings or when approved by the Engineer.
- d. Couplers which are located at a joint face shall be a type which can be set either flush or recessed from the face as shown on the Drawings. The couplers shall be sealed during concrete placement to completely eliminate concrete or cement paste from entering. After the concrete is placed, couplers intended for future connections shall be plugged and sealed to prevent any contact with water or other

DIVISION VII - DETAILED SPECIFICATIONS –
CONTRACT SEQ200436 / HWQ121B4

corrosive materials. Threaded couplers shall be plugged with plastic plugs which have an O-ring seal.

C. No Separate Payment

No separate payment shall be made for this work of this specification. All costs shall be included in the various Contract Items of this Contract.

* * * * *

DIVISION VII - DETAILED SPECIFICATIONS –
CONTRACT SEQ200436 / HWQ121B4

7.105

WELDING

A.

Description of Work

1. The Contractor shall perform all welding as indicated on the Contract Drawings and as specified herein.

B.

General Requirements - All welding shall be in accordance with specified standards as modified or supplemented by these Specifications. No welding shall be done when the base-metal temperature is lower than 32 degrees Fahrenheit. The subcontractor shall be responsible for the quality of the welding and shall set up and record procedures for welding all metals included in the work. Welding shall not be started until procedure, welders, and welding operators have been qualified by tests and copies of all records and reports submitted for approval. Costs of such testing shall be borne by the Contractor. Each weld shown or indicated on the Contract Drawings shall be made as specified on the approved procedure specifications provided to cover each type of weld. Welding of any special steel shall adhere, without deviation, to the written instructions of the steel manufacturer.

1. Welded Construction - Welded construction shall be used only where indicated on the Contract Drawings and approved shop drawings. The AWS Specification D1.1 (latest edition) Structural Welding Code or AWS D1.4 (latest edition) Structural Welding Code - Reinforcing Steel, as applicable and other requirements of this Section shall apply to the welded joints. Unless otherwise specified, welding shall be by automatic submerged arc or semi-automatic submerged arc,
2. Test Specimens - Test specimens shall be prepared by the Contractor for each type of welded joint as designated in paragraph entitled Procedure Qualification. Destructive tests of specimens for procedure and welder qualifications shall be conducted in accordance with AWS D1.1, Section 4, Qualifications, and the requirements specified herein.
3. Groove Welds - All groove welds shall be 100 percent complete penetration welds as defined in AWS D1.1 or shown in AWS D1.4 for reinforcing steel, regardless of whether a backup plate is shown, or whether the supplementary backing weld or melt-through symbol is included, in each groove-weld symbol shown, unless partial penetration is included in the weld symbol.

C.

Welding Procedure

DIVISION VII - DETAILED SPECIFICATIONS -
CONTRACT SEQ200436 / HWQ121B4

1. General Information - Welding procedures and procedure qualification tests shall be required for all welding covered by this specification to demonstrate that the combination of process, material, and technique produces the desired welds. These procedures, when qualified, become the welding procedure specification which must be followed in making weldments on materials within ranges shown in the Contract Drawings (and Specifications), and provide a means of assuring reproducible results and quality control. Procedure specifications and procedure qualification test results shall be kept by the Contractor and shall be available for examination by the Engineer. Five copies of the procedure specifications and test results shall be submitted for approval. Welding procedure specifications and tests shall be individually identified or completed on the shop details and erection drawings. Welding shall not be performed on any contract item before approval of procedure specification and qualification testing by the Engineer.
 - a. Welding Procedure Specification - A separate Procedure Specification shall be prepared for each type of weld which varies in accordance with the definition of essential changes as listed in AWS D1.1, Section 5.
 - b. Procedure Qualification - Each type of weld made by a specific process shall be qualified by tests as specified in AWS D1.1 or as specified herein for reinforcing steel.
 - c. Procedure Specification Requalification - When an essential variable, as specified in AWS D1.1, is changed, the procedure must be requalified.
 - d. Dissimilar Steels - Where dissimilar steels are welded together, the procedure shall be the same as for the lower-strength steel.
 - e. Groove Welds - All groove welds shall be 100 percent complete penetration welds as defined in AWS D1.1 or shown in AWS D1.4 for reinforcing steel, regardless of whether a backup plate is shown, or whether the supplementary backing weld or melt-through symbol is included, in each groove-weld symbol shown, unless partial penetration is included in the weld symbol.
 - f. Welded Studs - Gun welded studs shall conform with the requirements of AWS D1.1, Section 7.

DIVISION VII - DETAILED SPECIFICATIONS –
CONTRACT SEQ200436 / HWQ121B4

- g. Electrodes - Electrodes for structural steel welding shall conform with AWS D1.1, Section 4, as applicable.

D. Performance Certification Of Welders And Welding Operators

1. General Information - Each welder and welding operator assigned to work on this Contract shall be certified in conformance with AWS D1.1, the requirements of this Specification. Welders shall be New York City certified, and all welding shall be done in conformity with the New York City Building Code.
 - a. Welder's Certificates - Upon completion of the applicable qualification tests, each welder and welding operator shall be provided with a certificate by the Contractor. The certificate shall state the type of welding and positions for which he is qualified, the code under which he is qualified, and the firm or individual certifying the qualification tests. The certificate shall be kept on file at the job site by the Contractor and shall be made available for examination and approval by the Engineer. The certificate will remain in effect except when requalification of the welder or welding operator is required as specified in AWS D1.1 and the requirements of this Specification.
 - b. Welder's Identification - The Contractor shall assign each welder identifying number, letter, or symbol which shall be used by the welder to identify all welds made by him. For identification, the welder shall lightly stamp his symbol adjacent to the weld by means of a metal stamp.
 - c. Welder's Record - The Contractor shall maintain a record of all welders and welding operators employed on the Contract showing the date and results of tests and the identification mark assigned to each welder. These records shall be certified by the Contractor and made accessible to authorized personnel. Copies of the record shall be furnished to the Engineer.
 - d. Technique - Technique shall conform to AWS Specification D1.1, Section 4, entitled Technique, and the requirements of this Specification.

E. Supervision

All shop and field welding shall be under the immediate supervision of a representative of a standard testing agency or an approved inspection

DIVISION VII - DETAILED SPECIFICATIONS –
CONTRACT SEQ200436 / HWQ121B4

agency reporting directly to, and under the control of, the Department of Design and Construction. The Contractor shall submit the name of such agency to the Commissioner for approval before starting work. The costs of all welding inspections and tests shall be borne by the Contractor.

F. Inspection and Tests During Construction

The Engineer will make periodic checks of each welder to determine that welds are being made as specified in the approved procedure specifications. Welding speed may be estimated. All welds will receive 100 percent visual inspection by the Engineer to determine weld size and profile, surface cracks, overlap, and undercut. The Engineer reserves the right to perform any test on any weld, including liquid penetrant, magnetic particle, radiographic, and ultrasonic.

G. Acceptance Requirements

1. Welds, other than stud welds, are acceptable if inspection indicates conformance within the following limitations:
 - a. Cracks - All welding exhibiting any cracks, either in the weld metal or the parent metal, will be rejected.
 - b. Undercut - Undercut shall not be more than 1/32 inch deep.
 - c. Convexity or Reinforcement - Convexity or reinforcement of a weld face shall not exceed the limits shown in AWS D1.1, and there shall be no overlap.
 - d. Fusion - Incomplete fusion or lack of penetration will not be allowed.
 - e. Small Inclusions - Slag inclusions, porosity, and other fusion defects less than 1/16 inch in greatest dimension will be allowed if well dispersed and the sum of the greatest dimensions in any linear inch of welded joint does not exceed 3/8 inch.
 - f. Large Inclusions - Slag inclusions, porosity, and other fusion defects 1/16 inch or larger in greatest dimension will be allowed providing such defects do not exceed the limits specified in AWS D1.1.

H. Repair of Defective Welds

DIVISION VII - DETAILED SPECIFICATIONS –
CONTRACT SEQ200436 / HWQ121B4

1. In lieu of rejection of an entire piece or member containing welding which is unsatisfactory or which indicates inferior workmanship, the corrective measures listed hereunder may be permitted by the Engineer whose specific approval shall be obtained for making each correction. Corrective measures shall be made at the Contractor's expense and to the satisfaction of the Engineer and/or an acceptable independent testing lab
2. Defective or Unsound Welds or Base Metal - Defective or unsound welds or base metal shall be corrected either by removing and replacing the entire welds, or as follows:
 - a. Convexity and Overlap - Excessive convexity and overlap, defined in paragraph Acceptance Requirements, shall be reduced by removal of excess weld metal.
 - b. Concavity - Any concavity of weld, crater, undersize welds, undercutting: clean and deposit additional weld metal.
 - c. Discontinuities - Excessive weld porosity, slag, inclusions, defined in the paragraph entitled Acceptance Requirements, and incomplete fusion: remove defective portions and reweld.
 - d. Cracks - Cracks in weld or base metal: remove crack throughout its length, including sound weld metal 2 inches beyond each end of the crack; follow by the required rewelding.
3. Removal - The removal of weld metal or portions of the base metal shall be done by chipping, grinding, oxygen cutting, oxygen gouging, or air carbon-arc and in such a manner that the remaining weld metal or base metal is not nicked or undercut. Defective portions of the weld shall be removed without substantial removal of the base metal.
4. Additional Metal - Additional weld metal shall be deposited using an electrode smaller than that used for making the original weld, and not more than 5/32 inch diameter. The surface shall be cleaned thoroughly before welding.
5. Inaccessibility - Where work performed subsequent to the making of a deficient weld has rendered the weld inaccessible or has caused new conditions which would make the correction of the deficiency dangerous or ineffectual, the original conditions shall be

DIVISION VII - DETAILED SPECIFICATIONS –
CONTRACT SEQ200436 / HWQ121B4

restored by removing the welds or members, or both, before making the corrections, or the deficiency shall be compensated for by additional work done according to an approved revised design.

6. Caulking - Caulking of welds shall not be permitted.
7. Improper Fit - Improperly fitted parts may be cut apart and rewelded. Members distorted by welding shall be straightened by mechanical means or by carefully supervised application of a limited amount of localized heat. The temperature of heated areas shall not exceed 1,200 degrees F (a dull red color). Temperature shall be carefully measured with temperature indicating crayons during the heating operation. Parts to be heated for straightening shall be substantially free of stress and from external forces, except those stresses resulting from mechanical means used in conjunction with the application of heat.
8. Peening - No peening shall be done on the root or surface layers of a weld. Peening of intermediate weld layers may be used only if authorized by the Engineer and directed by him. Care shall be exercised to prevent overpeening which may cause overlapping, scaling, cracking, flaking, or excessive cold working of weld and base metal.

I. No Separate Payment

No separate payment shall be made for this work of the specification. All costs shall be included in the various Contract Items of this Contract.

* * * * *

DIVISION VII - DETAILED SPECIFICATIONS –
CONTRACT SEQ200436 / HWQ121B4

7.106 OUTLET STILLING BASIN

NO TEXT ON THIS PAGE

DIVISION VII - DETAILED SPECIFICATIONS –
CONTRACT SEQ200436 / HWQ121B4

7.107-B RIP-RAP STONE /ANGULAR NATURAL FIELD STONE

A. Description of Work

Under this item, the Contractor shall perform all work necessary to install rip-rap stone or angular natural field stone where directed by the Engineer, to protect the soil surface from erosive forces and/or improve the stability of soil slopes as well as water feature bottoms that are subject to seepage or have poor soil structure.

In general, rip-rap stone shall be utilized for both temporary and permanent constructed features such as erosion control features, channel side slopes and bottoms, grade sills, slope drains, grade stabilization structures, storm drains, and cut and fill slopes subject to seepage, erosion or weathering, particularly where conditions prohibit the establishment of vegetation.

Angular natural field stone shall be utilized to stabilize, reinforce or restore naturally occurring features as well as features that are intended to appear natural, such as stream side slopes, banks and bottoms, wetlands, shorelines subject to erosion, culvert inlets and outlets, outlet stilling basins and natural upland side slopes.

Rip-rap stone may be substituted with angular natural field stone as directed by the Engineer. The Contractor may use field stones excavated in the project site, contingent upon the approval of the Engineer.

B. Materials Used

Rip-Rap Stones/Angular Natural Field Stones

Stones shall be a well-graded mixture with 50% by weight larger than the specified design size. The diameter of the largest stone size in such a mixture shall be 1.5 times the d50 size with smaller sizes grading down to 1 inch. The stone size installed shall be as directed by the Engineer and as shown on the Contract Drawings.

The minimum layer thickness shall be 1.5 times the maximum stone diameter, but in no case less than 6 inches or as specified on the Contract Drawings.

Stones for rip-rap shall be hard, durable quarry materials. Stones used for natural field stones shall be hard, durable field materials and shall be dark in coloration. They shall be angular and not subject to breaking down

DIVISION VII - DETAILED SPECIFICATIONS –
CONTRACT SEQ200436 / HWQ121B4

when exposed to water or weathering. The specific gravity shall be at least 2.5.

Stones shall be free of decomposed stone, clay rock dust and other objectionable material. Existing stone walls and broken concrete or recycled stone shall not be used as stones. Broken concrete is not acceptable.

C. Construction Methods

Subgrade Preparation

Prepare the subgrade for stones to the required lines and grades shown on the plans. Compact any fill required in the subgrade to a density approximating that of the undisturbed material or overfill depressions with stones. Remove brush, trees, stumps and other objectionable material. Cut the subgrade sufficiently deep so that the finished grade of the stones will be at the elevation of the surrounding area. Channels shall be excavated sufficiently to allow placement of the stones in a manner such that the finished inside dimensions and grade of the stones meet design specifications.

Rip-Rap/Angular Natural Field Stone Placement

Placement of the stones shall follow immediately after placement of the filter. Place stones so that it forms a dense, well-graded mass of stone with a minimum of voids. The desired distribution of stones throughout the mass shall be obtained by selective loading at the quarry and controlled dumping during final placement. Place stones to its full thickness in one operation. Do not place stones by dumping through chutes or other methods that cause segregation of stone sizes. Be careful not to dislodge the underlying base or filter when placing the stones.

The toe of the stones shall be keyed into a stable foundation at its base as shown on the Contract Drawings. The toe shall be excavated to a depth of 2.0 feet. The design thickness of the stones shall extend a minimum of 3 feet horizontally from the slope. The finished slope shall be free of pockets of some stone or clusters of large stones. Hand placing will be required to achieve proper distribution of stone sizes to produce a relatively smooth, uniform surface. The finished grade of the stones shall blend with the surrounding area.

D. Measurement and Payment

DIVISION VII - DETAILED SPECIFICATIONS –
CONTRACT SEQ200436 / HWQ121B4

The quantity to be measured for payment under this Section shall be the total number of cubic yards of approved stones, measured in stockpiles, containers and/or vehicles and placed as directed by the Engineer.

The contract price per cubic yard of approved stone material placed shall be as indicated on the BID SCHEDULE OF PRICES Item No. BMP-7.107-B. The bid price shall constitute full compensation for all labor, materials, equipment and work incidental thereto, necessary to furnish, place and incorporate and all other work incidental thereto, in accordance with the plans and specifications to the satisfaction of the Engineer.

* * * * *

DIVISION VII - DETAILED SPECIFICATIONS –
CONTRACT SEQ200436 / HWQ121B4

7.108-A ALUMINUM GRATING

NO TEXT ON THIS PAGE

DIVISION VII - DETAILED SPECIFICATIONS –
CONTRACT SEQ200436 / HWQ121B4

7.109 GEOTEXTILE FABRIC

A. Description of Work

Under this item, the Contractor shall furnish all equipment and perform all work necessary to place geotextile fabric as indicated in the Contract Drawings and specifications and as directed by the Engineer.

B. Construction Methods

The geotextile fabric shall be Enkadrain 9120 or equivalent with the following specifications:

<u>Property</u>	<u>Test Method</u>	<u>Unit</u>	<u>Specification</u>
Material	Non-woven geotextile fabric		
Unit Weight	ASTM D1777	oz/sq. yd	4.3 (min)
Flow Rate	Falling Head Test	gpm/sq. ft.	120 (min)
Puncture	ASTM D751	lbs.	60 (min)
Thickness		in.	0.8 (min)

C. Measurement and Payment

The quantity to be measured for payment under this Section shall be the number of square feet of surface area on which Geotextile Fabric has been installed in accordance with the plans and specifications and directions of the Engineer.

The contract price per square foot of approved Geotextile Fabric installed shall be as indicated on the BID SCHEDULE OF PRICES Item No. BMP -7.109. The bid price shall constitute full compensation for all labor, materials and equipment required to place the geotextile fabric in the mitigation area and to protect trees near the BMP in accordance with the plans and specifications to the satisfaction of the Engineer.

D. No Separate Payment

All costs for all labor, materials and equipment required to place the geotextile fabric under the concrete structures shall be deemed included in the price bid under detailed specifications for concrete structures Section 7.129.

* * * * *

DIVISION VII - DETAILED SPECIFICATIONS –
CONTRACT SEQ200436 / HWQ121B4

7.110 SHEETING AND BRACING

A. Description of Work - The Contractor shall furnish and install sheeting together with all bracings as required for excavations in accordance with the provisions contained herein.

B. General Requirements

1. Shop Drawings - The Contractor shall submit to the Engineer for approval, shop drawings and other material required to substantiate conformance with the requirements set forth on the Contract Drawings and these Specifications.
2. Calculations - The Contractor shall submit to the Engineer for approval design calculations of his proposed sheeting and bracing plan. Such calculations shall incorporate all applicable loads as per the New York City Building Code and shall be signed and sealed by a New York State licensed professional engineer. The Contractor shall include with the calculations his detailed plan of operation as regards to the installation of the sheeting, method of excavation and removal of sheeting for the review by the Engineer.
3. The Contractor shall have at least three (3) projects similar in scope and type within the last five years in driving sheet piles.
4. The Contractor shall be responsible for the adequacy of all sheeting and bracing and for all damage resulting from sheeting and bracing failure or from placing, maintaining and removing it.

C. Construction Sheeting

1. General - Sheeting required by the Contractor for sheeting excavations, etc. shall be designed and submitted by the Contractor for the Engineer's review. Sheeting shall be removed at the conclusion of construction unless otherwise indicated or approved by the Engineer. Sheeting shall be either steel or wood sheeting as specified herein below.
2. Steel Sheeting - Sheeting shall conform to the requirements of ASTM A328. Sheet piles shall be new and shall be of the continuous interlock type of the section, length and weight shown on the Contract Drawings.
3. Structural steel and other accessories such as walers, braces, tie-rod assemblies, plates and similar members used with sheet piling shall conform to ASTM A36.

DIVISION VII - DETAILED SPECIFICATIONS –
CONTRACT SEQ200436 / HWQ121B4

4. Fastening - Bolts, nuts and washers shall conform to the requirements of ASTM A325 or A307. Connections shall be provided by the Contractor in accordance with AISC Specification for the Design, Fabrication and Erection of Structural Steel. Connections shall be subject to the Engineer's approval. Welding shall conform to the requirements of Detailed Specification 7.106, Welding.
5. Wood Sheeting - Timber of wood sheeting shall be Douglas Fir standard grade or Southern Yellow Pine No. 25R with extreme fiber unit bending stress not less than 1200 psi. All lagging shall be full size lumber (undressed), and shall be sound, free from shakes, large knots, and other defects which might impair its strength. Used timber may be furnished if equal in strength to that of corresponding new timber. Where conditions require tight sheeting to prevent loss of ground, tongue and groove wood sheeting shall be used.
6. Sheeting to be Left in Place - Construction sheeting to be left in place shall be indicated on the drawings. The Contractor shall cut off piling 2 ft. below ground surface or to the grades shown on the Contract Drawings.
7. Bracing and Anchorage - Bracing and anchorage shall be shown on the shop drawings.
8. Installation - The Contractor shall examine the areas and conditions under which steel sheet piling is to be installed. The Contractor shall notify the Engineer in writing of conditions detrimental to the proper and timely completion of the work. The Contractor shall not proceed with work until unsatisfactory conditions have been corrected in a manner acceptable to the Engineer.

D. No Separate Payment

All costs for the installation of sheeting and bracing performed in conjunction with the construction and installation of concrete structures will be included under the unit bid price for Concrete Structures Section 7.129. All costs for the installation of sheeting and bracing performed in conjunction with the construction of the mitigation area will be included under the unit bid price for Excavation Section 7.304-A.

* * * * *

DIVISION VII - DETAILED SPECIFICATIONS –
CONTRACT SEQ200436 / HWQ121B4

7.111 VALVES

NO TEXT ON THIS PAGE

DIVISION VII - DETAILED SPECIFICATIONS –
CONTRACT SEQ200436 / HWQ121B4

7.112

STONE PIERS FOR PEDESTRIAN/VEHICLE ENTRANCE

NO TEXT ON THIS PAGE

DIVISION VII - DETAILED SPECIFICATIONS –
CONTRACT SEQ200436 / HWQ121B4

7.113 MISCELLANEOUS PIPING

NO TEXT ON THIS PAGE

DIVISION VII - DETAILED SPECIFICATIONS –
CONTRACT SEQ200436 / HWQ121B4

7.114 STEEL WEIR PLATES

NO TEXT ON THIS PAGE

DIVISION VII - DETAILED SPECIFICATIONS –
CONTRACT SEQ200436 / HWQ121B4

7.114-B

FRP WEIR PLATES

NO TEXT ON THIS PAGE

DIVISION VII - DETAILED SPECIFICATIONS –
CONTRACT SEQ200436 / HWQ121B4

7.115 HOODS

NO TEXT ON THIS PAGE

DIVISION VII - DETAILED SPECIFICATIONS –
CONTRACT SEQ200436 / HWQ121B4

7.116

ALUMINUM SLIDE GATE

NO TEXT ON THIS PAGE

DIVISION VII - DETAILED SPECIFICATIONS –
CONTRACT SEQ200436 / HWQ121B4

7.117 GRAFFITI RESISTANT COATINGA. Description of Work

Under this Item, the Contractor shall furnish and apply Graffiti Resistant Coating to exterior stone, concrete, wood or other surfaces in accordance with OSHA guidelines, manufacturer's recommendations and the plans, specifications and directions of the Engineer.

B. General

The Contractor shall apply Graffiti Resistant Coatings as follows:

1. For previously painted masonry, concrete (vertical surfaces) and bethabara wood (both painted and unpainted), metal surfaces (both painted and unpainted), apply Graffiti Solution System (G.S.S.) manufactured by American Polymer Corporation, ARMAGLAZE, 9000 manufactured by Aquarius Coating, Inc., or approved equal
2. For new and unpainted masonry and concrete, the Contractor shall apply Professional Water Sealant & Anti-Graffiti, manufactured by Professional Products of Kansas, Inc., Blok-Guard & Graffiti Control Ultra manufactured by Prosoco, Inc., or approved equal.

C. Quality Assurance

Graffiti Resistant Coating shall be applied only by an approved installer per installation instructions who shall be trained by the manufacturer of each respective product and shall be certified by the manufacturers as qualified to install materials specified for this project. Only qualified Contractors or Subcontractors and their trades persons, meeting the above requirements shall be deemed approved. Submit a copy of current SSPC Certificate if applicable.

D. Product Delivery, Storage and Handling

1. The Contractor shall deliver materials in sufficient quantity to allow for continuity of work. Protect all materials and equipment during transit, delivery, storage and handling to prevent damage and deterioration.
2. Avoid fire; open flame and sparks. Container contents, even when empty, may ignite explosively when exposed to heat, welding, cutting torch, pilot lights and other flames and ignition sources at locations distant from the material storage and handling point.

DIVISION VII - DETAILED SPECIFICATIONS –
CONTRACT SEQ200436 / HWQ121B4

3. Avoid inhalation, ingestion, skin contact, and eye contact.
4. Protect shrubs, plants and grass during application. Avoid wind drift which may injure passersby or damage vehicles and adjacent properties.
5. For additional cautions, human health data and protective equipment to be used (including respiratory) refer to Material Safety Data Sheets.
6. Containers shall be kept closed when not in use.
7. Dispose of excess waste materials and empty containers in accordance with all local, state and federal regulations. Empty containers as may be classified as hazardous; they retain product residues such as vapor, liquid or solid. Do not transfer contents into other containers for storage.

E. Products

1. "G.S.S" Coatings. Note: This coating shall be applied to surfaces listed under "General" heading of this Specification (i.e. previously painted masonry, concrete and wood surfaces and metal surfaces both painted and unpainted).
 - a. G.S.S. Barrier Standard: Sealer product; standard undercoat - not high solids version. This Standard version shall be used with Clear overcoat. Barrier shall be applied over painted porous surfaces (not metal)¹
 - b. G.S.S. Barrier High Solids: Shall be used with Pigmented top coat. The high solids version is not recommended for use with clear top coating. High solids barrier consists of a one component, acrylic copolymer coating (see Manufacturer's Product Guide for more information).
 - c. G.S.S. 10 Clear Coating (Low VOC): Anti-graffiti product; overcoat G.S.S. 10 consists of a polymer composition; two (2) component resin and catalyst system. It is a non-sacrificial permanent coating with flat/matte finish. G.S.S. 10 Part A is premeasured to use for Part B.

¹For steel and aluminum surfaces, in lieu of G.S.S.-Barrier, use a water-borne urethane primer such as Bond-Plex, manufactured by Sherwin-Williams Company; or approved equal.

DIVISION VII - DETAILED SPECIFICATIONS –
CONTRACT SEQ200436 / HWQ121B4

- d. G.S.S. Pigmented Coating: Anti-graffiti product; top coat. Two (2) component polyurethane, non-sacrificial, protective coating. Color shall be selected from either the manufacturer's standard color guide or Sherwin-William Industrial and Marine Coatings, System 4000 color chart or approved equal. Finish shall be flat/matte (not gloss) unless otherwise noted. (pigmented coating shall be used in lieu of clear coating when previously painted substrate is not uniform in color and requires concealing with an opaque top coat.)
2. P.W.S. Coatings: Note: This coating shall be applied to surfaces listed under "General" heading above (i.e. new and unpainted masonry and unpainted concrete).

F. Execution

1. Surface Preparation
 - a. Surfaces shall be thoroughly dry, cleaned and free of dust, surface dirt, oil, grease and other contaminants that might prevent penetration of the coatings. Newly constructed surfaces, repointed surfaces and concrete shall be cured for at least 28 days before application. Glossy, glazed and slick troweled surfaces should be lightly etched or abraded before application of coatings. Surface defects, voids, joints or cracks must be properly sealed or filled, allowing any patching compounds to be completely cured before application. Cleaning may be accomplished by high pressure washing, sand blasting or chemical cleaning. When chemicals are used, they should be removed by high pressure water cleaning before application of the sealant. Use of raw acids shall not be permitted. Allow cleaned surfaces to dry completely. A test must always be made prior to application using the same cleaning and application procedures as to be used on the project. This test area shall remain available to be inspected by the Engineer.

G. Application Procedures

1. General product application must not be initiated during inclement weather, or when precipitation appears imminent. Application should be completed at least four (4) hours before precipitation begins.

DIVISION VII - DETAILED SPECIFICATIONS –
CONTRACT SEQ200436 / HWQ121B4

2. For the G.S.S. Type Coating Systems consisting of both undercoat and topcoat, refer to manufacturer's Application Guide along with information specified herein.
 - a. G.S.S. Barrier Undercoat sealer shall only be applied when temperature is between 50°F and 95°F. The surface to receive Barrier shall be visibly dry and relative humidity shall be such that condensation does not form on the surface during application.
 - b. Apply two (2) coats of Standard Barrier Undercoat (3 to 4 mils total) over all previously painted masonry and wood surfaces using either brush, roller or spray. Ensure that the coatings are applied evenly and built up sufficiently to create a protective layer over the underlying surface and to eliminate any future "shadowing" or "ghosting" which would appear after the graffiti removal if the surface is not adequately sealed and coated. Barrier shall be applied creating a pinhole-free surface. Allow 1 to 2 hours between coatings. Avoid over-application of Barrier coating to avoid pooling or puddling which can result in permanent whiting. Application of Barrier in direct sunlight can also result in permanent whiting.
 - c. G.S.S. 10 Overcoats shall be applied over G.S.S. Barrier undercoat. Prior to installation of overcoats, the barrier coats shall be allowed a minimum of 12 hours drying time. Moisture shall not be permitted on undercoating prior to application of G.S.S. 10 coating. G.S.S. 10 shall be activated by mixing parts A and B. These two portions have been premeasured at a precise ratio. The Contractor shall not mix at any other ratio and shall not add thinner or water. Part B shall be poured into Part A container. While mixing together, stir well with a lifting motion to ensure that the two parts are well balanced. If the coating must be thinned for application purposes, thin with MEK only and only after Parts A and B have been mixed together. The coating may be applied by brush, roller or spray. Apply two (2) coats of G.S.S. 10 of 1 to 2 mils thickness each coat. Allow one (1) to two (2) hours before applying the second coat. If using roller, direct the roller upwards from bottom toward top maintaining a wet wedge.
 - d. Coverage rates will vary depending upon porosity of the surface and method of application. Once activated, the coating has a pot life of approximately 4 to 6 hours under

DIVISION VII - DETAILED SPECIFICATIONS –
CONTRACT SEQ200436 / HWQ121B4

normal conditions (80°F or less). The lid shall not be left off the container unnecessarily.

H. For the Professional Water Sealant (P.W.S) Type Cleaning System, refer to Manufacturer's Application Guide along with information specified herein.

1. P.W.S shall be applied only when temperature is between 60°F and 80°F and relative humidity is 50%. Under these ideal weather conditions, the coating will dry to the touch in approximately twenty-five (25) minutes. At lower temperatures, drying time will be longer.
2. The coating shall be applied over all new and unpainted masonry, concrete and wood surfaces using a two (2) coat application process, with a drying time of not more than two and one-half (2-1/2) hours between applications.

Curing time will vary depending upon the temperature and humidity conditions. The second coat shall require six (6) to eight (8) hours to develop full graffiti protection.

3. On vertical applications, P.W.S. shall be applied with a low pressure airless sprayer at an angle to allow the sealant to run down the face rather than to penetrate deep into the voids of the substrate. On porous and rough stone surfaces, it shall be necessary to apply a mist coat before flood coating.
4. On horizontal surfaces, such as wooden bench slats, P.W.S. shall be applied by brooming, brushing, rolling or using airless spray equipment. The coating shall not be permitted to puddle or pond. Over-application may cause surface to become slippery when wet. Excess sealant shall be wiped up immediately.
5. For low pressure spray application, the setting shall be about 40 psi to avoid atomization of the material. Spray equipment shall be fitted with stainless steel or brass fittings and gaskets suitable for solvent solution. A fan spray tip of 50E with flow rate of approximately 4/10 of a gallon per minute is recommended. Coatings shall be applied in a saturating spray application from the top down. Apply sufficient material to create a six (6) inch to eight (8) inch rundown below the contact point. Allow the first application to penetrate the masonry surface until dry to the touch. If a second application is required, less material will be needed.

DIVISION VII - DETAILED SPECIFICATIONS –
CONTRACT SEQ200436 / HWQ121B4

6. For brush application, brushes should be nylon or other synthetic material resistant to solvent solution. When applying Professional Water Sealant with a brush, apply sufficient material to thoroughly saturate the surface. Avoid excessive overlapping. Take care of brush out runs and drips, and to avoid buildup of Professional Water Sealant.
7. Container shall be kept tightly sealed until ready to use. Stir thoroughly before use. Product shall not be diluted or altered in any way. Coverage rates will vary depending upon surface porosity and texture. Once opened, Professional Water Sealant must be used within 24 hours.

I. Clean-Up Instructions

Clean application equipment immediately after each use. For G.S.S products, avoid having the G.S.S. 10 coating set up on or inside application equipment, by cleaning frequently with any of the following solvents (do not use solvents other than listed): xylene, lacquer thinner, MEK or n-butyl acetate. If coating has begun to set up and cannot be cleaned with the above, G.S.S. Erasol shall be used for cleaning. All drips and over spray shall be cleaned while still wet. For spraying equipment, cleaning with MEK every one (1) to two (2) hours is recommended. Since G.S.S 10 adheres permanently to surfaces, including human skin, spills shall be cleaned immediately. For P.W.S. products, clean equipment with mineral spirits or paint thinner.

J. Cure Time Required Prior To Remover Use

For G.S.S. products, full curing time required before graffiti can be removed from newly applied protective coating is seven (7) days at ambient temperatures. Curing period is longer during cooler temperatures. A test patch shall be performed during cooler temperatures to determine whether the G.S.S. 10 top coat has cured sufficiently to remove graffiti with Erasol Remover product. Apply a small amount of Erasol Remover product on a clean spot of the coated surface and let it stand for 24 hours undisturbed. When the coating appears to have softened, it has not fully cured. When the coating remains hard, then Erasol may be used to remove graffiti.

K. Graffiti Removal

1. For permissible materials to be used in removing any graffiti which may accumulate during construction contract duration, the Contractor shall refer to listing found under Section 7.116.12 (Extra Materials).

DIVISION VII - DETAILED SPECIFICATIONS –
CONTRACT SEQ200436 / HWQ121B4

2. For graffiti removal procedures, see manufacturer's literature and instructions. Use of chemicals which are not included in manufacturer's list of components for remover system may damage or remove the protective coating, thereby necessitating the reapplication of sealant/coating systems.
3. Use of remover products which are not part of the complete system (i.e. not manufactured by the same companies as protective coatings) will void the 10 year manufacturer's warranties/guarantees.

L. Submittals

1. The Contractor shall submit manufacturer's technical data sheets, vapor transmission testing results and applicable OSHA regulations for storage, handling and application of both the Graffiti Resistant Coatings and Graffiti Remover products to the Engineer for approval.
2. The Contractor shall submit manufacturer's product guarantee/warranty for a period of ten (10) years from the date of purchase, stating that the coatings will allow for the removal of all types of paint and other graffiti materials when same manufacturer's removal product has been used subject to listing of manufacturer's limitations which shall be included with the submittal. Manufacturer and/or its Certified Applicator shall remove the graffiti and recoat the surface at their own expense. The G.C. Contractor shall provide, sealed in plastic, a statement of the warranty with the name, telephone number and address of the manufacturer of the product to be contacted in the event that product fails. G.C. shall forward one (1) copy of the warranty to NYCDDC at the time of final acceptance.
3. The Contractor shall submit written certification from the respective manufacturers of coatings, certifying that installers have been properly trained and are currently approved by the manufacturers to install the specified graffiti resistant coatings. Provide copy of certification to the Engineer prior to start of Contract work.

M. Measurement and Payment

The quantity of graffiti resistant coating to be paid for under this Item shall be the number of square feet of surfaces prepared, coated and cured

DIVISION VII - DETAILED SPECIFICATIONS –
CONTRACT SEQ200436 / HWQ121B4

in accordance with the Contract Drawings, Specifications and directions of the Engineer.

All costs for graffiti resistant coating performed in conjunction with the construction and installation of concrete structures will be included under the unit bid price for Concrete Structures Section 7.129. The bid price shall include the cost of all labor, materials, equipment and incidental expenses necessary to complete the work of furnishing and installing graffiti resistant coatings including surface preparation, application and proper curing of coating and maintenance of surfaces coated throughout contract duration, all in accordance with the plans, specifications and to the satisfaction of the Engineer.

* * * * *

DIVISION VII - DETAILED SPECIFICATIONS –
CONTRACT SEQ200436 / HWQ121B4

7.118 BEEHIVE GRATES

NO TEXT ON THIS PAGE

DIVISION VII - DETAILED SPECIFICATIONS –
CONTRACT SEQ200436 / HWQ121B4

7.119

LADDERS

NO TEXT ON THIS PAGE

DIVISION VII - DETAILED SPECIFICATIONS –
CONTRACT SEQ200436 / HWQ121B4

7.120 TRASH RACK

NO TEXT ON THIS PAGE

DIVISION VII - DETAILED SPECIFICATIONS –
CONTRACT SEQ200436 / HWQ121B4

7.121

MANHOLES, CHAMBERS & CATCHBASINS

NO TEXT ON THIS PAGE

DIVISION VII - DETAILED SPECIFICATIONS –
CONTRACT SEQ200436 / HWQ121B4

7.122 MANHOLE STEPS

NO TEXT ON THIS PAGE

DIVISION VII - DETAILED SPECIFICATIONS –
CONTRACT SEQ200436 / HWQ121B4

7.123

ASPHALT PAVING FOR PATH

NO TEXT ON THIS PAGE

DIVISION VII - DETAILED SPECIFICATIONS –
CONTRACT SEQ200436 / HWQ121B4

7.124 TIMBER STOP LOG

NO TEXT ON THIS PAGE

DIVISION VII - DETAILED SPECIFICATIONS –
CONTRACT SEQ200436 / HWQ121B4

7.125

ACCESS HATCHES

NO TEXT ON THIS PAGE

DIVISION VII - DETAILED SPECIFICATIONS –
CONTRACT SEQ200436 / HWQ121B4

7.126

GRANITE CASCADES

NO TEXT ON THIS PAGE

DIVISION VII - DETAILED SPECIFICATIONS –
CONTRACT SEQ200436 / HWQ121B4

7.127

TEMPORARY ASPHALT PAVEMENT

NO TEXT ON THIS PAGE

DIVISION VII - DETAILED SPECIFICATIONS –
CONTRACT SEQ200436 / HWQ121B4

7.128 ASPHALT PAVING

NO TEXT ON THIS PAGE

DIVISION VII - DETAILED SPECIFICATIONS –
CONTRACT SEQ200436 / HWQ121B4

7.129 CONCRETE STRUCTURESA. Work Included

The Contractor shall investigate, install, test and place in satisfactory operation all Concrete Structures as shown on the Contract Drawings and specified herein. Concrete Structures include but are not limited to headwalls, retaining walls, perimeter walls, weir walls, hydraulic flow splitters, hydraulic riser boxes, culverts, sewers, chambers, catch basins, manholes, sand filters, pedestrian bridges and stone piers.

B. General Requirements

1. General Specifications-The General Specification: 11-Concrete (Dated November 1991) of the Department of Design and Construction (DDC) is declared to be part of this specification, the same as it fully set forth elsewhere herein. Copies of this specification may be obtained from the Department. Concrete work shall conform to all requirements of that specification except as modified by the applicable sections of this Detailed Specification.
2. Refer to Sect 7.103.C: Detail Requirements as contained within this contract specification.
3. Geotechnical Investigation

A geotechnical investigation shall be performed by the contractor prior to construction. The geotechnical investigation shall include borings and a geotechnical report. Borings shall be located as shown, driven to a minimum depth of 35 feet or refusal with continuous sampling. The geotechnical report shall include boring logs, soil testing results, bearing capacity and bearing elevation, soil properties, recommendations on foundation type and subgrade preparation recommendations. Scour shall be considered in the foundation recommendations. The geotechnical report shall be signed and sealed by an Engineer licensed in the state of New York. The geotechnical report shall be submitted by the Contractor to the Engineer. The Contractor may be required to revise the design in order to comply with the recommendations made by the Geotechnical Engineer. All modifications are to be submitted to the Engineer for review.

3. Submittals

DIVISION VII - DETAILED SPECIFICATIONS –
CONTRACT SEQ200436 / HWQ121B4

The Contract shall submit to the Engineer for approval shop drawings and other materials required to substantiate conformance to the requirements set forth on the Contract Drawings and the Specifications in accordance with the Standard Sewer Specifications. Submittals shall also include all material required under the “Submittals” section of the chapters of General Specification 11, Concrete, and any additional submittals hereinafter specified.

C. Measurement and Payment

The quantity to be measured for payment under this Section shall be the total number of Concrete Structures installed as directed by the Engineer.

The Contract price for each Concrete Structures shall be as indicated on the Bid Schedule of Prices Item No. BMP-7.129-1. The bid price shall include all work and equipment necessary to complete this item in accordance with the plans and specifications and to the satisfaction of the Engineer. The Concrete Structures unit price shall include but not be limited to geotechnical investigation, concrete, reinforcement, excavation, backfilling, crushed stone, geotextile, sheeting and bracing, stone facing, hatches, manhole covers, grating, railings, piping, hoods, valves, weir plates, ladders, steps, trash racks and bronze plaque. The unit price shall also include removal of all existing structure and debris found at the proposed new structure location.

D. Concrete Structures Summary

<u>Item</u>	<u>Description</u>
BMP-7.129-1	Structure No. 1

* * * * *

DIVISION VII - DETAILED SPECIFICATIONS –
CONTRACT SEQ200436 / HWQ121B4

MORTARED STONE WALL

7.201 Work Included

Under this item, the Contractor shall furnish all labor, materials and equipment for completing the construction of mortared stone wall as specified herein and as shown on the Contract Drawings, including all incidental and appurtenant work required for a complete job.

The work shall include items of work specified under the following sections:

<u>Section Number</u>	<u>Title</u>
7.201	Work Included
7.202	Masonry Mortar
7.203	Masonry Accessories
7.204	PA Colonial Field Stone

* * * * *

DIVISION VII - DETAILED SPECIFICATIONS –
CONTRACT SEQ200436 / HWQ121B4

7.202 MASONRY MORTARA. Description of Work

1. Description. Furnish all labor and material necessary for the preparation and placing of all mortar for masonry and stone work.
2. General Requirements.
 - a. General Specifications. Masonry mortar and grout materials shall comply with the requirements of this Section, except where otherwise shown or specified. Where no description has been specified for any material required, the current Reference Standard RS 10-1, Masonry - City of New York Building Code, shall apply. Concrete materials shall conform to the requirements of General Specification 11 - Concrete.
 - b. Code. The use of masonry cement mortar, as approved by the Board of Standards and Appeals, is optional. Masonry cement mortar shall fulfill the requirements of the Administrative Code of the City of NY and it shall be a mix of one part cementitious material to two-and-three-fourths parts of sand by volume. It shall be furnished in sacks containing one cubic foot each, and shall be marked with the weight.
 - c. Test. Masonry mortar samples shall be provided by the Contractor upon request from the Engineer. Samples will be subject to tests in conformance with ASTM C270.
 - d. Job mock-up. Sample panels will be constructed at the site. At that time, adjust mortar samples to achieve desired colors at the discretion of the Engineer.

B. Materials

1. Cement. Unless otherwise qualified, the term "portland cement" whenever used in connection with masonry work shall conform to the requirements of General Specification 11 - Concrete. Masonry cement shall fulfill the requirements of ASTM C91.
2. White Portland Cement. White portland cement shall be approved domestic product containing no ingredient that will stain other materials with which the cement comes in contact. It shall not

DIVISION VII - DETAILED SPECIFICATIONS –
CONTRACT SEQ200436 / HWQ121B4

contain more than 0.03% by weight of soluble alkali and shall fulfill the requirements of ASTM C150.

3. Lime Putty. Lime putty shall be made from hydrated lime except that quicklime may be used when adequate time and facilities are available for aging. Suitable precautions shall be taken to protect the putty from exposure to the sun and to prevent excessive evaporation when stored.
 - a. Hydrated lime shall be mixed with the amount of water called for in the printed directions of the manufacturer to form a putty and shall be allowed to stand for at least 24 hours before using. The hydrated lime may be sifted into the water, or the putty may be screened or punched through a sieve, or treated in any other manner, so as to obtain a smooth lump-free putty. Hydrated lime shall fulfill the requirements of ASTM C6.
 - b. Quicklime (pulverized) shall be slaked in suitable large batches, with the amount of water called for in the printed directions of the manufacturer, to form a thick cream. Lime shall be sifted into water. During cool or cold weather, precautions shall be taken to maintain the heat and prevent premature cooling during the process of hydration. The slaked quicklime shall be passed through a No. 10 sieve and stored for at least 72 hours before using. When the use of lump quicklime, slaked on the job, in lieu of pulverized quicklime is specifically approved for plastering, the cooling and aging period shall be not less than 14 days. Quicklime shall fulfill the requirements of ASTM C5.
 - c. Pressure hydrated lime shall be used as recommended by the manufacturer and shall conform to the requirements of ASTM C206.
4. Fine Aggregate. Sand shall conform to all the physical and chemical requirements and fulfill all the test requirements of NY Specification 24-S-30 for types as herein specified.

Fine aggregate for thin joints for units with cut or ground edges shall be Class A Type 2A but with not less than 95% passing thru No. 16 sieve.

Fine aggregate for masonry work in general, glass block and plaster shall be Class A Type 2A. For joints which are 1/2" wide or more, Type 2A shall be used.

DIVISION VII - DETAILED SPECIFICATIONS –
CONTRACT SEQ200436 / HWQ121B4

White sand shall be pure silica sand or marble dust having a gradation approximately within the limits specified for thin joints.

Sand in setting bed mortar for tile shall be as described for masonry work, except that not more than 5% shall pass thru a No. 100 mesh sieve.

Fine aggregate for pointing mortar tile (ceramic and quarry) shall be as specified for masonry work, except that 100% shall pass thru a No. 30 mesh sieve with no more through than 5% passing through a No. 100 mesh sieve.

Before the start of work, sample of fine aggregate shall be submitted to the Engineer for approval.

5. Water. Water used in connection with masonry work shall be clean and free of injurious amounts of oil, acid, alkali, organic matter or other deleterious substances, or shall be the water used in the City for drinking purposes.
6. Waterproofing and Non-Shrink Admixtures. An approved waterproofing plasticizer with pozzolanic properties containing pure stearic acid and equal to "Omicron" by Master Builders, or "Hydrocide" powder by Sonneborn Building Products Division of Contech, Inc., shall be added to produce a non-shrinking waterproof mortar. Admixture will be mixed with mortar as per manufacturer's requirements or if manufacturer does not specify in a 15:1 volumetric ratio of mortar to admixture.
7. Grout. Grout shall be mixed to a thick consistency. Neat grout shall be composed of cement and water only. Non-staining cement shall be used for non-staining grout.

C. Mixes

1. General Specifications. The mortar mixtures shall conform to ASTM C270. The proportions of cement specified herein are the minimum.
2. Type M Mortar. ASTM C270; composed by volume in proportions of 1/2 part portland cement, 1 part masonry cement and not more than 4 parts sand, measured in a damp, loose condition, with waterproofing added, with a minimum average compressive strength at 28 days of 2,500 psi. Use Type III mortar for all masonry work which is below grade.

DIVISION VII - DETAILED SPECIFICATIONS –
CONTRACT SEQ200436 / HWQ121B4

3. Mixing. Mortar shall be freshly mixed and the quantity of each batch shall not be in excess of the amount that will be used before the same has started to set. Retempering will not be permitted. The ingredients for each batch shall be accurately measured and combined in the proportions specified, all parts being measured by volume. Mortar shall be mixed in a batch mixer or by hand and shall be of uniform color and consistency. Mixer drums shall be entirely emptied of a batch before charging for a succeeding batch is started. The mixing time shall be not less than 5 minutes, approximately 2 minutes of which shall be for mixing the dry materials and not less than 3 minutes for continuing the mixing after the water has been added.
4. Coloring. Mortar shall be colored using cement during the mixture process. After mixing, mortar shall be of uniform color.

D. Measurement and Payment

No separate payment shall be made for this work of the specification. All costs shall be included in the various Contract Items of this Contract.

* * * * *

DIVISION VII - DETAILED SPECIFICATIONS --
CONTRACT SEQ200436 / HWQ121B4

7.203 MASONRY ACCESSORIESA. Description of Work

1. The Contractor shall provide all labor, materials and equipment necessary to place all masonry accessories as specified and shown on the Contract Drawings.
2. General Requirements.
 - a. Samples. Submit three of each item to the Engineer as specified in the General Conditions.
 - b. Job Mock-Up. A sample panel will be constructed at the site. At that time furnish all anchors, ties and reinforcement necessary to construct the sample panel.
 - c. Manufacturer.
 - 1) Acceptable manufacturers of anchors, ties and accessories: Hohmann and Barnard, Inc., Hickman Building Products, Inc., or approved equal.
 - 2) Acceptable manufacturers of joint reinforcement: Dur-O-Wall, Inc., AA Wire Products or approved equal.
3. Product Delivery, Storage and Handling. Materials shall be stored under cover in a dry place and protected from the elements.

B. Materials

1. Anchors and Ties for Exterior and Interior Work . Non-corrosive, stainless steel.
 - a. Corrugated or Crimped Ties. 22 gauge, not less than 7/8-inch wide, not less than 5 inches long.
 - b. Dovetail Type Masonry Anchors for Fastening Stone to Slot Inserts in Concrete. Shall be designed to fit the slots, not less than 16 gauge, 7/8-inch wide, turned up 1/4-inch at the end. Dovetail slots shall be 20 gauge filled type, furnished under this Section and installed under General Specifications 11, Concrete.

DIVISION VII - DETAILED SPECIFICATIONS –
CONTRACT SEQ200436 / HWQ121B4

C. Installation

1. Clean off foreign coatings that will destroy or reduce the bond immediately before placing reinforcing anchors and ties.
2. Provide all anchors, anchor slots, ties, masonry joint reinforcement and other anchorage devices necessary to anchor masonry work to the structure and to other masonry.
3. Coordinate placement of vertical slots 16-inch o.c. for anchorage of masonry furring and facings in front of concrete. Continuous slots shall not be placed closer than 3 inches to the edges of concrete work.

D. Measurement and Payment

No separate payment shall be made for the Masonry Accessories construction of Concrete Structures. All costs shall be included in the unit cost of the Concrete Structures item, specification section 7.129.

* * * * *

DIVISION VII - DETAILED SPECIFICATIONS –
CONTRACT SEQ200436 / HWQ121B4

7.204 PA COLONIAL FIELD STONEA. Description of Work

The Contractor shall furnish all labor, materials, equipment and services necessary to install stone facing as specified herein and as shown on the Contract Drawings.

B. General Requirements.

1. Samples. Furnish sufficient stone units including special shapes required, to show range of colors, texture, finishes and dimensions.
2. Job Mock-Ups.
 - a. Construct two 4 ft.-0 in. x 6 ft.-0 in. sample panels of stone units, with at least one 90E corner, and coping. Show backup and reinforcement.
 - b. The Contractor shall construct the three types of sample panel as often as required by the Engineer to achieve approved samples. Do not proceed with construction until sample panels are accepted by the Engineer.
 - c. Retain accepted samples as reference standard for project.
 - d. Demolish and remove sample panels from the site after completion and acceptance of all masonry work.
3. Store all stone units above ground on level platforms which allow air circulation under stacked units; cover and protect against wetting prior to use.
4. Handle units on pallets of flat bed barrows and do not permit free discharge from conveyor units or transporting in mortar trays.
5. Do not place concrete masonry units, when air temperature is below 40° F (4° C) without specific instructions in writing from the Engineer.

C. Stone Facing Work1. Materials

DIVISION VII - DETAILED SPECIFICATIONS –
CONTRACT SEQ200436 / HWQ121B4

- a. Stones: All stones shall be quartzite sandstone, commonly known as Pennsylvania Colonial Field Stone or natural local stone as approved by the Engineer.

All stones shall generally have a minimum length of one (1) foot six (6) inches and a minimum height of six (6) inches. All stones shall generally have a maximum length of three (3) feet zero (0) inches and a maximum height of twelve (12) inches. Stone widths shall generally be no more than twelve (12) inches, and shall generally conform to the width of the stone ledge provided.

All stones shall be free of soil and debris in order to achieve a secure bond with the mortar.

D. Installation

1. Lay stone with not less than 1" nor more than 2" of the specified mortar between stone and the back-up wall, and in accordance with the approved mock-up.
2. Joints shall have a nominal thickness of 3/8-inch, and uniform.
 - a. Strike joints flush in surfaces not exposed to view.
 - b. Point joints tight in unparged masonry below ground, or water level.
 - c. Tool joints in exposed surface when thumb-print hard with round jointer.
3. Contractor shall field verify condition of existing structures and surfaces as per ACI guidelines 201.1R prior to laying of stone.
4. Laying
 - a. Lay only dry units. Stones shall be laid in cement mortar so as to form full bed, end and side joints at one operation. Stones shall be laid with flat side down and best side facing outward. Those stones with best face on all sides shall be used for the top course as wall cap.
 - b. Stones shall be tightly wedged together and flash point mortared in place.

DIVISION VII - DETAILED SPECIFICATIONS –
CONTRACT SEQ200436 / HWQ121B4

- c. Provide full mortar coverage on horizontal and vertical face shells. Provide full mortar coverage also on webs, in all starting courses, in piers, columns and pilasters, and adjacent to cells or cavities to be filled with grout.
 - d. Shove vertical joints tight.
 - e. All stones shall be laid in a horizontal banding pattern, utilizing the one-over-two and two-over-one method. Set units plumb, true and line, and with level courses accurately spaced. Adjust units to final position while mortar is soft and plastic.
 - f. Keep open spaces at control joints and expansion joints free of mortar by using a continuous wood or metal strip temporarily set in the wall.
 - g. If units are displaced after mortar has stiffened, remove, clean joints and units of mortar, and relay with fresh mortar.
 - h. When jointing fresh mortar to set or partially set stone construction clean exposed surface to set masonry and remove loose mortar prior to laying fresh masonry. If necessary to stop off a horizontal run of masonry, rake back one-half block length in each course. Do not use toothing to join new masonry to set or partially set masonry when continuing a horizontal run.
5. Anchors and Reinforcement
- a. Units at corners and at intersections shall be bonded with masonry bond and preformed joint reinforcement spaced vertically 16-inch o.c.
 - b. Where block passes concrete, anchor with one dovetail anchor for each 2 square feet of wall surface.
6. Built-In Work
- a. Avoid cutting and patching.
 - b. Install bolts, anchors, nailing blocks, inserts, frames, vents, flashings, conduit and other built-in items as masonry work progresses. Solidly grout spaces around built-in items.

DIVISION VII - DETAILED SPECIFICATIONS –
CONTRACT SEQ200436 / HWQ121B4

- c. Coordinate the work of this Section with work of all other trades so that no requirements are overlooked.

7. Protection of Work

- a. Protect sills, ledges and off-sets from mortar drippings or other damage and remove misplaced mortar or grout immediately.
- b. Cover top of walls with non-staining waterproof coverings when work is not in progress. Provide minimum 2 ft. overhang of protective covering each side of wall and securely anchor.
- c. Protect face materials against staining.

8. Pointing and Cleaning

- a. At final completion of unit masonry work fill holes in joints and tool the same.
- b. Cut out and repoint defective joints.
- c. Dry brush masonry surface after mortar has set, at end of each day's work and after final pointing.
- d. Leave work and surrounding surfaces clean and free of mortar spots and droppings.
- e. Wash down all exposed brick with an approved masonry-type detergent, and then thoroughly rinse with clean water. Before applying any cleaning agent to the entire wall, apply it to a sample wall in a location approved by the Engineer. Cleaning shall not proceed until the sample area has been approved by the Engineer after which the same materials and methods shall be used on the entire work. Acid solutions or acid-type detergents shall not be used.

E. Measurement and Payment

The quantity to be measured for payment under this Section shall be the total number of cubic yards of PA Colonial Field Stones and mortar furnished in accordance with the plans and specifications and directions of the Engineer.

DIVISION VII - DETAILED SPECIFICATIONS –
CONTRACT SEQ200436 / HWQ121B4

No separate payment shall be made for PA Colonial Field Stones furnished and installed as facing on Concrete Structures. All costs shall be included in the unit cost of the Concrete Structures item, specification section 7.129.

* * * * *

DIVISION VII - DETAILED SPECIFICATIONS –
CONTRACT SEQ200436 / HWQ121B4

EARTHWORK AND GRADING

7.300 Work Included

Under earthwork and grading, the Contractor shall provide all labor, material, tools and equipment necessary to complete the execution of the work in complete accordance with the Specifications and all Contract Drawings. The work shall include items of work specified under the following sections.

<u>Section Number</u>	<u>Title</u>
7.304-A	Excavation
7.305	Crushed Stone
7.307-A	Grading
7.308	Fill On-Site

* * * * *

DIVISION VII - DETAILED SPECIFICATIONS –
CONTRACT SEQ200436 / HWQ121B4

7.301 DEBRIS REMOVAL AND DISPOSAL

NO TEXT ON THIS PAGE

DIVISION VII - DETAILED SPECIFICATIONS –
CONTRACT SEQ200436 / HWQ121B4

7.302

CLEARING, GRUBBING AND REMOVALS

NO TEXT ON THIS PAGE

DIVISION VII - DETAILED SPECIFICATIONS –
CONTRACT SEQ200436 / HWQ121B4

7.303

TEMPORARY WOODEN TREE GUARDS

NO TEXT ON THIS PAGE

DIVISION VII - DETAILED SPECIFICATIONS –
CONTRACT SEQ200436 / HWQ121B4

7.304-A EXCAVATIONA. Description of Work

The Contractor shall furnish all labor, materials, equipment and services necessary to perform all excavation as indicated on the Contract Drawings and as specified herein. Under this item, the Contractor shall also remove all plant material, including root mass and rhizomes, from Common Reed (*Phragmites australis*) and Giant Reed (*Phragmites communis*) throughout the project area and as directed by the Engineer.

B. General Requirements

1. General Specifications - Except as modified and supplemented hereinafter in the Detailed Specifications, work performed under this Section shall conform to the NYCDDC Sewer Construction General Specifications.
2. Shop Drawings - The Contractor shall submit to the Engineer for approval shop drawings and other documentation required to show conformance with the requirements set forth on the Contract Drawings and these Specifications. Shop drawings shall include, but not be limited to, the requirements for shop drawings as specified in General Specification.

C. Excavation

1. General Information –The Contractor shall excavate all materials to the established lines and grades for the construction of all facilities included in this Contract, or as shown and specified, in accordance with the requirements of NYCDDC Sewer Construction General Specification, except as otherwise specified herein. Excavation shall include removing boulders of size less than one-half cubic yard. Excavation shall also include the removal of existing buried pipelines, the plugging of those remaining sections of the pipelines and the plugging of all existing buried pipelines to be abandoned but not removed.

The limits of excavation shown on the drawings are the payline and indicate the extent of work to be performed by the Contractor. The Contractor shall furnish and install any temporary side slope supports, bracing, and sheet piling required performing the excavation to the levels and surfaces indicated.

1. 2. Excavated Materials - The Contractor shall dispose off site all excess and unsuitable materials. Boulders and stones deemed

DIVISION VII - DETAILED SPECIFICATIONS –
CONTRACT SEQ200436 / HWQ121B4

suitable for reuse shall be stockpiled on-site at a location determined by the Engineer. Excavated material containing rhizomes and root mass from Phragmites and other plants shall be removed from the site and disposed of at an approved disposal site by the Contractor.

3. Hazardous and Non-Hazardous Waste – Prior to starting the work, the contractor shall perform soil sampling as detailed in Section 7.317-Soil Sampling and Disposal. Sampling and subsequent removal of contaminated soils shall be paid for under that item.
4. Care of Water - Prior to starting the work, the Contractor shall submit to the Engineer for approval, a detailed description of the method he proposes to use to care for water during construction, including a coordinated sequence of operation for the entire project. Approval by the Engineer will not relieve the Contractor of his responsibility for the safety of the work, existing structures and adjacent property.
5. Stockpiling - Topsoil that has been excavated and approved for use on-site is to be stockpiled separate from subsoil. Topsoil shall be excavated to a depth of 18" or as directed by the Engineer. Location of stockpiling shall be approved by the site Engineer. If the Engineer deems necessary, subsoils shall be separated and stockpiled according to soil horizons.
6. Avoidance of Impacts to Existing Infrastructure – Where infrastructure currently exists on site, the Contractor shall use hand tools to avoid impacts to the infrastructure. Any infrastructure impacted shall be replaced in kind by the Contractor at no additional cost to the City.

D. Measurement and Payment

The quantity to be measured for payment under the pay item Excavation shall be the total number of cubic yards, measured in containers and vehicles, and the quantity to be paid for will be 75% of the yardage determined by such measurements.

The contract price per cubic yard of material excavated and disposed of off-site shall be indicated on the BID SCHEDULE OF PRICES Items No. BMP-7.304-A. The bid price shall constitute full compensation for all labor, materials, equipment and work incidental thereto, necessary to complete the work in accordance with the plans and specifications to the satisfaction of the Engineer.

DIVISION VII - DETAILED SPECIFICATIONS –
CONTRACT SEQ200436 / HWQ121B4

All costs for excavation performed in conjunction with the construction and installation of concrete structures will be included under the unit bid price for Concrete Structures Section 7.129.

* * * * *

DIVISION VII - DETAILED SPECIFICATIONS –
CONTRACT SEQ200436 / HWQ121B4

7.305 CRUSHED STONE Description of Work

The Contractor shall provide and install Crushed Stone bedding as indicated on the Contract Drawings and as specified herein.

B. Materials

Crushed stone used shall conform to the following gradation and shall be compacted to 98 percent density as determined by ASTM D698.

<u>Sieve Size</u>	<u>Percentage of Dry Weight Passing Designated Sieve Size</u>
1"	100
1/2"	90-100
1/4"	0-15

C. Construction Methods

Crushed stone shall be installed as per the Contract plans and to the satisfaction of the Engineer.

D. Measurement and Payment

The quantity to be measured for payment under this Section shall be the total number of cubic yards of approved crushed stone as measured in vehicles and containers. The bid price shall constitute full compensation for all labor, materials, equipment and work incidental thereto, necessary to complete the work in accordance with the plans and specifications to the satisfaction of the Engineer.

No separate payment shall be made for crushed stone used as bedding for Concrete Structures. All costs shall be included in the unit cost of the Concrete Structures item, specification section 7.129.

* * * * *

DIVISION VII - DETAILED SPECIFICATIONS –
CONTRACT SEQ200436 / HWQ121B4

7.306

TREE REMOVAL AND DISPOSAL

NO TEXT ON THIS PAGE

DIVISION VII - DETAILED SPECIFICATIONS –
CONTRACT SEQ200436 / HWQ121B4

7.307-A GRADINGA. Description of Work

The Contractor shall furnish all labor, materials, equipment and services necessary to perform all grading as indicated on the Contract Drawings and as specified herein.

B. General Requirements

1. General Specifications - Except as modified and supplemented hereinafter in the Detailed Specifications, work performed under this Section shall conform to the NYCDDC Sewer Construction General Specifications.
2. Shop Drawings - The Contractor shall submit to the Engineer for approval shop drawings and other documentation required to show conformance with the requirements set forth on the Contract Drawings and these Specifications. Shop drawings shall include, but not be limited to, the requirements for shop drawings as specified in General Specification.

C. Grading – The Contractor shall perform filling, compacting, and grading of the indicated areas of site, including minor cutting and filling high and low areas, and leveling such areas to elevations and within limits shown on the Contract Drawings. All work shall be performed in accordance with the applicable requirements of the NYCDDC Sewer Construction General Specifications.D. Compaction

1. BMP Areas – Compaction shall not be done in BMP and landscaped areas.
2. Other Areas – Each layer of fill or backfill shall be compacted by a minimum of four complete passes with an approved tamping roller, pneumatic-tired roller, three-wheel power roller, or other approved compaction requirement. Compaction shall not be less than 95 percent of the maximum density modified proctor as determined by ASTM D1557, Method D.
3. Field Control – Sufficient in place density tests shall be performed by the Contractor in order to satisfy the Engineer that the specified density is being obtained. These tests shall be made at no cost to the City and shall be made using the calibrated sand cone method (ASTM D1556) or other method as determined by the Engineer.

DIVISION VII - DETAILED SPECIFICATIONS –
CONTRACT SEQ200436 / HWQ121B4

E. Finished Excavation, Fills, and Embankments – All areas covered by the project, including excavated and filled sections and adjacent transition areas, shall be uniformly graded. The finished surface shall be reasonably smooth, compacted, and free from irregular surface changes. The degree of finish shall be that ordinarily obtainable from blade-grader operations. Surfaces shall be finished not more than 0.15 foot above or below the established grade or approved cross section.

F. Protection – Newly graded areas shall be protected from traffic and erosion, and any settlement or washing away that may occur from any cause, prior to acceptance, shall be repaired and grades re-established to the required elevations and slopes, at no additional expense to the City.

The Contractor shall provide temporary ground cover sufficient to restrain erosion on all disturbed areas upon which further active construction is not taking place.

G. Measurement and Payment

The quantity to be measured for payment under the pay item Grading shall be the total number of square feet of work area graded. The contract price per square foot for grading shall be as indicated on the BID SCHEDULE OF PRICES Item No. BMP-7.307-A. The bid price shall constitute full compensation for labor, materials, equipment and work incidental thereto, necessary to complete the work in accordance with the plans and specifications to the satisfaction of the Engineer.

* * * * *

DIVISION VII - DETAILED SPECIFICATIONS –
CONTRACT SEQ200436 / HWQ121B4

7.308 FILL ON-SITEA. Description of Work

This work shall consist of providing and placing approved fill material where required throughout the project area only. The Contractor may use approved fill material excavated from sewer and foundation trenches and stockpiled excavated soils within BMP project limits as long as it meets the approved definition. Reuse of onsite excavated material requires that the material be screened prior to placement as fill. The approved fill material shall be provided, placed, spread, compacted and fine graded to the elevations, lines, grades and cross-sections indicated on the drawings as directed by the Engineer.

B. Definition

Approved fill is hereby defined as clean earth, consisting of a mixture of silt and clay. Fill material shall have a liquid limit less than or equal to 40 and a plasticity index less than or equal to 20, as determined by ASTM D4318. This mixture must be free of any roots, trees, tree stumps, leaves or other organic matter. Furthermore, this material must also be free of any metals, masonry (i.e. construction debris), stones over one and one-half (1-1/2) inches in diameter and deleterious material. In addition, the fill shall have a gradation such that 100% (by weight) passes a 3" sieve, 50-100% passes a #10 sieve, 20-90% passes a #60 sieve, and 0-20% passes a #200 sieve.

Fill used in planted areas shall be clean earth, consisting of a mixture of silt, clay, and sand. No custom ("select fill") fill shall be used in area which are to be planted.

C. Measurement and Payment

The quantity to be measured for payment under this Section shall be the total number of cubic yards of approved fill, measured in containers or vehicles, provided and placed as indicated on the Contract Drawings and as directed by the Engineer.

The contract price per cubic yard of approved fill material placed shall be as indicated on the BID SCHEDULE OF PRICES Item No. BMP-7.308. The bid price shall constitute full compensation for all labor, materials, equipment and work incidental thereto, necessary to complete the work in accordance with the plans and specifications to the satisfaction of the Engineer.

DIVISION VII - DETAILED SPECIFICATIONS –
CONTRACT SEQ200436 / HWQ121B4

No separate payment shall be made for fill used to backfill structures. All costs shall be included in the unit cost of the Concrete Structures item, specification section 7.129.

* * * * *

DIVISION VII - DETAILED SPECIFICATIONS –
CONTRACT SEQ200436 / HWQ121B4

7.309

IN-STREAM SEDIMENT REMOVAL

NO TEXT ON THIS PAGE

DIVISION VII - DETAILED SPECIFICATIONS –
CONTRACT SEQ200436 / HWQ121B4

7.310

PLANT AND SOD SALVAGE

NO TEXT ON THIS PAGE

DIVISION VII - DETAILED SPECIFICATIONS –
CONTRACT SEQ200436 / HWQ121B4

7.311

CONSTRUCTED WETLAND TREATMENT

NO TEXT ON THIS PAGE

DIVISION VII - DETAILED SPECIFICATIONS –
CONTRACT SEQ200436 / HWQ121B4

7.312

DEMOLITION AND SITE CLEARING

NO TEXT ON THIS PAGE

DIVISION VII - DETAILED SPECIFICATIONS –
CONTRACT SEQ200436 / HWQ121B4

7.313 REMOVAL OF POND SEDIMENTS

NO TEXT ON THIS PAGE

DIVISION VII - DETAILED SPECIFICATIONS –
CONTRACT SEQ200436 / HWQ121B4

LANDSCAPING AND RESTORATION WORK

7.400 Work Included

Under landscaping and restoration work, the Contractor shall provide labor, materials, tools and equipment necessary to complete the execution of the work in complete accordance with the Specifications and all Contract Drawings. The work shall include items of work specified under the following sections.

<u>Section Number</u>	<u>Title</u>
7.401	Landscaping for Terrestrial Zone and Wetland Zone
7.403	Top Soil for Restored Area
7.404-A	Restoration Specialist (Construction Monitor)
7.404-B	Erosion and Sediment Control Licensed Professional
7.407-A	Erosion Control Mat – Straw
7.407-B	Erosion Control Mat – Curled Wood or Coconut Fiber
7.408	Herbicide Application
7.413	Temporary Goose Exclusion Fence
7.417	Debris Exclusion Fence
7.414	BMP As-Built Plans

DIVISION VII - DETAILED SPECIFICATIONS –
CONTRACT SEQ200436 / HWQ121B4

7.401 LANDSCAPING FOR TERRESTRIAL ZONE AND WETLAND ZONE

A. Work Included

Under these items, the Contractor shall furnish all labor, materials, equipment and services necessary for the proper execution of all landscaping work, as specified herein and as shown on the Contract Drawings, including all incidental and appurtenant work required for a complete job. In addition, the contractor will also furnish and deliver Permanent Seed Mix as directed by the Engineer.

B. General Requirements

1. Reference Standards

- a. American Association of Nurserymen, Inc., (American National Standards Institute) Nursery Stock (Z60.1)
- b. American Joint Committee on Horticultural Nomenclature Standardized Plant Names.
- c. A Checklist of New York State Plants, Contributions to a Flora of New York State, Checklist III, Bulletin #458, Richard S. Mitchell, State Botanist, New York State Museum, 1986.
- d. A Comparative Flora of Staten Island, 1879 - 1981, Buegler and Parisio, Staten Island Institute of Arts & Sciences.

C. Quality Assurance

1. Source Quality Control:

- a. If private nursery sources are used, they must be within a 250-mile radius of the planting site. All specified plants shall have also been grown in the same USDA climatic zone as that of the planting site.

All seed and original stock material for herbaceous plants shall have been collected from locally adapted ecotypes within a one-hundred mile radius of the project site. Plant material may have to be contract grown in order to meet this requirement.

DIVISION VII - DETAILED SPECIFICATIONS –
CONTRACT SEQ200436 / HWQ121B4

No substitutions of specified plants will be accepted without prior approval of the Engineer or his/her duly authorized representative.

- b. General. Ship landscape material with certificates of inspection when required by governmental authorities. Comply with governing regulations applicable to landscape material.
 - c. Packaged Material. Package standard products with manufacturer's certified analysis. For other material, such as topsoil, provide analysis by recognized laboratory made in accordance with methods established by the Association of Official Agricultural Chemists, wherever applicable, or as further specified.
 - d. All seed shall be interagency certified under the auspices of a State Seed Improvement Cooperative and must bear their seals of certification on bag. Permanent seed shall be 75% Pure Live Seed minimum.
2. Plants shall be specified as in the Contract Documents. Nurseries which collect plants from the wild shall be rejected. No substitutions shall be permitted, except as authorized in writing by Engineer. If specified landscape material is not obtainable, submit proof of non-availability to Engineer, together with proposal for use of equivalent material. All plants specified within this Contract are native to the State of New York. Species native to this region, but not listed as native within A Checklist of New York State Plants or A Comparative Flora of Staten Island, may be accepted on a case-by-case basis.
 3. The Contractor shall provide plants of quantity, size, genus, species and variety shown and scheduled in the Contract Documents for landscape work and complying with recommendations and requirements of ANSI Z60.1 "American Standard for Nursery Stock". The Contractor shall provide healthy, vigorous stock, grown in a recognized nursery in accordance with good horticultural practice and free of disease, insects, eggs, larvae and defects such as knots, sun-scald, injuries abrasions, or disfigurement.
 4. All plants furnished under this Item shall be true to name. Plant names shall agree with the nomenclature of Standardized Plant Names as adopted by the American Joint Committee on Horticultural Nomenclature, 1942 Edition. Size and grading shall

DIVISION VII - DETAILED SPECIFICATIONS –
CONTRACT SEQ200436 / HWQ121B4

conform to those of the American Association of Nurserymen. All wetland plants shall come from within 250-mile radius of the project site.

5. Certified analyses by a recognized laboratory shall be submitted by the Contractor for approval by the Engineer for topsoil before delivery to the site. Analyses must include mechanical analysis, magnesium, nitrogen, potassium, and phosphorus levels, soluble salts, pH and organic matter. Standards and formatting for topsoil analyses shall conform to those of Cornell Cooperative Extension of Nassau County. Associated costs and additional guidelines for topsoil analyses shall be as specified under DETAILED SPECIFICATIONS FOR TOPSOIL FOR RESTORED AREA.
6. Inspection:
 - a. The Engineer shall inspect plants at place of growth before planting, for compliance with requirements for genus, species, variety, size and quality. Contractor shall be responsible for all inspection costs beyond a 50-mile radius from New York City.
 - b. Plant materials shall be inspected by the Engineer upon arrival at the job site and prior to planting. Any materials not in compliance with specifications shall not be accepted and shall be removed from the job site immediately.
 - c. The Engineer retains the right to further inspect plants for size and condition of balls and root systems, insects, injuries and latent defects, and to reject unsatisfactory or defective material at any time during progress of work. The Contractor shall remove rejected plants immediately from the project site.
 - d. Tagged samples of plant materials shall be delivered to the site and planted in locations approved by the Engineer. These tagged samples shall be maintained, protected and used as standards for comparison with the plants furnished for the work.
 - e. The Contractor shall be responsible for all certificates of inspection of plant material that may be required by Federal, State or other authorities to accompany each shipment of plants. On arrival, the certificates shall be filed with the Engineer. The Engineer shall receive a copy of

DIVISION VII - DETAILED SPECIFICATIONS –
CONTRACT SEQ200436 / HWQ121B4

each shipping invoice immediately after the delivery has arrived at the job site.

D. Submittals

The General Contractor shall submit the following information (as listed in 1. through 4.) for approval within ten working days following the date in the Notice to Commence Work:

1. Subcontractors. Subcontractors proposed for landscaping and associated restoration and site work must be approved by the Engineer prior to start of work. The Contractor shall submit at least three (3) alternative Subcontractors to the Engineer for review and approval. The Subcontractors proposed shall be evaluated on the following criteria, prioritized in descending order:
 - a. The Contractor shall submit a minimum of three (3) projects similar in scope and type within the last five years whereby the Contractor was directly responsible for the installation, restoration and maintenance of native habitats and wetlands. References and xerographic reproductions of photographs of the projects shall be submitted. Projects shall not be more than five years old.
 - b. Demonstrated capacity to accomplish the work in the required time including qualification of experienced foreman and key personnel.
 - c. Experience in digging and transplanting field stock.
 - d. Experience with City agencies, such as the Department of Parks and Recreation, Central Park Conservancy, Botanic Gardens, HPD and the Port Authority.
 - e. Other references or experience deemed appropriate to obtaining approval.
2. List of growers/nurseries.
3. Certified arborist or nurseryman, experienced in tree pruning and removal.
4. List of all materials and certificates specified within this Item.

The General Contractor shall submit the following information (as listed in 5 through 8) prior to construction:

DIVISION VII - DETAILED SPECIFICATIONS –
CONTRACT SEQ200436 / HWQ121B4

5. Certificates:
 - a. All necessary State, Federal and other inspection certificates as may be required by law.
 - b. Two (2) copies to the Engineer of manufacturers' or vendors' certified analysis for soil treatments and fertilizer materials shall be submitted with samples.
 - c. Certification and guarantee that all plant material is true to name and in conformance with these specifications.
 - d. The invoice or a written statement showing the size and grade of materials received or shipped, together with the source and health of the plant material and verification that balled and burlapped plants were sprayed with an anti-desiccant within 48 hours prior to digging. No plants shall be accepted that have been collected from property other than that owned or leased by a nursery.
 - e. Certification that all herbaceous plant material was grown from seed or stock collected from locally adapted ecotypes within a one-hundred mile radius of the project site.
6. Planting Schedule. Submit proposed planting schedule within one month of official Notice to Commence Work, indicating dates for each type of landscape work during normal seasons and as specified in the Contract for such work in area of site. Included shall be a schedule of nursery visits for the Engineer to tag plant material. Correlate from date of substantial completion. Once accepted, revise dates only as approved in writing, after documentation of reasons for delays.
7. List of equipment, methods of operation, and maintenance plan, including methods for protection of existing vegetation.
8. Manufacturer's Literature. Manufacturer's literature for all materials furnished shall be submitted with samples of same.
9. The Contractor is required to perform a separate germination test on the seed mixes to be used on this project prior to submitting the seed mix and supplier. The results of the germination test shall be included in with the information submitted to the Engineer for review and acceptance. The Contractor is advised that these tests can run two-months or more and should be prepared to have these

DIVISION VII - DETAILED SPECIFICATIONS –
CONTRACT SEQ200436 / HWQ121B4

tests completed in sufficient time for the next seeding season. Seed shall conform to all applicable state and federal regulations and to test provisions of the Association of Official Seed Analysts. There shall be no exceptions.

10. The Landscape Subcontractor shall submit a watering and weeding plan and maintenance schedule prior to the installation of plant material, to be approved by the Engineer or Restoration Specialist. The plan shall include proposed methods of watering and weeding, including but not limited to tree gators (bags), sprinklers, drip hoses, irrigation, tanker vehicles and hand watering, etc., as well as manual weeding and weeding tools. No additional payment will be made for watering and weeding during installation and during the three year guarantee period.

The approved plan and schedule do not relieve the Contractor in any way from any aspect of the replacement of dead plant material. The Landscape Subcontractor may alter the maintenance schedule based on weather and field conditions.

E. Product Delivery, Storage and Handling

1. Delivery of Materials:
 - a. Packaged Materials. Deliver packaged materials in unopened bags or containers, each bearing the name, warranty, and trademark of the producer and the composition, analysis and the weight of the material.
 - b. Plants. The Contractor shall provide plants of the stock type and quantities shown on the Contract Drawings. Do not prune prior to delivery unless otherwise approved by the Engineer. Do not bend or bind-tie plants in such a manner as to damage bark, break branches or destroy natural shape. Provide protective covering during delivery, and insure that all balled and burlapped stock, container stock, tube stock, and/or bare root material is handled properly and is not dropped.
 - c. All plant materials shall be protected from drying out and from wind damage during delivery.
 - d. The Contractor shall deliver plants after preparations for planting have been completed and plant immediately. If planting is delayed more than 6 hours after delivery, set plants in shade, protect from wind, weather and mechanical

DIVISION VII - DETAILED SPECIFICATIONS –
CONTRACT SEQ200436 / HWQ121B4

damage, and keep roots moist by covering with mulch, burlap or other acceptable means of retaining moisture. Water as necessary.

- e. The Contractor shall not remove container grown stock from container until planting time.
- f. Material should be planted in the ground immediately after delivery to site. Plants should be covered with damp-not wet-leaf compost while awaiting ground installation. Do not allow the plants to dry out or freeze.
- g. Fertilizer delivered to the job site shall be in original, unopened containers bearing the manufacturer's chemical analysis and essential information. Fertilizer containers shall be protected from exposure to precipitation and direct sunlight.
- h. All materials shall be stored in upland areas that are protected from weather.
- i. Seed shall be clean and fresh and delivered to the site in the original, unopened bags showing the net weight, composition of mix, suppliers name and guarantee of analysis. Seed shall be delivered and stored in original unopened packages, kept dry, and not opened until needed for use. Damaged or faulty packages shall not be used and will be rejected. Seed shall have been harvested for planting in the current growing season, and shall have been packed within the last 9 months.

F. Job Conditions

Adjacent Pond Plantings: Unless otherwise directed by the Engineer, evergreen material shall be planted and transplanted from April 1st to May 15th and from September 1st to October 15th. Deciduous material shall be planted and transplanted from March 1st to May 30th and from October 15th to December 1st. Container-grown herbaceous material shall be planted and transplanted from March 1st to May 30th and from August 15th to September 15th (SEE PLANTING SCHEDULE). Perform actual planting when conditions are suitable. No plant material shall be planted when the ground is frozen or in excessively moist condition. All material labeled as fall planting hazard shall be installed during the spring only. Notify the Engineer before proceeding with any planting operations.

DIVISION VII - DETAILED SPECIFICATIONS –
CONTRACT SEQ200436 / HWQ121B4

1. Time of Planting and Transplanting. All wetland plantings shall be installed in time frames indicated under the above Terrestrial and Wetland Buffer Zone Planting section. Perform actual planting when conditions are suitable. No plant material shall be planted when the ground is frozen or in excessively moist condition. Notify the Engineer before proceeding with any planting operations.
2. The Contractor shall proceed with and complete landscape work as rapidly as portions of site become available, working within seasonal limitations for each kind of landscape work required.
3. Utilities. The Contractor shall determine location of underground utilities and perform work in a manner which will avoid possible damage. Hand excavate, as required. Maintain grade stakes set by others until removal is approved by the Engineer.
4. Excavation. When conditions detrimental to plant growth are encountered, such as rubble fill, adverse draining conditions, or obstructions, notify the Engineer.
5. Preservation and Restoration of Existing Trees and Shrubs.
 - a. In order to avoid surface and subsurface root damage and soil compaction, the Contractor shall not be permitted to stockpile materials of any nature under the drip line of existing trees and shrubs. This directive shall apply to all areas within or outside the Contract limit line.
 - b. The Contractor shall assume the responsibility for any remedial work such as root and top pruning required and/or necessary to prevent loss of plant material when this article is violated or when trees or shrubs are injured by construction equipment.
 - c. Compensatory pruning and fertilizing of existing trees and shrubs shall be performed to compensate for damage of roots incurred. Fertilize in areas around undamaged roots only and not adjacent to the trunk or main stem. Fertilizer shall be applied in the fall unless otherwise approved by Engineer.
 - d. Tree pruning shall be performed in accordance with NYCDOT STANDARD HIGHWAY SPECIFICATION 4.18D.

DIVISION VII - DETAILED SPECIFICATIONS –
CONTRACT SEQ200436 / HWQ121B4

- e. No separate payment will be made for fertilizing and pruning of trees and shrubs in stockpile areas or when trees or shrubs are injured by construction equipment, but the cost thereof will be deemed to be included in the various prices bid for the items for which such pruning and fertilizing are necessary.
- f. No existing trees, shrubs or herbaceous plants shall be removed, except as specifically required by this Contract or as specified on Contract Documents, or as specifically approved in writing by the Engineer.
- g. Any areas or items of existing landscape which are removed or damaged shall be replaced by the Contractor at no additional cost to the City. The Contractor shall match the existing condition prior to damage or as directed by the Engineer.
- h. All existing landscape features including trees, shrubs, perennial, meadows, lawns, wetlands, paving, walls, stairs, etc. shall be protected by the Contractor, utilizing methods approved by the Engineer prior to start of work.

G. Guarantee

- 1. Landscape Guarantee and Replacements
 - a. Guarantee. All landscaping work shall have a replacement guarantee for a period of three (3) years beginning at the date of acceptance of the Landscaping work or the date of substantial completion, whichever is later, and shall be considered as included under monies shown within the guarantee provisions of Schedule A.
 - b. Operations. The Contractor shall, for a period of three (3) years, cultivate, weed, mulch, prune, and water all plants and permanent seeded areas under this Contract, to the satisfaction of the Engineer. The Contractor shall replace, according to the original specifications, any plant material which is dead or in a dying condition at the request of the Engineer. The Engineer shall be the sole judge as to the condition of the plants. The guarantee and maintenance applies to all planted and grassed areas, meadows, paved and other landscaped areas.

DIVISION VII - DETAILED SPECIFICATIONS –
CONTRACT SEQ200436 / HWQ121B4

- c. Replacement. Any plant material that is dead or not showing satisfactory growth, as determined by the Engineer, shall be promptly removed and replaced by the Contractor during normal planting season specified in Section 7.401.F. Initial replacement of dead material and the repair of bare areas will take place one year following the acceptance of plant material. The replacement shall be of the same variety, size and character as specified for the original planting. Unless a written waiver of this clause is issued, under the terms of the guarantee, replacement plants shall be chosen only by the Engineer.

At the end of the guarantee period, and upon written request, an inspection will be made by the Engineer. If mortality exceeds ten percent or if bare areas occur, the Contractor shall replace plant material.

H. Materials

1. Topsoil

- a. Topsoil from site stripping shall be used if the material meets specifications listed in 7.403. A soil test(s) shall be made at Contractor's expense to determine if the specifications for all the tests listed in (7.403) have been met. A soil test shall be required and shall serve as a representative analysis for every 200 cubic yards of material utilized.
- b. Additional topsoil shall be furnished from sources off the Contract site when existing topsoil is not sufficient. Material shall consist of natural loam topsoil, free from subsoil, obtained from an area which has never been stripped. Topsoil shall comply with the requirements of Specification section 7.403.

2. Fertilizer

Fertilizer shall be provided as indicated on the Contract Drawings: Osmocote, granular, slow-release in the specified time frame releases and analyses. Fertilizer shall be furnished in standard containers, with name, weight and guarantee analysis of contents clearly marked thereon. Appropriate containers to disperse specified amounts of fertilizer into planting holes shall be supplied and used by the Contractor.

3. Mycorrhizal Inoculants

DIVISION VII - DETAILED SPECIFICATIONS –
CONTRACT SEQ200436 / HWQ121B4

- a. Mycorrhizal inoculants shall not be used.
4. Plant Material
- a. The Contractor shall furnish all plant material shown. Plant material must be true to name and size and conform with the following standards:
 - i. American Joint Committee on Horticultural Nomenclature, Standardized Plant Names (Published by Mount Pleasant Press J. Horace McFarland Company, Harrisburg, PA.).
 - ii. American Association of Nurseryman, “Horticultural Standards” (Published by American Association of Nurserymen, Inc., 635-636 Southern Building, Washington, D.C.).
 - b. Nursery grown plants shall mean plants propagated by seed, division, tissue culture or cloned from existing stock at a nursery, which are healthy, vigorous plants, cultivated in accordance with sound horticultural practice. All plants shall be nursery grown unless collected from natural areas owned or leased for that purpose by the nursery. All plants shall have been grown under the same climatic conditions as those of the planting site. All herbaceous plants shall come from seeds or stock collected within a one-hundred mile radius of the project site. Only those nurseries within a 250-mile radius of the planting site will be accepted as plant sources. In some cases plant material may be obtained outside the 250-mile radius on a case-by-case basis.
 - c. All plants and all balled and burlapped plants shall be freshly dug; neither heeled-in nor plants from cold storage will be accepted. All plants shall have been transplanted or root pruned at least once in the past three years.
 - d. All plants shall conform to the measurements specified in the plant list on the Contract Drawings. All plants shall be typical of their species and shall have a normal, healthy habit of growth and be of first quality, sound, vigorous, well-branched and densely foliated. Plants that meet the requirements specified in the plant list, but that do not possess a normal balance between height and spread will not be accepted. No damaged or diseased plants will be accepted.

DIVISION VII - DETAILED SPECIFICATIONS –
CONTRACT SEQ200436 / HWQ121B4

5. Mulch

Mulch shall be organic mulch free from deleterious materials and suitable for top dressing of plants and shall be shredded hardwood bark, decayed hardwood chips, leaf mold, pine straw, partially decayed leaves, cottonseed hulls, peanut hulls or other organic products. Mulch must be aged at least one year, should not contain elm wood chips, or be from diseased trees. No shredded bark pieces shall be greater than 3" in length and 13" in width. Mulch for seeded areas shall be clean, seed-free salt hay. Mulch shall be free of roots or other parts of invasive exotic plants that may take root in restored area.

6. Compost

Compost having the general properties of humus shall contain organic matter with no admixture of refuse or material toxic to plant growth and shall be completely decomposed and free from deleterious materials such as a glass, paper, plastics, metals, etc. Compost shall be "Earthlife", manufactured by Casella Organics, or approved equal.

8. Topsoil Mix

The topsoil mix shall be a mixture of one part compost, and two parts of topsoil. Topsoil mixed on-site must be tested by Contractor and have pH of 5.5 - 6.5. Ericaceous plantings may require a lower pH. Where site conditions such as heavy clay soils exist, the Engineer shall determine a mix incorporating a percentage of the existing soils.

9. Temporary Seed Mixtures

Soil stockpiles and cleared and graded areas shall receive Ryegrass (annual or perennial).

Nurse/Cover seed shall be certified "Aroostook" winter rye (cereal rye).

10. Permanent Seed Mixture

Seed mixture shall be as specified in the Contract Drawings unless otherwise directed by the Engineer.

11. Erosion Control Mat (Blanket)

DIVISION VII - DETAILED SPECIFICATIONS –
CONTRACT SEQ200436 / HWQ121B4

The erosion control fabric utilized at BMPs and shown on the Contract Drawings shall conform to Detailed Specifications 7.407-A and 7.407-B.

I. Execution

Installation/Application/Performance For Adjacent Pond Plants

1. Workmanship. The Contractor shall complete all work in the best manner, so that the work as a whole is of uniform quality and appearance. The Contractor shall conform to the requirements specified hereafter.
2. Preparation.
 - a. Areas described and shown on plans shall be rough graded with suitable local fill to (maximum) four (4) inches below the finished surface, topsoiled, fine graded, prepared for planting and landscaped.
 - b. Subgrade shall be kept free of masonry, concrete, metal waste materials, and debris.
 - c. Remove stones over 1-1/2 inches in any dimension, as well as sticks, rubbish and other extraneous matter.
 - d. No topsoil mix is to be placed until the subgrade is approved by the Engineer.
 - e. For planting beds, spread topsoil mix to minimum depth required to meet lines, grades and elevations shown on the Contract Drawings, after light rolling and natural settlement.
 - f. The planting beds and pits shall be worked up well, and shall be free of other vegetation and large clods of soil.
 - g. Apply fertilizer at rate specified in Contract Drawings during planting and seeding operations. Do not use fertilizer for wetland plants or in excessively wet areas.
3. Delivery: Plants shall be packed, transported, and handled with utmost care to insure adequate protection against injury. When transported in closed vehicles, plants shall receive adequate ventilation to prevent sweating. When transported in open vehicles,

DIVISION VII - DETAILED SPECIFICATIONS –
CONTRACT SEQ200436 / HWQ121B4

plants shall be protected by tarpaulins or other suitable cover material. All bare root plants shall be adequately protected from drying out and immediately after inspection shall be heeled in moist soil. Balled and burlapped plants shall be set on the ground and the ball covered with soil. Until planted, all material shall be properly maintained and kept adequately moist, to the satisfaction of the Engineer.

4. Inspection: Inspection may be made before digging if the Engineer directs, but no plant material shall be planted by the Contractor until inspected by the Engineer at the site of the work. Plant material will be rejected if delivered with broken or damaged root balls, or if damaged on site by rough handling. All rejected material shall be immediately removed from the site and replaced with acceptable material at no additional cost to the City. Final inspection shall be made upon completion of the Contract.
5. Installation.
 - a. Planting Operations.
 1. Layout: All herbaceous plants shall be laid out in random and naturalistic arrangements, as specified in the Contract Drawings unless otherwise directed by the Engineer. All plant and planting area locations shall be staked prior to planting by the Engineer. Place no plantings within two (2) feet of pavements or structures, unless otherwise indicated.
 2. Loosen subsoil/subgrade to a depth of six (6) inches prior to topsoil placement so that the topsoil and subsoil layers don't mix. Loosen subsoil with rototiller, backhoe or discer. The soil-loosening operation shall be conducted in such a way as to back its way out of the site. After this, no more heavy machinery shall be allowed on the planting beds.
 3. Rototill/cultivate soils to a depth equal to the depth of the root ball and two times the diameter of the root ball. Set plants on the undisturbed solid ground in the center of the area.
 4. Obstructions Below Ground: Remove any rock, rubble, masonry, concrete, metal, stones over one inch or other underground obstructions to the depth

DIVISION VII - DETAILED SPECIFICATIONS –
CONTRACT SEQ200436 / HWQ121B4

necessary to permit proper planting.

5. Disposal: Remove and dispose of all excess excavations and unsuitable materials. Dispose in accordance with all local laws and regulations at Contractor's cost.
6. Apply topsoil, utilizing small equipment that does not compact soil.
7. Plant Beds: All plant material shall be planted in existing on-site and/or locally available topsoil, except for shallow plantings installed within the specified four-inch (minimum) topsoil layer.
8. Bare root material shall be adequately protected from drying out and immediately heeled in after inspection. The bundles of heeled-in plants shall be set upright on the ground, covered with mulch, and kept adequately moist until the time of installation. Until the time of planting, all plant material shall be stored in an approved location, securely fenced and maintained, to the satisfaction of the Engineer, at no additional cost to the City. All plants not planted immediately shall be watered as necessary to maintain optimal health until planting.
9. Setting Plants: Plant all plants to the same depth as their place of growth, unless otherwise directed. Center the plants in their planting pits. Set in the natural upright position at such a level that, after settlement, a normal or natural relationship of the crown of the plant with the ground surface shall be established. Be careful not to exert any pressure that will damage any portion of the plant.
10. Topsoil mix shall be lightly tamped around the base of all plants and trees. Avoid compacting the soil. As clay soils are particularly prone to compaction, especially if worked when wet, transplant into clay soils when they are not saturated to the greatest extent possible. Do not leave plants exposed to sun or wind prior to planting. Take special care to avoid desiccation of fibrous-rooted plants.

DIVISION VII - DETAILED SPECIFICATIONS –
CONTRACT SEQ200436 / HWQ121B4

11. The Contractor shall be liable for any damage to property caused by planting operations and the Contractor shall, without any additional cost, restore to original condition or replace all trees, plant beds, lawns, meadows and all construction disturbed or damaged in performing the work of this Contract.

6. Method of Work. Submit a list of proposed methods of execution of work under this section for review by the Engineer when proposed methods are different from, or supplementary to, those specified herein.

J. Temporary Seed Mixture

1. Soil stockpiles shall be seeded with a temporary seed mixture if they will be in place for greater than 30 days. Cleared and graded areas shall also be seeded with a temporary seed mixture to temporarily stabilize them, if they will not be landscaped or planted (final) within 30 days of being cleared.
2. Seed mixture – Temporary seeding shall be Ryegrass (annual or perennial) at a rate of 30 lbs per acre or 0.7 lbs per 1,000 sq. ft. If area is seeded during months of October and November, certified "Aroostook" winter rye (cereal rye) shall be used at a rate of 100 lbs per acre or 2.5 lbs per 1,000 sq. ft.
3. Temporary seeding shall be made within 24 hours of construction/disturbance. If not, the soil must be scarified prior to seeding.
4. Method of seeding – seed shall be evenly applied with broadcast seeder, drill or cultipack seeder.
5. If temporary seeding is made under favorable soil and site conditions during the optimum seeding dates (March 21 – May 20 or August 25 – October 15) mulch is not required. Any temporary seeding outside of those dates shall be mulched with salt hay mulch at a rate of 2 tons per acre (100-200 bales/acre).
6. Any area which fails to establish vegetative cover adequate to prevent rill erosion will be reseeded as soon as such areas are identified.

K. Permanent Seed Mixture

1. Seed materials shall be inspected by the Engineer upon arrival at the job site and prior to planting. Any materials not in compliance

DIVISION VII - DETAILED SPECIFICATIONS –
CONTRACT SEQ200436 / HWQ121B4

with specifications shall not be accepted and shall be removed from the job site immediately.

2. All seed materials shall be protected from drying out and from wind damage during delivery.
3. All areas shown to receive seed on Contract Drawings and all areas which are disturbed and not planted shall be seeded.
4. Seedbed Preparation – Scarify all compacted areas and remove all debris and obstacles such as rocks and stumps.
5. Do not broadcast seed by mechanical application when the wind velocity is such as to prevent uniform seed distribution.
6. Apply seed at the rate(s) specified on the Contract Drawings.
7. Time of Seeding – Permanent seeding shall be done within 15 days of final construction activities. Optimum seeding times are in the spring from March 15 – May 15 and in fall from September 15 – October 15. If construction is completed during mid-summer, seeding may be done if watering will be provided. After October 15 and up to March 15, mulch should be applied until the permanent seeding can be done during the recommended seeding dates.
8. Method of Seeding – Seed shall be broadcast by hand or mechanically using a drop-hopper. The seed shall then be sown to depths of 0-0.25" using an ATV pulling a weighted drag of the same width as the ATV, with bolts inserted every 4-6" along its width in order to open up furrows in the soil of up to 0.25" in depth. The ATV should drag the seeded area a minimum of four (4) times.
9. Following the seeding operation, 10-10-10 fast release fertilizer shall be broadcast at a rate of 400 lbs/acre throughout the seeded area by hand or mechanically using a cyclone broadcaster. Seed shall be watered as recommended by the seed manufacturer to achieve specified growth coverage.
10. Mulching straw of oat or wheat stalks shall be applied at a rate of 2 tons per acre (100-200 bales/acre). Hay is not acceptable due to its high weed content.
11. Seeding shall be deemed acceptable when 85% coverage of the seeded area with the seeded species has been achieved. Any area

DIVISION VII - DETAILED SPECIFICATIONS –
CONTRACT SEQ200436 / HWQ121B4

not meeting this requirement shall be reseeded with the original seed mix.

L. Final Acceptance

Herbaceous plants must be thriving. Planting beds must be evenly mulched and free of invasive nonnative plant species. Paving/landscape interface must be a smooth, crafted transition free from defects such as gaps, sharp edges or sudden level changes.

M. Final Cleanup

At time of final inspection of work, and before final acceptance, clean any paved areas that are dirty or stained due to work of this Section by sweeping or washing, and remove any defacements or stains. Remove construction equipment, excess materials and tools. Remove from site any debris and dispose of off-site, in accordance with all local laws, and at the Contractor's expense. The Contractor shall also cut all perimeter grass and weeds before final acceptance.

N. Wetland and Aquatic Plantings:

1. Installation

The Contractor shall complete all work in the best manner, so that the work as a whole is of uniform quality and appearance. The Contractor shall conform to the requirements specified hereafter.

- a. At the elevations described and shown on the plans, the areas shall be fine graded, prepared for planting and landscaped.
- b. Subgrade shall be kept free of waste material and debris. Subgrade shall be compacted prior to topsoil application at the Engineer's direction.
- c. Remove stones over 1-1/2 inches in any dimension, as well as sticks, rubbish and other extraneous matter.
- d. The planting areas shall be worked up well, and shall be free of other vegetation and large clods of soil.
- e. Install erosion control mat.
- f. Apply fertilizer at rate specified in Contract Drawings during planting and seeding operations.

DIVISION VII - DETAILED SPECIFICATIONS –
CONTRACT SEQ200436 / HWQ121B4

2. Erosion Control Blankets
 - a. Center a blanket in the bottom of the wetland area and anchor the erosion control blankets in a minimum 8" x 8" slot using five evenly spaced staples. Unroll blankets carefully in the direction of water flow, being careful to place blankets loosely and in full contact with the soil.
 - b. Overlap blanket edges approximately 4" with downstream edges over upstream edges.
 - c. Staple blankets using approximately 3 staples per square yard.
 - d. Overlap blanket ends 6" in a minimum 8" x 8" check slot, upper blanket over lower blanket and staple using five evenly spaced staples.
 - e. Cut excess blanket with scissors and anchor at the entrance to the weir/micro pool in a minimum 8" x 8" check slot with five evenly spaced staples.
 - f. Blanket shall not float or bubble anywhere after wetland is inundated with water.

3. Planting Operations
 - a. Layout: All plants shall be laid out in random and naturalistic arrangements, as specified in the Contract Drawings unless otherwise directed by the Engineer. All plant and planting area locations shall be staked prior to planting by the Engineer. Place no plantings within two (2) feet of pavements or structures, unless otherwise indicated.
 - b. When planting containerized wetland plants, care shall be taken so as not to set the plants in water where there is in excess of 3" - 4" of water between the top of plant and the water surface. When planting dormant wetland plants, care shall be taken so as not to set the plants in water where there is in excess of 12" - 14" of water between the top of plant and the water surface.
 - c. When planting containerized or tube wetland plants, care shall be taken so to set the plants in the water regime noted on the Contract Drawings plant schedule.

DIVISION VII - DETAILED SPECIFICATIONS –
CONTRACT SEQ200436 / HWQ121B4

- d. Rototill/cultivate soils to a depth equal to the depth of the root ball and two times the diameter of the root ball. Set the tree/shrub on the solid ground in the center of the area.
- e. Obstructions Below Ground: remove any rock, rubble, masonry, concrete, metal, stones over one inch in diameter or other underground obstructions to the depth necessary to permit proper planting.
- f. Disposal: Remove and dispose of all excess excavations and unsuitable materials. Dispose in accordance with all local laws and regulations at Contractor's cost.
- g. The storm sewers tributary to BMPs should not be put into service for 6 to 8 weeks after completion of the associated wetland plantings. This will permit the wetland plantings to establish themselves.

O. Measurement and Payment

The quantity to be measured for payment under this section shall be the total amount of trees, shrubs, herbaceous plants and seeded areas furnished, planted and maintained.

The contract price per unit for Landscaping Work shall be as indicated on the BID SCHEDULE OF PRICES Item No. BMP-7.401-J. The price bid shall be a separate unit price per herbaceous plant specified within the Contract Drawings, and shall include the costs of all excavating and preparing planting pits and beds, adding soil amendments, furnishing plants, digging, inspecting, planting, pruning, staking, guying, anchoring, wrapping, mulching, fertilizing, furnishing seed, seeding, liming, discing, raking, tilling harrowing, mowing, material, and maintaining all plant material and seeded areas. The price bid shall also include the costs of all rough and fine grading, all specified soils necessary and required for the satisfactory completion of all landscaping work and all other work incidental thereto in accordance with the plans and specifications to the satisfaction of the Engineer.

The contract price per square foot of seeding shall be as indicated on the BID SCHEDULE OF PRICES Item No. BMP-7.401-I.

DIVISION VII - DETAILED SPECIFICATIONS –
CONTRACT SEQ200436 / HWQ121B4

PLANT MATERIAL SUMMARY FOR LANDSCAPING WORK

<u>Item</u>	<u>Description</u>
BMP-7.401-I inclusive	Seeding
BMP-7401-J inclusive	Herbaceous Plants – Plugs

* * * * *

DIVISION VII - DETAILED SPECIFICATIONS –
CONTRACT SEQ200436 / HWQ121B4

7.402

SOD

NO TEXT ON THIS PAGE

DIVISION VII - DETAILED SPECIFICATIONS –
CONTRACT SEQ200436 / HWQ121B4

7.403 TOPSOIL FOR RESTORED AREAA. Description of Work

Under this item, the Contractor shall prepare topsoil areas and shall furnish, place and incorporate topsoil in accordance with the plans and specifications or as directed by the Engineer.

The Contractor shall be liable for any damage to property caused by topsoiling operations and all areas of construction disturbed shall be restored to their original condition to the satisfaction of the Engineer.

B. Material

Material shall consist of natural loam topsoil, free from subsoil. It shall be removed to a maximum depth of one (1) foot, or until subsoil is encountered. Topsoil shall be of uniform quality, friable, free from hard clods, stiff clay, hard pan, partially disintegrated stone, stones larger than one (1) inch diameter, lime, cement, ashes, slag, concrete, tar residues, tarred paper, gasoline, motor oil, or other petroleum hydrocarbons, boards, brush, weeds, stalks, roots, sods, chips, sticks or any other undesirable material. Invasive, nonnative seed shall not be allowed in the topsoil material.

All topsoil shall be tested by a New York State Cooperative Extension office or by an approved analytical laboratory with 5 years documented history of soil testing for state, city or county projects.

Topsoil from site stripping shall be tested prior to stripping. Soil test shall be performed per five (5) acres and at the extremes of elevations. After site topsoil has been stripped, stockpiled, and amended per soil test results, the stockpiled topsoil shall be tested again. For imported and stockpiled topsoil, soil tests shall be required and shall serve as a representative analysis for every 200 cubic yards of material utilized.

Topsoil shall comply with the following requirements: No topsoil shall be delivered in a frozen or muddy condition.

1. Organic Content: Topsoil shall contain a minimum four (4) percent organic matter and a maximum of fifteen (15) percent organic matter determined by loss, on ignition, of moisture-free samples dried in accordance with the current method of the Association of Official Agricultural Chemists. The acidity range shall be pH 5.5 to pH 6.5 inclusive.

DIVISION VII - DETAILED SPECIFICATIONS –
CONTRACT SEQ200436 / HWQ121B4

2. Nutrient Content: Magnesium, nitrogen, potassium, phosphorus levels, and soluble salts.

<u>Range (ppm)</u>		<u>Nutrient</u>
4	– 8	Phosphorus (P)
66	– 100	Magnesium (Mg)
115	– 164	Potassium (K)
0.36	- 0.75	Boron (B)
0	– 49	Iron (Fe)
0.5	– 1.0	Zinc (Zn)
85	– 120	Nitrogen (N)

Soluble salts shall be less than 2.5 millimhos.

3. Total Petroleum Hydrocarbon Content: Topsoil shall be tested for total petroleum hydrocarbons (TPH) by the Gravimetric-Hexane Method, as approved by the US Environmental Protection Agency. Topsoil shall contain less than 150 ppm total petroleum hydrocarbons. All soil testing positive shall be rejected and removed from the site.

4. Sieve Analysis: (By Wash Test, ASTM Designation C117)

The mechanical analysis of the soil shall be as follows:

Passing 2" sieve 100%
 Passing 1" sieve 95% to 100%
 Passing #4 sieve 90% to 100%
 Passing #100 sieve 30 % to 60%

5. Electrical Conductivity: Topsoil should have a maximum electrical conductivity of 1,000 micromhos/centimeter.
6. Invasive, Nonnative Plant Species: Topsoil shall be free of invasive nonnative plant propagules or if present, topsoil shall be sterilized with documentation.

When topsoil otherwise complies with the requirements of the specifications but shows an organic matter deficiency of not more than one (1) percent, organic matter may be incorporated when and as permitted by the Engineer.

The Contractor shall at the direction and discretion of the Engineer, or when quantities exceed two hundred (200) cubic yards, furnish a certified report of an approved analytical chemist showing the analysis of

DIVISION VII - DETAILED SPECIFICATIONS –
CONTRACT SEQ200436 / HWQ121B4

representative samples of the topsoil which he/she proposes to use. All samples are to be taken by the Engineer and delivered to the laboratory. The price bid shall include inspection and laboratory charges. No topsoil shall be delivered until the approval of samples by the Engineer, but such approval shall not constitute final acceptance. The Engineer reserves the right to reject on or after delivery any material which does not, in his/her opinion, meet these specifications.

The Engineer reserves the right to reject topsoil in which more than sixty (60) percent of the material passing the No. 100 U.S.S. mesh sieve consists of clay as determined by the Buoyoucoucous Hydrometer or by the decantation method. All percentages are to be based on dry weight of sample. If the Engineer directs, topsoil which varies only slightly from the specifications may be made acceptable by such corrections as the Engineer deems necessary.

C. Preparation of Topsoil Areas

Before any topsoil is placed, the subgrade shall be graded to a smooth, uniform surface, parallel to and below finished grade, the depths of which are shown on the plans or as directed by the Engineer. The subgrade surface shall be compacted with an approved roller weighing approximately five hundred (500) pounds. Hollows, depressions and gullies shall be filled with acceptable material free from stones over one (1) inch in diameter, cinders, rubbish and other unsuitable material. Fill which is four (4) inches or more in depth shall be compacted to the satisfaction of the Engineer.

All bumps, mounds, and ridges shall be cut down to subgrade elevations as shown in the Contract Drawings. All areas of the subgrade that are not in a friable condition shall be loosened to a depth of twelve (12) inches as directed by the Engineer. All surplus material and debris shall be removed and disposed of as directed by the Engineer.

D. Spreading

Topsoil for upland areas shall be spread and compacted to the overall depth of that which exists within the restoration area or to three (3) inches, whichever is greater. Topsoil for wetland areas shall be spread and compacted to the overall depth of that which exists within the wetland area or to four (4) inches, whichever is greater. The contractor shall use the lightest equipment appropriate to spread and compact the topsoil. Topsoil shall not be handled when, in the opinion of the Engineer, it is too wet.

DIVISION VII - DETAILED SPECIFICATIONS –
CONTRACT SEQ200436 / HWQ121B4

Topsoil for backfilling planting pits and planting beds shall be mixed with compost having the general properties of humus in the following proportions:

Two (2) parts of topsoil to one (1) part of compost. They shall be thoroughly mixed by placing the compost evenly over the topsoil piles and turning the piles at least three (3) times or until thoroughly mixed to the satisfaction of the Engineer.

Topsoil mixed on-site must be tested by the Contractor and have a pH of 5.5-6.5.

The finish grade shall not be excessively compacted. Finish grade to 12" below soil surface shall be loose, friable soil and not excessively compacted to the satisfaction of the Restoration Specialist. Maximum acceptable compaction is to 83% of the standard (AASHTO) Proctor maximum dry density. Conversely, soil shall not be so loose that there is potential for extensive settlement, slumping, soil erosion, or excessive drainage. On-site compaction tests, if required, shall be a standard test such as Nuclear Density Meter, or Sand Cone, or Balloon Density performed at contractor expense. After finish grading, and prior to installation of any erosion control fabric, planting, seeding, the Restoration Specialist shall inspect extent of soil compaction. Restoration Specialist shall re-inspect extent of compaction after completion of all site work. If required, Contractor will be required to loosen top 12" of soil to the satisfaction of the Restoration Specialist.

E. Mycorrhizal Inoculants

Mycorrhizal inoculants shall not be used.

F. Measurement and Payment

The quantity of topsoil to be paid for under this item shall be the number of cubic yards of topsoil furnished from off-contract site sources (i.e. suppliers approved by the engineer), mixed, placed and incorporated in the completed work in accordance with the plans and specifications to the satisfaction of the Engineer, measured in trucks used for delivery, at the site of the work. The quantity of topsoil to be paid for under this item shall be measured in cubic yards in trucks used for delivery. No topsoil shall be furnished until ordered by the Engineer. (No deductions shall be made except for the volume of topsoil displaced by balls of trees, except in paved areas). Delivery ticket with name and address of vendor, date and estimated volume must be supplied to the Engineer prior to truck measurement.

DIVISION VII - DETAILED SPECIFICATIONS –
CONTRACT SEQ200436 / HWQ121B4

The contract price per unit for Topsoil shall be as indicated on the BID SCHEDULE OF PRICES Item No. BMP-7.403. The bid price shall be a unit price per cubic yard of topsoil, and shall include the cost of all labor, materials and equipment necessary to prepare topsoil areas, furnish, mix, place and incorporate topsoil and compost, and all other work incidental thereto, in accordance with the plans and specifications to the satisfaction of the Engineer.

* * * * *

DIVISION VII - DETAILED SPECIFICATIONS –
CONTRACT SEQ200436 / HWQ121B4

7.404-A RESTORATION SPECIALIST (CONSTRUCTION MONITOR)

A. Description of Work

The Contractor is advised that the portions of work within this Contract pertaining to the construction of the BMP's and all other work in the project area shall require the supervisory expertise of a Restoration Specialist. The Restoration Specialist shall supervise all restoration work performed by the Contractor and his/her Subcontractors for the duration of the project, in accordance with the plans, specifications and directions of the Engineer. The Restoration Specialist shall also be responsible for overseeing the implementation of the project's soil erosion control plan. In addition, the Restoration Specialist shall be cognizant of all conditions of the NYSDEC and/or U. S. Army Corps of Engineers freshwater wetlands permit for the project, as they relate to work in the wetlands. Furthermore, the Restoration Specialist shall be responsible for overseeing all installation of plant material. The Restoration Specialist shall report to the NYCDDC representative or the Engineer. The qualifications of the Restoration Specialist shall be approved by the NYCDDC and on-site prior to the start of any work.

B. Qualifications

The Restoration Specialist utilized to perform the work required must have performed at least three (3) projects similar in scope and type to the required work in the previous five (5) years. The Restoration Specialist shall be a Registered Landscape Architect or have equivalent professional experience. Prior to the start of work, the Contractor shall be required to submit the names and resumes of at least three prospective candidates to NYCDDC or the Engineer. NYCDDC or the Engineer will approve the qualifications of the prospective candidates or alternatively ask for more choices, if the candidates are not deemed to be qualified.

C. Site Monitoring

The Restoration Specialist shall monitor the Contractor's in-place erosion and sediment control devices, including, but not limited to, construction (limiting) fences, siltation fences, staked straw bales, etc., and shall notify the Contractor when maintenance or repair of these devices is necessary. The Restoration Specialist shall monitor related/adjacent construction to insure that these activities do not adversely impact restoration activities or the success of the restoration work.

D. Restoration Supervision

DIVISION VII - DETAILED SPECIFICATIONS –
CONTRACT SEQ200436 / HWQ121B4

The Restoration Specialist shall supervise all aspects of the BMP installation and all other work in the project area including Wildlife Control and removal, in-stream sediment removal work, plant and sod salvage, and perimeter restoration work. The Restoration Specialist shall oversee all landscaping activities including installation of plant material related to the BMP installation and all other work in the project area including streambank stabilization.

E. Design and Design Review

The Restoration Specialist shall prepare, design and review design work as needed during construction. This work shall include but not be limited to the following:

- a. research and prepare design revision/modification drawings,
- b. research and prepare revisions/modifications to detailed specifications,
- c. prepare supplemental field sketches,
- d. review and critique design modification drawings and supplemental drawings.

The Restoration Specialist shall undertake this work when directed by the NYCDDC as represented on-site by the NYCDDC representative, its agent, or the Engineer.

F. Photo Documentation

The Restoration Specialist shall keep a digital photograph log of the BMP and BMP-related portion of the project. The photo log will follow the progress of the project, in a clear and understandable progression, and shall incorporate before, in progress and completed photographs of BMP's and natural area restorations within the project. Fixed photopoints shall be used at each site to ensure that before and after photographs are taken from the same location and angle. The photo log will be utilized by NYCDDC for required reports, etc.

The Restoration Specialist shall use a digital camera with a minimum resolution of 4.1 megapixels for use during all phases of the project for photo-documentation purposes. The Restoration Specialist shall assemble the completed photo log onto CD's and transmit the complete photo log to DDC or the Engineer.

DIVISION VII - DETAILED SPECIFICATIONS –
CONTRACT SEQ200436 / HWQ121B4

G. Monitoring Reports

The Restoration Specialist shall prepare and submit a Monitoring Report to the NYCDDC representative, its agent, or the Engineer following the completion of all planting and associated restoration activities. The Restoration Specialist shall continue to submit an annual Monitoring Report until the guarantee period(s) for the plant material has expired. Six (6) copies of each report submittal shall be required.

The Restoration Specialist shall examine, monitor and report on the various components of the restoration and shall incorporate color photographs, color photocopies, graphs, etc., as appropriate. All information shall be reported in a concise format. The Monitoring Report shall:

- report on all construction activities related to BMP and streambank stabilization,
- report the conditions of the vegetation planted within this Contract,
- quantify survival and cover rates and compare to permit requirements,
- recommend replacement species,
- report observed impacts to existing vegetation,
- report success rates in controlling erosion and sedimentation,
- report voluntary recruitment, and;
- present recommendations.

H. BMP As-Built Plans and Information

The Contractor shall be responsible for providing to the Restoration Specialist an as-built survey of all BMP areas as an electronic file. The Restoration Specialist shall verify the Contractor's information and include his/her landscape information and any other additional planting or natural features. See the BMP As-Built section under the Special Provision section, specification section 7.414 for details and requirements for the survey(s).

I. Measurement and Payment

DIVISION VII - DETAILED SPECIFICATIONS –
CONTRACT SEQ200436 / HWQ121B4

The quantity to be measured for payment under this section shall be the total number of hours necessary for the supervision of all restoration work within this Contract, site monitoring, design and diagram review, photo documentation, preparation of monitoring reports and completion of the as-built plans in accordance with the plans, specifications and direction of the Engineer, performed prior to the date of Substantial Completion.

Payment to the Restoration Specialist for all required work, including work performed both during active construction and after the date of Substantial Completion through the end of the three year Maintenance and Guarantee Period, shall be made during the period of active construction up to and including the date of Substantial Completion. There will be no transfer of contract monies during the Maintenance and Guarantee Period.

As the post-construction site monitoring, monitoring report preparation, and other related work must be undertaken and prepared during the three-year Maintenance and Guarantee Period, payment for this work shall be made by the Contractor to the Restoration Specialist prior to the Maintenance Guarantee Period.

For supplying all labor, materials and equipment necessary for Restoration Specialist, the Contractor shall receive a unit price bid.

The contract price per unit for Restoration Specialist shall be as indicated on the BID SCHEDULE OF PRICES Item No. BMP-7.404-A. The unit price bid shall include the costs for all labor, materials, equipment and incidental expenses necessary or required to complete the work in accordance with the plans and specifications to the satisfaction of the NYCDDC representative, its agent, or Engineer.

No separate or additional payment will be made for work performed in accordance with the requirements of this section during the Maintenance and Guarantee Period. In addition, said work shall be considered a part of the Maintenance and Guarantee and subject to the provisions thereof should the Contractor fail to complete this work as specified.

* * * * *

DIVISION VII - DETAILED SPECIFICATIONS –
CONTRACT SEQ200436 / HWQ121B4

7.404-B EROSION AND SEDIMENT CONTROL LICENSED/CERTIFIED PROFESSIONAL

A. Description of Work

The Contractor is advised to retain the services of an independent Licensed/Certified professional with practical experience in the principles and practices of erosion and sediment control and Stormwater Management to prepare and certify a site specific Stormwater Pollution Prevention Plan (SWPPP) in compliance with the New York State Department of Environmental Conservation (NYSDEC) Pollutants Discharge Elimination System (SPDES) General permit for Stormwater water runoff from construction activities GP-0-10 -001, issued pursuant to Article 17, Titles 7, 8, and Article 70 of the Environmental Conservation Law (ECL). The Certified Professional shall be approved by NYCDDC and be present on-site prior to the start of any work.

Within thirty (30) days after the contract is registered, The Contractor shall submit a complete SWPPP and Notice Of Intent (NOI) to the New York City Department of Design and Construction (NYCDDC) Infrastructure –Engineering Support Unit for review and comments. The Contractor through his Licensed/Certified Professional shall make all necessary revisions required and resubmit the SWPPP and the NOI for acceptance and signature. Work shall not begin until a permit identification number is issued by the NYSDEC, and an initial inspection is conducted by the Licensed/Certified Professional certifying that the appropriate control measures specified in the SWPPP have been adequately implemented to the satisfaction of the Resident Engineer and the Project Manager of the Engineering Support Unit.

B. Qualifications

The Licensed/Certified Professional employed to perform the required work must have previous experience in work of this nature and in completing the necessary submittals required under this Contract. The Certified Professional shall be a Professional Engineer or a Landscape Architect licensed to practice in New York State, or a Soil and Water Conservation Society Certified Professional in Erosion and Sediment Control (CPESC). Prior to the start of work, the Contractor is required to submit the names and resumes of at least three (3) prospective candidates to the NYCDDC for approval. The NYCDDC shall make a selection or alternatively ask for more choices, if they deem the candidates to be unqualified.

C. Site Monitoring, Inspection and Reports

DIVISION VII - DETAILED SPECIFICATIONS –
CONTRACT SEQ200436 / HWQ121B4

The Certified Professional shall monitor the Contractor's in-place erosion and sediment control devices, including, but not limited to, Turbidity Curtain, Reinforced Silt fence, Stake Straw Bales, Stabilized Construction Entrance, Storm Drain Inlet Protection Measure, Portable Sediment Tanks, and site dewatering measures, and shall notify the Contractor when maintenance or repair of these devices is necessary.

Following the start of construction activities, site inspections shall be conducted by the Certified Professional at least once a week and within 24 hours of rainfall events of 0.5 inches or greater. For construction sites where soils disturbance is greater than five (5) acres at one time, the Certified Professional shall conduct at least two (2) site inspections every seven (7) calendar days and within twenty-four (24) hours of the end of each rainfall event of 0.5 inches or greater. The two inspections shall be separated by a minimum of two (2) full calendar days. Subsequent to each inspection, the Certified Professional shall prepare an inspection report and submit the original to the Resident Engineer and one copy to the Infrastructure-Engineering Support Unit. At a minimum, the inspection report shall include, but not limited to, the following information:

1. Date and Time of inspection;
2. Name and Title of person performing the inspection;
3. A description of the weather and soil conditions (e.g dry, wet, saturated) at the time of the inspection;
4. A description of the condition runoff at all points of discharged from the construction site. This shall include identification of any discharges of sediment from the construction site;
5. A description of the condition of all natural surface waterbodies located within or immediately adjacent to the properties boundaries of the construction site which receive runoff from disturbed areas. This shall include identification of any discharges of sediment to the surface waterbody;
6. Record of any evidence of soil erosion on the site, potential for pollutants entering the drainage systems, problems at discharge points (such as turbidity in receiving water) and signs of soil and mud transport from the site to the public road at the limits of the project;
7. Identification of all erosion and sediment control practices that need repair or maintenance;
8. Identification of all erosion and sediment practices that were not installed properly or are not functioning as designed and need to be reinstalled or replaced;
9. Description and sketch of areas that are disturbed at the time of the inspection and areas that have been stabilized (temporary and/or final) since the last inspection;

DIVISION VII - DETAILED SPECIFICATIONS –
CONTRACT SEQ200436 / HWQ121B4

10. Corrective actions that must be taken to install, repair, replace or maintain erosion and sediment control practices; and to correct deficiencies identified with the construction of post-construction stormwater management practices;
11. Digital photographs, with date stamp, that clearly show the condition of all practices that have been identified as needing corrective actions. The Qualified Inspector shall attach paper color copies of the digital photographs to the inspection report. He shall also take digital photographs with date stamp, that clearly show the conditions of the practice(s) after the corrective actions has been completed;
12. Within one business day of the completion of an inspection, the Qualified Inspector shall notify the Contractor and the Resident Engineer of any corrective actions that need to be taken. The Contractor shall begin implementing the corrective actions within one business day of this notification; and
13. All the inspection reports shall be signed by the Licensed Professional.

The Contractor shall retain a signed copy of the General Permit GP-0-10-001, NOI, SWPPP, signed MS4 SWPPP Acceptance form, NOI Acknowledgment Letter and all original inspection reports required by this general permit at the construction site in a prominent place for public viewing from the date of initiation of construction activities to the date of final stabilization and the Notice of Termination (NOT) has been submitted to the NYSDEC. These documents must be made available to the permitting authority upon request. Prior to starting construction, the Contractor shall certify in the site logbook that the SWPPP was prepared in accordance with the requirements of the permit and it meets all federal, state and local erosion and sediment control requirements.

In addition, the Contractor and Subcontractors shall identify at least one person who is an employee of the company that will be responsible for a day to day implementation of the SWPPP. The name and telephone number of this person should be listed in the SWPPP. This person shall be known as the Trained Contractor and shall have received a DEC-endorsed four (4) hours of Erosion and Sediment Control training. After receiving the initial training, the Trained Contractor shall attend a four (4) hours training every three (3) years. The Contractor shall ensure that at least one Trained Contractor is on site on a daily basis when soil disturbance activities are being performed.

Performing implementation of a SWPPP on a permitted construction project without a Trained Contractor on site daily is a violation of Part III.A.6 of the SPDES General Permit. Stormwater controls must be maintained in good operating condition until all disturbed soils are

DIVISION VII - DETAILED SPECIFICATIONS –
CONTRACT SEQ200436 / HWQ121B4

permanently stabilized. Control devices in need of repair should be repaired promptly after identification.

Prior to filing of the Notice of Termination (NOT), or at the end of the permit term, the Contractor shall have the Licensed Professional perform a final site inspection. The Licensed Professional shall certify that the site has undergone final stabilization using either vegetative or structural stabilization methods and that all temporary erosion and sediment controls (such as silt fencing) not needed for long term erosion control have been removed. Subsequently, the Contractor shall submit a complete NOT to the Engineering Support Unit to terminate the permit coverage.

Additionally, the Licensed Professional must identify all permanent Stormwater management structures that have been constructed, and provide the owner(s) of such structures with a manual describing the operation and maintenance practices that will be necessary in order for the structures to function as designed after the site has been stabilized.

The Licensed Professional must also certify that the permanent structures have been constructed as described in the SWPPP.

D. Contractor's Liability.

The Contractor shall be liable for any discharge that either causes or contributes to a violation of water quality standards as contained in Parts 700 through 705 of Title 6 of the Official Compilation of Codes, Rules and Regulations of the State of New York. Should any storm water runoff from the site violate the water quality standards, the Contractor will be directed to take immediate steps, at his own expense, to rectify the situation and prevent any further sediment from entering the storm sewer system.

In the event that pollutants are discharged to the storm water system due to the Contractor's negligence, the Resident Engineer will direct the Contractor to cease any or all construction activities contributing to the release of these pollutants. The Contractor shall be held responsible, at his own cost, for any and all necessary actions to remedy the damage.

Furthermore, failure of the Contractor and Sub-contractor(s) to strictly adhere to any permit requirements shall constitute a permit violation that could result in substantial criminal, civil, and administrative penalties.

It is the Contractor's responsibility to pay all the SPDES permit fees which shall consist of the yearly regulatory fee, the initial authorization fee per acre of land disturbed and per acre of future impervious area. The

DIVISION VII - DETAILED SPECIFICATIONS –
CONTRACT SEQ200436 / HWQ121B4

Contractor shall be liable for all penalties incurred due to his failure to pay these fees on time.

E. Measurement and Payment

The quantity to be measured for payment under this section shall be the total number of days necessary to prepare the required reports to secure the permits; conduct the inspection and supervision of all erosion and sediment control works within this Contract, site monitoring, photo documentation, and preparation of monitoring reports in accordance with the plans, specifications and direction of the resident engineer, performed prior to the date of substantial completion.

The Contractor shall receive a unit price bid for supplying all labor, materials and equipment required by the Certified Professional.

The contract price per unit for the Licensed/Certified Professional shall be as indicated on the Bid Schedule of Price for Item No. BMP-7.404-B. The unit price bid shall include, but not be limited to, the cost of furnishing all the labor, materials, fees, permits and testing required to prepare the SWPPP, provide and construct all erosion and sediment control devices in accordance with the approved SWPPP; inspect and monitor the work; comply with NYSDEC permitting requirements and all necessary incidentals to complete the work all in accordance with the specifications and the directions of the Engineer.

* * * * *

DIVISION VII - DETAILED SPECIFICATIONS –
CONTRACT SEQ200436 / HWQ121B4

7.405

VECTOR, PEST AND WILDLIFE CONTROL

NO TEXT ON THIS PAGE

DIVISION VII - DETAILED SPECIFICATIONS –
CONTRACT SEQ200436 / HWQ121B4

7.406

WOOD CHIPS

NO TEXT ON THIS PAGE

DIVISION VII - DETAILED SPECIFICATIONS –
CONTRACT SEQ200436 / HWQ121B4

7.407-A EROSION CONTROL MAT - STRAW

A. Description of Work

Under this item, the Contractor shall furnish and place erosion control mat for slope protection within areas designated on the plans or where directed by the Engineer.

B. Material

The Erosion Control Mat shall meet the following requirements:

Netting	Two Side, Organic Leno Weave Jute, 100% Biodegradable 0.5" x 1.0" opening
Matrix	100% Agriculture Straw 0.55 lbs/yd ² 298.4 g/m ²
Thread	1.5" stitch space, Biodegradable

Index Value Properties

<u>Property</u>	<u>Test Method</u>	<u>Typical</u>
Mass/Unit Area	ASTM D6475	10.00 oz/yd ²
Thickness	ASTM D6525	.40 in
Tensile Strength-MD	ASTM D6818	106 lb/ft
Elongation-MD	ASTM D6818	16.7%
Tensile Strength-TD	ASTM D6818	118 lb/ft
Elongation-TD	ASTM D6818	26.8%
Light Penetration	ASTM D6567	6%
Water Absorption	ASTM D1117	322%
Unvegetated Shear Stress	ASTM D6460	1.55 lbs/ft ²
Slope		3:1 or flatter

The Erosion Control Mat shall be manufactured by East Coast Erosion Blankets, Bernville, PA, or approved equal.

Wire Staples shall consist of 12-inch lengths of No. 11 gauge wire bent to form a "U" or other wire staples as approved.

C. Method

DIVISION VII - DETAILED SPECIFICATIONS –
CONTRACT SEQ200436 / HWQ121B4

Erosion control mat shall be placed on topsoil perpendicular to slope contours where directed by the Engineer. Erosion control mat shall be laid without stretching so that it lies loosely on the soil and in contact with the soil at all points and shall be pressed firmly into the soil surface by rolling or tamping. If seeding is required, it shall be done prior to the installation of the erosion control mat.

The upper end of each roll of erosion control mat shall be turned and buried to a depth of six (6) inches, with the soil firmly tamped against it. Erosion control matting shall have a minimum lap of six (6) inches on all sides. Ends of rolls shall also have a minimum lap of six (6) inches with the upgrade section on top.

Check slots shall be constructed at intervals of 50 feet, unless otherwise directed by placing a fold of erosion control mat six (6) inches vertically into the ground with replaced soil tamped firmly against it.

Erosion control mat shall be held tightly to the soil by wire staples driven firmly into the ground. Wire staples shall be spaced not more than three (3) feet apart, along the sides and center of the erosion control mat and not more than one (1) foot apart at roll ends, check slots and at other critical areas as determined by the Engineer.

D. Maintenance

The Contractor shall maintain the areas of erosion control mat installation until final acceptance of the contract. Maintenance shall consist of providing protection for erosion control mat and repair of areas damaged by equipment, erosion, fire, or other causes, as well as re-establishment of the grade and conditions of the area as specified.

E. Measurement and Payment

The quantity to be measured for payment under this Section shall be the number of square feet of surface area on which erosion control mat has been installed in accordance with the plans and specifications and directions of the Engineer.

The Contract price per square feet of Erosion Control Mat - Straw shall be as indicated on the BID SCHEDULE OF PRICES Item No. BMP-7.407-A. The bid price shall include the costs for all labor, material, equipment and incidental in accordance with the plans and specifications to the satisfaction of the Engineer.

* * * * *

DIVISION VII - DETAILED SPECIFICATIONS –
CONTRACT SEQ200436 / HWQ121B4

7.407-B EROSION CONTROL MAT – CURLED WOOD OR COCONUT FIBER

A. Description of Work

Under this item, the Contractor shall furnish and place erosion control mat (ECM) - curled wood or coconut fiber for slope protection within areas designated on the plans or where directed by the Engineer.

B. Material

1. The mat shall be 100% biodegradable and consist of machine-produced mat of curled wood excelsior or coconut fiber with a majority of the fibers 6 inches or longer with consistent thickness and the fibers evenly distributed over the entire area of the mat.
2. Curled wood or coconut fiber ECM shall be American Excelsior Curlex II with FibreNet, North American Green C125BN, or approved equal matting with a minimum bare soil shear stress value of 2.0 lb/ft².

Wire Staples shall consist of 12-inch lengths of No. 11 gauge wire bent to form a "U" or other wire staples as approved.

C. Method

Erosion control mat shall be placed on topsoil perpendicular to slope contours where directed by the Engineer. Erosion control mat shall be laid without stretching so that it lies loosely on the soil and in contact with the soil at all points and shall be pressed firmly into the soil surface by rolling or tamping. If seeding is required, it shall be done prior to the installation of the erosion control mat.

The upper end of each roll of erosion control mat shall be turned and buried to a depth of six (6) inches, with the soil firmly tamped against it. Erosion control matting shall have a minimum lap of six (6) inches on all sides. Ends of rolls shall also have a minimum lap of six (6) inches with the upgrade section on top. All anchor and transverse trenches shall be a minimum of 12 inches deep.

DIVISION VII - DETAILED SPECIFICATIONS –
CONTRACT SEQ200436 / HWQ121B4

Check slots shall be constructed at intervals of 50 feet, unless otherwise directed by placing a fold of erosion control mat six (6) inches vertically into the ground with replaced soil tamped firmly against it.

Erosion control mat shall be held tightly to the soil by wire staples driven firmly into the ground. All mat shall be stapled as per manufacturer's specifications with staples spaced not more than three (3) feet apart, along the sides and center of the erosion control mat and not more than one (1) foot apart at roll ends, check slots and at other critical areas as determined by the Engineer.

D. Maintenance

The Contractor shall maintain the areas of erosion control mat installation until final acceptance of the contract. The Contractor will immediately repair or replace any section of curled wood or coconut fiber ECM which is not functioning properly or has been damaged in any way until a stable growth of grass has been established.

Maintenance shall consist of providing protection for erosion control mat and repair of areas damaged by equipment, erosion, fire, or other causes, as well as re-establishment of the grade and conditions of the area as specified.

E. Measurement and Payment

The quantity to be measured for payment under this Section shall be the number of square feet of surface area on which erosion control mat has been installed in accordance with the plans and specifications and directions of the Engineer.

The Contract price per square feet of Erosion Control Mat – Curled Wood or Coconut Fiber shall be as indicated on the BID SCHEDULE OF PRICES Item No. BMP-7.407-B. The bid price shall include the costs for all labor, material, equipment and incidental in accordance with the plans and specifications to the satisfaction of the Engineer.

* * * * *

DIVISION VII - DETAILED SPECIFICATIONS –
CONTRACT SEQ200436 / HWQ121B4

7.408 HERBICIDE APPLICATIONDescription of Work

Under this item, the Contractor shall administer two applications of herbicide to persistent weeds and weedy growth in accordance with the plans and specifications and as directed by the Engineer.

B. Quality Assurance

The Herbicide Applicator must possess a valid NYSDEC Type 5A - Aquatic Vegetation Pesticide Applicator Certification License.

C. Materials and Construction Methods

The work will eradicate invasive, non-native plants in upland areas using Glyphosate for eradication of all plants except Oriental Bittersweet, which will be treated with Garlon 4. All chemicals to be applied using backpack and hand held sprayers and individual stem wipe applications. Herbicide application to open water/marshlands is prohibited.

In Wetlands, the Contractor shall spray Rodeo Herbicide or approved equal onto specified weedy growth only, as directed by the Engineer, between May and September.

The Applicator shall spray to wet--not to the point of runoff. Care must be taken to properly calibrate the tank nozzle so as to direct herbicide spray only onto the undesirable plants and obtain complete coverage of leaves and stems. Avoid spray drift onto desirable plants and minimize spray contact with soil. It is recommended to spray when plants are not under water stress. Only flat pan nozzles shall be used when using a spray applicator. In areas where invasive plants are tightly intermixed with native plants, the applicator shall use the individual wipe or injection method to prevent the accidental treatment of desirable plant material. Marking dyes shall be added to the herbicide at the request of the engineer to prevent the accidental treatment of desirable plant material.

Apply on a warm sunny day (75 degrees to 90 degrees preferred). Do not spray if wind speed exceeds 5 mph or if weather conditions would decrease the effectiveness of the herbicide or increase the intended target area. Do not apply or allow herbicide spray into surrounding waterbodies. Do not exceed the rates indicated on product labels.

A non-ionic surfactant that is labeled for use with herbicides shall be added to the herbicide to help penetrate targeted plants for increased control. Surfactant must contain 50% or more active ingredient.

DIVISION VII - DETAILED SPECIFICATIONS –
CONTRACT SEQ200436 / HWQ121B4

When using water from on-site hydrants, remove all suspended particles that may reduce the effectiveness of the herbicide prior to adding the water to the mixing tank.

All treated areas shall be temporarily posted with signs indicating that the area has been treated with herbicide. Signs shall be clearly posted in areas where the public may come into contact with the plant material.

The Contractor shall return to the site after ten (10) days and remove any dead vegetation that may interfere with planting of new material. If a second application is deemed necessary, a minimum of 10 days is required before installing any new plant material. Planting may proceed when the site is deemed acceptable to the Engineer.

The plant species to be eradicated primarily include, but shall not be limited to the following, and shall include additional species at the direction of the engineer:

Japanese Knotweed (*Polygonum cuspidatum*)
 Multiflora Rose (*Rosa multiflora*)
 Purple Loosestrife (*Lythrum salicaria*)
 Oriental Bittersweet (*Celastrus orbiculatus*)
 Black Locust (*Robinia pseudoacacia*)
 Japanese Honeysuckle (*Lonicera japonica*)
 Common Reed (*Phragmites australis*)
 Mile-A-Minute Vine (*Polygonum perfoliatum*)
 Mugwort (*Artemisia vulgaris*)
 Common Ragweed (*Ambrosia artemisiifolia*)
 Giant Ragweed (*Ambrosia trifida*)
 English Ivy (*Hedera helix*)
 Japanese Stiltgrass (*Microstegium vimineum*)
 Porcelain Berry (*Ampelopsis brevipedunculata*)
 Burning Bush (*Euonymus alatus*)
 Russian Olive (*Elaeagnus angustifolia*)
 Giant Hogweed (*Heracleum mantegazzianum*)
 Tree of Heaven (*Ailanthus altissima*)
 White Mulberry (*Morus alba*)

D. Measurement and Payment

The quantity to be measured for payment under this section shall be the total number of crewdays (shifts) necessary for completion of Herbicide Application. A crewday (shift) is defined as one period from 8AM – 4PM, including lunch and breaks. The crew shall consist of two workers.

DIVISION VII - DETAILED SPECIFICATIONS –
CONTRACT SEQ200436 / HWQ121B4

The contract price per unit for Herbicide Application shall be as indicated on the BID SCHEDULE OF PRICES Item No. BMP-7.408-B. The unit price bid shall include the costs for all labor, materials, equipment and incidental expenses necessary or required to complete the work in accordance with the plans and specifications to the satisfaction of the Engineer.

* * * * *

DIVISION VII - DETAILED SPECIFICATIONS –
CONTRACT SEQ200436 / HWQ121B4

7.409

MYCORRHIZAL INOCULANTS

NO TEXT ON THIS PAGE

DIVISION VII - DETAILED SPECIFICATIONS –
CONTRACT SEQ200436 / HWQ121B4

7.410

PLANT PROTECTION FENCE

NO TEXT ON THIS PAGE

DIVISION VII - DETAILED SPECIFICATIONS –
CONTRACT SEQ200436 / HWQ121B4

7.411

WATERING AND WEEDING DURING GUARANTEE PERIOD

NO TEXT ON THIS PAGE

DIVISION VII - DETAILED SPECIFICATIONS –
CONTRACT SEQ200436 / HWQ121B4

7.412 SLOPE STABILIZATION

NO TEXT ON THIS PAGE

DIVISION VII - DETAILED SPECIFICATIONS –
CONTRACT SEQ200436 / HWQ121B4

7.413 TEMPORARY GOOSE EXCLUSION FENCEA. Description

Under this Item, the Contractor shall furnish, install, maintain and remove a temporary Goose Fence as a protective measure against plant herbivory in both the BMP and mitigation sites, according to the Plans and Specifications and the direction of the Engineer.

The fence shall be a minimum of five (5) feet high above existing grade and the posts shall be a non-tropical hardwood. The fence shall enclose all planted areas so as to prevent geese from entering any newly planted site.

The Contractor shall repair the fence as often as is necessary throughout the guarantee and maintenance period. The Contractor shall remove the entire fence at the end of the maintenance period, or as directed by the Engineer. Removal of fence is included under this Item, no additional payment will be made for this work.

B. Submittals and Materials

The Contractor must submit the following samples or the manufacturer's catalog cuts for approval ten (10) days before beginning work:

1. Non-tropical hardwood stakes (untreated).
2. Black Bi-oriented Utility Fence (TENAXUS or approved equal). The fencing shall meet the following specifications:
 - a. Material: High density UV stabilized polyethylene plastic resin
 - b. Height/length: 48" x 50"
 - c. Weight per roll: 20 lbs
 - d. Nominal mesh opening: 1"
 - e. Tensile strength (range): 2000 - 2310psi
 - f. Elongation at Break (%): 660%
 - g. 1/4" twine or string
 - h. 1" metallic mylar
 - i. 1-1/2" galvanized roofing nails.
 - j. 2" galvanized staples.
 - k. 14" Nylon cable ties.

C. Execution

The goose fence shall be installed by skilled laborers with proper tools and equipment for an aquatic environment within 1 day of completing each 50' section of planting. The Contractor shall drive stakes so that they are level

DIVISION VII - DETAILED SPECIFICATIONS –
CONTRACT SEQ200436 / HWQ121B4

and 1' (min.) from the edge of proposed wetland plugs. All broken or splintered stakes shall be removed and replaced with new ones.

Install black bi-oriented utility fencing making sure that there is no space between the existing grade and the bottom of the fence. Fasten safety fence to stake by using 1-1/2" roofing nails. Close all gaps so that adjacent pieces of fence abut tightly together.

Attach twine or string to stakes as shown on the Contract Drawings. String shall be pulled taught to reduce sagging. The string must alternate in and out of fence netting for increased stability of fence. Tie 10" strip of metallic (mylar) flagging along string every four feet. Work in one direction only. The Contractor shall be responsible for removing the fence at the end of the guarantee period for the wetland plants, or at the direction of the Engineer.

D. Measurement and Payment

The quantity to be measured for payment under this Section shall be the total number of linear feet of fence furnished, installed, maintained and accepted in accordance with the Plans and Specifications and the directions of the Engineer.

The contract price per linear foot for Goose Exclusion Fence shall be as indicated on the BID SCHEDULE OF PRICES, Item No. BMP-7.413. The unit price per linear foot shall include all labor, materials, equipment and work incidental expenses necessary or required to complete the work in accordance with the plans and specifications and to the satisfaction of the Engineer.

* * * * *

DIVISION VII - DETAILED SPECIFICATIONS –
CONTRACT SEQ200436 / HWQ121B4

7.414 BMP AS-BUILT PLANSA. Description of Work

Under this item the Contractor is to provide all labor, materials, tools and equipment necessary to complete the work described below in complete accordance with the Contract Documents and the direction of the Engineer.

B. BMP As-Built Plans and Information

The Contractor shall be responsible for providing a survey of final topographical features with contour lines every one (1) foot of elevation at a scale of 1" = 20'. The survey shall include all adjoining property lines. The survey shall indicate and clearly label all new reconstructed/rehabilitated structural features which include but are not limited to the following:

- Tipping elevation of water at weir structure;
- Inlet and outlet elevation of low flow pipe;
- Inlet and outlet elevations of drain pipe;
- Permanent pool elevation;
- Bottom elevations of forebay, low flow channel and micropool;
- All pipes, headwalls, manholes, weirs, and any other structure that is part of the storm drainage system;
- Boundary fencing and survey monuments;
- Planting spreadsheet indicating zone elevation, species, and quantity planted;
- Location, size and species of all existing trees greater than six (6") caliper.

The Contractor shall submit the as-built plans with the above information included as an electronic file to the Restoration Specialist. The Contractor shall supply the surveys immediately after the completion of each BMP site to allow the Restoration Specialist time to complete the landscape survey. The Restoration Specialist shall verify the contractor's information and include his/her information along with any additional planting and natural features information on a separate sheet to the as-built plans. Paper prints of the completed as-built plans shall be provided by the Contractor to the DDC representative, its agent or the Engineer for review.

The approved final as-built plans shall be stamped by the professional surveyor and sent as a mylar set to the NYC Department of Design and Construction for inclusion in the final complete set of project as-built plans. The final as-built BMP plans shall consist of the following three sheets per site; 1) a base map stamped by the surveyor with property lines,

DIVISION VII - DETAILED SPECIFICATIONS –
CONTRACT SEQ200436 / HWQ121B4

contours, structures, and invert elevations, 2) a tree and shrub plan, and 3) a herbaceous planting plan.

The Contractor shall also submit as an electronic file, AutoCAD 2008 and six sets of paper prints of the approved final (BMP only) as-built plans to the NYC Department of Design and Construction.

C. No Separate Payment

No separate payment shall be made for this work of the specification. All costs shall be included in the various Contract Items of this Contract.

* * * * *

DIVISION VII - DETAILED SPECIFICATIONS –
CONTRACT SEQ200436 / HWQ121B4

7.415

VINE AND INVASIVE PLANT REMOVAL

NO TEXT ON THIS PAGE

DIVISION VII - DETAILED SPECIFICATIONS –
CONTRACT SEQ200436 / HWQ121B4

7.415A WILDLIFE STRUCTURES

NO TEXT ON THIS PAGE

DIVISION VII - DETAILED SPECIFICATIONS –
CONTRACT SEQ200436 / HWQ121B4

7.416 GALVINIZED CHICKEN WIRE

NO TEXT ON THIS PAGE

DIVISION VII - DETAILED SPECIFICATIONS –
CONTRACT SEQ200436 / HWQ121B4

7.417 DEBRIS EXCLUSION FENCEA. Description of Work

The Contractor shall furnish all materials, labor, and equipment necessary to install the debris exclusion fence specified herein and as shown on the Contract Drawings, including all incidental and appurtenant work required for a complete job.

The debris exclusion fence shall protect recently installed plant material from water borne debris and wrack. The Contractor shall maintain the debris exclusion fence in good condition and repaired as necessary by the Contractor during the landscaping and plant guarantee period as directed by the Engineer.

B. Materials and Methods

The debris exclusion fence shall be constructed with the following materials:

- A. Furnish wire netting as follows:
 - 1. 18 gage galvanized wire
 - 2. 1.5 inch mesh opening
 - 3. Galvanized after weaving
- B. Posts: Furnish posts of the minimum sizes and weights as follows, 8-foot long, 2-inch square, sharpened oak posts. Space posts 5 feet on center maximum, unless otherwise shown.
- C. Contractor shall use minimum 16 gage high tensile wire to connect oak posts. The ties shall be rust resistant.
- D. Ties: For attaching netting to oak posts, use 16 inch high tensile polyethylene cable tie strips. For attaching netting to wire grid, use 1/8 inch high tensile polyethylene cable tie strips. All ties shall be ultraviolet light resistant. The Contractor shall secure two layers of netting to the poles, one on the front side of the poles and one on the back, so a double layer is created.
- E. Line posts shall be spaced 5-feet on center maximum, unless otherwise shown.

DIVISION VII - DETAILED SPECIFICATIONS –
CONTRACT SEQ200436 / HWQ121B4

The fence shall conform to the detail for Debris Exclusion Fence on the Contract drawings.

The debris exclusion fence shall be located where indicated on the Contract Drawings.

C. Maintenance

The debris exclusion fence shall be inspected periodically (at least once per week), or as directed by the Engineer through the plant guarantee period. Any required repairs shall be made immediately.

D. Measurement and Payment

The quantity to be measured for payment under this Section shall be the total number of linear feet of debris exclusion fence furnished, installed and maintained in accordance with the Plans and Specifications and the directions of the Engineer.

The contract price per linear foot for Debris Exclusion Fence shall be as indicated on the BID SCHEDULE OF PRICES Item No. BMP-7.417. The unit price per linear foot shall include all labor, materials, equipment and work incidental expenses necessary or required to complete the work in accordance with the plans and specifications and to the satisfaction of the Engineer. The cost of removal and disposal of the debris exclusion fence shall be included in the unit price.

* * * * *

DIVISION VII - DETAILED SPECIFICATIONS –
CONTRACT SEQ200436 / HWQ121B4

7.500 SOIL EROSION AND SEDIMENTATION CONTROL MEASURES

Under soil erosion and sedimentation control work, the Contractor shall provide all labor, materials, tools and equipment necessary to complete the execution of the work in complete accordance with the Specifications and all Contract Drawings. All Soil Erosion and Sedimentation Control work shall be done in conformance with and subject to the renewed State Pollutant Discharge Elimination System (SPDES) General Permits for Discharges Stormwater from Construction Activity, GP-0-08-001, the latest edition of the "New York Guidelines for Urban Erosion and Sediment Control" published by the Empire State Chapter of the Soil and Water Conservation Society, and the New York State Department of Transportation Standard Specification Part 107-12 -Soil, Erosion and Air Pollution Statement, including, but not limited to, the following methods of erosion and sedimentation control.

1. Slopes left exposed will, within 30 working days of completion of any phase of grading, be planted or otherwise provided with ground cover device, or structures sufficient to restrain erosion.
2. A ground cover sufficient to restrain erosion must be planted or otherwise provided within 15 working days on that portion of the tract (disturbed area) upon which further active construction is not being undertaken.

The Contractor shall submit for approval by the Engineer, NYCDDC and NYSDEC, a written Erosion and Sedimentation Control Plan, prepared by a Certified Professional in Erosion and Sediment Control (CPESC), who is a Professional Engineer (P.E.) or under the supervision of a P.E. The Erosion and Sediment Control Plan must be signed and sealed by that CPESC and/or the supervising P.E. The Plan shall comply with all conditions of the applicable freshwater wetland permit issued by NYSDEC.

The Erosion and Sedimentation Control Plan shall conform to the guidelines as set forth in the latest edition of the "New York Guidelines for Urban Erosion and Sediment Control" published by the Empire State Chapter of the Soil and Water Conservation Society and he/she shall implement the followings:

- No stockpiling of excavated material would be allowed in a manner or location that would permit erosion and its subsequent sedimentation in wetlands or other natural areas.
- No storage of soil shall be permitted within the Contract limits. Soil is deemed to be for this requirement any sediment including

DIVISION VII - DETAILED SPECIFICATIONS –
CONTRACT SEQ200436 / HWQ121B4

material such as topsoil fill, sand, any excavated material, boulders, stones, cold patch, etc.

- Storm sewers will be installed in a sequence and manner that reduces the time during which the tops of excavated areas would be exposed and vulnerable to erosion.
- At the end of each day's work, the street where sewers are being installed will be cleaned and swept to reduce the amount of soil that could potentially impact downstream areas as sediment. The Contractor shall be required to have a street sweeper on the site.
- Use truck tracking pads at the construction access locations to remove sediment from the tires of the trucks and other construction equipment prior to driving on the adjacent streets.
- Utilize sediment basins, sediment traps and/or sediment filters in the erosion control plan to capture sediment from run-off and from water produced by dewatering operations.
- Use portable sediment tanks to remove sediment from water generated by dewatering operations. All water from dewatering shall be treated before discharge into any surface water bodies, unless the turbidity of the effluent is less than three times the ambient level of the receiving water body as measured by the turbidity meter in standard units (i.e. NTU's).
- The Contractor shall supply all portable equipment.
- Use construction limiting fence, staked hay bales, and/or reinforced silt fence as shown on Contract Drawings, unless otherwise directed by the Engineer.
- Schedule work in wet areas, such as BMP sites, during relatively dry summer months.
- Employ water diversions to direct the stream away from the area being worked on, so as to create drier conditions for in-stream work.
- Use temporary pumping sump to control water level at site.
- Prior to the start of construction activities, such as sewer installation, inspect all erosion control measures and continually monitor them, especially after each storm event.

DIVISION VII - DETAILED SPECIFICATIONS –
CONTRACT SEQ200436 / HWQ121B4

- If Permittee uses dewatering methods which produce effluent discharges, Permittee shall monitor each discharge effluent and receiving water body. Discharges shall not cause substantial visible contrast to the natural condition in any receiving water body. A meter which records turbidity in standard units (i.e. NTUs) shall be utilized to establish ambient conditions in each water prior to discharge. If any monitored turbidity level exceeds three times the ambient level of the receiving water body, the Permittee shall insure (e.g., by reducing the flow rate or otherwise adjusting the dewatering system) that no substantial visible contrast to the natural condition in the receiving water body occurs. The action(s) taken, or the decision not to take any action, shall be recorded in the monitors log.

The Contractor shall not receive any payment for the preparation of the Erosion and Sedimentation Control Plan. Installation of the Erosion and Sedimentation features and maintenance of them will result in payment for their respective items as described in Section 7.501 through 7.510. The work shall take place at BMP sites only and is not payment for street work or the installation of sewers.

The work shall include items of work specified under the following sections:

<u>Section Number</u>	<u>Title</u>
7.501	Maintenance of Erosion Control Measures
7.504	Reinforced Silt Fence
7.509-A	Stabilized Construction Entrance
7.510	Portable Sediment Tank
7.516	Turbidity Curtain

DIVISION VII - DETAILED SPECIFICATIONS –
CONTRACT SEQ200436 / HWQ121B4

7.501 MAINTENANCE OF EROSION CONTROL MEASURES

Maintenance/repair of the erosion and sediment control measures shall be performed by the Contractor only as directed by the Engineer.

When, in the judgment of the Engineer, Restoration Specialist, and DDC Construction Monitor, the soil erosion control measures have deteriorated to a point of not functioning adequately because of storm events, the Contractor shall be notified to make the necessary repairs.

If the Engineer deems that the erosion control device was not adequately installed in the first place, repair of such a device shall be the sole responsibility of the Contractor.

Damage to the erosion control measures caused by the construction activity of the Contractor is the responsibility of the Contractor. If the Engineer determines that the damage is the result of the Contractor's construction activity, then the Engineer shall order that the devices are repaired. The Contractor shall make the repairs at his/her own expense.

In the event that the erosion control measures are damaged as a result of vandalism by the general public, the Contractor shall notify his insurance company and put forth his claim for remuneration to the said damage.

* * * * *

DIVISION VII - DETAILED SPECIFICATIONS –
CONTRACT SEQ200436 / HWQ121B4

7.502 CONSTRUCTION LIMIT FENCE

NO TEXT ON THIS PAGE

DIVISION VII - DETAILED SPECIFICATIONS –
CONTRACT SEQ200436 / HWQ121B4

7.503

STAKED STRAW BALES

NO TEXT ON THIS PAGE

DIVISION VII - DETAILED SPECIFICATIONS –
CONTRACT SEQ200436 / HWQ121B4

7.504 REINFORCED SILT FENCEA. Description of Work

The Contractor shall furnish all materials, labor, and equipment necessary to construct reinforced silt fence specified herein and as shown on the Contract Drawings, including all incidental and appurtenant work required for a complete job.

Upon furnishing and installing the approved reinforced silt fence but prior to commencing any other work on-site, the Contractor shall notify the Engineer and arrange for an on-site inspection.

The reinforced silt fence shall be maintained in good condition and repaired as necessary by the Contractor during the construction and post-construction/site stabilization phases as directed by the Engineer.

B. Materials and Methods

1. Construction (Limiting) Fence: The construction (limiting) fence shall be a welded wire fence with a minimum height of four (4) feet. The fence shall be constructed of wire fabric fastened to the middle rails and to vertical line posts.

Wire fabric shall be of No. 6 gauge wire with a mesh of approximately 2 inches. The upper edge of the fabric shall be twisted and barbed. The fabric shall be securely fastened to vertical line posts by means of ties and spaced not more than 12 inches apart on rails and not more than 14 inches apart on line posts.

The construction (limiting) fence shall be located where indicated on the Contract Drawings. The fence shall be adjusted to avoid interference with trees and to maintain access to houses.

Line posts shall be spaced not more than 6 feet on centers. Posts shall be securely set in the ground. Line posts shall extend at least 2 feet below finished grade. Post locations shall be adjusted to avoid tree roots as appropriate.

2. Filter Fabric: Filter fabric shall be securely attached to the vertical line posts and wire fabric, and shall be situated between the wire fabric and staked straw bales.

The filter fabric shall be purchased and delivered in a continuous roll and cut on-site to the length of the barrier(s) to avoid the use of joints. Dimensions of the roll shall be thirty-six (36) inches by one

DIVISION VII - DETAILED SPECIFICATIONS –
CONTRACT SEQ200436 / HWQ121B4

hundred (100) feet in length. When joints are necessary, filter cloth shall be spliced together only at a line post, with a minimum 6-inch overlap, and securely sealed. The filter fabric shall meet NYSDOT specifications on same, and shall be fabric MUTUAL MISF 1776 as manufactured by Mutual Industries Inc.; Fabric # GTF190 as manufactured by Linq Industrial Fabric; Fabric # 2130 as manufactured by Propex, or approved equal.

A trench shall be excavated approximately 4 inches wide and 4 inches deep along the line of posts and upslope from the barrier. The filter fabric shall be extending into the trench, the trench backfilled, and the soil compacted over the filter fabric.

Siltation fences shall be removed when they have served their useful purpose, but not before the upslope area has been permanently stabilized.

3. Straw Bales: All straw bales shall be of straw, and shall be standard sized bales. Bales shall be placed in a single row, with ends of adjacent bales tightly abutting one another. Bales shall be placed upslope of the filter fabric, and shall at all times run parallel to the construction (limiting) fence and abut the filter fabric.

All bales shall be fiber-bound. No string bound straw bales are accepted. Straw bales shall be installed so that bindings are oriented around the sides rather than along the tops and bottoms of the bales in order to prevent deterioration of the bindings.

The straw bale barrier shall be entrenched and backfilled. A trench shall be excavated the width of a bale and the length of the proposed barrier to a depth of 4 inches. After the bales are staked and chinked, the excavated soil shall be backfilled against the barrier. Backfill soil shall conform to the ground to the ground level on the downhill side and shall be built up to 4 inches against the uphill side of the straw bale barrier.

Each bale shall be securely anchored by at least two stakes or steel reinforcing bars driven through the bale. The first stake in each bale shall be driven toward the previously laid bale to force the bales together. Stakes or reinforcing bars shall be driven deep enough into the ground to securely anchor the bales.

The gaps between bales shall be chinked (filled by wedging) with straw to prevent water from escaping between the bales. The Contract shall scatter loose straw over the area immediately uphill from the straw bale barrier to increase barrier efficiency.

DIVISION VII - DETAILED SPECIFICATIONS –
CONTRACT SEQ200436 / HWQ121B4

Straw bale barriers shall be removed when they have served their usefulness, but not before the upslope areas have been permanently stabilized.

C. Maintenance

The reinforced silt fences shall be inspected periodically (at least once per week), or as directed by the Engineer. Any required repairs shall be made immediately.

Filter fabric shall be inspected at least once per week and immediately after each rainfall and at least daily during prolonged rainfall. Any required repairs shall be made immediately. Should the fabric decompose or become ineffective prior to the end of the expected usable life while the barrier is still necessary, the fabric shall be replaced promptly.

Straw bales shall be inspected at least once per week and immediately after each rainfall and at least daily during prolonged rainfall. Close attention shall be paid to the repair of damaged bales, end runs and undercutting beneath bales. Necessary repairs to barriers or replacement of bales shall be accomplished promptly. Sediment deposits should be removed after each rainfall. They must be removed when the level of deposition reaches approximately one-half foot deep in front of the straw bale. Any sediment deposits remaining in place after the straw bale barrier is no longer required shall be dressed to conform to the existing grade.

D. Measurement and Payment

The quantity to be measured for payment under this section shall be the total number of linear feet of Reinforced Silt Fence, installed and maintained in accordance with the plans, specifications and directions of the Engineer. The construction (limiting) fence, filter fabric and staked straw bales which together make up the reinforced silt fence shall be measured as one erosion and sediment control feature.

The contract price per linear foot for Reinforced Silt Fence shall be as indicated on the BID SCHEDULE OF PRICES, Item No. BMP-7.504. The bid price shall constitute full compensation for all labor, materials and equipment and incidental expenses necessary to complete the work in accordance with the plans and specifications and to the satisfaction of the Engineer.

* * * * *

DIVISION VII - DETAILED SPECIFICATIONS –
CONTRACT SEQ200436 / HWQ121B4

7.505

SAND BAGS

NO TEXT ON THIS PAGE

DIVISION VII - DETAILED SPECIFICATIONS –
CONTRACT SEQ200436 / HWQ121B4

7.506

SEDIMENT TRAP WITH FILTER

NO TEXT ON THIS PAGE

DIVISION VII - DETAILED SPECIFICATIONS –
CONTRACT SEQ200436 / HWQ121B4

7.507

SEDIMENT FILTER

NO TEXT ON THIS PAGE

DIVISION VII - DETAILED SPECIFICATIONS –
CONTRACT SEQ200436 / HWQ121B4

7.508

SEDIMENT BASIN

NO TEXT ON THIS PAGE

DIVISION VII - DETAILED SPECIFICATIONS –
CONTRACT SEQ200436 / HWQ121B4

7.509-A STABILIZED CONSTRUCTION ENTRANCE

A. Description of Work

The Contractor shall furnish all materials, labor, and equipment necessary to construct the stabilized construction entrance specified herein and within the limits as shown on the Contract Drawings, including all incidental and appurtenant work required for a complete job.

Upon furnishing and installing the stabilized construction entrance but prior to commencing any other work on-site, the Contractor shall notify the Engineer and arrange for an on-site inspection.

The entrance shall be maintained in good condition and repaired as necessary by the Contractor during the construction phases as directed by the Engineer.

B. Materials and Methods

1. The entrance areas shall be cleared and stripped of all vegetation, roots and other objectionable material prior to installation of the access way as specified.
2. Provide surface drainage and divert excess runoff to stabilized areas as required and as directed by the Engineer.
3. Traprock - use 1-1/4" traprock concrete equivalent.
4. Thickness - not less than six (6) inches for traprock.
5. Width shall be twelve (12) foot minimum.
6. Filter cloth shall be placed over the entire area prior to placing of stone. Filter cloth shall be as specified below.

Filter cloth underliner shall be suitable for heavy duty construction traffic and have the following minimum properties:

Grab tensile strength	220 lbs.
Elongation at failure	220%
Mullen Burst Strength	430%
Puncture Strength	125 lbs.
Equivalent opening size	40-80 mm

Filter cloth shall be Trevira Spunbound 1135, Mirafi 600x, or approved equal.

DIVISION VII - DETAILED SPECIFICATIONS –
CONTRACT SEQ200436 / HWQ121B4

7. Surface water - All surface water flowing or diverted toward construction entrances shall be piped across the entrance. If piping is impractical, a mountable berm with 5:1 slopes will be permitted.
8. Maintenance - the entrance shall be maintained in a condition which will prevent tracking or flowing of sediment onto public rights-of-way. All sediment spilled, dropped, washed or tracked onto public rights-of-way must be removed immediately.
9. When washing is required, it shall be done on an area stabilized with stone and which drains into an approved sediment trapping device.
10. Periodic inspection and needed maintenance shall be provided after each rain.
11. After completion of the project, the stabilized construction entrance shall be removed and regraded to its original condition. Prior to grading and planting, the area shall be tilled to lessen the compaction of the soils.

C. Maintenance

1. Maintenance of the stabilized construction entrance will include periodic inspection of the surface condition. Top dress with new gravel as needed. Any areas producing sediment should be treated immediately.
2. After completion of the project, the stabilized construction entrance shall be removed and the areas regraded to their original elevations. Prior to seeding and planting, the areas shall be tilled to lessen the compaction of the soils.
3. For those stabilized construction entrances that are in the beds of accessways, the traprock can stay in place for use in accessways. (See specification for accessways.)

D. Measurement and Payment

The contract price per unit for the Stabilized Construction Entrance shall be as indicated on the BID SCHEDULE OF PRICES, Item No. BMP-7.509-A. The bid price shall constitute full compensation for all labor, materials and equipment and incidental expenses necessary to complete the work in accordance with the plans and specifications and to the satisfaction of the Engineer.

DIVISION VII - DETAILED SPECIFICATIONS –
CONTRACT SEQ200436 / HWQ121B4

* * * * *

DIVISION VII - DETAILED SPECIFICATIONS –
CONTRACT SEQ200436 / HWQ121B4

7.510 PORTABLE SEDIMENT TANKA. Description of Work

The Contractor shall furnish all materials, labor and equipment necessary to install the portable sediment tank specified herein and as shown on the Contract Drawings. A sediment tank is a compartmented tank container through which sediment laden water is pumped to trap and retain the sediment.

The purpose of the portable sediment tank is to trap and retain sediment prior to discharging the water to wetlands, adjoining properties and rights-of-way below the sediment tank site. The sediment tank shall be located for ease of cleanout and disposal of the trapped sediment and to minimize the interference with construction activities and pedestrian traffic. The temporary relocation of the tank(s) during clean-out shall be included in the cost of this item. Relocating the tank(s) from one work area to another before, during and after construction shall be included in the cost of this item.

B. Design Criteria

The following formula should be used in determining the storage volume of the sediment tank: pump discharge (gpm) x 16 = cubic foot storage.

Certified pump curves are to be provided to ensure that the pump provided can meet the hydraulic requirements.

C. Tank Specifications

The Contractor shall use steel containers with baffles to provide that the volume requirements necessary.

D. Maintenance

The Contractor shall be responsible to clean out the sediment tank when one third (1/3) is filled with silt. All sediment collected in the tank shall be disposed of off-site.

E. Measurement and Payment

The quantity to be paid for under this item shall be the number of portable sediment tanks placed in accordance with the plans and specifications to the satisfaction of the Engineer, measured in number of above items at the site of the work.

DIVISION VII - DETAILED SPECIFICATIONS –
CONTRACT SEQ200436 / HWQ121B4

The Contract price per unit for portable sediment tanks shall be as indicated on the BID SCHEDULE OF PRICES, Item No. BMP-7.510. The bid price shall be a unit price per portable sediment tank and shall include the cost of all labor, materials and equipment necessary to furnish, place and incorporate and all other work incidental thereto, in accordance with the plans and specifications to the satisfaction of the Engineer.

* * * * *

DIVISION VII - DETAILED SPECIFICATIONS –
CONTRACT SEQ200436 / HWQ121B4

7.511 STORM DRAIN - INLET PROTECTION MEASURES

NO TEXT ON THIS PAGE

DIVISION VII - DETAILED SPECIFICATIONS –
CONTRACT SEQ200436 / HWQ121B4

7.512

DIRTBAG

NO TEXT ON THIS PAGE

DIVISION VII - DETAILED SPECIFICATIONS –
CONTRACT SEQ200436 / HWQ121B4

7.513 SURFACE WATER COLLECTOR

NO TEXT ON THIS PAGE

DIVISION VII - DETAILED SPECIFICATIONS –
CONTRACT SEQ200436 / HWQ121B4

7.514

TEMPORARY WATER BARRIER

NO TEXT ON THIS PAGE

DIVISION VII - DETAILED SPECIFICATIONS –
CONTRACT SEQ200436 / HWQ121B4

7.515 JERSEY BARRIER

NO TEXT ON THIS PAGE

DIVISION VII - DETAILED SPECIFICATIONS –
CONTRACT SEQ200436 / HWQ121B4

7.516 TURBIDITY CURTAIN

A. Description of Work

1. The Contractor shall furnish, deliver and install a turbidity curtain in the water body adjacent to the work area to trap sediment and prevent migration of silt from the work site into the water body. The turbidity curtain is an impenetrable barrier supported at the top through a flotation system and weighted at the bottom to achieve closure.
2. The turbidity curtain shall be used when construction activity occurs along the water body shoreline. The turbidity curtain shall be in place prior to any work starting in the work area before any land disturbance activities are initiated. The turbidity curtain shall be removed within a week of completing the work.
3. The Turbidity Curtain shall be located beyond the lateral limits of the work area and firmly anchored in place. The alignment shall be set as close to the work area as possible but not so close as to be disturbed by construction equipment. The height of the curtain shall be 20% greater than the depth of the water at Mean High/High Water, to account for water level fluctuations and tidal range.

B. Materials

1. Turbidity Curtain shall be per NYSDOT Sheet 209-06.
2. Turbidity Curtain shall be made from monofilament woven polypropylene with the following properties, or approved equal:

Composition:	5.8 oz/sq. yd. (ASTM D-4632)
Grab Strength	120 lbs (ASTM D-4533)
Trap Tear Strength	600 psi (ASTM 3786)
Burst Strength	150 psi (ASTM D-3787)
Elongation	70%, 500 hrs (ASTM D-4632)
UV Resistance	40 (ASTM D-4335)
3. Turbidity Curtain floats shall be 6 inch diameter expanded polystyrene logs providing a minimum of 9 lbs/ft buoyancy.
4. Curtain shall have 5/16 inch galvanized steel tension cable and 5/16 inch galvanized ballast chain, or approved equal.
5. Seams shall be double sewn with grommets.

DIVISION VII - DETAILED SPECIFICATIONS –
CONTRACT SEQ200436 / HWQ121B4

6. Barrier connection shall be using marine grade quick connects.

C. Method

1. The area of proposed installation of the curtain shall be inspected for obstacles and impediments that could damage the curtain or impair its effectiveness to retain sediment.
2. All materials shall be removed so they cannot enter the water body.
3. Shallow installations can be made by securing the curtain by staking rather than using a flotation system. Supplemental anchors of the turbidity curtain toe shall be used, as needed, depending on water surface disturbances such as boats and wave action by winds.

D. Maintenance

1. The turbidity curtain shall be inspected daily and repaired or replaced immediately.
2. When necessary, or as directed by the Engineer, sediment removal shall be done by hand prior to removal of the barrier.
3. All removed silt shall be stabilized away from the water body.
4. The barrier shall be removed by carefully pulling it toward the construction site to minimize the release of attached sediment. Any floating construction or natural debris shall be immediately removed to prevent damage to the curtain.
5. If the curtain is oriented in a manner that faces the prevailing winds, frequent checks of the anchorage shall be made.

E. Measurement and Payment

The quantity to be measured for payment under this Section shall be the total number of linear feet, provided and placed, and removed upon the completion of work, as indicated on the Contract Drawings and as directed by the Engineer.

The contract price per linear foot of turbidity curtain shall be as indicated on the BID SCHEDULE OF PRICES Item No. BMP-7.516. The bid price shall constitute full compensation for all labor, materials, equipment and

DIVISION VII - DETAILED SPECIFICATIONS –
CONTRACT SEQ200436 / HWQ121B4

work incidental thereto, necessary to complete the work in accordance with the plans and specifications to the satisfaction of the Engineer.

* * * * *

DIVISION VII - DETAILED SPECIFICATIONS –
CONTRACT SEQ200436 / HWQ121B4

PERIMETER SITE SECURITY/ACCESS CONTROL MEASURES

7.600 WORK INCLUDED

Under Perimeter Site Security and Access Control Measures, the Contractor shall provide all labor, material, tools and equipment necessary to complete the execution of the work in complete accordance with the Specifications and all Contract Drawings. The work shall include items of work specified under the following sections.

<u>Section Number</u>	<u>Title</u>
7.606	Permanent Accessway with Concrete Pavers or Gravel

* * * * *

DIVISION VII - DETAILED SPECIFICATIONS –
CONTRACT SEQ200436 / HWQ121B4

7.601-B GALVANIZED STEEL "W" BEAM GUIDE RAIL

NO TEXT ON THIS PAGE

DIVISION VII - DETAILED SPECIFICATIONS –
CONTRACT SEQ200436 / HWQ121B4

7.602

BOULDER PROVISION AND PLACEMENT

NO TEXT ON THIS PAGE

DIVISION VII - DETAILED SPECIFICATIONS –
CONTRACT SEQ200436 / HWQ121B4

7.603

FIXED AND REMOVABLE STEEL PIPE BOLLARDS

NO TEXT ON THIS PAGE

DIVISION VII - DETAILED SPECIFICATIONS –
CONTRACT SEQ200436 / HWQ121B4

7.604 BLACK CHAIN LINK FENCE

NO TEXT ON THIS PAGE

DIVISION VII - DETAILED SPECIFICATIONS –
CONTRACT SEQ200436 / HWQ121B4

7.605

SIGN INSTALLATION ON STEEL RAIL POSTS

NO TEXT ON THIS PAGE

DIVISION VII - DETAILED SPECIFICATIONS –
CONTRACT SEQ200436 / HWQ121B4

7.606 PERMANENT ACCESSWAY WITH CONCRETE PAVERS OR GRAVEL

A. Description of Work

The Contractor shall provide all labor, materials, tools and equipment necessary to complete the permanent accessways as shown in the Contract Drawings and as directed by the Engineer.

B. Materials and Methods - Concrete Pavers

1. Pavers

The Permanent Accessway shall be constructed using concrete grid pavers. Unless directed by the Engineer, materials and methods shall conform to ICPI Technical Specification #8. The pavers shall be 23 5/8" x 15 3/4". They shall be made in a grid-like pattern 3 1/8" in height. The Pavement Accessway edges shall be secured with a concrete curb. The pavers and adjoining curb shall be earthtone brown in color. The pavers shall be fabricated of Portland Cement Type II or III fine and course aggregates (ASTM C-33-61) utilizing a steel mesh-6"/6" x 8/8 gauge with an air-entraining agent between 4%-6% (ASTM C-173) achieving a concrete strength of 5,000 psi at 28 days (ASTM C-39-49) and a maximum water absorption of 5% (ASTM C-97). The concrete grid pavers shall be manufactured by Metromont Materials Company or approved equal.

2. Crushed Stone

The crushed stone layer shall consist of 1/2" to 1" stone, with gradation conforming to ASTM D2940.

3. Sand

Sand bedding shall consist of concrete sand, with gradation conforming to ASTM33(6).

4. Filter Cloth

Filter cloth underliner shall have the following minimum properties:

Grab tensile strength	220 lbs.
Elongation at failure	220%

DIVISION VII - DETAILED SPECIFICATIONS –
CONTRACT SEQ200436 / HWQ121B4

Mullen Burst Strength	430%
Puncture Strength	125 lbs.
Equivalent opening size	40-80 mm

Filter cloth shall be Trevira Spunbound 1135, Mirafi 600x, or approved equal.

5. Testing

The pavers should be tested and confirm to the following tests:

Compression/Load Test (ASTM C 67 - Adapted)

Samples are to be conditioned at 70°F (21°F) and 50% relative humidity room for 24 hours prior to testing. Cut samples of 12" x 12" were used for this test.

A. Load Tests - Quarter of a full Panel.

Sample No.	Effective Area (sq.in)	Maximum Load (lbs.)	Load Strength Per Unit (PSI)
1	49.00	287,000	5,857
2	49.00	296,000	6,041
3	49.00	322,000	6,571
<i>Average:</i>			6,156

B. Compression Tests - Single Block Unit

Sample No.	Effective Area (sq.in)	Maximum Load (lbs.)	Compression Strength Per Unit (PSI)
1	12.25	68,500	5,592
2	12.25	65,000	5,306
3	12.25	70,000	5,714
<i>Average:</i>			5,537

6. Installation Procedure

- a. Prior to placing a dense-graded base, the soil subgrade or approved fill should be uniformly compacted to at least

DIVISION VII - DETAILED SPECIFICATIONS –
CONTRACT SEQ200436 / HWQ121B4

95% of standard Proctor density per ASTM D698(4).
Remove from the setting bed rock or other materials which
would create uneven bearing.

- b. Install concrete curb along the perimeter outlining the entire area to receive crushed stone and pavers.
- c. A 12 inch deep crushed stone base should then be installed, compacted to a minimum of 98% standard Proctor density (4).
- d. Place sand in a 2" compacted layer over the base to present a true and even grade over entire area to receive pavers.
- e. Set pavers and line up to abut.

7. Void Filler

Thoroughly mix topsoil with fertilizer and spread loosely to fill voids in pavers. Water with a mist spray to settle. Add additional topsoil mix to bring the topsoil flush with top of the paver. Seed at slightly less than normal rate. When grass is 2 1/2" high, cut to 1 3/4".

C. Material and Methods – Gravel

The specifications for permanent gravel accessway shall be the same as those for stabilized construction entrance of this Detailed Specification Section 7.509A.

D. Measurement and Payment

The contract price per square foot for Permanent Accessway with Concrete Pavers shall be as indicated on the BID SCHEDULE OF PRICES Item No. BMP-7.606-B for pavers. No separate payment shall be made for concrete curbing or sub base material used for pavers. The unit price per square foot shall include all labor, materials, equipment and incidental expenses necessary to complete the work in accordance with the plans and specifications to the satisfaction of the Engineer.

* * * * *

DIVISION VII - DETAILED SPECIFICATIONS –
CONTRACT SEQ200436 / HWQ121B4

STREAMBANK STABILIZATION

7.700 Work Included

Under Streambank Stabilization, the Contractor shall provide all labor, material, tools and equipment necessary to complete the execution of the work in complete accordance with the Specifications and all Contract Drawings. The work shall include items of work specified under the following Sections.

<u>Section Number</u>	<u>Title</u>
7.710	Reno Mattress

* * * * *

DIVISION VII - DETAILED SPECIFICATIONS –
CONTRACT SEQ200436 / HWQ121B4

7.701

LIVE STAKES

NO TEXT ON THIS PAGE

DIVISION VII - DETAILED SPECIFICATIONS –
CONTRACT SEQ200436

7.702

ROCK TOE PLANTING

NO TEXT ON THIS PAGE

DIVISION VII - DETAILED SPECIFICATIONS -
CONTRACT SEQ200436

7.703

NATURAL FIELD STONES

NO TEXT ON THIS PAGE

DIVISION VII - DETAILED SPECIFICATIONS –
CONTRACT SEQ200436

7.704

OAK STAKES

NO TEXT ON THIS PAGE

DIVISION VII - DETAILED SPECIFICATIONS –
CONTRACT SEQ200436

7.705

EROSION CONTROL MAT

NO TEXT ON THIS PAGE

DIVISION VII - DETAILED SPECIFICATIONS –
CONTRACT SEQ200436

7.706

FILTER BEDDING

NO TEXT ON THIS PAGE

DIVISION VII - DETAILED SPECIFICATIONS –
CONTRACT SEQ200436

7.707

COIR LOGS

NO TEXT ON THIS PAGE

DIVISION VII - DETAILED SPECIFICATIONS –
CONTRACT SEQ200436

7.708

ROOT WAD/CLUSTER AND DOWNED TREE

NO TEXT ON THIS PAGE

DIVISION VII - DETAILED SPECIFICATIONS -
CONTRACT SEQ200436

7.709

STRAIGHT VANES

NO TEXT ON THIS PAGE

DIVISION VII - DETAILED SPECIFICATIONS –
CONTRACT SEQ200436

7.710 RENO MATTRESSA. Description of Work

Under this item the Contractor shall furnish all labor, materials, equipment necessary to install Reno Mattress as shown on the Contract drawings and in accordance with the specification and as directed by the Engineer.

B. Materials and Construction

Reno Mattress is a wire mesh container uniformly partitioned into internal cells with relatively small height in relation to the other dimensions. The internal cells are interconnected with other units and filled with stone at the project site to form flexible, permanent monolithic structures used for channel bottom protection. The reno mattress shall have the dimensions as shown on the contract drawings.

The wire mesh shall be non-raveling mesh made of twisting continuous pairs of wires to form hexagonal shaped openings which are interconnected to adjacent wires. The wire is made from zinc coated and over coated with PVC. PVC coatings shall not show cracks or breaks after the fabrication of the mesh. Fasteners used to assemble and interconnect the individual units shall be made of stainless steel.

The stones for the reno mattress shall be between 4" and 6" in diameter. The stones shall meet the specifications of the Rip Rap, Section 7.107 of this contract.

The subgrade shall be excavated to allow for the placement of the reno mattress to form the grade shown of the contract drawings. The reno mattress shall be placed on geotextile fabric laid directly on the compacted subgrade.

C. Measurement and Payment

The quantity to be measured for payment under this Section shall be the total number of square yards of reno mattress installed as directed by the Engineer.

The contract price per square yard of reno mattress installed shall be as indicated on the BID SCHEDULE OF PRICES Item No. BMP-7.710. The contract price shall include all excavation, grading and geotextile fabric necessary to install the reno mattress as directed by the Engineer. The bid price shall constitute full compensation for all labor, materials, equipment and work incidental thereto, necessary to complete this item in accordance with the plans and specifications to the satisfaction of the Engineer.

* * * * *

DIVISION VII - DETAILED SPECIFICATIONS -
CONTRACT SEQ200436

END OF ADDENDUM NO. 4

This addendum consists of two hundred thirty-eight (238) pages.

**SPECIFICATIONS FOR
HANDLING, TRANSPORTATION AND DISPOSAL
OF NON-HAZARDOUS AND POTENTIALLY HAZARDOUS
CONTAMINATED MATERIALS**

Reconstruction of South Jamaica Area - Baisley Pond Park

Borough of Queens

DDC Project No. HWQ121B4

Prepared By:



**NEW YORK CITY DEPARTMENT OF
DESIGN + CONSTRUCTION**

30-30 Thomson Avenue, 3rd Floor
Long Island City, New York 11101

Date: 10/22/2014



Table of Contents

ITEM 8.01 C1	<u>HANDLING, TRANSPORTING AND DISPOSAL OF NON-HAZARDOUS CONTAMINATED SOILS</u>	A5-1
ITEM 8.01 C2	<u>SAMPLING AND TESTING OF CONTAMINATED/POTENTIALLY HAZARDOUS SOILS FOR DISPOSAL PARAMETERS</u>	A5-7
ITEM 8.01 H	<u>HANDLING, TRANSPORTING AND DISPOSAL OF HAZARDOUS SOILS</u> ...	A5-9
ITEM 8.01 S	<u>HEALTH AND SAFETY</u>	A5-15
ITEM 8.01 W1	<u>REMOVAL, TREATMENT AND DISCHARGE/DISPOSAL OF CONTAMINATED WATER</u>	A5-20
ITEM 8.01 W2	<u>SAMPLING AND TESTING OF CONTAMINATED WATER</u>	A5-27

Attachments

1. New York City Department of Environmental Protection Limitations for Effluent to Storm-Sanitary or Combined Sewers Parameters
2. Applicable Regulations
3. Definitions
4. Phase II Subsurface Corridor Investigation Report



ITEM 8.01 C1 HANDLING, TRANSPORTING AND DISPOSAL OF NON-HAZARDOUS CONTAMINATED SOILS

8.01 C1.1 WORK TO INCLUDE

General: This work shall consist of the handling, transportation and disposal of non-hazardous contaminated soils. The materials covered by this specification are soils that are contaminated with petroleum or chemical products but cannot be classified as hazardous waste. For the purpose of this specification, soil shall be defined as any material excavated below the pavement and base for pavement.

Non-hazardous contaminated soils are defined as soils exhibiting one or more of the following characteristics:

- ◆ Elevated Photo-Ionization Detector (PID) readings, subsequently confirmed by lab analysis
- ◆ Visual evidence of contamination
- ◆ Petroleum and/or chemical odors
- ◆ Soils that have been documented as contaminated in previous environmental reports

Non-hazardous contaminated soils must be stockpiled at an off-site approved location or secured on-site by the Contractor, meeting all required Federal, State and Local stipulations. Sampling and laboratory analysis must be conducted to determine if the soils are hazardous, unless the alternative procedure as defined under subsection 8.01 C1.1 A.5 has been agreed upon by treatment facilities. Contaminated soils determined to be non-hazardous shall be handled in accordance with the specifications herein for Item 8.01 C1. Contaminated soils determined to be hazardous shall be handled in accordance with the specifications for Item 8.01 H – Handling, Transporting and Disposal of Hazardous Soils.

The Contractor shall retain the services of an independent Environmental Consultant, as specified under Item 8.01 S – Health and Safety, to oversee the work required under this Item.

Non-hazardous soils shall be delivered to the disposal or treatment facility within thirty (30) calendar days after excavation.

The Contractor shall conduct sampling and analysis of the impacted soils as specified under Item 8.01 C2 – Sampling and Testing of Contaminated/Potentially Hazardous Soils for Disposal Parameters. The laboratory results shall be forwarded to DDC Program Administration, Engineering Support Services (ESS) for review to determine if the soils will be handled and disposed of as contaminated regulated soils or hazardous waste. No other soils shall be sampled or tested without the DDC's approval or direction.

The Contractor shall ensure that all operations associated with the handling, sampling, loading, transportation, and disposal of non-hazardous contaminated soils are in compliance with all applicable Federal, State, and City statutes and regulations.

The Contractor shall document the excavation, handling, transportation and disposal of non-hazardous contaminated soils. The Contractor shall supply all equipment, material and labor required to conduct the specified work of this Item.

A. Material Handling Plan: Within forty-five (45) calendar days after award of Contract, the Contractor shall submit to the Program Administration, ESS for review, a Material Handling Plan (MHP). The MHP must be approved by the Program Administration, ESS, prior to the Contractor's commencement of work. The MHP shall, at a minimum, consist of:

1. The Contractor's procedures for identifying non-hazardous contaminated soils during excavation, including the specific model and manufacturer of intended organic vapor

- monitoring equipment and calibration procedures to be used. It should also include the training and experience of the personnel who will operate the equipment.
2. The Contractor's procedures for safely handling non-hazardous contaminated soils. The procedures must include personnel safety and health as well as environmental protection considerations.
 3. Name, address, New York State Department of Health's (DOH) Environmental Laboratories Accreditation Program (ELAP) status and telephone number of the proposed laboratory for analysis of representative soil samples. The ELAP for the intended analysis must approve the laboratory.
 4. Identification of the Contractor's proposed waste transporter(s). This information shall include:
 - a. Name and Waste Transporter Permit Number
 - b. Address
 - c. Name of responsible contact for the hauler
 - d. Telephone number for the contact
 - e. Any and all necessary permit authorizations for each type of waste transported
 - f. Previous experience in performing the type of work specified herein
 5. All staging/stockpiling areas (if stockpiling areas are intended and available), or alternate procedures that will be used. Alternate procedures may include, but are not limited to, agreements from the intended disposal or treatment facilities to accept boring data and/or analytical data previously obtained during the site characterization so that materials may be directly loaded into vehicles for shipment to the disposal facility.
 6. A backup facility should the staging/stockpile areas become unavailable, insufficient in area or not be present by some other unforeseen difficulty.
 7. Identification of the Contractor's two proposed Treatment Storage or Disposal (TSD) facilities for non-hazardous contaminated soils (primary and back-up) for final disposal of the soils. The primary TSD shall be an approved soil recycling/treatment facility. The backup facility may be a recycling/treatment facility or a New York State Department of Environmental Conservation (DEC) approved lined landfill or other facility approved by DEC to accept this material. The information required for each facility shall include:
 - a. Facility name and the State identification number
 - (1) Facility location
 - (2) Name of responsible contact for the facility
 - (3) Telephone number for contact
 - (4) Signed letter of agreement to accept waste as specified in this contract
 - (5) Unit of measure utilized at facility for costing purposes
 - b. A listing of all permits, licenses, letters of approval, and other authorizations to operate, which are currently held and valid for the proposed facility.
 - c. A listing of all permits, licenses, letters of approval, and other authorizations to operate which have been applied for by the proposed facility but not yet granted or issued.

- d. The Contractor shall specify and describe the disposal/containment unit(s) that the proposed facility will use to manage the waste. The Contractor shall identify the capacity available in the units and the capacity reserved for the subject waste.
 - e. The Contractor shall provide the date of the proposed facility's last compliance inspection.
 - f. A list of all active (unresolved) compliance orders (or agreements), enforcement notices, or notices of violations issued to the proposed facility shall be provided. The source and nature of the cause of violation shall be stated, if known.
8. Description of all sampling and field/laboratory analyses that will be needed to obtain disposal facility approval.

8.01 C1.2 MATERIALS

- A. Containers shall be as required in the United State Department of Transportation (DOT) regulations.
- B. Polyethylene to be placed under (20 mil. thickness minimum) and over (10 mil. thickness minimum) soil piles.
- C. The Contractor shall assure that the waste hauler's appropriate choice of vehicles and operating practices shall prevent spillage or leakage of contaminated material from occurring en route.
- D. The Contractor shall provide, install and maintain any temporary loading facilities on site as required until completion of material handling activities. The location and design of any facilities shall be included in the MHP and be approved by the Program Administration, ESS.

8.01 C1.3 CONSTRUCTION DETAILS

A. Material Handling

1. Immediately after excavation of non-hazardous contaminated soil the Contractor shall:
 - a. Load material directly onto trucks/tankers/roll offs for disposal off site; or
 - b. If interim stockpiling is required, place on a minimum of 20 mil. or equivalent plastic ground cloth and cover by minimum of 10 mil. polyethylene sheeting or equivalent to protect against leaching or runoff of contaminants into groundwater or stormwater. Weight or secure the sheeting by appropriate means and seal seams as approved by the DDC to prevent tearing or removal by weather. Grade surrounding surface to provide for positive drainage away from pile. Stockpile shall not exceed 100 cubic yards.
2. Institute appropriate procedures and security measures to ensure the protection of site personnel and the public from contaminated materials as described in the approved MHP and Item 8.01 S - Health and Safety.
3. Any soil encountered that appears to contain unknown contaminants (based on visual, odor, or other observation), or that vary substantially from the material originally identified must be segregated in stockpiles and the independent Environmental Consultant promptly notified. Construct stockpiles to the same requirements as stated in subsection A.1.b above.
4. Provide any dewatering that is necessary to complete the work. Contaminated water shall be disposed of in accordance with Item 8.01 W1 - Removal, Treatment and Discharge/Disposal of Contaminated Water.

5. Provide and operate field organic vapor test equipment, a PID or a flame ionization detector (FID), to detect general organic vapor levels at intervals of approximately fifty (50) cubic yards of soil excavated, when visual or odor observations indicate the material may substantially differ from the soil previously excavated and/or as directed by the independent Environmental Consultant.

B. Off-Site Transportation to Disposal or Treatment Facility

1. General

- a. The Contractor shall furnish all labor, equipment, supplies and incidental costs required to transport contaminated material from the work area to the off-site disposal or treatment facility, and any other items and services required for transporting contaminated material for disposal at an off-site facility.
- b. The Contractor shall submit the name and location of the facility where an off-site scale is located. The Contractor shall also submit a plan to the DDC for review outlining procedures on controlling trucks leaving the work site and en-route to the off-site scale. The Contractor shall be responsible for tracking all material/vehicles from the site to the off-site scale.
- c. The Contractor shall provide to the DDC certified tare and gross weight slips for each load received at the accepted facility which shall be attached to each returned manifest.
- d. The Contractor shall coordinate the schedule for truck arrival and material deliveries at the job site to meet the approved project schedule.
- e. The Contractor shall inspect all vehicles leaving the project site to ensure that contaminated soils adhering to the wheels or undercarriage are removed prior to the vehicle leaving the site.
- f. The Contractor shall obtain letters of commitment from the waste haulers and the treatment, disposal or recovery facility to haul and accept shipments. The letter shall indicate agreement to handle and accept the specified estimated quantities and types of material during the time period specified in the project schedule and any time extension as deemed necessary.
- g. **The Program Administration, ESS shall review and approve waste profiles before transportation to the TSD facility.**

2. Hauling

- a. The Contractor shall coordinate manifesting, placarding of shipments, and vehicle decontamination. All quantities shall also be measured and recorded upon arrival at the disposal or treatment facility. If any deviation between the two records occurs, the matter is to be reported immediately to the DDC and to be resolved by the Contractor to the satisfaction of the DDC.
- b. The Contractor shall be held responsible, at its own cost for any and all actions necessary to remedy situations involving material spilled in transit or mud and dust tracked off-site.
- c. The Contractor shall ensure that trucks are protected against contamination by properly covering and lining them with compatible material (such as polyethylene) or by decontaminating them prior to and between acceptances of loads.
- d. The Contractor shall be responsible for inspecting the access routes for road conditions, overhead clearance, and weight restrictions.

- e. The Contractor shall only use the transporter(s) identified in the MHP for the performance of work. Any use of substitute or additional transporters must have previous written approval from the Program Administration, ESS at no additional cost to the City.
 - f. The Contractor shall develop, document, and implement a policy for accident prevention.
 - g. The Contractor shall not combine contaminated materials from other projects with material from this project.
 - h. No material shall be transported until approved by the DDC.
3. Off-Site Disposal
- a. The Contractor shall use only the facility(ies) identified in the MPH for the performance of the work. Substitutions or additions shall not be permitted without prior written approval from the Program Administration, ESS, and if approved shall be at no extra cost to the City.
 - b. The Contractor shall be responsible for acceptance of the materials at an approved facility, for ensuring that the facility is properly permitted to accept the stated materials, and that the facility provides the stated treatment and/or disposal services.
 - c. The DDC reserves the right to contact and visit the disposal or treatment facility and regulatory agencies to verify the agreement to accept the stated materials and to verify any other information provided.
 - d. In the event that the identified and approved facility ceases to accept the stated materials or the facility ceases operations, it is the Contractor's responsibility to locate an alternate approved and permitted facility(ies) for accepting materials. The alternate facility(ies) must be approved in writing by the DDC in the same manner and with the same requirements as for the original facility(ies). This shall be done at no extra cost or delay to the City.
 - e. The Contractor shall obtain manifest forms, and complete the shipment manifest records required by the appropriate regulatory agencies for verifying the material and quantity of each load in unit of volume and weight. Copies of each manifest shall be submitted to the DDC within four (4) business days following shipment, and within three (3) business days after notification of receipt of the facility. Any manifest discrepancies shall be reported immediately to the DDC and be resolved by the Contractor to the satisfaction of the DDC.
4. Equipment and Vehicle Decontamination
- a. The Contractor shall design and construct a portable decontamination station to be used to decontaminate equipment and vehicles exiting from the exclusion zone. The cost for this work will be paid under Item 8.01 S - Health and Safety.
 - b. Water generated during the decontamination process shall be disposed of in accordance with Item 8.01 W1 – Removal, Treatment and Discharge/Disposal of Contaminated Water.

8.01 C1.4 METHOD OF MEASUREMENT

Quantities for non-hazardous contaminated soils shall be measured in tons. The tonnage will be determined by off-site truck scales, as per Subsection 8.01 C1.3.B1, that are capable of generating load tickets.

8.01 C1.5 PRICE TO COVER

- A. The unit bid price bid per ton for Item 8.01 C1 shall include the cost of furnishing all labor, materials, equipment, plan, and insurance for excavation, handling, transportation, disposal, documentation, fees, permits, loading, stockpiling, hauling, and any other incidentals necessary to complete all the work as specified herein for handling, transporting, and disposal of non-hazardous contaminated soil.
- B. Final disposal of hazardous soil shall be paid for under Item 8.01 H – Handling, Transporting and Disposal of Hazardous Soils. Disposal of decontamination water shall be paid for under Item 8.01 W1 – Removal, Treatment and Discharge/Disposal of Contaminated Water.
- C. Backfill will be paid for under its respective item as specified in the contract document.
- D. The independent Environmental Consultant shall be paid under Item 8.01 S – Health and Safety.

Payment will be made under:

<u>ITEM NUMBER</u>	<u>ITEM</u>	<u>PAYMENT UNIT</u>
8.01 C1	Handling, Transporting, and Disposal of Non-Hazardous Contaminated Soil	Tons

**ITEM 8.01 C2 SAMPLING AND TESTING OF CONTAMINATED/ POTENTIALLY
HAZARDOUS SOIL FOR DISPOSAL PARAMETERS**

8.01 C2.1 WORK TO INCLUDE

A. Description

The work shall consist of collecting and analyzing representative soil samples for parameters typically requested by the disposal facilities.

B. Sampling and Laboratory Analysis

1. At least thirty (30) days prior to the commencement of work, the Contractor's independent Environmental Consultant must submit a Soil Sampling Plan/Field Sampling Plan (SSP/FSP) to the Program Administration, Engineering Support Services (ESS) for review and approval. The plan shall include the name, address, DOH's ELAP status, and telephone numbers of the proposed laboratory. The plan shall also include training and experience of the personnel who will collect the samples.
2. The Contractor shall sample and analyze representative samples of the contaminated/potentially hazardous soils. For stockpiled soils, the Contractor shall collect and analyze one (1) composite sample per 500 cubic yards or fraction thereof. Each composite sample shall consist of a minimum of five (5) grab samples collected from greater than two (2) feet below the soil surface. For drummed soil, the Contractor shall collect one (1) composite sample per (ten) 10 drums or fraction thereof. Each composite sample shall consist of a grab sample from each of the ten (10) drums or fraction thereof. Each composite sample shall be analyzed for Resource Conservation and Recovery Act (RCRA) hazardous waste characteristics (Ignitability, Reactivity, Corrosivity), Full Toxicity Characteristic Leaching Procedure (TCLP) (including RCRA metals, volatile Organic Compounds (VOCs), Semi-Volatile Organic Compounds (SVOCs), pesticides, herbicides), Total Petroleum Hydrocarbons (TPH) and Polychlorinated Biphenyls (PCBs). All samples collected should be analyzed on a five (5) calendar days turn around time and analytical results must be submitted to Program Administration, ESS upon receipt of the analytical results.
3. All sampling shall be conducted by a person trained in sampling protocols using standard accepted practices for obtaining representative samples.
4. The Contractor must also contact the disposal facility where the waste will be sent for permanent disposal, and arrange to collect any additional samples required by the facility. The cost associated with additional sampling and testing shall be included in the bid price of this Item.
5. The quality of the data from the sampling program is the Contractor's responsibility. The Contractor must furnish all qualified personnel, equipment and instruments necessary to carry out the sampling. Unless directed otherwise, all sampling procedures must follow the DEC sampling guidelines and protocols.
6. All sample containers shall be marked and identified with legible sample labels which shall indicate the project name, sample location and/or container, the sample number, the date and time of sampling, preservatives utilized and other information that may be useful in determining the character of the sample. Chain-of-custody shall be tracked from laboratory issuance of sample containers through laboratory receipt of the samples.
7. The Contractor shall maintain a bound sample logbook. The Contractor shall provide DDC access to it at all times and shall turn it over to the DDC in good condition at the

completion of the work. The following information, as a minimum shall be recorded to the log:

1. Sample identification number
 2. Sample location
 3. Field observation
 4. Sample type
 5. Analyses
 6. Date/time of collection
 7. Collector's name
 8. Sample procedures and equipment utilized
 9. Date sent to laboratory and name of laboratory
8. The City reserves the right to direct the Contractor to conduct alternative sampling in lieu of the parameters described in subsection B2, if the situation warrants. The substitute sampling parameters shall be of equal or lesser monetary value than those described in subsection B2, as determined by industry laboratory pricing standards.
 9. Only dedicated sampling equipment may be used to collect these samples. All equipment involved in field sampling must be decontaminated before being brought to the sampling location, and must be properly disposed after use.
 10. Soils exceeding any of the hazardous characteristic criteria meet the legal definition of hazardous soils (rather than non-hazardous contaminated soils) and shall be transported or disposed of under Item 8.01 H – Handling, Transporting and Disposal of Hazardous Soils. All analyses must be done by a laboratory that has received approval from the ELAP for the methods to be used. The Contractor must specify the laboratory in the MHP.

8.01 C2.2 METHOD OF MEASUREMENT

Quantities for samples shall be measured as the number of sets of samples that are tested. A set shall be defined as one (1) composite sample analyzed for the full range of parameters as specified in subsection B2.

8.01 C2.3 PRICE TO COVER

The unit price bid per set for Item 8.01 C2 shall include the cost of furnishing all labor, materials, equipment, plan, and insurance necessary for sampling, handling, transporting, testing, documentation, fees, permits and any other incidentals necessary to complete the work as specified herein for sampling and testing of contaminated/potentially hazardous soil.

Payment will be made under:

ITEM NUMBER	ITEM	PAYMENT UNIT
8.01 C2	Sampling and Testing of Contaminated/ Potentially Hazardous Soil for Disposal Parameters	Set

ITEM 8.01 H HANDLING, TRANSPORTING, AND DISPOSAL OF HAZARDOUS SOILS

8.01 H.1 WORK TO INCLUDE

General: This work shall consist of the handling, transportation and disposal of soils or materials that are listed as hazardous wastes or exhibit any of the characteristics of a hazardous waste, namely ignitability, corrosivity, reactivity, and toxicity, as defined in 6 NYCRR Part 371, Section 371.3 and 40 CFR Section 261. For the purpose of this specification, soils shall be defined as any materials excavated below the pavement and base for pavement.

Contaminated soils determined to be hazardous under Item 8.01 C2 shall be handled, transported, and disposed of under Item 8.01 H in accordance with the specifications herein.

The independent Environmental Consultant retained by the Contractor, as specified under Item 8.01 S – Health and Safety, shall conduct sampling and analysis of above soils to determine which soils are hazardous.

All work under Item 8.01 H shall be performed under the direct supervision of the Contractor's Environmental Consultant, as approved by the Program Administration, Engineering Support Services (ESS).

The Contractor shall ensure that all operations associated with the handling, sampling, loading, transportation, and disposal of hazardous materials are in compliance with the applicable Federal, State, and Local statutes and regulations.

The Contractor shall document the excavation, handling, sampling, and testing, transportation and disposal of hazardous soils. The City shall be listed in the disposal documents as the waste generator.

The Contractor shall supply all equipment, material and labor required to conduct the specified work of this section.

The Contractor shall ensure that all operations associated with the handling, sampling, loading, transportation and disposal of hazardous soils are conducted in a manner to protect site personnel, the public and the environment, in accordance with all applicable Federal, State, and Local laws and regulations.

The Contractor shall decontaminate all equipment prior to its removal from the exclusion zone and/or following contact with hazardous materials, as detailed in Item 8.01 S - Health and Safety. Water generated during the decontamination process shall be disposed of under Item 8.01 W1 – Removal, Treatment and Discharge/Disposal of Contaminated Water.

- A. Material Handling Plan: Within forty-five (45) calendar days after award of Contract, the Contractor shall submit to the Program Administration, ESS for review, a Material Handling Plan (MHP). The MHP must be approved by the Program Administration, ESS, prior to the Contractor's commencement of work. The MHP shall, at a minimum, consist of:
1. The Contractor's procedures for identifying contaminated/potentially hazardous soils during excavation, including instrumentation and calibration procedures to be used.
 2. The Contractor's procedures for safely handling hazardous soils or soils which have not yet been tested but are believed to be potentially hazardous.
 3. Identification of the Contractor's proposed waste transporter(s). This information shall include:
 - a. Name and waste transporter permit number
 - b. Address
 - c. Name of responsible contact for the hauler

- d. Telephone number for the contact
 - e. Any and all necessary permit authorizations for each type of waste transported
 - f. Previous experience in performing the type of work specified herein
4. All staging/stockpiling areas (if stockpiling areas are intended and available), or alternate procedures that will be used. Alternate procedures could include, but are not limited to, agreements from the intended disposal or treatment facilities to accept boring data and/or analytical data previously obtained during the site characterization so that materials may be directly loaded into vehicles for shipment to the disposal facility or the use of off-site stockpiling locations approved by the DEC.
 5. A backup facility, should the staging/stockpile areas become unavailable, insufficient in area or not be present by some other unforeseen difficulty.
 6. Identification of the Contractor's two proposed United State Environmental Protection Agency (EPA) or DEC approved RCRA TSD facilities for hazardous soils.
 7. The Contractor shall submit the following information prior to any transportation of soils regarding the temporary and final off-site TSD or facilities where it is proposing to take hazardous soils. The expense of furnishing all information will be included in the Contractor's bid price:
 - a. General Information
 - (1) Facility name and the EPA identification number
 - (2) Facility location
 - (3) Name of responsible contact for the facility
 - (4) Telephone number for contact
 - (5) Signed letter of agreement to accept waste as specified in this contract
 - (6) Signed letter of agreement with a TSD for disposal of waste that may not be land-disposed
 - (7) Unit of measure utilized at each facility for costing purposes
 - b. A listing of all permits, licenses, letters of approval, and other authorizations to operate, which are currently held and valid for the proposed facility as they pertain to receipt and management of wastes derived from this Contract.
 - c. A listing of all permits, licenses, letters of approval, and other authorizations to operate which have been applied for by the proposed facility.
 - d. The Contractor shall specify and describe the disposal/containment unit(s) that the proposed facility will use to manage the waste. The Contractor shall identify the capacity available in the units and the capacity reserved for the subject waste.
 - e. The Contractor shall provide the date of the proposed facility(ies) last compliance inspection under RCRA.
 - f. A list of all active (unresolved) compliance orders, agreements, enforcement notices or notices of violations issued to the proposed facility shall be approved. The source and nature of the cause of violation shall be stated, if known.
 8. Description of all sampling and analyses that will be needed to obtain disposal facility approval.

8.01 H.2 MATERIALS

- A. Containers shall be watertight as required in the DOT regulations and must meet all applicable regulations including but not limited to those in Attachment 2.
- B. Polyethylene (20 mil. thickness minimum) to be placed under and (10 mil. thickness minimum) over soil piles. If soils are placed in drums, polyethylene must be placed over the drums.

8.01 H1.3 CONSTRUCTION DETAILS

A. Material Handling

1. The Contractor shall institute procedures to protect site personnel and the public from the non-hazardous and hazardous materials as described in Section 8.01 S - Health and Safety.
2. The Contractor shall handle hazardous soil as approved in the MHP.
3. Stockpiled materials at the temporary TSD facility shall be handled according to the facility requirements but at a minimum: shall be drummed or placed on and covered with polyethylene to protect against erosion and leaching into surrounding soils, the stockpile area shall be graded for positive drainage away from the pile, and shall be labeled while being held for sampling prior to permanent disposal.
4. Provide any dewatering that is necessary to complete the work. Water shall be disposed of in accordance with Item 8.01 W1 – Removal, Treatment and Discharge/Disposal of Contaminated Water.

B. Off-Site Transportation and Disposal

1. The Contractor shall furnish all labor, equipment and supplies required to transport hazardous materials from the work area to the off-site TSD facility(ies) and to acquire any other items and services required for transporting hazardous materials for storage and/or disposal at an approved off-site facility.
2. Weight Measurement
 - a. The Contractor shall submit the name and location of the facility where an off-site scale is located. The Contractor shall also submit a plan to the DDC for review outlining procedures on controlling trucks leaving the work site and on-route to the off-site scale. The Contractor shall be responsible for tracking all materials/vehicles from the site to the off-site scale.
 - b. The Contractor shall provide to the DDC certified tare and gross weight slips for each load received at the accepted facility which shall be attached to each returned manifest.
3. General
 - a. Manifests: The Contractor shall organize and maintain the material shipment records/manifests required by law.
 - b. The Contractor shall coordinate the schedule for truck arrival and material deliveries at the job site to meet the approved project schedule. The schedule shall be compatible with the availability of equipment and personnel for material handling at the job site.

- c. The Contractor shall inspect all vehicles leaving the project site to ensure that hazardous soils adhering to the wheels or under carriage are removed prior to the vehicle leaving the site.
- d. The Contractor shall obtain letters of commitment from the waste haulers and the TSD facility to haul and accept shipments. The letter shall indicate agreement to handle and accept the specified estimated quantities and types of material during the time period specified in the project schedule and any time extension as deemed as necessary.

4. Hauling

- a. The Contractor shall not deliver waste to any facility other than the TSD facility(ies) listed on the shipping manifest.
- b. The Contractor shall coordinate manifesting, placarding, of shipments, and vehicle decontamination. All quantities shall also be measured and recorded upon arrival at the TSD facility. If any deviation between the two records occurs, the matter is to be reported immediately to the DDC and to be resolved by the Contractor to the satisfaction of the DDC.
- c. The Contractor shall be held responsible, at its own expense, for any and all actions necessary to remedy situations involving material spilled in transit or mud and dust tracked off-site.
- d. The Contractor shall ensure that trucks are protected against contamination by properly covering and lining them with compatible material (such as polyethylene) or by decontaminating them prior to any use other than hauling hazardous materials.
- e. The Contractor shall be responsible for inspecting the access routes for road conditions, overhead clearance, and weight restrictions.
- f. The Contractor shall only use the transporter(s) identified in the MHP for the performance of work. Only a transporter with a current Part 364 Waste Transporter Permit from the DEC may transport this material. Any use of substitute or additional transporters must have previous written approval from the DDC at no additional cost to the City.
- g. The Contractor shall develop, document, and implement a policy for accident prevention.
- h. The Contractor shall not combine hazardous materials from other projects with material from this project.
- i. **The Contractor shall obtain for the City an EPA hazardous waste generator identification number and a representative of Program Administration, ESS will review and sign the manifest as the generator.**
- j. No materials shall be transported until approved by the DDC.

5. Off-Site Disposal

- a. The Contractor shall be responsible for acceptance of the materials at an approved TSD facility, for ensuring that the facility is properly permitted to accept the stated materials, and that the facility provides the stated storage and/or disposal services.
- b. In the event that the identified and approved facility ceases to accept the stated materials or the facility ceases operations, it is the Contractor's responsibility to locate an alternate approved and permitted facility(ies) for accepting materials. The Contractor is responsible for making the necessary arrangements to utilize the

facility(ies), and the alternate facility(ies) must be approved in writing by the DDC in the same manner and with the same requirements as for the original facility(ies). This shall be done with no extra cost or delay to the City.

- c. The Contractor shall submit all results and weights to the DDC.
- d. **The Contractor is responsible to pay all fees associated with the generation and disposal of all excavated hazardous waste. These fees include, but are not limited to, the New York State Department of Finance and Taxation (DFT) quarterly fees for hazardous waste and the New York State DEC annual hazardous waste regulatory fee program. The Contractor shall submit a copy of proof of payment to the DDC and Program Administration, ESS.**

6. Equipment and Vehicle Decontamination

The Contractor shall design and construct a portable decontamination station to be used to decontaminate equipment and vehicles exiting from the exclusion zone. The cost for this work shall be paid under Item 8.01 S - Health and Safety. Disposal of decontamination liquids is described under Item 8.01 W1 – Removal, Treatment and Discharge/Disposal of Contaminated Water.

7. Record Keeping

The Contractor shall obtain manifest forms, and complete the shipment manifest records required by the appropriate regulatory agencies for verifying the material and quantity of each load in unit of volume and weight. Copies of each manifest shall be submitted to the DDC within four (4) business days following shipment, and within three (3) business days after notification of receipt of the facility. Any manifest discrepancies shall be reported immediately to the DDC and be resolved by the Contractor to the satisfaction of the DDC.

8.01 H.4 METHOD MEASUREMENT

Quantities for hazardous soil shall be measured in tons satisfactorily delivered to the treatment, storage or disposal facility. The tonnage will be determined by off-site truck scales, as per subsection 8.01 H1.3.B.2, that are capable of generating load tickets.

8.01 H.5 PRICE TO COVER

- A. The unit price bid per ton for Item 8.01 H shall include the cost of furnishing all labor, materials, equipment, plan, and insurance for excavation, handling, transportation, disposal, documentation, permits, fees, taxes, stockpiling, hauling, and any other incidentals necessary to complete the work as specified herein for handling, transporting and disposal of hazardous soils.
- B. Final disposal of non-hazardous materials shall be paid for under Item 8.01 C1 – Handling, Transporting and Disposal of Non-Hazardous Soils. Disposal of decontamination water shall be paid under Item 8.01 W1 – Removal, Treatment and Discharge/Disposal of Contaminated Water.
- C. The independent Environmental Consultant shall be paid under Item 8.01 S – Health and Safety.
- D. Backfill will be paid for under its respective item.

Payment will be made under:

<u>ITEM NUMBER</u>	<u>ITEM</u>	<u>PAYMENT UNIT</u>
8.01 H	Handling, Transporting, and Disposal of Hazardous Soils	Tons

ITEM 8.01 S HEALTH AND SAFETY

8.01 S.1 WORK TO INCLUDE

Health and Safety Requirements

A. Scope of Work

It is the Contractor's responsibility to stage and conduct his work in a safe manner. The Contractor shall implement a Health and Safety Plan (HASP) for contaminated/hazardous soil intrusive activities as set forth in Occupational Safety and Health Administration (OSHA) Standards 1910.120 and 1926.650-652. The Contractor shall ensure that all workers have at a minimum hazard awareness training. The Contractor shall segregate contaminated work area in secured exclusion zones. These zones shall limit access to Contractor personnel specifically trained to enter the work area. The exclusion zone shall be set up to secure the area from the public and untrained personnel. The project health and safety program shall apply to all construction personnel including persons entering the work area. In addition, the Contractor shall protect the public from on-site hazards, including subsurface contaminants associated with on-site activities. The HASP shall be signed off by a Certified Industrial Hygienist and reviewed by Program Administration, Engineering Support Services (ESS).

Work shall include, but not be limited to:

1. Implementation of a baseline medical program.
2. Providing safety equipment and protective clothing for site personnel, including maintenance of equipment on a daily basis; replacement of disposable equipment as required; decontamination of clothing, equipment and personnel; and providing all other health and safety measures.
3. Providing, installing, operating and maintaining on-site emergency medical first aid equipment as specified in this section for which payment is not provided under other pay items in this Contract.
4. Providing, installing, operating, maintaining and decommissioning all equipment and personnel decontamination facilities specified within this section, including, but not limited to, the decontamination pad, decontamination water supply, decontamination water collection equipment and all other items and services required for the implementation of the health and safety requirements for which pay items are not provided elsewhere in this Contract.
5. Provide the minimum health and safety requirements for excavation activities within the limits of this Contract.
6. Implement and enforce a HASP: The HASP as presented in these specifications is dynamic with provisions for change to reflect new information, new practices or procedures, changing site environmental conditions or other situations which may affect site workers and the public. The HASP will also address measures for community protection, accident prevention, personnel protection, emergency response/contingency planning, air monitoring, odor control and hazardous chemicals expected on site. Providing a Confined Space Entry Program as defined in the Occupational Safety and Health Act, Confined Space Entry Standard, 29 CFR 1910.146.

B. Environmental Consulting Services

The Contractor shall retain an independent Environmental Consultant to obtain all permits and perform all field screening, air monitoring, community air monitoring, soil sampling, and health

and safety services. The independent Environmental Consultant shall at a minimum provide documentation to the Program Administration, ESS demonstrating the minimum requirements as set forth below:

1. The independent Environmental Consultant project supervisor on site and other designated key personnel shall have a minimum of three (3) years experience in the environmental field dealing with issues associated with contaminated soils. Such experience shall include oversight on environmental, specifically volatile organic compound and dust monitoring services as a routine part of its daily operations.
2. The independent Environmental Consultant must be experienced in work of this nature, size, and complexity and must have previous experience in working with the DEC.
3. The independent Environmental Consultant shall furnish a project listing identifying the location, nature of services provided, owner, owner's contact, contact's telephone number, project duration and value for at least five (5) projects within the last three (3) years.
4. If conditions within the exclusion zone are deemed hazardous, then the Contractor and its independent Environmental Consultant shall ensure that all personnel working within identified exclusion zones and/or involved (direct contact) with the handling, storage or transport of hazardous and contaminated materials shall have completed a minimum of forty (40) hours of Health and Safety Training on Hazardous Waste Sites in accordance with 29 CFR 1910.120(e). The training program shall be conducted by a qualified safety instructor. If conditions in the exclusion zone are deemed to be non-hazardous, the independent Environmental Consultant shall provide site specific training.
5. The Contractor shall ensure that on-site management and supervisors directly responsible for or who supervise employees engaged in hazardous waste operations shall receive the training specified in above and at least eight (8) additional hours of specialized training on managing such operations at the time of job assignment.

C. Submittals

1. The Contractor shall submit, within forty-five (45) calendar days after the contract award, a written HASP as specified herein, to Program Administration, ESS for review and comment. The Contractor shall make all necessary revisions required by Program Administration, ESS and resubmit the HASP to the Program Administration, ESS for acceptance. Start-up work for the project will not be permitted until written acceptance has been issued by the Program Administration, ESS.
2. Daily safety logs shall be maintained by the Contractor and shall be submitted to the DDC either on request or on completion of the work. Training logs shall be maintained by the Contractor and submitted to the DDC either on request or on completion of the work. Daily logs on air monitoring during excavation activities shall be prepared and maintained by the Contractor and submitted to the DDC either on request or upon completion of the work.
3. A closeout report shall be submitted by the Contractor to the DDC upon completion of the work within the defined exclusion zones. This report shall summarize the daily safety and monitoring logs and provides an overview of the Contractor's performance regarding environmental and safety issues. The report shall carefully document all areas where contamination has been found including pictures, addresses of locations, and potential sources.
4. Medical Surveillance Examinations: The Contractor shall submit to the DDC the name, office address and telephone number of the medical consultant utilized. Evidence of baseline medical examinations together with the evidence of the ability to wear National

Institute for Occupational Safety and Health (NIOSH) approved respirators (as specified in American National Standards Institute (ANSI) Z88.6) shall be provided to the DDC for all construction personnel who are to enter the exclusion zones.

5. Accident Reports: All accidents, spills, or other health and safety incidents shall be reported to the DDC.

D. Health and Safety Plan

The HASP shall comply with OSHA regulations 29 CFR 1910.120/1926.65. This document shall at a minimum contain the following:

1. Description of work to be performed
2. Site description
3. Key personnel
4. Worker training procedures
5. Work practices and segregation of work area
6. Hazardous substance evaluation
7. Hazard assessment
8. Personal and community air monitoring procedures and action levels
9. Personal protective equipment
10. Decontamination procedures
11. Safety rules
12. Emergency procedures
13. Spill control, dust control, vapor/odor suppression procedures
14. Identification of the nearest hospital and route
15. Confined space procedures
16. Excavation safety procedures

8.01 S.2 MEASUREMENT

Health and Safety Requirements

- A. 25% of the lump sum price will be paid when the following items are implemented or mobilized:

- Medical surveillance program
- Health and safety training
- Health and safety plan
- Environmental and personnel monitoring
- Instrumentation
- Spill control
- Dust control
- Personnel and equipment decontamination facilities
- Personnel protective clothing
- Communications
- Mobilization

- B. 50% will be paid in proportional monthly amounts over the period of work.
- C. 25% will be paid when the operation is demobilized and removed from the project site.

8.01 S.3 PRICE TO COVER

Health and Safety Requirements

The lump sum price bid for the health and safety requirements shall include all labor, materials, equipment, and insurance necessary to complete the work in accordance with these specifications. The price bid shall include, but not be limited to, the following:

- A. Providing training, safety personnel, air monitoring and medical examinations as specified.
- B. Providing safety equipment and protective clothing for site personnel, including maintenance of equipment on a daily basis; replacement of disposable equipment as required; decontamination of clothing, equipment and personnel; and all other health and safety activities or costs not paid for under other pay items in this Contract.
- C. Providing, installing, operating and maintaining on-site emergency medical and first aid equipment. This includes all furnishings, equipment, supplies and maintenance of all medical equipment, and all other health and safety items and services for which payment is not provided under other pay items in this Contract.
- D. Providing, installing, operating, maintaining, and decommissioning all personnel and equipment decontamination facilities, including decontamination pad, decontamination water supply, and all other items and services required for the implementation of the health and safety requirements for which pay items are not provided elsewhere in this Contract. Vehicle decontamination pads shall be included in the price of this item. Disposal of decontamination fluid shall be paid for under Item 8.01 W1 – Removal, Treatment and Discharge/Disposal of Contaminated Water.
- E. Spill Control
 - 1. Payment shall account for furnishing, installing, and maintaining all spill control equipment and facilities. Payment will include equipment and personnel to perform emergency measures required to contain any spillage and to remove spilled materials and soils or liquids that become contaminated due to spillage during work within the exclusion zones and handling of excavated soils and liquids from these areas. This collected spill material will be properly disposed of.
 - 2. Payment under this item shall not include testing, handling, transportation or disposal of petroleum-contaminated/potentially hazardous soils excavated during construction. The price for this work will be paid for under Items 8.01 C1 – Handling, Transporting and Disposal of Non-Hazardous Contaminated Soils, 8.01 C2 – Sampling and Testing of Contaminated/Potentially Hazardous Soil for Disposal Parameters or 8.01 H – Handling, Transporting and Disposal of Hazardous Soils, as appropriate.
- F. Dust Control

Payment shall account for furnishing, installing, and maintaining dust control equipment and facilities to be used whenever applicable dust levels are exceeded. Payment will include all necessary labor, equipment, clean water, foam, and all other materials required by the Dust Control Plan. The DOH Community Air Monitoring Plan (CAMP) may be used as guidance.
- G. Vapor/Odor Suppression

Payment shall account for furnishing, installing and maintaining vapor/odor control equipment and facilities to be used whenever organic vapor monitoring or the presence of odors indicates that vapor suppression is required to protect workers or the public. Payment will include all necessary labor, equipment, clean water, foam and all other materials required by the Vapor/Odor Suppression Plan.

H. Mobilization/Demobilization

1. Mobilization

Payment shall include but not be limited to:

- a. All work required to furnish, install and maintain all signs, fencing, support zone facilities, parking areas and all temporary utilities;
- b. All work required to furnish, install, and maintain an office space with phone and utilities for health and safety personnel;
- c. All work required for complete preparation of lay down area for roll-off containers, including sampling, and any required fencing;
- d. All direct invoiced cost from bonding companies and government agencies for permits and costs of insurance; and
- e. All other items and services required for mobilization and site preparation.

2. Demobilization

Payment shall include but not be limited to: All work required to sample the area; remove from the site all equipment, temporary utilities and supporting facilities; performance of necessary decontamination and repairs; disposal of disposable equipment and protective gear and other items and services required for complete demobilization.

Payment will be made under:

<u>ITEM NUMBER</u>	<u>ITEM</u>	<u>PAYMENT UNIT</u>
8.01 S	Health and Safety	Lump Sum

ITEM 8.01 W1 REMOVAL, TREATMENT AND DISCHARGE/DISPOSAL OF CONTAMINATED WATER

8.01 W1.1 WORK TO INCLUDE

General: This work shall consist of the proper removal and disposal of all contaminated groundwater and decontamination water generated during construction operations. The Contractor shall be solely responsible for the proper disposal or discharge of all contaminated water generated at the job site. The Contractor will have the option of treating water on-site for discharge to the combined sanitary/storm sewer system or removing contaminated water for off-site disposal. The Contractor shall be responsible to choose a method compatible to the construction work and shall be compensated on a per day basis regardless of method employed. The Contractor will be compensated for only those days where the system is in full operation.

The Contractor shall retain a dewatering/water treatment Specialist (hereinafter the "Specialist") and laboratory as specified under Item 8.01 W2 – Sampling and Testing of Contaminated Water, to conduct any testing that may be required for disposal of impacted water.

The dewatering/water treatment Specialist is responsible to obtain all permits; perform all water sampling, testing; and provide ancillary services related to dewatering and water treatment. The Specialist shall at a minimum provide documentation to the Program Administration, Engineering Support Services (ESS) demonstrating the minimum requirements as set forth below:

1. The Specialist shall demonstrate that it has, at a minimum, three (3) years experience in the design of dewatering plans. The Specialist should demonstrate expertise dealing with issues associated with contaminated water. During that three (3) year period, the Specialist shall demonstrate that it provided dewatering and water treatment systems as a routine part of its daily operations.
2. The Specialist must be experienced in work of this nature, size, and complexity and must have previous experience in working with the DEC.
3. The Specialist shall furnish a project listing identifying the location, nature of services provided, owner, owner's contact, contact's telephone number, project duration and value for at least five (5) projects within the last three (3) years of a similar nature, size, and complexity to this one.
4. If conditions within the exclusion zone are deemed hazardous, then the Contractor and its independent Environmental Consultant shall ensure that all personnel working within identified exclusion zones and/or involved (direct contact) with the handling, storage or transport of hazardous and contaminated material shall have completed a minimum of forty (40) hours of Health and Safety Training on Hazardous Waste Sites in accordance with 29 CFR 1910.120(e). The training program shall be conducted by a qualified safety instructor. If conditions in the exclusion zone are deemed to be non-hazardous, the Specialist shall be responsible to provide site-specific training to its employees and other affected personnel.
5. The Contractor shall ensure that on-site management and supervisors directly responsible for or who supervise employees engaged in hazardous waste operations shall receive the training specified in above and at least eight (8) additional hours of specialized training on managing such operations at the time of job assignment.

The Contractor shall document all operations associated with the handling, sampling and disposal of contaminated water, and ensure that they are in compliance with applicable Federal, State and Local statutes and regulations.

The Contractor shall supply all labor, equipment, transport, plant, material, treatment, and other incidentals required to conduct the specified work of this section.

If water will be disposed of into the combined sanitary/storm sewer system, the Contractor shall ensure the Specialist treats the water to comply with the New York City Department of Environmental Protection (DEP) Sanitary/Combined and Storm Sewer Effluent Limit concentrations prior to discharge. The Contractor is responsible for providing settling or filtering tanks and any other apparatus required by DEP. Alternatively, the Contractor can provide a plan for transport and disposal at an off-site waste disposal facility.

Within forty-five (45) calendar days after award of Contract, the Contractor shall submit to the Program Administration, ESS for review, a Water Handling Plan (WHP). The WHP must be approved by the Program Administration, ESS, prior to the Contractor's commencement of work. The minimum requirements for the WHP are specified herein Item 8.01W 1.2, for each type of disposal (disposal into the combined sanitary/storm sewer or off-site disposal). The Contractor shall maintain a complete, up to date copy of the WHP on the job site at all times.

8.01 W1.2 CONSTRUCTION DETAILS

For each disposal method the Contractor proposes to utilize (disposal to combined sanitary/storm sewer or off-site disposal), the WHP shall include the information required in paragraphs A and B below, as appropriate.

A. On-site treatment and discharge into New York City combined sanitary/storm sewers.

1. Regulations: The Contractor shall comply with all applicable regulations. This includes but may not be limited to:
Title 15-New DEP Sewer Use Regulations.
2. Permits: The Contractor is solely responsible to obtain all necessary and appropriate Federal, State and Local permits and approvals. The Contractor will be responsible for performing all and any system pilot tests required for permit approval. This includes but may not be limited to:
 - a. Industrial waste approval for the New York City sewer system.
 - b. Groundwater discharge permit for the New York City sewer system (DEP Division of Sewer Regulation and Control), if discharge to sewer exceeds 10,000 gallons per day.
 - c. The Contractor shall comply with DEC State Pollutant Discharge Elimination System (SPDES) Permit Number GP-0-10-001, General Permit for Stormwater Discharges.
 - d. Long Island well point permit for Brooklyn and Queens sites, if well points are used for dewatering.
 - e. Wastewater quality control application, DEP.
3. The WHP for this portion of the work shall include at a minimum:

- a. Identification and design of Contractor's proposed treatment to assure that the water meets the DEP sewer use guidelines prior to discharge to the sewer, including identification of all materials, procedures, settling or filtering tanks, filters and other appurtenances proposed for treatment and disposal of contaminated water.
- b. The name, address and telephone number of the contact for the Contractor's proposed chemical laboratory, as well as the laboratory's certifications under Federal, State or non-governmental bodies.
- c. The name, address and telephone number of the contact for the Contractor's proposed independent Environmental Consultant.
- d. Copies of all submitted permit applications and approved permits the Contractor have received.

4. Materials

The Contractor shall supply all settling or filtering tanks, pumps, filters, treatment devices and other appurtenances for treatment, temporary storage and disposal of contaminated water. All equipment shall be suitable for the work described herein.

5. Execution

- a. The Contractor is solely responsible for disposal of all water, in accordance with all Federal, State and Local regulations.
- b. The Contractor is solely responsible for any treatment required to assure that water discharged into the sewer is in compliance with all permits and Federal, State and Local statutes and regulations.
- c. The Contractor is solely responsible for the quality of the water disposed of into the sewers.
- d. The Contractor is responsible for sampling and testing of water for the DEP Sanitary/Combined and Storm sewer Effluent Limit concentrations. The quality of the data is the Contractor's responsibility. Any sampling and testing shall be conducted and paid in accordance with Item 8.01 W2 – Sampling and Testing of Contaminated Water.
- e. The Contractor shall be responsible to maintain the discharge rate to the sewer such that all permit requirements are met, the capacity of the sewer is not exceeded and no surcharging occurs downstream due to the Contractor's actions. Dewatering by means of well points or deep wells will not be allowed in the Boroughs of Brooklyn or Queens where the rate of pumping exceeds forty-five (45) gallons per minute unless the appropriate permit has been secured from the DEC.
- f. Disposal of Treatment Media
 - (1) The Contractor shall be responsible for disposal or recycling of treatment media in accordance with all Federal, State and Local regulations.
 - (2) The Contractor shall provide the DDC with all relevant documentation concerning the disposal of treatment media, including manifests, bills of

loading, certificates of recycling or destruction and other applicable documentation.

- (3) **Disposal of treatment media shall not be considered as a separate pay item; instead it shall be considered as incidental work thereto and included in the unit price bid.**

B. Off-Site Disposal

1. Regulations: The Contractor shall conform to all applicable Federal, State and Local regulations pertaining to the transportation, storage and disposal of any hazardous and/or non-hazardous materials as listed in Attachment 2.
2. The following shall be submitted to the DDC prior to initiating any off-site disposal:
 - a.
 - (1) Name and waste transporter permit number
 - (2) Address
 - (3) Name of responsible contact for the hauler
 - (4) Any and all necessary permit authorizations for each type of waste transported
 - (5) Previous experience in performing the type of work specified herein
 - b. General information for each proposed treatment/disposal facility and at least one backup treatment/disposal facility
 - (1) Facility name and EPA identification number
 - (2) Facility location
 - (3) Name of responsible contact for the facility
 - (4) Telephone number for contact
 - (5) Unit of measure utilized at facility for costing purposes
 - c. A listing of all permits, licenses, letters of approval and other authorizations to operate, which are currently held and valid for the proposed facility as they pertain to receipt and management of the wastes derived from this Contract.
 - d. A listing of all permits, licenses, letters of approval and other authorizations to operate which have been applied for by the proposed facility but not yet granted or issued. Provide dates of application(s) submitted. Planned submittals shall also be noted.
 - e. The Contractor shall specify and describe the disposal/containment unit(s) that the proposed facility will use to manage the waste and provide dates of construction and beginning of use, if applicable. Drawings may be provided. The Contractor shall identify the capacity available in the units and the capacity reserved for the subject waste.
 - f. The Contractor shall provide the date of the proposed facility's last compliance inspection.

- g. A list of all active (unresolved) compliance orders, agreements, enforcement notices or notices of violations issued to the proposed facility shall be submitted. The source and nature of the cause of violation shall be stated, if known. If groundwater contamination is noted, details of the facility's groundwater monitoring program shall be provided.
- h. Description of all sampling and field/laboratory analyses that will be needed to obtain disposal facility approval.

3. Materials

All vessels for temporary storage and transport to an off-site disposal facility shall be as required in DOT regulations.

4. Execution

a. General

- (1) The Contractor shall organize and maintain the material shipment records/manifests required by Federal, State and Local law. The Contractor shall include all bills of lading, certificates of destruction, recycling or treatment and other applicable documents.
- (2) The Contractor shall coordinate the schedule for truck arrival and material deliveries at the job site to meet the approved project schedule. The schedule shall be compatible with the availability of equipment and personnel for material handling at the job site.
- (3) The Contractor shall inspect all vehicles leaving the project site to ensure that contaminated liquids are not spilling and are contained for transport.
- (4) The Contractor shall obtain letters of commitment from the waste haulers and the treatment, disposal or recovery facility to haul and accept shipment. The letter shall indicate agreement to handle and accept the specified estimated quantities and types of material during the time period specified in the project schedule and any time extension as deemed as necessary.
- (5) The Contractor shall verify the volume of each shipment of water from the site.
- (6) The Contractor is responsible for sampling and testing of water for off-site disposal. The quality of the data is the Contractor's responsibility. Any sampling and testing shall be conducted and paid in accordance with Item 8.01 W2 – Sampling and Testing of Contaminated Water.
- (7) The Contractor shall be responsible for any additional analyses required by the TSD facility, and for the acceptance of the water at an approved TSD facility.

b. Hauling

- (1) The Contractor shall not deliver waste to any facility other than the TSD facility(ies) listed on the shipping manifest.
- (2) The Contractor shall coordinate manifesting, placarding of shipments, and vehicle decontamination. All quantities shall also be measured and recorded

upon arrival at the TSD facility(ies). If any deviation between the two records occurs, the matter is to be reported immediately to the DDC and shall be resolved by the Contractor to the satisfaction of the DDC.

- (3) The Contractor shall be held responsible for any and all actions necessary to remedy situations involving material spilled in transit or mud and dust tracked off-site. This cleanup shall be accomplished at the Contractor's expense.
- (4) The Contractor shall be responsible for inspecting the access routes for road conditions, overhead clearance and weight restrictions.
- (5) The Contractor shall only use the transporter(s) identified in the WHP for the performance of work. Only a transporter with a current Part 364 Waste Transporter Permit from DEC may transport this material. Any use of substitute or additional transporters must have previous written approval from the DDC at no additional cost to the City.
- (6) The Contractor shall develop, document, and implement a policy for accident prevention.
- (7) The Contractor shall not combine waste materials from other projects with material from this project.
- (8) The Contractor shall obtain for the City a hazardous waste generator identification number and will sign the manifest as the generator, if necessary.
- (9) No material shall be transported until approved by the DDC.

c. Disposal Facilities

- (1) The Contractor shall use only the TSD facility(ies) identified in the WHP for the performance of the work. Substitutions or additions shall not be permitted without prior written approval from the Program Administration, ESS, and, if approved, shall be at no extra cost to the City.
- (2) The Contractor shall be responsible for acceptance of the material at an approved TSD facility, for ensuring that the facility is properly permitted to accept the stated material, and that the facility provides the stated storage and/or disposal services.
- (3) The DDC reserves the right to contact and visit the disposal facility and regulatory agencies to verify the agreement to accept the stated material and to verify any other information provided. This does not in any way relieve the Contractor of his responsibilities under this Contract.
- (4) In the event that the identified and approved facility ceases to accept the stated materials or the facility ceases operations, it is the Contractor's responsibility to locate an alternate approved and permitted facility(ies) for accepting materials. The Contractor is responsible for making the necessary arrangements to utilize the facility(ies), and the alternate facility(ies) must be approved in writing by the DDC in the same manner and with the same requirements as for the original facility(ies). This shall be done with no extra cost or delay to the City.

d. Equipment and Vehicle Decontamination

- (1) The Contractor shall design and construct a portable decontamination station to be used to decontaminate equipment and vehicles exiting the exclusion zone. The cost for this work shall be paid under Item 8.01 S – Health and Safety.

8.01 W1.3 METHOD OF MEASUREMENT

The quantity for on-site treatment and discharge or off-site disposal shall be on a per day basis.

8.01 W1.4 PRICE TO COVER

A. The per day price bid for Item 8.01 W1 shall include the cost of furnishing all labor, materials, equipment, plan, and insurance for handling, transportation, disposal, documentation, permits, hauling, mobilization and demobilization, and any other incidentals thereto to complete the work.

B. The Contractor will not be paid for water that is within the DEP Sewer Discharge Limits.

Payment will be made under:

<u>ITEM NUMBER</u>	<u>ITEM</u>	<u>PAYMENT UNIT</u>
8.01 W1	Removal, Treatment and Disposal/Discharge of Contaminated Water	Day

ITEM 8.01 W2 SAMPLING AND TESTING OF CONTAMINATED WATER

8.01 W2.1 WORK TO INCLUDE

A. Description

The work shall consist of sampling and testing of potentially contaminated groundwater, surface runoff within the excavated area and all contaminated water generated during the decontamination process.

B. Sampling and Testing

1. The Contractor is responsible, at a minimum, for sampling and testing of contaminated water for the DEP Sanitary/Combined and Storm Sewer Effluent Limit concentrations as listed in Attachment 1. The quality of the data is the Contractor's responsibility. Any additional testing required by the Federal, State and/or disposal facilities shall be included in the bid price of this Item.
2. All sampling and testing shall be conducted by a person trained in sampling protocols using accepted standard practices and/or the DEC sampling guidelines and protocols.
3. All sample containers shall be marked with legible sample labels which shall indicate the project name, sample location and/or container, the sample number, the date and time of sampling, preservatives utilized, how the sample was chilled to 4 degrees Celsius, and other information that may be useful in determining the character of the sample.
4. Chain-of-custody shall be tracked from laboratory issuance of sample containers through receipt of the samples.
5. The Contractor shall maintain a bound sample log book. The Contractor shall provide the DDC access to it at all times and shall turn it over to the DDC in good condition at the completion of the work. The following information, as a minimum, shall be recorded to the log:
 - a. Sample identification number
 - b. Sample location
 - c. Field observation
 - d. Sample type
 - e. Analyses
 - f. Date/time of collection
 - g. Collector's name
 - h. Sample procedures and equipment used
 - i. Date sent to laboratory/name of laboratory
6. Only dedicated sampling equipment may be used to collect these samples. All equipment involved in field sampling must be decontaminated before being brought to the site, and must be properly disposed of after use.
7. Samples shall be submitted to the Contractor's laboratory within the holding times for the parameters analyzed.

8. All analyses must be done by a laboratory that has received approval from the DOH's ELAP for the methods to be done. The Contractor must specify the laboratory in the WHP.
9. Analytical results for water discharged to the sewer and for off-site disposal must be submitted to the DDC no later than five (5) days after sample collection.
10. The City reserves the right to direct the Contractor to conduct alternative sampling in lieu of the parameters described above, if the situation warrants. The substitute sampling parameters shall be of equal or lesser monetary value than those described above, as determined by industry laboratory pricing standards.

8.01 W2.2 METHOD OF MEASUREMENT

Quantities for samples shall be measured as the number of sets of samples that are tested for the DEP Sanitary/Combined and Storm Sewer Effluent Limit concentrations. A set shall be defined as one (1) representative sample analyzed for the full range of DEP parameters as specified in attachment 1.

8.01 W2.3 PRICE TO COVER

The unit price bid per set for Item 8.01 W2 shall include the cost of furnishing all labor, materials, equipment, plan, and insurance for handling, transport, sampling, testing, documentation, permits, other incidentals necessary to complete the work of sampling and testing of contaminated water. Any additional costs incurred by the Contractor for sampling and testing of contaminated water shall be included in the bid price of this Item.

Payment will be made under:

<u>ITEM NUMBER</u>	<u>ITEM</u>	<u>PAYMENT UNIT</u>
8.01 W2	Sampling and Testing of Contaminated Water	Set

ATTACHMENT 1

New York City Department of Environmental Protection Limitations for Discharge To Storm, Sanitary/Combined Sewer

**NEW YORK CITY DEPARTMENT OF ENVIRONMENTAL PROTECTION
BUREAU OF WASTEWATER TREATMENT**

Limitations for Effluent to Sanitary or Combined Sewers

Parameter ¹	Daily Limit	Units	Sample Type	Monthly Limit
Non-polar material ²	50	mg/l	Instantaneous	---
pH	5-11	SU's	Instantaneous	---
Temperature	< 150	Degree F	Instantaneous	---
Flash Point	> 140	Degree F	Instantaneous	---
Cadmium	2	mg/l	Instantaneous	---
	0.69	mg/l	Composite	---
Chromium (VI)	5	mg/l	Instantaneous	---
Copper	5	mg/l	Instantaneous	---
Lead	2	mg/l	Instantaneous	---
Mercury	0.05	mg/l	Instantaneous	---
Nickel	3	mg/l	Instantaneous	---
Zinc	5	mg/l	Instantaneous	---
Benzene	134	ppb	Instantaneous	57
Carbontetrachloride	---	---	Composite	---
Chloroform	---	---	Composite	---
1,4 Dichlorobenzene	---	---	Composite	---
Ethylbenzene	380	ppb	Instantaneous	142
MTBE (Methyl-Tert-Butyl-Ether)	50	ppb	Instantaneous	---
Naphthalene	47	ppb	Composite	19
Phenol	---	---	Composite	---
Tetrachloroethylene (Perc)	20	ppb	Instantaneous	---
Toluene	74	ppb	Instantaneous	28
1,2,4 Trichlorobenzene	---	---	Composite	---
1,1,1 Trichloroethane	---	---	Composite	---
Xylenes (Total)	74	ppb	Instantaneous	28
PCB's (Total) ³	1	ppb	Composite	---
Total Suspended Solids (TSS)	350 ⁴	mg/l	Instantaneous	---
CBOD ⁵	---	---	Composite	---
Chloride ⁵	---	---	Instantaneous	---
Total Nitrogen ⁵	---	---	Composite	---
Total Solids ⁵	---	---	Instantaneous	---
Other				

1 All handling and preservation of collected samples and laboratory analyses of samples shall be performed in accordance with 40 C.F.R. pt. 136. If 40 C.F.R. pt. 136 does not cover the pollutant in question, the handling, preservation, and analysis must be performed in

accordance with the latest edition of "Standard Methods for the Examination of Water and Wastewater." All analyses shall be performed using a detection level less than the lowest applicable regulatory discharge limit. If a parameter does not have a limit, then the detection level is defined as the least of the Practical Quantitation Limits identified in NYSDEC's Analytical Detectability and Quantitation Guidelines for Selected Environmental Parameters, December 1988

- 2 Analysis for *non-polar materials* must be done by EPA method 1664 Rev. A. Non-Polar Material shall mean that portion of the oil and grease that is not eliminated from a solution containing N-Hexane, or any other extraction solvent the EPA shall prescribe, by silica gel absorption.
- 3 Analysis for PCB=s is required if *both* conditions listed below are met:
 - 1) if proposed discharge \geq 10,000 gpd;
 - 2) if duration of a discharge $>$ 10 days.Analysis for PCB=s must be done by EPA method 608 with MDL= \leq 65 ppt. PCB's (total) is the sum of PCB-1242 (Arochlor 1242), PCB-1254 (Arochlor 1254), PCB-1221 (Arochlor 1221), PCB-1232 (Arochlor 1232), PCB-1248 (Arochlor 1248), PCB-1260 (Arochlor 1260) and PCB-1016 (Arochlor 1016).
- 4 For discharge \geq 10,000 gpd, the TSS limit is 350 mg/l. For discharge $<$ 10,000gpd, the limit is determined on a case by case basis.
- 5 Analysis for Carbonaceous Biochemical Oxygen Demand (CBOD), Chloride, Total Solids and Total Nitrogen are required if proposed discharge \geq 10,000 gpd.

ATTACHMENT 2

Applicable Regulations

Applicable regulations include, but are not limited to:

1. 49 CFR 100 to 179 - DOT Hazardous Materials Transport and Manifest System Requirements
2. New York State Department of Environmental Conservation (DEC), Spills Technology and Remediation Series (STARS) Memo #1
3. 6 NYCRR 360-1 DEC Solid Waste Management Facilities
4. 6 NYCRR 364- Waste Transporter permits
5. Local restrictions on transportation of waste/debris
6. 40 CFR 260 to 272 - Hazardous Waste Management (RCRA)
7. 6 NYCRR 371 - Identification and Listing of Hazardous Wastes
8. 6 NYCRR 372 - Hazardous Waste Manifest System and Related Standards for Generators, Transporters and Facilities
9. 6 NYCRR 373-1 - Hazardous Waste Treatment, Storage and Disposal Facility Permitting Requirements
10. 6 NYCRR 376 - Land Disposal Restrictions
11. Posted weight limitations on roads or bridges
12. Transportation Skills Programs, Inc. 1985 - Hazardous Materials and Waste Shipping Papers and Manifests
13. Other local restrictions on transportation of waste/debris
14. Occupational Safety and Health Administration (OSHA), Standards and Regulations, 29 CFR 1910 (General Industry)
15. OSHA 29 CFR 1910.120 Hazardous Waste Operations and Emergency Response
16. OSHA Safety and Health Standards 29 CFR 1926 (Construction Industry)
17. OSHA 29 CFR 1910.146 Confined Space Entry Standard
18. Standard Operating Safety Guidelines, EPA Office of Emergency and Remedial Response Publication, 9285.1-03
19. NIOSH / OSHA / USCG / EPA Occupational Safety and Health Guidance Manual for Hazardous Waste Site Activities (1986)
20. U.S. Department of Health and Human Services (DHHS) "NIOSH Sampling and Analytical Methods," DHHS (NIOSH) Publication 84-100
21. ANSI, Practice for Respiratory Protection, Z88.2 (1980)
22. ANSI, Emergency Eyewash and Shower Equipment, Z41.1 (1983)
23. ANSI, Protective Footwear, Z358.1 (1981)
24. ANSI, Physical Qualifications for Respirator Use, Z88.6 (1984)
25. ANSI, Practice for Occupational and Educational Eye and Face Protection, Z87.1 (1968)
26. Water Pollution Control Federation "Manual of Practice No. 1, Safety in Wastewater Works"
27. NFPA No. 327 "Standard Procedures for Cleaning and Safeguarding Small Tanks and Containers"

28. Occupational Safety and Health Act Confined Space Entry Standard 29 CFR 1910.146.87
29. Department of Transportation 49 CFR 100 through 179
30. Department of Transportation 49 CFR 387 (46 FR 30974, 47073)
31. Environmental Protection Agency 40 CFR 136 (41 FR 52779)
32. Environmental Protection Agency 40 CFR 262 and 761
33. Resource Conservation and Recovery Act (RCRA)
34. Any transporter of hazardous or non-hazardous materials shall be licensed in the State of New York and all other states traversed in accordance with all applicable regulations.

ATTACHMENT 3

Definitions

Contaminated Groundwater and Decontamination Fluids: Groundwater within the excavation trench or decontamination water that contains regulated compounds above the NYCDEP Discharge to Sanitary/Combined Sewer Effluent limits.

Disposal or Treatment Facility: A facility licensed to accept either non-hazardous regulated waste or hazardous waste for either treatment or disposal.

Exclusion Zone: Work area that will be limited to access by Contractor personnel specifically trained to enter the work area only. The exclusion zone will be set up to secure the area from the public and untrained personnel. The project health and safety program will apply to all construction personnel including persons entering the work area.

Hazard Assessment: An assessment of any physical hazards that may be encountered on a work site.

Hazardous Soils: Soils that exhibit any of the characteristics of a hazardous waste, namely ignitability, corrosivity, reactivity, and toxicity, as defined in 6 NYCRR Part 371, Section 371.3 and 40 CFR Section 261.

Hazardous Substance Evaluation: An evaluation of the possible or known presence of any hazardous substances that may be encountered on a job site. This evaluation is included in the Health and Safety Plan and will include the identification and description of any hazardous substances expected to be encountered. Material Safety Data Sheets (MSDS) will be included for each substance.

Health and Safety Plan: A plan employed at a work site that describes all the measures that will be taken to assure that all work is conducted in a safe manner, and that the health of the workers and the public will be insured.

Material Handling Plan: A plan outlining the methods that will be employed to handle, transport and dispose of contaminated materials.

Non-Hazardous Contaminated Soils: Soils which exhibit a distinct chemical or petroleum odor, or exhibit elevated photoionization detector readings but are not classified as hazardous waste under 6 NYCRR Part 371, Section 371.3 and 40 CFR Section 261.

New York State Health Department's Environmental Laboratory Approval Program: A program by which the state of New York approves and accredits environmental testing laboratories.

PCBs: Polychlorinated biphenyls are a group of toxic compounds commonly used as a coolant in transformers and other electrical components.

Photoionization Detector: A hand held instrument used to measure volatile organic compounds in air. The instrument ionizes the organic molecules through the use of an ultraviolet lamp.

RCRA Hazardous Waste Characteristics: Characteristics of a material which may indicate the material is hazardous. These include: ignitability, corrosivity, reactivity, and toxicity.

Total Petroleum Hydrocarbons: An analytical procedure used to determine the total amount of petroleum compounds in a material.

ATTACHMENT 4

Phase II Subsurface Corridor Investigation Report

(NO TEXT ON THIS PAGE)

- Final -

Phase II Subsurface Corridor Investigation Report
For
Reconstruction of South Jamaica Area
Queens, New York

DDC PROJECT NO. HWQ121B4 / *SEA 200936*

WORK ORDER NO. 6481-ATC-6258

CONTRACT REGISTRATION NO. 20090016802

Prepared for:



Bureau of Environmental and Geotechnical Services

30-30 Thomson Avenue, Fifth Floor

Long Island City, New York 11101

Prepared by:



ATC Associates Inc.

104 East 25th Street, 10th Floor

New York, NY 10010

PROJECT NO. 015.38500.0064

December 7, 2009



TABLE OF CONTENTS

EXECUTIVE SUMMARY ES-1

1.0 INTRODUCTION..... 1

 1.1 SCOPE OF WORK..... 1

2.0 CORRIDOR INFORMATION..... 3

 2.1 CORRIDOR LOCATION, DESCRIPTION AND USE..... 3

 2.2 DESCRIPTION OF SURROUNDING PROPERTIES 3

 2.3 CORRIDOR AND REGIONAL TOPOGRAPHIC SETTING..... 4

 2.4 CORRIDOR AND REGIONAL GEOLOGY 4

 2.5 CORRIDOR AND REGIONAL HYDROGEOLOGY 4

 2.6 SUMMARY OF PREVIOUS ENVIRONMENTAL INVESTIGATIONS 4

3.0 CORRIDOR EVALUATION 6

 3.1 SOIL QUALITY INVESTIGATION 6

 3.2 GROUNDWATER QUALITY INVESTIGATION..... 7

4.0 FINDINGS 8

 4.1 FIELD SCREENING 8

 4.2 LABORATORY ANALYTICAL RESULTS FOR SOIL AND GROUNDWATER
 SAMPLES..... 8

 4.2.1 SEMI-VOLATILE ORGANIC COMPOUNDS (SVOCs) IN SOIL..... 9

 4.2.2 TARGET ANALYTE LIST (TAL) METALS IN SOIL 9

 4.2.3 PESTICIDES IN SOIL 9

 4.2.4 POLY CHLORINATED BIPHENYLS (PCBS) IN SOIL 9

 4.2.5 WASTE CLASSIFICATION OF SOIL 9

 4.2.6 ANALYSIS OF NYCDEP PARAMETERS IN GROUNDWATER..... 9

5.0 CONCLUSIONS AND RECOMMENDATIONS..... 11

6.0 STATEMENT OF LIMITATIONS 13

Tables

 1 Summary of Environmental Boring Data

 2 Summary of TCL SVOCs Detected in Soil

 3 Summary of TAL Metals Detected in Soil

 4 Summary of Pesticides Analytical Results in Soil

 5 Summary of PCBs Analytical Results in Soil

 6 Summary of Waste Characterization Sample Analysis of Soil

 7 Summary of NYCDEP Parameters Analyzed in the Groundwater Sample

Figures

 1 Topographic Corridor Location Map

 2 Sample Location Plan

Appendices

 A Boring Location Sketches

 B Geologic Boring Logs and Temporary Well Construction Details

 C Laboratory Analytical Results



EXECUTIVE SUMMARY

On behalf of the New York City Department of Design and Construction (NYCDDC), ATC Associates, Inc. (ATC) conducted a Phase II Subsurface Corridor Investigation (SCI) of the following six (6) street segments in the Jamaica section of Queens, New York (hereinafter referred to as the Corridor):

1. 164th Street, between 119th Avenue and 120th Avenue;
2. 119th Avenue, between 164th Street and Guy R. Brewer Boulevard;
3. 119th Avenue, between Guy R. Brewer Boulevard and Long Street;
4. 118th Avenue, between Guy R. Brewer Boulevard and Lakeview Boulevard;
5. Lakeview Boulevard, between 118th Avenue and 122nd Avenue; and
6. Lakeview Lane, between 122nd Avenue and Baisley Boulevard.

The Corridor is located south of Foch Boulevard, west of 165th Street, north of Baisley Boulevard, and east of Baisley Pond and 155th Street in the Jamaica section of Queens, New York. Infrastructure improvements consisting of the excavation for the installation and/or repair of utilities is proposed throughout the Corridor. The Phase II SCI was conducted to determine if the Corridor's environmental condition might impact proposed construction activities. The investigation consisted of the following components:

- The advancement of two (2) borings (SB-01 and SB-02) to a depth of 20 feet below grade (ftbg). The borings were advanced using a Geoprobe direct push drill rig. Prior to direct push advancement, borings were cleared to a depth of five (5) feet using a hand auger. Soil samples were collected using four (4)-foot long, 2-inch diameter Macro Core stainless steel samplers equipped with polyvinyl chloride (PVC) liners.
- The collection of one (1) composite waste characterization sample (WC-01) composited of soil from borings SB-01 and SB-02 (grade to bottom).
- Laboratory analysis of the waste characterization sample for: (1) Target Compound List (TCL) Base Neutral/Acid (BN/A) extractable semi-volatile organic compounds (SVOCs) by United States Environmental Protection Agency (EPA) Method 8270; (2) Target Analyte List (TAL) metals by EPA Method 6010B series; (3) pesticides by EPA Method 8081A; (4) polychlorinated biphenyls (PCBs) by EPA Method 8082; (5) Full Toxicity Characteristics Leaching Procedure (TCLP); (6) Resource Conservation and Recovery Act (RCRA) Characteristics (ignitability, reactivity and corrosivity); and (7) Total Petroleum Hydrocarbons Diesel Range Organics/Gasoline Range Organics (TPHC DRO/GRO) via EPA Method 8015B.
- The installation of one (1) temporary well point (TWP) in boring SB-02 and the collection of one (1) groundwater sample using direct push technology by installing a slotted PVC screen bridging the groundwater table and riser pipe to grade. Dedicated PVC tubing was deployed in the TWP and connected to a check valve to extract the groundwater sample.



- Laboratory analysis of the groundwater sample for the parameters published by the New York City Department of Environmental Protection (NYCDEP) as Limitations for Effluent to Sanitary or Combined Sewers (NYCDEP Sewer Discharge Criteria).
- The preparation of this report, with tables summarizing the laboratory analytical results and figures depicting boring locations, significant site features and, if applicable, contamination occurrence and distribution.

Field procedures, including photo-ionization detector (PID) readings and visual and olfactory indicators of contamination (staining, odors) were utilized during drilling and sampling activities. Soil samples from the ground surface to the bottom of each boring were visually identified and classified in the field using the Burmister-based soil classification system.

In order to evaluate the subsurface soil and groundwater, laboratory analytical results were compared with the regulatory standards identified in: (1) New York State Department of Environmental Conservation (NYSDEC) Technical and Administrative Guidance Memorandum #4046 (TAGM) dated 1994 (including Eastern Soil Background Concentrations for metals); (2) NYSDEC STARS 1992 Memo #1 Petroleum Contamination Soil Guidance Policy Toxicity Characteristic Leaching Procedure (TCLP) Alternative Guidance Values; and (3) NYSDEC Subpart 375-6: Remedial Program Soil Cleanup Objectives (SCOs) Unrestricted and Restricted Use (Track 1 and Track 2).

In order to identify representative conditions for disposal purposes, an aliquot of soil from the two (2) borings (SB-01 and SB-02) was reserved and combined to create one (1) composite waste characterization sample (WC-01). The waste classification sample was analyzed for Full Toxicity Characteristics Leaching Procedure (TCLP), Resource Conservation and Recovery Act (RCRA) Characteristics (Ignitability, Reactivity and Corrosivity) via EPA Method 7.3.4.2, and Total Petroleum Hydrocarbons Diesel Range Organics/Gasoline Range Organics (TPHC DRO/GRO) via EPA Method 8015B. The waste classification soil sample results were compared with the Toxicity Characteristic Regulatory Levels for hazardous waste published in RCRA and New York State Department of Environmental Conservation (NYSDEC) Part 371.

Field screening did not identify the presence of impacted soils in the soil borings advanced in the Corridor. No PID readings were detected in any of the soil borings. No evidence of petroleum impacts, such as stained soil or petroleum odors, was identified in the soil borings. Since contamination was not identified during field screening, grab samples to identify representative conditions relative to the presence of volatile organic compounds (VOCs) were not collected from the two (2) "Moderate" risk borings.

The subsurface material encountered during this Phase II SCI from grade to 20 ftbg consisted predominantly of fine to medium sand, with variable amounts of clay, silt and gravel, which appeared to be consistent with glacial and glaciofluvial deposits. Man-made materials (brick, concrete, etc) or wood fragments, which would be indicative of urban fill, were not observed. Some organic material (peat) was observed in boring SB-01 which was located near Baisley Pond. Bedrock was not encountered during this Phase II SCI. Based on the USGS



Hydrogeologic Framework of Long Island, New York, dated 1989, in the vicinity of the Corridor bedrock is expected to be at a depth greater than 200 ftbg. The waste characterization sample analyzed for TCLP did not exhibit evidence of hazardous waste characteristics.

The sample analyzed for TCLP (WC-01) did not exhibit evidence of hazardous waste characteristics. GRO were detected in this sample at a concentration of 7.18 milligrams per kilogram (mg/kg). There is no regulatory standard for this parameter. The detected concentration of GRO may be attributable to contaminants in urban fill material placed at the Site. Analytical results did not identify detectable concentrations of pesticides and PCBs. Dimethyl phthalate, SVOC, was detected at a concentration below the method quantitation limits and below applicable regulatory standards. The compound is a common laboratory cross-contaminant. Beryllium and chromium were detected in WC-01 at concentration above the NYSDEC TAGM #4046 RSCO and below Eastern United States Soil Background Concentrations. The detected concentrations of metals are attributable either to natural (background) levels and/or to contaminants in urban fill material placed at the Site.

Groundwater was encountered at five (5) ftbg in SB-01 and eight (8) ftbg in SB-02. Methyl tert butyl ether (MTBE) and Total Suspended Solids (TSS) were detected in the groundwater sample a SB-02 at concentrations exceeding the NYCDEP Sewer Discharge Criteria. The detection of methyl tert butyl ether (MTBE), a gasoline additive, in the groundwater sample collected may be attributed to the former upgradient service station with gasoline tanks. The presence of TSS in the groundwater is attributed to the fact that the (unfiltered) sample was collected from a TWP and not a permanent monitoring well. The groundwater sample collected from a TWP is considered to be more representative of conditions to be encountered during construction activities. All other parameters were within NYCDEP Sewer Discharge Criteria.

Conclusions

Based on the results of the Phase II SCI, the following conclusions are presented:

- Field screening did not identify evidence of impacts in the boring locations. No PID readings were detected in the boring locations. No evidence of petroleum impacts, such as stained soil or petroleum odors, was identified in the boring locations.
- One SVOC, Dimethyl phthalate, was detected in WC-01 at a concentration below the method quantitation limits and below applicable standards. The compound is common laboratory cross contaminant.
- Beryllium and chromium were detected in WC-01 at a concentration above TAGM #4046 RSCO and below Eastern USA Soil Background Levels. The detected concentrations of metals are attributable to natural levels.
- Pesticides and PCBs were not detected in any of the soil samples analyzed.
- The subsurface soils did not exhibit hazardous waste characteristics.



- Groundwater does not meet NYCDEP Sewer Discharge Criteria and will require pre-treatment prior to discharge. MTBE and TSS were detected in the groundwater sample above NYCDEP Sewer Discharge Criteria. The MTBE, a gasoline additive, in the groundwater sample collected may be attributed to a former service station with gasoline tanks located approximately 115 feet upgradient from the Corridor. The presence of TSS in the groundwater is attributed to the fact that the (unfiltered) sample was collected from a TWP and not a permanent monitoring well. The groundwater sample collected from a TWP is considered to be more representative of conditions to be encountered during construction activities.

Based on the results of the field investigation and laboratory analytical results, ATC recommends the following:

- The contract documents should identify provisions for managing, handling, transporting and disposing of non-hazardous contaminated soil for metals. Since fill material may be present throughout the Corridor, contract documents should contain provisions for managing non-hazardous contaminated soil as a contingency. The contractor should be required to submit a Material Handling Plan to identify the specific protocol and procedures that will be employed to manage the waste in accordance with applicable regulations.
- Dust control procedures are recommended during excavation activities to minimize the creation and dispersion of fugitive airborne dust. The contractor may implement dust control measures to minimize potential airborne contaminants released as a direct result of construction activities. A Community Air Monitoring Plan (CAMP) shall be developed in accordance with NYSDEC DER-10 Regulations. The CAMP requires real-time monitoring for VOCs and particulates (i.e., dust) at the downwind perimeter of each designated work area when certain activities are in progress at contaminated sites. The CAMP is intended to provide a measure of protection for the downwind community from potential airborne contaminant releases as a direct result of investigative and remedial work activities. Specific requirements shall be reviewed for each situation in consultation with the New York State Department of Health (NYSDOH) to ensure proper applicability.
- Dewatering may be necessary during construction activities in the Corridor. Based on the results of laboratory analyses for NYCDEP parameters, MTBE and TSS were detected in the groundwater sample above the applicable NYCDEP Sewer Discharge Criteria and will require pre-treatment prior to discharge to sanitary or combined sewers. The contractor will be required to obtain a NYCDEP sewer discharge permit and perform sampling and laboratory analysis prior to discharge into sanitary and combined sewers.
- If discharge into storm sewers is required during dewatering, it must be done under the appropriate NYSDEC State Pollutant Discharge Elimination System (SPDES) permit. Additional sampling and laboratory analysis will be required to satisfy NYSDEC requirements prior to discharge into storm sewers.



- Before beginning any excavation activity, the contractor shall submit a site-specific health and safety plan (HASP) that will meet the requirements set forth by Occupational, Safety and Health Administration (OSHA), New York State Department of Health (NYSDOH) and any other applicable regulations. The HASP should identify the possible locations and risks associated with the potential contaminants that may be encountered, and the administrative and engineering controls that will be utilized to mitigate concerns.



1.0 INTRODUCTION

On behalf of the New York City Department of Design and Construction (NYCDDC), ATC Associates, Inc. (ATC) conducted a Phase II Subsurface Corridor Investigation (SCI) of the following six (6) street segments in the Jamaica section of Queens, New York (hereinafter referred to as the Corridor):

1. 164th Street, between 119th Avenue and 120th Avenue;
2. 119th Avenue, between 164th Street and Guy R. Brewer Boulevard;
3. 119th Avenue, between Guy R. Brewer Boulevard and Long Street;
4. 118th Avenue, between Guy R. Brewer Boulevard and Lakeview Boulevard;
5. Lakeview Boulevard, between 118th Avenue and 122nd Avenue; and
6. Lakeview Lane, between 122nd Avenue and Baisley Boulevard.

The Corridor is approximately 0.85 mile or 4,488 linear feet (LF) long and is located south of Foch Boulevard, west of 165th Street, north of Baisley Boulevard, and east of Baisley Pond and 155th Street in the Jamaica section of Queens, New York. Infrastructure improvements consisting of the excavation for the installation and/or repair of utilities is proposed throughout the Corridor. The Phase II SCI was conducted to determine if the Corridor's environmental condition might impact proposed construction activities.

1.1 Scope of Work

The Phase II SCI consisted of a field investigation, laboratory analyses, and preparation of a written report with tables summarizing the laboratory analytical results and figures depicting boring locations, significant site features and, if applicable, contamination occurrence and distribution. Drilling activities for the field investigation were performed by Zebra Environmental Corp. (Zebra) of Lynbrook, NY. Oversight of drilling activities was performed by ATC. Laboratory analyses were provided by CHEMTECH Consulting Group of Mountainside, New Jersey (CHEMTECH), a New York State Department of Health (NYSDOH) approved laboratory [No. 11376]. Field derived Quality Assurance/Quality Control samples (i.e. field blank, trip blank, duplicate) were not collected for this project. The field investigation was conducted on October 12, 2009 and consisted of the following components:

- The advancement of two (2) borings (SB-01 and SB-02) to a depth of 20 feet below grade (ftbg). The borings were advanced using a Geoprobe direct push drill rig. Prior to direct push advancement, borings were cleared to a depth of five (5) feet using a hand auger. Soil samples were collected using four (4)-foot long, 2-inch diameter Macro Core stainless steel samplers equipped with polyvinyl chloride (PVC) liners.
- Field screening, classification and identification of soils from the ground surface to the bottom of each boring. Soil samples were visually identified and classified in the field using the Burmister-based soil classification system. Field screening consisted of visual and olfactory indicators of contamination (staining, odors), as well as screening with a photo-ionization detector (PID).



- The collection of one (1) composite waste characterization sample (WC-01) composed of soil from borings SB-01 and SB-02 (grade to bottom).
- Laboratory analysis of the waste characterization sample for: (1) Target Compound List (TCL) Base Neutral/Acid (BN/A) extractable semi-volatile organic compounds (SVOCs) by United States Environmental Protection Agency (EPA) Method 8270; (2) Target Analyte List (TAL) metals by EPA Method 6010B series; (3) pesticides by EPA Method 8081A; (4) polychlorinated biphenyls (PCBs) by EPA Method 8082; (5) Full Toxicity Characteristics Leaching Procedure (TCLP); (6) Resource Conservation and Recovery Act (RCRA) Characteristics (ignitability, reactivity and corrosivity); and (7) Total Petroleum Hydrocarbons Diesel Range Organics/Gasoline Range Organics (TPHC DRO/GRO) via EPA Method 8015B.
- The installation of one (1) temporary well point (TWP) in boring SB-02 and the collection of one (1) groundwater sample using direct push technology by installing a slotted PVC screen bridging the groundwater table and riser pipe to grade. Dedicated PVC tubing was deployed in each TWP and connected to a check valve to extract the groundwater sample.
- Laboratory analysis of the groundwater sample for the parameters published by the New York City Department of Environmental Protection (NYCDEP) as Limitations for Effluent to Sanitary or Combined Sewers (NYCDEP Sewer Discharge Criteria).



2.0 CORRIDOR INFORMATION

2.1 Corridor Location, Description and Use

The Corridor is located in the Jamaica section of Queens, New York. The Corridor consists of the following six (6) street segments:

1. 164th Street, between 119th Avenue and 120th Avenue;
2. 119th Avenue, between 164th Street and Guy R. Brewer Boulevard;
3. 119th Avenue, between Guy R. Brewer Boulevard and Long Street;
4. 118th Avenue, between Guy R. Brewer Boulevard and Lakeview Boulevard;
5. Lakeview Boulevard, between 118th Avenue and 122nd Avenue; and
6. Lakeview Lane, between 122nd Avenue and Baisley Boulevard.

The Corridor is generally located in an area of mixed residential and some commercial/retail use. The Corridor is developed with paved roadways and existing infrastructure systems. Manholes, storm sewers and natural gas meters are visible in roadway and sidewalk areas, and indicate the presence of multiple buried utilities, including water, sewer and natural gas. Current use of the Corridor and the surrounding area consists primarily of residential use and some commercial/retail establishments. The Guy R. Brewer Dialysis Center is located at the eastern extension of the 118th Avenue street segment and a restaurant is located along 119th Avenue between Guy R. Brewer Boulevard and 164th Street. No significant contamination was detected during the Phase II SCI that could be attributed to a specific historical or current site located directly on the Corridor.

2.2 Description of Surrounding Properties

The Corridor is primarily surrounded by residential development, typically consisting of one- and two-story homes. The Baisley Park Houses, a multi-family public housing complex consisting of five (5) eight-story apartment buildings is located to the north of the Corridor, along Foch Boulevard. Commercial/retail buildings are located along Guy R. Brewer Boulevard and Baisley Boulevard. Baisley Pond Park is located to the west of the Corridor, along Lakeview Boulevard and Lakeview Lane. Specific properties of concern include a Getty gasoline station that is currently located off the Corridor and upgradient, at the southwestern corner of the intersection of Baisley Boulevard and Guy R. Brewer Boulevard. Historically (1950-1999), a gasoline station was located off the Corridor and upgradient, at the southeastern corner of the intersection of Baisley Boulevard and Guy R. Brewer Boulevard, which is currently a Walgreens Pharmacy. A former service station with multiple gasoline tanks was historically located off the Corridor and upgradient, at the intersection of Guy R. Brewer Boulevard and Foch Boulevard. Currently, this site is a commercial building. The detection of methyl tert butyl ether (MTBE), a gasoline additive, in the groundwater sample collected may be attributed to the former service station with gasoline tanks.



2.3 Corridor and Regional Topographic Setting

Based on a review of the United States Geological Survey (USGS) 7.5 Minute Quadrangle Map, Jamaica, NY, dated 1994, the elevation of the Corridor ranges from approximately 10 feet above mean sea level (msl) at Lakeview Boulevard to approximately 20 feet msl at the intersection of 118th Avenue and Guy R. Brewer Boulevard. The topography of the immediate Corridor area slopes gently to the west. Surface water runoff is expected to follow the local topographic slope to the west towards Baisley Pond. A copy of the topographic map is presented on Figure 1.

2.4 Corridor and Regional Geology

Based on the New York Department of Environmental Conservation, Water Power and Control Commission report titled *Ground Water in Bronx, New York, and Richmond Counties, with Summary Data on Kings and Queens Counties, New York City, New York*, the area's geology is expected to consist of Pleistocene age glacial till deposits and glaciofluvial sediments derived from melt-water of the retreating glaciers. The upper portions of the glacial deposits have been disturbed by a long history of development activities, thus resulting in a layer of fill material, which is classified as Urban Land. The subsurface material encountered during this Phase II SCI from grade to 20 ftbg consisted predominantly of fine to medium sand, with variable amounts of clay, silt and gravel, which appeared to be consistent with glacial and glaciofluvial deposits. Man-made materials (brick, concrete, etc) or wood fragments, which would be indicative of urban fill, were not observed. Some organic material (peat) was observed in boring SB-01 which was located near Baisley Pond. Bedrock was not encountered during this Phase II SCI. Based on the USGS *Hydrogeologic Framework of Long Island, New York*, dated 1989, in the vicinity of the Corridor bedrock is expected to be at a depth greater than 200 ftbg. Geologic Boring Logs are provided in Appendix B.

2.5 Corridor and Regional Hydrogeology

The nearest surface water body is Baisley Pond, located adjacent to the west of the Corridor. The major regional surface water body is Jamaica Bay, located approximately 2.5 miles south of the Corridor. In the vicinity of the Corridor, the local groundwater flow direction is anticipated to be to the west and west-southwest, toward Baisley Pond. Groundwater was encountered at five (5) ftbg in SB-01 and eight (8) ftbg in SB-02. Estimated groundwater levels and/or flow direction(s) may vary due to seasonal fluctuations in precipitation, local usage demands, geology, underground structures, or dewatering operations.

2.6 Summary of Previous Environmental Investigations

ATC prepared a Phase I Corridor Assessment Report (CAR) dated July 9, 2009, which presented the results of a survey conducted along the Corridor to document the current use. The survey also included a review of fire insurance maps to document historical use and a limited review of the state databases to identify sites that are known to be contaminated. The CAR described the Corridor lying in an area of residential and light commercial use.



The CAR recommended a total of two (2) borings to address a total of three (3) Final "Moderate" risk sites that have the potential to impact the subsurface of the Corridor. The final "Moderate" Risk sites are listed below:

MODERATE RISK SITES:

1. Getty Gasoline Station, 161-51 Baisley Blvd. (Map ID 3, B15, B17, B18).
2. 125 Starr Inc./Carmichael's Service, 117-07 Guy R. Brewer Boulevard (formerly a service station and currently commercial building), (Map ID A8, A9/34).
3. D & the 4 Rs, 127-04 Guy R. Brewer Boulevard (formerly a gasoline station and currently Walgreen's Pharmacy), (Map ID 27, D30).



3.0 CORRIDOR EVALUATION

Proposed construction activities at this site include soil excavation and may include dewatering, which in turn requires that soils and groundwater at the site be characterized to identify material handling requirements (i.e. use of protective equipment) and for material reuse, handling and/or waste disposal requirements. ATC provided oversight for the advancement of two (2) soil borings and the installation of one (1) TWP during the field investigation at the designated areas in the vicinity of the planned construction. Groundwater was encountered at five (5) and eight (8) ftbg. The soil and groundwater samples from the borings and TWP were transferred into laboratory-supplied sample jars and properly labeled. The samples were stored with ice in a cooler to preserve them at 4° Celsius prior to and during shipment. A chain-of-custody was prepared prior to sample shipment. A summary of environmental boring data and field observations is provided in Table 1.

3.1 Soil Quality Investigation

Two (2) borings (SB-01 and SB-02) were advanced to a depth of 20 ftbg using a Geoprobe direct push drill rig. Prior to direct push advancement, borings were cleared to a depth of five (5) ftbg using a hand auger. Soil samples were collected using four (4)-foot long, 2-inch diameter Macro Core stainless steel samplers equipped with polyvinyl chloride (PVC) liners. The location of the Corridor and soil boring locations are provided on Figure 2. The designations and sampling intervals for the samples that were submitted to the laboratory are included in Table 1. Boring location sketches depicting each boring location are included in Appendix A. The locations of each boring are described below:

- **SB-01** – Advanced downgradient of “Moderate” risk sites No. 1 and No. 3, and located on Lakeview Lane, 250 feet southeast of the 122nd Avenue southern curb line and 1 feet west of the Lakeview Lane western street line, in the dirt shoulder.
- **SB-02** – Advanced downgradient of “Moderate” risk site No. 2, and located on 118th Street, 15 feet west of the Guy R. Brewer Boulevard western curb line and 4 feet south of the 118th Avenue northern curb line, in the street.

Soil from each boring was classified and examined for visual evidence (i.e. staining, discoloration) and any olfactory indications (i.e. odors) of contamination. Continuous soil samples were collected from each boring at four foot intervals. Upon sample retrieval, the soils were examined for visual evidence (i.e. staining, discoloration) and any olfactory indications (i.e. odors) of contamination. In addition, a photo-ionization detector (PID) was used to screen the soil for VOCs.

Since contamination was not identified during field screening, grab samples to identify representative conditions relative to the presence of VOCs were not collected from the two (2) “Moderate” risk borings.



In order to identify representative conditions for disposal purposes, an aliquot of soil from the two (2) borings (SB-01 and SB-02) was reserved and combined to create one (1) composite waste characterization sample (WC-01). The waste classification sample was analyzed for Full Toxicity Characteristics Leaching Procedure (TCLP), Resource Conservation and Recovery Act (RCRA) Characteristics (Ignitability, Reactivity and Corrosivity) via EPA Method 7.3.4.2, and Total Petroleum Hydrocarbons Diesel Range Organics/Gasoline Range Organics (TPHC DRO/GRO) via EPA Method 8015B. The waste classification soil sample was compared with the Toxicity Characteristic Regulatory Levels for hazardous waste published in RCRA and NYSDEC Part 371.

In order to identify representative conditions relative to the presence of SVOCs, metals, pesticides and PCBs over the entire soil column at the borings, one (1) composite sample was collected. For the boring composite sample collected, soil from the whole column was mixed in a glass jar or stainless steel bowl before sample selection. Boring composite samples were collected from the top of the column to the depth of 20 ftbg.

Soil classification information, including stratigraphy, is documented on the boring logs included in Appendix B. All boring equipment was cleaned by being rinsed with tap water, scrubbed with Alconox, then rinsed with deionized water again between each sample interval. In addition, a clear, dedicated PVC liner was used inside the Macro Core sampler for neat recovery of the soil cores. Following the completion of each boring, the boreholes were back-filled with drill cuttings, and then sealed with cement grout or asphalt, if appropriate.

3.2 Groundwater Quality Investigation

As groundwater may be encountered within the depths associated with the future excavation, one (1) groundwater sample was collected for screening and laboratory analysis during the soil boring activities. A TWP was installed in soil boring SB-02. For the installation of the TWP, the Geoprobe unit was advanced to a depth of 20 ftbg, approximately 12 feet into the encountered water table. The TWP consisted of a 15-foot length section of one-inch diameter schedule 40 PVC screen and riser. The location of the TWP is provided on Figure 2. A groundwater sample was collected from the TWP for screening and laboratory analysis via dedicated PVC tubing and check valve. All tubing was new, clean and unused and was properly disposed after use. Upon extraction, the sample was examined for visual evidence (i.e., discoloration, sheen) and any olfactory indications (i.e. odors) of contamination were noted.

The groundwater sample was analyzed for parameters published by NYCDEP as Limitations for Effluent to Sanitary or Combined Sewers. The analytical results of the groundwater sample were compared to the NYCDEP Sewer Discharge Criteria.



4.0 FINDINGS

This section discusses the analytical data and findings for the activities discussed in Section 3.0. Boring logs can be found in Appendix B. Complete analytical data reports are included in Appendix C.

4.1 Field Screening

Based on the results of field screening (visual or olfactory observations and/or PID measurements), no evidence of contamination was encountered during the subsurface investigation. No PID readings were detected above the background level [one (1) part per million (ppm)] in the soil borings. Additionally, no visual or olfactory evidence of petroleum contamination was encountered during the collection of groundwater samples. Refer to Table 1 for a summary of environmental boring data.

4.2 Soil and Groundwater Laboratory Analytical Results

The soil and groundwater samples were submitted to CHEMTECH for analysis. Field derived Quality Assurance/Quality Control samples (i.e. field blank, trip blank, duplicate) were not collected for this project. Laboratory analytical reports are included in Appendix C.

The boring composite soil sample (WC-01) composited from the two (2) borings (SB-01 and SB-02) was analyzed for SVOCs Base Neutral/Acid (BN/A) extractables by EPA Method 8270, TAL metals by EPA 6010B series, pesticides by EPA Method 8081A, and PCBs by EPA Method 8082. In order to evaluate the subsurface soil quality, the laboratory analytical results were compared with the regulatory standards identified in: (1) NYSDEC Technical and Administrative Guidance Memorandum #4046 (TAGM) dated 1994, which provides the Recommended Soil Cleanup Objectives (RSCOs) and the Eastern Soil Background Concentrations for metals; (2) NYSDEC STARS 1992 Memo #1 Petroleum Contamination Soil Guidance Policy Toxicity Characteristic Leaching Procedure (TCLP) Alternative Guidance Values; and (3) NYSDEC Subpart 375-6: Remedial Program Soil Cleanup Objectives (SCOs) Unrestricted and Restricted Use (Track 1 and Track 2). The laboratory analytical results of the waste classification soil sample were compared with the Toxicity Characteristic Regulatory Levels for Hazardous Waste published in RCRA and NYSDEC Part 371.

TAGM provides guidance for remedial actions at NYSDEC Inactive Hazardous Waste and Spill sites, based on health-related concerns and available clean-up technologies. NYSDEC Subpart 375-6: Remedial Program Soil Cleanup Objectives provides Unrestricted Use (Track 1) SCOs.

The groundwater sample was analyzed for parameters published by NYCDEP as Limitations for Effluent to Sanitary or Combined Sewers. The analytical results of the groundwater samples were compared to the criteria published by the NYCDEP.



4.2.1 Semi-Volatile Organic Compounds (SVOCs) in Soil

Dimethyl phthalate was detected in WC-01 at a concentration below the method quantitation limits and below applicable standards. The compound is a common laboratory cross contaminant. Refer to Table 2 for a summary of SVOC detections.

4.2.2 Target Analyte List (TAL) Metals in Soil

Beryllium and chromium were detected in WC-01 at concentrations above TAGM #4046 RSCOs and below Eastern USA Soil Background Levels. No other metals were detected above TAGM #4046 RSCO or Eastern USA Soil Background Levels. The detected concentrations of metals are attributable either to natural levels or to contaminants in urban fill material placed at the Site. Refer to Table 3 for a summary of TAL metals detections.

4.2.3 Pesticides in Soil

Pesticides were not detected in WC-01. Refer to Table 4 for a summary of pesticide analytical results.

4.2.4 Polychlorinated Biphenyls (PCBs) in Soil

PCBs were not detected in WC-01. Refer to Table 5 for a summary of PCB analytical results.

4.2.5 Waste Classification of Soil

Ignitability (flash point), reactivity (cyanide and sulfide), and corrosivity (pH) were within the acceptable RCRA ranges. TCLP VOCs, SVOCs, herbicides and pesticides were not detected in the waste classification soil sample (WC-01). Metals were detected, but at levels below NYSDEC TAGM 4046 RSCOs, Eastern Soil Background concentrations and below RCRA Hazardous Waste Levels. TPH DRO was not detected in the waste characterization soil sample. TPH GRO was detected at a concentration of 7.18 milligrams per kilogram (mg/kg). There is no standard for TPHC DRO/GRO. Analytical results will need to be compared to levels acceptable by the chosen receiving facility to determine appropriate waste classification prior to off-site disposal. Refer to Table 6 for a summary of TCLP parameters and RCRA characteristics.

4.2.6 Analysis of NYCDEP Parameters in Groundwater

The groundwater sample was analyzed for the parameters required by the NYCDEP Limitations for Effluent to Sanitary or Combined Sewers (Daily Limit). MTBE was detected at a concentration of 260 micrograms per liter ($\mu\text{g/L}$) which is above the NYCDEP Sewer Discharge Criteria of 50 $\mu\text{g/L}$. Total Suspended Solids (TSS) were detected at a concentration of 1,100 milligrams per liter (mg/L) which is above the NYCDEP Sewer Discharge Criteria of 350 mg/L. All other parameters are within NYCDEP Sewer Discharge Criteria. The detection of MTBE, a gasoline additive, may be attributed to the former upgradient service station with gasoline tanks. The presence of TSS is attributed to the fact that the (unfiltered) groundwater sample was



collected from a TWP and not a permanent monitoring well. Normally, a permanent monitoring well would be "developed" prior to the collection of samples to remove suspended sediments. However, the groundwater sample collected from a TWP is considered to be more representative of conditions to be encountered during construction activities. Based on the results for MTBE and TSS, groundwater does not meet NYCDEP Sewer Discharge Criteria and will require pre-treatment prior to discharge. Refer to Table 7 for a summary of selected NYCDEP parameters in groundwater.



5.0 CONCLUSIONS AND RECOMMENDATIONS

Based on the results of the field investigation and a review of the analytical results compared to the RCRA, NYSDEC Part 371, NYSDEC TAGM #4046, and NYCDEP Sewer Discharge Criteria, the following conclusions are presented:

- Field screening did not identify evidence of impacts in the boring locations. No PID readings were detected in the boring locations. No evidence of petroleum impacts, such as stained soil or petroleum odors, was identified in the boring locations.
- One SVOC, Dimethyl phthalate, was detected in WC-01 at a concentration below the method quantitation limits and below applicable standards. The compound is common laboratory cross contaminant.
- Beryllium and chromium were detected in WC-01 at a concentration above TAGM #4046 RSCO and below Eastern USA Soil Background Levels. The detected concentrations of metals are attributable to natural levels.
- Pesticides and PCBs were not detected in any of the soil samples analyzed.
- The subsurface soils did not exhibit hazardous waste characteristics.
- Groundwater does not meet NYCDEP Sewer Discharge Criteria and will require pre-treatment prior to discharge. MTBE and TSS were detected in the groundwater sample above NYCDEP Sewer Discharge Criteria. The MTBE, a gasoline additive, in the groundwater sample collected may be attributed to a former service station with gasoline tanks located approximately 115 feet upgradient from the Corridor. The presence of TSS in the groundwater is attributed to the fact that the (unfiltered) sample was collected from a TWP and not a permanent monitoring well. The groundwater sample collected from a TWP is considered to be more representative of conditions to be encountered during construction activities.

Based on the results of the field investigation and laboratory analytical results, ATC recommends the following:

- The contract documents should identify provisions for managing, handling, transporting and disposing of non-hazardous contaminated soil for metals. Since fill material may be present throughout the Corridor, contract documents should contain provisions for managing non-hazardous contaminated soil as a contingency. The contractor should be required to submit a Material Handling Plan to identify the specific protocol and procedures that will be employed to manage the waste in accordance with applicable regulations.
- Dust control procedures are recommended during excavation activities to minimize the creation and dispersion of fugitive airborne dust. The contractor may implement dust control measures to minimize potential airborne contaminants released as a direct result of construction activities. A Community Air Monitoring Plan (CAMP) shall be developed in



accordance with NYSDEC DER-10 Regulations. The CAMP requires real-time monitoring for VOCs and particulates (i.e., dust) at the downwind perimeter of each designated work area when certain activities are in progress at contaminated sites. The CAMP is intended to provide a measure of protection for the downwind community from potential airborne contaminant releases as a direct result of investigative and remedial work activities. Specific requirements shall be reviewed for each situation in consultation with the New York State Department of Health (NYSDOH) to ensure proper applicability.

- Dewatering may be necessary during construction activities in the Corridor. Based on the results of laboratory analyses for NYCDEP parameters, MTBE and TSS were detected in the groundwater sample above the applicable NYCDEP Sewer Discharge Criteria and will require pre-treatment prior to discharge to sanitary or combined sewers. The contractor will be required to obtain a NYCDEP sewer discharge permit and perform sampling and laboratory analysis prior to discharge into sanitary and combined sewers.
- If discharge into storm sewers is required during dewatering, it must be done under the appropriate NYSDEC State Pollutant Discharge Elimination System (SPDES) permit. Additional sampling and laboratory analysis will be required to satisfy NYSDEC requirements prior to discharge into storm sewers.
- Before beginning any excavation activity, the contractor shall submit a site-specific health and safety plan (HASP) that will meet the requirements set forth by Occupational, Safety and Health Administration (OSHA), New York State Department of Health (NYSDOH) and any other applicable regulations. The HASP should identify the possible locations and risks associated with the potential contaminants that may be encountered, and the administrative and engineering controls that will be utilized to mitigate concerns.



6.0 STATEMENT OF LIMITATIONS

The data presented and the opinions expressed in this report are qualified as stated in the attachment to this section of the report.

Report Prepared By:

Matthew Mankovich
Senior Project Manager

Report Reviewed By:

Constantine Tsentas, P.G.
Manager, Environmental Division



STATEMENT OF LIMITATIONS

The data presented and the opinions expressed in this report are qualified as follows:

The sole purpose of the investigation and of this report is to assess the physical characteristics of the Site with respect to the presence or absence in the environment of oil or hazardous materials and substances as defined in the applicable state and federal environmental laws and regulations and to gather information regarding current and past environmental conditions at the Site.

ATC derived the data in this report primarily from visual inspections, examination of records in the public domain, interviews with individuals with information about the Site, and a limited number of subsurface explorations made on the dates indicated. The passage of time, manifestation of latent conditions or occurrence of future events may require further exploration at the Site, analysis of the data, and reevaluation of the findings, observations, and conclusions expressed in the report.

In preparing this report, ATC has relied upon and presumed accurate certain information (or the absence thereof) about the Site and adjacent properties provided by governmental officials and agencies, the Client, and others identified herein. Except as otherwise stated in the report, ATC has not attempted to verify the accuracy or completeness of any such information.

The data reported and the findings, observations, and conclusions expressed in the report are limited by the Scope of Services, including the extent of subsurface exploration and other tests. The Scope of Services was defined by the requests of the Client, the time and budgetary constraints imposed by the Client, and the availability of access to the Site.

Because of the limitations stated above, the findings, observations, and conclusions expressed by ATC in this report are not, and should not be considered, an opinion concerning the compliance of any past or present owner or operator of the site with any federal, state or local law or regulation. No warranty or guarantee, whether express or implied, is made with respect to the data reported or findings, observations, and conclusions expressed in this report. Further, such data, findings, observations, and conclusions are based solely upon site conditions in existence at the time of investigation.

This report has been prepared on behalf of and for the exclusive use of the Client, and is subject to and issued in connection with the Agreement and the provisions thereof.

TABLES



TABLES

TABLE 1 – SUMMARY OF FIELD INVESTIGATION

TABLE 2 – SUMMARY OF TCL SVOCs DETECTED IN SOIL

TABLE 3 – SUMMARY OF TAL METALS DETECTED IN SOIL

TABLE 4 – SUMMARY OF PESTICIDES ANALYTICAL RESULTS IN SOIL

TABLE 5 – SUMMARY OF PCBS ANALYTICAL RESULTS IN SOIL

**TABLE 6 – SUMMARY OF WASTE CHARACTERIZATION SAMPLE
ANALYSIS OF SOIL**

**TABLE 7 – SUMMARY OF NYCDEP PARAMETERS ANALYZED IN THE
GROUNDWATER SAMPLE**



Table 1. Summary of Environmental Boring Data
Phase II Subsurface Corridor Investigation for Reconstruction of South Jamaica Area
Queens, New York

Boring No.	Sample ID	PID (ppm)	Sample Interval (ftbg)	Total VOCs (mg/kg)	Total SVOCs (mg/kg)	Metals Exceed (Yes/No) ¹	Total PCBs (mg/kg)	Total Pesticides (mg/kg)	Depth to Water (ftbg)	Total Depth (ftbg)	Other Comments
SB-01	WC-01	0	0-20	N/A	0.21	Yes	N/A	N/A	5	20	Boring composite sample and aliquot for waste characterization composite sample
SB-02	WC-01	0	0-20	N/A	0.21	Yes	N/A	N/A	8	20	Boring composite sample and aliquot for waste characterization composite sample Temporary Well Point (TWP) installed

Notes:

- 1. Metal(s) exceeds TAGM 4046 or Eastern USA Soil (EUS) Background guidance values.
- N/S - Not Sampled
- ND - Not Detected
- N/A - Not Analyzed
- ftbg = feet below grade
- ppm = parts per million
- mg/kg = milligrams per kilogram

ATC Associates Inc.
DDC Project Number: HWQ121B4

December 7, 2009
Work Order Letter No. 6481-ATC-6258



Table 2. Summary of Target Compound List Semi-Volatile Organic Compounds Detected in Soil
Phase II Subsurface Corridor Investigation for Reconstruction of South Jamaica Area
Queens, New York

TCL SVOC	Unrestricted Use (Track 1) Soil Cleanup Objectives (SCOs)	Restricted-Residential Use (Track 2) Soil Cleanup Objectives (SCOs)	STARS TCLP Alternative Guidance Values	TAGM #4046 Recommended Soil Clean-up Objective	Sample ID, Date Collected and Depth
Dimethyl Phthalate	NS	NS	NS	2	WC-01 10/12/2009 0-20' 0.21

Notes:

All concentrations are reported in parts per million (ppm or mg/kg)

ND = Compound not detected above method detection limit (see attached lab report for mol's)

NS = No Standard

J = Compound detected below the quantitation limit

B = Compound was detected in an associated laboratory blank

TAGM RSCOs = NYSDEC Technical and Administrative Guidance Memorandum (TAGM #4046) Recommended Soil Cleanup Objectives (RSCOs) (January 24, 1994)

SCOs = Soil Cleanup Objectives as per the NYSDEC Regulations 6 NYCRR Subpart 375-6 Remedial Program Soil Cleanup Objectives (December 14, 2006)

STARS TCLP Alternative Guidance Values are the Spill Technology and Remediation Series (STARS) Toxicity Characteristic Leaching Procedure (TCLP) Alternative Guidance Values, NYSDEC STARS Memorandum 1 - Petroleum Contaminated Soil Guidance Policy (August 1992)

BOLD = Concentration exceeds NYSDEC TAGM RSCOs

Shading = Concentration exceeds Unrestricted Use (Track 1) Soil Cleanup Objectives

Underline = Concentration exceeds STARS TCLP Alternative Guidance Values

ATC Associates Inc.

DDC Project Number: HWC121B4

December 7, 2009

Work Order Letter No. 6481-ATC-6258



Table 3. Summary of Target Analyte List Metals Detected in Soil
Phase II Subsurface Corridor Investigation for Reconstruction of South Jamaica Area
Queens, New York

Target Analyte List Metal	RCRA Hazardous Waste Levels (mg/L)	20 Times RCRA Hazardous Waste Levels (mg/L)	Eastern USA Soil Background (mg/kg)	TAGM #4046 Recommended Soil Clean-up Objective (mg/kg)	Unrestricted Use (Track 1) Soil Cleanup Objectives (SCOs)	Sample ID, Date Collected and Depth
Aluminum	NS	NS	33,000	SB	NS	WC-01 10/12/2009 0-20'
Barium	100	2,000	15 - 600	300 or SB	350	4020 29.8
Beryllium	NS	NS	0-1.75	0.16 or SB	7.2	0.18J
Cadmium	1	20	0.1-1	1 or SB	2.5	0.1J
Calcium	NS	NS	130 - 35,000	SB	NS	665
Chromium	5	100	1.5 - 40	10 or SB	NS	13.1
Copper	NS	NS	1 - 50	25 or SB	50	2.92
Cobalt	NS	NS	2.5 - 60	30 or SB	NS	5.44
Iron	NS	NS	2,000 - 550,000	2,000 or SB	NS	8110
Lead	5	100	500*	SB	63	5.7
Magnesium	NS	NS	100 - 5,000	SB	NS	1050
Manganese	NS	NS	50 - 5,000	SB	1600	138
Nickel	NS	NS	0.5-25	13 or SB	30	9.39
Potassium	NS	NS	8,500 - 4,300	SB	NS	338
Selenium	1	20	0.1-3.9	2 or SB	3.9	0.66J
Sodium	NS	NS	6,000 - 8,000	SB	NS	181
Vanadium	NS	NS	1 - 300	150 or SB	NS	13.6
Zinc	NS	NS	9 - 50	20 or SB	109	19.1

Notes:

- All concentrations are in parts per million (ppm, mg/kg, or mg/L)
- ND = Compound not detected above method detection limit (see attached lab report for md'l's)
- NS = No Standard
- SB = Site Background Concentration
- TAGM RSCOs = NYSDEC Technical and Administrative Guidance Memorandum (TAGM #4046) Recommended Soil Cleanup Objectives (RSCOs) (January 24, 1994)
- BOLD = Concentration exceeds NYSDEC TAGM RSCOs
- Shading = Detected concentration exceeds Eastern Soil Background Concentrations as per TAGM RSCOs
- Underline = Concentration exceeds twenty times RCRA Hazardous Waste Level
- *Background levels for lead vary widely. Average levels in undeveloped, rural areas may range from 4 - 61 ppm. Average background levels in metropolitan or suburban areas or near highways are much higher and typically range from 200 - 500 ppm



Table 4. Summary of Pesticides Analytical Results in Soil
Phase II Subsurface Corridor Investigation for Reconstruction of South Jamaica Area
Queens, New York

Pesticides	Unrestricted Use (Track 1) Soil Cleanup Objectives (SCOs)	Restricted-Residential Use (Track 2) Soil Cleanup Objectives (SCOs)	STARS TCLP Alternative Guidance Values	TAGM #4046 Recommended Soil Clean-up Objective	Sample ID, Date Collected and Depth
Pesticides	Varies by compound	Varies by compound	Varies by compound	Varies by compound	WC-01 10/12/2009 0-20' ND

Notes:

- All concentrations are reported in parts per million (ppm or mg/kg)
- ND = Compound not detected above method detection limit (see attached lab report for md'l's)
- NS = No Standard
- J = Compound detected below the quantitation limit
- B = Compound was detected in an associated laboratory blank
- TAGM RSCOs = NYSDEC Technical and Administrative Guidance Memorandum (TAGM #4046) Recommended Soil Cleanup Objectives (RSCOs) (January 24, 1994)
- SCOs = Soil Cleanup Objectives as per the NYSDEC Regulations 6 NYCRR Subpart 375-6 Remedial Program Soil Cleanup Objectives (December 14, 2006)
- STARS TCLP Alternative Guidance Values are the Spill Technology and Remediation Series (STARS) Toxicity Characteristic Leaching Procedure (TCLP) Alternative Guidance Values, NYSDEC STARS Memorandum 1 - Petroleum Contaminated Soil Guidance Policy (August 1992)
- BOLD** = Concentration exceeds NYSDEC TAGM RSCOs
- Shading = Concentration exceeds Unrestricted Use (Track 1) Soil Cleanup Objectives
- Underlining = Concentration exceeds STARS TCLP Alternative Guidance Values



Table 5. Summary of Polychlorinated Biphenyl Analytical Results in Soil
Phase II Subsurface Corridor Investigation for Reconstruction of South Jamaica Area
Queens, New York

PCBs	Unrestricted Use (Track 1) Soil Cleanup Objectives (SCOs)	Restricted-Residential Use (Track 2) Soil Cleanup Objectives (SCOs)	STARS TCLP Alternative Guidance Values	TAGM #4046 Recommended Soil Clean-up Objective	Sample ID, Date Collected and Depth
PCBs	NS	1	NS	1 (surface) 10 (subsurface)	WC-01 10/12/2009 0-20' ND

Notes:

- All concentrations are reported in parts per million (ppm or mg/kg)
- ND = Compound not detected above method detection limit (see attached lab report for mdl's)
- NS = No Standard
- J = Compound detected below the quantitation limit
- B = Compound was detected in an associated laboratory blank
- TAGM RSCOs = NYSDEC Technical and Administrative Guidance Memorandum (TAGM #4046) Recommended Soil Cleanup Objectives (RSCOs) (January 24, 1994)
- SCOs = Soil Cleanup Objectives as per the NYSDEC Regulations 6 NYCRR Subpart 375-6 Remedial Program Soil Cleanup Objectives (December 14, 2006)
- STARS TCLP Alternative Guidance Values are the Spill Technology and Remediation Series (STARS) Toxicity Characteristic Leaching Procedure (TCLP) Alternative Guidance Values, NYSDEC STARS Memorandum 1 - Petroleum Contaminated Soil Guidance Policy (August 1992)
- BOLD** = Concentration exceeds NYSDEC TAGM RSCOs
- Shading** = Concentration exceeds Unrestricted Use (Track 1) Soil Cleanup Objectives
- Underline = Concentration exceeds STARS TCLP Alternative Guidance Values



Table 6. Summary of Waste Characterization Sample Analysis of Soil
 Phase II Subsurface Corridor Investigation for Reconstruction of South Jamaica Area
 Queens, New York

Parameter	RCRA Hazardous Waste Levels	Sample ID, Date Collected and Boring	
		WC-01 10/12/2009	
		SB-01 and SB-02	
RCRA Characteristics			
Reactivity Cyanide	250 mg/kg		ND
Reactivity Sulfide	500 mg/kg		ND
Flash Point - Liquid/Solid	140 Degrees Fahrenheit (F)		>200 F
pH (Corrosivity)	>2 and < 12.5 S.U.		7.4 S.U.
1,1-Dichloroethene	0.7 mg/L		ND
1,2-Dichloroethane	0.5 mg/L		ND
2-Butanone	200 mg/L		ND
Benzene	0.5 mg/L		ND
Carbon Tetrachloride	5 mg/L		ND
Chlorobenzene	100 mg/L		ND
Chloroform	6 mg/L		ND
Tetrachloroethene	0.7 mg/L		ND
Trichloroethene	0.5 mg/L		ND
Vinyl Chloride	0.2 mg/L		ND
1,4-Dichlorobenzene	7.5 mg/L		ND
2,4,5-Trichlorophenol	400 mg/L		ND
2,4,6-Trichlorophenol	2 mg/L		ND
2,4-Dinitrotoluene	0.13 mg/L		ND
2-Methylphenol	200 mg/L		ND
3+4-Methylphenols	200 mg/L		ND
Hexachlorobenzene	0.13 mg/L		ND
Hexachlorobutadiene	0.5 mg/L		ND
Hexachloroethane	3 mg/L		ND
Nitrobenzene	2 mg/L		ND
Pentachlorophenol	100 mg/L		ND
Pyridine	5 mg/L		ND
2,4,5-TP (SILVEX)	1 mg/L		ND
2,4-D	10 mg/L		ND
Chlordane	0.03 mg/L		ND
Endrin	0.02 mg/L		ND
gamma-BHC	0.4 mg/L		ND
Heptachlor	0.008 mg/L		ND
Heptachlor epoxide	0.008 mg/L		ND
Methoxychlor	10 mg/L		ND
Toxaphene	0.5 mg/L		ND
Arsenic	5 mg/L		ND
Barium	100 mg/L		0.189J mg/L
Cadmium	1 mg/L		ND
Chromium	5 mg/L		ND
Lead	5 mg/L		0.0541J mg/L
Mercury	0.2 mg/L		0.0018J mg/L
Selenium	1 mg/L		ND
Silver	5 mg/L		ND
TPH-DRO	NS mg/kg		ND
TPH-GRO	NS mg/kg		7.18

Notes:

NS = No Standard

ND = Compound not detected above method detection limit (see attached lab report for mdl's)

BOLD and Shaded = Concentration failed TCLP analysis

F = Degrees Fahrenheit

S.U. = Standard Units



Table 7. Summary of NYCDEP Parameters Analyzed in Groundwater Samples

Parameter ¹	NYC DEP Limitations to Sanitary or Combined Sewers		Well ID, Date Collected and Depth to Water	
			SB-02	
			10/12/2009	
				8 Feet
Non-Polar Material ²	50	mg/L		ND
pH	5-12	SU's		6.2
Temperature	< 150	°F		66.2
Flash Point - Liquid/Solid	> 140	°F		> 150
Cadmium (Instantaneous or Composite)	2 or 0.69	mg/L		0.00165
Chromium Hexavalent (VI)	5	mg/L		ND
Copper	5	mg/L		0.0662
Lead	2	mg/L		0.0432
Mercury	0.05	mg/L		ND
Nickel	3	mg/L		0.141
Zinc	5	mg/L		0.0932
Benzene	134	ug/L		59
Carbon Tetrachloride	NS	ug/L		ND
Chloroform	NS	ug/L		ND
1,4 Dichlorobenzene	NS	ug/L		ND
Ethylbenzene	380	ug/L		ND
MTBE (Methyl-Tert-Butyl-Ether)	50	ug/L		260
Naphthalene	47	ug/L		0.3
Phenol	NS	ug/L		72
Tetrachloroethene	20	ug/L		ND
Toluene	74	ug/L		ND
1,2,4 Trichlorobenzene	NS	ug/L		0.14
1,1,1 Trichloroethane	NS	ug/L		ND
Xylenes (Total)	74	ug/L		ND
PCBs (Total) ³	1	ug/L		ND
Total Suspended Solids	350	mg/L		1,100
CBOD ⁵	NS	mg/L		ND
Chloride ⁵	NS	mg/L		510
Total Nitrogen ⁵	NS	mg/L		4.5
Total Solids ⁵	NS	mg/L		2,300

Notes:

All concentrations are reported in parts per million (ppm or mg/L) or parts per billion (ppb or ug/L)

N/A = Compound or sample characteristic not analyzed

NS = No Standard

ND = Compound not detected above method detection limit (see attached lab report for mdl's)

Bold = Positive detection

Shaded = Concentration exceeds NYCDEP Limitations for Effluent to Sanitary or Combined Sewers (daily limit)

¹ All handling and preservation of collected samples and laboratory analyses of samples was performed in accordance with 40 CFR Part 136.

² Analysis for non-polar materials was performed by EPA method 1664.

³ Analysis for PCBs was performed according to EPA method 608 with method detection limit =<65 parts per trillion. Analysis for PCBs is required if discharge =>10,000 gallons per day (gpd) and duration of discharge > 10 days.

⁴ For discharge >= 10,000 gpd, the TSS limit is 350 mg/l. For discharge < 10,000 gpd, the limit is determined on a case by case basis

⁵ Analysis for Carbonaceous Biochemical Oxygen Demand (CBOD), Chloride, Total Solids, and Total Nitrogen are required if proposed discharge >= 10,000 gpd

FIGURES



FIGURE 1 – TOPOGRAPHIC CORRIDOR LOCATION MAP

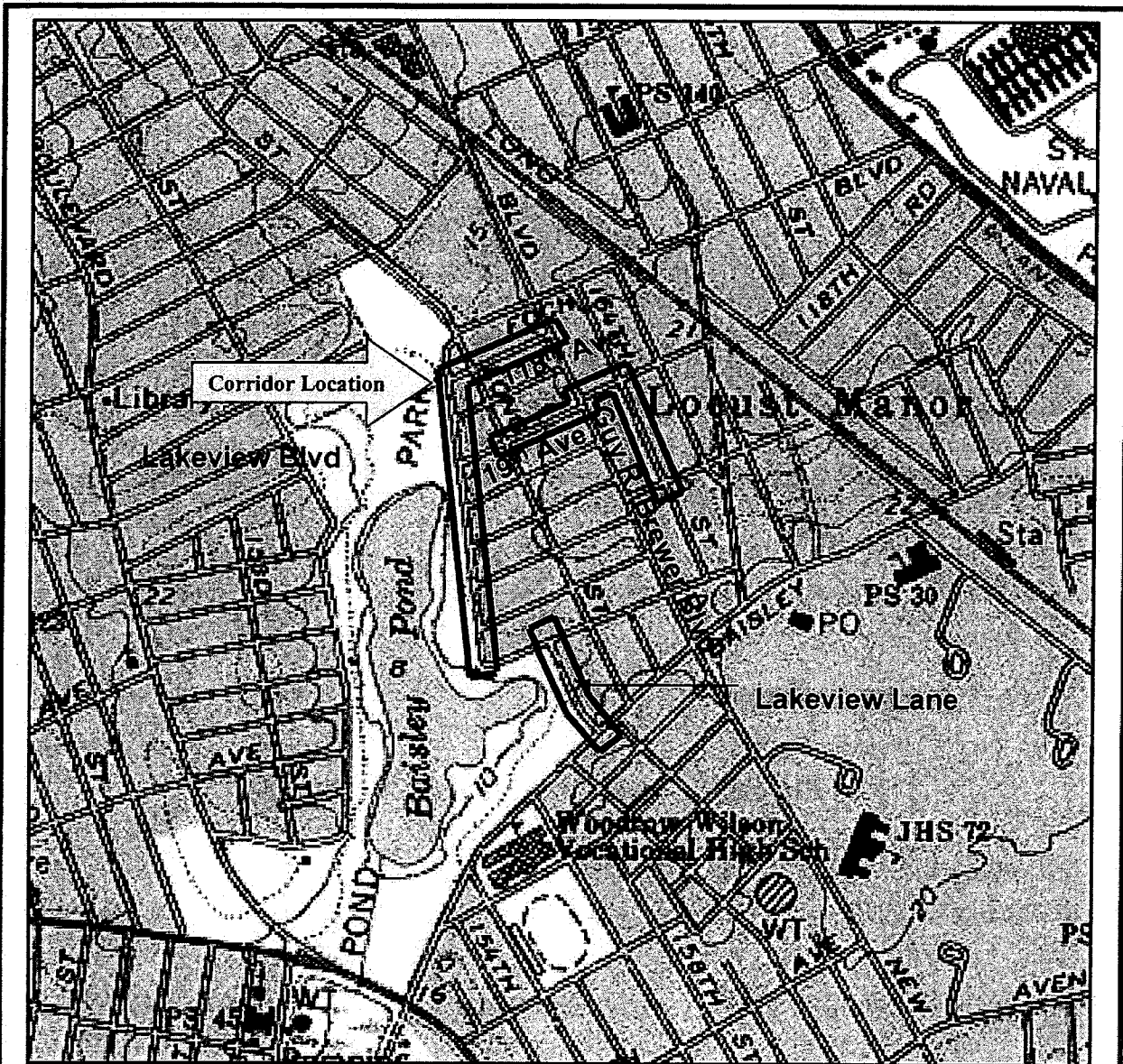

0 5 1 MILE
 0 1000 FEET 0 500 1000 METERS
 Printed from TOPO! ©2001 National Geographic Holdings (www.topo.com)

FIGURE 1 – TOPOGRAPHIC CORRIDOR LOCATION MAP

PROJECT NAME: Reconstruction of South Jamaica Area
BOROUGH, STATE: Queens, New York
ATC PROJECT NO. : 015.38500.0064
DDC REGISTRATION CONTRACT NO. : 20090016802
DDC PROJECT NO. : HWQ121B4
DDC WORK ORDER NO. : 6481-ATC-6258

USGS Topographic Map 7.5 Minute Series, Jamaica, NY 1994 Quadrangle



FIGURE 2 – SAMPLE LOCATION PLAN

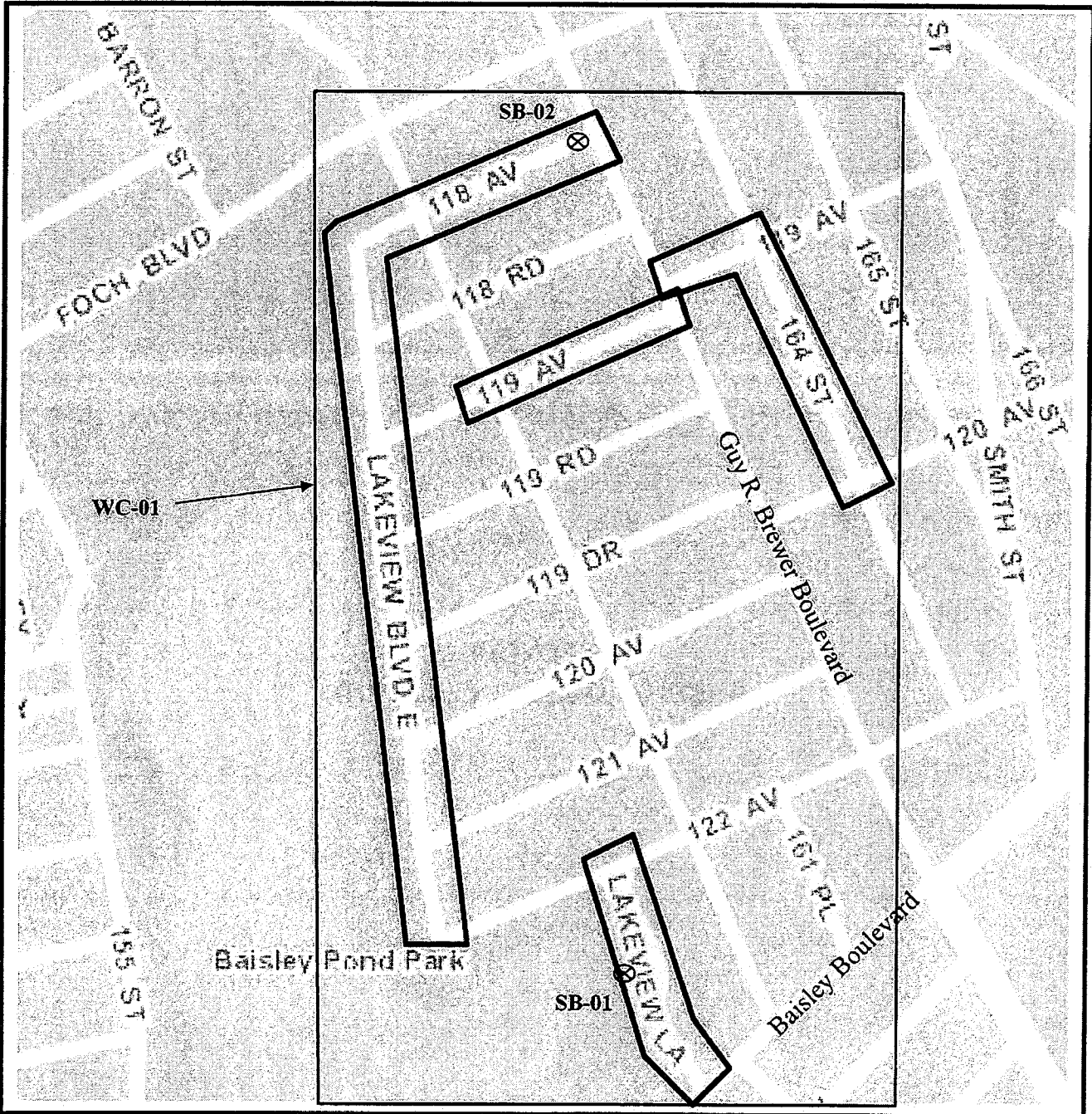



FIGURE 2 – SAMPLE LOCATION PLAN



LEGEND:

 Corridor

 "Moderate" risk boring

PROJECT NAME: Reconstruction of South Jamaica Area
BOROUGH, STATE: Queens, New York
ATC PROJECT NO. : 015.38500.0064
DDC REGISTRATION CONTRACT NO. : 20090016802
DDC PROJECT NO. : HWQ121B4
DDC WORK ORDER NO. : 6481-ATC-6258





APPENDIX A
BORING LOCATION SKETCHES

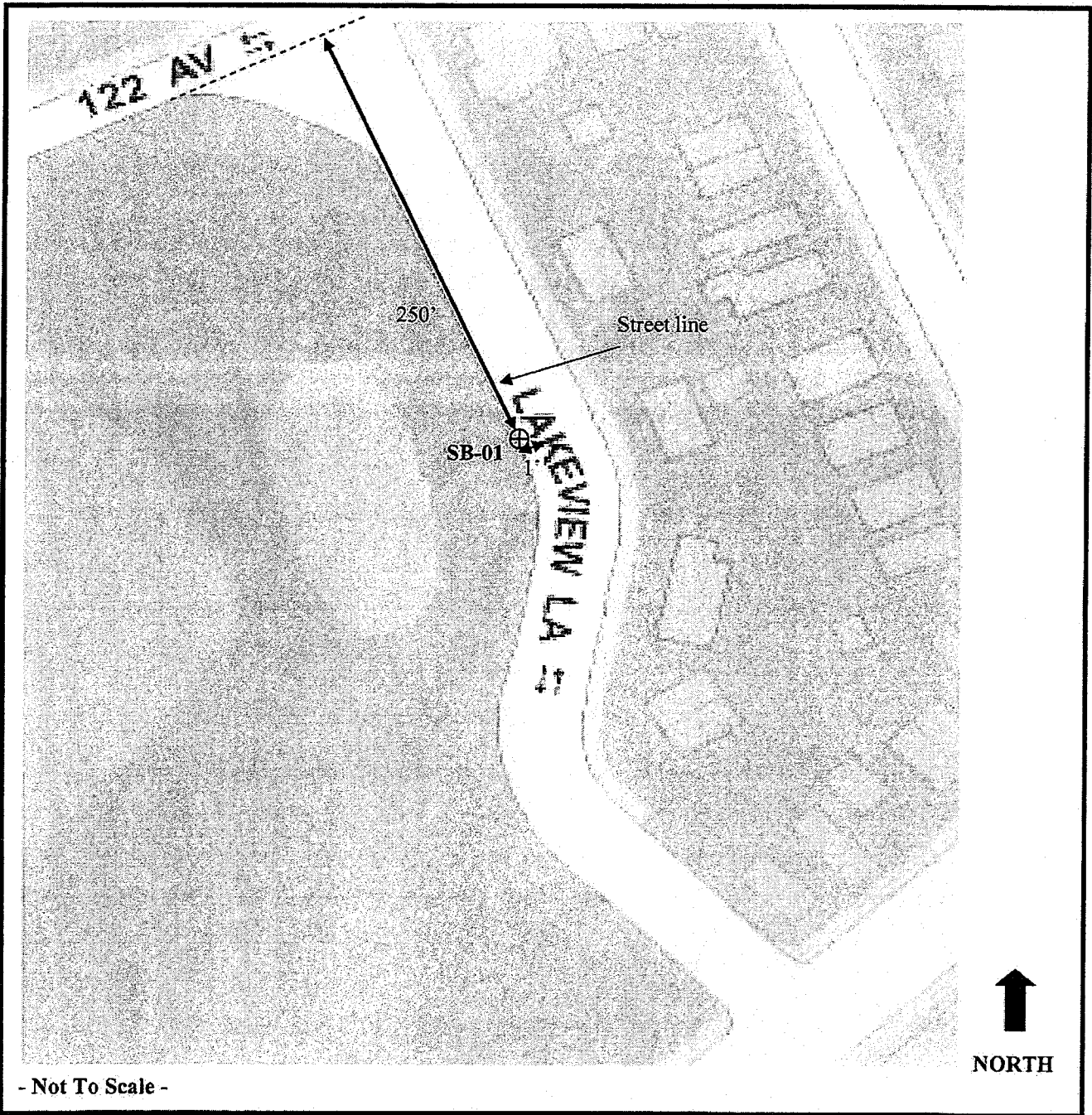

Appendix A - Boring Location Sketch



LEGEND:

- High Risk Soil Boring Location
- ⊕ Moderate Risk Soil Boring Location
- ▲ Moderate Risk Soil Boring Location and Temporary Well Point

PROJECT NAME: Reconstruction of South Jamaica Area
 BOROUGH, STATE: Queens, New York
 ATC PROJECT NO. : 015.38500.0064
 DDC REGISTRATION CONTRACT NO. : 20090016802
 DDC PROJECT NO. : HWQ121B4
 DDC WORK ORDER NO. : 6481-ATC-6273

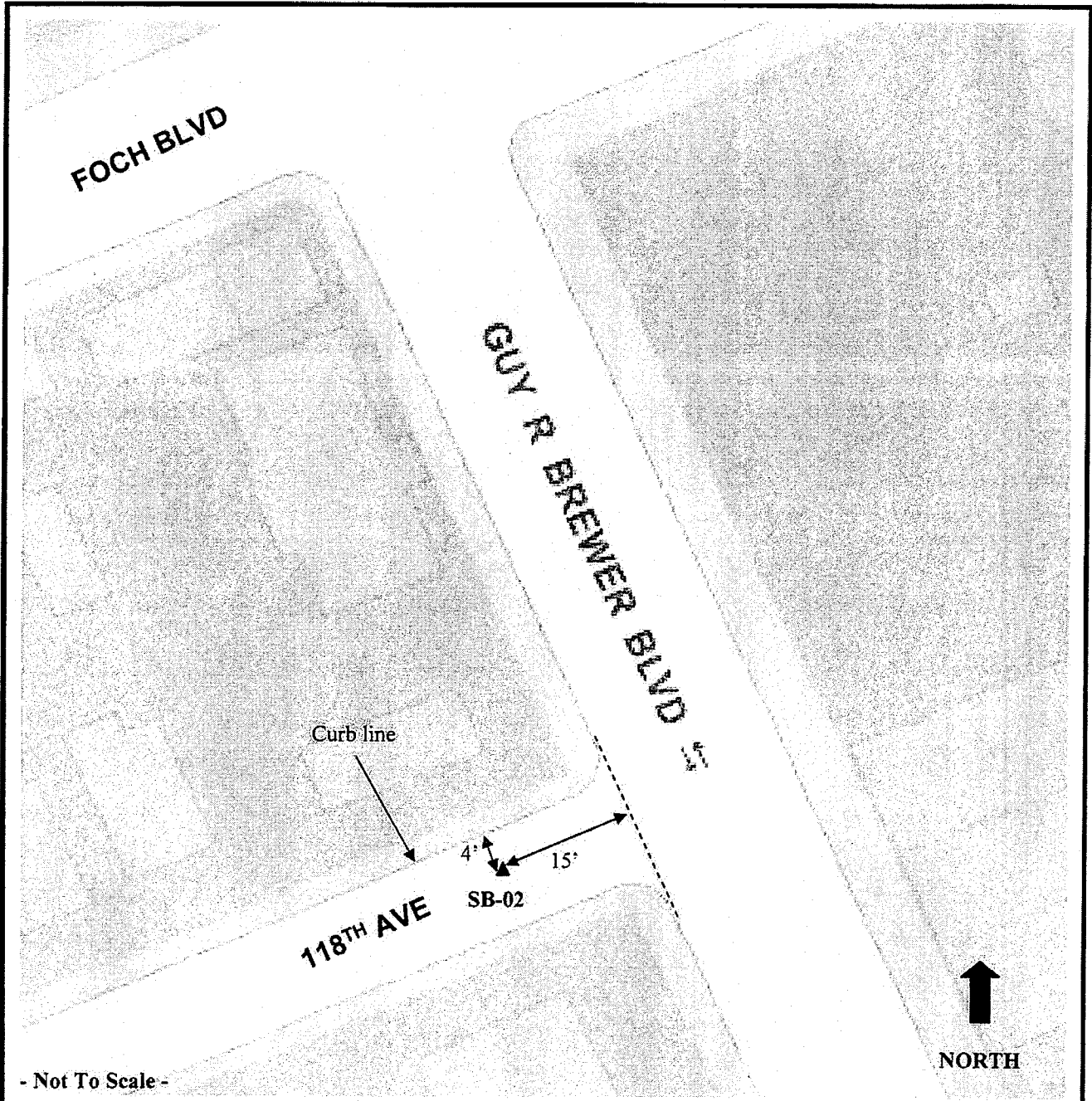

Appendix A - Boring Location Sketch



LEGEND:

- High Risk Soil Boring Location
- ⊕ Moderate Risk Soil Boring Location
- ▲ Moderate Risk Soil Boring Location and Temporary Well Point

PROJECT NAME: Reconstruction of South Jamaica Area
 BOROUGH, STATE: Queens, New York
 ATC PROJECT NO. : 015.38500.0064
 DDC REGISTRATION CONTRACT NO. : 20090016802
 DDC PROJECT NO. : HWQ121B4
 DDC WORK ORDER NO. : 6481-ATC-6273





APPENDIX B
GEOLOGIC BORING LOGS AND TEMPORARY WELL
CONSTRUCTION DETAILS

ATC Associates Inc. 104 East 25th Street New York, NY 10010 212-353-8280				<u>Client:</u> New York City Department of Design & Construction		<u>Boring No.:</u> SB-01	
				<u>DDC Project No.:</u> HWQ121B4		<u>Boring location:</u> On Lakeview Lane, 250 feet southeast of the 122nd Avenue southern curb line and 1 feet west of the Lakeview Lane western street line, in the dirt shoulder.	
<u>Driller:</u> Zebra				<u>ATC Project No.:</u> 015.38500.0064		<u>Project Location:</u> South Jamaica Area	
<u>Inspector:</u> John Mascioli				<u>Drilling Method:</u> Hand Auger / Geoprobe			
<u>Groundwater Observations:</u> 5 Feet				<u>Sampling Method:</u> Hand Auger / Macro Core			
Depth (ft.)	Well Construction	Sample Interval	Recovery (ft.)	PID Reading (ppm)	Field Identification of Soil and Observations		
0			5	0	0-5' - Cleared via hand auger 0-6.5' - Dark brown-black fine to medium Sand, little clay and peat organics. ▼ Groundwater encountered at 5 feet		
5							
			3	0	6.5-8' - Gray sandy Silt		
8							
			4	0	8-16' - Gray and brown fine to medium Sand and gravel		
12							
			4	0	16-20' - Reddish brown fine to medium Sand, trace gravel		
16							
			4	0	Boring completed at a depth of 20 feet bgs.		
20							
24							

ATC Associates Inc. 104 East 25th Street New York, NY 10010 212-353-8280				Client: New York City Department of Design & Construction	Boring No.: SB-02
				DDC Project No: HWQ121B4 ATC Project No: 015.38500.0064	Boring location: On 118th Avenue, 15 feet west of the Guy R. Brewer Boulevard western curb line and 4 feet south of the 118th Avenue northern curb line, in the street.
Driller: Zebra Inspector: John Mascioli				Project Location: South Jamaica Area	
Groundwater Observations: 8 Feet				Drilling Method: Hand Auger / Geoprobe Sampling Method: Hand Auger / Macro Core	Date: October 12, 2009
Depth (ft.)	Well Construction	Sample Interval	Recovery (ft.)	PID Reading (ppm)	Field Identification of Soil and Observations
0	[Hatched pattern]		5	0	0-5' - Cleared via hand auger 0-12" - Asphalt/Concrete
5					
8	[Hatched pattern]		3	0	
12	[Hatched pattern]		3	0	▼ Groundwater encountered at 8 feet <u>Temporary Well Construction Details</u> Total Depth: 15 feet Well Diameter: 1 inch Riser Interval: 5 feet Screen Interval: 10 feet Slot Size: #10 Depth to Groundwater: 8 feet Date Installed: October 12, 2009 Date Abandoned: October 12, 2009
16	[Hatched pattern]		4	0	
20			4	0	
24					Boring completed at a depth of 20 feet bgs.

Contractors/Consultants can obtain laboratory analytical results from New York City Department of Design and Construction Infrastructure Division, Program Administration – Engineering Support Services.

30-30 Thomson Avenue, 3rd Floor
Long Island City, NY 11101

END OF ADDENDUM NO. 5

This addendum consists of eighty-two (82) pages.

THE CITY OF NEW YORK
DEPARTMENT OF DESIGN AND CONSTRUCTION
INFRASTRUCTURE DIVISION
BUREAU OF DESIGN

PROJECT ID: HWQ121B4

RECONSTRUCTION OF LAKEVIEW BOULEVARD EAST AND VICINITY

INCLUDING SEWER, WATER MAIN, STREET LIGHTING,
AND TRAFFIC SIGNAL WORK

TOGETHER WITH ALL WORK INCIDENTAL THERETO

BOROUGH OF QUEENS
CITY OF NEW YORK

ADDENDUM NO.6

(SECTION U VERSION 2.0)

DATED: MARCH 30, 2015

1. The Contractor shall be responsible for compliance with all the provisions of the following Sections and Schedules, which are hereby made a part of the original contract documents:
 - A. "SECTION U: Additional Contract Requirements Applying to Work Performed in the Presence of Privately Owned Utility Facilities" (Pages A6-3 through A6-13)
 - B. Schedule U-1 (Page A6-14)
 - C. Schedules U-2 listing scope of utility interferences is no longer included in City contract. Such information will be part of Interference Agreement between Utility Operator and Contractor.
 - D. Section U-3 Page A6-15 (as per the Private Utilities reference document for SECTION U called "CET SPECIFICATIONS AND SKETCHES", dated November 2010).
2. Each facility operator shall provide inspectors at the work site to inspect methods of interference work, verify quantities and items of Utility Work, and coordinate all phases of the facility operator operations.
3. In addition, the following statements are made to provide clarification of various paragraphs under Section U:
 - A. Section U, ¶3, requires the Contractor to immediately commence negotiations with each Company for an Interference Agreement under which the Company will compensate the Contractor for any Interference Work which the Company does not elect to perform with its own forces or by specialty contractors retained by the Company. Thus the Contractor is on notice that its work under the Contract may be affected by

Interference Work performed by (a) the Contractor pursuant to a separate Interference Agreement with the Company, (b) the Company, or (c) partly by each.

- B. The City has no contract with any of the Companies for work on or adjacent to the site of work under this Contract, and the Companies are not "Other Contractors" as defined for the purposes of this Contract. The Contractor is reminded, however, that pursuant to Section U, ¶13, the City will not compensate the Contractor for any direct and/or indirect costs related to Interference Work, regardless of whether such Interference Work is covered by an Interference Agreement between the Contractor and the Company or is performed by the Company using its own forces or by specialty contractors retained by the Company.
- C. Section U, ¶13, provides that the provisions of Section U are material provisions of the Contract and that the Contractor's failure to comply with the procedures set forth in Section U are sufficient for the Commissioner to declare the Contractor in default pursuant to Article 48 of the Contract.

Pursuant to this Addendum, the Contractor is informed that the Performance Bond required of the Contractor pursuant to the Contract is not deemed to guarantee performance of any of the Interference Work.

Section U: Additional Contract Requirements Applicable to Work Performed in the Presence of Privately Owned Utility Facilities

The Contractor is hereby notified that pursuant to the law and franchise agreements issued by the City, certain private utility and public service companies named in Schedule U-1 ("the Companies") own and/or operate surface and/or subsurface facilities within the limits of this contract. The existence of these facilities impacts the productivity of the City work called for in the contract. In order to improve coordination of the City construction with the private utility facilities owned and/or operated by the Companies named in Schedule U-1, Article 1.06.30 of the Standard Highway Specifications of the New York City Department of Transportation, Dated November 1, 2010; and/or Articles 10.15 through 10.18 of the Standard Sewer and Water Main Specifications of the New York City Department of Environmental Protection, Dated July 1, 2014; as applicable, are amended and will be implemented as follows:

1. Means and methods for City work:

- a) The Contractor is hereby notified that the utility interferences may impact the performance of, and/or interferes with, City work. The contractor will be required to perform such utility work as directed by the Resident Engineer in order to clear all utility interferences from the project site as required for satisfactory completion of City work within specified contract schedule.
- b) In areas serviced by overhead electric system, the contractor understands and by bidding for this contract agrees that he/she will be required to perform the public work in the presence of energized electrical overhead lines and appurtenances located in areas adjacent and/or within the project area. As a consequence he/she will select means and method of construction appropriate to maintain the safety clearances required or as permitted by electric operators in order to avoid damaging the insulation or shielding of these lines and also to prevent knocking them down.

2. *Field inspection prior to construction:*

Prior to the start of any contract work in areas serviced by overhead electric lines, and after the award to the apparent low bidder for this contract, the contractor must request a field walk of the project area along with the operator of the overhead electrical facilities and the DDC Engineer-In-Charge. At that time the facility operator will confirm the type and condition of the overhead electrical lines and the sufficiency of their insulating properties with respect to the means and methods proposed by the contractor. The contractor must be prepared to describe in enough details his/her proposed means and methods of construction operations in order to anticipate the likelihood that electric lines insulation would be cut or otherwise compromised. Also such details will allow the facility operator to anticipate the need for added insulation and/or shielding of non-insulated lines.

3. *Compensation for interference work:*

Compensation for Interference Work is a matter of adjustment between the Contractor and each private utility company located within the limits of the project area and whose utility facilities are affected by City contract work. In particular, the City will not compensate the Contractor for any direct and/or indirect costs related to Interference Work, including, but not limited to, lost profit, increased overhead, or any other impact costs. Upon receipt of a Notice of Award from the City, the Contractor shall immediately commence negotiations with each of the Companies concerning the manner in which and the price for which the Contractor, through its own forces or by others hired by it, will perform and be paid by the Company for all necessary Interference Work as defined above, and at known locations of City contract work, that the Company(ies) choose(s) not to perform with its(their) own forces or by specialty Contractors hired by it (them) (as per "Interference Agreement"). (Specialty contractors' work is limited to (i) insulation installation and removal, (ii) live gas and steam work, (iii) cleanup and disposal of hazardous materials, (iv) splicing live electrical and telecommunications facilities, and (v) work not traditionally performed by general construction contractors.

4. *Interference Agreement:*

1. Although the parties may negotiate an Interference Agreement in any format or manner they deem fit, the Contractor is hereby advised that the Companies have indicated to the City that they will agree to compensate the Contractor on a unit price basis for

Types of Interferences encountered on this Contract in accordance to the Private Utilities reference document for SECTION U called "CET SPECIFICATIONS AND SKETCHES", dated November 2010, copy of which is available on demand.

2. The Contractor shall notify the City upon concluding an Interference Agreement with each of the Companies.

5. *City contract work to continue without Interference Agreement :*

If, prior to the start of construction, as directed by the City's Order to work / Notice To Proceed (OTW/ NTP) date any of the Companies and the Contractor have not concluded an Interference Agreement as described above, then the City shall issue a written "48 Hours notice to Public Corporation" as prescribed by the City of New York Administrative Code", commonly referred to as "Order-Outs" and City construction will proceed as ordered and the Contractor will be directed by the Resident Engineer to perform the City work on Time, Material and Equipment basis (T&M) as specified in standard City contract agreement Article 26.2. T&M records will include identification of types of utility facilities interfering with City work, utility facility owners, specifying the nature and quantity of any materials, plant and equipment furnished or used in connection with the performance of such work and crew size, such as: name and number of each worker employed on such work. T&M records will also indicate the hours of active time, standby time and idle time. The Company (ies) and the Contractor will maintain separate records of the actual quantity and cost of labor, materials, and equipment expended, and will provide copies of this information to the other party on a daily basis for reconciliation. These T&M records along with cost evaluations will be submitted daily to the Resident Engineer for review and approval. The total cost of City work will be based on quantity of work performed multiplied by unit price contract bid items. The total interference cost will be calculated as the difference between the total T&M cost and total cost for City work. The Resident Engineer will conduct a monthly reconciliation session of the daily T&M records with the affected Company (ies) and contractor. If the contractor and affected utility companies cannot reconcile their T&M records, by the last day of each month, then the Resident Engineer will submit the approved City's T&M records along with total cost evaluations to the DDC Director of Construction who will review these records and recommend approval and validity certification by the DDC Deputy Commissioner.

1. Copies of the DDC approved and certified T&M records will then be transmitted by the DDC to the contractor and the utility companies. These certified records may be used by the contractor for compensation claims against the responsible private facility owners, or may be used by any party as supporting documentation in dispute regarding compensation for performing Interference Work. The contractor will be required to perform City work while invoices are submitted by the contractor to the Utility companies for payment within 30 days, or while compensation disputes between contractor and affected company (ies) are submitted to Binding Arbitration process described in Paragraph 9.
2. All issues related to utility work and/ or delays due to compensation disputes or claims against utility companies are not allowable as justification for granting contract time extensions or delay claims against the City. The City may assess liquidated damages specified in the contract for net overall delays suffered by City contract work as a result of utility issues, disputes and claims.
3. The standard City contract dispute resolution process specified in Article 27 "Presentation of disputes to Commissioner", of the standard City contract agreement is not applicable to any disputes related to utility work and/ or compensation for such work or claim against utility companies. Utility work issues, disputes and claims may only be submitted to Binding Arbitration process described in Paragraph 9.
4. The contractor will notify the Resident Engineer when utility work that require the intervention of company utility specialty crews causes excessive contractor's labor and equipment standby or idleness and, thereby jeopardizing the City project schedule. The Resident Engineer will submit the facts to the DDC Director of construction who will recommend to the Deputy Commissioner regarding the issuance of a "48 hours notice" to the concerned utility company as authorized by the New York City administrative Code Section 19-143 and/ or Section 24-521 as applicable.
5. Utility delays caused by utility and/ or by unavailability of utility specialty crews cannot be discounted for earning any contractual bonus when such bonus clause is included in a contract. However, if such specified bonus is not earned or disallowed by the City or if the City assesses specified liquidated damages as a result of such excessive delays, the contractor may seek damages from the responsible utility company (ies).

6. *Extra utility work with Utility Agreement:*

If during construction the Contractor encounters utility facilities interferences or utility scope of work that it believes is not covered by the Interference Agreement as described above, then the Contractor shall immediately notify the Company in writing, with a copy to the City, describing the nature and location of the extra work in question. The Company then has five (5) business days to investigate the conditions and then:

1. Advise the Contractor and the City in writing that no interference with its facilities exists at the location in question, and hence that the Contractor may proceed with City work without providing for any impact from Company facilities;
2. Advise the Contractor and the City in writing that the Interference Agreement negotiated pursuant to Paragraph 4, provides for the scope of work encountered.
3. Advise the Contractor and the City in writing that it intends to perform the necessary utility Work with company forces or with its own contractor including, but not limited to, relocating its facility out of the way of the proposed City work. In this case, the Company shall provide a written schedule for the performance of the utility work it proposes to perform, which shall be subject to approval by the City based on its impact to the Contractor's currently approved progress schedule. Upon approval of the Company's schedule by the City, the Contractor shall provide access to the worksite to the Company and/or any contractors hired by it to perform this utility work. If necessary, the City may grant a contract time extension for delays caused by the performance of such utility work by the company.
4. Reasonably specify in writing the scope of work to be performed by the Contractor on behalf of the Company that is not covered under the Interference Agreement negotiated pursuant to Paragraph 5, including, but not limited to, relocating, supporting, and/or protecting the Company's facilities, and/or shifting the City facility if approved by the Resident Engineer, and/or otherwise changing its operations to work in the presence of the Company's facilities. Should the Company elect this option, it must adequately define and provide an initial price offer for the work required to be performed.

- (g) After lunch, Contractor and/or its representatives shall have two hours to ask Company questions about its claim and its presentation. Thereafter the arbitrator(s) shall have two hours to ask Company questions about its claim and its presentation.
- (h) Subject to the above time limitations, the arbitrator(s) may conduct the arbitration in such manner as the arbitrator(s) deems reasonable.
- (i) The arbitrator(s) shall then have one week to select in writing, as the arbitrator ('s) award, that party's Final Offer which appears to be more reasonable, based on the presentations at the arbitration hearings.
- (j) The arbitrator shall have no discretion to grant an award other than one of the two Final Offers submitted by the parties.
- (k) Any award for work that has already been performed shall be paid on the 7th day after receipt of the arbitrator's decision, or on the 30th day after completion of the work, whichever is later. Payment for work not yet completed at the time of the arbitrator's decision shall be paid within 30 days of completion of work. Interest shall accrue from the date payment is due at the rate of 9% per annum. Either party may cause judgment to be entered in accordance with the arbitrator(s) decision in a court in the State of New York, County of New York.
- (l) The arbitrator's fees and any other costs of the arbitration shall be initially shared equally by Company and Contractor. The non-prevailing party shall then pay all arbitrator's fees and costs of the arbitration and shall reimburse the prevailing party for its share of such fees and costs theretofore paid.
- (m) The parties may, at any time, settle any matter submitted to arbitration.

10. Order-out waiver:

The Contractor and all subcontractors hired by it, if an Interference Agreement is executed as specified between the concerned parties, agree to waive any rights they may have, if any, under law, contract or otherwise to compel the City to assert any right the City may have, including the issuance of any directives required under the New York City Administrative Code, Section 19-143 and Section 24-521, to require any or all of the Companies to maintain, repair, replace, protect, support, shift, alter, relocate, and/or remove utility facilities in connection with the work to be performed under this contract. However, nothing in this section shall preclude the City from exercising its rights under the Law to issue such a directive to the Company.

11. Cost of insurance:

Each of the named Companies, at their option and if an Interference Agreement is executed as specified between the concerned parties, may be named as an additional insured on all insurance policies required to be maintained under this contract. In the event that a Company opts to be so named as an additional insured, the actual incremental cost, if any, to the Contractor of providing such insurance coverage shall be borne by that Company. The Contractor shall provide a written statement from its insurance provider documenting the actual cost of this added coverage to the Company. Under no circumstances shall the cost of insurance coverage on behalf of any Company be borne by the City. Nothing in this paragraph shall be interpreted to imply the City's acceptance of any additional responsibility or liability for any matter related to the performance of Utility Work. In particular, the Company and the Contractor bear joint and full responsibility to ensure that any Utility Work performed by the Contractor is in compliance with all applicable government and Company regulations.

12. Cost of utility interference work:

The Companies, by virtue of a prior agreement with the City, have agreed to perform their obligations described in this section. It is expressly understood that the cost of Utility Work or any delays cost cause by such utility work shall not be a charge against the City, but shall be a matter for adjustment between the Contractor and the Company or Companies concerned. The City and the Contractor agree that the Companies are third party beneficiaries of this section of the contract, if a Utility Agreement is executed between the contractor and utility company (ies). The provisions of this section shall govern in all cases where Company property interferes with or is about to be disturbed by the City work, notwithstanding any other provision of the Contract, except for Natural Gas transmission/distribution facilities covered subject to the Gas Facility Cost Allocation Act (GFCAA) and covered separately in this contract.

13. Default declaration:

The Contractor agrees that the provisions of this section are material provisions of the contract, and that the Contractor's failure to comply with the procedures set forth above are sufficient for the Commissioner to declare the Contractor in default pursuant to Article 48 of the Contract.

14. NYS Labor Law:

The Contractor is hereby advised that New York State Labor Law applies to public work. The work described in this Section U of the contract performed by utility company (ies) with their own forces or vendors hired by such company (ies) is not public work.

15. Facility operators:

The insurance requirements in Paragraph 11 of this Section U apply to: (i) additional Companies, if any, who were not named in Schedule "A" but which have executed a Utility Agreement with the contractor for utility work; and (ii) additional coverage, if any, paid for by Utility Companies whose utility facilities are located within the project limits, that they may require for the utility work pursuant to an utility agreement between the contractor and such utility companies.

[End]

"STANDARD UTILITY LETTER OF AGREEMENT"

(Name)
Deputy Commissioner, Infrastructure Division
Department of Design and Construction
30-30 Thomson Avenue
Long Island City, NY 11101

RE: City Work Performed in the Presence of Private Utility Facilities
Project No: _____

Dear (Name):

This letter is to certify that _____, has requested the inclusion of the attached "Section U: Additional contract requirements applying to work performed in the presence of privately owned utility." The company agrees to abide by the terms of this Section U at the company's own expenses due to their facilities interferences with the Public work.

Sincerely,

By: Authorized Company Representative

Title

NOTARY PUBLIC

CERTIFIED AS TO FORM
AND LEGAL AUTHORITY:

By: _____

SCHEDULE U-1

HWQ121B4

RECONSTRUCTION OF LAKEVIEW BOULEVARD EAST AND VICINITY

SCHEDULE U-1

LISTING OF COMPANIES NAMED FOR THIS CONTRACT

<u>COMPANY NAME</u>	<u>CONTACT NAME</u>	<u>CONTACT TELEPHONE</u>
CON EDISON	THERESA KONG	212-460-4834
VERIZON	AUBREY MAKHANLALL	718-977-8165
TIME WARNER	JOHN PIAZZA	718-888-4261

SECTION U-3

(NO TEXT IN THIS SECTION)

END OF ADDENDUM No.6
This Addendum consists of Sixteen (16) pages

ATTACH TO CONTRACT DOCUMENTS

THE CITY OF NEW YORK
DEPARTMENT OF DESIGN AND CONSTRUCTION
INFRASTRUCTURE DIVISION
BUREAU OF DESIGN

PROJECT ID:HWQ121B4

RECONSTRUCTION OF LAKEVIEW BOULEVARD EAST

LAKEVIEW LANE - FROM BAISLEY BOULEVARD TO 122ND AVENUE
122ND AVENUE - FROM LAKEVIEW LANE TO LAKEVIEW BOULEVARD EAST
LAKEVIEW BOULEVARD EAST - FROM 122ND AVENUE TO 118TH AVENUE
118TH AVENUE - FROM LAKEVIEW BOULEVARD EAST TO LONG STREET

NEW STORM AND SANITARY SEWERS (SEQ200436) IN:

LAKEVIEW LANE - FROM BAISLEY BOULEVARD TO 122ND AVENUE
122ND AVENUE - FROM LAKEVIEW LANE TO LAKEVIEW BOULEVARD EAST
LAKEVIEW BOULEVARD EAST - FROM 122ND AVENUE TO 118TH AVENUE
119TH AVENUE - FROM LONG STREET TO 164TH STREET
164TH STREET - FROM 119TH AVENUE TO 120TH AVENUE

CAPITAL PROJECT WM-1
WATER MAIN WORK IN:

LAKEVIEW LANE - FROM BAISLEY BOULEVARD TO 122ND AVENUE
122ND AVENUE - FROM LAKEVIEW LANE TO LAKEVIEW BOULEVARD EAST
LAKEVIEW BOULEVARD EAST - FROM 122ND AVENUE TO 118TH AVENUE
118TH AVENUE - FROM LAKEVIEW BOULEVARD EAST TO LONG STREET
119TH AVENUE - FROM LONG STREET TO 164TH STREET
164TH STREET - FROM 119TH AVENUE TO 120TH AVENUE

INCLUDING STREET LIGHTING AND TRAFFIC WORK

Together With All Work Incidental Thereto

BOROUGH OF QUEENS
CITY OF NEW YORK

ADDENDUM NO. 7

DATED: June 11, 2015

THIS ADDENDUM IS HEREBY MADE A PART OF THE CONTRACT DOCUMENTS

1. Refer to the Bid and Contract Documents, Volume 1 of 3, page 3;
Delete page 3, in its entirety;
Substitute the attached revised page 3 (R).
2. Refer to the Bid and Contract Documents, Volume 3 of 3, Addendum
No. 1, page A1-9, Subsection 6.74B.2, line number 5;
Change the color of the paint from "green" to "black".
3. Refer to the Bid and Contract Documents, Volume 3 of 3, Addendum
No. 1, Page A1-12;
Insert new SECTION 8.12 TW, TREE WELLS, as contained on the
attached pages A1-12a and A1-12b.

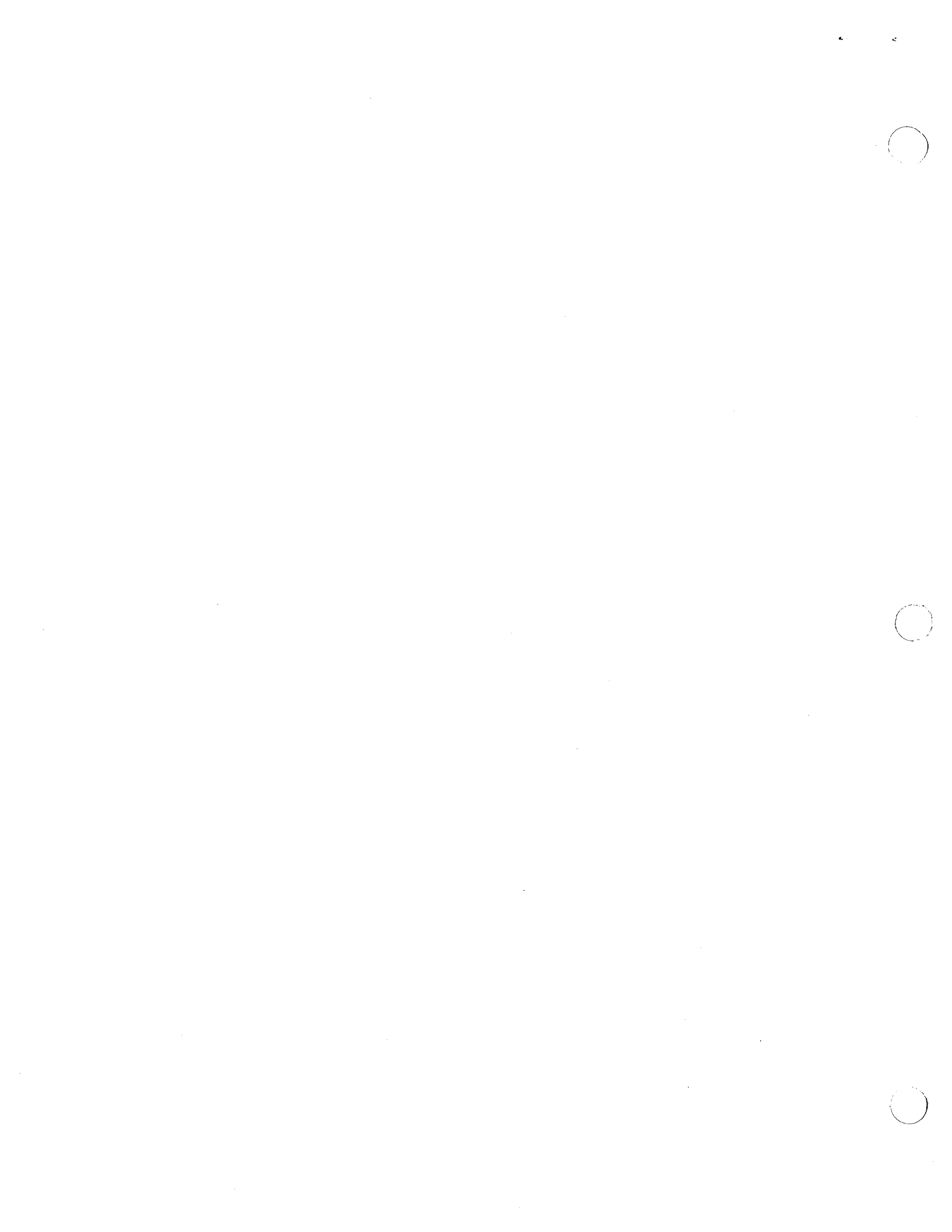

PROJECT ID:HWQ121E4

4. Refer to the Bid and Contract Documents, Volume 3 of 3, Addendum No. 2, pages A2-6, A2-7 and A2-8;
Delete pages A2-6, A2-7 and A2-8, in their entirety;
Substitute the attached revised pages A2-6(R), A2-7(R) and A2-8(R).
5. Refer to the Bid and Contract Documents, Volume 3 of 3, Addendum No. 4, page A4-236;
Insert, following Page A4-236, the attached cover sheet for **ADDENDUM NO. 5.**
6. Refer to the Contract Drawings, CLEARING/EROSION AND SEDIMENT CONTROL PLAN FOR NEW OUTFALL on SHEET 31 OF 75 (BMP2/10), Note 3, lines 1 and 2;
Delete the words "AND PORTABLE SEDIMENT TANK" in lines 1 and 2.
7. Refer to the Contract Drawings, CLEARING/EROSION AND SEDIMENT CONTROL PLAN FOR MITIGATION AREA on SHEET 32 OF 75 (BMP3/10), Note 1, lines 1 and 2;
Delete the words "AND PORTABLE SEDIMENT TANK" in lines 1 and 2.
8. Refer to the Contract Drawings, TREE IMPACT MITIGATION TECHNIQUES (3 OF 5) on SHEET 52 OF 75 (TM9/TM11);
Delete the box containing ② CASE NO. 11 - TREE 612 LVL 04+49 - QUERCUS PALUSTRIS 6.5" DBH SECTION, located at the lower right corner of the drawing, in its entirety;
Substitute the attached revised Sketch #1.
9. Refer to the Contract Drawings, TREE IMPACT MITIGATION TECHNIQUES on SHEET 52 OF 75 (TM9/TM11), SHEET 53 OF 75 (TM10/TM11) and SHEET 54 OF 75 (TM11/TM11), Note No. 3 on each sheet;
Add the following sentence to Note No. 3: "DRYWALL SHALL BE CONSTRUCTED IN ACCORDANCE WITH THE REQUIREMENTS OF SECTION 8.12 TW, IN ADDENDUM NO. 1."
10. See attached Page 1 of 1 for list of QUESTIONS SUBMITTED BY BIDDERS AND RESPONSES PROVIDED BY DDC for additional information.

END OF ADDENDUM NO. 7

By signing in the space provided below, the bidder acknowledges receipt of this Addendum consisting of two (2) pages and nine (9) pages of attachments.

THIS ADDENDUM MUST BE SIGNED BY ALL BIDDERS AND ATTACHED TO THEIR BID

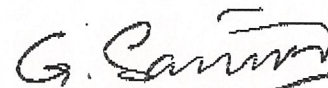

GURDIP SAINI, P.E.
Associate Commissioner/Design I

P+T II Contracting Corp
Name of Bidder

By: 







**Department of
Design and
Construction**

**INFRASTRUCTURE DIVISION
BUREAU OF DESIGN**

VOLUME 3 OF 3

PROJECT ID:HWQ121B4

RECONSTRUCTION OF LAKEVIEW BOULEVARD EAST

LAKEVIEW LANE - FROM BAISLEY BOULEVARD TO 122ND AVENUE
122ND AVENUE - FROM LAKEVIEW LANE TO LAKEVIEW BOULEVARD EAST
LAKEVIEW BOULEVARD EAST - FROM 122ND AVENUE TO 118TH AVENUE
118TH AVENUE - FROM LAKEVIEW BOULEVARD EAST TO LONG STREET

NEW STORM AND SANITARY SEWERS (SEQ200436) IN:

LAKEVIEW LANE - FROM BAISLEY BOULEVARD TO 122ND AVENUE
122ND AVENUE - FROM LAKEVIEW LANE TO LAKEVIEW BOULEVARD EAST
LAKEVIEW BOULEVARD EAST - FROM 122ND AVENUE TO 118TH AVENUE
119TH AVENUE - FROM LONG STREET TO 164TH STREET
164TH STREET - FROM 119TH AVENUE TO 120TH AVENUE

CAPITAL PROJECT WM-1

WATER MAIN WORK IN:

LAKEVIEW LANE - FROM BAISLEY BOULEVARD TO 122ND AVENUE
122ND AVENUE - FROM LAKEVIEW LANE TO LAKEVIEW BOULEVARD EAST
LAKEVIEW BOULEVARD EAST - FROM 122ND AVENUE TO 118TH AVENUE
118TH AVENUE - FROM LAKEVIEW BOULEVARD EAST TO LONG STREET
119TH AVENUE - FROM LONG STREET TO 164TH STREET
164TH STREET - FROM 119TH AVENUE TO 120TH AVENUE

INCLUDING STREET LIGHTING AND TRAFFIC WORK

Together With All Work Incidental Thereto

**BOROUGH OF QUEENS
CITY OF NEW YORK**

Contractor.

Dated _____, 20____