



**THE CITY OF NEW YORK
DEPARTMENT OF DESIGN AND CONSTRUCTION
DIVISION OF INFRASTRUCTURE**

30-30 THOMSON AVENUE
LONG ISLAND CITY, NEW YORK 11101-3045
TELEPHONE (718) 391-1000
WEBSITE www.nyc.gov/buildnyc

LAW

VOLUME 1 OF 3

BID BOOKLET

FOR FURNISHING ALL LABOR AND MATERIALS NECESSARY AND REQUIRED FOR:

PROJECT ID: HWPEDSF1

**MULTI-SITE PEDESTRIAN SAFETY
WHICH INCLUDES THE FOLLOWING INTERSECTIONS:**

**31ST STREET AND 39TH AVENUE
31ST STREET AND 36TH AVENUE
31ST STREET AND BROADWAY**

**INCLUDING BUS BULBOUTS, CURB EXTENSIONS, BUS PADS,
PEDESTRIAN RAMPS, CATCH BASINS, PAVEMENT MARKINGS,
STREET LIGHTING, AND TRAFFIC SIGNAL WORK**

**Together With All Work Incidental Thereto
BOROUGH OF QUEENS
CITY OF NEW YORK**

FOR THE DEPARTMENT OF TRANSPORTATION
PREPARED BY
THE RBA GROUP

OCTOBER 22, 2014

NYS DOT PIN X772.58
Fed. Aid Project No. _____

Bid Opening 11:00 A.M. on
Location 1st Floor Bid Room, 30-30 Thomson Ave., Long Island City, N.Y. 11101



15-07

Bid Tab

Description **MULTI-SITE PEDESTRIAN SAFETY WHICH INCLUDES THE FOLLOWING INTERSECTIONS: 31ST STREET AND 39TH AVENUE, ETC. - BOROUGH OF QUEENS**

Bid Date **2/6/2015** **FMS ID** **HWPEDSF1**

Estimated Cost **\$2,198,916.00** **Client Agency** **DOT**

Bid Security **Not less than 2% of Total Bid Price** **PLA** **No**

Time Allowed **365 CCD** **Contract Manager** **Giovanni Matos**

Addendum **7** **Project Manager** **Rawal, Aniruddh**

PIN **8502013HW0079C** **E-PIN** **85015B0051**

Selective Bidding Yes No **Consultant** **The RBA Group**

Bid Rank	Vendor	Bid Amount	Security Type
1	J. PIZZIRUSSO LANDSCAPING CORP.	\$2,130,068.30	Bond
2	PERFETTO CONTRACTING CO. INC.	\$2,546,671.50	Bond
3	C.A.C. INDUSTRIES, INC.	\$2,819,906.19	Bond
4	POWER CONCRETE CO., INC.	\$2,844,929.65	Bond
5	NORTHBROOK CONTRACTING CORP.	\$3,688,970.00	Bond

Recorder: Emmanuel Charles ext. 2200

Approver:

Donna Holley



January 12, 2016

CERTIFIED MAIL - RETURN RECEIPT REQUEST

J. PIZZIRUSSO LANDSCAPING CORP.
7104 AVENUE W
BROOKLYN, NY 11234

RE: FMS ID: HWPEDSF1
E-PIN: 85015B0051001
DDC PIN: 8502013HW0079C
MULTI-SITE PEDESTRIAN SAFETY
WHICH INCLUDES THE FOLLOWING
INTERSECTIONS: 31ST STREET AND
39TH AVENUE, ETC... - BOROUGH OF
QUEENS
NOTICE OF AWARD

Dear Contractor:

You are hereby awarded the above referenced contract based upon your bid in the amount of \$2,130,068.30 submitted at the bid opening on February 06, 2015. Within ten (10) days of your receipt of this notice of award, you are required to take the actions set forth in Paragraphs (1) through (3) below. For your convenience, attached please find a copy of Schedule A of the General Conditions to the Contract, which sets forth the types and amounts of insurance coverage required for this contract.

- (1) Execute four copies of the Agreement in the Contracts Unit, 30-30 Thomson Avenue, 1st Floor, Long Island City, New York (IDCNY Building). A Commissioner of Deeds will be available to witness and notarize your signature. The Agreement must be signed by an officer of the corporation or a partner of the firm.
- (2) Submit to the Contracts Unit four properly executed performance and payment bonds. If required for this contract, copies of performance and payment bonds are attached.
- (3) Submit to the Contracts Unit the following insurance documentation: (a) original certificate of insurance for general liability in the amount required by Schedule A, and (b) original certificates of insurance or other proof of coverage for workers' compensation and disability benefits, as required by New York State Law. The insurance documentation specified in this paragraph is required for registration of the contract with the Comptroller's Office.



On or before the contract commencement date, you are required to submit all other certificates of insurance and/or policies in the types and amounts required by Schedule A. Such certificates of Insurance and/or policies must be submitted to the Agency Chief Contracting Office, Attention: Risk Manager, Fourth Floor at the above indicated department address.

Your attention is directed to the section of the Information for Bidders entitled "Failure to Execute Contract". As indicated in this section, in the event you fail to execute the contract and furnish the required bonds within the (10) days of your receipt of this notice of award, your bid security will be retained by the City and you will be liable for the difference between your bid price and the price for which the contract is subsequently awarded, less the amount of the bid security retained.

Sincerely,

A handwritten signature in black ink, which appears to read "John Goddard for". The signature is written in a cursive, flowing style. Below the signature, the name "John Goddard" is printed in a standard black font.

John Goddard

1

BID FORM
THE CITY OF NEW YORK
DEPARTMENT OF DESIGN AND CONSTRUCTION
DIVISION OF INFRASTRUCTURE

BID FOR FURNISHING ALL LABOR AND
MATERIAL NECESSARY AND REQUIRED FOR:

PROJECT ID: HWPEDSF1

MULTI-SITE PEDESTRIAN SAFETY
WHICH INCLUDES THE FOLLOWING INTERSECTIONS:

31ST STREET AND 39TH AVENUE
31ST STREET AND 36TH AVENUE
31ST STREET AND BROADWAY

INCLUDING BUS BULBOUTS, CURB EXTENSIONS, BUS PADS,
PEDESTRIAN RAMPS, CATCH BASINS, PAVEMENT MARKINS,
STREET LIGHTING, AND TRAFFIC SIGNAL WORK

Together With All Work Incidental Thereto
BOROUGH OF QUEENS
CITY OF NEW YORK

Name of Bidder: J. Pizzirusso Landscaping Corp.

Date of Bid Opening: 2/6/15

Bidder is: (Check one, whichever applies) Individual () Partnership () Corporation ()

Place of Business of Bidder: 7104 Ave W Brooklyn NY 11234

Bidder's Telephone Number: 718-531-6084 Fax Number: 718-531-6677

Bidder's E-Mail Address: JPL Corp @ AOL.com

Residence of Bidder (If Individual): _____

If Bidder is a Partnership, fill in the following blanks:

Names of Partners	Residence of Partners
<u>John Pizzirusso</u>	_____
<u>Joseph Pizzirusso</u>	_____
_____	_____

If Bidder is a Corporation, fill in the following blanks:

Organized under the laws of the State of New York

Name and Home Address of President: John Pizzirusso
2848 Lindenmere Dr. Merrick NY 11710

Name and Home Address of Secretary: Joseph Pizzirusso
3009 Judith Pa Bellmore NY 11710

Name and Home Address of Treasurer: _____

BID FORM

The above-named Bidder affirms and declares:

1. The said bidder is of lawful age and the only one interested in this bid; and no person, firm or corporation other than hereinbefore named has any interest in this bid, or in the Contract proposed to be taken.
2. By submission of this bid, each bidder and each person signing on behalf of any bidder certifies, and in the case of a joint bid each party thereto certifies as to its own organization, under penalty of perjury, that to the best of its knowledge and belief: (1) the prices in this bid have been arrived at independently without collusion, consultation, communication or agreement, for the purpose of restricting competition, as to any matter relating to such prices with any other bidder or with any competitor; (2) unless otherwise required by law, the prices quoted in this bid have not been knowingly disclosed by the bidder and will not knowingly be disclosed by the bidder prior to opening, directly or indirectly, to any other bidder or to any competitor; and (3) No attempt has been made or will be made by the bidder to induce any other person, partnership or corporation to submit or not to submit a bid for the purpose of restricting competition.
3. No councilman or other officer or employee or person whose salary is payable in whole or in part from the City Treasury is directly or indirectly interested in this bid, or in the supplies, materials, equipment, work or labor to which it relates, or in any of the profits thereof.
4. The bidder is not in arrears to the City of New York upon debt or contract or taxes, and is not a defaulter, as surety or otherwise, upon any obligation of the City of New York, and has not been declared not responsible, or disqualified, by any agency of the City of New York or State of New York, nor is there any proceeding pending relating to the responsibility or qualification of the bidder to receive public contracts except as set forth on the Affirmation included as page C-6 of this Bid Booklet.

The bidder hereby affirms that it has paid all applicable City income, excise and other taxes for all years it has conducted business activities in New York City.

5. The bidder, as an individual, or as a member, partner, director or officer of the bidder, if the same be a firm, partnership or corporation, executes this document expressly warranting and representing that should this bid be accepted by the City and the Contract awarded to him, he and his subcontractors engaged in the performance: (1) will comply with the provisions of Section 6-108 of the Administrative Code of the City of New York and the non-discrimination provisions of Section 220a of the New York State Labor Law, as more expressly and in detail set forth in the Agreement; (2) will comply with Section 6-109 of the Administrative Code of the City of New York in relation to minimum wages and other stipulations as more expressly and in detail set forth in the Agreement; (3) have complied with the provisions of the aforesaid laws since their respective effective dates, and (4) will post notices to be furnished by the City, setting forth the requirements of the aforesaid laws in prominent and conspicuous places in each and every plant, factory, building and structure where employees engaged in the performance of the Contract can readily view it, and will continue to keep such notices posted until the supplies, materials and equipment, or work labor and services required to be furnished or rendered by the Contractor have been finally accepted by the City. In the event of any breach or violation of the foregoing, the Contractor may be subject to damages, liquidated or otherwise, cancellation of the Contract and suspension as a bidder for a period of three years. (The words, "the bidder", "he", "his", and "him" where used herein shall mean the individual bidder, firm, partnership or corporation executing this bid).

6. Compliance Report

The bidder, as an individual, or as a member, partner, director, or officer of the bidder, if the same be a firm, partnership, or corporation, (1) represents that his attention has been specifically drawn to Executive Order No. 50, dated, April 25, 1980, on Equal Employment Compliance of the contract, and (2) warrants that he will comply with the provisions of Executive Order No. 50. The Employment Report must be submitted as part of the bid.

The bidder, as an individual, or as a member, partner, director, or officer of the bidder, if the same be a firm, partnership, or corporation, executes this document expressly warranting that he will comply with: (1) the provision of the contract on providing records, Chapter 8.

7. By submission of this bid, the bidder certifies that it now has and will continue to have the financial capability to fully perform the work required for this contract. Any award of this contract will be made in reliance upon such certification. Upon request therefor, the bidder will submit written verification of such financial capability in a form that is acceptable to the department.

8. In accordance with Section 165 of the State Finance Law, the bidder agrees that tropical hardwoods, as defined in Section 165 of the State Finance Law, shall not be utilized in the performance of this Contract, except as the same are permitted by the foregoing provision of law.

9. The bidder has visited and examined the site of the work and has carefully examined the Contract in the form approved by the Corporation Counsel, and will execute the Contract and perform all its items, covenants and conditions, and will provide, furnish and deliver all the work, materials, supplies, tools and appliances for all labor and materials necessary or required for the hereinafter named work, all in strict conformity with the Contract, for the prices set forth in the Bid Schedule:

(NO TEXT ON THIS PAGE)

BID FORM

LEAD PROJECT ID. HWPEDSF1

TOTAL BID PRICE: In the space provided below, the Bidder shall indicate its Total Bid Price in figures. Such Total Bid Price is set forth on the final page of the Bid Schedule.

TOTAL BID PRICE:
(a/k/a BID PROPOSAL)

\$ 2,130,068.³⁰

E. c 2/6/15

BIDDER'S SIGNATURE AND AFFIDAVIT

Bidder: J. Pizzirusso Landscaping Corp.

By: [Signature] Vice President
(Signature of Partner or corporate officer)

[Signature] Joseph Pizzirusso

Attest: _____ Secretary of Corporate Bidder
(Corporate Seal)

Affidavit on the following page should be subscribed
and sworn to before a Notary Public

Claire M Conteduca
Notary Public State of New York
Kings County
No. 01C06201485
Commission Expires March 2, '17

[Signature]

BID FORM (TO BE NOTARIZED)

AFFIDAVIT WHERE BIDDER IS AN INDIVIDUAL

STATE OF NEW YORK, COUNTY OF _____ ss:

_____ being duly sworn says:

I am the person described in and who executed the foregoing bid, and the several matters therein stated are in all respects true.

(Signature of the person who signed the Bid)

Subscribed and sworn to before me this
_____ day of _____, _____

Notary Public

AFFIDAVIT WHERE BIDDER IS A PARTNERSHIP

STATE OF NEW YORK, COUNTY OF _____ ss:

_____ being duly sworn says:

I am a member of _____ the firm described in and which executed the foregoing bid. I subscribed the name of the firm thereto on behalf of the firm, and the several matters therein stated are in all respects true.

(Signature of Partner who signed the Bid)

Subscribed and sworn to before me this
_____ day of _____, _____

Notary Public

AFFIDAVIT WHERE BIDDER IS A CORPORATION

STATE OF NEW YORK, COUNTY OF Kings ss:

_____ being duly sworn says:

I am the Vice President of the above named corporation whose name is subscribed to and which executed the foregoing bid. I reside at 3007 Judith Drive Bellmore NY 11710
I have knowledge of the several matters therein stated, and they are in all respects true.

(Signature of Corporate Officer who signed the Bid)

Subscribed and sworn to before me this
5 day of Feb, 2015

Alvin M. Conte
Notary Public

AFFIRMATION

PROJECT ID. HWPEDSF1

The undersigned bidder affirms and declares that said bidder is not in arrears to the City of New York upon debt, contract or taxes and is not a defaulter, as surety or otherwise, upon obligation to the City of New York, and has not been declared not responsible, or disqualified, by any agency of the City of New York, nor is there any proceeding pending relating to the responsibility or qualification of the bidder to receive public contracts except: DPR has entered and Advise of Contract for
Failure To meet MBE Goals on Contract CW46-407M.
(If none, the bidder shall insert the word "None" in the space provided above.)

Full Name of Bidder: J. Piccirosso Landscaping Corp.
Address: 7104 Ave W
City Brooklyn State New York Zip Code 11710

CHECK ONE BOX AND INCLUDE APPROPRIATE NUMBER:

A - Individual or Sole Proprietorship*
SOCIAL SECURITY NUMBER

B - Partnership, Joint Venture or other unincorporated organization
EMPLOYER IDENTIFICATION NUMBER

C - Corporation
EMPLOYER IDENTIFICATION NUMBER

113539578

By: [Signature]
Signature

Title: Vice President

If a corporation, place seal here

This affirmation must be signed by an officer or duly authorized representative.

*Under the Federal Privacy Act the furnishing of Social Security Numbers by bidders on City contracts is voluntary. Failure to provide a Social Security Number will not result in a bidder's disqualification. Social Security Numbers will be used to identify bidders, proposers or vendors to ensure their compliance with laws, to assist the City in enforcement of laws, as well as to provide the City a means of identifying of businesses which seek City contracts.

(NO TEXT ON THIS PAGE)



12/24/2014 12:00 AM

NEW YORK CITY DEPARTMENT OF DESIGN AND CONSTRUCTION
DIVISION OF INFRASTRUCTURE - BUREAU OF DESIGN

CONTRACT PIN: 8502013HW0079C
PROJECT ID: HWPEDSF1

BID SCHEDULE

- NOTE:**
- (1) The Agency may reject a bid if it contains unbalanced bid prices. An unbalanced bid is considered to be one containing lump sum or unit items which do not reflect reasonable actual costs plus a reasonable proportionate share of the Bidder's anticipated profit, overhead costs, and other indirect costs, anticipated for the performance of the items in question.
 - (2) The following bid prices on Unit Price Contracts are to be paid for the actual quantities of the item numbers in the completed work or structure, and they cover the cost of all work, labor, material, tools, plant and appliances of every description necessary to complete the entire work, as specified, and the removal of all debris, temporary work and appliances.
 - (3) **PLEASE BE SURE A LEGIBLE BID IS ENTERED, IN INK, FOR EACH ITEM.**
Alterations must be initiated in ink by the bidder.
 - (4) The Extended Amount entered in Column 6 shall be the product of the Estimated Quantity in Column 3 times the Unit Price Bid in Column 5.
 - (5) Prospective bidders must examine the Bid Schedule carefully and, before bidding, must advise the Commissioner, in writing, if any pages are missing, and must request that such missing pages be furnished them. The pages of this Bid Schedule are numbered consecutively, as follows:
B - 3 Through B - 33

PLEASE BE SURE A LEGIBLE BID IS ENTERED FOR EACH ITEM.
THE BIDDER SHALL INSERT THE TOTAL BID PRICE IN
THE BID FORM ON PAGE C-4 OF THIS BID BOOKLET.

BID SCHEDULE FORM

COL 1 SEQ. NO	COL 2 ITEM NUMBER and DESCRIPTION	COL 3 ENGINEER'S ESTIMATE OF QUANTITY	COL 4 UNIT	COL 5 UNIT PRICE (IN FIGURES)		COL 6 EXTENDED AMOUNT (IN FIGURES)	
				DOLLARS	CTS	DOLLARS	CTS
001	4.02 AG ASPHALTIC CONCRETE WEARING COURSE, 3" THICK	832.00	S.Y.	30.00		24,960.00	
002	4.02 CB ASPHALTIC CONCRETE MIXTURE	192.00	TONS	148.00		28,416.00	
003	4.04 H CONCRETE BASE FOR PAVEMENT, VARIABLE THICKNESS FOR TRENCH RESTORATION, (HIGH-EARLY STRENGTH)	249.00	C.Y.	216.00		53,784.00	
004	4.05 AX HIGH-EARLY STRENGTH REINFORCED CONCRETE PAVEMENT (BUS STOPS)	336.00	C.Y.	312.00		104,832.00	
005	4.08 AA CONCRETE CURB (18" DEEP)	101.00	L.F.	32.00		3,232.00	
006	4.09 AD STRAIGHT STEEL FACED CONCRETE CURB (18" DEEP)	589.00	L.F.	50.00		29,450.00	

12/24/2014 12:00 AM

NEW YORK CITY DEPARTMENT OF DESIGN AND CONSTRUCTION
 DIVISION OF INFRASTRUCTURE - BUREAU OF DESIGN

PROJECT ID: HWPEDSF1
 CONTRACT PIN: 8502013HW0079C

BID SCHEDULE FORM

COL 1 SEQ. NO.	COL 2 ITEM NUMBER and DESCRIPTION	COL 3 ENGINEER'S ESTIMATE OF QUANTITY	COL 4 UNIT	COL 5 UNIT PRICE (IN FIGURES) DOLLARS . CTS	COL 6 EXTENDED AMOUNT (IN FIGURES) DOLLARS . CTS
007	4.09 AF STRAIGHT STEEL FACED CONCRETE CURB (27" DEEP)	587.00	L.F.	54.00	31,698.00
008	4.09 CD CORNER STEEL FACED CONCRETE CURB (18" DEEP)	325.00	L.F.	59.00	19,175.00
009	4.11 CA FILL, PLACE MEASUREMENT	161.00	C.Y.	28.00	4,508.00
010	4.13 AAS 4" CONCRETE SIDEWALK (UNPIGMENTED)	30,855.00	S.F.	9.00	277,695.00
011	4.13 BAS 7" CONCRETE SIDEWALK (UNPIGMENTED)	1,620.00	S.F.	10.50	17,010.00
012	4.13 DE EMBEDDED PREFORMED DETECTABLE WARNING UNITS	242.00	S.F.	24.00	5,808.00

BID SCHEDULE FORM

COL 1 SEQ. NO	COL 2 ITEM NUMBER and DESCRIPTION	COL 3 ENGINEER'S ESTIMATE OF QUANTITY	COL 4 UNIT	COL 5 UNIT PRICE (IN FIGURES) DOLLARS	COL 6 EXTENDED AMOUNT (IN FIGURES) DOLLARS	CTS
013	4.18 A MAINTENANCE TREE PRUNING (UNDER 12" CAL.)	1.00	EACH	1.00	1.00	1.00
014	4.21 TREE CONSULTANT	4.00	P/HR	190.00	760.00	760.00
015	51.21S0A1000E STANDARD MANHOLE TYPE A-1 ON EXISTING SEWER	6.00	EACH	5,760.00	34,560.00	34,560.00
016	51.21S0A2000E STANDARD MANHOLE TYPE A-2 ON EXISTING SEWER	1.00	EACH	7,200.00	7,200.00	7,200.00
017	51.23RF REPLACEMENT OF EXISTING MANHOLE FRAME AND COVER	5.00	EACH	720.00	3,600.00	3,600.00
018	51.41S001 STANDARD CATCH BASIN, TYPE 1	13.00	EACH	3,840.00	49,920.00	49,920.00

12/24/2014 12:00 AM

NEW YORK CITY DEPARTMENT OF DESIGN AND CONSTRUCTION
 DIVISION OF INFRASTRUCTURE - BUREAU OF DESIGN

PROJECT ID: HWPEDSF1
 CONTRACT PIN: 8502013HW0079C

BID SCHEDULE FORM

COL 1 SEQ. NO	COL 2 ITEM NUMBER and DESCRIPTION	COL 3 ENGINEER'S ESTIMATE OF QUANTITY	COL 4 UNIT	COL 5 UNIT PRICE (IN FIGURES) DOLLARS	COL 6 EXTENDED AMOUNT (IN FIGURES) DOLLARS
019	51.42S1SO INCREMENTAL COST OF STANDARD CATCH BASIN TYPE 3 WITH CURB PIECE IN LIEU OF STANDARD CATCH BASIN TYPE 1	5.00	EACH	2,400.00	12,000.00
020	52.11D12 12" DUCTILE IRON PIPE BASIN CONNECTION	399.00	L.F.	200.00	79,800.00
021	55.11AB ABANDONING BASINS AND INLETS	5.00	EACH	720.00	3,600.00
022	6.02 AAN UNCLASSIFIED EXCAVATION	1,758.00	C.Y.	52.00	91,416.00
023	6.02 XHEC INCREMENTAL COST FOR MODIFYING WORK METHODS NEAR (WITHIN 3 FEET OF) TRANSIT FACILITIES AND BUILDING VAULTS	94.00	C.Y.	96.00	9,024.00
024	6.02 XSCW INCREMENTAL COST FOR USING SPECIAL CARE WORK METHODS NEAR (FROM 3 FEET TO 50 FEET) TRANSIT FACILITIES	1,665.00	C.Y.	38.00	63,270.00

BID SCHEDULE FORM

COL 1 SEQ. NO	COL 2 ITEM NUMBER and DESCRIPTION	COL 3 ENGINEERS ESTIMATE OF QUANTITY	COL 4 UNIT	COL 5 UNIT PRICE (IN FIGURES)		COL 6 EXTENDED AMOUNT (IN FIGURES)	
				DOLLARS	CTS	DOLLARS	CTS
025	6.23 AB REMOVE EXISTING FIRE ALARM POST	1.00	EACH	506	00	506	00
026	6.23 BA FURNISH AND INSTALL FIRE ALARM POST AND SUBBASE IN ACCORDANCE WITH F.D. STD. DWG. #141	1.00	EACH	3,072	00	3,072	00
027	6.23 BD FURNISH AND INSTALL 4-PAIR FIRE ALARM CABLE	209.00	L.F.	13	00	2,717	00
028	6.23 BES FURNISH AND INSTALL FIRE DEPARTMENT SLOTTED MANHOLE TYPE "A" WITH FRAME AND COVER IN ACCORDANCE WITH F.D. STD. DWG. #140, #144S & #144E	2.00	EACH	8,160	00	16,320	00
029	6.23 BFB FURNISH AND INSTALL FIRE DEPARTMENT 24 WIRE TERMINAL BOX AND TERMINATE FIRE ALARM CABLES	1.00	EACH	3,034	00	3,034	00
030	6.23 BGSE FURNISH AND INSTALL 4" P.V.C. CONDUIT, SCHEDULE 40, U.L. 651 (WITH PAVEMENT EXCAVATION)	99.00	L.F.	23	00	2,277	00

12/24/2014 12:00 AM

NEW YORK CITY DEPARTMENT OF DESIGN AND CONSTRUCTION

PROJECT ID: HWPEDSF1

DIVISION OF INFRASTRUCTURE - BUREAU OF DESIGN

CONTRACT PIN: 8502013HW0079C

BID SCHEDULE FORM

COL 1 SEQ. NO.	COL 2 ITEM NUMBER and DESCRIPTION	COL 3 ENGINEER'S ESTIMATE OF QUANTITY	COL 4 UNIT	COL 5 UNIT PRICE (IN FIGURES) DOLLARS	COL 6 EXTENDED AMOUNT (IN FIGURES) DOLLARS	CTS
031	6.23 BHE FURNISH AND INSTALL 4" 90-DEGREE P.V.C. WIDE BEND, SCHEDULE 40, U.L. 651 (WITH PAVEMENT EXCAVATION) IN ACCORDANCE WITH F.D. STD. DWG. #141 OR #145AA	1.00	EACH	240.00	240.00	
032	6.23 BP FURNISH AND INSTALL FIRE ALARM PEDESTAL BUMPERS (2 REQUIRED PER SET) IN ACCORDANCE WITH F.D. STD. DWG. #168	1.00	SETS	480.00	480.00	
033	6.25 RS TEMPORARY SIGNS	96.00	S.F.	7.50	720.00	
034	6.26 TIMBER CURB	5,657.00	L.F.	8.60	48,650.20	
035	6.28 BA LIGHTED TYPE III BREAKAWAY BARRICADES	4,964.00	L.F.	10.50	52,122.00	
036	6.36 DR STRUCTURAL REPAIR AND ADJUSTMENT OF UTILITY STRUCTURES	6.00	C.Y.	960.00	5,760.00	

BID SCHEDULE FORM

COL 1 SEQ. NO	COL 2 ITEM NUMBER and DESCRIPTION	COL 3 ENGINEER'S ESTIMATE OF QUANTITY	COL 4 UNIT	COL 5 UNIT PRICE (IN FIGURES)		COL 6 EXTENDED AMOUNT (IN FIGURES)	
				DOLLARS	CTS	DOLLARS	CTS
037	6.40 B ENGINEER'S FIELD OFFICE (TYPE B)	15.00	MONTH	5,280.00		79,200.00	
038	6.43 PHOTOGRAPHS	572.00	SETS	20.00		11,440.00	
039	6.44 THERMOPLASTIC REFLECTORIZED PAVEMENT MARKINGS (4" WIDE)	9,998.00	L.F.	1.40		13,997.20	
040	6.49 TEMPORARY PAVEMENT MARKINGS (4" WIDE)	440.00	L.F.	1.00		440.00	
041	6.50 CLEANING OF DRAINAGE STRUCTURES	13.00	EACH	768.00		9,984.00	

12/24/2014 12:00 AM

NEW YORK CITY DEPARTMENT OF DESIGN AND CONSTRUCTION
 DIVISION OF INFRASTRUCTURE - BUREAU OF DESIGN

PROJECT ID: HWPEDSF1

CONTRACT PIN: 8502013HW0079C

BID SCHEDULE FORM

COL 1 SEQ. NO.	COL 2 ITEM NUMBER and DESCRIPTION	COL 3 ENGINEERS ESTIMATE OF QUANTITY	COL 4 UNIT	COL 5 UNIT PRICE (IN FIGURES) DOLLARS CTS	COL 6 EXTENDED AMOUNT (IN FIGURES) DOLLARS CTS
042	6.52 FED UNIFORMED FLAGPERSON PRICE BID SHALL BE FOR THE FIXED SUM OF \$ 38,610.00	1.00	F.S.	38,610 00	38,610 00
043	6.53 REMOVE EXISTING LANE MARKINGS (4" WIDE)	7,444.00	L.F.	0 72	5,359 68
044	6.55 SAWCUTTING EXISTING PAVEMENT	4,542.00	L.F.	4 80	21,801 60
045	6.73 A REMOVING EXISTING PARKING METER POSTS	11.00	EACH	10 00	110 00
046	6.75 GRINDING EXISTING ASPHALTIC CONCRETE WEARING COURSE	18.00	C.Y.	480 00	8,640 00

BID SCHEDULE FORM

COL 1 SEQ. NO	COL 2 ITEM NUMBER and DESCRIPTION	COL 3 ENGINEER'S ESTIMATE OF QUANTITY	COL 4 UNIT	COL 5 UNIT PRICE (IN FIGURES)		COL 6 EXTENDED AMOUNT (IN FIGURES)	
				DOLLARS	CTS	DOLLARS	CTS
047	6.82 A REMOVING EXISTING TRAFFIC AND STREET NAME SIGNS	157.00	S.F.	1	00	157	00
048	6.82 B REMOVING EXISTING TRAFFIC AND STREET NAME SIGN POSTS	144.00	L.F.	1	00	144	00
049	6.83 AA FURNISHING NEW NON-REFLECTORIZED TRAFFIC SIGNS	27.00	S.F.	9	00	243	00
050	6.83 AB FURNISHING NEW TRAFFIC SIGN POSTS	108.00	L.F.	11	00	1,188	00
051	6.83 AR FURNISHING NEW REFLECTORIZED TRAFFIC SIGNS	65.00	S.F.	15	00	975	00
052	6.83 BA INSTALLING TRAFFIC SIGNS	92.00	S.F.	9	60	883	20

12/24/2014 12:00 AM

NEW YORK CITY DEPARTMENT OF DESIGN AND CONSTRUCTION
DIVISION OF INFRASTRUCTURE - BUREAU OF DESIGN

PROJECT ID: HWPEDSF1
CONTRACT PIN: 8502013HW0079C

BID SCHEDULE FORM

COL 1 SEQ. NO	COL 2 ITEM NUMBER and DESCRIPTION	COL 3 ENGINEER'S ESTIMATE OF QUANTITY	COL 4 UNIT	COL 5 UNIT PRICE (IN FIGURES) DOLLARS CTS	COL 6 EXTENDED AMOUNT (IN FIGURES) DOLLARS CTS
053	6.83 BB INSTALLING TRAFFIC SIGN POSTS	108.00	L.F.	9.60	1,036.80
054	6.84 B LOLLIPOP TYPE BUS STOP SIGNS PRICE BID SHALL BE FOR THE FIXED SUM OF \$ 20,000.00	1.00	F.S.	20,000.00	20,000.00
055	6.86 AA FURNISHING NEW STREET NAME SIGNS	25.00	S.F.	72.00	1,800.00
056	6.86 AB FURNISHING NEW STREET NAME SIGN POSTS	98.00	L.F.	5.75	563.50
057	6.86 BA INSTALLING STREET NAME SIGNS	25.00	S.F.	19.00	475.00

BID SCHEDULE FORM

COL 1 SEQ. NO	COL 2 ITEM NUMBER AND DESCRIPTION	COL 3 ENGINEER'S ESTIMATE OF QUANTITY	COL 4 UNIT	COL 5 UNIT PRICE (IN FIGURES)		COL 6 EXTENDED AMOUNT (IN FIGURES) DOLLARS
				DOLLARS	CTS	
058	6.86 BB INSTALLING STREET NAME SIGN POSTS	98.00	L.F.		14 00	1,372 00
059	6.87 PLASTIC BARRELS	1,066.00	EACH		4 80	5,116 80
060	6.91 REFLECTIVE CRACKING MEMBRANE (18" WIDE)	4,542.00	L.F.		3 40	15,142 80
061	6.99 AUDIO AND VIDEO DOCUMENTATION SURVEY	1.00	L.S.		2,880 00	2,880 00
062	60.11R606 FURNISHING AND DELIVERING 6-INCH DUCTILE IRON RESTRAINED JOINT PIPE (CLASS 56)	11.00	L.F.		41 00	451 00
063	60.11R612 FURNISHING AND DELIVERING 12-INCH DUCTILE IRON RESTRAINED JOINT PIPE (CLASS 56)	638.00	L.F.		107 00	68,266 00

12/24/2014 12:00 AM

NEW YORK CITY DEPARTMENT OF DESIGN AND CONSTRUCTION
 DIVISION OF INFRASTRUCTURE - BUREAU OF DESIGN

PROJECT ID: HWPEDSF1
 CONTRACT PIN: 8502013HW0079C

BID SCHEDULE FORM

COL 1 SEQ. NO	COL 2 ITEM NUMBER and DESCRIPTION	COL 3 ENGINEER'S ESTIMATE OF QUANTITY	COL 4 UNIT	COL 5 UNIT PRICE (IN FIGURES) DOLLARS	COL 6 EXTENDED AMOUNT (IN FIGURES) DOLLARS
064	60.12D06 LAYING 6-INCH DUCTILE IRON PIPE AND FITTINGS	14.00	L.F.	96.00	1,344.00
065	60.12D12 LAYING 12-INCH DUCTILE IRON PIPE AND FITTINGS	688.00	L.F.	76.00	52,288.00
066	60.13M0A24 FURNISHING AND DELIVERING DUCTILE IRON MECHANICAL JOINT 24- -INCH DIAMETER AND SMALLER FITTINGS, INCLUDING WEDGE TYPE RETAINER GLANDS	4.00	TONS	8,065.00	32,260.00
067	61.11DMM06 FURNISHING AND DELIVERING 6-INCH MECHANICAL JOINT DUCTILE IRON GATE VALVE COMPLETE WITH WEDGE TYPE RETAINER GLANDS	1.00	EACH	1150.00	1,150.00
068	61.11DMM12 FURNISHING AND DELIVERING 12-INCH MECHANICAL JOINT DUCTILE IRON GATE VALVE COMPLETE WITH WEDGE TYPE RETAINER GLANDS	6.00	EACH	3,300.00	19,800.00

BID SCHEDULE FORM

COL 1 SEQ. NO	COL 2 ITEM NUMBER and DESCRIPTION	COL 3 ENGINEER'S ESTIMATE OF QUANTITY	COL 4 UNIT	COL 5 UNIT PRICE (IN FIGURES) DOLLARS	COL 6 EXTENDED AMOUNT (IN FIGURES) DOLLARS
069	61.11TWC03 FURNISHING AND DELIVERING 3-INCH WET CONNECTION TAPPING VALVE COMPLETE WITH WEDGE TYPE RETAINER GLANDS	1.00	EACH	1,440.00	1,440.00
070	61.11TWC04 FURNISHING AND DELIVERING 4-INCH WET CONNECTION TAPPING VALVE COMPLETE WITH WEDGE TYPE RETAINER GLANDS	1.00	EACH	1,440.00	1,440.00
071	61.11TWC06 FURNISHING AND DELIVERING 6-INCH WET CONNECTION TAPPING VALVE COMPLETE WITH WEDGE TYPE RETAINER GLANDS	1.00	EACH	1,560.00	1,560.00
072	61.12DMM06 SETTING 6-INCH MECHANICAL JOINT DUCTILE IRON GATE VALVE COMPLETE WITH WEDGE TYPE RETAINER GLANDS	1.00	EACH	285.00	285.00
073	61.12DMM12 SETTING 12-INCH MECHANICAL JOINT DUCTILE IRON GATE VALVE COMPLETE WITH WEDGE TYPE RETAINER GLANDS	6.00	EACH	480.00	2,880.00
074	61.12TWC03 SETTING 3-INCH WET CONNECTION TAPPING VALVE COMPLETE WITH WEDGE TYPE RETAINER GLANDS	1.00	EACH	860.00	860.00

12/24/2014 12:00 AM

NEW YORK CITY DEPARTMENT OF DESIGN AND CONSTRUCTION
 DIVISION OF INFRASTRUCTURE - BUREAU OF DESIGN

PROJECT ID: HWPEDSF1

CONTRACT PIN: 8502013HW0079C

BID SCHEDULE FORM

COL 1 SEQ. NO	COL 2 ITEM NUMBER AND DESCRIPTION	COL 3 ENGINEERS ESTIMATE OF QUANTITY	COL 4 UNIT	COL 5 UNIT PRICE (IN FIGURES) DOLLARS : CTS	COL 6 EXTENDED AMOUNT (IN FIGURES) DOLLARS : CTS
075	61.12TWC04 SETTING 4-INCH WET CONNECTION TAPPING VALVE COMPLETE WITH WEDGE TYPE RETAINER GLANDS	1.00	EACH	860.00	860.00
076	61.12TWC06 SETTING 6-INCH WET CONNECTION TAPPING VALVE COMPLETE WITH WEDGE TYPE RETAINER GLANDS	1.00	EACH	860.00	860.00
077	62.11SD FURNISHING AND DELIVERING HYDRANTS	1.00	EACH	3,070.00	3,070.00
078	62.12SG SETTING HYDRANTS COMPLETE WITH WEDGE TYPE RETAINER GLANDS	1.00	EACH	960.00	960.00
079	62.13RH REMOVING HYDRANTS	1.00	EACH	96.00	96.00
080	62.14FS FURNISHING, DELIVERING AND INSTALLING HYDRANT FENDERS	2.00	EACH	336.00	672.00

BID SCHEDULE FORM

COL 1 SEQ. NO.	COL 2 ITEM NUMBER and DESCRIPTION	COL 3 ENGINEER'S ESTIMATE OF QUANTITY	COL 4 UNIT	COL 5 UNIT PRICE (IN FIGURES)		COL 6 EXTENDED AMOUNT (IN FIGURES)	
				DOLLARS	CTS	DOLLARS	CTS
081	63.11VC FURNISHING AND DELIVERING VARIOUS CASTINGS	5.00	TONS	2,600.00		13,000.00	00
082	637.9520 FIELD INFORMATION MANAGEMENT SYSTEM PRICE BID SHALL BE FOR THE FIXED SUM OF \$ 25,000.00	1.00	F.S.	25,000.00		25,000.00	00
083	64.11EL WITHDRAWING AND REPLACING HOUSE SERVICES USING 1-1/2- INCH OR LARGER SCREW TAPS	11.00	EACH	620.00		6,820.00	00
084	64.11ST WITHDRAWING AND REPLACING HOUSE SERVICES USING SMALLER THAN 1-1/2-INCH SCREW TAPS	7.00	EACH	430.00		3,010.00	00
085	64.12COEG CUTTING AND OFFSETTING HOUSE SERVICE WATER CONNECTIONS (EQUAL TO OR GREATER THAN 3-INCH DIAMETER)	6.00	L.F.	288.00		1,728.00	00

12/24/2014 12:00 AM

NEW YORK CITY DEPARTMENT OF DESIGN AND CONSTRUCTION
 DIVISION OF INFRASTRUCTURE - BUREAU OF DESIGN

PROJECT ID: HWPEDSF1

CONTRACT PIN: 8502013HW0079C

BID SCHEDULE FORM

COL 1 SEQ. NO.	COL 2 ITEM NUMBER and DESCRIPTION	COL 3 ENGINEER'S ESTIMATE OF QUANTITY	COL 4 UNIT	COL 5 UNIT PRICE (IN FIGURES) DOLLARS CTS	COL 6 EXTENDED AMOUNT (IN FIGURES) DOLLARS CTS
086	64.12COLT CUTTING AND OFFSETTING HOUSE SERVICE WATER CONNECTIONS (LESS THAN 3-INCH DIAMETER)	6.00	L.F.	288 00	1,728 00
087	64.12ESEG EXTENDING HOUSE SERVICE WATER CONNECTIONS (EQUAL TO OR GREATER THAN 3-INCH DIAMETER)	6.00	L.F.	288 00	1,728 00
088	64.12ESLT EXTENDING HOUSE SERVICE WATER CONNECTIONS (LESS THAN 3- INCH DIAMETER)	6.00	L.F.	288 00	1,728 00
089	64.13WC12 FURNISHING, DELIVERING AND INSTALLING WET CONNECTION SLEEVE ON 12-INCH WATER MAIN PIPE WITH VARIOUS OUTLETS	11.00	EACH	1,775 00	19,525 00
090	65.11BR FURNISHING, DELIVERING AND INSTALLING BANDS, RODS, WASHERS, ETC., COMPLETE, FOR RESTRAINING JOINTS	2,836.00	LBS.	9 00	25,524 00
091	65.21PS FURNISHING AND PLACING POLYETHYLENE SLEEVE Unit price bid shall not be less than: \$ 0.50	714.00	L.F.	0 50	357 00

BID SCHEDULE FORM

COL 1 SEQ. NO	COL 2 ITEM NUMBER and DESCRIPTION	COL 3 ENGINEER'S ESTIMATE OF QUANTITY	COL 4 UNIT	COL 5 UNIT PRICE (IN FIGURES)		COL 6 EXTENDED AMOUNT (IN FIGURES)	
				DOLLARS	CTS	DOLLARS	CTS
092	65.31FF FURNISHING, DELIVERING AND PLACING FILTER FABRIC Unit price bid shall not be less than: \$ 0.10	1,779.00	S.F.	010		177	90
093	65.71SG FURNISHING, DELIVERING AND PLACING SCREENED GRAVEL OR SCREENED BROKEN STONE BEDDING	37.00	C.Y.	5800		2,146	00
094	7.13 B MAINTENANCE OF SITE Unit price bid shall not be less than: \$ 8,600.00	9.00	MONTH	8,600.00		77,400	00
095	7.19 LOAD TRANSFER JOINT	294.00	L.F.	900		2,646	00
096	7.36 PEDESTRIAN STEEL BARRICADES	13,019.00	L.F.	700		91,133	00
097	7.50 CBB CITY BENCH BACKLESS	6.00	EACH	2,500.00		15,000	00

12/24/2014 12:00 AM

NEW YORK CITY DEPARTMENT OF DESIGN AND CONSTRUCTION
 DIVISION OF INFRASTRUCTURE - BUREAU OF DESIGN

PROJECT ID: HWPEDSF1
 CONTRACT PIN: 8502013HW0079C

BID SCHEDULE FORM

COL 1 SEQ. NO.	COL 2 ITEM NUMBER AND DESCRIPTION	COL 3 ENGINEER'S ESTIMATE OF QUANTITY	COL 4 UNIT	COL 5 UNIT PRICE (IN FIGURES) DOLLARS CTS	COL 6 EXTENDED AMOUNT (IN FIGURES) DOLLARS CTS
098	7.88 AA RODENT INFESTATION SURVEY AND MONITORING Unit price bid shall not be less than: \$ 1,000.00	1.00	L.S.	3,600.00	3,600.00
099	7.88 AB RODENT BAIT STATIONS Unit price bid shall not be less than: \$ 60.00	88.00	EACH	60.00	5,280.00
100	7.88 AC BAITING OF RODENT BAIT STATIONS Unit price bid shall not be less than: \$ 9.25	88.00	EACH	13.00	1,144.00
101	7.88 AD WATERBUG BAIT APPLICATIONS Unit price bid shall not be less than: \$ 65.00	132.00	BLOCK	65.00	8,580.00
102	70.31FN FENCING Unit price bid shall not be less than: \$ 2.00	1,298.00	L.F.	2.00	2,596.00
103	70.61RE ROCK EXCAVATION	6.00	C.Y.	2.00	12.00

BID SCHEDULE FORM

COL 1 SEQ. NO.	COL 2 ITEM NUMBER and DESCRIPTION	COL 3 ENGINEER'S ESTIMATE OF QUANTITY	COL 4 UNIT	COL 5 UNIT PRICE (IN FIGURES) DOLLARS	COL 6 EXTENDED AMOUNT (IN FIGURES) DOLLARS
104	70.81CB CLEAN BACKFILL Unit price bid shall not be less than: \$ 15.00	121.00	C.Y.	15.00	11815.00
105	73.11AB ADDITIONAL BRICK MASONRY Unit price bid shall not be less than: \$ 62.50	2.00	C.Y.	62.50	125.00
106	73.21AC ADDITIONAL CONCRETE Unit price bid shall not be less than: \$ 62.50	2.00	C.Y.	120.00	240.00
107	73.31AE0 ADDITIONAL EARTH EXCAVATION INCLUDING TEST PITS (ALL DEPTHS) Unit price bid shall not be less than: \$ 20.00	2.00	C.Y.	96.00	192.00
108	73.41AG ADDITIONAL SELECT GRANULAR BACKFILL Unit price bid shall not be less than: \$ 15.00	2.00	C.Y.	28.00	56.00
109	73.51AS ADDITIONAL STEEL REINFORCING BARS Unit price bid shall not be less than: \$ 1.00	220.00	LBS.	2.50	550.00

12/24/2014 12:00 AM

NEW YORK CITY DEPARTMENT OF DESIGN AND CONSTRUCTION
 DIVISION OF INFRASTRUCTURE - BUREAU OF DESIGN

PROJECT ID: HWPEDSF1
 CONTRACT PIN: 8502013HW0079C

BID SCHEDULE FORM

COL 1 SEQ. NO	COL 2 ITEM NUMBER and DESCRIPTION	COL 3 ENGINEERS ESTIMATE OF QUANTITY	COL 4 UNIT	COL 5 UNIT PRICE (IN FIGURES) DOLLARS CTS	COL 6 EXTENDED AMOUNT (IN FIGURES) DOLLARS CTS
110	8.02 A SPECIAL CARE EXCAVATION AND RESTORATION FOR SIDEWALK WORK	2,312.00	S.F.	1.00	2,312.00
111	8.02 B SPECIAL CARE EXCAVATION AND RESTORATION FOR CURB WORK	201.00	L.F.	9.00	1,809.00
112	9.04 HW ALLOWANCE FOR ANTI-FREEZE ADDITIVE IN CONCRETE PRICE BID SHALL BE FOR THE FIXED SUM OF \$ 15,000.00	1.00	F.S.	15,000.00	15,000.00
113	SL-20.02.02 FURNISH AND INSTALL STANDARD TYPE ANCHOR BOLT FOUNDATION, AS PER DRAWING E-3788	10.00	EACH	2,112.00	21,120.00
114	SL-21.03.24A FURNISH AND INSTALL TYPE 14' (HIGH) STEEL DAVIT LAMPPOST (SINGLE ARM) AS PER STANDARD DWG J-5308.	10.00	EACH	3,096.00	30,960.00

BID SCHEDULE FORM

COL 1 SEQ. NO	COL 2 ITEM NUMBER and DESCRIPTION	COL 3 ENGINEERS ESTIMATE OF QUANTITY	COL 4 UNIT	COL 5 UNIT PRICE (IN FIGURES)		COL 6 EXTENDED AMOUNT (IN FIGURES)
				DOLLARS	CTS	
115	SL-21.09.09 REMOVE F.S. SPUN ALUMINUM, #10, ETC LAMPPOST, WITH ARMS(S), LUMINAIRE(S), ETC., WITH ALL ATTACHMENTS, IF ANY. REMOVE PORTION OF FOUNDATION. RESTORE TO SURROUNDING CONDITIONS.	4.00	EACH	645	00	2,580.00
116	SL-22.03.18 FURNISH AND INSTALL TYPE COBRA HEAD LUMINAIRE WITH 150 WATT HPS WITH SOLID STATE BALLAST AND STRAY VOLTAGE INDICATOR FOR 100 VOLT LAMP.	10.00	EACH	580	00	5,800.00
117	SL-24.01.04 REMOVE BRACKET, LUMINAIRE AND CONTROL, IF ANY, FROM WOOD POLE	2.00	EACH	258	00	516.00
118	SL-26.01.01 FURNISH AND INSTALL, OR FURNISH AND REPLACE A PLUG-IN SOLID STATE PHOTOELECTRIC CONTROL	10.00	EACH	65	00	650.00
119	SL-26.06.02 FURNISH AND INSTALL LED FIRE ALARM LUMINAIRES.	1.00	EACH	225	00	225.00

12/24/2014 12:00 AM

NEW YORK CITY DEPARTMENT OF DESIGN AND CONSTRUCTION
DIVISION OF INFRASTRUCTURE - BUREAU OF DESIGN

PROJECT ID: HWPEDSF1
CONTRACT PIN: 8502013HW0079C

BID SCHEDULE FORM

COL 1 SEQ. NO.	COL 2 ITEM NUMBER and DESCRIPTION	COL 3 ENGINEER'S ESTIMATE OF QUANTITY	COL 4 UNIT	COL 5 UNIT PRICE (IN FIGURES) DOLLARS CTS	COL 6 EXTENDED AMOUNT (IN FIGURES) DOLLARS CTS
120	T-1.1 INSTALL TYPE "S" OR "T" FOUNDATION	4.00	EACH	1,200.00	4,800.00
121	T-1.18 REMOVE TYPE "A", "B", "S" OR "T" SERIES FOUNDATION	3.00	EACH	816.00	2,448.00
122	T-1.21 REMOVE TYPE "F-1" FOUNDATION	1.00	EACH	816.00	816.00
123	T-1.29 RAISE OR LOWER FOUNDATION TO GRADE	1.00	EACH	1,440.00	1,440.00
124	T-2.1 INSTALL TYPE "S-1" OR "T-1" SERIES POST	4.00	EACH	505.00	2,020.00
125	T-2.16 FURNISH, INSTALL, MAINTAIN AND REMOVE TEMPORARY POST OR PYLON WITH SIGNALS	2.00	EACH	1,290.00	2,580.00

BID SCHEDULE FORM

COL 1 SEQ. NO	COL 2 ITEM NUMBER and DESCRIPTION	COL 3 ENGINEER'S ESTIMATE OF QUANTITY	COL 4 UNIT	COL 5 UNIT PRICE (IN FIGURES)		COL 6 EXTENDED AMOUNT (IN FIGURES)	
				DOLLARS	CTS	DOLLARS	CTS
126	T-2.18 FURNISH, INSTALL, MAINTAIN AND REMOVE TEMPORARY POST OR PYLON WITH CONTROLLER AND SIGNALS	1.00	EACH	1,548	00	1,548	00
127	T-2.22 REMOVE TYPE "S-1" OR "T-1" SERIES POST	3.00	EACH	462	00	1,386	00
128	T-2.23 REMOVE TYPE "S-10", "T-10" OR "S-14" SERIES POST	1.00	EACH	538	00	538	00
129	T-20000 FURNISH TEN FOOT ALUMINUM SIGNAL POST TYPE "S-1"	4.00	EACH	612	00	2,448	00
130	T-20020 a) FURNISH 3/4" ANCHOR BOLT ASSEMBLIES FOR S-1 (EACH) (3 REQUIRED PER POST)	12.00	EACH	16	00	192	00
131	T-3.1 INSTALL "ONE-WAY" SIGNAL UNIT ON MAST ARM OR TOP OF TRAFFIC POST	3.00	EACH	258	00	774	00

12/24/2014 12:00 AM

NEW YORK CITY DEPARTMENT OF DESIGN AND CONSTRUCTION
 DIVISION OF INFRASTRUCTURE - BUREAU OF DESIGN

PROJECT ID: HWPEDSF1
 CONTRACT PIN: 8502013HW0079C

BID SCHEDULE FORM

COL 1 SEQ. NO	COL 2 ITEM NUMBER and DESCRIPTION	COL 3 ENGINEER'S ESTIMATE OF QUANTITY	COL 4 UNIT	COL 5 UNIT PRICE (IN FIGURES)		COL 6 EXTENDED AMOUNT (IN FIGURES)	
				DOLLARS	CTS	DOLLARS	CTS
132	T-3.18 REMOVE SIGNAL HEAD FROM ANY TYPE POST	6.00	EACH	258	00	1,548	00
133	T-3.2 INSTALL "ONE-WAY" SIGNAL UNIT ON THE SHAFT OF ANY POST	3.00	EACH	419	00	1,257	00
134	T-3.21 REMOVE PEDESTRIAN SIGNAL OR SIGN UNIT OR OTHER ILLUMINATED SIGNS FROM ANY POST	18.00	EACH	258	00	4,644	00
135	T-3.4 INSTALL "ONE-WAY" SIGNAL UNIT OR PEDESTRIAN SIGNAL ON STEEL STRUCTURE (PER FACE)	6.00	EACH	1,204	00	7,224	00
136	T-3.6 INSTALL PEDESTRIAN SIGNAL ON ANY TYPE POST	13.00	EACH	365	00	4,745	00
137	T-30013L FURNISH ADJUST 3 SCTN 1-WAY TRAFFIC SIGNAL, 8" - WILED LENS	6.00	EACH	375	00	2,250	00

BID SCHEDULE FORM

COL 1 SEQ. NO.	COL 2 ITEM NUMBER and DESCRIPTION	COL 3 ENGINEER'S ESTIMATE OF QUANTITY	COL 4 UNIT	COL 5 UNIT PRICE (IN FIGURES) DOLLARS	COL 6 EXTENDED AMOUNT (IN FIGURES) DOLLARS
138	T-31150 FURNISH "ISA" ALUMINUM DIE CASTINGS AND ASSEMBLY FOR POST SIGNAL MOUNTING	3.00	EACH	86.00	258.00
139	T-31200 e) "VB" ASSEMBLY *ASSEMBLY IS EQUAL TO ONE PAIR	3.00	EACH	75.00	225.00
140	T-31210 h) "HUB" ASSEMBLY *ASSEMBLY IS EQUAL TO ONE PAIR	19.00	EACH	41.00	779.00
141	T-31340 f) "VB-P" ASSEMBLY *ASSEMBLY IS EQUAL TO ONE PAIR	12.00	EACH	86.00	1032.00
142	T-31351 g) "VB-2P" ASSEMBLY *ASSEMBLY IS EQUAL TO ONE PAIR	4.00	EACH	225.00	900.00
143	T-33000L FURNISH POLYCARBONATE INCANDESCENT PED SIGNAL W/LED LENS	19.00	EACH	312.00	5,928.00

12/24/2014 12:00 AM

NEW YORK CITY DEPARTMENT OF DESIGN AND CONSTRUCTION
 DIVISION OF INFRASTRUCTURE - BUREAU OF DESIGN

PROJECT ID: HWPEDSF1
 CONTRACT PIN: 8502013HW0079C

BID SCHEDULE FORM

COL. 1 SEQ. NO.	COL. 2 ITEM NUMBER and DESCRIPTION	COL. 3 ENGINEER'S ESTIMATE OF QUANTITY	COL. 4 UNIT	COL. 5 UNIT PRICE (IN FIGURES)		COL. 6 EXTENDED AMOUNT (IN FIGURES) DOLLARS
				DOLLARS	CTS	
144	T-4.22 INSTALL ANY TYPE OF ADVANCED SOLID STATE TRAFFIC SIGNAL CONTROLLER AND CABINET ON METAL POLE	2.00	EACH	2,258.00		4,516.00
145	T-4.8 REMOVE ONE CONTROL BOX AND CONTROLLER FROM ANY POST OR SUPPORT	2.00	EACH	765.00		1,530.00
146	T-5.1 FURNISH AND INSTALL 2" RIGID UNDERGROUND CONDUIT IN UNPAVED ROADWAY	180.00	L.F.	48.00		8,640.00
147	T-5.18 FURNISH AND INSTALL 2" RIGID CONDUIT ON "ELEVATED" STRUCTURE	50.00	L.F.	129.00		6,450.00
148	T-5.2 FURNISH AND INSTALL 2" RIGID UNDERGROUND CONDUIT IN PAVED ROADWAY	20.00	L.F.	43.00		860.00
149	T-5.3 FURNISH AND INSTALL 2" RIGID UNDERGROUND CONDUIT IN PAVED SIDEWALK	20.00	L.F.	43.00		860.00

BID SCHEDULE FORM

COL 1 SEQ. NO	COL 2 ITEM NUMBER and DESCRIPTION	COL 3 ENGINEER'S ESTIMATE OF QUANTITY	COL 4 UNIT	COL 5 UNIT PRICE (IN FIGURES)		COL 6 EXTENDED AMOUNT (IN FIGURES)	
				DOLLARS	CTS	DOLLARS	CTS
150	T-5.32 RESTORING PERMANENT ROADWAY (INCLUDING SAWCUT)	20.00	L.F.		9.00		180.00
151	T-5.34 RESTORING PERMANENT SIDEWALK	20.00	S.F.		19.00		380.00
152	T-5.36 REMOVE CONDUIT FROM POST	40.00	L.F.		28.00		1,120.00
153	T-5.37 REMOVE CONDUIT FROM "ELEVATED" STRUCTURE	40.00	L.F.		38.00		1,520.00
154	T-6.10 REMOVE CABLE (INCLUDES OVERHEAD)	1,000.00	L.F.		5.00		5,000.00
155	T-6.11 REMOVE OVERHEAD CABLE AND SUPPORTS	300.00	L.F.		27.00		8,100.00

12/24/2014 12:00 AM

NEW YORK CITY DEPARTMENT OF DESIGN AND CONSTRUCTION
DIVISION OF INFRASTRUCTURE - BUREAU OF DESIGN

PROJECT ID: HWPEDSF1

CONTRACT PIN: 8502013HW0079C

BID SCHEDULE FORM

COL 1 SEQ. NO.	COL 2 ITEM NUMBER AND DESCRIPTION	COL 3 ENGINEER'S ESTIMATE OF QUANTITY	COL 4 UNIT	COL 5 UNIT PRICE (IN FIGURES) DOLLARS CTS.	COL 6 EXTENDED AMOUNT (IN FIGURES) DOLLARS CTS.
156	T-6.2 INSTALL MULTIPLE CABLE (INCLUDES OVERHEAD)	1,000.00	L.F.	10.00	10,000.00
157	T-6.3 INSTALL CABLE AND SUPPORTS ON STRUCTURE	300.00	L.F.	36.00	10,800.00
158	T-60000B FURNISH 2 c # 10B (SEE SPEC) (BREAKDOWN = 2#10 WITH 3RD WIRE FOR GROUNDING).	1,000.00	L.F.	2.00	2,000.00
159	T-60040 e) 7 CONDUCTOR, 14 A.W.G.	400.00	L.F.	1.50	600.00
160	T-60190 e) 13 CONDUCTOR, 14 A.W.G.	1,200.00	L.F.	2.60	3,120.00
161	T-7.47 REMOVE JUNCTION BOX	2.00	EACH	279.00	558.00

BID SCHEDULE FORM

COL 1 SEQ. NO	COL 2 ITEM NUMBER and DESCRIPTION	COL 3 ENGINEER'S ESTIMATE OF QUANTITY	COL 4 UNIT	COL 5 UNIT PRICE (IN FIGURES)		COL 6 EXTENDED AMOUNT (IN FIGURES)	
				DOLLARS	CTS	DOLLARS	CTS
162	T-8.10 RELOCATE CONCRETE PYLON WITH POST	3.00	EACH	1,525.00		4,575.00	00
163	T-8.8 INSTALL CONCRETE PYLON	3.00	EACH	1,354.00		4,062.00	00
164	T-8.9 REMOVE CONCRETE PYLON	3.00	EACH	760.00		2,280.00	00
165	T-8.1000 FURNISH CONCRETE PYLON	3.00	EACH	460.00		1,380.00	00

12/24/2014 12:00 AM

NEW YORK CITY DEPARTMENT OF DESIGN AND CONSTRUCTION
DIVISION OF INFRASTRUCTURE - BUREAU OF DESIGN

PROJECT ID: HWPEDSF1
CONTRACT PIN: 8502013HW0079C

BID SCHEDULE FORM

COL 1 SEQ. NO	COL 2 ITEM NUMBER and DESCRIPTION	COL 3 ENGINEER'S ESTIMATE OF QUANTITY	COL 4 UNIT	COL 5 UNIT PRICE (IN FIGURES) DOLLARS CTS	COL 6 EXTENDED AMOUNT (IN FIGURES) DOLLARS CTS
------------------	--------------------------------------	--	---------------	--	---

SUB-TOTAL: \$ 2,048,142.68

166	6.39 A MOBILIZATION BID PRICE OF MOBILIZATION SHALL NOT EXCEED 4% OF THE ABOVE SUB-TOTAL PRICE.	1.00	L.S.	81,925 62	81,925 62
-----	--	------	------	-----------	-----------

TOTAL BID PRICE: \$ 2,130,068.30

PLEASE BE SURE A LEGIBLE BID IS ENTERED FOR EACH ITEM.
THE BIDDER SHALL INSERT THE TOTAL BID PRICE IN
THE BID FORM ON PAGE C-4 OF THIS BID BOOKLET.

(NO TEXT ON THIS PAGE)

BID BOND 1
FORM OF BID BOND

KNOW ALL MEN BY THESE PRESENTS. That we,

J. Pizzirusso Landscaping Corp

7104 Avenue W

Brooklyn, NY 11234-6647

hereinafter referred to as the "Principal", and

Endurance American Insurance Company

750 Third Avenue, 2nd Floor

New York, NY 10017-9014

hereinafter referred to as the "Surety" are held and firmly bound to THE CITY OF NEW YORK, hereinafter referred to as the "CITY", or to its successors and assigns in the penal sum of Ten Percent (10%) of Total

Amount Bid ---- 2,130,068.30

(\$ 10% ----), Dollars lawful money of the United States, for the payment of which said sum of money well and truly to be made, we, and each of us, bind ourselves, our heirs, executors, administrators, successors and assigns, jointly and severally, firmly by these presents.

Whereas, the Principal is about to submit (or has submitted) to the City the accompanying proposal, hereby made a part hereof, to enter into a contract in writing for Multi-Site Pedestrian Safety - 31st St & 39th Ave.

NOW, THEREFORE, the conditions of this obligation are such that if the Principal shall not withdraw said Proposal without the consent of the City for a period of forty-five (45) days after the opening of bids and in the event of acceptance of the Principal's Proposal by the City, if the Principal shall:

(a) Within ten (10) days after notification by the City, execute in quadruplicate and deliver to the City all the executed counterparts of the Contract in the form set forth in the Contract Documents, in accordance with the proposal as accepted, and

(b) Furnish a performance bond and separate payment bond, as may be required by the City, for the faithful performance and proper fulfillment of such Contract, which bonds shall be satisfactory in all respects to the City and shall be executed by good and sufficient sureties, and

(c) In all respects perform the agreement created by the acceptance of said Proposal as provided in the Information for Bidders, bound herewith and made a part hereof, or if the City shall reject the aforesaid Proposal, then this obligation shall be null and void; otherwise to remain in full force and effect.

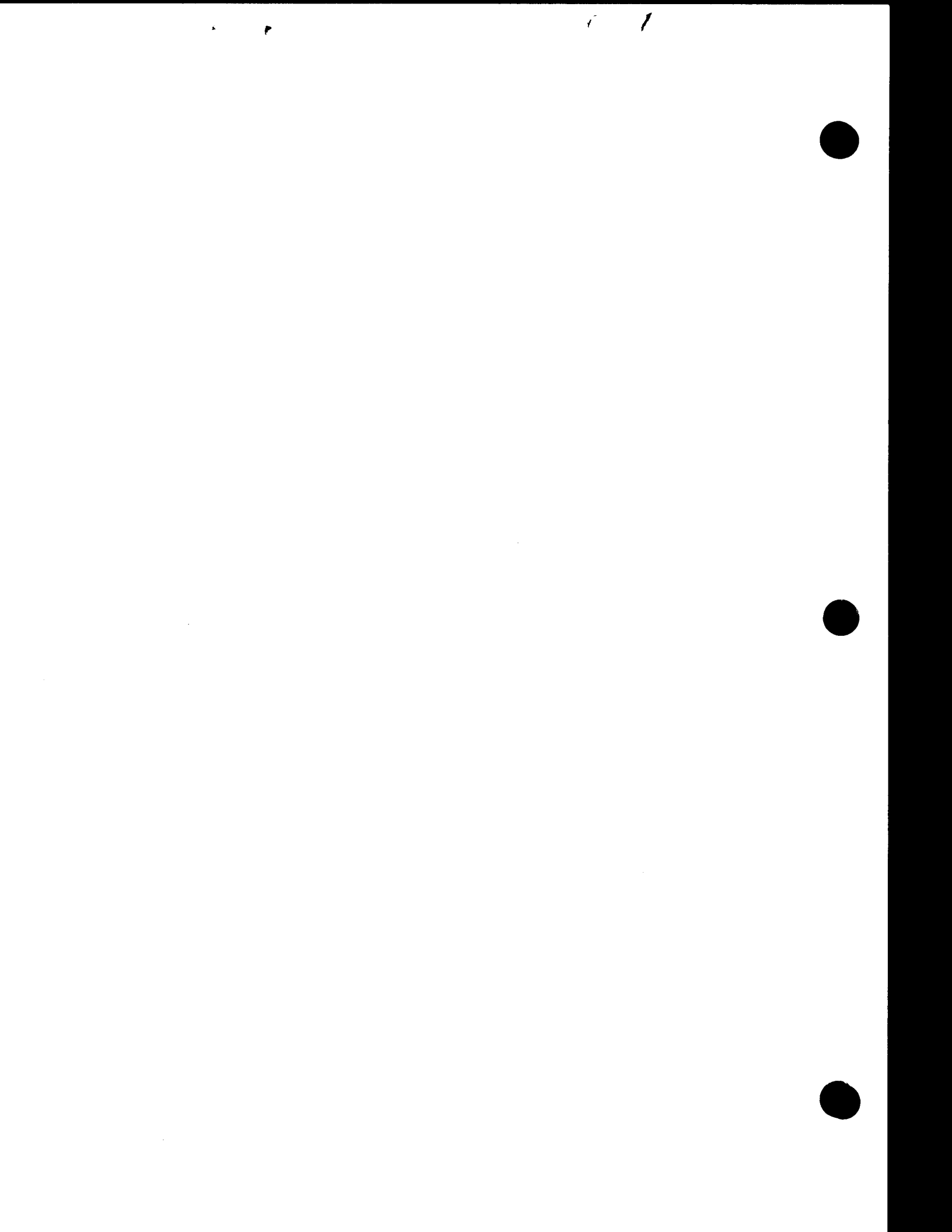

BID BOND 2

In the event that the Proposal of the Principal shall be accepted and the Contract be awarded to him the Surety hereunder agrees subject only to the payment by the Principal of the premium therefore, if requested by the City, to write the aforementioned performance and payment bonds in the form set forth in the Contract Documents.

It is expressly understood and agreed that the liability of the Surety for any and all claims hereunder shall in no event exceed the penal amount of this obligation as herein stated.

There shall be no liability under this bond if, in the event of the acceptance of the Principal's Proposal by the City, either a performance bond or payment bond, or both, shall not be required by the City on or before the 30th day after the date on which the City signs the Contract.

The surety, for the value received, hereby stipulates and agrees that the obligations of the Surety and its bond shall in no way be impaired or affected by any postponements of the date upon which the City will receive or open bids, or by any extensions of time within which the City may accept the Principal's Proposal, or by any waiver by the City of any of the requirements of the Information for Bidders, and the Surety hereby waives notice of any such postponements, extensions, or waivers.

IN WITNESS WHEREOF, the Principal and the Surety have hereunto set their hands and seals and such of them as are corporations have caused their corporate seals to be hereto affixed and these presents to be signed by their proper officers the 4th day of February, 2015.

(Seal)

J. Pizzirusso Landscaping Corp _____ (L.S.)
Principal

By: _____
Joseph Pizzirusso, Vice President

(Seal)

Endurance American Insurance Company _____
Surety

By: _____
Alissa J. Wolf, Attorney-in-Fact

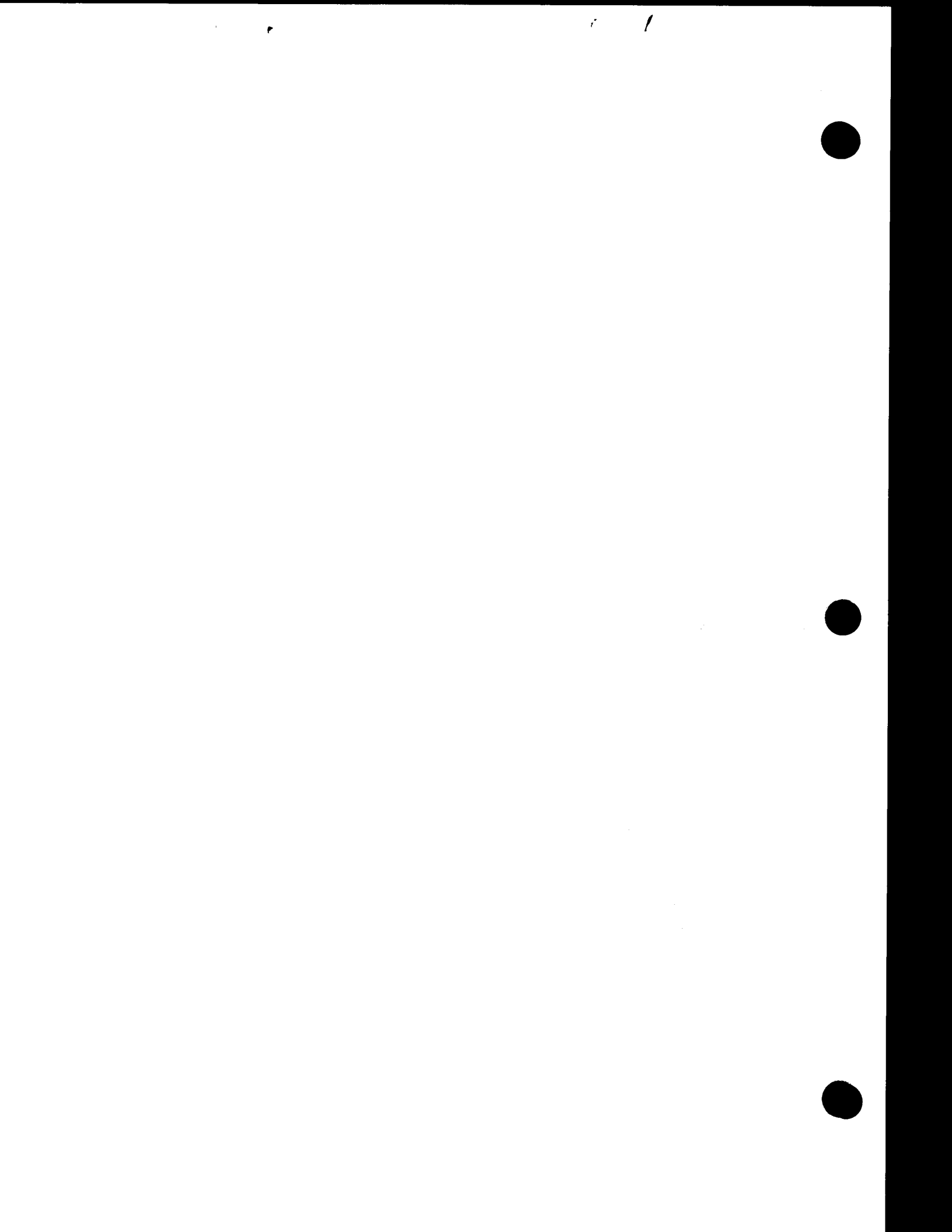

ACKNOWLEDGEMENT OF PRINCIPAL, IF A CORPORATION

State of New York County of _____ ss:
On this _____ day of February, 2015, before me personally came
Joseph Pizzirusso to me known, who, being by me duly sworn, did depose and say that he
resides at _____
that he is the Vice-President of J. Pizzirusso Landscaping Corp
the corporation described in and which executed the foregoing instrument; that he knows the seal of said
corporation; that one of the seals affixed to said instrument is such seal; that it was so affixed by order of the
directors of said corporation, and that he signed his name thereto by like order.

Claire M Conteduca
Notary Public State of New York
Kings County
No. 01C06201485
Commission Expires March 2, 17

Notary Public

ACKNOWLEDGEMENT OF PRINCIPAL, IF A PARTNERSHIP

State of _____ County of _____ ss:
On this _____ day of _____, _____, before me personally appeared
_____ to me known and known to me to be one of the members of the firm of
_____ described in and who executed the foregoing instrument, and he
acknowledged to me that he executed the same as and for the act and deed of said firm.

Notary Public

ACKNOWLEDGEMENT OF PRINCIPAL, IF AN INDIVIDUAL

State of _____ County of _____ ss:
On this _____ day of _____, _____, before me personally appeared
_____ to me known and known to me to be the person described in and who
executed the foregoing instrument and acknowledged that he executed the same.

Notary Public

AFFIX ACKNOWLEDGEMENTS AND JUSTIFICATION OF SURETIES



ACKNOWLEDGEMENT OF SURETY

STATE OF New York)
COUNTY OF Erie) ss
CITY OF BUFFALO)

On this 4th day of February in the year 2015 before me personally came Alissa J. Wolf , to me known, who, being by me duly sworn, did depose and say that he/she/they reside (s) Buffalo, NY , that he/she/they (is) (are) the Attorney- in -Fact duly appointed of the Endurance American Insurance Company the corporation described in and which executed the above instrument; that he/she/they know(s) the seal of said corporation; that the seal affixed to said instrument is such corporate seal; that it was so affixed by authority of the board of directors of said corporation, and that he/she/they signed his/her/their name(s) thereto by like authority.

COLLEEN A KENDZIORA
NOTARY PUBLIC STATE OF NEW YORK
ERIE COUNTY
COMM. EXP. 03/23/20 19

Colleen A. Kendziora
NOTARY PUBLIC

OFFICE OF THE
ATTORNEY GENERAL
STATE OF NEW YORK
ALBANY, N. Y.

POWER OF ATTORNEY

Know all Men by these Presents, that ENDURANCE AMERICAN INSURANCE COMPANY, a Delaware corporation (the "Corporation"), with offices at 750 Third Avenue, New York, New York 10017, has made, constituted and appointed and by these presents, does make, constitute and appoint

LORIANN FAY, TIMOTHY M. TOOLE, VICTORIA RIVERA, ALISSA J. WOLF

its true and lawful Attorney(s)-in-fact, at BUFFALO in the State of NY and each of them to have full power to act without the other or others, to make, execute, seal and deliver for and on its behalf bonds, undertakings or obligations in surety or co-surety with others, also to execute and deliver on its behalf renewals, extensions, agreements, waivers, consents or stipulations relating to such aforesaid bonds, undertakings or obligations provided, however, that no single bond or undertaking so made, executed and delivered shall obligate the Corporation for any portion of the penal sum thereof in excess of the sum of SEVEN MILLION FIVE HUNDRED THOUSAND Dollars (\$7,500,000.00).

Such bonds and undertakings for said purposes, when duly executed by said attorney(s)-in-fact, shall be binding upon the Corporation as fully and to the same extent as if signed by the President of the Corporation under its corporate seal attested by its Corporate Secretary.110

This appointment is made under and by authority of certain resolutions adopted by the Board of Directors of the Corporation by unanimous written consent on the 21st day of July, 2011, a copy of which appears below under the heading entitled "Certificate".

110
This Power of Attorney is signed and sealed by facsimile under and by authority of the following resolution adopted by the Board of Directors of the Corporation by unanimous written consent on the 21st day of July, 2011 and said resolution has not since been revoked, amended or repealed:

RESOLVED, that in granting powers of attorney pursuant to certain resolutions adopted by the Board of Directors of the Corporation by unanimous written consent on the 21st day of July, 2011, the signature of such directors and officers and the seal of the Corporation may be affixed to any such power of attorney or any certificate relating thereto by facsimile, and any such power of attorney or certificate bearing such facsimile signature or seal shall be valid and binding upon the Corporation in the future with respect to any bond or undertaking to which it is attached.

This Power of Attorney shall expire and all authority hereunder shall terminate without notice at 12:01 a.m. (Standard Timer where said attorney(s)-in-fact is authorized to act.)
OCTOBER 29, 2015

IN WITNESS WHEREOF, the Corporation has caused these presents to be duly signed and its corporate seal to be hereunto affixed and attested this 3RD day of OCTOBER, 2014 at New York, New York.
(Corporate Seal)

ENDURANCE AMERICAN INSURANCE COMPANY

ATTEST
Alfred N. Wright, Senior Vice President

By
Ronald Diggs, Vice President

STATE OF NEW YORK
COUNTY OF NEW YORK
ss: MANHATTAN

On the 3RD day of OCTOBER, 2014 before me personally came RONALD DIGGS to me known, who being by me duly sworn, did depose and say that (s)he resides in HELLETTOWN, PENNSYLVANIA that (s)he is a VICE PRESIDENT of ENDURANCE AMERICAN INSURANCE COMPANY, the corporation described in and which executed the above instrument; that (s)he knows the seal of said corporation; that the seal affixed to said instrument is such corporate seal; that it was so affixed by order of the Board of Directors of said corporation, and that (s)he signed his (her) name thereto by like order.
(Notarial Seal)

.....
Anie Licari, Notary Public - My Commission Expires: October 29, 2015

CERTIFICATE

STATE OF NEW YORK
COUNTY OF NEW YORK
ss: MANHATTAN

I, Doug Worman, the Chief Executive Officer of ENDURANCE AMERICAN INSURANCE COMPANY, a Delaware Corporation (the "Corporation"), hereby certify:

- 1. That the original power of attorney of which the foregoing is a copy was duly executed on behalf of the Corporation and has not since been revoked, amended or modified; that the undersigned has compared the foregoing copy thereof with the original power of attorney, and that the same is a true and correct copy of the original power of attorney and of the whole thereof;
- 2. The following are resolutions which were adopted by the Board of Directors of the Corporation by unanimous written consent on the 21st day of July, 2011 and said resolutions have not since been revoked, amended or modified:

"RESOLVED, that each of the individuals named below is authorized to make, execute, seal and deliver for and on behalf of the Corporation any and all bonds, undertakings or obligations in surety or co-surety with others and to execute and deliver for and on behalf of the Corporation renewals, extensions, agreements, waivers, consents or stipulations relating to such aforesaid bonds, undertakings or obligations:

ALFRED N. WRIGHT, RONALD DIGGS

And

RESOLVED FURTHER, that each of the individuals named above is authorized to appoint attorneys-in-fact for the purpose of making, executing, sealing and delivering bonds, undertakings or obligations in surety or co-surety for and on behalf of the Corporation.

- 3. The undersigned further certifies that the above resolutions are true and correct copies of the resolutions as so recorded and of the whole thereof.

IN WITNESS WHEREOF, I have hereunto set my hand and affixed the corporate seal this 14th day of February, 2015.

.....
Doug Worman, Chief Executive Officer of U.S. Insurance

ENDURANCE AMERICAN INSURANCE COMPANY

Balance Sheet - Statutory - Basis

December 31, 2013

Assets:

Bonds	\$	277,960,234
Common stocks		92,821,239
Cash		81,252,414
Receivable for securities		<u>10,473,849</u>
Total, cash and invested assets		462,507,736

Agents' balances		639,892,014
Reinsurance recoverable on loss and loss adjustment expense payments		204,937,779
Funds held by or deposited with reinsures companies		4,455,680
Investment income due and accrued		1,277,293
Receivables from parent and affiliates		<u>718,976</u>
Total admitted assets	\$	<u>1,313,789,478</u>

Liabilities:

Loss and loss adjustment expenses	\$	220,360,070
Reinsurance payable on paid loss and loss adjustment expenses		403,424,215
Unearned premiums		78,153,735
Ceded reinsurance premiums payable		324,020,849
Funds held by company under reinsurance treaties		5,604,760
Provision for reinsurance		3,027,000
Payable to parent, subsidiary and affiliates		6,119,752
Payable for securities		22,619,701
Other liabilities		<u>2,972,307</u>
Total liabilities		1,066,302,389

Capital and surplus:

Common capital stock		6,000,000
Gross paid in and contributed surplus		531,153,297
Unassigned funds (surplus)		<u>(289,666,208)</u>
Total capital and surplus		247,487,089

Total liabilities, capital and surplus	\$	<u>1,313,789,478</u>
--	----	----------------------

I, Stan Osofsky, Treasurer of Endurance American Insurance Company (the "Company") do hereby certify that to the best of my knowledge and belief, the foregoing is a full and true Statutory Statement of Admitted Assets, Liabilities, Capital and Surplus of the Company as of December 31, 2013 prepared in conformity with accounting practices prescribed or permitted by the State of Delaware Department of Insurance. The foregoing statement should not be taken as a complete statement of financial condition of the Company. Such a statement is available upon request at the Company's office located at 333 Westchester Avenue, White Plains, NY 10604.

IN WITNESS WHEREOF, I have hereunto set my hand and affixed the seal of the Company at New York, New York.



Stan Osofsky

Subscribed and sworn to before me this 7th day of April 2014

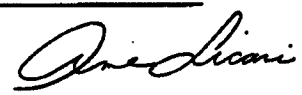

ANE LICARI
Notary Public, State of New York
No. 0118178502
Qualified in Kings County
Term Expires October 29, 2018



ATTACH TO CONTRACT DOCUMENTS

THE CITY OF NEW YORK
DEPARTMENT OF DESIGN AND CONSTRUCTION
INFRASTRUCTURE DIVISION
BUREAU OF DESIGN

PROJECT ID: HWPEDSF1

MULTI-SITE PEDESTRIAN SAFETY
WHICH INCLUDES THE FOLLOWING INTERSECTIONS:

31ST STREET AND 39TH AVENUE
31ST STREET AND 36TH AVENUE
31ST STREET AND BROADWAY

INCLUDING BUS BULBOUTS, CURB EXTENSIONS, BUS PADS,
PEDESTRIAN RAMPS, CATCH BASINS, PAVEMENT MARKINS,
STREET LIGHTING, AND TRAFFIC SIGNAL WORK

Together With All Work Incidental Thereto
BOROUGH OF QUEENS

ADDENDUM NO. 5

DATED: January 8, 2015

THIS ADDENDUM IS HEREBY MADE A PART OF THE CONTRACT DOCUMENTS

1. Refer to the Bid and Contract Documents, Volume 3 of 3, Addendum No. 1, SECTION 7.50 ST on pages A1-5 through A1-7; Delete SECTION 7.50 ST, on pages A1-5 through A1-7, in its entirety; Substitute the new SECTION 7.50 CB as contained on the attached pages A1-5R through A1-7R.

END OF ADDENDUM NO. 5

By signing in the space provided below, the bidder acknowledges receipt of this Addendum consisting of one (1) page and three (3) pages of attachments.

THIS ADDENDUM MUST BE SIGNED BY ALL BIDDERS AND ATTACHED TO THEIR BID

MOHSEN ZARGARELAHI, P.E.
Assistant Commissioner

J. Pizzitello Landscaping Corp
Name of Bidder

By: 

ATTACH TO CONTRACT DOCUMENTS

THE CITY OF NEW YORK
DEPARTMENT OF DESIGN AND CONSTRUCTION
INFRASTRUCTURE DIVISION
BUREAU OF DESIGN

PROJECT ID: HWPEDSF1

MULTI-SITE PEDESTRIAN SAFETY
WHICH INCLUDES THE FOLLOWING INTERSECTIONS:

31ST STREET AND 39TH AVENUE
31ST STREET AND 36TH AVENUE
31ST STREET AND BROADWAY

INCLUDING BUS BULBOUTS, CURB EXTENSIONS, BUS PADS,
PEDESTRIAN RAMPS, CATCH BASINS, PAVEMENT MARKINS,
STREET LIGHTING, AND TRAFFIC SIGNAL WORK

Together With All Work Incidental Thereto
BOROUGH OF QUEENS

ADDENDUM NO. 6

DATED: January 23, 2015

THIS ADDENDUM IS HEREBY MADE A PART OF THE CONTRACT DOCUMENTS

1. Refer to the Bid and Contract Documents, VOLUME 1 OF 3, Attachment 1 - Bid Information on Page A-1;
Change the dates shown for Submission of Bids and for Bid Opening from "JANUARY 28, 2015" to read "FEBRUARY 6, 2015".

END OF ADDENDUM NO. 6

By signing in the space provided below, the bidder acknowledges receipt of this Addendum consisting of one (1) page.

THIS ADDENDUM MUST BE SIGNED BY ALL BIDDERS AND ATTACHED TO THEIR BID

J. Pizzarello Landscaping Corp
Name of Bidder

By: [Signature]

[Signature]
MOHSEN ZARGARELAHI, P.E.
Assistant Commissioner

A6-1



ATTACH TO CONTRACT DOCUMENTS

THE CITY OF NEW YORK
DEPARTMENT OF DESIGN AND CONSTRUCTION
INFRASTRUCTURE DIVISION
BUREAU OF DESIGN

PROJECT ID: HWPEDSF1

MULTI-SITE PEDESTRIAN SAFETY
WHICH INCLUDES THE FOLLOWING INTERSECTIONS:

31ST STREET AND 39TH AVENUE
31ST STREET AND 36TH AVENUE
31ST STREET AND BROADWAY

INCLUDING BUS BULBOUTS, CURB EXTENSIONS, BUS PADS,
PEDESTRIAN RAMPS, CATCH BASINS, PAVEMENT MARKINS,
STREET LIGHTING, AND TRAFFIC SIGNAL WORK

Together With All Work Incidental Thereto
BOROUGH OF QUEENS

ADDENDUM NO. 7

DATED: January 28, 2015

THIS ADDENDUM IS HEREBY MADE A PART OF THE CONTRACT DOCUMENTS

1. Refer to the Bid and Contract Documents, Volume 3 of 3, SCHEDULE A, Page SA-2, third box down titled "CONTRACT ARTICLE 24, PERIOD OF GUARANTEE";
Change the word "Eighteen" to read "Twelve" in the box to the right.

END OF ADDENDUM NO. 7

By signing in the space provided below, the bidder acknowledges receipt of this Addendum consisting of one (1) page.

THIS ADDENDUM MUST BE SIGNED BY ALL BIDDERS AND ATTACHED TO THEIR BID

MOHSEN ZARGARELAHI, P.E.
Assistant Commissioner

J. Lizzadro Landscaping Corp.
Name of Bidder

By: 



Tax ID #: _____

**SCHEDULE B – M/WBE Utilization Plan
Part I: M/WBE Participation Goals**

Part I to be completed by contracting agency

Contract Overview

APT E- Pin # 85015B0051 FMS Project ID#: HWPEDSF1
 Project Title/ Agency PIN # MULTI-SITE PEDESTRIAN SAFETY / 8502013HW0079C
 Bid/Proposal Response Date _____
 Contracting Agency Department of Design and Construction
 Agency Address 30-30 Thomson Ave. City Long Island City State NY Zip Code 11101
 Contact Person Jessica Lavides Title MWBE Liaison & Compliance Analyst
 Telephone # (718) 391-1065 Email LavidesJe@ddc.nyc.gov

Project Description (attach additional pages if necessary)

**MULTI-SITE PEDESTRIAN SAFETY
WHICH INCLUDES THE FOLLOWING INTERSECTIONS:**

31ST STREET AND 39TH AVENUE
 31ST STREET AND 36TH AVENUE
 31ST STREET AND BROADWAY

INCLUDING BUS BULBOUTS, CURB EXTENSIONS, BUS PADS,
 PEDESTRIAN RAMPS, CATCH BASINS, PAVEMENT MARKINGS,
 STREET LIGHTING, AND TRAFFIC SIGNAL WORK

Together With All Work Incidental Thereto
 BOROUGH OF QUEENS
 CITY OF NEW YORK

M/WBE Participation Goals for Services

Enter the percentage amount for each group or for an unspecified goal. Please note that there are no goals for Asian Americans in Professional Services.

Prime Contract Industry: Construction

Group	Percentage
<u>Unspecified*</u>	<u>EXEMPT %</u>
or	
Black American	UNSPECIFIED*
Hispanic American	UNSPECIFIED*
Asian American	UNSPECIFIED*
Women	UNSPECIFIED*
Total Participation Goals	EXEMPT % Line 1

**Note: For this procurement, individual ethnicity and gender goals are not specified. The Total Participation Goal for construction contracts may be met by using either Black-American, Hispanic-American, Asian American, or Women certified firms or any combination of such firms.*



Tax ID #: _____

APT E-
PIN #: _____

SCHEDULE B - Part II: M/WBE Participation Plan

Part II to be completed by the bidder/proposer.

Please note: For Non-M/WBE Prime Contractors who will NOT subcontract any services and will self-perform the entire contract, you must obtain a FULL waiver by completing the Waiver Application on pages 17 and 18 and timely submitting it to the contracting agency pursuant to the Notice to Prospective Contractors. Once a FULL WAIVER is granted, it must be included with your bid or proposal and you do not have to complete or submit this form with your bid or proposal.

Section I: Prime Contractor Contact Information

Tax ID #	_____	FMS Vendor ID #	_____
Business Name	_____	Contact Person	_____
Address	_____		
Telephone #	_____	Email	_____

Section II: M/WBE Utilization Goal Calculation: Check the applicable box and complete subsection.

PRIME CONTRACTOR ADOPTING AGENCY M/WBE PARTICIPATION GOALS

<input type="checkbox"/> For Prime Contractors (including Qualified Joint Ventures and M/WBE firms) adopting Agency M/WBE Participation Goals. Calculate the total dollar value of your total bid that you agree will be awarded to M/WBE subcontractors for services and/or credited to an M/WBE prime contractor or Qualified Joint Venture. Please review the Notice to Prospective Contractors for more information on how to obtain credit for M/WBE participation.	Total Bid/Proposal Value	Agency Total Participation Goals (Line 1, Page 13)	Calculated M/WBE Participation Amount
	\$ _____	X _____	= \$ Line 2

PRIME CONTRACTOR OBTAINED PARTIAL WAIVER APPROVAL: ADOPTING MODIFIED M/WBE PARTICIPATION GOALS

<input type="checkbox"/> For Prime Contractors (including Qualified Joint Ventures and M/WBE firms) adopting Modified M/WBE Participation Goals. Calculate the total dollar value of your total bid that you agree will be awarded to M/WBE subcontractors for services and/or credited to an M/WBE prime contractor or Qualified Joint Venture. Please review the Notice to Prospective Contractors for more information on how to obtain credit for M/WBE participation.	Total Bid/Proposal Value	Adjusted Participation Goal (From Partial Waiver)	Calculated M/WBE Participation Amount
	\$ _____	X _____	= \$ Line 3



Section III: M/WBE Utilization Plan: How Proposer/Bidder Will Fulfill M/WBE Participation Goals. Please review the Notice to Prospective Contractors for more information on how to obtain credit for M/WBE participation. Check applicable box. The Proposer or Bidder will fulfill the M/WBE Participation Goals:

As an M/WBE Prime Contractor that will self-perform and/or subcontract to other M/WBE firms a portion of the contract the value of which is at least the amount located on Lines 2 or 3 above, as applicable. The value of any work subcontracted to non-M/WBE firms will not be credited towards fulfillment of M/WBE Participation Goals. Please check all that apply to Prime Contractor:

MBE WBE

As a Qualified Joint Venture with an M/WBE partner, in which the value of the M/WBE partner's participation and/or the value of any work subcontracted to other M/WBE firms is at least the amount located on Lines 2 or 3 above, as applicable. The value of any work subcontracted to non M/WBE firms will not be credited towards fulfillment of M/WBE Participation Goals.

As a non M/WBE Prime Contractor that will enter into subcontracts with M/WBE firms the value of which is at least the amount located on Lines 2 or 3 above, as applicable.

Section IV: General Contract Information

What is the expected percentage of the total contract dollar value that you expect to award in subcontracts for services, regardless of M/WBE status? % _____

Enter brief description of the type(s) and dollar value of subcontracts for all any services you plan subcontracting if awarded this contract. For each item, indicate whether the work is designated for participation by MBEs and/or WBEs and the time frame in which such work is scheduled to begin and end. Use additional sheets if necessary.

- 1. _____
- 2. _____
- 3. _____
- 4. _____
- 5. _____
- 6. _____
- 7. _____
- 8. _____
- 9. _____
- 10. _____
- 11. _____
- 12. _____
- 13. _____
- 14. _____
- 15. _____
- 16. _____
- 17. _____

✓ Scopes of Subcontract Work



Tax ID #: _____

APT E-
PIN #: _____

Section V: Vendor Certification and Required Affirmations

I hereby:

- 1) acknowledge my understanding of the M/WBE participation requirements as set forth herein and the pertinent provisions of Section 6-129 of the Administrative Code of the City of New York ("Section 6-129"), and the rules promulgated thereunder;*
- 2) affirm that the information supplied in support of this M/WBE Utilization Plan is true and correct;*
- 3) agree, if awarded this Contract, to comply with the M/WBE participation requirements of this Contract, the pertinent provisions of Section 6-129, and the rules promulgated thereunder, all of which shall be deemed to be material terms of this Contract;*
- 4) agree and affirm that it is a material term of this Contract that the Vendor will accept the total dollar value of the M/WBE Participation Goals to certified MBEs and/or WBEs, or a partial waiver obtained or such goals are modified by the Agency; and*
- 5) agree and affirm, if awarded this Contract, to make all reasonable, good faith efforts to meet the M/WBE Participation Goals, or if a partial waiver is obtained or such goals are modified by the Agency, to meet the modified Participation Goals by soliciting and obtaining the participation of certified MBE and/or WBE firms.*

Signature _____
Print Name _____ Title _____



SCHEDULE B – PART III – REQUEST FOR WAIVER OF M/WBE PARTICIPATION REQUIREMENT

Contract Overview

Tax ID # _____ FMS Vendor ID # _____
 Business Name _____
 Contact Name _____ Telephone # _____ Email _____
 Type of Procurement Competitive Sealed Bids Other _____ Bid/Response Due Date _____
 APT E-PIN # (for this procurement): _____ Contracting Agency: _____

M/WBE Participation Goals as described in bid/solicitation documents

_____ % Agency M/WBE Participation Goal

Proposed M/WBE Participation Goal as anticipated by vendor seeking waiver

_____ % of the total contract value anticipated in good faith by the bidder/proposer to be subcontracted for services and/or credited to an M/WBE Prime Contractor or Qualified Joint Venture.

Basis for Waiver Request: Check appropriate box & explain in detail below (attach additional pages if needed)

- Vendor does not subcontract services, and has the capacity and good faith intention to perform all such work itself with its own employees.
- Vendor subcontracts some of this type of work but at a lower % than bid/solicitation describes, and has the capacity and good faith intention to do so on this contract. (Attach subcontracting plan outlining services that the vendor will self-perform and subcontract to other vendors or consultants.)
- Vendor has other legitimate business reasons for proposing the M/WBE Participation Goal above. Explain under separate cover.

References

List 3 most recent contracts performed for NYC agencies (if any). Include information for each subcontract awarded in performance of such contracts. Add more pages if necessary.

CONTRACT NO.	AGENCY	DATE COMPLETED
Total Contract Amount \$ _____	Total Amount Subcontracted \$ _____	
Item of Work Subcontracted and Value of subcontract _____	Item of Work Subcontracted and Value of subcontract _____	Item of Work Subcontracted and Value of subcontract _____
CONTRACT NO.	AGENCY	DATE COMPLETED
Total Contract Amount \$ _____	Total Amount Subcontracted \$ _____	
Item of Work Subcontracted and Value of subcontract _____	Item of Work Subcontracted and Value of subcontract _____	Item of Work Subcontracted and Value of subcontract _____
CONTRACT NO.	AGENCY	DATE COMPLETED
Total Contract Amount \$ _____	Total Amount Subcontracted \$ _____	
Item of Work Subcontracted and Value of subcontract _____	Item of Work Subcontracted and Value of subcontract _____	Item of Work Subcontracted and Value of subcontract _____



List 3 most recent contracts performed for other entities. Include information for each subcontract awarded in performance of such contracts. Add more pages if necessary.

Complete ONLY if vendor has performed fewer than 3 New York City contracts.)

TYPE OF Contract _____ ENTITY _____ DATE COMPLETED _____
 Manager at entity that hired vendor (Name/Phone No./Email) _____
 Total Contract Amount \$ _____ Total Amount Subcontracted \$ _____
 Type of Work Subcontracted _____

TYPE OF Contract _____ AGENCY/ENTITY _____ DATE COMPLETED _____
 Manager at agency/entity that hired vendor (Name/Phone No./Email) _____
 Total Contract Amount \$ _____ Total Amount Subcontracted \$ _____
 Item of Work Subcontracted and Value of subcontract _____ Item of Work Subcontracted and Value of subcontract _____

TYPE OF Contract _____ AGENCY/ENTITY _____ DATE COMPLETED _____
 Manager at entity that hired vendor (Name/Phone No./Email) _____
 Total Contract Amount \$ _____ Total Amount Subcontracted \$ _____
 Item of Work Subcontracted and Value of subcontract _____ Item of Work Subcontracted and Value of subcontract _____

VENDOR CERTIFICATION: I hereby affirm that the information supplied in support of this waiver request is true and correct, and that this request is made in good faith.

Signature: _____ Date: _____
 Print Name: _____ Title: _____

Shaded area below is for agency completion only

AGENCY CHIEF CONTRACTING OFFICER APPROVAL
 Signature: _____ Date: _____

CITY CHIEF PROCUREMENT OFFICER APPROVAL
 Signature: _____ Date: _____

Waiver Determination:
 Full Waiver Approved
 Waiver Denied
 Partial Waiver Approved
 Revised Participation Goals



GET UPFRONT CAPITAL TO COMPETE ON CITY CONTRACTS



Contract Financing for NYC Small Businesses

NYC Business Solutions helps small businesses, including Minority or Women-owned Business Enterprises (M/WBEs), across all industries secure low-rate loans to compete on City contracts.

Whether your firm has been selected to perform a construction project, provide professional services, or supply the City with goods, businesses across all industries can access up to \$150,000 in capital to cover contract-related labor and equipment costs.

The ideal business should:

- Currently be in operation
- Have plans to bid on a City contract
- Need early-stage resources (e.g. working capital, inventory, or equipment)

Call 311 and ask for “contract financing” or visit www.nyc.gov/contractfinancing for more information

(NO TEXT ON THIS PAGE)

CITY OF NEW YORK

**DEPARTMENT OF
DESIGN AND CONSTRUCTION
DIVISION OF INFRASTRUCTURE**

BID BOOKLET

FOR FURNISHING ALL LABOR AND MATERIALS
NECESSARY AND REQUIRED FOR:

PROJECT ID: HWPEDSF1

**MULTI-SITE PEDESTRIAN SAFETY
WHICH INCLUDES THE FOLLOWING INTERSECTIONS:**

**31ST STREET AND 39TH AVENUE
31ST STREET AND 36TH AVENUE
31ST STREET AND BROADWAY**

**INCLUDING BUS BULBOUTS, CURB EXTENSIONS, BUS PADS,
PEDESTRIAN RAMPS, CATCH BASINS, PAVEMENT MARKINS,
STREET LIGHTING, AND TRAFFIC SIGNAL WORK**

**Together With All Work Incidental Thereto
BOROUGH OF QUEENS
CITY OF NEW YORK**

(NO TEXT ON THIS PAGE)

**CITY OF NEW YORK
DEPARTMENT OF DESIGN AND CONSTRUCTION
DIVISION OF INFRASTRUCTURE**

BID BOOKLET

TABLE OF CONTENTS

SECTION	PAGE
PART A	
1. Table of Contents.....	1
2. Special Notice to Bidders.....	2
3. Attachment 1 – Bid Information.....	A-1
4. Bid Schedule.....	B-1
5. Bid Form.....	C-1
6. Affirmation.....	C-6
7. Bid Bond	C-7
8. M/WBE Program: M/WBE Utilization Plan.....	5
9. Apprenticeship Program Requirements	19
PART B	
10. Safety Questionnaire	21
11. Pre-award Process.....	24
12. Project Reference Form.....	26
13. Contract Certificate.....	29
14. Vendex Compliance.....	30
15. Iran Divestment Act Compliance Rider	31
16. Construction Employment Report.....	33

(NO TEXT ON THIS PAGE)

**CITY OF NEW YORK
DEPARTMENT OF DESIGN AND CONSTRUCTION
DIVISION OF INFRASTRUCTURE**

SPECIAL NOTICE TO BIDDERS

BID SUBMISSION REQUIREMENTS

THE FOLLOWING DOCUMENTS ARE TO BE COMPLETED AND SUBMITTED WITH THE BID:

1. Bid Schedule and Bid Form, including Affirmation
2. Bid Security (if required, see Attachment 1 on Page A-1)
3. ~~Schedule B: M/WBE Utilization Plan (if participation goals have been established)~~

**FAILURE TO SUBMIT ITEMS (1), (2) AND (3)
WILL RESULT IN THE DISQUALIFICATION OF THE BID.**

4. Safety Questionnaire
5. Construction Employment Report (if bid is \$1,000,000 or more)
6. Contract Certificate (if bid is less than \$1,000,000)
7. Confirmation of Vendex Compliance
8. Bidder's Certification of Compliance with Iran Divestment Act
9. Special Experience Requirements (if applicable)
10. Apprenticeship Program Questionnaire (if applicable)
11. Any addenda issued prior to the receipt of bids

**FAILURE TO SUBMIT ITEMS (4) THROUGH (11)
MAY RESULT IN THE DISQUALIFICATION OF THE BID.**

NOTES:

- (1) All of the above referred to blank forms to be completed and submitted with the bid are included in the BID BOOKLET.
- (2) If the bidder has any questions or requires additional information, please contact the Department of Design and Construction by phone (718-391- 2601) or by fax (718-391-2615).
- (3) **VENDEX QUESTIONNAIRES:** The Bidder is advised that Vendex Questionnaires and procedures have been changed. Vendex Questionnaires, as well as detailed instructions, may be obtained at www.nyc.gov/vendex. The bidder may also obtain Vendex forms and instructions by contacting the Agency Chief Contracting Officer or the contact person for this contract.
- (4) **SPECIAL EXPERIENCE REQUIREMENTS:** The Bidder is advised that Special Experience Requirements may apply to this contract. Such requirements are set forth on pages 3, 3a, 3b, and 4 of this Bid Booklet.
- (5) Apparent low bidder, as determined at the bid opening or subsequently notified that its firm is the low Bidder, will be required to submit within 7 days a complete DBE Pre-Award Utilization Package in compliance with SECTION 102-12H of the NEW YORK STATE DEPARTMENT OF TRANSPORTATION STANDARD SPECIFICATIONS using the approved civil rights reporting software called EBO.

SPECIAL NOTICE TO BIDDERS

SPECIAL EXPERIENCE REQUIREMENTS (Revised 03/2014)

- (A) **SPECIAL EXPERIENCE REQUIREMENTS FOR THE BIDDER:** The Special Experience Requirements set forth below apply to the bidder. Compliance with such Special Experience Requirements will be determined solely by the City prior to an award of contract. Failure to comply with the Special Experience Requirements will result in rejection of the bid as non-responsive.

The requirements in this Section (A) apply to this contract where indicated by a blackened box (■).

- The bidder must, within the last seven (7) consecutive years prior to the bid opening, have successfully completed in a timely fashion at least one (1) project similar in scope and type to the required work. Such prior project may have been performed as a prime contractor, subcontractor or sub-subcontractor.

The Special Experience Requirements next to the blackened box below apply to the bidder. If the bidder intends to perform such work itself, it must demonstrate compliance with the Special Experience Requirements. If the bidder intends to subcontract this work, the proposed subcontractor or sub-subcontractor must demonstrate compliance with the Special Experience Requirements. The contractor, subcontractor or sub-subcontractor (hereinafter referred to as the "entity") that will perform any specific area of work indicated by the blackened box below, may have performed the required prior project(s) as a prime contractor, subcontractor or sub-subcontractor. Once approved, no substitution will be permitted, unless the qualifications of the proposed replacement have been approved in writing in advance by the City.

- Trunk Water Main Work:** The entity that will perform the trunk water main work must, within the last seven (7) consecutive years prior to the bid opening, have successfully completed in a timely fashion at least one (1) project similar in scope and type to the required work.
- Best Management Practice Work:** Best Management Practice ("BMP") Work is any item of work in the Bid Schedule that begins with the prefix "BMP". The entity that will perform any BMP Work must, within the last five (5) consecutive years prior to the bid opening, have successfully completed in a timely fashion at least three (3) projects similar in scope and type to the required work.

For professional services in connection with BMP Work, (i.e., monitoring and reporting services), the individual who will perform the required services must, within the last five (5) consecutive years prior to the bid opening, have successfully completed in a timely fashion at least three (3) projects similar in scope and type to the required work. Additional requirements are set forth below.

- The individual serving as the Restoration Specialist (Construction Monitor) must be a Registered Landscape Architect licensed by the state of New York, or must have equivalent professional experience.
- The individual serving as the Erosion and Sediment Control Licensed/Certified Professional must be a Certified Professional in Erosion and Sediment Control (CPESC), certified by CPESC, Inc.
- Micro-Tunneling/Pipe Jacking Work:** The entity that will perform the micro-tunneling/pipe jacking work must, within the last five (5) consecutive years prior to the bid opening, have successfully completed in a timely fashion at least two (2) projects similar in scope and type to the required work.

- OTHER:** _____

(B) **SPECIAL EXPERIENCE REQUIREMENTS FOR SPECIFIC AREAS OF WORK (to be provided after an award of contract):**

The requirements in this Section (B) apply to this contract where indicated by a blackened box (■).

The Special Experience Requirements set forth below apply to the contractor, subcontractor or sub-subcontractor that will perform the specific area of work. **Compliance with such Special Experience Requirements will be determined solely by the City after an award of contract.** After an award of contract, when requested by the City, the contractor will be required to submit the qualifications of the contractor, subcontractor or sub-subcontractor that will perform the specific area of work. If the bidder intends to perform such work itself, it must demonstrate compliance with the Special Experience Requirements. If the bidder intends to subcontract this work, the proposed subcontractor or sub-subcontractor must demonstrate compliance with the Special Experience Requirements. Once approved, no substitution will be permitted, unless the qualifications of the proposed replacement have been approved in writing in advance by the City.

Special Experience Requirements apply to the contractor, subcontractor or sub-subcontractor (hereinafter referred to as the "entity") that will perform any specific area of work indicated by a blackened box. The entity may have performed the required prior project(s) as a prime contractor, subcontractor or sub-subcontractor.

- Hazmat Work:** Hazmat Work is any item of work in the Bid Schedule that begins with the prefix 8.01. The entity that will perform any Hazmat Work must, within the last three (3) consecutive years prior to the bid opening, have successfully completed in a timely fashion at least five (5) projects similar in scope and type to the required work.
- Pile, CFA Pile, and/or Mini-Pile Work:** The entity that will perform the Pile, CFA Pile and/or Mini-Pile Work must, within the last three (3) consecutive years prior to the bid opening, have successfully completed in a timely fashion at least two (2) projects similar in scope and type to the required work.

For professional services in connection with Pile Work, (i.e., engineering and inspection services), the individual who will perform the required services must be a Professional Engineer licensed by the state of New York. Such individual must also comply with the above requirements for prior projects.

- Construction Report, Monitoring And Post-Construction Report, and Continuous Real-Time Monitoring For Vibrations And Movements And Post-Construction Report Work:** The entity that will perform the Construction Report, Monitoring For Vibrations And Movements, and Post-Construction Report Work must, within the last three (3) consecutive years prior to the bid opening, have successfully completed in a timely fashion at least two (2) projects similar in scope and type to the required work.

For professional services in connection with Reporting and Monitoring Work, (i.e., engineering and inspection services), the individual who will perform the required services must be a Professional Engineer licensed by the state of New York. Such individual must also comply with the above requirements for prior projects.

- OTHER:** _____

(C) **SPECIFICATIONS:** In the event of any conflict, omission or inconsistency between (1) the Specifications and/or Contract Drawings, and (2) the Special Experience Requirements in Section (B) of the Special Notice To Bidders, the special experience listed in the Specifications and/or Contract Drawings shall be controlling. The Special Experience Requirements in Section (B) of this Special Notice To Bidders are only for the convenience of the bidders.

(D) **SUBMISSION REQUIREMENTS:** For each project submitted to demonstrate compliance with the Special Experience Requirements, the bidder must complete and submit the Qualification Form included in the Bid Booklet. The City will only evaluate a project if the following criteria are met: (1) the project is described on the Qualification Form, and (2) all information on the Qualification Form is provided. The City will not evaluate any project which does not comply with the criteria set forth herein, including any project which is referred to only on the resume of an individual.

If Special Experience Requirements are indicated for any specific area of work, the submission requirement set forth above shall apply to the entity that will perform the specific area of work.

(E) **CONDITIONS:** In determining compliance with the Special Experience Requirements for the bidder set forth above, the City may consider prior projects completed by principal(s) or other employees of the bidder while affiliated with another entity, subject to the conditions set forth below.

- Any principal or other employee on whose prior experience the bidder is relying to demonstrate compliance with this special experience requirement must have held the following: (a) a significant management role in the prior entity with which he/she was affiliated, and (b) a significant management role in the entity submitting the bid for a period of six (6) months or more from the inception of the bidding entity.
- The bidder may not rely on the experience of its principals or other employees to demonstrate compliance with any other requirements, including without limitation, financial requirements or requirements for a specified minimum amount of annual gross revenues.

(F) **JOINT VENTURES:** In the event the bidder is a joint venture, at least one firm in the joint venture must meet the above described experience requirements.

Qualification Form

List previous projects completed to meet the special experience requirements for this contract.
Please photocopy this form for submission of all required projects.

Name of Contractor: _____

Name of Project: _____

Location of Project: _____

Owner or Owner's representative (Architect or Engineer) who is familiar with the work performed:

Name: _____

Title: _____ Phone Number: _____

Brief description of the Project completed or the Project in progress: _____

Was the Project performed as a prime, a subcontractor or a sub-subcontractor: _____

Amount of Contract, Subcontract or Sub-subcontract: _____

Start Date and Completion Date: _____

Name of Contractor: _____

Name of Project: _____

Location of Project: _____

Owner or Owner's representative (Architect or Engineer) who is familiar with the work performed:

Name: _____

Title: _____ Phone Number: _____

Brief description of the Project completed or the Project in progress: _____

Was the Project performed as a prime, a subcontractor or a sub-subcontractor: _____

Amount of Contract, Subcontract or Sub-subcontract: _____

Start Date and Completion Date: _____

(NO TEXT ON THIS PAGE)

ATTACHMENT 1 - BID INFORMATION

PROJECT ID: HWPEDSF1

PIN: 8502013HW0079C

Description and Location of Work:

**MULTI-SITE PEDESTRIAN SAFETY
WHICH INCLUDES THE FOLLOWING INTERSECTIONS:**

31ST STREET AND 39TH AVENUE

31ST STREET AND 36TH AVENUE

31ST STREET AND BROADWAY

**INCLUDING BUS BULBOUTS, CURB EXTENSIONS, BUS PADS,
PEDESTRIAN RAMPS, CATCH BASINS, PAVEMENT MARKINS,
STREET LIGHTING, AND TRAFFIC SIGNAL WORK**

**Together With All Work Incidental Thereto
BOROUGH OF QUEENS
CITY OF NEW YORK**

Documents Available At:

30-30 Thomson Avenue
First Floor Bid Procurement Room
Long Island City, New York 11101
8:30 A.M. to 4:00 P.M. – Monday through Friday

Submission of Bids To:

30-30 Thomson Avenue
First Floor Bid Procurement Room
Long Island City, New York 11101
Before 11:00 A.M. on **JANUARY 28, 2015**

Bid Opening:

30-30 Thomson Avenue
First Floor Bid Procurement Room
Long Island City, New York 11101

Time and Date: 11:00 A.M. on **JANUARY 28, 2015**

Pre-Bid Conference:

Yes _____ No X
If Yes, Mandatory _____ Optional: _____
Time and Date: _____
Location: _____

Bid Security:

Bid Security is required in the amount set forth below; provided, however, bid security is not required if the TOTAL BID PRICE set forth on the Bid Form is less than \$ 1,000,000.00.

- (1) Bond in an amount not less than 10% of the TOTAL BID PRICE set forth on the Bid Form, OR
- (2) Certified Check in an amount not less than 5% of the TOTAL BID PRICE set forth on the Bid Form.

Performance and Payment Security: Required for contracts in the amount of \$1,000,000 or more. Performance Security and Payment Security shall each be in an amount equal to 100% of the Contract Price.

Agency Contact Person:

Lorraine Holley
Phone: 718-391-2601 FAX: 718-391-2615

(NO TEXT ON THIS PAGE)

BID SCHEDULE

NOTICE TO BIDDERS

Items listed in this Bid Schedule which have one (1) digit followed by a decimal (e.g. 4.02 AG), shall comply with the requirements of the corresponding numerical Sections of the New York City Department of Transportation Standard Highway Specifications, as amended by Addendum No. 1 herein Volume 3 of 3.

Item Nos. 637.9520 listed in this Bid Schedule shall comply with the corresponding numeric Section in Addendum No. 1, herein Volume 3 of 3.

Items listed in this Bid Schedule which have two (2) digits beginning with the numbers "5", "6" and "7" followed by a decimal (e.g. 52.11D12, 60.12D06, and 70.31FN) shall comply with the requirements of the New York City Department of Environmental Protection (NYCDEP) STANDARD SEWER AND WATER MAIN SPECIFICATIONS dated July 1, 2014, as amended by Addendum No. 3 herein Volume 3 of 3.

Items listed in this Bid Schedule beginning with the prefix "SL-" (e.g. SL-21.09.05) are Street Lighting Items, less the prefix, which shall be done in accordance with the requirements of Sub-Section 1.06.23.(D) and Section 1.06.49 in the Standard Highway Specifications.

Items listed in the Bid Schedule beginning with the prefix "T-", (e.g. T-2.1) are Traffic Items, less the prefix, which shall be done in accordance with the requirements of Sub-Section 1.06.23.(D) and Section 1.06.49 in the Standard Highway Specifications.

Project ID. HWPEDSF1

(NO TEXT)



12/24/2014 12:00 AM

NEW YORK CITY DEPARTMENT OF DESIGN AND CONSTRUCTION
DIVISION OF INFRASTRUCTURE - BUREAU OF DESIGN

CONTRACT PIN: 8502013HW0079C
PROJECT ID: HWPEDSF1

BID SCHEDULE

- NOTE:** (1) The Agency may reject a bid if it contains unbalanced bid prices. An unbalanced bid is considered to be one containing lump sum or unit items which do not reflect reasonable actual costs plus a reasonable proportionate share of the Bidder's anticipated profit, overhead costs, and other indirect costs, anticipated for the performance of the items in question.
- (2) The following bid prices on Unit Price Contracts are to be paid for the actual quantities of the item numbers in the completed work or structure, and they cover the cost of all work, labor, material, tools, plant and appliances of every description necessary to complete the entire work, as specified, and the removal of all debris, temporary work and appliances.
- (3) PLEASE BE SURE A LEGIBLE BID IS ENTERED, IN INK, FOR EACH ITEM.
Alterations must be initialed in ink by the bidder.
- (4) The Extended Amount entered in Column 6 shall be the product of the Estimated Quantity in Column 3 times the Unit Price Bid in Column 5.
- (5) Prospective bidders must examine the Bid Schedule carefully and, before bidding, must advise the Commissioner, in writing, if any pages are missing, and must request that such missing pages be furnished them. The pages of this Bid Schedule are numbered consecutively, as follows:
B - 3 Through B - 33

PLEASE BE SURE A LEGIBLE BID IS ENTERED FOR EACH ITEM.
THE BIDDER SHALL INSERT THE TOTAL BID PRICE IN
THE BID FORM ON PAGE C-4 OF THIS BID BOOKLET.

BID SCHEDULE FORM

COL. 1 SEQ. NO	COL. 2 ITEM NUMBER and DESCRIPTION	COL. 3 ENGINEER'S ESTIMATE OF QUANTITY	COL. 4 UNIT	COL. 5 UNIT PRICE (IN FIGURES) DOLLARS	COL. 6 EXTENDED AMOUNT (IN FIGURES) DOLLARS	CTS
001	4.02 AG ASPHALTIC CONCRETE WEARING COURSE, 3" THICK	832.00	S.Y.			
002	4.02 CB ASPHALTIC CONCRETE MIXTURE	192.00	TONS			
003	4.04 H CONCRETE BASE FOR PAVEMENT, VARIABLE THICKNESS FOR TRENCH RESTORATION, (HIGH-EARLY STRENGTH)	249.00	C.Y.			
004	4.05 AX HIGH-EARLY STRENGTH REINFORCED CONCRETE PAVEMENT (BUS STOPS)	336.00	C.Y.			
005	4.08 AA CONCRETE CURB (18" DEEP)	101.00	L.F.			
006	4.09 AD STRAIGHT STEEL FACED CONCRETE CURB (18" DEEP)	589.00	L.F.			

12/24/2014 12:00 AM

NEW YORK CITY DEPARTMENT OF DESIGN AND CONSTRUCTION
 DIVISION OF INFRASTRUCTURE - BUREAU OF DESIGN

PROJECT ID: HWPEDSF1
 CONTRACT PIN: 8502013HW0079C

BID SCHEDULE FORM

COL 1 SEQ. NO	COL 2 ITEM NUMBER and DESCRIPTION	COL 3 ENGINEER'S ESTIMATE OF QUANTITY	COL 4 UNIT	COL 5 UNIT PRICE (IN FIGURES)		COL 6 EXTENDED AMOUNT (IN FIGURES)	
				DOLLARS	CTS	DOLLARS	CTS
007	4.09 AF STRAIGHT STEEL FACED CONCRETE CURB (27" DEEP)	587.00	L.F.				
008	4.09 CD CORNER STEEL FACED CONCRETE CURB (18" DEEP)	325.00	L.F.				
009	4.11 CA FILL, PLACE MEASUREMENT	161.00	C.Y.				
010	4.13 AAS 4" CONCRETE SIDEWALK (UNPIGMENTED)	30,855.00	S.F.				
011	4.13 BAS 7" CONCRETE SIDEWALK (UNPIGMENTED)	1,620.00	S.F.				
012	4.13 DE EMBEDDED PREFORMED DETECTABLE WARNING UNITS	242.00	S.F.				

BID SCHEDULE FORM

COL 1 SEQ. NO	COL 2 ITEM NUMBER and DESCRIPTION	COL 3 ENGINEER'S ESTIMATE OF QUANTITY	COL 4 UNIT	COL 5 UNIT PRICE (IN FIGURES) DOLLARS	COL 6 EXTENDED AMOUNT (IN FIGURES) DOLLARS	CTS
013	4.18 A MAINTENANCE TREE PRUNING (UNDER 12" CAL.)	1.00	EACH			
014	4.21 TREE CONSULTANT	4.00	P/HR			
015	51.21S0A1000E STANDARD MANHOLE TYPE A-1 ON EXISTING SEWER	6.00	EACH			
016	51.21S0A2000E STANDARD MANHOLE TYPE A-2 ON EXISTING SEWER	1.00	EACH			
017	51.23RF REPLACEMENT OF EXISTING MANHOLE FRAME AND COVER	5.00	EACH			
018	51.41S001 STANDARD CATCH BASIN, TYPE 1	13.00	EACH			

12/24/2014 12:00 AM

NEW YORK CITY DEPARTMENT OF DESIGN AND CONSTRUCTION
 DIVISION OF INFRASTRUCTURE - BUREAU OF DESIGN

PROJECT ID: HWPEDSF1

CONTRACT PIN: 8502013HW0079C

BID SCHEDULE FORM

COL 1 SEQ. NO	COL 2 ITEM NUMBER and DESCRIPTION	COL 3 ENGINEER'S ESTIMATE OF QUANTITY	COL 4 UNIT	COL 5 UNIT PRICE (IN FIGURES)		COL 6 EXTENDED AMOUNT (IN FIGURES)	
				DOLLARS	CTS	DOLLARS	CTS
019	51.42S1SO INCREMENTAL COST OF STANDARD CATCH BASIN TYPE 3 WITH CURB PIECE IN LIEU OF STANDARD CATCH BASIN TYPE 1	5.00	EACH				
020	52.11D12 12" DUCTILE IRON PIPE BASIN CONNECTION	399.00	L.F.				
021	55.11AB ABANDONING BASINS AND INLETS	5.00	EACH				
022	6.02 AAN UNCLASSIFIED EXCAVATION	1,758.00	C.Y.				
023	6.02 XHEC INCREMENTAL COST FOR MODIFYING WORK METHODS NEAR (WITHIN 3 FEET OF) TRANSIT FACILITIES AND BUILDING VAULTS	94.00	C.Y.				
024	6.02 XSCW INCREMENTAL COST FOR USING SPECIAL CARE WORK METHODS NEAR (FROM 3 FEET TO 50 FEET) TRANSIT FACILITIES	1,665.00	C.Y.				

BID SCHEDULE FORM

COL 1	COL 2	COL 3	COL 4	COL 5	COL 6
SEQ. NO	ITEM NUMBER and DESCRIPTION	ENGINEER'S ESTIMATE OF QUANTITY	UNIT	UNIT PRICE (IN FIGURES) DOLLARS : CTS	EXTENDED AMOUNT (IN FIGURES) DOLLARS : CTS
025	6.23 AB REMOVE EXISTING FIRE ALARM POST	1.00	EACH		
026	6.23 BA FURNISH AND INSTALL FIRE ALARM POST AND SUBBASE IN ACCORDANCE WITH F.D. STD. DWG. #141	1.00	EACH		
027	6.23 BD FURNISH AND INSTALL 4-PAIR FIRE ALARM CABLE	209.00	L.F.		
028	6.23 BES FURNISH AND INSTALL FIRE DEPARTMENT SLOTTED MANHOLE TYPE "A" WITH FRAME AND COVER IN ACCORDANCE WITH F.D. STD. DWG. #140, #144S & #144E	2.00	EACH		
029	6.23 BFB FURNISH AND INSTALL FIRE DEPARTMENT 24 WIRE TERMINAL BOX AND TERMINATE FIRE ALARM CABLES	1.00	EACH		
030	6.23 BGSE FURNISH AND INSTALL 4" P.V.C. CONDUIT, SCHEDULE 40, U.L. 651 (WITH PAVEMENT EXCAVATION)	99.00	L.F.		

12/24/2014 12:00 AM

NEW YORK CITY DEPARTMENT OF DESIGN AND CONSTRUCTION
 DIVISION OF INFRASTRUCTURE - BUREAU OF DESIGN

PROJECT ID: HWPEDSF1
 CONTRACT PIN: 8502013HW0079C

BID SCHEDULE FORM

COL 1 SEQ. NO	COL 2 ITEM NUMBER and DESCRIPTION	COL 3 ENGINEER'S ESTIMATE OF QUANTITY	COL 4 UNIT	COL 5 UNIT PRICE (IN FIGURES) DOLLARS	COL 6 EXTENDED AMOUNT (IN FIGURES) DOLLARS
031	6.23 BHE FURNISH AND INSTALL 4" 90-DEGREE P.V.C. WIDE BEND, SCHEDULE 40, U.L. 651 (WITH PAVEMENT EXCAVATION) IN ACCORDANCE WITH F.D. STD. DWG. #141 OR #145AA	1.00	EACH		
032	6.23 BP FURNISH AND INSTALL FIRE ALARM PEDESTAL BUMPERS (2 REQUIRED PER SET) IN ACCORDANCE WITH F.D. STD. DWG. #168	1.00	SETS		
033	6.25 RS TEMPORARY SIGNS	96.00	S.F.		
034	6.26 TIMBER CURB	5,657.00	L.F.		
035	6.28 BA LIGHTED TYPE III BREAKAWAY BARRICADES	4,964.00	L.F.		
036	6.36 DR STRUCTURAL REPAIR AND ADJUSTMENT OF UTILITY STRUCTURES	6.00	C.Y.		

BID SCHEDULE FORM

COL 1 SEQ. NO	COL 2 ITEM NUMBER and DESCRIPTION	COL 3 ENGINEER'S ESTIMATE OF QUANTITY	COL 4 UNIT	COL 5 UNIT PRICE (IN FIGURES)		COL 6 EXTENDED AMOUNT (IN FIGURES)	
				DOLLARS	CTS	DOLLARS	CTS
037	6.40 B ENGINEER'S FIELD OFFICE (TYPE B)	15.00	MONTH				
038	6.43 PHOTOGRAPHS	572.00	SETS				
039	6.44 THERMOPLASTIC REFLECTORIZED PAVEMENT MARKINGS (4" WIDE)	9,998.00	L.F.				
040	6.49 TEMPORARY PAVEMENT MARKINGS (4" WIDE)	440.00	L.F.				
041	6.50 CLEANING OF DRAINAGE STRUCTURES	13.00	EACH				

12/24/2014 12:00 AM

NEW YORK CITY DEPARTMENT OF DESIGN AND CONSTRUCTION
 DIVISION OF INFRASTRUCTURE - BUREAU OF DESIGN

PROJECT ID: HWPEDSF1
 CONTRACT PIN: 8502013HW0079C

BID SCHEDULE FORM

COL 1 SEQ. NO	COL 2 ITEM NUMBER and DESCRIPTION	COL 3 ENGINEER'S ESTIMATE OF QUANTITY	COL 4 UNIT	COL 5 UNIT PRICE (IN FIGURES)		COL 6 EXTENDED AMOUNT (IN FIGURES)	
				DOLLARS	CTS	DOLLARS	CTS
042	6.52 FED UNIFORMED FLAGPERSON PRICE BID SHALL BE FOR THE FIXED SUM OF \$ 38,610.00	1.00	F.S.	38,610	00	38,610	00
043	6.53 REMOVE EXISTING LANE MARKINGS (4" WIDE)	7,444.00	L.F.				
044	6.55 SAWCUTTING EXISTING PAVEMENT	4,542.00	L.F.				
045	6.73 A REMOVING EXISTING PARKING METER POSTS	11.00	EACH				
046	6.75 GRINDING EXISTING ASPHALTIC CONCRETE WEARING COURSE	18.00	C.Y.				

BID SCHEDULE FORM

COL 1 SEQ. NO	COL 2 ITEM NUMBER and DESCRIPTION	COL 3 ENGINEER'S ESTIMATE OF QUANTITY	COL 4 UNIT	COL 5 UNIT PRICE (IN FIGURES)		COL 6 EXTENDED AMOUNT (IN FIGURES)	
				DOLLARS	CTS	DOLLARS	CTS
047	6.82 A REMOVING EXISTING TRAFFIC AND STREET NAME SIGNS	157.00	S.F.				
048	6.82 B REMOVING EXISTING TRAFFIC AND STREET NAME SIGN POSTS	144.00	L.F.				
049	6.83 AA FURNISHING NEW NON-REFLECTORIZED TRAFFIC SIGNS	27.00	S.F.				
050	6.83 AB FURNISHING NEW TRAFFIC SIGN POSTS	108.00	L.F.				
051	6.83 AR FURNISHING NEW REFLECTORIZED TRAFFIC SIGNS	65.00	S.F.				
052	6.83 BA INSTALLING TRAFFIC SIGNS	92.00	S.F.				

12/24/2014 12:00 AM

NEW YORK CITY DEPARTMENT OF DESIGN AND CONSTRUCTION
DIVISION OF INFRASTRUCTURE - BUREAU OF DESIGN

PROJECT ID: HWPEDSF1
CONTRACT PIN: 8502013HW0079C

BID SCHEDULE FORM

COL 1 SEQ. NO	COL 2 ITEM NUMBER and DESCRIPTION	COL 3 ENGINEER'S ESTIMATE OF QUANTITY	COL 4 UNIT	COL 5 UNIT PRICE (IN FIGURES)		COL 6 EXTENDED AMOUNT (IN FIGURES)	
				DOLLARS	CTS	DOLLARS	CTS
053	6.83 BB INSTALLING TRAFFIC SIGN POSTS	108.00	L.F.				
054	6.84 B LOLLIPOP TYPE BUS STOP SIGNS PRICE BID SHALL BE FOR THE FIXED SUM OF \$ 20,000.00	1.00	F.S.	20,000	00	20,000	00
055	6.86 AA FURNISHING NEW STREET NAME SIGNS	25.00	S.F.				
056	6.86 AB FURNISHING NEW STREET NAME SIGN POSTS	98.00	L.F.				
057	6.86 BA INSTALLING STREET NAME SIGNS	25.00	S.F.				

BID SCHEDULE FORM

COL. 1 SEQ. NO	COL. 2 ITEM NUMBER and DESCRIPTION	COL. 3 ENGINEER'S ESTIMATE OF QUANTITY	COL. 4 UNIT	COL. 5 UNIT PRICE (IN FIGURES) DOLLARS : CTS	COL. 6 EXTENDED AMOUNT (IN FIGURES) DOLLARS : CTS
058	6.86 BB INSTALLING STREET NAME SIGN POSTS	98.00	L.F.		
059	6.87 PLASTIC BARRELS	1,066.00	EACH		
060	6.91 REFLECTIVE CRACKING MEMBRANE (18" WIDE)	4,542.00	L.F.		
061	6.99 AUDIO AND VIDEO DOCUMENTATION SURVEY	1.00	L.S.		
062	60.11R606 FURNISHING AND DELIVERING 6-INCH DUCTILE IRON RESTRAINED JOINT PIPE (CLASS 56)	11.00	L.F.		
063	60.11R612 FURNISHING AND DELIVERING 12-INCH DUCTILE IRON RESTRAINED JOINT PIPE (CLASS 56)	638.00	L.F.		

12/24/2014 12:00 AM

NEW YORK CITY DEPARTMENT OF DESIGN AND CONSTRUCTION
 DIVISION OF INFRASTRUCTURE - BUREAU OF DESIGN

PROJECT ID: HWPEDSF1

CONTRACT PIN: 8502013HW0079C

BID SCHEDULE FORM

COL 1 SEQ. NO	COL 2 ITEM NUMBER and DESCRIPTION	COL 3 ENGINEER'S ESTIMATE OF QUANTITY	COL 4 UNIT	COL 5 UNIT PRICE (IN FIGURES)		COL 6 EXTENDED AMOUNT (IN FIGURES)	
				DOLLARS	CTS	DOLLARS	CTS
064	60.12D06 LAYING 6-INCH DUCTILE IRON PIPE AND FITTINGS	14.00	L.F.				
065	60.12D12 LAYING 12-INCH DUCTILE IRON PIPE AND FITTINGS	688.00	L.F.				
066	60.13M0A24 FURNISHING AND DELIVERING DUCTILE IRON MECHANICAL JOINT 24 -INCH DIAMETER AND SMALLER FITTINGS, INCLUDING WEDGE TYPE RETAINER GLANDS	4.00	TONS				
067	61.11DMM06 FURNISHING AND DELIVERING 6-INCH MECHANICAL JOINT DUCTILE IRON GATE VALVE COMPLETE WITH WEDGE TYPE RETAINER GLANDS	1.00	EACH				
068	61.11DMM12 FURNISHING AND DELIVERING 12-INCH MECHANICAL JOINT DUCTILE IRON GATE VALVE COMPLETE WITH WEDGE TYPE RETAINER GLANDS	6.00	EACH				

BID SCHEDULE FORM

COL 1 SEQ. NO	COL 2 ITEM NUMBER and DESCRIPTION	COL 3 ENGINEER'S ESTIMATE OF QUANTITY	COL 4 UNIT	COL 5 UNIT PRICE (IN FIGURES)		COL 6 EXTENDED AMOUNT (IN FIGURES)	
				DOLLARS	CTS	DOLLARS	CTS
069	61.11TWC03 FURNISHING AND DELIVERING 3-INCH WET CONNECTION TAPPING VALVE COMPLETE WITH WEDGE TYPE RETAINER GLANDS	1.00	EACH				
070	61.11TWC04 FURNISHING AND DELIVERING 4-INCH WET CONNECTION TAPPING VALVE COMPLETE WITH WEDGE TYPE RETAINER GLANDS	1.00	EACH				
071	61.11TWC06 FURNISHING AND DELIVERING 6-INCH WET CONNECTION TAPPING VALVE COMPLETE WITH WEDGE TYPE RETAINER GLANDS	1.00	EACH				
072	61.12DMM06 SETTING 6-INCH MECHANICAL JOINT DUCTILE IRON GATE VALVE COMPLETE WITH WEDGE TYPE RETAINER GLANDS	1.00	EACH				
073	61.12DMM12 SETTING 12-INCH MECHANICAL JOINT DUCTILE IRON GATE VALVE COMPLETE WITH WEDGE TYPE RETAINER GLANDS	6.00	EACH				
074	61.12TWC03 SETTING 3-INCH WET CONNECTION TAPPING VALVE COMPLETE WITH WEDGE TYPE RETAINER GLANDS	1.00	EACH				

12/24/2014 12:00 AM

NEW YORK CITY DEPARTMENT OF DESIGN AND CONSTRUCTION
 DIVISION OF INFRASTRUCTURE - BUREAU OF DESIGN

PROJECT ID: HWPEDSF1

CONTRACT PIN: 8502013HW0079C

BID SCHEDULE FORM

COL 1 SEQ. NO	COL 2 ITEM NUMBER and DESCRIPTION	COL 3 ENGINEER'S ESTIMATE OF QUANTITY	COL 4 UNIT	COL 5 UNIT PRICE (IN FIGURES)		COL 6 EXTENDED AMOUNT (IN FIGURES)	
				DOLLARS	CTS	DOLLARS	CTS
075	61.12TWC04 SETTING 4-INCH WET CONNECTION TAPPING VALVE COMPLETE WITH WEDGE TYPE RETAINER GLANDS	1.00	EACH				
076	61.12TWC06 SETTING 6-INCH WET CONNECTION TAPPING VALVE COMPLETE WITH WEDGE TYPE RETAINER GLANDS	1.00	EACH				
077	62.11SD FURNISHING AND DELIVERING HYDRANTS	1.00	EACH				
078	62.12SG SETTING HYDRANTS COMPLETE WITH WEDGE TYPE RETAINER GLANDS	1.00	EACH				
079	62.13RH REMOVING HYDRANTS	1.00	EACH				
080	62.14FS FURNISHING, DELIVERING AND INSTALLING HYDRANT FENDERS	2.00	EACH				

BID SCHEDULE FORM

COL 1 SEQ. NO	COL 2 ITEM NUMBER and DESCRIPTION	COL 3 ENGINEER'S ESTIMATE OF QUANTITY	COL 4 UNIT	COL 5 UNIT PRICE (IN FIGURES) DOLLARS : CTS	COL 6 EXTENDED AMOUNT (IN FIGURES) DOLLARS : CTS
081	63.11VC FURNISHING AND DELIVERING VARIOUS CASTINGS	5.00	TONS		
082	637.9520 FIELD INFORMATION MANAGEMENT SYSTEM PRICE BID SHALL BE FOR THE FIXED SUM OF \$ 25,000.00	1.00	F.S.	25,000 00	25,000 00
083	64.11EL WITHDRAWING AND REPLACING HOUSE SERVICES USING 1-1/2- INCH OR LARGER SCREW TAPS	11.00	EACH		
084	64.11ST WITHDRAWING AND REPLACING HOUSE SERVICES USING SMALLER THAN 1-1/2-INCH SCREW TAPS	7.00	EACH		
085	64.12COEG CUTTING AND OFFSETTING HOUSE SERVICE WATER CONNECTIONS (EQUAL TO OR GREATER THAN 3-INCH DIAMETER)	6.00	L.F.		

12/24/2014 12:00 AM

NEW YORK CITY DEPARTMENT OF DESIGN AND CONSTRUCTION
 DIVISION OF INFRASTRUCTURE - BUREAU OF DESIGN

PROJECT ID: HWPEDSF1

CONTRACT PIN: 8502013HW0079C

BID SCHEDULE FORM

COL 1 SEQ. NO	COL 2 ITEM NUMBER and DESCRIPTION	COL 3 ENGINEER'S ESTIMATE OF QUANTITY	COL 4 UNIT	COL 5 UNIT PRICE (IN FIGURES)		COL 6 EXTENDED AMOUNT (IN FIGURES)	
				DOLLARS	CTS	DOLLARS	CTS
086	64.12COLT CUTTING AND OFFSETTING HOUSE SERVICE WATER CONNECTIONS (LESS THAN 3-INCH DIAMETER)	6.00	L.F.				
087	64.12ESEG EXTENDING HOUSE SERVICE WATER CONNECTIONS (EQUAL TO OR GREATER THAN 3-INCH DIAMETER)	6.00	L.F.				
088	64.12ESLT EXTENDING HOUSE SERVICE WATER CONNECTIONS (LESS THAN 3- INCH DIAMETER)	6.00	L.F.				
089	64.13WC12 FURNISHING, DELIVERING AND INSTALLING WET CONNECTION SLEEVE ON 12-INCH WATER MAIN PIPE WITH VARIOUS OUTLETS	11.00	EACH				
090	65.11BR FURNISHING, DELIVERING AND INSTALLING BANDS, RODS, WASHERS, ETC., COMPLETE, FOR RESTRAINING JOINTS	2,836.00	LBS.				
091	65.21PS FURNISHING AND PLACING POLYETHYLENE SLEEVE Unit price bid shall not be less than: \$ 0.50	714.00	L.F.				

BID SCHEDULE FORM

COL. 1 SEQ. NO	COL. 2 ITEM NUMBER and DESCRIPTION	COL. 3 ENGINEER'S ESTIMATE OF QUANTITY	COL. 4 UNIT	COL. 5 UNIT PRICE (IN FIGURES) DOLLARS	COL. 6 EXTENDED AMOUNT (IN FIGURES) DOLLARS	CTS
092	65.31FF FURNISHING, DELIVERING AND PLACING FILTER FABRIC Unit price bid shall not be less than: \$ 0.10	1,779.00	S.F.			
093	65.71SG FURNISHING, DELIVERING AND PLACING SCREENED GRAVEL OR SCREENED BROKEN STONE BEDDING	37.00	C.Y.			
094	7.13 B MAINTENANCE OF SITE Unit price bid shall not be less than: \$ 8,600.00	9.00	MONTH			
095	7.19 LOAD TRANSFER JOINT	294.00	L.F.			
096	7.36 PEDESTRIAN STEEL BARRICADES	13,019.00	L.F.			
097	7.50 CBB CITY BENCH BACKLESS	6.00	EACH			

12/24/2014 12:00 AM

NEW YORK CITY DEPARTMENT OF DESIGN AND CONSTRUCTION
 DIVISION OF INFRASTRUCTURE - BUREAU OF DESIGN

PROJECT ID: HWPEDSF1

CONTRACT PIN: 8502013HW0079C

BID SCHEDULE FORM

COL 1 SEQ. NO	COL 2 ITEM NUMBER and DESCRIPTION	COL 3 ENGINEER'S ESTIMATE OF QUANTITY	COL 4 UNIT	COL 5 UNIT PRICE (IN FIGURES)		COL 6 EXTENDED AMOUNT (IN FIGURES)	
				DOLLARS	CTS	DOLLARS	CTS
098	7.88 AA RODENT INFESTATION SURVEY AND MONITORING Unit price bid shall not be less than: \$ 1,000.00	1.00	L.S.				
099	7.88 AB RODENT BAIT STATIONS Unit price bid shall not be less than: \$ 60.00	88.00	EACH				
100	7.88 AC BAITING OF RODENT BAIT STATIONS Unit price bid shall not be less than: \$ 9.25	88.00	EACH				
101	7.88 AD WATERBUG BAIT APPLICATIONS Unit price bid shall not be less than: \$ 65.00	132.00	BLOCK				
102	70.31FN FENCING Unit price bid shall not be less than: \$ 2.00	1,298.00	L.F.				
103	70.61RE ROCK EXCAVATION	6.00	C.Y.				

BID SCHEDULE FORM

COL 1 SEQ. NO	COL 2 ITEM NUMBER and DESCRIPTION	COL 3 ENGINEER'S ESTIMATE OF QUANTITY	COL 4 UNIT	COL 5 UNIT PRICE (IN FIGURES)		COL 6 EXTENDED AMOUNT (IN FIGURES)	
				DOLLARS	CTS	DOLLARS	CTS
104	70.81CB CLEAN BACKFILL Unit price bid shall not be less than: \$ 15.00	121.00	C.Y.				
105	73.11AB ADDITIONAL BRICK MASONRY Unit price bid shall not be less than: \$ 62.50	2.00	C.Y.				
106	73.21AC ADDITIONAL CONCRETE Unit price bid shall not be less than: \$ 62.50	2.00	C.Y.				
107	73.31AE0 ADDITIONAL EARTH EXCAVATION INCLUDING TEST PITS (ALL DEPTHS) Unit price bid shall not be less than: \$ 20.00	2.00	C.Y.				
108	73.41AG ADDITIONAL SELECT GRANULAR BACKFILL Unit price bid shall not be less than: \$ 15.00	2.00	C.Y.				
109	73.51AS ADDITIONAL STEEL REINFORCING BARS Unit price bid shall not be less than: \$ 1.00	220.00	LBS.				

12/24/2014 12:00 AM

NEW YORK CITY DEPARTMENT OF DESIGN AND CONSTRUCTION
 DIVISION OF INFRASTRUCTURE - BUREAU OF DESIGN

PROJECT ID: HWPEDSF1

CONTRACT PIN: 8502013HW0079C

BID SCHEDULE FORM

COL 1 SEQ. NO	COL 2 ITEM NUMBER and DESCRIPTION	COL 3 ENGINEER'S ESTIMATE OF QUANTITY	COL 4 UNIT	COL 5 UNIT PRICE (IN FIGURES)		COL 6 EXTENDED AMOUNT (IN FIGURES)	
				DOLLARS	CTS	DOLLARS	CTS
110	8.02 A SPECIAL CARE EXCAVATION AND RESTORATION FOR SIDEWALK WORK	2,312.00	S.F.				
111	8.02 B SPECIAL CARE EXCAVATION AND RESTORATION FOR CURB WORK	201.00	L.F.				
112	9.04 HW ALLOWANCE FOR ANTI-FREEZE ADDITIVE IN CONCRETE PRICE BID SHALL BE FOR THE FIXED SUM OF \$ 15,000.00	1.00	F.S.	15,000	00	15,000	00
113	SL-20.02.02 FURNISH AND INSTALL STANDARD TYPE ANCHOR BOLT FOUNDATION, AS PER DRAWING E-3788	10.00	EACH				
114	SL-21.03.24A FURNISH AND INSTALL TYPE 14' (HIGH) STEEL DAVIT LAMPPOST (SINGLE ARM) AS PER STANDARD DWG J-5308.	10.00	EACH				

BID SCHEDULE FORM

COL 1 SEQ. NO	COL 2 ITEM NUMBER and DESCRIPTION	COL 3 ENGINEER'S ESTIMATE OF QUANTITY	COL 4 UNIT	COL 5 UNIT PRICE (IN FIGURES)		COL 6 EXTENDED AMOUNT (IN FIGURES)	
				DOLLARS	CTS	DOLLARS	CTS
115	SL-21.09.09 REMOVE F.S. SPUN ALUMINUM, #10, ETC LAMPPOST, WITH ARMS(S), LUMINAIRE(S), ETC. WITH ALL ATTACHMENTS, IF ANY. REMOVE PORTION OF FOUNDATION. RESTORE TO SURROUNDING CONDITIONS.	4.00	EACH				
116	SL-22.03.18 FURNISH AND INSTALL TYPE COBRA HEAD LUMINAIRE WITH 150 WATT HPS WITH SOLID STATE BALLAST AND STRAY VOLTAGE INDICATOR FOR 100 VOLT LAMP.	10.00	EACH				
117	SL-24.01.04 REMOVE BRACKET, LUMINAIRE AND CONTROL, IF ANY, FROM WOOD POLE	2.00	EACH				
118	SL-26.01.01 FURNISH AND INSTALL, OR FURNISH AND REPLACE A PLUG-IN SOLID STATE PHOTOELECTRIC CONTROL	10.00	EACH				
119	SL-26.06.02 FURNISH AND INSTALL LED FIRE ALARM LUMINAIRES.	1.00	EACH				

12/24/2014 12:00 AM

NEW YORK CITY DEPARTMENT OF DESIGN AND CONSTRUCTION
 DIVISION OF INFRASTRUCTURE - BUREAU OF DESIGN

PROJECT ID: HWPEDSF1
 CONTRACT PIN: 8502013HW0079C

BID SCHEDULE FORM

COL 1 SEQ. NO	COL 2 ITEM NUMBER and DESCRIPTION	COL 3 ENGINEER'S ESTIMATE OF QUANTITY	COL 4 UNIT	COL 5 UNIT PRICE (IN FIGURES)		COL 6 EXTENDED AMOUNT (IN FIGURES)	
				DOLLARS	CTS	DOLLARS	CTS
120	T-1.1 INSTALL TYPE "S" OR "T" FOUNDATION	4.00	EACH				
121	T-1.18 REMOVE TYPE "A", "B", "S" OR "T" SERIES FOUNDATION	3.00	EACH				
122	T-1.21 REMOVE TYPE "F-1" FOUNDATION	1.00	EACH				
123	T-1.29 RAISE OR LOWER FOUNDATION TO GRADE	1.00	EACH				
124	T-2.1 INSTALL TYPE "S-1" OR "T-1" SERIES POST	4.00	EACH				
125	T-2.16 FURNISH, INSTALL, MAINTAIN AND REMOVE TEMPORARY POST OR PYLON WITH SIGNALS	2.00	EACH				

BID SCHEDULE FORM

COL 1 SEQ. NO	COL 2 ITEM NUMBER and DESCRIPTION	COL 3 ENGINEER'S ESTIMATE OF QUANTITY	COL 4 UNIT	COL 5 UNIT PRICE (IN FIGURES)		COL 6 EXTENDED AMOUNT (IN FIGURES)	
				DOLLARS	CTS	DOLLARS	CTS
126	T-2.18 FURNISH, INSTALL, MAINTAIN AND REMOVE TEMPORARY POST OR PYLON WITH CONTROLLER AND SIGNALS	1.00	EACH				
127	T-2.22 REMOVE TYPE "S-1" OR "T-1" SERIES POST	3.00	EACH				
128	T-2.23 REMOVE TYPE "S-10", "T-10" OR "S-14" SERIES POST	1.00	EACH				
129	T-20000 FURNISH TEN FOOT ALUMINUM SIGNAL POST TYPE "S-1"	4.00	EACH				
130	T-20020 a) FURNISH 3/4" ANCHOR BOLT ASSEMBLIES FOR S-1 (EACH) (3 REQUIRED PER POST)	12.00	EACH				
131	T-3.1 INSTALL "ONE-WAY" SIGNAL UNIT ON MAST ARM OR TOP OF TRAFFIC POST	3.00	EACH				

12/24/2014 12:00 AM

NEW YORK CITY DEPARTMENT OF DESIGN AND CONSTRUCTION
DIVISION OF INFRASTRUCTURE - BUREAU OF DESIGN

PROJECT ID: HWPEDSF1
CONTRACT PIN: 8502013HW0079C

BID SCHEDULE FORM

COL 1 SEQ. NO	COL 2 ITEM NUMBER and DESCRIPTION	COL 3 ENGINEER'S ESTIMATE OF QUANTITY	COL 4 UNIT	COL 5 UNIT PRICE (IN FIGURES)		COL 6 EXTENDED AMOUNT (IN FIGURES)	
				DOLLARS	CTS	DOLLARS	CTS
132	T-3.18 REMOVE SIGNAL HEAD FROM ANY TYPE POST	6.00	EACH				
133	T-3.2 INSTALL "ONE-WAY" SIGNAL UNIT ON THE SHAFT OF ANY POST	3.00	EACH				
134	T-3.21 REMOVE PEDESTRIAN SIGNAL OR SIGN UNIT OR OTHER ILLUMINATED SIGNS FROM ANY POST	18.00	EACH				
135	T-3.4 INSTALL "ONE-WAY" SIGNAL UNIT OR PEDESTRIAN SIGNAL ON STEEL STRUCTURE (PER FACE)	6.00	EACH				
136	T-3.6 INSTALL PEDESTRIAN SIGNAL ON ANY TYPE POST	13.00	EACH				
137	T-30013L FURNISH ADJUST 3 SCTN 1-WAY TRAFFIC SIGNAL, 8" - W/LED LENS	6.00	EACH				

BID SCHEDULE FORM

COL 1 SEQ. NO	COL 2 ITEM NUMBER and DESCRIPTION	COL 3 ENGINEER'S ESTIMATE OF QUANTITY	COL 4 UNIT	COL 5 UNIT PRICE (IN FIGURES)		COL 6 EXTENDED AMOUNT (IN FIGURES)	
				DOLLARS	CTS	DOLLARS	CTS
138	T-31150 FURNISH "ISA" ALUMINUM DIE CASTINGS AND ASSEMBLY FOR POST SIGNAL MOUNTING	3.00	EACH				
139	T-31200 e) "VB" ASSEMBLY *ASSEMBLY IS EQUAL TO ONE PAIR	3.00	EACH				
140	T-31210 h) "HUB" ASSEMBLY *ASSEMBLY IS EQUAL TO ONE PAIR	19.00	EACH				
141	T-31340 f) "VB-P" ASSEMBLY *ASSEMBLY IS EQUAL TO ONE PAIR	12.00	EACH				
142	T-31351 g) "VB-2P" ASSEMBLY *ASSEMBLY IS EQUAL TO ONE PAIR	4.00	EACH				
143	T-33000L FURNISH POLYCARBONATE INCANDESCENT PED SIGNAL W/LED LENS	19.00	EACH				

12/24/2014 12:00 AM

NEW YORK CITY DEPARTMENT OF DESIGN AND CONSTRUCTION
 DIVISION OF INFRASTRUCTURE - BUREAU OF DESIGN

PROJECT ID: HWPEDSF1
 CONTRACT PIN: 8502013HW0079C

BID SCHEDULE FORM

COL 1 SEQ. NO	COL 2 ITEM NUMBER and DESCRIPTION	COL 3 ENGINEER'S ESTIMATE OF QUANTITY	COL 4 UNIT	COL 5 UNIT PRICE (IN FIGURES) DOLLARS : CTS	COL 6 EXTENDED AMOUNT (IN FIGURES) DOLLARS : CTS
144	T-4.22 INSTALL ANY TYPE OF ADVANCED SOLID STATE TRAFFIC SIGNAL CONTROLLER AND CABINET ON METAL POLE	2.00	EACH		
145	T-4.8 REMOVE ONE CONTROL BOX AND CONTROLLER FROM ANY POST OR SUPPORT	2.00	EACH		
146	T-5.1 FURNISH AND INSTALL 2" RIGID UNDERGROUND CONDUIT IN UNPAVED ROADWAY	180.00	L.F.		
147	T-5.18 FURNISH AND INSTALL 2" RIGID CONDUIT ON "ELEVATED" STRUCTURE	50.00	L.F.		
148	T-5.2 FURNISH AND INSTALL 2" RIGID UNDERGROUND CONDUIT IN PAVED ROADWAY	20.00	L.F.		
149	T-5.3 FURNISH AND INSTALL 2" RIGID UNDERGROUND CONDUIT IN PAVED SIDEWALK	20.00	L.F.		

BID SCHEDULE FORM

COL 1 SEQ. NO	COL 2 ITEM NUMBER and DESCRIPTION	COL 3 ENGINEER'S ESTIMATE OF QUANTITY	COL 4 UNIT	COL 5 UNIT PRICE (IN FIGURES) DOLLARS CTS	COL 6 EXTENDED AMOUNT (IN FIGURES) DOLLARS CTS
150	T-5.32 RESTORING PERMANENT ROADWAY (INCLUDING SAWCUT)	20.00	L.F.		
151	T-5.34 RESTORING PERMANENT SIDEWALK	20.00	S.F.		
152	T-5.36 REMOVE CONDUIT FROM POST	40.00	L.F.		
153	T-5.37 REMOVE CONDUIT FROM "ELEVATED" STRUCTURE	40.00	L.F.		
154	T-6.10 REMOVE CABLE (INCLUDES OVERHEAD)	1,000.00	L.F.		
155	T-6.11 REMOVE OVERHEAD CABLE AND SUPPORTS	300.00	L.F.		

12/24/2014 12:00 AM

NEW YORK CITY DEPARTMENT OF DESIGN AND CONSTRUCTION
 DIVISION OF INFRASTRUCTURE - BUREAU OF DESIGN

PROJECT ID: HWPEDSF1
 CONTRACT PIN: 8502013HW0079C

BID SCHEDULE FORM

COL 1 SEQ. NO	COL 2 ITEM NUMBER and DESCRIPTION	COL 3 ENGINEER'S ESTIMATE OF QUANTITY	COL 4 UNIT	COL 5 UNIT PRICE (IN FIGURES)		COL 6 EXTENDED AMOUNT (IN FIGURES)	
				DOLLARS	CTS	DOLLARS	CTS
156	T-6.2 INSTALL MULTIPLE CABLE (INCLUDES OVERHEAD)	1,000.00	L.F.				
157	T-6.3 INSTALL CABLE AND SUPPORTS ON STRUCTURE	300.00	L.F.				
158	T-60000B FURNISH 2 c # 10B (SEE SPEC) (BREAKDOWN = 2#10 WITH 3RD WIRE FOR GROUNDING).	1,000.00	L.F.				
159	T-60040 e) 7 CONDUCTOR, 14 A.W.G.	400.00	L.F.				
160	T-60190 e) 13 CONDUCTOR, 14 A.W.G.	1,200.00	L.F.				
161	T-7.47 REMOVE JUNCTION BOX	2.00	EACH				

BID SCHEDULE FORM

COL 1 SEQ. NO	COL 2 ITEM NUMBER and DESCRIPTION	COL 3 ENGINEER'S ESTIMATE OF QUANTITY	COL 4 UNIT	COL 5 UNIT PRICE (IN FIGURES)		COL 6 EXTENDED AMOUNT (IN FIGURES)	
				DOLLARS	CTS	DOLLARS	CTS
162	T-8.10 RELOCATE CONCRETE PYLON WITH POST	3.00	EACH				
163	T-8.8 INSTALL CONCRETE PYLON	3.00	EACH				
164	T-8.9 REMOVE CONCRETE PYLON	3.00	EACH				
165	T-8.1000 FURNISH CONCRETE PYLON	3.00	EACH				

12/24/2014 12:00 AM

NEW YORK CITY DEPARTMENT OF DESIGN AND CONSTRUCTION
DIVISION OF INFRASTRUCTURE - BUREAU OF DESIGN

PROJECT ID: HWPEDSF1

CONTRACT PIN: 8502013HW0079C

BID SCHEDULE FORM

COL 1 SEQ. NO	COL 2 ITEM NUMBER and DESCRIPTION	COL 3 ENGINEER'S ESTIMATE OF QUANTITY	COL 4 UNIT	COL 5 UNIT PRICE (IN FIGURES) DOLLARS CTS	COL 6 EXTENDED AMOUNT (IN FIGURES) DOLLARS CTS
------------------	--------------------------------------	--	---------------	--	---

SUB-TOTAL: \$ _____

166	6.39 A MOBILIZATION BID PRICE OF MOBILIZATION SHALL NOT EXCEED 4% OF THE ABOVE SUB-TOTAL PRICE.	1.00	L.S.		
-----	--	------	------	--	--

TOTAL BID PRICE: \$ _____

PLEASE BE SURE A LEGIBLE BID IS ENTERED FOR EACH ITEM.
THE BIDDER SHALL INSERT THE TOTAL BID PRICE IN
THE BID FORM ON PAGE C-4 OF THIS BID BOOKLET.

(NO TEXT ON THIS PAGE)

**BID FORM
THE CITY OF NEW YORK
DEPARTMENT OF DESIGN AND CONSTRUCTION
DIVISION OF INFRASTRUCTURE**

**BID FOR FURNISHING ALL LABOR AND
MATERIAL NECESSARY AND REQUIRED FOR:**

PROJECT ID: HWPEDSF1

**MULTI-SITE PEDESTRIAN SAFETY
WHICH INCLUDES THE FOLLOWING INTERSECTIONS:**

**31ST STREET AND 39TH AVENUE
31ST STREET AND 36TH AVENUE
31ST STREET AND BROADWAY**

**INCLUDING BUS BULBOUTS, CURB EXTENSIONS, BUS PADS,
PEDESTRIAN RAMPS, CATCH BASINS, PAVEMENT MARKINS,
STREET LIGHTING, AND TRAFFIC SIGNAL WORK**

**Together With All Work Incidental Thereto
BOROUGH OF QUEENS
CITY OF NEW YORK**

Name of Bidder: _____

Date of Bid Opening: _____

Bidder is: (Check one, whichever applies) Individual () Partnership () Corporation ()

Place of Business of Bidder: _____

Bidder's Telephone Number: _____ Fax Number: _____

Bidder's E-Mail Address: _____

Residence of Bidder (If Individual): _____

If Bidder is a Partnership, fill in the following blanks:

Names of Partners

Residence of Partners

If Bidder is a Corporation, fill in the following blanks:

Organized under the laws of the State of _____

Name and Home Address of President: _____

Name and Home Address of Secretary: _____

Name and Home Address of Treasurer: _____

BID FORM

The above-named Bidder affirms and declares:

1. The said bidder is of lawful age and the only one interested in this bid; and no person, firm or corporation other than hereinbefore named has any interest in this bid, or in the Contract proposed to be taken.
2. By submission of this bid, each bidder and each person signing on behalf of any bidder certifies, and in the case of a joint bid each party thereto certifies as to its own organization, under penalty of perjury, that to the best of its knowledge and belief: (1) the prices in this bid have been arrived at independently without collusion, consultation, communication or agreement, for the purpose of restricting competition, as to any matter relating to such prices with any other bidder or with any competitor; (2) unless otherwise required by law, the prices quoted in this bid have not been knowingly disclosed by the bidder and will not knowingly be disclosed by the bidder prior to opening, directly or indirectly, to any other bidder or to any competitor; and (3) No attempt has been made or will be made by the bidder to induce any other person, partnership or corporation to submit or not to submit a bid for the purpose of restricting competition.
3. No councilman or other officer or employee or person whose salary is payable in whole or in part from the City Treasury is directly or indirectly interested in this bid, or in the supplies, materials, equipment, work or labor to which it relates, or in any of the profits thereof.
4. The bidder is not in arrears to the City of New York upon debt or contract or taxes, and is not a defaulter, as surety or otherwise, upon any obligation of the City of New York, and has not been declared not responsible, or disqualified, by any agency of the City of New York or State of New York, nor is there any proceeding pending relating to the responsibility or qualification of the bidder to receive public contracts except as set forth on the Affirmation included as page C-6 of this Bid Booklet.

The bidder hereby affirms that it has paid all applicable City income, excise and other taxes for all years it has conducted business activities in New York City.

5. The bidder, as an individual, or as a member, partner, director or officer of the bidder, if the same be a firm, partnership or corporation, executes this document expressly warranting and representing that should this bid be accepted by the City and the Contract awarded to him, he and his subcontractors engaged in the performance: (1) will comply with the provisions of Section 6-108 of the Administrative Code of the City of New York and the non-discrimination provisions of Section 220a of the New York State Labor Law, as more expressly and in detail set forth in the Agreement; (2) will comply with Section 6-109 of the Administrative Code of the City of New York in relation to minimum wages and other stipulations as more expressly and in detail set forth in the Agreement; (3) have complied with the provisions of the aforesaid laws since their respective effective dates, and (4) will post notices to be furnished by the City, setting forth the requirements of the aforesaid laws in prominent and conspicuous places in each and every plant, factory, building and structure where employees engaged in the performance of the Contract can readily view it, and will continue to keep such notices posted until the supplies, materials and equipment, or work labor and services required to be furnished or rendered by the Contractor have been finally accepted by the City. In the event of any breach or violation of the foregoing, the Contractor may be subject to damages, liquidated or otherwise, cancellation of the Contract and suspension as a bidder for a period of three years. (The words, "the bidder", "he", "his", and "him" where used herein shall mean the individual bidder, firm, partnership or corporation executing this bid).

6. Compliance Report

The bidder, as an individual, or as a member, partner, director, or officer of the bidder, if the same be a firm, partnership, or corporation, (1) represents that his attention has been specifically drawn to Executive Order No. 50, dated, April 25, 1980, on Equal Employment Compliance of the contract, and (2) warrants that he will comply with the provisions of Executive Order No. 50. The Employment Report must be submitted as part of the bid.

The bidder, as an individual, or as a member, partner, director, or officer of the bidder, if the same be a firm, partnership, or corporation, executes this document expressly warranting that he will comply with: (1) the provision of the contract on providing records, Chapter 8.

7. By submission of this bid, the bidder certifies that it now has and will continue to have the financial capability to fully perform the work required for this contract. Any award of this contract will be made in reliance upon such certification. Upon request therefor, the bidder will submit written verification of such financial capability in a form that is acceptable to the department.

8. In accordance with Section 165 of the State Finance Law, the bidder agrees that tropical hardwoods, as defined in Section 165 of the State Finance Law, shall not be utilized in the performance of this Contract, except as the same are permitted by the foregoing provision of law.

9. The bidder has visited and examined the site of the work and has carefully examined the Contract in the form approved by the Corporation Counsel, and will execute the Contract and perform all its items, covenants and conditions, and will provide, furnish and deliver all the work, materials, supplies, tools and appliances for all labor and materials necessary or required for the hereinafter named work, all in strict conformity with the Contract, for the prices set forth in the Bid Schedule:

(NO TEXT ON THIS PAGE)

BID FORM

LEAD PROJECT ID. HWPEDSF1

TOTAL BID PRICE: In the space provided below, the Bidder shall indicate its Total Bid Price in figures. Such Total Bid Price is set forth on the final page of the Bid Schedule.

TOTAL BID PRICE:
(a/k/a BID PROPOSAL)

\$ _____

BIDDER'S SIGNATURE AND AFFIDAVIT

Bidder: _____

By: _____
(Signature of Partner or corporate officer)

Attest:
(Corporate Seal)

Secretary of Corporate Bidder

Affidavit on the following page should be subscribed
and sworn to before a Notary Public

BID FORM (TO BE NOTARIZED)

AFFIDAVIT WHERE BIDDER IS AN INDIVIDUAL

STATE OF NEW YORK, COUNTY OF _____ ss:

_____ being duly sworn says:
I am the person described in and who executed the foregoing bid, and the several matters therein stated are in all respects true.

(Signature of the person who signed the Bid)

Subscribed and sworn to before me this
_____ day of _____, _____

Notary Public

AFFIDAVIT WHERE BIDDER IS A PARTNERSHIP

STATE OF NEW YORK, COUNTY OF _____ ss:

_____ being duly sworn says:
I am a member of _____ the firm described in and which executed the foregoing bid. I subscribed the name of the firm thereto on behalf of the firm, and the several matters therein stated are in all respects true.

(Signature of Partner who signed the Bid)

Subscribed and sworn to before me this
_____ day of _____, _____

Notary Public

AFFIDAVIT WHERE BIDDER IS A CORPORATION

STATE OF NEW YORK, COUNTY OF _____ ss:

_____ being duly sworn says:
I am the _____ of the above named corporation whose name is subscribed to and which executed the foregoing bid. I reside at _____
I have knowledge of the several matters therein stated, and they are in all respects true.

(Signature of Corporate Officer who signed the Bid)

Subscribed and sworn to before me this
_____ day of _____, _____

Notary Public

AFFIRMATION

PROJECT ID. HWPEDSF1

The undersigned bidder affirms and declares that said bidder is not in arrears to the City of New York upon debt, contract or taxes and is not a defaulter, as surety or otherwise, upon obligation to the City of New York, and has not been declared not responsible, or disqualified, by any agency of the City of New York, nor is there any proceeding pending relating to the responsibility or qualification of the bidder to receive public contracts except: _____

(If none, the bidder shall insert the word "None" in the space provided above.)

Full Name of Bidder: _____

Address: _____

City _____ State _____ Zip Code _____

CHECK ONE BOX AND INCLUDE APPROPRIATE NUMBER:

A - Individual or Sole Proprietorship*
SOCIAL SECURITY NUMBER

B - Partnership, Joint Venture or other unincorporated organization
EMPLOYER IDENTIFICATION NUMBER

C- Corporation
EMPLOYER IDENTIFICATION NUMBER

By: _____

Signature

Title: _____

If a corporation, place seal here

This affirmation must be signed by an officer or duly authorized representative.

*Under the Federal Privacy Act the furnishing of Social Security Numbers by bidders on City contracts is voluntary. Failure to provide a Social Security Number will not result in a bidder's disqualification. Social Security Numbers will be used to identify bidders, proposers or vendors to ensure their compliance with laws, to assist the City in enforcement of laws, as well as to provide the City a means of identifying of businesses which seek City contracts.

(NO TEXT ON THIS PAGE)

BID BOND 1
FORM OF BID BOND

KNOW ALL MEN BY THESE PRESENTS. That we, _____

hereinafter referred to as the "Principal", and _____

hereinafter referred to as the "Surety" are held and firmly bound to THE CITY OF NEW YORK,
hereinafter referred to as the "CITY", or to its successors and assigns in the penal sum of _____

(\$ _____), Dollars lawful money of the United States, for the payment of which said sum of
money well and truly to be made, we, and each of us, bind ourselves, our heirs, executors, administrators,
successors and assigns, jointly and severally, firmly by these presents.

Whereas, the Principal is about to submit (or has submitted) to the City the accompanying
proposal, hereby made a part hereof, to enter into a contract in writing for _____

NOW, THEREFORE, the conditions of this obligation are such that if the Principal shall not
withdraw said Proposal without the consent of the City for a period of forty-five (45) days after the
opening of bids and in the event of acceptance of the Principal's Proposal by the City, if the Principal
shall:

- (a) Within ten (10) days after notification by the City, execute in quadruplicate and deliver
to the City all the executed counterparts of the Contract in the form set forth in the Contract Documents,
in accordance with the proposal as accepted, and
- (b) Furnish a performance bond and separate payment bond, as may be required by the City,
for the faithful performance and proper fulfillment of such Contract, which bonds shall be satisfactory in
all respects to the City and shall be executed by good and sufficient sureties, and
- (c) In all respects perform the agreement created by the acceptance of said Proposal as
provided in the Information for Bidders, bound herewith and made a part hereof, or if the City shall reject
the aforesaid Proposal, then this obligation shall be null and void; otherwise to remain in full force and
effect.

BID BOND 2

In the event that the Proposal of the Principal shall be accepted and the Contract be awarded to him the Surety hereunder agrees subject only to the payment by the Principal of the premium therefore, if requested by the City, to write the aforementioned performance and payment bonds in the form set forth in the Contract Documents.

It is expressly understood and agreed that the liability of the Surety for any and all claims hereunder shall in no event exceed the penal amount of this obligation as herein stated.

There shall be no liability under this bond if, in the event of the acceptance of the Principal's Proposal by the City, either a performance bond or payment bond, or both, shall not be required by the City on or before the 30th day after the date on which the City signs the Contract.

The surety, for the value received, hereby stipulates and agrees that the obligations of the Surety and its bond shall in no way be impaired or affected by any postponements of the date upon which the City will receive or open bids, or by any extensions of the time within which the City may accept the Principal's Proposal, or by any waiver by the City of any of the requirements of the Information for Bidders, and the Surety hereby waives notice of any such postponements, extensions, or waivers.

IN WITNESS WHEREOF, the Principal and the Surety have hereunto set their hands and seals and such of them as are corporations have caused their corporate seals to be hereto affixed and these presents to be signed by their proper officers the _____ day of _____, _____.

(Seal) _____ (L.S.)
Principal

By: _____

(Seal) _____
Surety

By: _____

BID BOND 3

ACKNOWLEDGMENT OF PRINCIPAL, IF A CORPORATION

State of _____ County of _____ ss:
On this _____ day of _____, _____, before me personally came
_____ to me known, who, being by me duly sworn, did depose and say
that he resides at _____
that he is the _____ of _____
the corporation described in and which executed the foregoing instrument; that he knows the seal of said
corporation; that one of the seals affixed to said instrument is such seal; that it was so affixed by order of
the directors of said corporation, and that he signed his name thereto by like order.

Notary Public

ACKNOWLEDGMENT OF PRINCIPAL, IF A PARTNERSHIP

State of _____ County of _____ ss:
On this _____ day of _____, _____, before me personally appeared
_____ to me known and known to me to be one of the members of the
firm of _____ described in and who executed the foregoing
instrument, and he acknowledged to me that he executed the same as and for the act and deed of said
firm.

Notary Public

ACKNOWLEDGMENT OF PRINCIPAL, IF AN INDIVIDUAL

State of _____ County of _____ ss:
On this _____ day of _____, _____, before me personally appeared
_____ to me known and known to me to be the person described in
and who executed the foregoing instrument and acknowledged that he executed the same.

Notary Public

AFFIX ACKNOWLEDGMENTS AND JUSTIFICATION OF SURETIES

(NO TEXT ON THIS PAGE)

M/WBE PROGRAM

M/WBE UTILIZATION PLAN

M/WBE Program Requirements: The requirements for the M/WBE Program are set forth on the following pages of this Bid Booklet, in the section entitled "Notice to All Prospective Contractors".

Schedule B: M/WBE Utilization Plan: Schedule B: M/WBE Utilization Plan for this Contract is set forth in this Bid Booklet on the pages following the section entitled "Notice to All Prospective Contractors". The M/WBE Utilization Plan (Part I) indicates whether Participation Goals have been established for this Contract. If Participation Goals have been established for this Contract, the bidder must submit an M/WBE Utilization Plan (Part II) with its bid.

Waiver: The bidder may seek a full or partial pre-award waiver of the Participation Goals in accordance with the "Notice to All Prospective Contractors" (See Part A, Section 10). The bidder's request for a waiver must be submitted at least seven (7) calendar days prior to the bid date. Waiver requests submitted after the deadline will not be considered. The form for requesting a waiver of the Participation Goals is set forth in the M/WBE Utilization Plan (Part III).

Rejection of the Bid: The bidder must complete Schedule B: M/WBE Utilization Plan (Part II) set forth in this Bid Booklet on the pages following the section entitled "Notice to All Prospective Contractors". A Schedule B submitted by the bidder which does not include the Vendor Certification and Required Affirmations (See Section V of Part II) will be deemed to be non-responsive, unless a full waiver of the Participation Goals is granted (Schedule B, Part III). In the event that the City determines that the bidder has submitted a Schedule B where the Vendor Certification and Required Affirmations are completed but other aspects of the Schedule B are not complete, or contain a copy or computation error that is at odds with the Vendor Certification and Required Affirmations, the bidder will be notified by the Agency and will be given four (4) calendar days from receipt of notification to cure the specified deficiencies and return a completed Schedule B to the Agency. Failure to do so will result in a determination that the Bid is non-responsive. Receipt of notification is defined as the date notice is emailed or faxed (if the bidder has provided an email address or fax number), or no later than five (5) calendar days from the date of mailing or upon delivery, if delivered.

Impact on LBE Requirements: If Participation Goals have been established for the participation of M/WBEs, the contractor is not required to comply with the Locally Based Enterprise Program ("LBE"). The LBE Program is set forth in Article 67 of the Contract.

NOTICE TO ALL PROSPECTIVE CONTRACTORS

**PARTICIPATION BY MINORITY-OWNED AND WOMEN-OWNED BUSINESS
ENTERPRISES IN CITY PROCUREMENT**

ARTICLE I. M/WBE PROGRAM

Local Law No. 129 of 2005 added and Local Law 1 of 2013 amended Section 6-129 of the Administrative Code of the City of New York (hereinafter "Section 6-129"). Section 6-129 establishes the program for participation in City procurement ("M/WBE Program") by minority-owned business enterprises ("MBEs") and women-owned business enterprises ("WBEs"), certified in accordance with Section 1304 of the New York City Charter. As stated in Section 6-129, the intent of the program is to address the impact of discrimination on the City's procurement process, and to promote the public interest in avoiding fraud and favoritism in the procurement process, increasing competition for City business, and lowering contract costs. The contract provisions contained herein are pursuant to Section 6-129, and the rules of the Department of Small Business Services ("DSBS") promulgated thereunder.

If this Contract is subject to the M/WBE Program established by Section 6-129, the specific requirements of MBE and/or WBE participation for this Contract are set forth in Schedule B of the Contract (entitled the "M/WBE Utilization Plan"), and are detailed below. The Contractor must comply with all applicable MBE and WBE requirements for this Contract.

All provisions of Section 6-129 are hereby incorporated in the Contract by reference and all terms used herein that are not defined herein shall have the meanings given such terms in Section 6-129. Article I, Part A, below, sets forth provisions related to the participation goals for construction, standard and professional services contracts. Article I, Part B, below, sets forth miscellaneous provisions related to the M/WBE Program.

PART A

**PARTICIPATION GOALS FOR CONSTRUCTION, STANDARD
AND PROFESSIONAL SERVICES CONTRACTS OR TASK ORDERS**

1. The MBE and/or WBE Participation Goals established for this Contract or Task Orders issued pursuant to this Contract, ("Participation Goals"), as applicable, are set forth on Schedule B, Part I to this Contract (see Page 1, line 1 Total Participation Goals) or will be set forth on Schedule B, Part I to Task Orders issued pursuant to this Contract, as applicable.

The Participation Goals represent a percentage of the total dollar value of the Contract or Task Order, as applicable, that may be achieved by awarding subcontracts to firms certified with New York City Department of Small Business Services as MBEs and/or WBEs, and/or by crediting the participation of prime contractors and/or qualified joint ventures as provided in Section 3 below, unless the goals have been waived or modified by Agency in accordance with Section 6-129 and Part A, Sections 10 and 11 below, respectively.

2. If Participation Goals have been established for this Contract or Task Orders issued pursuant to this Contract, Contractor agrees or shall agree as a material term of the Contract that Contractor shall be subject to the Participation Goals, unless the goals are waived or modified by Agency in accordance with Section 6-129 and Part A, Sections 10 and 11 below, respectively.

3. If Participation Goals have been established for this Contract or Task Order issued pursuant to this Contract, a Contractor that is an MBE and/or WBE shall be permitted to count its own participation toward fulfillment of the relevant Participation Goal, provided that in accordance with Section 6-129 the value of Contractor's participation shall be determined by subtracting from the total value of the Contract or Task Order, as applicable, any amounts that the Contractor pays to direct subcontractors (as defined in Section 6-129(c)(13)), and provided further that a Contractor that is certified as both an MBE and a WBE may count its own participation either toward the goal for MBEs or the goal for WBEs, but not both.

A Contractor that is a qualified joint venture (as defined in Section 6-129(c)(30)) shall be permitted to count a percentage of its own participation toward fulfillment of the relevant **Participation Goal**. In accordance with Section 6-129, the value of Contractor's participation shall be determined by subtracting from the total value of the Contract or Task Order, as applicable, any amounts that Contractor pays to direct subcontractors, and then multiplying the remainder by the percentage to be applied to total profit to determine the amount to which an MBE or WBE is entitled pursuant to the joint venture agreement, provided that where a participant in a joint venture is certified as both an MBE and a WBE, such amount shall be counted either toward the goal for MBEs or the goal for WBEs, but not both.

4. A. If **Participation Goals** have been established for this Contract, a prospective contractor shall be required to submit with its bid or proposal, as applicable, a completed Schedule B, M/WBE Utilization Plan, Part II (see Pages 2-4) indicating: (a) whether the contractor is an MBE or WBE, or qualified joint venture; (b) the percentage of work it intends to award to direct subcontractors; and (c) in cases where the contractor intends to award direct subcontracts, a description of the type and dollar value of work designated for participation by MBEs and/or WBEs, and the time frames in which such work is scheduled to begin and end. In the event that this M/WBE Utilization Plan indicates that the bidder or proposer, as applicable, does not intend to meet the **Participation Goals**, the bid or proposal, as applicable, shall be deemed non-responsive, unless Agency has granted the bidder or proposer, as applicable, a pre-award waiver of the Participation Goals in accordance with Section 6-129 and Part A, Section 10 below.

B. (i) If this Contract is for a master services agreement or other requirements type contract that will result in the issuance of Task Orders that will be individually registered ("Master Services Agreement") and is subject to M/WBE **Participation Goals**, a prospective contractor shall be required to submit with its bid or proposal, as applicable, a completed Schedule B, M/WBE Participation Requirements for Master Services Agreements That Will Require Individually Registered Task Orders, Part II (page 2) indicating the prospective contractor's certification and required affirmations to make all reasonable good faith efforts to meet participation goals established on each individual Task Order issued pursuant to this Contract, or if a partial waiver is obtained or such goals are modified by the Agency, to meet the modified **Participation Goals** by soliciting and obtaining the participation of certified MBE and/or WBE firms. In the event that the Schedule B indicates that the bidder or proposer, as applicable, does not intend to meet the **Participation Goals** that may be established on Task Orders issued pursuant to this Contract, the bid or proposal, as applicable, shall be deemed nonresponsive.

(ii) **Participation Goals** on a Master Services Agreement will be established for individual Task Orders issued after the Master Services Agreement is awarded. If **Participation Goals** have been established on a Task Order, a contractor shall be required to submit a Schedule B - M/WBE Utilization Plan For Independently Registered Task Orders That Are Issued Pursuant to Master Services Agreements, Part II (see Pages 2-4) indicating: (a) whether the contractor is an MBE or WBE, or qualified joint venture; (b) the percentage of work it intends to award to direct subcontractors; and (c) in cases where the contractor intends to award direct subcontracts, a description of the type and dollar value of work designated for participation by MBEs and/or WBEs, and the time frames in which such work is scheduled to begin and end. The contractor must engage in good faith efforts to meet the **Participation Goals** as established for the Task Order unless Agency has granted the contractor a pre-award waiver of the Participation Goals in accordance with Section 6-129 and Part A, Section 10 below.

C. **THE BIDDER/PROPOSER MUST COMPLETE THE SCHEDULE B INCLUDED HEREIN (SCHEDULE B, PART II). A SCHEDULE B SUBMITTED BY THE BIDDER/PROPOSER WHICH DOES NOT INCLUDE THE VENDOR CERTIFICATION AND REQUIRED AFFIRMATIONS (SEE SECTION V OF PART II) WILL BE DEEMED TO BE NON-RESPONSIVE, UNLESS A FULL WAIVER OF THE PARTICIPATION GOALS IS GRANTED (SCHEDULE B, PART III). IN THE EVENT THAT THE CITY DETERMINES THAT THE BIDDER/PROPOSER HAS SUBMITTED A SCHEDULE B WHERE THE VENDOR CERTIFICATION AND REQUIRED AFFIRMATIONS ARE COMPLETED BUT OTHER ASPECTS OF THE SCHEDULE B ARE NOT COMPLETE, OR CONTAIN A COPY OR COMPUTATION ERROR THAT IS AT ODDS WITH THE VENDOR CERTIFICATION AND AFFIRMATIONS, THE BIDDER/PROPOSER WILL BE NOTIFIED BY THE AGENCY AND WILL BE GIVEN FOUR (4) CALENDAR DAYS FROM RECEIPT OF NOTIFICATION TO CURE THE SPECIFIED DEFICIENCIES AND RETURN A COMPLETED SCHEDULE B TO THE AGENCY. FAILURE TO DO**

SO WILL RESULT IN A DETERMINATION THAT THE BID/PROPOSAL IS NON-RESPONSIVE. RECEIPT OF NOTIFICATION IS DEFINED AS THE DATE NOTICE IS E-MAILED OR FAXED (IF THE BIDDER/PROPOSER HAS PROVIDED AN E-MAIL ADDRESS OR FAX NUMBER), OR NO LATER THAN FIVE (5) CALENDAR DAYS FROM THE DATE OF MAILING OR UPON DELIVERY, IF DELIVERED.

5. Where an M/WBE Utilization Plan has been submitted, the Contractor shall, within 30 days of issuance by Agency of a notice to proceed, submit a list of proposed persons or entities to which it intends to award subcontracts within the subsequent 12 months. In the case of multiyear contracts, such list shall also be submitted every year thereafter. The Agency may also require the Contractor to report periodically about the contracts awarded by its direct subcontractors to indirect subcontractors (as defined in Section 6-129(c)(22)). **PLEASE NOTE: If this Contract is a public works project subject to GML §101(5) (i.e., a contract valued at or below \$3M for projects in New York City) or if the Contract is subject to a project labor agreement in accordance with Labor Law §222, and the bidder is required to identify at the time of bid submission its intended subcontractors for the Wicks trades (plumbing and gas fitting; steam heating, hot water heating, ventilating and air conditioning (HVAC); and electric wiring), the Contractor must identify all those to which it intends to award construction subcontracts for any portion of the Wicks trade work at the time of bid submission, regardless of what point in the life of the contract such subcontracts will occur. In identifying intended subcontractors in the bid submission, bidders may satisfy any Participation Goals established for this Contract by proposing one or more subcontractors that are MBEs and/or WBEs for any portion of the Wicks trade work. In the event that the Contractor's selection of a subcontractor is disapproved, the Contractor shall have a reasonable time to propose alternate subcontractors.**

6. MBE and WBE firms must be certified by DSBS in order for the Contractor to credit such firms' participation toward the attainment of the **Participation Goals**. Such certification must occur prior to the firms' commencement of work. A list of MBE and WBE firms may be obtained from the DSBS website at www.nyc.gov/buycertified, by emailing DSBS at buyer@sbs.nyc.gov, by calling (212) 513-6356, or by visiting or writing DSBS at 110 William St., New York, New York, 10038, 7th floor. Eligible firms that have not yet been certified may contact DSBS in order to seek certification by visiting www.nyc.gov/getcertified, emailing MWBE@sbs.nyc.gov, or calling the DSBS certification helpline at (212) 513-6311. A firm that is certified as both an MBE and a WBE may be counted either toward the goal for MBEs or the goal for WBEs, but not both. No credit shall be given for participation by a graduate MBE or graduate WBE, as defined in Section 6-129(c)(20).

7. Where an M/WBE Utilization Plan has been submitted, the Contractor shall, with each voucher for payment, and/or periodically as Agency may require, submit statements, certified under penalty of perjury, which shall include, but not be limited to, the total amount the Contractor paid to its direct subcontractors, and, where applicable pursuant to Section 6-129(j), the total amount direct subcontractors paid to indirect subcontractors; the names, addresses and contact numbers of each MBE or WBE hired as a subcontractor by the Contractor, and, where applicable, hired by any of the Contractor's direct subcontractors; and the dates and amounts paid to each MBE or WBE. The Contractor shall also submit, along with its voucher for final payment: the total amount it paid to subcontractors, and, where applicable pursuant to Section 6-129(j), the total amount its direct subcontractors paid directly to their indirect subcontractors; and a final list, certified under penalty of perjury, which shall include the name, address and contact information of each subcontractor that is an MBE or WBE, the work performed by, and the dates and amounts paid to each.

8. If payments made to, or work performed by, MBEs or WBEs are less than the amount specified in the Contractor's M/WBE Utilization Plan, Agency shall take appropriate action, in accordance with Section 6-129 and Article II below, unless the Contractor has obtained a modification of its M/WBE Utilization Plan in accordance with Section 6-129 and Part A, Section 11 below.

9. Where an M/WBE Utilization Plan has been submitted, and the Contractor requests a change order the value of which exceeds the greater of 10 percent of the Contract or Task Order, as applicable, or \$500,000, Agency shall review the scope of work for the Contract or Task Order, as applicable, and the scale and types of work involved in the change order, and determine whether the **Participation Goals** should be modified.

10. Pre-award waiver of the **Participation Goals**. (a) A bidder or proposer, or contractor with respect to a Task Order, may seek a pre-award full or partial waiver of the **Participation Goals** in accordance with Section 6-129, which requests that Agency change one or more **Participation Goals** on the grounds that the **Participation Goals** are unreasonable in light of the availability of certified firms to perform the services required, or by demonstrating that it has legitimate business reasons for proposing a lower level of subcontracting in its M/WBE Utilization Plan.

(b) To apply for a full or partial waiver of the **Participation Goals**, a bidder, proposer, or contractor, as applicable, must complete Part III (Page 5) of Schedule B and submit such request no later than seven (7) calendar days prior to the date and time the bids, proposals, or Task Orders are due, in writing to the Agency by email at poped@ddc.nyc.gov or via facsimile at (718) 391-1886. Bidders, proposers, or contractors, as applicable, who have submitted requests will receive an Agency response by no later than two (2) calendar days prior to the due date for bids, proposals, or Task Orders; provided, however, that if that date would fall on a weekend or holiday, an Agency response will be provided by close-of-business on the business day before such weekend or holiday date.

(c) If the Agency determines that the **Participation Goals** are unreasonable in light of the availability of certified firms to perform the services required, it shall revise the solicitation and extend the deadline for bids and proposals, or revise the Task Order, as applicable.

(d) Agency may grant a full or partial waiver of the **Participation Goals** to a bidder, proposer or contractor, as applicable, who demonstrates—before submission of the bid, proposal or Task Order, as applicable—that it has legitimate business reasons for proposing the level of subcontracting in its M/WBE Utilization Plan. In making its determination, Agency shall consider factors that shall include, but not be limited to, whether the bidder, proposer or contractor, as applicable, has the capacity and the bona fide intention to perform the Contract without any subcontracting, or to perform the Contract without awarding the amount of subcontracts represented by the **Participation Goals**. In making such determination, Agency may consider whether the M/WBE Utilization Plan is consistent with past subcontracting practices of the bidder, proposer or contractor, as applicable, whether the bidder, proposer or contractor, as applicable, has made efforts to form a joint venture with a certified firm, and whether the bidder, proposer, or contractor, as applicable, has made good faith efforts to identify other portions of the Contract that it intends to subcontract.

11. Modification of M/WBE Utilization Plan. (a) A Contractor may request a modification of its M/WBE Utilization Plan after award of this Contract. **PLEASE NOTE: If this Contract is a public works project subject to GML §101(5) (i.e., a contract valued at or below \$3M for projects in New York City) or if the Contract is subject to a project labor agreement in accordance with Labor Law §222, and the bidder is required to identify at the time of bid submission its intended subcontractors for the Wicks trades (plumbing and gas fitting; steam heating, hot water heating, ventilating and air conditioning (HVAC); and electric wiring), the Contractor may request a Modification of its M/WBE Utilization Plan as part of its bid submission.** The Agency may grant a request for Modification of a Contractor's M/WBE Utilization Plan if it determines that the Contractor has established, with appropriate documentary and other evidence, that it made reasonable, good faith efforts to meet the **Participation Goals**. In making such determination, Agency shall consider evidence of the following efforts, as applicable, along with any other relevant factors:

- (i) The Contractor advertised opportunities to participate in the Contract, where appropriate, in general circulation media, trade and professional association publications and small business media, and publications of minority and women's business organizations;
- (ii) The Contractor provided notice of specific opportunities to participate in the Contract, in a timely manner, to minority and women's business organizations;
- (iii) The Contractor sent written notices, by certified mail or facsimile, in a timely manner, to advise MBEs or WBEs that their interest in the Contract was solicited;
- (iv) The Contractor made efforts to identify portions of the work that could be substituted for portions originally designated for participation by MBEs and/or WBEs in the M/WBE Utilization Plan, and for which the Contractor claims an inability to retain MBEs or WBEs;

- (v) The Contractor held meetings with MBEs and/or WBEs prior to the date their bids or proposals were due, for the purpose of explaining in detail the scope and requirements of the work for which their bids or proposals were solicited;
- (vi) The Contractor made efforts to negotiate with MBEs and/or WBEs as relevant to perform specific subcontracts, or act as suppliers or service providers;
- (vii) Timely written requests for assistance made by the Contractor to Agency's M/WBE liaison officer and to DSBS;
- (viii) Description of how recommendations made by DSBS and Agency were acted upon and an explanation of why action upon such recommendations did not lead to the desired level of participation of MBEs and/or WBEs.

Agency's M/WBE officer shall provide written notice to the Contractor of the determination.

(b) The Agency may modify the **Participation Goals** when the scope of the work has been changed by the Agency in a manner that affects the scale and types of work that the Contractor indicated in its M/WBE Utilization Plan would be awarded to subcontractors.

12. If this Contract is for an indefinite quantity of construction, standard or professional services or is a requirements type contract and the Contractor has submitted an M/WBE Utilization Plan and has committed to subcontract work to MBEs and/or WBEs in order to meet the **Participation Goals**, the Contractor will not be deemed in violation of the M/WBE Program requirements for this Contract with regard to any work which was intended to be subcontracted to an MBE and/or WBE to the extent that the Agency has determined that such work is not needed.

13. If **Participation Goals** have been established for this Contract or a Task Order issued pursuant to this Contract, at least once annually during the term of the Contract or Task Order, as applicable, Agency shall review the Contractor's progress toward attainment of its M/WBE Utilization Plan, including but not limited to, by reviewing the percentage of work the Contractor has actually awarded to MBE and/or WBE subcontractors and the payments the Contractor made to such subcontractors.

14. If **Participation Goals** have been established for this Contract or a Task Order issued pursuant to this Contract, Agency shall evaluate and assess the Contractor's performance in meeting those goals, and such evaluation and assessment shall become part of the Contractor's overall contract performance evaluation.

PART B: MISCELLANEOUS

1. The Contractor shall take notice that, if this solicitation requires the establishment of an M/WBE Utilization Plan, the resulting contract may be audited by DSBS to determine compliance with Section 6-129. See §6-129(e)(10). Furthermore, such resulting contract may also be examined by the City's Comptroller to assess compliance with the M/WBE Utilization Plan.

2. Pursuant to DSBS rules, construction contracts that include a requirement for an M/WBE Utilization Plan shall not be subject to the law governing Locally Based Enterprises set forth in Section 6-108.1 of the Administrative Code of the City of New York.

3. DSBS is available to assist contractors and potential contractors in determining the availability of MBEs and/or WBEs to participate as subcontractors, and in identifying opportunities that are appropriate for participation by MBEs and/or WBEs in contracts.

4. Prospective contractors are encouraged to enter into qualified joint venture agreements with MBEs and/or WBEs as defined by Section 6-129(c)(30).

5. By submitting a bid or proposal the Contractor hereby acknowledges its understanding of the M/WBE Program requirements set forth herein and the pertinent provisions of Section 6-129, and any rules promulgated thereunder, and if awarded this Contract, the Contractor hereby agrees to comply with the M/WBE Program requirements of this Contract and pertinent provisions of Section 6-129, and any rules promulgated thereunder, all of which shall be deemed to be material terms of this Contract. The Contractor hereby agrees to make all reasonable, good faith efforts to solicit and obtain the participation of MBEs and/or WBEs to meet the required **Participation Goals**.

ARTICLE II. ENFORCEMENT

1. If Agency determines that a bidder or proposer, as applicable, has, in relation to this procurement, violated Section 6-129 or the DSBS rules promulgated pursuant to Section 6-129, Agency may disqualify such bidder or proposer, as applicable, from competing for this Contract and the Agency may revoke such bidder's or proposer's prequalification status, if applicable.

2. Whenever Agency believes that the Contractor or a subcontractor is not in compliance with Section 6-129 or the DSBS rules promulgated pursuant to Section 6-129, or any provision of this Contract that implements Section 6-129, including, but not limited to any **M/WBE Utilization Plan**, Agency shall send a written notice to the Contractor describing the alleged noncompliance and offering the Contractor an opportunity to be heard. Agency shall then conduct an investigation to determine whether such Contractor or subcontractor is in compliance.

3. In the event that the Contractor has been found to have violated Section 6-129, the DSBS rules promulgated pursuant to Section 6-129, or any provision of this Contract that implements Section 6-129, including, but not limited to, any **M/WBE Utilization Plan**, Agency may determine that one of the following actions should be taken:

- (a) entering into an agreement with the Contractor allowing the Contractor to cure the violation;
- (b) revoking the Contractor's pre-qualification to bid or make proposals for future contracts;
- (c) making a finding that the Contractor is in default of the Contract;
- (d) terminating the Contract;
- (e) declaring the Contractor to be in breach of Contract;
- (f) withholding payment or reimbursement;
- (g) determining not to renew the Contract;
- (h) assessing actual and consequential damages;
- (i) assessing liquidated damages or reducing fees, provided that liquidated damages may be based on amounts representing costs of delays in carrying out the purposes of the M/WBE Program, or in meeting the purposes of the Contract, the costs of meeting utilization goals through additional procurements, the administrative costs of investigation and enforcement, or other factors set forth in the Contract;
- (j) exercising rights under the Contract to procure goods, services or construction from another contractor and charge the cost of such contract to the Contractor that has been found to be in noncompliance; or
- (k) taking any other appropriate remedy.

4. If an **M/WBE Utilization Plan** has been submitted, and pursuant to this Article II, Section 3, the Contractor has been found to have failed to fulfill its **Participation Goals** contained in its **M/WBE Utilization Plan** or the **Participation Goals** as modified by Agency pursuant to Article I, Part A, Section 11, Agency may assess liquidated damages in the amount of ten percent (10%) of the difference between the dollar amount of work required to be awarded to MBE and/or WBE firms to meet the **Participation Goals** and the dollar amount the Contractor actually awarded and paid, and/or credited, to MBE and/or WBE firms. In view of the difficulty of accurately ascertaining the loss which the City will suffer by reason of Contractor's failure to meet the **Participation Goals**, the foregoing amount is hereby fixed and agreed as the liquidated damages that the City will suffer by reason of such failure, and not as a penalty. Agency may deduct and retain out of any monies which may become due under this Contract the amount of any such liquidated damages; and in case the amount which may become due under this Contract shall be less than the amount of liquidated damages suffered by the City, the Contractor shall be liable to pay the difference.

5. Whenever Agency has reason to believe that an MBE and/or WBE is not qualified for certification, or is participating in a contract in a manner that does not serve a commercially useful function (as defined in Section 6-129(c)(8)), or has violated any provision of Section 6-129, Agency shall notify the Commissioner of DSBS who shall determine whether the certification of such business enterprise should be revoked.

6. Statements made in any instrument submitted to Agency pursuant to Section 6-129 shall be submitted under penalty of perjury and any false or misleading statement or omission shall be grounds for the application of any applicable criminal and/or civil penalties for perjury. The making of a false or fraudulent statement by an MBE and/or WBE in any instrument submitted pursuant to Section 6-129 shall, in addition, be grounds for revocation of its certification.

7. The Contractor's record in implementing its M/WBE Utilization Plan shall be a factor in the evaluation of its performance. Whenever Agency determines that a Contractor's compliance with an M/WBE Utilization Plan has been unsatisfactory, Agency shall, after consultation with the City Chief Procurement Officer, file an advice of caution form for inclusion in VENDEX as caution data.

Tax ID #: _____

SCHEDULE B – MWBE Utilization Plan
Part I: MWBE Participation Goals
Part I to be completed by contracting agency

Contract Overview	
APT E- Pin #	85015B0051
Project Title/ Agency PIN #	MULTI-SITE PEDESTRIAN SAFETY / 8502013HW0079C
Bid/Proposal Response Date	
Contracting Agency	Department of Design and Construction
Agency Address	30-30 Thomson Ave. City Long Island City State NY Zip Code 11101
Contact Person	Jessica Lavidès Title MWBE Liaison & Compliance Analyst
Telephone #	(718) 391-1065 Email LavidèsJe@ddc.nyc.gov

Project Description (attach additional pages if necessary)

**MULTI-SITE PEDESTRIAN SAFETY
 WHICH INCLUDES THE FOLLOWING INTERSECTIONS:**

31ST STREET AND 39TH AVENUE
 31ST STREET AND 36TH AVENUE
 31ST STREET AND BROADWAY

**INCLUDING BUS BULBOUTS, CURB EXTENSIONS, BUS PADS,
 PEDESTRIAN RAMPS, CATCH BASINS, PAVEMENT MARKINS,
 STREET LIGHTING, AND TRAFFIC SIGNAL WORK**

Together With All Work Incidental Thereto
**BOROUGH OF QUEENS
 CITY OF NEW YORK**

MWBE Participation Goals for Services
Enter the percentage amount for each group or for an unspecified goal. Please note that there are no goals for Asian Americans in Professional Services.

Prime Contract Industry: **Construction**

Group	Percentage
Unspecified*	EXEMPT %
or	
Black American	UNSPECIFIED*
Hispanic American	UNSPECIFIED*
Asian American	UNSPECIFIED*
Women	UNSPECIFIED*
Total Participation Goals	EXEMPT % Line 1

**Note: For this procurement, individual ethnicity and gender goals are not specified. The Total Participation Goal for construction contracts may be met by using either Black-American, Hispanic-American, Asian American, or Women certified firms or any combination of such firms.*

Tax ID #: _____

APT E-
PIN #: _____

SCHEDULE B - Part II: M/WBE Participation Plan

Part II to be completed by the bidder/proposer.

Please note: For Non-M/WBE Prime Contractors who will NOT subcontract any services and will self-perform the entire contract, you must obtain a FULL waiver by completing the Waiver Application on pages 17 and 18 and timely submitting it to the contracting agency pursuant to the Notice to Prospective Contractors. Once a FULL WAIVER is granted, it must be included with your bid or proposal and you do not have to complete or submit this form with your bid or proposal.

Section I: Prime Contractor Contact Information

Tax ID #	_____	FMS Vendor ID #	_____
Business Name	_____	Contact Person	_____
Address	_____		
Telephone #	_____	Email	_____

Section II: M/WBE Utilization Goal Calculation: Check the applicable box and complete subsection.

PRIME CONTRACTOR ADOPTING AGENCY M/WBE PARTICIPATION GOALS

<input type="checkbox"/> For Prime Contractors (including Qualified Joint Ventures and M/WBE firms) adopting Agency M/WBE Participation Goals. Calculate the total dollar value of your total bid that you agree will be awarded to M/WBE subcontractors for services and/or credited to an M/WBE prime contractor or Qualified Joint Venture. Please review the Notice to Prospective Contractors for more information on how to obtain credit for M/WBE participation.	Total Bid/Proposal Value	Agency Total Participation Goals (Line 1, Page 13)	Calculated M/WBE Participation Amount
	\$ _____ X	=	\$ _____ Line 2

PRIME CONTRACTOR OBTAINED PARTIAL WAIVER APPROVAL: ADOPTING MODIFIED M/WBE PARTICIPATION GOALS

<input type="checkbox"/> For Prime Contractors (including Qualified Joint Ventures and M/WBE firms) adopting Modified M/WBE Participation Goals. Calculate the total dollar value of your total bid that you agree will be awarded to M/WBE subcontractors for services and/or credited to an M/WBE prime contractor or Qualified Joint Venture. Please review the Notice to Prospective Contractors for more information on how to obtain credit for M/WBE participation.	Total Bid/Proposal Value	Adjusted Participation Goal (From Partial Waiver)	Calculated M/WBE Participation Amount
	\$ _____ X	=	\$ _____ Line 3

Section III: M/WBE Utilization Plan: How Proposer/Bidder Will Fulfill M/WBE Participation Goals. Please review the Notice to Prospective Contractors for more information on how to obtain credit for M/WBE participation. Check applicable box. The Proposer or Bidder will fulfill the M/WBE Participation Goals:

As an M/WBE Prime Contractor that will self-perform and/or subcontract to other M/WBE firms a portion of the contract the value of which is at least the amount located on Lines 2 or 3 above, as applicable. The value of any work subcontracted to non-M/WBE firms will not be credited towards fulfillment of M/WBE Participation Goals. Please check all that apply to Prime Contractor:

MBE WBE

As a Qualified Joint Venture with an M/WBE partner, in which the value of the M/WBE partner's participation and/or the value of any work subcontracted to other M/WBE firms is at least the amount located on Lines 2 or 3 above, as applicable. The value of any work subcontracted to non M/WBE firms will not be credited towards fulfillment of M/WBE Participation Goals.

As a non M/WBE Prime Contractor that will enter into subcontracts with M/WBE firms the value of which is at least the amount located on Lines 2 or 3 above, as applicable.

Section IV: General Contract Information

What is the expected percentage of the total contract dollar value that you expect to award in subcontracts for services, regardless of M/WBE status? % _____

Enter brief description of the type(s) and dollar value of subcontracts for all/any services you plan on subcontracting if awarded this contract. For each item, indicate whether the work is designated for participation by MBEs and/or WBEs and the time frame in which such work is scheduled to begin and end. Use additional sheets if necessary.

✓ Scopes of Subcontract Work

1. _____
2. _____
3. _____
4. _____
5. _____
6. _____
7. _____
8. _____
9. _____
10. _____
11. _____
12. _____
13. _____
14. _____
15. _____
16. _____
17. _____

Tax ID #: _____

APT E-
PIN #: _____

Section V: Vendor Certification and Required Affirmations

- I hereby:
- 1) acknowledge my understanding of the M/WBE participation requirements as set forth herein and the pertinent provisions of Section 6-129 of the Administrative Code of the City of New York ("Section 6-129"), and the rules promulgated thereunder;
 - 2) affirm that the information supplied in support of this M/WBE Utilization Plan is true and correct;
 - 3) agree, if awarded this Contract, to comply with the M/WBE participation requirements of this Contract, the pertinent provisions of Section 6-129, and the rules promulgated thereunder, all of which shall be deemed to be material terms of this Contract;
 - 4) agree and affirm that it is a material term of this Contract that the Vendor will attain a total dollar value of the M/WBE Participation Goals to certified MBEs and/or WBEs, as a percentage of the total dollar value of the Contract, or such goals are modified by the Agency; and
 - 5) agree and affirm, if awarded this Contract, to make all reasonable, good faith efforts to meet the M/WBE Participation Goals, or If a partial waiver is obtained or such goals are modified by the Agency, to meet the modified Participation Goals by soliciting and obtaining the participation of certified MBE and/or WBE firms.

Signature _____
 Print Name _____ Title _____

SCHEDULE B – PART III – REQUEST FOR WAIVER OF M/WBE PARTICIPATION REQUIREMENT

Contract Overview

Tax ID # _____ FMS Vendor ID # _____
 Business Name _____
 Contact Name _____ Telephone # _____ Email _____
 Type of Procurement Competitive Sealed Bids Other _____ Bid/Response Due Date _____
 APT E-PIN # (for this procurement): _____ Contracting Agency: _____

M/WBE Participation Goals as described in bid/solicitation documents

_____ % Agency M/WBE Participation Goal

Proposed M/WBE Participation Goal as anticipated by vendor seeking waiver

_____ % of the total contract value anticipated in good faith by the bidder/proposer to be subcontracted for services and/or credited to an M/WBE Prime Contractor or Qualified Joint Venture.

Basis for Waiver Request: Check appropriate box & explain in detail below (attach additional pages if needed)

- Vendor does not subcontract services, and has the capacity and good faith intention to perform all such work itself with its own employees.
- Vendor subcontracts *some* of this type of work but at a *lower* % than bid/solicitation describes, and has the capacity and good faith intention to do so on this contract. (Attach subcontracting plan outlining services that the vendor will self-perform and subcontract to other vendors or consultants.)
- Vendor has other legitimate business reasons for proposing the M/WBE Participation Goal above. Explain under separate cover.

References

List 3 most recent contracts performed for NYC agencies (if any). Include information for each subcontract awarded in performance of such contracts. Add more pages if necessary.

CONTRACT NO.	AGENCY	DATE COMPLETED
Total Contract Amount \$ _____	Total Amount Subcontracted \$ _____	
Item of Work Subcontracted and Value of subcontract _____	Item of Work Subcontracted and Value of subcontract _____	Item of Work Subcontracted and Value of subcontract _____
CONTRACT NO. _____	AGENCY _____	DATE COMPLETED _____
Total Contract Amount \$ _____	Total Amount Subcontracted \$ _____	
Item of Work Subcontracted and Value of subcontract _____	Item of Work Subcontracted and Value of subcontract _____	Item of Work Subcontracted and Value of subcontract _____
CONTRACT NO. _____	AGENCY _____	DATE COMPLETED _____
Total Contract Amount \$ _____	Total Amount Subcontracted \$ _____	
Item of Work Subcontracted and Value of subcontract _____	Item of Work Subcontracted and Value of subcontract _____	Item of Work Subcontracted and Value of subcontract _____

List 3 most recent contracts performed for other entities. Include information for each subcontract awarded in performance of such contracts. Add more pages if necessary.

(Complete ONLY if vendor has performed fewer than 3 New York City contracts.)

TYPE OF Contract _____ ENTITY _____ DATE COMPLETED _____
 Manager at entity that hired vendor (Name/Phone No./Email) _____
 Total Contract Amount \$ _____ Total Amount Subcontracted \$ _____
 Type of Work Subcontracted _____

TYPE OF Contract _____ AGENCY/ENTITY _____ DATE COMPLETED _____
 Manager at agency/entity that hired vendor (Name/Phone No./Email) _____
 Total Contract Amount \$ _____ Total Amount Subcontracted \$ _____
 Item of Work Subcontracted and Value of subcontract _____ Item of Work Subcontracted and Value of subcontract _____

TYPE OF Contract _____ AGENCY/ENTITY _____ DATE COMPLETED _____
 Manager at entity that hired vendor (Name/Phone No./Email) _____
 Total Contract Amount \$ _____ Total Amount Subcontracted \$ _____
 Item of Work Subcontracted and Value of subcontract _____ Item of Work Subcontracted and Value of subcontract _____

VENDOR CERTIFICATION: I hereby affirm that the information supplied in support of this waiver request is true and correct, and that this request is made in good faith.

Signature: _____ Date: _____
 Print Name: _____ Title: _____

Shaded area below is for agency completion only

AGENCY CHIEF CONTRACTING OFFICER APPROVAL
 Signature: _____ Date: _____

CITY CHIEF PROCUREMENT OFFICER APPROVAL
 Signature: _____ Date: _____

Waiver Determination
 All Waiver Approved
 Waiver Denied
 Conditional Waiver Approved
 Required Participation Qualification

APPRENTICESHIP PROGRAM REQUIREMENTS

Bidders are advised that the Apprenticeship Program Requirements set forth below apply to each contract for which a check mark is indicated before the word "Yes". Compliance with these requirements will be determined solely by the City.

_____ YES NO

(1) Apprenticeship Program Requirements

Notice to Bidders: Please be advised that, pursuant to the authority granted to the City under Labor Law Section 816-b, the Department of Design and Construction hereby requires that the contractor awarded a contract as a result of this Invitation for Bids, and any of its subcontractors with subcontracts worth one million dollars or over, have, prior to entering into such contract or subcontract, apprenticeship agreements appropriate for the type and scope of work to be performed that have been registered with, and approved by, the New York State Commissioner of Labor. In addition, the contractor and its subcontractors will be required to show that such apprenticeship programs have three years of current, successful experience in providing career opportunities.

The failure to prove, upon request, that these requirements have been met shall result in the contract not being awarded to the contractor or the subcontract not being approved.

Please be further advised that, pursuant to Labor Law Section 220, the allowable ratio of apprentices to journeypersons in any craft classification shall not be greater than the ratio permitted to the contractor as to its workforce on any job under the registered apprenticeship program.

(2) Apprenticeship Program Questionnaire

The bidder must submit a completed and signed Apprenticeship Program Questionnaire. The Questionnaire is set forth on the following page of the Bid Booklet.

APPRENTICESHIP PROGRAM QUESTIONNAIRE

PROJECT ID: HWPEDSF1 HWPEDSF1

The bidder must submit a completed and signed Apprenticeship Program Questionnaire.

Name of Bidder: _____

1. Does the bidder have an Apprenticeship Program appropriate for the type and scope of work to be performed?
[Note: Participation may be by either direct sponsorship or through collective bargaining agreement(s).]

_____ YES _____ NO

2. Has the bidder's Apprenticeship Program been registered with, and approved by, the New York State Commissioner of Labor?

_____ YES _____ NO

3. Has the bidder's Apprenticeship Program had three years of successful experience in providing career opportunities?

_____ YES _____ NO

If the answer to Question #3 is "Yes", the bidder shall, in the space below, provide information regarding the experience the Apprenticeship Program has had in providing career opportunities. The bidder may attach additional pages if necessary.

Bidder: _____

By: _____ Title: _____
(Signature of Partner or Corporate Officer)

Date: _____

SAFETY QUESTIONNAIRE

The bidder must include, with its bid, all information requested on this Safety Questionnaire. Failure to provide a completed and signed Safety Questionnaire at the time of bid opening may result in disqualification of the bid as non-responsive.

1. Bidder Information:

Company Name: _____

DDC Project Number: _____

Company Size: _____ Ten (10) employees or less

_____ Greater than ten (10) employees

Company has previously worked for DDC _____ YES _____ NO

2. Type(s) of Construction Work

TYPE OF WORK	LAST 3 YEARS	THIS PROJECT
General Building Construction	_____	_____
Residential Building Construction	_____	_____
Nonresidential Building Construction	_____	_____
Heavy Construction, except building	_____	_____
Highway and Street Construction	_____	_____
Heavy Construction, except highways	_____	_____
Plumbing, Heating, HVAC	_____	_____
Painting and Paper Hanging	_____	_____
Electrical Work	_____	_____
Masonry, Stonework and Plastering	_____	_____
Carpentry and Floor Work	_____	_____
Roofing, Siding, and Sheet Metal	_____	_____
Concrete Work	_____	_____
Specialty Trade Contracting	_____	_____
Asbestos Abatement	_____	_____
Other (specify)	_____	_____
_____	_____	_____

3. Experience Modification Rate:

The Experience Modification Rate (EMR) is a rating generated by the National Council of Compensation Insurance (NCCI). This rating is used to determine the contractor's premium for worker's compensation insurance. The contractor may obtain its EMR by contacting its insurance broker or the NCCI. If the contractor cannot obtain its EMR, it must submit a written explanation as to why.

Project ID. _____

The Contractor must indicate its Intrastate and Interstate EMR for the past three years. [Note: For contractors with less than three years of experience, the EMR will be considered to be 1.00].

YEAR	<u>INTRASTATE</u> RATE	<u>INTERSTATE</u> RATE
_____	_____	_____
_____	_____	_____
_____	_____	_____

If the Intrastate and/or Interstate EMR for any of the past three years is greater than 1.00, the contractor must attach, to this questionnaire, a written explanation for the rating and identify what corrective action was taken to correct the situation resulting in that rating.

4. OSHA Information:

YES NO Contractor has received a willful violation issued by OSHA or New York City Department of Buildings (NYCDOB) within the last three years.

YES NO Contractor has had an incident requiring OSHA notification within 8 hours (i.e., fatality, or hospitalization of three or more employees).

The Occupational Safety and Health Act (OSHA) of 1970 requires employers with ten or more employees, on a yearly basis to complete and maintain on file the form entitled "Log of Work-related Injuries and Illnesses". This form is commonly referred to as the OSHA 300 Log (OSHA 200 Log for 2001 and earlier).

The OSHA 300 Log must be submitted for the last three years for contractors with more than ten employees.

The Contractor must indicate the total number of hours worked by its employees, as reflected in payroll records for the past three years.

The contractor must submit the Incident Rate for Lost Time Injuries (the Incident Rate) for the past three years. The Incident Rate is calculated in accordance with the formula set forth below. For each given year, the total number of incidents is the total number of non-fatal injuries and illnesses reported on the OSHA 300 Log. The 200,000 hours represents the equivalent of 100 employees working forty hours a week, fifty weeks per year.

$$\text{Incident Rate} = \frac{\text{Total Number of Incidents} \times 200,000}{\text{Total Number of Hours Worked by Employees}}$$

YEAR	TOTAL NUMBERS OF HOURS WORKED BY EMPLOYEES	INCIDENT RATE
_____	_____	_____
_____	_____	_____
_____	_____	_____

If the contractor's Incident Rate for any of the past three years is one point higher than the Incident Rate for the type of construction it performs (listed below), the contractor must attach, to this questionnaire, a written explanation for the relatively high rate.

General Building Construction	8.5
Residential Building Construction	7.0
Nonresidential Building Construction	10.2
Heavy Construction, except building	8.7
Highway and Street Construction	9.7
Heavy Construction, except highways	8.3
Plumbing, Heating, HVAC	11.3
Painting and Paper Hanging	6.9
Electrical Work	9.5
Masonry, Stonework and Plastering	10.5
Carpentry and Floor Work	12.2
Roofing, Siding, and Sheet Metal	10.3
Concrete Work	8.6
Specialty Trade Contracting	8.6

5. Safety Performance on Previous DDC Project(s)

YES NO Contractor previously audited by the DDC Office of Site Safety.

DDC Project Number(s): _____, _____, _____

YES NO Accident on previous DDC Project(s).

DDC Project Number(s): _____, _____, _____

YES NO Fatality or Life-altering Injury on DDC Project(s) within the last three years.
[Examples of a life-altering injury include loss of limb, loss of a sense (e.g., sight, hearing), or loss of neurological function].

DDC Project Number(s): _____, _____, _____

Date: _____

By: _____

(Signature of Owner, Partner, Corporate Officer)

Title: _____

(NO TEXT ON THIS PAGE)

Pre-Award Process

The bidder is advised that as part of the pre-award review of its bid, it may be required to submit the information described in Sections (A) through (D) below. If required, such information must be submitted by the bidder within five (5) business days following receipt of notification from DDC that it is among the low bidders. Such notification from DDC will be by facsimile or in writing and will specify the types of information must be submitted. The types of information the bidder may be required to submit are described below. In the event the bidder fails to submit the required information within the specified time frame, its bid may be rejected as nonresponsive.

- (A) **Project Reference Form:** If required, the bidder must complete and submit the Project Reference Form set forth on pages 26 through 28 of this Bid Booklet. The Project Reference Form consists of 3 parts: (1) Similar Contracts Completed by the Bidder, (2) Contracts Currently Under Construction by the Bidder, and (3) Pending Contracts Not Yet Started by the Bidder.
- (B) **Copy of License:** If required, the bidder must submit a copy of the license under which the bidder will be performing the work. Such license must clearly show the following: (1) Name of the Licensee, (2) License Number, and (3) Expiration date of the License. A copy of the license will be required from bidders for the following contracts: Plumbing Work, Electrical Work and Asbestos Abatement.
- (C) **Financial Information:** If required, the bidder must submit the financial information described below:
- (1) **Audited Financial Statements:** Financial statements (Balance Sheet and Income Statement) of the entity submitting the bid, as audited by an independent auditor licensed to practice as a certified public accountant (CPA). Audited financial statements for the three most recent fiscal years must be submitted. Each such financial statement must include the auditor's standard report.

If the bidder does not have audited financial statements, it must submit an affidavit attesting to the fact that the bidder does not have such statements. In addition, the bidder must submit the following documentation covering the three most recent fiscal years: signed federal tax returns, unaudited financial statements, and a "certified review letter" from a certified public accountant (CPA) verifying the unaudited financial statements.

Unless the most recent audited or unaudited financial statement was issued within ninety (90) days, the bidder must submit interim financial information that includes data on financial position and results of operation (income data) for the current fiscal year. Such information may be summarized on a monthly or quarterly basis or at other intervals.

- (2) **Schedule of Aged Accounts Receivable,** including portion due within ninety (90) days.

(D) **Project Specific Information:** If required, the bidder must submit the project specific information described below:

- (1) Statement indicating the number of years of experience the bidder has had and in what type of construction.
- (2) Resumes of all key personnel to be involved in the project, including the proposed project superintendent.
- (3) List of significant pieces of equipment expected to be used for the contract, and whether such equipment is owned or leased.
- (4) Description of work expected to be subcontracted, and to what firms, if known.
- (5) List of key material suppliers.
- (6) Preliminary bar chart time schedule
- (7) Contractor's expected means of financing the project. This should be based on the assumption that the contractor is required to finance 2X average monthly billings throughout the contract period.
- (8) Any other issues the contractor sees as impacting his ability to complete the project according to the contract.

In addition to the information described in Sections (A) through (D) above, the bidder shall submit such additional information as the Commissioner may require, including without limitation, an explanation or justification for specific unit price items.

The bidder is further advised that it may be required to attend a pre-award meeting with DDC representatives. If such a meeting is convened, the bidder will be advised as to any additional material to be provided.

A. PROJECT REFERENCES – SIMILAR CONTRACTS COMPLETED BY THE BIDDER

List all contracts substantially completed within the last 4 years similar to the contract being awarded, up to a maximum of 10, in descending order of date of substantial completion.

Project & Location	Contract Type	Contract Amount (\$000)	Date Completed	Owner Reference & Tel. No.	Architect/Engineer Reference & Tel. No. if different from owner

B. PROJECT REFERENCES – CONTRACTS CURRENTLY UNDER CONSTRUCTION BY THE BIDDER

List all contracts currently under construction even if they are not similar to the contract being awarded.

Project & Location	Contract Type	Contract Amount (\$000)	Subcontracted to Others (\$000)	Uncompleted Portion (\$000)	Date Scheduled to Complete	Owner Reference & Tel. No.	Architect/Engineer Reference & Tel. No. if different from owner

C. PROJECT REFERENCES – PENDING CONTRACTS NOT YET STARTED BY THE BIDDER

List all contracts awarded to or won by the bidder but not yet started.

Project & Location	Contract Type	Contract Amount (\$000)	Date Scheduled to Start	Owner Reference & Tel. No.	Architect/Engineer Reference & Tel. No. if different from owner

(NO TEXT ON THIS PAGE)

**OFFICE OF THE MAYOR
BUREAU OF LABOR SERVICES
CONTRACT CERTIFICATE**

To be completed if the contract is less than \$1,000,000

Contractor: _____

Address: _____

Telephone Number: _____

Name and Title of Signatory: _____

Contracting Agency or Owner: _____

Project Number: _____

Proposed Contract Amount: _____

Description and Address of Proposed Contract: _____

Names of Subcontractors in the amount of 750,000 or more on this contract (if not known at this time, so state indicating that trades will be subcontracted):

I, (fill in name of person signing) _____,
hereby affirm that I am authorized by the above-named contractor to certify that said contractor's
proposed contract with the above-named owner or city agency is less than \$1,000,000. This affirmation
is made in accordance with Executive Order No. 50 (1980) as amended and its implementing regulations.

Date

Signature

**WILLFUL OR FRAUDULENT FALSIFICATION OF ANY DATA OR INFORMATION
SUBMITTED HEREWITH MAY RESULT IN THE TERMINATION OF ANY CONTRACT BETWEEN
THE CITY AND THE BIDDER OR CONTRACTOR AND BAR THE BIDDER OR CONTRACTOR FROM
PARTICIPATION IN ANY CITY CONTRACT FOR A PERIOD OF UP TO THREE YEARS. FURTHER,
SUCH FALSIFICATION MAY RESULT IN CRIMINAL PROSECUTION.**

(NO TEXT ON THIS PAGE)

VENDEX COMPLIANCE

(A) Vendex Fees: Pursuant to Procurement Policy Board Rule 2-08(f)(2), the contractor will be charged a fee for the administration of the VENDEX system, including the Vendor Name Check process, if a Vendor Name Check review is required to be conducted by the Department of Investigation. The contractor shall also be required to pay the applicable required fees for any of its subcontractors for which Vendor Name Check reviews are required. The fee(s) will be deducted from payments made to the contractor under the contract. For contracts with an estimated value of less than or equal to \$1,000,000, the fee will be \$175 per Vendor Name Check review. For contracts with an estimated value of greater than \$1,000,000, the fee will be \$350 per Vendor Name Check review.

(B) Confirmation of Vendex Compliance: The Bidder shall submit this Confirmation of Vendex Compliance to the Department of Design and Construction, Contracts Section, 30-30 Thomson Avenue – First Floor, Long Island City, NY 11101.

Bid Information: The Bidder shall complete the bid information set forth below.

Name of Bidder: _____
Bidder's Address: _____
Bidder's Telephone Number: _____
Bidder's Fax Number: _____
Date of Bid Opening: _____
PROJECT ID: HWPEDSF1 _____

Vendex Compliance: To demonstrate compliance with Vendex requirements, the Bidder shall complete either Section (1) or Section (2) below, whichever applies.

(1) Submission of Vendex Questionnaires to MOCS: By signing in the space provided below, the Bidder certifies that as of the date specified below, the Bidder has submitted Vendex Questionnaires to the Mayor's Office of Contract Services, Attn: VENDEX, 253 Broadway, 9th Floor, New York, New York 10007.

Date of Submission: _____

By: _____
(Signature of Partner or corporate officer)

Print Name: _____

(2) Submission of Certification of No Change to DDC: By signing in the space provided below, the Bidder certifies that it has read the instructions in a "Vendor's Guide to Vendex" and that such instructions do not require the Bidder to submit Vendex Questionnaires. The Bidder has completed **TWO ORIGINALS** of the Certification of No Change set forth on the next page of this Bid Booklet.

By: _____
(Signature of Partner or corporate officer)

Print Name: _____

(NO TEXT ON THIS PAGE)

Certificate of No Change Form

- Please submit two completed forms. Copies will not be accepted.
- Please send both copies to the agency that requested it, unless you are advised to send it directly to the Mayor's Office of Contract Services (MOCS).
- A materially false statement willfully or fraudulently made in connection with this certification, and/or the failure to conduct appropriate due diligence in verifying the information that is the subject of this certification, may result in rendering the submitting entity non-responsible for the purpose of contract award.
- A materially false statement willfully or fraudulently made in connection with this certification may subject the person making the false statement to criminal charges

I, _____, being duly sworn, state that I have read
Enter Your Name

and understand all the items contained in the vendor questionnaire and any submission of change as identified on page one of this form and certify that as of this date, these items have not changed. I further certify that, to the best of my knowledge, information and belief, those answers are full, complete, and accurate; and that, to the best of my knowledge, information, and belief, those answers continue to be full, complete, and accurate.

In addition, I further certify on behalf of the submitting vendor that the information contained in the principal questionnaire(s) and any submission of change identified on page two of this form have not changed and have been verified and continue, to the best of my knowledge, to be full, complete and accurate.

I understand that the City of New York will rely on the information supplied in this certification as additional inducement to enter into a contract with the submitting entity.

Vendor Questionnaire *This section is required.*

This refers to the vendor questionnaire(s) submitted for the vendor doing business with the City.

Name of Submitting Entity: _____

Vendor's Address: _____

Vendor's EIN or TIN: _____ Requesting Agency: _____

Are you submitting this Certification as a parent? (Please circle one) Yes No

Signature date on the last full vendor questionnaire signed for the submitting vendor: _____

Signature date on change submission for the submitting vendor: _____

Principal Questionnaire

This section refers to the most recent principal questionnaire submissions.



Principal Name	Date of signature on last full Principal Questionnaire	Date(s) of signature on submission of change
----------------	--	---

1

2

3

4

5

6

Check if additional changes were submitted and attach a document with the date of additional submissions.

Certification *This section is required.*

This form must be signed and notarized. Please complete this twice. Copies will not be accepted.

Certified By:

Name (Print)

Title

Name of Submitting Entity

Signature

Date

Notarized By:

Notary Public

County License Issued

License Number

Sworn to before me on: _____
Date

Certificate of No Change Form

- Please submit two completed forms. Copies will not be accepted.
- Please send both copies to the agency that requested it, unless you are advised to send it directly to the Mayor's Office of Contract Services (MOCS).
- A materially false statement willfully or fraudulently made in connection with this certification, and/or the failure to conduct appropriate due diligence in verifying the information that is the subject of this certification, may result in rendering the submitting entity non-responsible for the purpose of contract award.
- A materially false statement willfully or fraudulently made in connection with this certification may subject the person making the false statement to criminal charges

I, _____, being duly sworn, state that I have read
Enter Your Name

and understand all the items contained in the vendor questionnaire and any submission of change as identified on page one of this form and certify that as of this date, these items have not changed. I further certify that, to the best of my knowledge, information and belief, those answers are full, complete, and accurate; and that, to the best of my knowledge, information, and belief, those answers continue to be full, complete, and accurate.

In addition, I further certify on behalf of the submitting vendor that the information contained in the principal questionnaire(s) and any submission of change identified on page two of this form have not changed and have been verified and continue, to the best of my knowledge, to be full, complete and accurate.

I understand that the City of New York will rely on the information supplied in this certification as additional inducement to enter into a contract with the submitting entity.

Vendor Questionnaire *This section is required.*

This refers to the vendor questionnaire(s) submitted for the vendor doing business with the City.

Name of Submitting Entity: _____

Vendor's Address: _____

Vendor's EIN or TIN: _____ Requesting Agency: _____

Are you submitting this Certification as a parent? (Please circle one) Yes No

Signature date on the last full vendor questionnaire signed for the submitting vendor: _____

Signature date on change submission for the submitting vendor: _____

Principal Questionnaire

This section refers to the most recent principal questionnaire submissions.



Principal Name	Date of signature on last full Principal Questionnaire	Date(s) of signature on submission of change
----------------	--	--

1

2

3

4

5

6

Check if additional changes were submitted and attach a document with the date of additional submissions.

Certification *This section is required.*

This form must be signed and notarized. Please complete this twice. Copies will not be accepted.

Certified By:

Name (Print)

Title

Name of Submitting Entity

Signature

Date

Notarized By:

Notary Public

County License Issued

License Number

Sworn to before me on: _____

Date

IRAN DIVESTMENT ACT COMPLIANCE RIDER

FOR NEW YORK CITY CONTRACTORS

The Iran Divestment Act of 2012, effective as of April 12, 2012, is codified at State Finance Law (“SFL”) §165-a and General Municipal Law (“GML”) §103-g. The Iran Divestment Act, with certain exceptions, prohibits municipalities, including the City, from entering into contracts with persons engaged in investment activities in the energy sector of Iran. Pursuant to the terms set forth in SFL §165-a and GML §103-g, a person engages in investment activities in the energy sector of Iran if:

- (a) The person provides goods or services of twenty million dollars or more in the energy sector of Iran, including a person that provides oil or liquefied natural gas tankers, or products used to construct or maintain pipelines used to transport oil or liquefied natural gas, for the energy sector of Iran; or
- (b) The person is a financial institution that extends twenty million dollars or more in credit to another person, for forty-five days or more, if that person will use the credit to provide goods or services in the energy sector in Iran and is identified on a list created pursuant to paragraph (b) of subdivision three of Section 165-a of the State Finance Law and maintained by the Commissioner of the Office of General Services.

A bid or proposal shall not be considered for award nor shall any award be made where the bidder or proposer fails to submit a signed and verified bidder’s certification.

Each bidder or proposer must certify that it is not on the list of entities engaged in investment activities in Iran created pursuant to paragraph (b) of subdivision 3 of Section 165-a of the State Finance Law. In any case where the bidder or proposer cannot certify that they are not on such list, the bidder or proposer shall so state and shall furnish with the bid or proposal a signed statement which sets forth in detail the reasons why such statement cannot be made. The City of New York may award a bid to a bidder who cannot make the certification on a case by case basis if:

- (1) The investment activities in Iran were made before the effective date of this section (i.e., April 12, 2012), the investment activities in Iran have not been expanded or renewed after the effective date of this section and the person has adopted, publicized and is implementing a formal plan to cease the investment activities in Iran and to refrain from engaging in any new investments in Iran: or
- (2) The City makes a determination that the goods or services are necessary for the City to perform its functions and that, absent such an exemption, the City would be unable to obtain the goods or services for which the contract is offered. Such determination shall be made in writing and shall be a public document.

**BIDDER'S CERTIFICATION OF COMPLIANCE WITH
IRAN DIVESTMENT ACT**

Pursuant to General Municipal Law §103-g, which generally prohibits the City from entering into contracts with persons engaged in investment activities in the energy sector of Iran, the bidder/proposer submits the following certification:

[Please Check One]

BIDDER'S CERTIFICATION

- By submission of this bid or proposal, each bidder/proposer and each person signing on behalf of any bidder/proposer certifies, and in the case of a joint bid each party thereto certifies as to its own organization, under penalty of perjury, that to the best of its knowledge and belief, that each bidder/proposer is not on the list created pursuant to paragraph (b) of subdivision 3 of Section 165-a of the State Finance Law.

- I am unable to certify that my name and the name of the bidder/proposer does not appear on the list created pursuant to paragraph (b) of subdivision 3 of Section 165-a of the State Finance Law. I have attached a signed statement setting forth in detail why I cannot so certify.

SIGNATURE

PRINTED NAME

TITLE

Sworn to before me this
____ day of _____, 20 ____

Notary Public

Dated:

**THE CITY OF NEW YORK
DEPARTMENT OF SMALL BUSINESS SERVICES
DIVISION OF LABOR SERVICES
CONTRACT COMPLIANCE UNIT
110 WILLIAMS STREET
NEW YORK, NEW YORK 10038
PHONE: (212) 513-6323
FAX: (212) 618-8879**

CONSTRUCTION

EMPLOYMENT

REPORT

(NO TEXT ON THIS PAGE)

The City of New York
 Department of Small Business Services
 Division of Labor Services
 Contract Compliance Unit
 110 William Street
 New York, New York 10038
 Phone: (212) 513 - 6323
 Fax: (212) 618-8879

CONSTRUCTION EMPLOYMENT REPORT
 INSTRUCTIONS

WHO MUST FILE A CONSTRUCTION EMPLOYMENT REPORT

A Construction Employment Report (ER) must be filed if you meet the following conditions:

CONTRACT FUNDING SOURCE	CONTRACTOR	CONTRACT VALUE	SUBMISSION REQUIREMENT
Federal/Federally assisted	Prime and subcontractors	\$10,000 or greater	Construction Employment Report
City and state funded	Prime contractor	\$1,000,000 or greater	
	Subcontractor	\$750,000 or greater	
		Less than \$750,000	Less than \$750,000 Certificate (City/State Only)

Prime Contractor:

- A general contractor or construction manager selected to perform work on a construction project funded (in whole or in part) by the federal government with a proposed contract value of \$10,000 or more.
- A general contractor or construction manager selected to perform work on a construction project funded or assisted by the City of New York with a proposed contract value of \$1,000,000 or more.

Subcontractor:

- A subcontractor selected to perform work on a construction project funded (in whole or in part) by the federal government with a proposed contract value of \$10,000 or more.
- A subcontractor selected to perform work on a construction project funded or assisted by the City of New York with a proposed contract value of \$750,000 or more.
- A subcontractor selected to perform work on a construction project funded or assisted by the City of New York with a proposed contract value of less than \$750,000 must submit a "Less than \$750,000" certificate.

WHERE TO FILE

Employment Reports must be filed with the City agency awarding the contract. If you are a contractor or subcontractor who will be working for a private developer in receipt of funding or assistance from the City, the ER must be filed with the City agency with jurisdiction over the developer's project.

DLS REVIEW PROCESS

In accordance with Executive Order 50 (EO 50), upon receipt by DLS of a completed ER, DLS conducts a review of the contractor's current employment policies, practices and procedures, as well as perform a statistical analysis of the contractor's workforce, if necessary. The process is as follows:

1. Within five (5) business days, DLS will review the ER for completeness and accuracy. If any information is omitted or incorrect, or if necessary documents are not submitted, the submission shall be deemed incomplete and DLS will inform the contractor. The substantive compliance review does not commence until the submission is complete. **An incomplete submission will delay the review process and may preclude or interrupt the contract approval.**
2. If the ER submission is complete, the compliance review will proceed, resulting in one of the following:

Certificate of Approval

The contractor is found to be in compliance with all applicable laws and regulations. The approval is valid for 36 months.

Continued Approval Certificate

The contractor has been issued a Certificate of Approval in the previous 36 months which is good for the applicable contract.

Conditional Certificate of Compliance

The contractor is required to take corrective actions in order to be in compliance with EO 50. The contractor must meet the conditions within one month of the issue of the Conditional Certificate.

Determination of Nonperformance

The contractor has failed to take the required corrective actions stipulated in the Conditional Certificate. A determination of nonperformance may prevent a contractor from receiving an award of a contract.

HOW TO COMPLETE THE EMPLOYMENT REPORT

Contents

General Information

Part I: Contractor/Subcontractor Information

Part II: Employment Policies and Practices

Part III: Contract Bid Information and Projected and Current Workforce Forms

Signature Page

PART I: CONTRACTOR/SUBCONTRACTOR INFORMATION

- Questions 7 – 11: Please provide the required contact information for your company. All contracts must have a designated Equal Employment Officer.
- Question 12: If you are a subcontractor, you must state the name of the contractor for whom you are providing the construction services.
- Question 13: Please provide the number of permanent employees in your company.
- Question 14a-g: The Project Identification Number (PIN) and the Contract Registration ID Number (CT#) can be obtained from the City agency. Provide a description of the trade work you will perform on this project and the address where the work will be performed. Subcontractors can obtain this information from the contract they have with the prime contractor.
- Questions 15 – 18: If your company has received a valid Certificate of Approval within the past 36 months, been audited by the United States Department of Labor, Office of Federal Contract Compliance Programs (OFCCP), or if your company has submitted an ER for a different contract for which you have not yet received a compliance certificate, then you only need to complete and submit the following:
- General Information section
 - Part I - Contractor/Subcontractor Information
 - Form B - Projected Workforce
 - Signature Page

If your company is currently waiting for an approval on another contract previously submitted, be certain to identify the date on which you submitted the completed Employment Report, the name of the City contracting agency with which the contract was made, and the name and telephone number of the person to whom the Employment Report was submitted.

If your company was issued a Conditional Certificate of Approval, all required corrective actions must have been taken or DLS will not issue a Continued Certificate.

- Question 18: If the company was audited by the OFCCP, also provide the following:
- Identify the reviewing OFCCP office by its name and address
 - If an unconditional certificate of compliance was issued by the OFCCP, attach a copy of the certificate in lieu of completing Parts II and III;
 - Include copies of all corrective actions and documentation of OFCCP's performance; and
 - Provide a copy of all stated OFCCP findings.

- Question 19: Please provide a copy of any Collective Bargaining Agreement(s) which is negotiated through an employer trade association on behalf of your organization or any of its affiliates.

PART II: EMPLOYMENT POLICIES AND PRACTICES

Remember to label all documents with the question number for which they are submitted.

Questions 20a – j: You must respond to the questions as to whether or not your firm has documents reflecting written policies, benefits and procedures. If so, then you must identify by name each document in which the policy(ies), procedure(s) and benefit(s) is located and submit copies of all of the document(s). If your firm follows unwritten practices or procedures, include an explanation of how they operate. Please submit the most current document(s), including all applicable amendments. Label each document and/or unwritten practice according to the question to which it corresponds (e.g. 20a, 20b, etc.)

Questions 21a – h: Inquires about the manner/methods by which you comply with the requirements of the Immigration Reform and Control Act of 1986 (IRCA).

Question 22: Inquires into where and how I-9 forms are maintained and stored.

Questions 23a – e: Inquires into whether or not there is a requirement that an applicant or employee be subjected to a medical examination at any given time. Copies of the medical information questionnaire and instructions must be submitted with the Employment Report.

Question 24: Indicate the existence and location of all statements of your firm's Equal Employment Opportunity policy and attach a copy of each statement.

Question 25: Submit any current Affirmative Action Plan(s) created pursuant to Executive Order 11246.

Question 26: If your firm or collective bargaining agreement has an internal grievance procedure, indicate this and submit a copy of the policy and procedure. If unwritten, explain its nature and operation. Explain how your firm's procedure addresses EEO complaints.

Question 27: If your employees have used the procedure in the last three (3) years, please submit an explanation in the format indicated below:

1. Number of complaint(s)	2. Nature of the complaint(s)	3. Position(s) of the complainant(s)	4. Was an investigation conducted? Y/N	5. Current status of the disposition
---------------------------	-------------------------------	--------------------------------------	---	--------------------------------------

Question 28: Indicate whether in the past three (3) years complaints have been filed with a court of law or administrative agency, naming your company as a defendant (or respondent) in a complaint alleging violation of any anti-discrimination or affirmative action laws. If yes, develop and submit a log to show, for each administrative/and or judicial action filed, the following information:

1. Name(s) of complainant(s)	2. Administrative agency or court in which action was filed	3. Nature of the complaint(s)	4. Current status	5. If not pending, the complaint's disposition
------------------------------	---	-------------------------------	-------------------	--

Question 29: Identify each job for which a physical qualification exists. Identify and explain the physical qualification(s) for each stated job. Submit job descriptions for each job and the reasons for the qualifications.

Question 30: Identify each job for which there exists any qualification related to age, race, color, national origin, sex, creed, disability, marital status, sexual orientation or citizenship status. Identify and explain the specific related qualification for each job stated. Submit job descriptions for each job and the reasons for the qualifications.

PART III: CONTRACT BID INFORMATION AND PROJECTED AND CURRENT WORKFORCE FORMS

FORM A: CONTRACT BID INFORMATION – USE OF SUBCONTRACTORS/TRADES

Your projections for the utilization of subcontractors on the proposed contract are to be provided in this section. A chart has been provided for the identification of subcontractors. Information is to be provided to the extent known at the time the ER is filed for review by DLS. If the subcontractor's name is unknown, then write "unknown". Under "ownership", enter the appropriate race/ethnic and gender code. If the contract is federally funded or assisted and the subcontractor is being utilized in accordance with applicable federal requirements with respect to Minority Business Enterprise or Woman Business Enterprise requirements, enter the appropriate code. This will also apply to state funded contracts with similar requirements for minority and female owned businesses.

FORM B: PROJECTED WORKFORCE FOR WORK TO BE PERFORMED ON THIS PROJECT

For each trade to be engaged by your company for this project, enter the projected workforce for Males and Females by trade classification in the charts provided.

FORM C: CURRENT WORKFORCE FOR WORK TO BE PERFORMED ON THIS PROJECT

For each trade *currently* engaged by your company for all work performed in NYC, enter the current workforce for Males and Females by trade classification in the charts provided.

SIGNATURE PAGE

The signatory of this Employment Report and all other documents submitted to DLS must be an official authorized to enter into a binding legal agreement. The signature page must be completed in its entirety and notarized. Only original signatures will be accepted.

The City of New York Department of Small Business Services
Division of Labor Services Contract Compliance Unit
110 William Street, New York, New York 10038
Phone: (212) 513 - 6323
Fax: (212) 618-8879

CONSTRUCTION EMPLOYMENT REPORT

GENERAL INFORMATION

1. Your contractual relationship in this contract is: Prime contractor Subcontractor
- 1a. Are M/WBE goals attached to this project? Yes No
2. Please check one of the following if your firm would like information on how to certify with the City of New York as a:
 Minority Owned Business Enterprise
 Women Owned Business Enterprise
 Disadvantaged Business Enterprise
 Locally Based Business Enterprise
 Emerging Business Enterprise
- 2a. If you are certified as an **MBE, WBE, LBE, EBE** or **DBE**, what city/state agency are you certified with? _____ Are you DBE certified? Yes No
3. Please indicate if you would like assistance from SBS in identifying certified M/WBEs for contracting opportunities: Yes No
4. Is this project subject to a project labor agreement? Yes No
5. Are you a Union contractor? Yes No If yes, please list which local(s) you affiliated with _____
6. Are you a Veteran owned company? Yes No

PART I: CONTRACTOR/SUBCONTRACTOR INFORMATION

7. _____
Employer Identification Number or Federal Tax I.D. Email Address
8. _____
Company Name
9. _____
Company Address and Zip Code
10. _____
Chief Operating Officer Telephone Number
11. _____
Designated Equal Opportunity Compliance Officer Telephone Number
(If same as Item #10, write "same")
12. _____
Name of Prime Contractor and Contact Person
(If same as Item #8, write "same")

13. Number of employees in your company: _____

14. Contract information:

(a) _____ (b) _____
Contracting Agency (City Agency) Contract Amount

(c) _____ (d) _____
Procurement Identification Number (PIN) Contract Registration Number (CT#)

(e) _____ (f) _____
Projected Commencement Date Projected Completion Date

(g) Description and location of proposed contract:

15. Has your firm been reviewed by the Division of Labor Services (DLS) within the past 36 months and issued a Certificate of Approval? Yes___ No___

If yes, attach a copy of certificate.

16. Has DLS within the past month reviewed an Employment Report submission for your company and issued a Conditional Certificate of Approval? Yes___ No___

If yes, attach a copy of certificate.

NOTE: DLS WILL NOT ISSUE A CONTINUED CERTIFICATE OF APPROVAL IN CONNECTION WITH THIS CONTRACT UNLESS THE REQUIRED CORRECTIVE ACTIONS IN PRIOR CONDITIONAL CERTIFICATES OF APPROVAL HAVE BEEN TAKEN.

17. Has an Employment Report already been submitted for a different contract (not covered by this Employment Report) for which you have not yet received compliance certificate? Yes___ No___ If yes,

Date submitted: _____

Agency to which submitted: _____

Name of Agency Person: _____

Contract No: _____

Telephone: _____

18. Has your company in the past 36 months been audited by the United States Department of Labor, Office of Federal Contract Compliance Programs (OFCCP)? Yes___ No___

If yes,

(a) Name and address of OFCCP office.

(b) Was a Certificate of Equal Employment Compliance issued within the past 36 months?
Yes___ No___

If yes, attach a copy of such certificate.

(c) Were any corrective actions required or agreed to? Yes___ No___

If yes, attach a copy of such requirements or agreements.

(d) Were any deficiencies found? Yes___ No___

If yes, attach a copy of such findings.

19. Is your company or its affiliates a member or members of an employers' trade association which is responsible for negotiating collective bargaining agreements (CBA) which affect construction site hiring? Yes___ No___

If yes, attach a list of such associations and all applicable CBA's.

PART II: DOCUMENTS REQUIRED

20. For the following policies or practices, attach the relevant documents (e.g., printed booklets, brochures, manuals, memoranda, etc.). If the policy(ies) are unwritten, attach a full explanation of the practices. See instructions.

- ___ (a) Health benefit coverage/description(s) for all management, nonunion and union employees (whether company or union administered)
- ___ (b) Disability, life, other insurance coverage/description
- ___ (c) Employee Policy/Handbook
- ___ (d) Personnel Policy/Manual
- ___ (e) Supervisor's Policy/Manual
- ___ (f) Pension plan or 401k coverage/description for all management, nonunion and union employees, whether company or union administered
- ___ (g) Collective bargaining agreement(s).
- ___ (h) Employment Application(s)
- ___ (i) Employee evaluation policy/form(s).
- ___ (j) Does your firm have medical and/or non-medical (i.e. education, military, personal, pregnancy, child care) leave policy?

21. To comply with the Immigration Reform and Control Act of 1986 when and of whom does your firm require the completion of an I-9 Form?

- (a) Prior to job offer Yes___ No___
- (b) After a conditional job offer Yes___ No___
- (c) After a job offer Yes___ No___
- (d) Within the first three days on the job Yes___ No___
- (e) To some applicants Yes___ No___
- (f) To all applicants Yes___ No___
- (g) To some employees Yes___ No___
- (h) To all employees Yes___ No___

22. Explain where and how completed I-9 Forms, with their supportive documentation, are maintained and made accessible.

23. Does your firm or any of its collective bargaining agreements require job applicants to take a medical examination? Yes___ No___

If yes, is the medical examination given:

- (a) Prior to a job offer Yes___ No___
- (b) After a conditional job offer Yes___ No___
- (c) After a job offer Yes___ No___
- (d) To all applicants Yes___ No___
- (e) Only to some applicants Yes___ No___

If yes, list for which applicants below and attach copies of all medical examination or questionnaire forms and instructions utilized for these examinations.

24. Do you have a written equal employment opportunity (EEO) policy? Yes___ No___

If yes, list the document(s) and page number(s) where these written policies are located.

25. Does the company have a current affirmative action plan(s) (AAP)

___ Minorities and Women

___ Individuals with handicaps

___ Other. Please specify _____

26. Does your firm or collective bargaining agreement(s) have an internal grievance procedure with respect to EEO complaints? Yes___ No___

If yes, please attach a copy of this policy.

If no, attach a report detailing your firm's unwritten procedure for handling EEO complaints.

27. Has any employee, within the past three years, filed a complaint pursuant to an internal grievance procedure or with any official of your firm with respect to equal employment opportunity? Yes___ No___

If yes, attach an internal complaint log. See instructions.

28. Has your firm, within the past three years, been named as a defendant (or respondent) in any administrative or judicial action where the complainant (plaintiff) alleged violation of any anti-discrimination or affirmative action laws? Yes___ No___

If yes, attach a log. See instructions.

29. Are there any jobs for which there are physical qualifications? Yes___ No___

If yes, list the job(s), submit a job description and state the reason(s) for the qualification(s).

30. Are there any jobs for which there are age, race, color, national origin, sex, creed, disability, marital status, sexual orientation, or citizenship qualifications? Yes___ No___

If yes, list the job(s), submit a job description and state the reason(s) for the qualification(s).

SIGNATURE PAGE

I, (print name of authorized official signing) _____ hereby certify that the information submitted herewith is true and complete to the best of my knowledge and belief and submitted with the understanding that compliance with New York City's equal employment requirements, as contained in Chapter 56 of the City Charter, Executive Order No. 50 (1980), as amended, and the implementing Rules and Regulations, is a contractual obligation. I also agree on behalf of the company to submit a certified copy of payroll records to the Division of Labor Services on a monthly basis.

Contractor's Name

Name of person who prepared this Employment Report Title

Name of official authorized to sign on behalf of the contractor Title

Telephone Number

Signature of authorized official Date

If contractors are found to be underutilizing minorities and females in any given trade based on Chapter 56 Section 3H, the Division of Labor Services reserves the right to request the contractor's workforce data and to implement an employment program.

Contractors who fail to comply with the above mentioned requirements or are found to be in noncompliance may be subject to the withholding of final payment.

Willful or fraudulent falsifications of any data or information submitted herewith may result in the termination of the contract between the City and the bidder or contractor and in disapproval of future contracts for a period of up to five years. Further, such falsification may result in civil and/or criminal prosecution.

To the extent permitted by law and consistent with the proper discharge of DLS' responsibilities under Charter Chapter 56 of the City Charter and Executive Order No. 50 (1980) and the implementing Rules and Regulations, all information provided by a contractor to DLS shall be confidential.

Only original signatures accepted.

Sworn to before me this _____ day of _____ 20 _____

Notary Public Authorized Signature Date

FORM A CONTRACT BID INFORMATION: USE OF SUBCONTRACTORS/TRADES

1. Do you plan to subcontractor work on this contract? Yes ___ No ___
2. If yes, complete the chart below.

NOTE: All proposed subcontractors with a subcontract in excess of \$750,000 must complete an Employment Report for review and approval before the contract may be awarded and work commences.

SUBCONTRACTOR'S NAME*	OWNERSHIP (ENTER APPROPRIATE CODE LETTERS BELOW)	WORK TO BE PERFORMED BY SUBCONTRACTOR	TRADE PROJECTED FOR USE BY SUBCONTRACTOR	PROJECTED DOLLAR VALUE OF SUBCONTRACT

***If subcontractor is presently unknown, please enter the trade (craft name).**

OWNERSHIP CODES

- W: White
- B: Black
- H: Hispanic
- A: Asian
- N: Native American
- F: Female

FORM B: PROJECTED WORKFORCE

TRADE CLASSIFICATION CODES

- (J) Journeylevel Workers
- (H) Helper
- (TOT) Total by Column
- (A) Apprentice (TRN) Trainee

For each trade to be engaged by your company for this project, enter the projected workforce for Males and Females by trade classification on the charts below.

Trade:	MALES						FEMALES														
	(1)		(2)		(3)		(4)		(5)		(6)		(7)		(8)		(9)		(10)		
	White Non Hisp.	Black Non Hisp.	White Non Hisp.	Black Non Hisp.	White Non Hisp.	Black Non Hisp.	Asian	Asian	Native Amer.	Native Amer.	White Non Hisp.	Black Non Hisp.	White Non Hisp.	Black Non Hisp.	Hispanic	Hispanic	Asian	Asian	Native Amer.	Native Amer.	
J																					
H																					
A																					
TRN																					
TOT																					

Total (Col. #1-10):

Total Minority, Male & Female (Col. #2,3,4,5,7,8,9, & 10):

Total Female (Col. #6 - 10):

What are the recruitment sources for you projected hires (i.e., unions, government employment office, job tap center, community outreach)?

FORM B: PROJECTED WORKFORCE

Trade: _____

Union Affiliation, if applicable _____

Total (Col. #1-10): _____

Total Minority, Male & Female
(Col. #2,3,4,5,7,8,9, & 10): _____

Total Female
(Col. #6 - 10): _____

FEMALES

(6) White Non Hisp.	(7) Black Non Hisp.	(8) Hisp.	(9) Asian	(10) Native Amer.

MALES

(1) White Non Hisp.	(2) Black Non Hisp.	(3) Hisp.	(4) Asian	(5) Native Amer.

J

H

A

TRN

TOT

What are the recruitment sources for you projected hires (i.e., unions, government employment office, job tap center, community outreach)?

FORM C: CURRENT WORKFORCE

TRADE CLASSIFICATION CODES

- (J) Journeylevel Workers
- (H) Helper
- (TOT) Total by Column
- (A) Apprentice
- (TRN) Trainee

For each trade currently engaged by your company for all work performed in New York City, enter the current workforce for Males and Females by trade classification on the charts below.

Trade:	MALES					FEMALES														
	(1)		(2)		(3)	(4)		(5)		(6)		(7)		(8)	(9)		(10)			
	White Non Hisp.	Black Non Hisp.	White Non Hisp.	Black Non Hisp.	Hisp.	Asian	Asian	Native Amer.	White Non Hisp.	Black Non Hisp.	White Non Hisp.	Black Non Hisp.	Hisp.	Asian	Asian	Native Amer.	White Non Hisp.	Black Non Hisp.	Native Amer.	
J																				
H																				
A																				
TRN																				
TOT																				

What are the recruitment sources for you projected hires (i.e., unions, government employment office, job tap center, community outreach)?

FORM C: CURRENT WORKFORCE

Trade: _____

Union Affiliation, if applicable _____

Total (Col. #1-10): _____

Total Minority, Male & Female
(Col. #2,3,4,5,7,8,9, & 10): _____

Total Female
(Col. #6 - 10): _____

MALES

	(1)		(2)		(3)		(4)		(5)	
	White Non Hisp.	Black Non Hisp.	White Non Hisp.	Black Non Hisp.	Hisp.	Asian	Hisp.	Asian	Native Amer.	Native Amer.
J										
H										
A										
TRN										
TOT										

FEMALES

	(6)		(7)		(8)		(9)		(10)	
	White Non Hisp.	Black Non Hisp.	White Non Hisp.	Black Non Hisp.	Hisp.	Asian	Hisp.	Asian	Native Amer.	Native Amer.
J										
H										
A										
TRN										
TOT										

What are the recruitment sources for you projected hires (i.e., unions, government employment office, job tap center, community outreach)?

(NO TEXT ON THIS PAGE)

The City of New York Department of Small Business Services
Division of Labor Services Contract Compliance Unit
110 William Street, New York, New York 10038
Phone: (212) 513 - 6323
Fax: (212) 618-8879

CONSTRUCTION EMPLOYMENT REPORT

GENERAL INFORMATION

1. Your contractual relationship in this contract is: Prime contractor ___ Subcontractor x
- 1a. Are MWBE goals attached to this project? Yes ___ No ___
2. Please check one of the following if your firm would like information on how to certify with the City of New York as a:

<input type="checkbox"/> Minority Owned Business Enterprise	<input type="checkbox"/> Locally Based Business Enterprise
<input type="checkbox"/> Women Owned Business Enterprise	<input type="checkbox"/> Emerging Business Enterprise
<input type="checkbox"/> Disadvantaged Business Enterprise	
- 2a. If you are certified as an **MBE, WBE, LBE, EBE** or **DBE**, what city/state agency are you certified with? _____ Are you DBE certified? Yes ___ No ___
3. Please indicate if you would like assistance from SBS in identifying certified MWBEs for contracting opportunities: Yes ___ No ___
4. Is this project subject to a project labor agreement? Yes ___ No ___
5. Are you a Union contractor? Yes ___ No ___ If yes, please list which local(s) you affiliated with _____
6. Are you a Veteran owned company? Yes ___ No ___

PART I: CONTRACTOR/SUBCONTRACTOR INFORMATION

7. _____
Employer Identification Number or Federal Tax I.D. Email Address
8. _____
Company Name
9. _____
Company Address and Zip Code
10. _____
Chief Operating Officer Telephone Number
11. _____
Designated Equal Opportunity Compliance Officer Telephone Number
(If same as Item #10, write "same")
12. _____
Name of Prime Contractor and Contact Person
(If same as Item #8, write "same")

13. Number of employees in your company: _____

14. Contract information:

(a) _____ (b) _____
Contracting Agency (City Agency) Contract Amount

(c) _____ (d) _____
Procurement Identification Number (PIN) Contract Registration Number (CT#)

(e) _____ (f) _____
Projected Commencement Date Projected Completion Date

(g) Description and location of proposed contract:

15. Has your firm been reviewed by the Division of Labor Services (DLS) within the past 36 months and issued a Certificate of Approval? Yes___ No___

If yes, attach a copy of certificate.

16. Has DLS within the past month reviewed an Employment Report submission for your company and issued a Conditional Certificate of Approval? Yes___ No___

If yes, attach a copy of certificate.

NOTE: DLS WILL NOT ISSUE A CONTINUED CERTIFICATE OF APPROVAL IN CONNECTION WITH THIS CONTRACT UNLESS THE REQUIRED CORRECTIVE ACTIONS IN PRIOR CONDITIONAL CERTIFICATES OF APPROVAL HAVE BEEN TAKEN.

17. Has an Employment Report already been submitted for a different contract (not covered by this Employment Report) for which you have not yet received compliance certificate?
Yes___ No___ If yes,

Date submitted: _____

Agency to which submitted: _____

Name of Agency Person: _____

Contract No: _____

Telephone: _____

18. Has your company in the past 36 months been audited by the United States Department of Labor, Office of Federal Contract Compliance Programs (OFCCP)? Yes___ No___

If yes,

(a) Name and address of OFCCP office.

(b) Was a Certificate of Equal Employment Compliance issued within the past 36 months?
Yes___ No___

If yes, attach a copy of such certificate.

(c) Were any corrective actions required or agreed to? Yes___ No___

If yes, attach a copy of such requirements or agreements.

(d) Were any deficiencies found? Yes___ No___

If yes, attach a copy of such findings.

19. Is your company or its affiliates a member or members of an employers' trade association which is responsible for negotiating collective bargaining agreements (CBA) which affect construction site hiring? Yes___ No___

If yes, attach a list of such associations and all applicable CBA's.

PART II: DOCUMENTS REQUIRED

20. For the following policies or practices, attach the relevant documents (e.g., printed booklets, brochures, manuals, memoranda, etc.). If the policy(ies) are unwritten, attach a full explanation of the practices. See instructions.

- ___ (a) Health benefit coverage/description(s) for all management, nonunion and union employees (whether company or union administered)
- ___ (b) Disability, life, other insurance coverage/description
- ___ (c) Employee Policy/Handbook
- ___ (d) Personnel Policy/Manual
- ___ (e) Supervisor's Policy/Manual
- ___ (f) Pension plan or 401k coverage/description for all management, nonunion and union employees, whether company or union administered
- ___ (g) Collective bargaining agreement(s).
- ___ (h) Employment Application(s)
- ___ (i) Employee evaluation policy/form(s).
- ___ (j) Does your firm have medical and/or non-medical (i.e. education, military, personal, pregnancy, child care) leave policy?

21. To comply with the Immigration Reform and Control Act of 1986 when and of whom does your firm require the completion of an I-9 Form?

- (a) Prior to job offer Yes___ No___
- (b) After a conditional job offer Yes___ No___
- (c) After a job offer Yes___ No___
- (d) Within the first three days on the job Yes___ No___
- (e) To some applicants Yes___ No___
- (f) To all applicants Yes___ No___
- (g) To some employees Yes___ No___
- (h) To all employees Yes___ No___

22. Explain where and how completed I-9 Forms, with their supportive documentation, are maintained and made accessible.

23. Does your firm or any of its collective bargaining agreements require job applicants to take a medical examination? Yes___ No___

If yes, is the medical examination given:

- (a) Prior to a job offer Yes___ No___
- (b) After a conditional job offer Yes___ No___
- (c) After a job offer Yes___ No___
- (d) To all applicants Yes___ No___
- (e) Only to some applicants Yes___ No___

If yes, list for which applicants below and attach copies of all medical examination or questionnaire forms and instructions utilized for these examinations.

24. Do you have a written equal employment opportunity (EEO) policy? Yes___ No___

If yes, list the document(s) and page number(s) where these written policies are located.

25. Does the company have a current affirmative action plan(s) (AAP)

____ Minorities and Women

____ Individuals with handicaps

____ Other. Please specify _____

26. Does your firm or collective bargaining agreement(s) have an internal grievance procedure with respect to EEO complaints? Yes___ No___

If yes, please attach a copy of this policy.

If no, attach a report detailing your firm's unwritten procedure for handling EEO complaints.

27. Has any employee, within the past three years, filed a complaint pursuant to an internal grievance procedure or with any official of your firm with respect to equal employment opportunity? Yes___ No___

If yes, attach an internal complaint log. See instructions.

28. Has your firm, within the past three years, been named as a defendant (or respondent) in any administrative or judicial action where the complainant (plaintiff) alleged violation of any anti-discrimination or affirmative action laws? Yes___ No___

If yes, attach a log. See instructions.

29. Are there any jobs for which there are physical qualifications? Yes___ No___

If yes, list the job(s), submit a job description and state the reason(s) for the qualification(s).

30. Are there any jobs for which there are age, race, color, national origin, sex, creed, disability, marital status, sexual orientation, or citizenship qualifications? Yes___ No___

If yes, list the job(s), submit a job description and state the reason(s) for the qualification(s).

SIGNATURE PAGE

I, (print name of authorized official signing) _____ hereby certify that the information submitted herewith is true and complete to the best of my knowledge and belief and submitted with the understanding that compliance with New York City's equal employment requirements, as contained in Chapter 56 of the City Charter, Executive Order No. 50 (1980), as amended, and the implementing Rules and Regulations, is a contractual obligation. I also agree on behalf of the company to submit a certified copy of payroll records to the Division of Labor Services on a monthly basis.

Contractor's Name

Name of person who prepared this Employment Report Title

Name of official authorized to sign on behalf of the contractor Title

Telephone Number

Signature of authorized official Date

If contractors are found to be underutilizing minorities and females in any given trade based on Chapter 56 Section 3H, the Division of Labor Services reserves the right to request the contractor's workforce data and to implement an employment program.

Contractors who fail to comply with the above mentioned requirements or are found to be in noncompliance may be subject to the withholding of final payment.

Willful or fraudulent falsifications of any data or information submitted herewith may result in the termination of the contract between the City and the bidder or contractor and in disapproval of future contracts for a period of up to five years. Further, such falsification may result in civil and/or criminal prosecution.

To the extent permitted by law and consistent with the proper discharge of DLS' responsibilities under Charter Chapter 56 of the City Charter and Executive Order No. 50 (1980) and the implementing Rules and Regulations, all information provided by a contractor to DLS shall be confidential.

Only original signatures accepted.

Sworn to before me this _____ day of _____ 20 _____

Notary Public Authorized Signature Date

FORM A. CONTRACT BID INFORMATION: USE OF SUBCONTRACTORS/TRADES

1. Do you plan to subcontractor work on this contract? Yes ___ No ___
2. If yes, complete the chart below.

NOTE: All proposed subcontractors with a subcontract in excess of \$750,000 must complete an Employment Report for review and approval before the contract may be awarded and work commences.

SUBCONTRACTOR'S NAME*	OWNERSHIP (ENTER APPROPRIATE CODE LETTERS BELOW)	WORK TO BE PERFORMED BY SUBCONTRACTOR	TRADE PROJECTED FOR USE BY SUBCONTRACTOR	PROJECTED DOLLAR VALUE OF SUBCONTRACT

*If subcontractor is presently unknown, please enter the trade (craft name).

OWNERSHIP CODES

- W: White
- B: Black
- H: Hispanic
- A: Asian
- N: Native American
- F: Female

FORM B: PROJECTED WORKFORCE

TRADE CLASSIFICATION CODES

- (J) Journeylevel Workers
- (H) Helper
- (TOT) Total by Column
- (A) Apprentice
- (TRN) Trainee

For each trade to be engaged by your company for this project, enter the projected workforce for Males and Females by trade classification on the charts below.

Trade:	MALES						FEMALES													
	(1)		(2)		(3)		(4)		(5)		(6)		(7)		(8)		(9)		(10)	
	White Non Hisp.	Black Non Hisp.	White Non Hisp.	Black Non Hisp.	White Non Hisp.	Black Non Hisp.	Asian	Asian	Native Amer.	Native Amer.	White Non Hisp.	Black Non Hisp.	White Non Hisp.	Black Non Hisp.	White Non Hisp.	Black Non Hisp.	Asian	Asian	Native Amer.	Native Amer.
J																				
H																				
A																				
TRN																				
TOT																				

Trade: _____

Union Affiliation, if applicable _____

Total (Col. #1-10): _____

Total Minority, Male & Female
(Col. #2,3,4,5,7,8,9, & 10): _____

Total Female
(Col. #6 - 10): _____

What are the recruitment sources for you projected hires (i.e., unions, government employment office, job tap center, community outreach)?

FORM B: PROJECTED WORKFORCE

Trade: _____

Union Affiliation, if applicable _____

Total (Col. #1-10): _____

Total Minority, Male & Female
(Col. #2,3,4,5,7,8,9, & 10): _____

Total Female
(Col. #6 - 10): _____

MALES

(1) White Non Hisp.	(2) Black Non Hisp.	(3) Hisp.	(4) Asian	(5) Native Amer.

J
H
A
TRN
TOT

FEMALES

(6) White Non Hisp.	(7) Black Non Hisp.	(8) Hisp.	(9) Asian	(10) Native Amer.

What are the recruitment sources for you projected hires (i.e., unions, government employment office, job tap center, community outreach)?

FORM C: CURRENT WORKFORCE

TRADE CLASSIFICATION CODES

- (J) Journeylevel Workers
- (H) Helper
- (TOT) Total by Column
- (A) Apprentice
- (TRN) Trainee

For each trade currently engaged by your company for all work performed in New York City, enter the current workforce for Males and Females by trade classification on the charts below.

Trade:	MALES						FEMALES													
	(1)		(2)		(3)		(4)		(5)		(6)		(7)		(8)		(9)		(10)	
	White Non Hisp.	Black Non Hisp.	White Non Hisp.	Black Non Hisp.	White Non Hisp.	Asian Hisp.	Asian Hisp.	Asian Hisp.	Native Amer.	Native Amer.	White Non Hisp.	Black Non Hisp.	White Non Hisp.	Asian Hisp.	Asian Hisp.	Asian Hisp.	Native Amer.	Native Amer.	Native Amer.	Native Amer.
J																				
H																				
A																				
TRN																				
TOT																				

Union Affiliation, if applicable

Total (Col. #1-10):

Total Minority, Male & Female (Col. #2,3,4,5,7,8,9, & 10):

Total Female (Col. #6 - 10):

What are the recruitment sources for you projected hires (i.e., unions, government employment office, job tap center, community outreach)?

FORM C: CURRENT WORKFORCE

Trade: _____

Union Affiliation, if applicable _____

Total (Col. #1-10): _____

Total Minority, Male & Female
(Col. #2,3,4,5,7,8,9, & 10): _____

Total Female
(Col. #6 - 10): _____

MALES

(1) White Non Hisp.	(2) Black Non Hisp.	(3) Hisp.	(4) Asian	(5) Native Amer.

J
H
A
TRN
TOT

FEMALES

(6) White Non Hisp.	(7) Black Non Hisp.	(8) Hisp.	(9) Asian	(10) Native Amer.

What are the recruitment sources for you projected hires (i.e., unions, government employment office, job tap center, community outreach)?

(NO TEXT ON THIS PAGE)

The City of New York Department of Small Business Services
Division of Labor Services Contract Compliance Unit
110 William Street, New York, New York 10038
Phone: (212) 513 - 6323 Fax: (212) 618-8879

Date _____

File Number _____

**LESS THAN \$750,000 SUBCONTRACT CERTIFICATE
(CITY, STATE AND ICIP ONLY)**

Are you currently certified as one of the following? Please check yes or no:

MBE Yes ___ No ___ WBE Yes ___ No ___ LBE Yes ___ No ___

DBE Yes ___ No ___ EBE Yes ___ No ___

If you are certified as an MBE, WBE, LBE, EBE or DBE, what city/state agency are you certified with?

Please check one of the following if your firm would like information on how to certify with the City of New York as a:

___ Minority Owned Business Enterprise

___ Locally based Business Enterprise

___ Women Owned Business Enterprise

___ Emerging Business Enterprise

___ Disadvantaged Business Enterprise

Company Name

Employer Identification Number or Federal Tax I.D

Company Address and Zip Code

Contact Person (First Name, Last Name)

Telephone Number

Fax Number

E-mail Address

Description and location of proposed subcontract:

Are you a Union contractor? Yes ___ No ___ If yes, please list which local(s) you affiliated with

Are you a Veteran owned company? Yes ___ No ___

Procurement Identification Number (PIN)
(City contracts only)

Contract Registration Number (CT#)
(City contracts only)

Block and Lot Number
(ICIP projects only)

Contract Amount

I, (print name of authorized official signing) _____ hereby certify that I am authorized by the above-named subcontractor to certify that said subcontractor's proposed contract with the above named owner or City agency is less than \$750,000. This affirmation is made in accordance with NYC Charter Chapter 56, Executive Order No. 50 (1980) and the implementing Rules.

Willful or fraudulent falsifications of any data or information submitted herewith may result in the termination of the contract between the City and the bidder or contractor and in disapproval of future contracts for a period of up to five years. Further, such falsification may result in civil and/or criminal prosecution.

Signature of authorized official

Date

Only original signatures accepted.

Sworn to before me this _____ day of _____ 20 _____

Notary Public

Authorized Signature

Date





NEW YORK CITY DEPARTMENT OF
DESIGN + CONSTRUCTION

**INFRASTRUCTURE DIVISION
BUREAU OF DESIGN**

VOLUME 1 OF 3

PROJECT ID: HWPEDSF1

MULTI-SITE PEDESTRIAN SAFETY
WHICH INCLUDES THE FOLLOWING INTERSECTIONS:

31ST STREET AND 39TH AVENUE
31ST STREET AND 36TH AVENUE
31ST STREET AND BROADWAY

INCLUDING BUS BULBOUTS, CURB EXTENSIONS, BUS PADS,
PEDESTRIAN RAMPS, CATCH BASINS, PAVEMENT MARKINGS,
STREET LIGHTING, AND TRAFFIC SIGNAL WORK

Together With All Work Incidental Thereto
BOROUGH OF QUEENS
CITY OF NEW YORK

Contractor.

Dated _____, 20____



**THE CITY OF NEW YORK
DEPARTMENT OF DESIGN AND CONSTRUCTION
DIVISION OF INFRASTRUCTURE**

30-30 THOMSON AVENUE
LONG ISLAND CITY, NEW YORK 11101-3045
TELEPHONE (718) 391-1000
WEBSITE www.nyc.gov/buildnyc

VOLUME 2 OF 3

**INFORMATION FOR BIDDERS
CONTRACT
PERFORMANCE AND PAYMENT BONDS
PREVAILING WAGE SCHEDULE**

FOR FURNISHING ALL LABOR AND MATERIALS NECESSARY AND REQUIRED FOR

PROJECT ID: HWPEDSF1

**MULTI-SITE PEDESTRIAN SAFETY
WHICH INCLUDES THE FOLLOWING INTERSECTIONS:**

**31ST STREET AND 39TH AVENUE
31ST STREET AND 36TH AVENUE
31ST STREET AND BROADWAY**

**INCLUDING BUS BULBOUTS, CURB EXTENSIONS, BUS PADS,
PEDESTRIAN RAMPS, CATCH BASINS, PAVEMENT MARKINS,
STREET LIGHTING, AND TRAFFIC SIGNAL WORK**

**Together With All Work Incidental Thereto
BOROUGH OF QUEENS
CITY OF NEW YORK**

FOR THE DEPARTMENT OF TRANSPORTATION
PREPARED BY
THE RBA GROUP

OCTOBER 22, 2014

NYS DOT PIN X772.58
Fed. Aid Project No. _____

Bid Opening 11:00 A.M. on
Location 1st Floor Bid Room, 30-30 Thomson Ave., Long Island City, N.Y. 11101



115-074





NEW YORK CITY DEPARTMENT OF
DESIGN + CONSTRUCTION

**THE CITY OF NEW YORK
DEPARTMENT OF DESIGN AND CONSTRUCTION
DIVISION OF INFRASTRUCTURE**

30-30 THOMSON AVENUE
LONG ISLAND CITY, NEW YORK 11101-3045
TELEPHONE (718) 391-1000
WEBSITE www.nyc.gov/buildnyc

VOLUME 2 OF 3

**INFORMATION FOR BIDDERS
CONTRACT
PERFORMANCE AND PAYMENT BONDS
PREVAILING WAGE SCHEDULE**

FOR FURNISHING ALL LABOR AND MATERIALS NECESSARY AND REQUIRED
FOR:

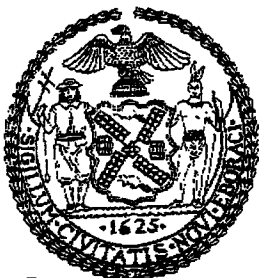

FOR THE DEPARTMENT OF TRANSPORTATION
PREPARED BY
IN-HOUSE DESIGN

DECEMBER 24, 2013



NOTICE TO BIDDERS

Please be advised that the City of New York has issued a new Standard Construction Contract. The new Contract, which is incorporated in this bid, is significantly different from the 2008 version previously used by the City. A listing of some of the significant changes is provided below. This notice is only a partial listing. Please refer to the Contract itself for a full understanding of the changes and the actual text of the changes that were made. The text of the revised Standard Construction Contract is the controlling document should there be any discrepancies between this notice and the Standard Construction Contract.

Significant changes include the following:

ARTICLE 11 DAMAGES CAUSED BY DELAYS

In 2008, the City embarked on a pilot project to test the use of new construction contract language altering the allocation of the risk of project delays, as between the City and the contractor. The City has determined to make the pilot project language the standard language for all City construction contracts. Accordingly, there is now one Standard City Construction Contract that is to be used by all agencies for all bids released after the release of the new contract. The damages for delay language is Article 11. Please note that changes have been made to the damages for delay provisions from the pilot to the adopted version.

ARTICLE 22 INSURANCE

Changes have been made to the insurance provisions, including incorporating requirements that the insurance provided comply with recent NYC Department of Buildings regulations specifying required dollar limits for CGL insurance for certain projects and requiring proof of builder's risk insurance prior to Work commencing rather than within 10 days of award.

ARTICLE 26 EXTRA WORK

The percentage paid for overhead for Extra Work pursuant to Section 26.1.11 is increased from 10% to 12% and the calculation of Worker's Compensation insurance costs reimbursed for Extra Work has been clarified.

ARTICLE 37 LABOR LAW REQUIREMENTS
ARTICLE 38 PAYROLL REPORTS

The provisions governing Labor Law provisions have been tightened, including requirements the employee identification cards include a photo (unless the requirement is waived), a prohibition on cash payments to employees and subcontractors, and clear enforcement authority requirements.

ARTICLE 70 ELECTRONIC FILING

A provision is added to make mandatory the electronic filing of certain alteration permits with the Department of Buildings.

Other significant changes include the following:

ARTICLE 7 INDEMNIFICATION

Changes have been made to the indemnification provisions.

ARTICLE 14 FINAL ACCEPTANCE OF WORK
ARTICLE 44 SUBSTANTIAL COMPLETION PAYMENT

The Commissioner is no longer required to issue a substantial completion determination in addition to the already existing requirement that the Engineer issue a substantial completion determination and reach an agreement on a punch list of remaining work. Now, the Engineer, when issuing the punch list to the Contractor, must also include a proposed schedule for the completion of the punch list. The Contractor may propose an alternative schedule that is subject to the approval of the Engineer. If the Contractor fails to respond to the Engineer's proposed schedule, the Engineer's schedule is deemed accepted.

ARTICLE 15 LIQUIDATED DAMAGES

The contract is revised to match Schedule A to provide that liquidated damages are available only until substantial completion.

ARTICLE 17 SUBCONTRACTS

The requirements for prior approval of subcontractors, and for contractors to be responsible for the actions of their subcontractors, have been tightened. The requirement that the Contractor list subcontractors in the City's Payee Information Portal has been added; the provision was previously attached as a rider.

ARTICLE 19 SECURITY DEPOSIT

The provisions governing the return of bid deposits are clarified.

ARTICLE 20 PAYMENT GUARANTEE

The Payment Guaranty provisions, which apply when the City does not require the Contractor to obtain payment bonds, has been significantly revised to track the requirements of State Finance law 137.

ARTICLE 28 RECORDKEEPING FOR EXTRA OR DISPUTED WORK

The recordkeeping requirement that currently apply to payments for Time & Materials for extra work are expressly made applicable to regular work that is paid for on a T & M basis.

ARTICLE 35 EMPLOYEES

The whistleblower provisions of local law are added to the construction contract. They previously have been attached as a rider.

ARTICLE 38 PAYROLL REPORTS
ARTICLE 77 RECORDS RETENTION

Requirements that records be maintained for six years and directions on how such records must be made available.

ARTICLE 42 PARTIAL PAYMENTS

Increased flexibility has been provided for when contractors may submit invoices.

ARTICLE 62 TAX EXEMPTION

The provisions identifying the State tax exemption for municipalities are revised to more clearly describe State law.

(NO TEXT ON THIS PAGE)

CITY OF NEW YORK

**DEPARTMENT OF
DESIGN AND CONSTRUCTION
DIVISION OF INFRASTRUCTURES**

INFORMATION FOR BIDDERS

SEPTEMBER 2008

(NO TEXT ON THIS PAGE)

*CITY OF NEW YORK CITY
DEPARTMENT OF DESIGN AND CONSTRUCTION
INFORMATION FOR BIDDERS*

TABLE OF CONTENTS

SECTION 1.	DESCRIPTION AND LOCATION OF WORK	1
SECTION 2.	TIME AND PLACE FOR RECEIPT OF BIDS	1
SECTION 3.	DEFINITIONS	1
SECTION 4.	INVITATION FOR BIDS AND CONTRACT DOCUMENTS	1
SECTION 5.	PRE-BID CONFERENCE	2
SECTION 6.	AGENCY CONTACT	2
SECTION 7.	BIDDER'S OATH	2
SECTION 8.	EXAMINATION AND VIEWING OF SITE, CONSIDERATION OF OTHER SOURCES OF INFORMATION AND CHANGED CONDITIONS	2
SECTION 9.	EXAMINATION OF PROPOSED CONTRACT	3
SECTION 10.	FORM OF BID	3
SECTION 11.	IRREVOCABILITY OF BID	3
SECTION 12.	ACKNOWLEDGMENT OF AMENDMENTS	4
SECTION 13.	BID SAMPLES AND DESCRIPTIVE LITERATURE	4
SECTION 14.	PROPRIETARY INFORMATION/TRADE SECRETS	4
SECTION 15.	PRE-OPENING MODIFICATION OR WITHDRAWAL OF BIDS	4
SECTION 16.	BID EVALUATION AND AWARD	4
SECTION 17.	LATE BIDS, LATE WITHDRAWALS AND LATE MODIFICATIONS	5
SECTION 18.	WITHDRAWAL OF BIDS.	5
SECTION 19.	MISTAKE IN BIDS	5
SECTION 20.	LOW TIE BIDS	6
SECTION 21.	REJECTION OF BIDS	6
SECTION 22.	RIGHT TO APPEAL DETERMINATIONS OF NON-RESPONSIVENESS OR NON-RESPONSIBILITY AND RIGHT TO PROTEST SOLICITATIONS AND AWARD	7
SECTION 23.	AFFIRMATIVE ACTION AND EQUAL EMPLOYMENT OPPORTUNITY	7
SECTION 24.	VENDEX QUESTIONNAIRES	7
SECTION 25.	COMPLAINTS ABOUT THE BID PROCESS	8
SECTION 26.	BID, PERFORMANCE AND PAYMENT SECURITY	8
SECTION 27.	FAILURE TO EXECUTE CONTRACT	9
SECTION 28.	BIDDER RESPONSIBILITIES AND QUALIFICATIONS	9
SECTION 29.	EMPLOYMENT REPORT	10
SECTION 30.	LABOR LAW REQUIREMENTS	10
SECTION 31.	INSURANCE	10
SECTION 32.	LUMP SUM CONTRACTS	11
SECTION 33.	UNIT PRICE CONTRACTS	11
SECTION 34.	EXCISE TAX	11
SECTION 35.	LICENSES AND PERMITS	11
SECTION 36.	MULTIPLE PRIME CONTRACTORS	11
SECTION 37.	LOCALLY BASED ENTERPRISE REQUIREMENTS (LBE)	12
SECTION 38.	BID SUBMISSION REQUIREMENTS	13
SECTION 39.	COMPTROLLER'S CERTIFICATE	14
SECTION 40.	PROCUREMENT POLICY BOARD RULES	14
SECTION 41.	DDC SAFETY REQUIREMENTS	14

(NO TEXT ON THIS PAGE)

INFORMATION FOR BIDDERS

1. Description and Location of Work

The description and location of the work for which bids are requested are specified in Attachment 1, "Bid Information". Attachment 1 is included as page A-1 of the Bid Booklet.

2. Time and Place for Receipt of Bids

Sealed bids shall be received on or before the date and hour specified in Attachment 1, at which time they will be publicly opened and read aloud in the presence of the Commissioner or his or her representative, and any bidders who may desire to be present.

3. Definitions

The definitions set forth in the Procurement Policy Board Rules shall apply to this Invitation For Bids.

4. Invitation For Bids and Contract Documents

(A) Except for titles, sub-titles, headings, running headlines, tables of contents and indices (all of which are printed herein merely for convenience) the following, except for such portions thereof as may be specifically excluded, shall be deemed to be part of the Contract and the Invitation for Bids.

- (1) All provisions required by law to be inserted in this Contract, whether actually inserted or not
- (2) The Contract Drawings and Specifications
- (3) The General Conditions, the General Requirements and the Special Conditions, if any
- (4) The Contract
- (5) The Information for Bidders; Request for Proposals; Notice of Solicitation and Proposal For Bids; Bid or Proposal, and, if used, the Bid Booklet
- (6) The Budget Director's Certificate; all Addenda issued prior to the receipt of the bids; the Notice of Award; Performance and Payment Bonds, if required; and the Notice to Proceed with the Work.

(B) For particulars as to this procurement, including quantity and quality of the purchase, extent of the work or labor to be performed, delivery and performance schedule, and any other special instructions, prospective bidders are referred to the Invitation For Bids Documents. A copy of such documents can be obtained at the location set forth in Attachment 1.

(C) Deposit for Copy of Invitation For Bids Documents: Prospective bidders may obtain a copy of the Invitation For Bids Documents by complying with the conditions set forth in the Notice of Solicitation. The deposit must be in the form of a check or money order made payable to the City of New York, and drawn upon a state or national bank or trust company, or a check of such bank or trust company signed by a duly authorized officer thereof.

(D) Return of Invitation For Bids Documents: All Invitation For Bids Documents must be returned to the Department upon request. If the bidder elects not to submit a bid thereunder, the

Invitation For Bids Documents shall be returned to the Department, along with a statement that no bid will be submitted.

(E) Return of Deposit: Such deposit will be returned within 30 days after the award of the contract or the rejection of all bids as set forth in the advertisement, provided the Invitation For Bids Documents are returned to the location specified in Attachment 1, in physical condition satisfactory to the Commissioner.

(F) Additional Copies: Additional copies of the Invitation For Bids Documents may be obtained, subject to the conditions set forth in the advertisement for bids.

5. Pre-Bid Conference

A pre-bid conference shall be held as set forth in Attachment 1. Nothing stated at the pre-bid conference shall change the terms or conditions of the Invitation For Bids Documents, unless a change is made by written amendment as provided in Section 9 below. Failure to attend a mandatory pre-bid conference shall constitute grounds for the rejection of the bid.

6. Agency Contact

Any questions or correspondence relating to this bid solicitation shall be addressed to the Agency Contact person specified in Attachment 1.

7. Bidder's Oath

(A) The bid shall be properly signed by an authorized representative of the bidder and the bid shall be verified by the written oath of the authorized representative who signed the bid, that the several matters stated and information furnished therein are in all aspects true.

(B) A materially false statement willfully or fraudulently made in connection with the bid or any of the forms completed and submitted with the bid may result in the termination of any Contract between the City and the Bidder. As a result, the Bidder may be barred from participating in future City contracts as well as be subject to possible criminal prosecution.

8. Examination and Viewing of Site, Consideration of Other Sources of Information and Changed Conditions

(A) Pre-Bidding (Investigation) Viewing of Site -Bidders must carefully view and examine the site of the proposed work, as well as its adjacent area, and seek other usual sources of information, for they will be conclusively presumed to have full knowledge of any and all conditions on, about or above the site relating to or affecting in any way the performance of the work to be done under the Contract which were or should have been indicated to a reasonably prudent bidder. To arrange a date for visiting the work site, bidders are to contact the Agency Contact person specified in Attachment 1.

(B) Should the contractor encounter during the progress of the work subsurface conditions at the site materially differing from any shown on the Contract Drawings or indicated in the Specifications or such subsurface conditions as could not reasonably have been anticipated by the contractor and were not anticipated by the City, which conditions will materially affect the cost of the work to be done under the

Contract, the attention of the Commissioner must be called immediately to such conditions before they are disturbed. The Commissioner shall thereupon promptly investigate the conditions. If he finds that they do so materially differ, or that they could not have been reasonably anticipated by the contractor and were not anticipated by the City, the Contract may be modified with his written approval.

9. Examination of Proposed Contract

(A) Request for Interpretation or Correction: Prospective bidders must examine the Contract Documents carefully and before bidding must request the Commissioner in writing for an interpretation or correction of every patent ambiguity, inconsistency or error therein which should have been discovered by a reasonably prudent bidder. Such interpretation or correction, as well as any additional contract provisions the Commissioner may decide to include, will be issued in writing by the Commissioner as an addendum to the Contract, which will be transmitted to each person recorded as having received a copy of the Contract Documents from the Department. Transmission of such addendum will be by mail, e-mail, facsimile or hand delivery. Such addendum will also be posted at the place where the Contract Documents are available for the inspection of prospective bidders. Upon transmission as provided for herein, such addendum shall become a part of the Contract Documents, and binding on all bidders, whether or not actual notice of such addendum is shown.

(B) Only Commissioner's Interpretation or Correction Binding: Only the written interpretation or correction so given by the Commissioner shall be binding, and prospective bidders are warned that no other officer, agent or employee of the City is authorized to give information concerning, or to explain or interpret, the Contract.

(C) Documents given to a subcontractor for the purpose of soliciting the subcontractor's bid shall include either a copy of the bid cover sheet or a separate information sheet setting forth the project name, the Contract number (if available), the contracting agency and the Project's location.

10. Form of Bid

Each bid must be submitted upon the prescribed form and must contain: a) the name, residence and place of business of the person or persons making the same; b) the names of all persons interested therein, and if no other person is so interested, such fact must be distinctly stated; c) a statement to the effect that it is made without any connection with any other person making a bid for the same purpose and that it is in all respects fair and without collusion or fraud; d) a statement that no Council member or other officer or employee or person whose salary is payable in whole or part from the City Treasury is directly or indirectly interested therein or in the supplies, materials or equipment and work or labor to which it relates, or in any portion of the profits thereof; e) a statement that the bidder is not in arrears to the City or to any agency upon a debt or contract or taxes, and is not a defaulter as surety or otherwise upon any obligation to the City to any agency thereof, except as set forth in the bid.

THE BID SHALL BE TYPEWRITTEN OR WRITTEN LEGIBLY IN INK. THE BID SHALL BE SIGNED IN INK. ERASURES OR ALTERATIONS SHALL BE INITIALED BY THE SIGNER IN INK. FAILURE TO CONFORM TO THE REQUIREMENTS OF THIS SECTION 10 SHALL RESULT IN THE REJECTION OF THE BID.

11. Irrevocability of Bid

The prices set forth in the bid cannot be revoked and shall be effective until the award of the Contract, unless the bid is withdrawn as provided for in Sections 15 and 18 below.

12. Acknowledgment of Amendments

The receipt of any amendment to the Contract Documents shall be acknowledged by the bidder in its bid submission.

13. Bid Samples and Descriptive Literature

Bid samples and descriptive literature shall not be submitted by the bidder, unless expressly requested elsewhere in the Contract or Contract Documents. Any unsolicited bid samples or descriptive literature which are submitted shall not be examined or tested and shall not be deemed to vary any of the provisions of this Contract.

14. Proprietary Information/Trade Secrets

(A) The bidder shall identify those portions of the bid which it deems to be confidential, proprietary information or trade secrets, and provide justification why such materials shall not be disclosed by the City. All such materials shall be clearly indicated by stamping the pages on which such information appears, at the top and bottom thereof with the word "Confidential". Such materials stamped "Confidential" must be easily separable from the non-confidential sections of the bid.

(B) All such materials so indicated shall be reviewed by the Agency and any decision not to honor a request for confidentiality shall be communicated in writing to the bidder. For those bids which are unsuccessful, all such confidential materials shall be returned to the bidder. Prices, makes and model or catalog numbers of the items offered, deliveries, and terms of payment shall be publicly available after bid opening, regardless of any designation of confidentiality made by the bidder.

15. Pre-Opening Modification or Withdrawal of Bids

Bids may be modified or withdrawn by written notice received in the office designated in Attachment 1, before the time and date set for the bid opening. If a bid is withdrawn in accordance with this Section, the bid security, if any, shall be returned to the bidder.

16. Bid Evaluation and Award

In accordance with the New York City Charter, the Procurement Policy Board Rules and the terms and conditions of this Invitation For Bids, this Contract shall be awarded, if at all, to the responsible bidder whose bid meets the requirements and evaluation criteria set forth in the Invitation For Bids, and whose bid price is either the most favorable bid price or, if the Invitation For Bids so states, the most favorable evaluated bid price. A bid may not be evaluated for any requirement or criterion that is not disclosed in the Invitation For Bids.

Restriction: No negotiations with any bidder shall be allowed to take place except under the circumstances and in the manner set forth in Section 21. Nothing in this Section shall be deemed to permit a contract award to a bidder submitting a higher quality item than that designated in the Invitation For Bids, if that bid is not also the most favorable bid.

17. Late Bids, Late Withdrawals and Late Modifications

Any bid received at the place designated in the solicitation after the time and date set for receipt of bids is late and shall not be considered. Any request for withdrawal or modification received at the place designated in the solicitation after the time and date set for receipt of bids is late and shall not be considered. The exception to this provision is that a late modification of a successful bid that makes the bid terms more favorable to the City shall be considered at any time it is received.

18. Withdrawal of Bids.

Except as provided for in Section 15, above, a bidder may not withdraw its bid before the expiration of forty-five (45) days after the date of the opening of bids; thereafter, a bidder may withdraw its bid only in writing and in advance of an actual award. If within sixty (60) days after the execution of the Contract, the Commissioner fails to fix the date for commencement of work by written notice to the bidder, the bidder, at his option, may ask to be relieved of his obligation to perform the work called for by written notice to the Commissioner. If such notice is given to the Commissioner, and the request to withdraw is granted, the bidder waives all claims in connection with this Contract.

19. Mistake in Bids

(A) Mistake Discovered Before Bid Opening: A bidder may correct mistakes discovered before the time and date set for bid opening by withdrawing or correcting the bid as provided in Section 15 above.

(B) Mistakes Discovered Before Award

(1) In accordance with General Municipal Law (Section 103, subdivision 11), where a unilateral error or mistake is discovered in a bid, such bid may be withdrawn upon written approval of the Agency Chief Contracting Officer if the following conditions are met:

- (a) The mistake is known or made known to the agency prior to the awarding of the Contract or within 3 days after the opening of the bid, whichever period is shorter; and
- (b) The price bid was based upon an error of such magnitude that enforcement would be unconscionable; and
- (c) The bid was submitted in good faith and the bidder submits credible evidence that the mistake was a clerical error as opposed to a judgment error; and
- (d) The error in the bid is actually due to an unintentional and substantial arithmetic error or an unintentional omission of a substantial quantity of work, labor, material or services made directly in the compilation of the bid, which unintentional arithmetic error or unintentional omission can be clearly shown by objective evidence drawn from inspection of the original work paper, documents, or materials used in the preparation of the bid sought to be withdrawn; and
- (e) It is possible to place the agency in the same position as existed prior to the bid.

(2) Unless otherwise required by law, the sole remedy for a bid mistake in accordance with this Article shall be withdrawal of the bid, and the return of the bid bond, or other security, if any, to the bidder. Thereafter, the agency may, in its discretion, award the Contract to the next lowest bidder or rebid the Contract. Any amendment to or reformation of a bid or a Contract to rectify such an error or mistake

therein is strictly prohibited.

(3) If the mistake and the intended correct bid are clearly evident on the face of the bid document, the bid shall be corrected to the intended correct bid and may not be withdrawn. Examples of mistakes that may be corrected are typographical errors, errors in extending unit prices, transposition errors and arithmetical errors.

20. Low Tie Bids

(A) When two or more low responsive bids from responsible bidders are identical in price, meeting all the requirements and criteria set forth in the Invitation For Bids, the Agency Chief Contracting Officer will break the tie in the following manner and order of priority:

- (1) Award to a certified New York City small, minority or woman-owned business entity bidder;
- (2) Award to a New York City bidder;
- (3) Award to a certified New York State small, minority or woman-owned business bidder;
- (4) Award to a New York State bidder.

(B) If two or more bidders still remain equally eligible after application of paragraph (A) above, award shall be made by a drawing by lot limited to those bidders. The bidders involved shall be invited to attend the drawing. A witness shall be present to verify the drawing and shall certify the results on the bid tabulation sheet.

21. Rejection of Bids

(A) Rejection of Individual Bids: The Agency may reject a bid if:

- (1) The bidder fails to furnish any of the information required pursuant to Section 24 or 28 hereof; or if
- (2) The bidder is determined to be not responsible pursuant to the Procurement Policy Board Rules; or if
- (3) The bid is determined to be non-responsive pursuant to the Procurement Policy Board Rules; or if
- (4) The bid, in the opinion of the Agency Chief Contracting Officer, contains unbalanced bid prices and is thus non-responsive, unless the bidder can show that the prices are not unbalanced for the probable required quantity of items, or if the imbalance is corrected pursuant to Section 15.

(B) Rejection of All Bids: The Agency, upon written approval by the Agency Chief Contracting Officer, may reject all bids and may elect to resolicit bids if in its sole opinion it shall deem it in the best interest of the City so to do.

(C) Rejection of All Bids and Negotiation With All Responsible Bidders: The Agency Head may determine that it is appropriate to cancel the Invitation For Bids after bid opening and before award and to complete the acquisition by negotiation. This determination shall be based on one of the following reasons:

- (1) All otherwise acceptable bids received are at unreasonable prices, or only one bid is received and the Agency Chief Contracting Officer cannot determine the reasonableness of the bid price, or no responsive bid has been received from a responsible bidder; or
- (2) In the judgment of the Agency Chief Contracting Officer, the bids were not independently arrived at in open competition, were collusive, or were submitted in bad faith.

(D) When the Agency has determined that the Invitation for Bids is to be canceled and that use of negotiation is appropriate to complete the acquisition, the contracting officer may negotiate and award the Contract without issuing a new solicitation, subject to the following conditions:

- (1) prior notice of the intention to negotiate and a reasonable opportunity to negotiate have been given by the contracting officer to each responsible bidder that submitted a bid in response to the Invitation for Bids;
- (2) the negotiated price is the lowest negotiated price offered by a responsible bidder; and
- (3) the negotiated price is lower than the lowest rejected bid price of a responsible bidder that submitted a bid in response to the Invitation for Bids.

22. Right to Appeal Determinations of Non-Responsiveness or Non-Responsibility and Right to Protest Solicitations and Award

The bidder has the right to appeal a determination of non-responsiveness or non-responsibility and has the right to protest a solicitation and award. For further information concerning these rights, the bidder is directed to the Procurement Policy Board Rules.

23. Affirmative Action and Equal Employment Opportunity

This Invitation For Bids is subject to applicable provisions of Federal, State and Local Laws and executive orders requiring affirmative action and equal employment opportunity.

24. VENDEX Questionnaires

(A) Requirement: Pursuant to Administrative Code Section 6-116.2 and the PPB Rules, bidders may be obligated to complete and submit VENDEX Questionnaires. Generally, if this bid is \$100,000 or more, or if this bid when added to the sum total of all contracts, concessions and franchises the bidder has received from the City and any subcontracts received from City contractors over the past twelve months, equals or exceeds \$100,000, Vendex Questionnaires must be completed. If required, Vendex Questionnaires must be completed and submitted before any award of contract may be made or before approval is given for a proposed subcontractor. Non-compliance with these submission requirements may result in the disqualification of the bid, disapproval of a subcontractor, subsequent withdrawal of approval for the use of an approved subcontractor, or the cancellation of the contract after its award.

(B) Submission: Vendex Questionnaires must be submitted directly to the Mayor's Office of Contract Services, ATTN: Vendex, 253 Broadway, 9th Floor, New York, New York 10007. In addition, the bidder must submit a Confirmation of Vendex Compliance to the agency. A form for this confirmation is set forth in the Bid Booklet.

(C) Obtaining Forms: Vendex Questionnaires, as well as detailed instructions, may be obtained at www.nyc.gov/vendex. The bidder may also obtain Vendex forms and instructions by contacting the

Agency Chief Contracting Office or the contract person for this contract.

25. Complaints About the Bid Process

The New York City Comptroller is charged with the audit of contracts in New York City. Any vendor who believes that there has been unfairness, favoritism or impropriety in the bid process should inform the Comptroller, Office of Contract Administration, One Centre Street, Room 835, New York, New York; telephone number (212)669-2797.

26. Bid, Performance and Payment Security

(A) Bid Security: Each bid must be accompanied by bid security in an amount and type specified in Attachment 1 (page A-1 of the Bid Booklet). The bid security shall assure the City of New York of the adherence of the bidder to its proposal, the execution of the Contract, and the furnishing of Performance and Payment Bonds by the bidder, if required in Attachment 1. Bid security shall be returned to the bidder as follows:

- (1) Within ten (10) days after the bid opening, the Comptroller will be notified to return the deposits of all but the three (3) lowest bidders. Within five (5) days after the award, the Comptroller will be notified to return the deposits of the remaining two unsuccessful bidders.
- (2) Within five (5) days after the execution of the Contract and acceptance of the Contractor's bonds, the Comptroller will be notified to return the bid security of the successful bidder or, if performance and payment bonds are not required, only after the sum retained under Article 21 of the Contract equals the amount of the bid security.
- (3) Where all bids are rejected, the Comptroller will be notified to return the deposit of the three (3) lowest bidders at the time of rejection.

(B) Performance and Payment Security: Performance and Payment Security must be provided in an amount and type specified in Attachment 1 (page A-1 of the Bid Booklet). The performance and payment security shall be delivered by the contractor prior to or at the time of execution of the Contract. If a contractor fails to deliver the required performance and payment security, its bid security shall be enforced, and an award of Contract may be made to the next lowest responsible and responsive bidder, or the contract may be rebid.

(C) Acceptable Types of Security: Acceptable types of security for bids, performance, and payment shall be limited to the following:

- (1) a one-time bond in a form satisfactory to the City;
- (2) a bank certified check or money order;
- (3) obligations of the City of New York; or
- (4) other financial instruments as determined by the Office of Construction in consultation with the Comptroller.

Whenever the successful bidder deposits obligations of the City of New York as performance and payment security, the Comptroller may sell and use the proceeds thereof for any purpose for which the principal or surety on such bond would be liable under the terms of the Contract. If the money is deposited with the Comptroller, the successful bidder shall not be entitled to receive interest on such money from the City.

(D) Form of Bonds: Security provided in the form of bonds must be prepared on the form of bonds authorized by the City of New York. Forms for bid, performance, and payment bonds are included in the Invitation for Bids Documents. Such bonds must have as surety thereunder such surety company or companies as are: (1) approved by the City of New York; (2) authorized to do business in the State of New York, and (3) approved by the Department of the Treasury of the United States. Premiums for any required bonds must be included in the base bid.

The bidder is advised that submission of a bid bond where the surety on such bond fails to meet the criteria set forth herein, shall result in the rejection of the bid as non-responsive.

The Department of the Treasury of the United States advises that information concerning approved surety companies may be obtained as follows: (1) from the Government Printing Office at 202-512-1800; (2) through the Internet at <http://www.fms.treas.gov/c570/index.html>, and (3) through a computerized public bulletin board, which can be accessed by using your computer modem and dialing 202-874-6887.

(E) Power of Attorney: Attorneys in fact who sign bid, performance, or payment bonds must file with each bond a certified copy of their power of attorney to sign said bonds.

27. Failure to Execute Contract

In the event of failure of the successful bidder to execute the Contract and furnish the required security within ten (10) days after notice of the award of the Contract, the deposit of the successful bidder or so much thereof as shall be applicable to the amount of the award made shall be retained by the City, and the successful bidder shall be liable for and hereby agrees to pay on demand the difference between the price bid and the price for which such Contract shall be subsequently awarded, including the cost of any required reletting and less the amount of such deposit. No plea of mistake in such accepted bid shall be available to the bidder for the recovery of the deposit or as a defense to any action based upon such accepted bid. Further, should the bidder's failure to comply with this Section cause any funding agency, body or group (Federal, State, City, Public, Private, etc.) to terminate, cancel or reduce the funding on this project, the bidder in such event shall be liable also to the City for the amount of actual funding withdrawn by such agency on this project, less the amount of the forfeited deposit.

28. Bidder Responsibilities and Qualifications

(A) Bidders must include with their bids all information necessary for a determination of bidder responsibility, as set forth in the Specifications.

(B) The Agency may require any bidder or prospective bidder to furnish all books of account, records, vouchers, statements or other information concerning the bidder's financial status for examination as may be required by the Agency to ascertain the bidder's responsibility and capability to perform the Contract. If required, a bidder must also submit a sworn statement setting forth such information as the Agency may require concerning present and proposed plant and equipment, the personnel and qualifications of his working organizations, prior experience and performance record.

(C) Oral Examination on Qualifications: In addition thereto, and when directed by the Agency, the bidder, or a responsible officer, agent or employee of the bidder, must submit to an oral examination to be conducted by the Agency in relation to his proposed tentative plan and schedule of

operations, and such other matters as the Agency may deem necessary in order to determine the bidder's ability and responsibility to perform the work in accordance with the Contract. Each person so examined must sign and verify a stenographic transcript of such examination noting thereon such corrections as such person may desire to make.

(D) If the bidder fails or refuses to supply any of the documents or information set forth in paragraph (B) hereof or fails to comply with any of the requirements thereof, the Agency may reject the bid.

29. Employment Report

In accordance with Executive Order No. 50 (1980) as modified by Executive Order 108 (1986), the filing of a completed Employment Report (ER) is a requirement of doing business with the City of New York for construction contractors with contracts of \$1,000,000 or more and subcontractors with construction subcontracts of \$750,000 or more. The required forms and information are included in the Bid Booklet.

30. Labor Law Requirements

(A) General: The successful bidder will be required to comply strictly with all Federal, State and local labor laws and regulations.

(B) New York State Labor Law: This Contract is subject to New York State Labor Law Section 220, which requires that construction workers on the site be paid prevailing wages and supplements. The Contractor is reminded that all wage provisions of this Contract will be enforced strictly and failure to comply will be considered when evaluating performance. Noncompliance may result in the contractor being debarred by the City from future contracts. Complaints filed with the Comptroller may result in decisions which may debar a contractor from bidding contracts with any state governmental entity and other political subdivisions.

(C) Records: The Contractor is expected to submit accurate payroll reports and other required documents and verify attendance and job classifications being utilized in compliance with the law, Contract provisions and agency procedures.

31. Insurance

(A) Bidders are advised that the insurance requirements contained herein are regarded as material terms of the Contract. As required by Article 22 of the Contract, the contractor must effect and maintain with companies licensed and authorized to do business in the State of New York, the types of insurance set forth therein, when required by and in the amounts set forth in Schedule A of the General Conditions. Such required insurance must be provided from the date the contractor is ordered to commence work and up to the date of final acceptance of all required work.

(B) The contractor must, within ten days of receipt of the notice of award, submit the following insurance documentation: (a) original certificate of insurance for general liability in the amount required by Schedule A of the General Conditions, and (b) original certificates of insurance or other proof of coverage for workers' compensation and disability benefits, as required by Section 57 of the New York State Workers' Compensation Law and Section 220 of the Disability Benefits Law.

32. Lump Sum Contracts

(A) Comparison of Bids: Bids on Lump Sum Contracts will be compared on the basis of the lump sum price bid, adjusted for alternate prices bid, if any.

(B) Lump Sum Bids for "General Construction Work" which include excavation shall include all necessary excavation work defined in the Specifications as being included in the lump sum bid. The bidder shall also bid a unit price for the additional cost of excavating material which is defined in the Specifications as excavation for which additional payment will be made. The total estimated additional cost of removing such material will be taken as the quantity set forth in the Engineer's Estimate multiplied by the unit price bid. This total estimated cost of additional excavation shall be added to the lump sum bid for the General Construction Work for the purpose of comparing bids to determine the low bidder.

(C) Variations from Engineer's Estimate: The Engineer's Estimate of the quantity of excavation for which additional payment will be made is approximate only and is given solely to be used as a uniform basis for the comparison of bids and such estimate is not to be considered as part of this contract. The quantities actually required to complete the contract work may be more or less than the quantities in the Engineer's Estimate and, if so, no action for damages or for loss of profits shall accrue to the contractor by reason thereof.

33. Unit Price Contracts

(A) Comparison of Bids: Bids on Unit Price Contracts will be compared on the basis of a total estimated price, arrived at by taking the sum of the estimated quantities of such items, in accordance with the Engineer's Estimate of Quantities set forth in the Bid Schedule, multiplied by the corresponding unit prices, and including any lump sum bids on individual items.

(B) Variations from Engineer's Estimate: Bidders are warned that the Engineer's Estimate of Quantities on the various items of work and materials is approximate only, given solely to be used as a uniform basis for the comparison of bids, and is not be considered part of this contract. The quantities actually required to complete the contract work may be less or more than so estimated, and if so, no action for damages or for loss of profits shall accrue to the contractor by reason thereof.

(C) Overruns: The terms and conditions applicable to overruns of unit price items are set forth in Article 26 of the Contract.

34. Excise Tax

Bidders are referred to the Specifications for information on Federal Excise Tax exemptions.

35. Licenses and Permits

The successful bidder will be required to obtain all necessary licenses and permits necessary to perform the work.

36. Multiple Prime Contractors

If more than one prime contractor will be involved on this project, all contractors are required to examine the Invitation for Bid packages for all other parts of the project.

37. Locally Based Enterprise Requirements (LBE)

This Contract is subject to the requirements of Administrative Code, Section 6-108.1, and the regulations promulgated thereunder. No construction contract will be awarded unless and until these requirements have been complied with in their entirety. The bidder is advised of the provisions set forth below, as well as the provisions with respect to the Locally Based Enterprise Program contained in Article 67 of the Contract. The contractor is advised that:

(A) If any portion of the Contract is subcontracted, not less than ten percent of the total dollar amount of the contract shall be awarded to locally based enterprises ("LBEs"); except, where less than ten percent of the total dollar amount of the Contract is subcontracted, such lesser percentage shall be so awarded.

(B) No contractor shall require performance and payment bonds from LBE subcontractors.

(C) No Contract shall be awarded unless the contractor first identifies in its bid:

- (1) the percentage, dollar amount and type of work to be subcontracted; and
- (2) the percentage, dollar amount and type of work to be subcontracted to LBEs.

(D) Within ten calendar days after notification of low bid, the apparent low bidder shall submit an "LBE Participation Schedule" to the contracting agency. If such schedule does not identify sufficient LBE subcontractors to meet the requirements of Administrative Code Section 6-108.1, the apparent low bidder shall submit documentation of its good faith efforts to meet such requirements.

(1) The "LBE Participation Schedule" shall include:

- (a) the name and address of each LBE that will be given a subcontract,
- (b) the percentage, dollar amount and type of work to be subcontracted to the LBE, and
- (c) the dates when the LBE subcontract work will commence and end.

(2) The following documents shall be attached to the "LBE Participation Schedule":

- (a) verification letters from each subcontractor listed in the "LBE Participation Schedule" stating that the LBE will enter into a formal agreement for work,
- (b) certification documents of any proposed LBE subcontractor which is not on the LBE certified list, and
- (c) copies of the certification letter of any proposed subcontractor which is an LBE.

(3) Documentation of good faith efforts to achieve the required LBE percentage shall include as appropriate but not limited to the following:

- (a) attendance at prebid meetings, when scheduled by the agency, to advise bidders of contract requirements;

- (b) advertisement where appropriate in general circulation media, trade association publications and small business media of the specific subcontracts that would be at least equal to the percentage goal for LBE utilization specified by the contractor;
- (c) written notification to association of small, minority and women contractors soliciting specific subcontractors;
- (d) written notification by certified mail to LBE firms that their interest in the contract is solicited for specific work items and their estimated values;
- (e) demonstration of efforts made to select portions of the work for performance by LBE firms in order to increase the likelihood of achieving the stated goal;
- (f) documented efforts to negotiate with LBE firms for specific subcontracts, including at a minimum:
 - (i) The names, address and telephone numbers of LBE firms that are contacted;
 - (ii) A description of the information provided to LBE firms regarding the plans and specifications for portions of the work to be performed;
 - (iii) Documentation showing that no reasonable price can be obtained from LBE firms;
 - (iv) A statement of why agreements with LBE firms were not reached;
- (g) a statement of the reason for rejecting any LBE firm which the contractor deemed to be unqualified; and
- (h) documentation of efforts made to assist the LBE firms contacted that needed assistance in obtaining required insurance.

(E) Unless otherwise waived by the Commissioner with the approval of the Office of Economic and Financial Opportunity, failure of a proposed contractor to provide the information required by paragraphs (C) and (D) above may render the bid non-responsive and the Contract may not be awarded to the bidder. If the contractor states that it will subcontract a specific portion of the work, but can demonstrate despite good faith efforts it cannot achieve its required LBE percentage for subcontracted work until after award of Contract, the Contract may be awarded, subject to a letter of compliance from the contractor stating that it will comply with Administrative Code Section 6-108.1 and subject to approval by the Commissioner. If the contractor has not met its required LBE percentage prior to award, the contractor shall demonstrate that a good faith effort has been made subsequent to award to obtain LBEs on each subcontract until it meets the required percentage.

(F) When a bidder indicates prior to award that no work will be subcontracted, no work may be subcontracted without the prior written approval of the Commissioner, which shall be granted only if the contractor in good faith seeks LBE subcontractors at least six weeks prior to the start of work.

(G) The contractor may not substitute or change any LBE which was identified prior to award of the contract without the written permission of the Commissioner. The contractor shall make a written application to the Commissioner for permission to make such substitution or change, explaining why the contractor needs to change its LBE subcontractor and how the contractor will meet its LBE subcontracting requirement. Copies of such application must be served on the originally identified LBE by certified mail return receipt requested, as well as the proposed substitute LBE. The Commissioner shall determine whether or not to grant the contractor's request for substitution.

38. Bid Submission Requirements

The Bid Submission Requirements are set forth on page 2 of the Bid Booklet.

39. Comptroller's Certificate

This Contract shall not be binding or of any force unless it is registered by the Comptroller in accordance with Section 328 of the City Charter and the Procurement Policy Board Rules. This Contract shall continue in force only after annual appropriation of funds by the City of New York and certification as hereinabove set forth.

40. Procurement Policy Board Rules

This Invitation For Bids is subject to the Rules of the Procurement Policy Board of the City of New York. In the event of a conflict between said Rules and a provision of this Invitation For Bids, the Rules shall take precedence.

41. DDC Safety Requirements

The DDC Safety Requirements apply to the work to be performed pursuant to the Contract. The DDC Safety Requirements are set forth on the following pages.

CITY OF NEW YORK
DEPARTMENT OF DESIGN AND CONSTRUCTION
SAFETY REQUIREMENTS

THE DDC SAFETY REQUIREMENTS INCLUDE THE FOLLOWING SECTIONS:

- I. POLICY ON SITE SAFETY**
- II. PURPOSE**
- III. DEFINITIONS.....**
- IV. RESPONSIBILITIES.....**
- V. SAFETY QUESTIONNAIRE**
- VI. SAFETY PROGRAM AND SITE SAFETY PLAN**
- VII. KICK-OFF/PRE-CONSTRUCTION MEETINGS AND SAFETY REVIEW**
- VIII. EVALUATION DURING WORK IN PROGRESS**
- IX. SAFETY PERFORMANCE EVALUATION.....**

I. POLICY ON SITE SAFETY

The City of New York Department of Design and Construction (DDC) is committed to a policy of injury and illness prevention and risk management for construction work that will ensure the safety and health of the workers engaged in the projects and the protection of the general public. Therefore, it is DDC's policy that work carried out by Contractors on DDC jobsites must, at a minimum, comply with applicable federal, state and city laws, rules and regulations, including without limitation:

- ❑ U. S. Department of Labor 29 Code of Federal Regulations (CFR) Part 1926 and applicable Sub-parts of Part 1910 – U.S. Occupational Safety and Health Administration (OSHA) including, but not limited to "Respiratory Protection" (29 CFR 1910.134), "Permit-Required Confined Spaces" (29 CFR 1910.146), and "Hazard Communication" (29 CFR 1910.1200);
- ❑ New York State Department of Labor Industrial Code Rule 23 – Protection in Construction, Demolition and Excavation;
- ❑ New York City Construction Codes, Title 28
- ❑ NYC Department of Transportation Title 34 Chapter 2 – Highway Rules
- ❑ New York State Department of Labor Industrial Code Rule 753
- ❑ NYC Local Law No. 113 (2005) Noise Control Code

In addition, all regulations promulgated by the NYC Department of Transportation, including requirements for Maintenance and Protection of Traffic (MPT), are applicable when contained in contract specifications. While MPT is a significant component of work in our Infrastructure Division, it does not supersede or exempt Contractors from complying with other applicable health and safety standards (for example, excavating and trenching standards, operation of heavy equipment and compliance with City environmental and noise regulations).

II. PURPOSE

The purpose of this policy is to ensure that Contractors perform their work and supervise their employees in accordance with all applicable federal, state and city rules and regulations. Further, Contractors will be expected to minimize or eliminate jobsite and public hazard, through a planning, inspection, auditing and corrective action process. The goal is to control risks so that injuries, illnesses and accidents to contractors' employees, DDC employees and the general public, as well as damage to city-owned and private property, are reduced to the lowest level feasible.

III. DEFINITIONS

Agency Chief Contracting Officer (ACCO): The ACCO shall mean the person delegated authority by the Commissioner to organize and supervise the procurement activity of subordinate Agency staff in conjunction with the CCPO.

Competent Person: As defined by OSHA, an individual who is capable of identifying existing and predictable hazards in the surroundings or working conditions that are unsanitary, hazardous, or dangerous to employees or the general public, and who has authorization to take prompt corrective measures to eliminate them.

Construction Safety Auditor: A representative of the QACS Construction Safety Unit who provides inspection and assessment services to enhance health and safety on all DDC construction projects. The activities of the Construction Safety Auditor include performing site surveys, reviewing health and safety plans, reviewing construction permits, and rendering technical advice and assistance to DDC Resident Engineers and Project Managers.

City of New York Department of Design and Construction: Safety Requirements
Technical Support Division – Bureau of Quality Assurance and Construction Safety

Construction Safety Unit: A part of QACS within the Division of Technical Support that assesses contractor safety on DDC jobsites and advises responsible parties of needed corrective actions.

Construction Superintendent: A representative of the contractor responsible for overseeing performance of the required construction work. This individual must engage in sound construction practices, and is responsible to maintain a safe work site. In the case of a project involving the demolition, alteration or new construction of buildings, the Construction Superintendent must be licensed by the NYC Department of Buildings.

Contractor: For purposes of these Safety Requirements, the term "Contractor" shall mean any person or entity that enters into a contract for the performance of construction work on a DDC project. The term "Contractor" shall include any person or entity which enters into any of the following types of contracts: (1) a prime construction contract for a specific project, (2) a prime construction contract using the Job Order Contracting System ("JOCS Contract"), and (3) a subcontract with a CM/Builder ("First Tier Subcontract").

Director - Quality Assurance and Construction Safety (QACS): Responsible for the operations of the QACS Construction Safety Unit and the DDC Site Safety management programs.

Job Hazard Assessment (JHA): A process of identifying site-specific hazards that may be present during construction and establishing the means and methods to reduce or eliminate those hazards.

Jobsite Safety Coordinator: A person designated by the Contractor to be onsite during all activities. This individual shall have received, at a minimum, the OSHA 10-hour construction safety program. Other examples of acceptable training are the 30-hour OSHA Safety and Health Standards for the Construction Industry training program (OSHA 510) or a degree/certificate in a safety and health from a college-level curriculum. This person does not necessarily have to be dedicated full-time to site safety, but must have sufficient experience and authority to undertake corrective action and must qualify to be a competent person. For certain projects, as defined in NYC Construction Codes – Title 28, this person may be required to have a Site Safety Manager's License issued by the NYC DOB.

Qualified Person: As defined by OSHA, an individual who, by possession of a recognized degree, certificate, license or professional standing, or who by extensive knowledge, training, and experience, has successfully demonstrated his or her ability to solve problems relating to the subject matter, the work, or the project. Qualified Persons are required under regulation to address issues pertaining, but without limit, to fall protection, scaffold design and trenching and shoring, among others.

Resident Engineer (RE) / Construction Project Manager (CPM): Representative of the Commissioner duly designated by the Commissioner to be his/her representative at the site of the work. (The RE/CPM may be a third-party consultant, including a CM, retained by DDC.)

Safety Program: Established by the Contractor that covers all operations of that Contractor and establishes the Contractor's overall safety policy, regulatory compliance plan and minimum safety standards. The Safety Program must be submitted prior to the commencement of work at the site and is subject to review and acceptance by the Construction Safety Unit.

Safety Questionnaire: Used by DDC to evaluate Contractor's current and past safety performance. It is required to be completed by all Contractors initially when submitting bids for Construction work, or when being pre-qualified and updated annually or as requested by the DDC.

Site Safety Plan: A site-specific safety plan developed by the Contractor for a specific project. The Site Safety Plan must identify hazards associated with the project, and include specific safety precautions and training appropriate and necessary to complete the work. The Site Safety Plan must be submitted prior to the commencement of work at the site and is subject to review and acceptance by the Construction Safety Unit.

City of New York Department of Design and Construction: Safety Requirements
Technical Support Division – Bureau of Quality Assurance and Construction Safety

Unsafe or Unhealthy Condition: A condition that could be potentially hazardous to the health and safety of personnel or the public, and/or damaging to equipment, machinery, property or the environment.

Weekly Safety Meetings: Weekly documented jobsite safety meetings, given to all jobsite personnel by contractor, with the purpose of discussing general safety topics and job specific requirements encountered at the DDC work site.

IV. RESPONSIBILITIES

All persons who manage, perform, and provide support for construction projects shall conduct operations in compliance with the requirements identified in this Policy and all applicable governing regulatory agency requirements and guidelines pertaining to safety in construction.

A. Resident Engineer / Construction Project Manager / Construction Manager

- Monitors the issuance of safety-related permits, approvals and drawings and maintains copies on site.
- Monitors construction-related work activities to confirm that they are conducted in accordance with DDC policies and all applicable regulations that pertain to construction safety.
- Maintains documentation and periodically attends weekly safety meeting.
- Notifies the Construction Safety Unit and the ACCO's Insurance and Risk Management Unit of project-related accidents and emergencies, as per DDC's Construction Safety Emergency Protocol.
- Gathers facts related to all accidents and prepares DDC Accident Reports.
- Notifies the Construction Safety Unit of outside regulatory agency inspections and forwards a copy of the inspection report within three days of its receipt.
- Monitors the conditions at the site for conformance with the Site Safety Plan and DDC construction documents.
- Notifies the contractor and DDC in the event that any condition or activity exists that is not in compliance with the Site Safety Plan, applicable federal, state or local codes or any condition that presents a potential risk of injury to the public or workers or possible damage to property.
- Notifies DDC of any emergency condition and directs the contractor to provide such labor, materials, equipment and supervision to abate such conditions.
- Reports gross safety violations to the Construction Safety Unit immediately.

B. Contractors

- Complete a Safety Questionnaire and submit with its bid or as part of a pre-qualification package.
- Provide a Written Job Hazard Assessment (JHA) that identifies expected safety issues of the work to be performed. JHA shall be included with the Site Safety Plan submitted by the contractor.
- Submit a Site Safety Plan and Safety Program within 15 days of issuance of the Notice to Proceed, or as otherwise directed. The Site Safety Plan and Safety Program are subject to review and acceptance by the Construction Safety Unit prior to the commencement of work at the site. The Site Safety Plan shall be revised and updated as necessary.
- Ensure that all employees are aware of the hazards associated with the project through formal and informal training and/or other communications. Conduct and document weekly safety meetings for the duration of the project. Documentation to be provided to the RE/CPM/CM on a monthly basis.
- Name a Construction Superintendent, if required.
- Name a Job Site Safety Coordinator. The Contractor will be required to identify the Job Site Safety Coordinator in the Site Safety Plan.
- Comply with all mandated federal, state and local safety and health rules and regulations.
- Comply with all provisions of the Site Safety Plan.
- As part of the Site Safety Plan, prepare a site specific MPT (if not otherwise provided in the contract documents) and comply with all of its provisions.

City of New York Department of Design and Construction: Safety Requirements
Technical Support Division – Bureau of Quality Assurance and Construction Safety

- Conduct and document site-specific safety orientation for Contractor personnel to review the hazards associated with the project as identified in the Site Safety Plan and the specific safety procedures and controls that will be used to protect workers, the general public and property. The Job Site Safety Coordinator will conduct this training prior to mobilization and provide documentation to the RE/CPM/CM.
- Provide, replace and adequately maintain at or around the project site, suitable and sufficient signage, lights, barricades and enclosures (fences, sidewalk sheds, netting, bracing, etc.).
- Report unsafe conditions or hazards to the DDC RE/CPM/CM as soon as practical, but no more than 24 hours after discovery, and take action to remove or abate such conditions.
- Report any accident involving injuries to workers or the general public, as well as property damage, to the DDC RE/CPM/CM within two (2) hours.
- Notify the DDC RE/CPM/CM within two (2) hours of the start of an inspection by any regulatory agency personnel, including OSHA.
- Maintain all records pertaining to all required compliance documents and accident and injury reports.
- Respond to DDC recommendations on safety, which shall in no way relieve the Contractor of its responsibilities for safety on the project. The Contractor has sole responsibility for safety.

V. SAFETY QUESTIONNAIRE

DDC requires that all Contractors provide information regarding their current and past safety and environmental performance and programs. This will be accomplished by the use of the DDC Safety Questionnaire. As a part of the bid submittal package, the contractor must submit a completed DDC Safety Questionnaire listing their workers' compensation experience modification rating and OSHA Incidence Rates for the three (3) years prior to the date of the bid opening. DDC may request a Contractor to update its Questionnaire at any time or to provide more detailed information. The Contractor must provide the requested update within 30 days.

The following criteria will be used by DDC in reviewing the Contractor's responsibility, which will be based on the information provided on the questionnaire:

- Criteria 1: OSHA Injury and Illness Rates (I&IR) are no greater than the average for the industry (based on the most current Bureau of Labor Statistics data for the Contractors SIC code); and
- Criteria 2: Insurance workers compensation Experience Modification Rate (EMR) equal to or less than 1.0; and
- Criteria 3: Any willful violations issued by OSHA or NYC DOB within the last three years; and
- Criteria 4: A fatality (worker or member of public) experienced on or near Contractor's worksite within the last three (3) years; and
- Criteria 5: An unacceptable rating by QACS based on past performance on DDC projects; and
- Criteria 6: Contractor has in place an acceptable corporate safety program and its employees shall have completed all documented relative safety training; and
- Criteria 7: Contractor shall provide OSHA Injury Records (currently OSHA 300 Log) for the last three (3) years.

If the Contractor fails to meet the basic criteria listed above, the Construction Safety Unit may request, through the ACCO, more detail concerning the Contractor's safety experience. DDC may request the Contractor to provide copies of, among other things, OSHA records, OSHA and DOB citations, EPA citations and written Safety Programs.

VI. SAFETY PROGRAM AND SITE SAFETY PLAN

Within fifteen (15) days of issuance of the Notice to Proceed, or as otherwise directed, the Contractor shall submit the following: (1) Safety Program, and (2) Site Safety Plan. The Safety Program shall set forth the Contractor's overall safety policy, regulatory compliance plan and minimum safety standard, and the Site Safety Plan shall identify hazards associated with the project, and include specific safety precautions and training appropriate and necessary to complete the work. The Safety Program and the Site Safety Plan are subject to review and acceptance by the Construction Safety Unit prior to the commencement of work at the site. Failure by the contractor to submit an acceptable Site Safety Plan and Safety Program shall be grounds for default.

The Site Safety Plan shall apply to all Contractor and subcontractor operations, and shall have at a minimum, the following elements. Each element shall be described in a separate section in the written document. It may be necessary to modify the basic format for certain unique or high-risk projects (such as tunnels or high-rise construction). The basic elements are as follows:

1. **Responsibility and Organization:** Identify the person or persons with authority and responsibility for implementing the Site Safety Plan. Provide an organization chart and define levels of authority and responsibility. Identify the Competent Person, the Construction Superintendent (if required), the Job Safety Coordinator and the Qualified Person required for this project.
2. **Communication:** Establish a system for communicating with employees and subcontractors on matters relating to worker and public safety and health and environmental protection, including provisions designed to encourage employees to inform the employer of hazards at the worksite without fear of reprisal. An emergency response notification protocol is to be established that also includes after hours contact numbers. The plan must also include provisions for weekly safety meetings held by the Job Site Safety Coordinator.
3. **Job Hazard Assessment:** A written document submitted by the contractor, used to identify expected job hazards and public safety risks and state the specific means and methods to reduce, control or eliminate those hazards. This part of the Site Safety Plan must also include how on-going evaluations of those risks and hazards will be carried out, including plans for periodic inspections to identify unsafe conditions, work practices and public safety hazards.
4. **Accident/Exposure Investigation:** Establish a procedure to investigate and report occupational and public injury or illness, property damage, vehicle accidents or other mishaps.
5. **Hazard Correction:** Establish means, methods and/or procedures for correcting unsafe or unhealthy conditions that might be exposing both the public and workers to hazards. Corrective actions must be taken immediately when observed or discovered. Should an imminent hazard exist which cannot be immediately abated without endangering employees, the public and/or property, remove or restrict all exposed persons from the area except those necessary to correct the existing condition. Employees necessary to correct the hazardous condition shall be provided the necessary safeguards. When corrective actions cannot be taken immediately, temporary measures should be taken until such time permanent measures are taken to eliminate the potential risks or hazards.
6. **Training:** Describe site-specific hazard training programs. In addition to the required safety orientation, additional site specific training, in the form of required weekly safety meetings, will be required. Contractors must also initiate training when: a) new employees are hired; b) employees are given new job assignments for which training has not been previously received; c) new substances, processes, procedures or equipment are introduced that might represent a new public or worker hazard; d) the employee is made aware of a new or previously unrecognized hazard; e) new supervisors are assigned to familiarize themselves with the safety and health hazards to which employees under their immediate direction and control may be exposed; and f) after a jobsite incident or accident has occurred.

City of New York Department of Design and Construction: Safety Requirements
Technical Support Division – Bureau of Quality Assurance and Construction Safety

7. Recordkeeping: Establish procedures to maintain records of scheduled and periodic inspections, weekly safety meetings, and training records. Updated records shall be maintained at the jobsite, accessible to the Construction Safety Auditors and/or Quality Assurance Auditors/RE/CPM, and retained in accordance with DDC policy.

The most critical component of the Site Safety Plan is the Job Hazard Assessment section. This section must address specific hazards that are anticipated throughout the project. Each Site Safety Plan must address, at a minimum:

- Public and pedestrian safety
- Fall protection
- Electrical hazards
- Scaffolding
- Fire protection
- Emergency notification & response
- Housekeeping / debris removal
- Dust control
- Maintenance and protection of traffic
- Trenching and excavating
- Heavy equipment operations
- Material / equipment storage
- Environmental contamination
- Sheeting and shoring
- Alcohol and Drug Abuse Policy

The following additional hazards must be addressed, if applicable, based on the contract safety specifications and/or the results of the JHA (the list is not all-inclusive):

- Basic Personal Protective Equipment
- Compressed Air
- Compressed Gas Cylinders
- Cranes, Derricks and Hoists
- Demolition
- Electrical safety
- Excavations and Trenching
- Fall Protection – Floor openings/Stairways
- Fall Protection – Guardrails Toe boards etc
- Fall Protection – Leading Edge
- Fall Protection – Personal Fall Protection Devices
- Fire Protection and Fire Prevention
- Hazard Communication (RIGHT TO KNOW)
- Hazardous Energy & Lock Out / Tag Out
- Housekeeping/ Sanitation
- Maintenance and Protection of Traffic (MPT)
- Man Lifts /Aerial Lifts
- Marine Operations
- Motor Vehicle Safety
- Overhead Power lines
- Permit Required Confined Space
- Portable Ladders
- Powered Actuated Tools
- Powered Material Handling Equipment
- Scaffolds – Mobile
- Scaffolds – Stationary
- Scaffolds – Suspended
- Slings
- Steel Erection

City of New York Department of Design and Construction: Safety Requirements
Technical Support Division – Bureau of Quality Assurance and Construction Safety

- Welding and Cutting (Hot Work)
- Airborne Contaminants – Particulates – General
- Asbestos
- Blood borne Pathogens
- Hearing Protection
- Lead in Construction
- Mercury in Construction
- PCB's
- Respiratory Protection
- Silica
- Thermal Stress
- West Nile Virus
- Rodents and Vermin
- Noise Mitigation Plan

Certain DDC programs, such as Job Order Contracting System (JOCS), may not necessarily require Site Safety Plans. The JOCS contractor will be required to submit a Safety Program. In addition, certain DDC Operating Units may establish program or client-specific safety requirements. The contractor's Site Safety Plan must address such program or client specific safety requirements.

VII. KICK-OFF MEETINGS/PRE-CONSTRUCTION AND SAFETY REVIEW

As part of the construction kick-off meeting, a Site Safety Plan review will be part of the agenda. A QACS representative will participate in this meeting with the contractor prior to the start of the project for the purpose of:

- A. Reviewing the safety issues detailed in the contract.
- B. Reviewing the Site Safety Plan.
- C. Reviewing any new issues or information that was not previously addressed.
- D. Discussing planned inspections and audits of the site by DDC personnel.

VIII. EVALUATION DURING WORK IN PROGRESS

The Contractor's adherence to these Safety Requirements will be monitored throughout the project. This will be accomplished by the following:

- A. Use of a safety checklist by a representative of the Construction Safety Unit or other designated DDC representative or Consultant during regular, unannounced inspections of the job site. Field Exit Conferences will be held with the RE/CPM, Contractor Superintendents or Safety Representatives.
- B. The RE/CPM will continually monitor the safety and environmental performance of the contractor's employees and work methods. Deficiencies shall be brought to the attention of the contractor's representative on site for immediate correction. The DDC representative will maintain a written record of these deficiencies and forward them to the Construction Safety Unit on a weekly basis. Any critical deficiencies shall be immediately reported to QACS phone# (718) 391-1624 or (718) 391-1911.
- C. If the Contractor's safety performance during the project is not up to DDC standards (safety performance measure, accident/incident rate, etc.) the Director- QACS, or designee will meet with the Contractor's safety representative, the DDC project manager, the RE/CPM, or the DDC Environmental Specialist (if environmental issues are involved). The purpose of this meeting is to 1) determine the level of non-compliance; 2) explain and clarify the safety/environmental provisions; 3) agree on a future course of action to correct the deficiencies.

City of New York Department of Design and Construction: Safety Requirements
Technical Support Division – Bureau of Quality Assurance and Construction Safety

- D. If the deficiencies continue to occur with inadequate attention by the contractor, this shall, among other remedies available, be grounds for default.
- E. The contractor shall inform the Construction Safety Unit and ACCO Insurance and Risk Management Unit of all medical injuries or illnesses that require doctors' treatment resulting from an on-the-job incident within 24 hours of the occurrence. The Construction Safety Unit shall also be immediately informed of all fatalities, catastrophic accidents with more than one employee hospitalized, any injuries to members of the general public and major equipment damage (e.g., property damage, equipment rollovers, loads dropped from crane). QACS shall maintain a record of all contractor injuries and illnesses during the project and provide regular reports to the Agency.
- F. The Construction Safety Unit shall be immediately notified at the start of any NYS-DOL/ NYC-COSH/ OSHA/ EPA inspections. The Director of Quality Assurance & Construction Safety shall maintain a log of all contractor OSHA/EPA inspections and citations during the project.

IX. SAFETY PERFORMANCE EVALUATION

The contractor's safety record, including all DDC inspection results, will be considered as part of the Contractor's performance evaluation at the conclusion of the project. Poor safety performance during the course of the project shall be a reason to rate a Contractor unsatisfactory which will be reflected in the City's Vendex system and will be considered for future procurement actions as set forth in the City's Procurement Policy Board Rules.

(NO TEXT ON THIS PAGE)

CITY OF NEW YORK
STANDARD CONSTRUCTION CONTRACT

DECEMBER 2013

(NO TEXT ON THIS PAGE)

**CITY OF NEW YORK
STANDARD CONSTRUCTION CONTRACT**

TABLE OF CONTENTS

**CHAPTER I
THE CONTRACT AND DEFINITIONS**

ARTICLE 1.	THE CONTRACT	1
ARTICLE 2.	DEFINITIONS	1

**CHAPTER II
THE WORK AND ITS PERFORMANCE**

ARTICLE 3.	CHARACTER OF THE WORK	4
ARTICLE 4.	MEANS AND METHODS OF CONSTRUCTION	4
ARTICLE 5.	COMPLIANCE WITH LAWS	5
ARTICLE 6.	INSPECTION	10
ARTICLE 7.	PROTECTION OF WORK AND OF PERSONS AND PROPERTY; NOTICES AND INDEMNIFICATION	11

**CHAPTER III
TIME PROVISIONS**

ARTICLE 8.	COMMENCEMENT AND PROSECUTION OF THE WORK	12
ARTICLE 9.	PROGRESS SCHEDULES	12
ARTICLE 10.	REQUESTS FOR INFORMATION OR APPROVAL	13
ARTICLE 11.	NOTICE OF CONDITIONS CAUSING DELAY AND DOCUMENTATION OF DAMAGES CAUSED BY DELAY	13
ARTICLE 12.	COORDINATION WITH OTHER CONTRACTORS	17
ARTICLE 13.	EXTENSION OF TIME FOR PERFORMANCE	18
ARTICLE 14.	COMPLETION AND FINAL ACCEPTANCE OF THE WORK	21
ARTICLE 15.	LIQUIDATED DAMAGES	22
ARTICLE 16.	OCCUPATION OR USE PRIOR TO COMPLETION	22

**CHAPTER IV
SUBCONTRACTS AND ASSIGNMENTS**

ARTICLE 17.	SUBCONTRACTS	23
ARTICLE 18.	ASSIGNMENTS	25

**CITY OF NEW YORK
STANDARD CONSTRUCTION CONTRACT**

TABLE OF CONTENTS

**CHAPTER V
CONTRACTOR'S SECURITY AND GUARANTY**

ARTICLE 19.	SECURITY DEPOSIT	26
ARTICLE 20.	PAYMENT GUARANTEE	26
ARTICLE 21.	RETAINED PERCENTAGE	29
ARTICLE 22.	INSURANCE	29
ARTICLE 23.	MONEY RETAINED AGAINST CLAIMS	35
ARTICLE 24.	MAINTENANCE AND GUARANTY	36

**CHAPTER VI
CHANGES, EXTRA WORK AND DOCUMENTATION OF CLAIM**

ARTICLE 25.	CHANGES	37
ARTICLE 26.	METHODS OF PAYMENT FOR OVERRUNS AND EXTRA WORK	37
ARTICLE 27.	RESOLUTION OF DISPUTES	40
ARTICLE 28.	RECORD KEEPING FOR EXTRA OR DISPUTED WORK OR WORK ON A TIME & MATERIALS BASIS	44
ARTICLE 29.	OMITTED WORK	45
ARTICLE 30.	NOTICE AND DOCUMENTATION OF COSTS AND DAMAGES; PRODUCTION OF FINANCIAL RECORDS	45

**CHAPTER VII
POWERS OF THE RESIDENT ENGINEER, THE ENGINEER
OR ARCHITECT AND THE COMMISSIONER**

ARTICLE 31.	THE RESIDENT ENGINEER	46
ARTICLE 32.	THE ENGINEER OR ARCHITECT OR PROJECT MANAGER	47
ARTICLE 33.	THE COMMISSIONER	47
ARTICLE 34.	NO ESTOPPEL	48

**CHAPTER VIII
LABOR PROVISIONS**

ARTICLE 35.	EMPLOYEES	48
ARTICLE 36.	NO DISCRIMINATION	50
ARTICLE 37.	LABOR LAW REQUIREMENTS	52
ARTICLE 38.	PAYROLL REPORTS	57
ARTICLE 39.	DUST HAZARDS	58

**CITY OF NEW YORK
STANDARD CONSTRUCTION CONTRACT**

TABLE OF CONTENTS

**CHAPTER IX
PARTIAL AND FINAL PAYMENTS**

ARTICLE 40.	CONTRACT PRICE	58
ARTICLE 41.	BID BREAKDOWN ON LUMP SUM	58
ARTICLE 42.	PARTIAL PAYMENTS	58
ARTICLE 43.	PROMPT PAYMENT	59
ARTICLE 44.	SUBSTANTIAL COMPLETION PAYMENT	59
ARTICLE 45.	FINAL PAYMENT	60
ARTICLE 46.	ACCEPTANCE OF FINAL PAYMENT	61
ARTICLE 47.	APPROVAL BY PUBLIC DESIGN COMMISSION	62

**CHAPTER X
CONTRACTOR'S DEFAULT**

ARTICLE 48.	COMMISSIONER'S RIGHT TO DECLARE CONTRACTOR IN DEFAULT	62
ARTICLE 49.	EXERCISE OF THE RIGHT TO DECLARE DEFAULT	64
ARTICLE 50.	QUITTING THE SITE	64
ARTICLE 51.	COMPLETION OF THE WORK	64
ARTICLE 52.	PARTIAL DEFAULT	64
ARTICLE 53.	PERFORMANCE OF UNCOMPLETED WORK	65
ARTICLE 54.	OTHER REMEDIES	65

**CHAPTER XI
MISCELLANEOUS PROVISIONS**

ARTICLE 55.	CONTRACTOR'S WARRANTIES	66
ARTICLE 56.	CLAIMS AND ACTIONS THEREON	66
ARTICLE 57.	INFRINGEMENT	66
ARTICLE 58.	NO CLAIM AGAINST OFFICERS, AGENTS OR EMPLOYEES	67
ARTICLE 59.	SERVICE OF NOTICES	67
ARTICLE 60.	UNLAWFUL PROVISIONS DEEMED STRICKEN FROM CONTRACT	67
ARTICLE 61.	ALL LEGAL PROVISIONS DEEMED INCLUDED	67
ARTICLE 62.	TAX EXEMPTION	67
ARTICLE 63.	INVESTIGATION(S) CLAUSE	69
ARTICLE 64.	TERMINATION BY THE CITY	71
ARTICLE 65.	CHOICE OF LAW, CONSENT TO JURISDICTION AND VENUE	73

**CITY OF NEW YORK
STANDARD CONSTRUCTION CONTRACT**

TABLE OF CONTENTS

CHAPTER XI (CONT'D)

MISCELLANEOUS PROVISIONS

ARTICLE 66.	PARTICIPATION IN AN INTERNATIONAL BOYCOTT	74
ARTICLE 67.	LOCALLY BASED ENTERPRISE PROGRAM	74
ARTICLE 68.	ANTITRUST	75
ARTICLE 69.	MACBRIDE PRINCIPLES PROVISIONS	75
ARTICLE 70	ELECTRONIC FILING/NYC DEVELOPMENT HUB	77
ARTICLE 71.	PROHIBITION OF TROPICAL HARDWOODS	77
ARTICLE 72.	CONFLICTS OF INTEREST	78
ARTICLE 73.	MERGER CLAUSE	78
ARTICLE 74.	STATEMENT OF WORK	78
ARTICLE 75.	COMPENSATION TO BE PAID TO CONTRACTOR	78
ARTICLE 76:	ELECTRONIC FUNDS TRANSFER	78
ARTICLE 77:	RECORDS RETENTION	79
ARTICLE 78:	PARTICIPATION BY MINORITY-OWNED AND WOMEN-OWNED BUSINESS ENTERPRISES IN CITY PROCUREMENT	79
SIGNATURES		87
ACKNOWLEDGMENT BY CORPORATION		88
ACKNOWLEDGMENT BY PARTNERSHIP		88
ACKNOWLEDGMENT BY INDIVIDUAL		88
ACKNOWLEDGMENT BY COMMISSIONER		89
AUTHORITY		90
COMPTROLLER'S CERTIFICATE		90
MAYOR'S CERTIFICATE		91
PERFORMANCE BOND #1		92
PERFORMANCE BOND #2		96
PAYMENT BOND		100

WITNESSETH:

The parties, in consideration of the mutual agreements contained herein, agree as follows:

**CHAPTER I
THE CONTRACT AND DEFINITIONS**

ARTICLE 1. THE CONTRACT

1.1 Except for titles, subtitles, headings, running headlines, tables of contents and indices (all of which are printed herein merely for convenience), the following, except for such portions thereof as may be specifically excluded, shall be deemed to be part of this Contract:

1.1.1 All provisions required by law to be inserted in this Contract, whether actually inserted or not;

1.1.2 The Contract Drawings and Specifications;

1.1.3 The General Conditions and Special Conditions, if any;

1.1.4 The Contract;

1.1.5 The Information for Bidders; Request for Proposals; Notice of Solicitation and Proposal For Bids; Bid or Proposal, and, if used, the Bid Booklet;

1.1.6 All Addenda issued prior to the receipt of the bids; the Notice of Award; Performance and Payment Bonds, if required; and the Notice to Proceed or the Order to Work.

1.2 Should any conflict occur in or between the Drawings and Specifications, the Contractor shall be deemed to have estimated the most expensive way of doing the Work, unless the Contractor shall have asked for and obtained a decision in writing from the Commissioner of the Agency that is entering into this Contract, before the submission of its bid, as to what shall govern.

ARTICLE 2. DEFINITIONS

2.1 The following words and expressions, or pronouns used in their stead, shall, wherever they appear in this Contract, be construed as follows, unless a different meaning is clear from the context:

2.1.1 "**Addendum**" or "**Addenda**" shall mean the additional Contract provisions and/or technical clarifications issued in writing by the Commissioner prior to the receipt of bids.

2.1.2 "**Agency**" shall mean a city, county, borough or other office, position, department, division, bureau, board or commission, or a corporation, institution or agency of government, the expenses of which are paid in whole or in part from the City treasury.

2.1.3 "**Agency Chief Contracting Officer**" (**ACCO**) shall mean a person delegated authority by the Commissioner to organize and supervise the procurement activity of subordinate Agency staff in conjunction with the CCPO, or his/her duly authorized representative.

2.1.4 **"Allowance"** shall mean a sum of money which the Agency may include in the total amount of the Contract for such specific contingencies as the Agency believes may be necessary to complete the Work, *e.g.*, lead or asbestos remediation, and for which the Contractor will be paid on the basis of stipulated unit prices or a formula set forth in the Contract or negotiated between the parties provided, however, that if the Contractor is not directed to use the Allowance, the Contractor shall have no right to such money and it shall be deducted from the total amount of the Contract.

2.1.5 **"City"** shall mean the City of New York.

2.1.6 **"City Chief Procurement Officer" (CCPO)** shall mean a person delegated authority by the Mayor to coordinate and oversee the procurement activity of Mayoral agency staff, including the ACCO and any offices which have oversight responsibility for the procurement of construction, or his/her duly authorized representative.

2.1.7 **"Commissioner"** shall mean the head of the Agency that has entered into this Contract, or his/her duly authorized representative.

2.1.8 **"Comptroller"** shall mean the Comptroller of the City of New York.

2.1.9 **"Contract"** or **"Contract Documents"** shall mean each of the various parts of the contract referred to in Article 1 hereof, both as a whole and severally.

2.1.10 **"Contract Drawings"** shall mean only those drawings specifically entitled as such and listed in the Specifications or in any Addendum, or any drawings furnished by the Commissioner, pertaining or supplemental thereto.

2.1.11 **"Contract Work"** shall mean everything required to be furnished and done by the Contractor by any one or more of the parts of the Contract referred to in Article 1, except Extra Work as hereinafter defined.

2.1.12 **"Contractor"** shall mean the entity which executed this Contract, whether a corporation, firm, partnership, joint venture, individual, or any combination thereof, and its, their, his/her successors, personal representatives, executors, administrators, and assigns, and any person, firm, partnership, joint venture, individual, or corporation which shall at any time be substituted in the place of the Contractor under this Contract.

2.1.13 **"Days"** shall mean calendar days, except where otherwise specified.

2.1.14 **"Engineer"** or **"Architect"** or **"Project Manager"** shall mean the person so designated in writing by the Commissioner in the Notice to Proceed or the Order to Work to act as such in relation to this Contract, including a private Architect or Engineer or Project Manager, as the case may be. Subject to written approval by the Commissioner, the Engineer, Architect or Project Manager may designate an authorized representative.

2.1.15 **"Engineering Audit Officer" (EAO)** shall mean the person so designated by the Commissioner to perform responsible auditing functions hereunder.

2.1.16 **"Extra Work"** shall mean Work other than that required by the Contract at the time of award which is authorized by the Commissioner pursuant to Chapter VI of this Contract.

2.1.17 **"Federal-Aid Contract"** shall mean a contract in which the United States (federal) Government provides financial funding as so designated in the Information for Bidders.

2.1.18 **"Final Acceptance"** shall mean final written acceptance of all the Work by the Commissioner, a copy of which shall be sent to the Contractor.

2.1.19 **"Final Approved Punch List"** shall mean a list, approved pursuant to Article 14.2.2, specifying those items of Work to be completed by the Contractor after Substantial Completion and dates for the completion of each item of Work.

2.1.20 **"Law"** or **"Laws"** shall mean the Constitution of the State of New York, the New York City Charter, the New York City Administrative Code, a statute of the United States or of the State of New York, a local law of the City of New York, any ordinance, rule or regulation having the force of law, or common law.

2.1.21 **"Materialman"** shall mean any corporation, firm, partnership, joint venture, or individual, other than employees of the Contractor, who or which contracts with the Contractor or any Subcontractor, to fabricate or deliver, or who actually fabricates or delivers, plant, materials or equipment to be incorporated in the Work.

2.1.22 **"Means and Methods of Construction"** shall mean the labor, materials, temporary structures, tools, plant, and construction equipment, and the manner and time of their use, necessary to accomplish the result intended by this Contract.

2.1.23 **"Notice to Proceed"** or **"Order to Work"** shall mean the written notice issued by the Commissioner specifying the time for commencement of the Work and the Engineer, Architect or Project Manager.

2.1.24 **"Other Contractor(s)"** shall mean any contractor (other than the entity which executed this Contract or its Subcontractors) who or which has a contract with the City for work on or adjacent to the building or Site of the Work.

2.1.25 **"Payroll Taxes"** shall mean State Unemployment Insurance (SUI), Federal Unemployment Insurance (FUI), and payments pursuant to the Federal Insurance Contributions Act (FICA).

2.1.26 **"Project"** shall mean the public improvement to which this Contract relates.

2.1.27 **"Procurement Policy Board" (PPB)** shall mean the Agency of the City of New York whose function is to establish comprehensive and consistent procurement policies and rules which shall have broad application throughout the City.

2.1.28 **"Required Quantity"** in a unit price Contract shall mean the actual quantity of any item of Work or materials which is required to be performed or furnished in order to comply with the Contract.

2.1.29 **"Resident Engineer"** shall mean the representative of the Commissioner duly designated by the Commissioner to be his/her representative at the site of the Work.

2.1.30 **"Site"** shall mean the area upon or in which the Contractor's operations are carried on, and such other areas adjacent thereto as may be designated as such by the Engineer.

2.1.31 **"Small Tools"** shall mean items that are ordinarily required for a worker's job function, including but not limited to, equipment that ordinarily has no licensing, insurance

or substantive storage costs associated with it; such as circular and chain saws, impact drills, threaders, benders, wrenches, socket tools, etc.

2.1.32 "**Specifications**" shall mean all of the directions, requirements, and standards of performance applying to the Work as hereinafter detailed and designated under the Specifications.

2.1.33 "**Subcontractor**" shall mean any person, firm or corporation, other than employees of the Contractor, who or which contracts with the Contractor or with its subcontractors to furnish, or actually furnishes labor, or labor and materials, or labor and equipment, or superintendence, supervision and/or management at the Site. Wherever the word Subcontractor appears, it shall also mean sub-Subcontractor.

2.1.34 "**Substantial Completion**" shall mean the written determination by the Engineer that the Work required under this Contract is substantially, but not entirely, complete and the approval of the **Final Approved Punch List**.

2.1.35 "**Work**" shall mean all services required to complete the Project in accordance with the Contract Documents, including without limitation, labor, material, superintendence, management, administration, equipment, and incidentals, and obtaining any and all permits, certifications and licenses as may be necessary and required to complete the Work, and shall include both Contract Work and Extra Work.

CHAPTER II THE WORK AND ITS PERFORMANCE

ARTICLE 3. CHARACTER OF THE WORK

3.1 Unless otherwise expressly provided in the **Contract Drawings, Specifications, and Addenda**, the **Work** shall be performed in accordance with the best modern practice, utilizing, unless otherwise specified in writing, new and unused materials of standard first grade quality and workmanship and design of the highest quality, to the satisfaction of the **Commissioner**.

ARTICLE 4. MEANS AND METHODS OF CONSTRUCTION

4.1 Unless otherwise expressly provided in the **Contract Drawings, Specifications, and Addenda**, the **Means and Methods of Construction** shall be such as the **Contractor** may choose; subject, however, to the **Engineer's** right to reject the **Means and Methods of Construction** proposed by the **Contractor** which in the opinion of the **Engineer**:

4.1.1 Will constitute or create a hazard to the **Work**, or to persons or property; or

4.1.2 Will not produce finished **Work** in accordance with the terms of the **Contract**; or

4.1.3 Will be detrimental to the overall progress of the **Project**.

4.2 The **Engineer's** approval of the **Contractor's Means and Methods of Construction**, or his/her failure to exercise his/her right to reject such means or methods, shall not relieve the **Contractor** of its obligation to complete the **Work** as provided in this **Contract**; nor shall the exercise of such right to reject create a cause of action for damages.

ARTICLE 5. COMPLIANCE WITH LAWS

5.1 The **Contractor** shall comply with all **Laws** applicable to this **Contract** and to the **Work** to be done hereunder.

5.2 Procurement Policy Board Rules: This **Contract** is subject to the Rules of the **PPB** ("**PPB Rules**") in effect at the time of the bid opening for this **Contract**. In the event of a conflict between the **PPB Rules** and a provision of this **Contract**, the **PPB Rules** shall take precedence.

5.3 Noise Control Code provisions.

5.3.1 In accordance with the provisions of Section 24-216(b) of the Administrative Code of the **City** ("**Administrative Code**"), Noise Abatement Contract Compliance, devices and activities which will be operated, conducted, constructed or manufactured pursuant to this **Contract** and which are subject to the provisions of the **City Noise Control Code** shall be operated, conducted, constructed, or manufactured without causing a violation of the **Administrative Code**. Such devices and activities shall incorporate advances in the art of noise control development for the kind and level of noise emitted or produced by such devices and activities, in accordance with regulations issued by the **Commissioner** of the **City Department of Environmental Protection**.

5.3.2 The **Contractor** agrees to comply with Section 24-219 of the Administrative Code and implementing rules codified at 15 Rules of the City of New York ("**RCNY**") Section 28-100 *et seq.* In accordance with such provisions, the **Contractor**, if the **Contractor** is the responsible party under such regulations, shall prepare and post a Construction Noise Mitigation Plan at each **Site**, in which the **Contractor** shall certify that all construction tools and equipment have been maintained so that they operate at normal manufacturers operating specifications. If the **Contractor** cannot make this certification, it must have in place an Alternative Noise Mitigation Plan approved by the **City Department of Environmental Protection**. In addition, the **Contractor's** certified Construction Noise Mitigation Plan is subject inspection by the **City Department of Environmental Protection** in accordance with Section 28-101 of Title 15 of **RCNY**. No **Contract Work** may take place at a **Site** unless there is a Construction Noise Mitigation Plan or approved Alternative Noise Mitigation Plan in place. In addition, the **Contractor** shall create and implement a noise mitigation training program. Failure to comply with these requirements may result in fines and other penalties pursuant to the applicable provisions of the **Administrative Code** and **RCNY**.

5.4 Ultra Low Sulfur Diesel Fuel: In accordance with the provisions of Section 24-163.3 of the **Administrative Code**, the **Contractor** specifically agrees as follows:

5.4.1 Definitions. For purposes of this Article 5.4, the following definitions apply:

5.4.1(a) "**Contractor**" means any person or entity that enters into a Public Works Contract with a **City Agency**, or any person or entity that enters into an agreement with such person or entity, to perform work or provide labor or services related to such Public Works Contract.

5.4.1(b) "**Motor Vehicle**" means any self-propelled vehicle designed for transporting persons or property on a street or highway.

5.4.1(c) "**Nonroad Engine**" means an internal combustion engine (including the fuel system) that is not used in a Motor Vehicle or a vehicle used solely for competition, or that is not subject to standards promulgated under Section 7411 or Section 7521 of

Title 42 of the United States Code, except that this term shall apply to internal combustion engines used to power generators, compressors or similar equipment used in any construction program or project.

5.4.1(d) "Nonroad Vehicle" means a vehicle that is powered by a Nonroad Engine, fifty (50) horsepower and greater, and that is not a Motor Vehicle or a vehicle used solely for competition, which shall include, but not be limited to, excavators, backhoes, cranes, compressors, generators, bulldozers, and similar equipment, except that this term shall not apply to horticultural maintenance vehicles used for landscaping purposes that are powered by a Nonroad Engine of sixty-five (65) horsepower or less and that are not used in any construction program or project.

5.4.1(e) "Public Works Contract" means a contract with a **City Agency** for a construction program or project involving the construction, demolition, restoration, rehabilitation, repair, renovation, or abatement of any building, structure, tunnel, excavation, roadway, park or bridge; a contract with a **City Agency** for the preparation for any construction program or project involving the construction, demolition, restoration, rehabilitation, repair, renovation, or abatement of any building, structure, tunnel, excavation, roadway, park or bridge; or a contract with a **City Agency** for any final work involved in the completion of any construction program or project involving the construction, demolition, restoration, rehabilitation, repair, renovation, or abatement of any building, structure, tunnel, excavation, roadway, park or bridge.

5.4.1(f) "Ultra Low Sulfur Diesel Fuel" means diesel fuel that has a sulfur content of no more than fifteen parts per million (15 ppm).

5.4.2 Ultra Low Sulfur Diesel Fuel

5.4.2(a) All **Contractors** shall use Ultra Low Sulfur Diesel Fuel in diesel-powered Nonroad Vehicles in the performance of this **Contract**.

5.4.2(b) Notwithstanding the requirements of Article 5.4.2(a), **Contractors** may use diesel fuel that has a sulfur content of no more than thirty parts per million (30 ppm) to fulfill the requirements of this Article 5.4.2, where the Commissioner of the City Department of Environmental Protection ("DEP Commissioner") has issued a determination that a sufficient quantity of Ultra Low Sulfur Diesel Fuel is not available to meet the needs of **Agencies** and **Contractors**. Any such determination shall expire after six (6) months unless renewed.

5.4.2(c) **Contractors** shall not be required to comply with this Article 5.4.2 where the **City Agency** letting this **Contract** makes a written finding, which is approved, in writing, by the DEP Commissioner, that a sufficient quantity of Ultra Low Sulfur Diesel Fuel, or diesel fuel that has a sulfur content of no more than thirty parts per million (30 ppm) is not available to meet the requirements of Section 24-163.3 of the Administrative Code, provided that such **Contractor** in its fulfillment of the requirements of this **Contract**, to the extent practicable, shall use whatever quantity of Ultra Low Sulfur Diesel Fuel or diesel fuel that has a sulfur content of no more than thirty parts per million (30 ppm) is available. Any finding made pursuant to this Article 5.4.2(c) shall expire after sixty (60) **Days**, at which time the requirements of this Article 5.4.2 shall be in full force and effect unless the **City Agency** renews the finding in writing and such renewal is approved by the DEP Commissioner.

5.4.2(d) **Contractors** may check on determinations and approvals issued by the DEP Commissioner pursuant to Section 24-163.3 of the Administrative Code, if any, at www.dep.nyc.gov or by contacting the **City Agency** letting this **Contract**.

5.4.2(e) The requirements of this Article 5.4.2 do not apply where they are precluded by federal or State funding requirements or where the **Contract** is an emergency procurement.

5.4.3 Best Available Technology

5.4.3(a) All **Contractors** shall utilize the best available technology for reducing the emission of pollutants for diesel-powered Nonroad Vehicles in the performance of this **Contract**. For determinations of best available technology for each type of diesel-powered Nonroad Vehicle, **Contractors** shall comply with the regulations of the City Department of Environmental Protection, as and when adopted, Chapter 14 of Title 15 of the Rules of the City of New York (RCNY). The **Contractor** shall fully document all steps in the best available technology selection process and shall furnish such documentation to the **City Agency** or the DEP Commissioner upon request. The **Contractor** shall retain all documentation generated in the best available technology selection process for as long as the selected best available technology is in use.

5.4.3(b) No **Contractor** shall be required to replace best available technology for reducing the emission of pollutants or other authorized technology utilized for a diesel-powered Nonroad Vehicle in accordance with the provisions of this Article 5.4.3 within three (3) years of having first utilized such technology for such vehicle.

5.4.3(c) This Article 5.4.3 shall not apply to any vehicle used to satisfy the requirements of a specific Public Works Contract for fewer than twenty (20) **Days**.

5.4.3(d) The **Contractor** shall not be required to comply with this Article 5.4.3 with respect to a diesel-powered Nonroad Vehicle under the following circumstances:

5.4.3(d)(i) Where the **City Agency** makes a written finding, which is approved, in writing, by the DEP Commissioner, that the best available technology for reducing the emission of pollutants as required by this Article 5.4.3 is unavailable for such vehicle, the **Contractor** shall use whatever technology for reducing the emission of pollutants, if any, is available and appropriate for such vehicle.

5.4.3(d)(ii) Where the DEP Commissioner has issued a written waiver based upon the **Contractor** having demonstrated to the DEP Commissioner that the use of the best available technology for reducing the emission of pollutants might endanger the operator of such vehicle or those working near such vehicle, due to engine malfunction, the **Contractor** shall use whatever technology for reducing the emission of pollutants, if any, is available and appropriate for such vehicle, which would not endanger the operator of such vehicle or those working near such vehicle.

5.4.3(d)(iii) In determining which technology to use for the purposes of Articles 5.4.3(d)(i) and 5.4.3(d)(ii) above, the **Contractor** shall primarily consider the reduction in emissions of particulate matter and secondarily consider the reduction in emissions of nitrogen oxides associated with the use of such

technology, which shall in no event result in an increase in the emissions of either such pollutant.

5.4.3(d)(iv) The **Contractor** shall submit requests for a finding or a waiver pursuant to this Article 5.4.3(d) in writing to the DEP Commissioner, with a copy to the **ACCO** of the **City Agency** letting this **Contract**. Any finding or waiver made or issued pursuant to Articles 5.4.3(d)(i) and 5.4.3(d)(ii) above shall expire after one hundred eighty (180) **Days**, at which time the requirements of Article 5.4.3(a) shall be in full force and effect unless the **City Agency** renews the finding, in writing, and the DEP Commissioner approves such finding, in writing, or the DEP Commissioner renews the waiver, in writing.

5.4.3(e) The requirements of this Article 5.4.3 do not apply where they are precluded by federal or State funding requirements or where the **Contract** is an emergency procurement.

5.4.4 Section 24-163 of the Administrative Code. The **Contractor** shall comply with Section 24-163 of the Administrative Code related to the idling of the engines of motor vehicles while parking.

5.4.5 Compliance

5.4.5(a) The **Contractor's** compliance with Article 5.4 may be independently monitored. If it is determined that the **Contractor** has failed to comply with any provision of Article 5.4, any costs associated with any independent monitoring incurred by the **City** shall be reimbursed by the **Contractor**.

5.4.5(b) Any **Contractor** who violates any provision of Article 5.4, except as provided in Article 5.4.5(c) below, shall be liable for a civil penalty between the amounts of one thousand (\$1,000) and ten thousand (\$10,000) dollars, in addition to twice the amount of money saved by such **Contractor** for failure to comply with Article 5.4.

5.4.5(c) No **Contractor** shall make a false claim with respect to the provisions of Article 5.4 to a **City Agency**. Where a **Contractor** has been found to have done so, such **Contractor** shall be liable for a civil penalty of twenty thousand (\$20,000) dollars, in addition to twice the amount of money saved by such **Contractor** in association with having made such false claim.

5.4.6 Reporting

5.4.6(a) For all Public Works Contracts covered by this Article 5.4, the **Contractor** shall report to the **City Agency** the following information:

5.4.6(a)(i) The total number of diesel-powered Nonroad Vehicles used to fulfill the requirements of this Public Works Contract;

5.4.6(a)(ii) The number of such Nonroad Vehicles that were powered by Ultra Low Sulfur Diesel Fuel;

5.4.6(a)(iii) The number of such Nonroad Vehicles that utilized the best available technology for reducing the emission of pollutants, including a breakdown by vehicle model and the type of technology;

5.4.6(a)(iv) The number of such Nonroad Vehicles that utilized such other authorized technology in accordance with Article 5.4.3, including a breakdown by vehicle model and the type of technology used for each such vehicle;

5.4.6(a)(v) The locations where such Nonroad Vehicles were used; and

5.4.6(a)(vi) Where a determination is in effect pursuant to Article 5.4.2(b) or 5.4.2(c), detailed information concerning the **Contractor's** efforts to obtain Ultra Low Sulfur Diesel Fuel or diesel fuel that has a sulfur content of no more than thirty parts per million (30 ppm).

5.4.6(b) The **Contractor** shall submit the information required by Article 5.4.6(a) at the completion of **Work** under the Public Works Contract and on a yearly basis no later than August 1 throughout the term of the Public Works Contract. The yearly report shall cover **Work** performed during the preceding fiscal year (July 1 - June 30).

5.5 Ultra Low Sulfur Diesel Fuel. In accordance with the Coordinated Construction Act for Lower Manhattan, as amended:

5.5.1 Definitions. For purposes of this Article 5.5, the following definitions apply:

5.5.1(a) "Lower Manhattan" means the area to the south of and within the following lines: a line beginning at a point where the United States pierhead line in the Hudson River as it exists now or may be extended would intersect with the southerly line of West Houston Street in the Borough of Manhattan extended, thence easterly along the southerly side of West Houston Street to the southerly side of Houston Street, thence easterly along the southerly side of Houston Street to the southerly side of East Houston Street, thence northeasterly along the southerly side of East Houston Street to the point where it would intersect with the United States pierhead line in the East River as it exists now or may be extended, including tax lots within or immediately adjacent thereto.

5.5.1(b) "Lower Manhattan Redevelopment Project" means any project in Lower Manhattan that is funded in whole or in part with federal or State funding, or any project intended to improve transportation between Lower Manhattan and the two air terminals in the City known as LaGuardia Airport and John F. Kennedy International Airport, or between Lower Manhattan and the air terminal in Newark known as Newark Liberty International Airport, and that is funded in whole or in part with federal funding.

5.5.1(c) "Nonroad Engine" means an internal combustion engine (including the fuel system) that is not used in a Motor Vehicle or a vehicle used solely for competition, or that is not subject to standards promulgated under Section 7411 or Section 7521 of Title 42 of the United States Code, except that this term shall apply to internal combustion engines used to power generators, compressors or similar equipment used in any construction program or project.

5.5.1(d) "Nonroad Vehicle" means a vehicle that is powered by a Nonroad Engine, fifty (50) horsepower (HP) and greater, and that is not a Motor Vehicle or a vehicle used solely for competition, which shall include, but not be limited to, excavators, backhoes, cranes, compressors, generators, bulldozers, and similar equipment, except

that this terms shall not apply to horticultural maintenance vehicles used for landscaping purposes that are powered by a Nonroad Engine of sixty-five (65) HP or less and that are not used in any construction program or project.

5.5.1(e) "Ultra Low Sulfur Diesel Fuel" means diesel fuel that has a sulfur content of no more than fifteen parts per million (15 ppm).

5.5.2 Requirements. **Contractors** and **Subcontractors** are required to use only Ultra Low Sulfur Diesel Fuel to power the diesel-powered Nonroad Vehicles with engine HP rating of fifty (50) HP and above used on a Lower Manhattan Redevelopment Project and, where practicable, to reduce the emission of pollutants by retrofitting such Nonroad Vehicles with oxidation catalysts, particulate filters, or technology that achieves lowest particulate matter emissions.

5.6 Pesticides. In accordance with Section 17-1209 of the Administrative Code, to the extent that the **Contractor** or any **Subcontractor** applies pesticides to any property owned or leased by the **City**, the **Contractor**, and any **Subcontractor** shall comply with Chapter 12 of the Administrative Code.

5.7 Waste Treatment, Storage, and Disposal Facilities and Transporters. In connection with the **Work**, the **Contractor** and any **Subcontractor** shall use only those waste treatment, storage, and disposal facilities and waste transporters that possess the requisite license, permit or other governmental approval necessary to treat, store, dispose, or transport the waste, materials or hazardous substances.

5.8 Environmentally Preferable Purchasing. The **Contractor** shall ensure that products purchased or leased by the **Contractor** or any **Subcontractor** for the **Work** that are not specified by the **City** or are submitted as equivalents to a product specified by the **City** comply with the requirements of the New York City Environmentally Preferable Purchasing Program contained in Chapter 11 of Title 43 of the RCNY, pursuant to Chapter 3 of Title 6 of the Administrative Code.

ARTICLE 6. INSPECTION

6.1 During the progress of the **Work** and up to the date of **Final Acceptance**, the **Contractor** shall at all times afford the representatives of the **City** every reasonable, safe, and proper facility for inspecting all **Work** done or being done at the **Site** and also for inspecting the manufacture or preparation of materials and equipment at the place of such manufacture or preparation.

6.2 The **Contractor's** obligation hereunder shall include the uncovering or taking down of finished **Work** and its restoration thereafter; provided, however, that the order to uncover, take down and restore shall be in writing, and further provided that if **Work** thus exposed proves satisfactory, and if the **Contractor** has complied with Article 6.1, such uncovering or taking down and restoration shall be considered an item of **Extra Work** to be paid for in accordance with the provisions of Article 26. If the **Work** thus exposed proves unsatisfactory, the **City** has no obligation to compensate the **Contractor** for the uncovering, taking down or restoration.

6.3 Inspection and approval by the **Commissioner**, the **Engineer**, **Project Manager**, or **Resident Engineer**, of finished **Work** or of **Work** being performed, or of materials and equipment at the place of manufacture or preparation, shall not relieve the **Contractor** of its obligation to perform the **Work** in strict accordance with the **Contract**. Finished or unfinished **Work** not found to be in strict accordance with the **Contract** shall be replaced as directed by the **Engineer**, even though such **Work** may have been previously approved and paid for. Such corrective **Work** is **Contract Work** and shall not be deemed **Extra Work**.

6.4 Rejected **Work** and materials shall be promptly taken down and removed from the **Site**, which must at all times be kept in a reasonably clean and neat condition.

**ARTICLE 7. PROTECTION OF WORK AND OF PERSONS
AND PROPERTY; NOTICES AND INDEMNIFICATION**

7.1 During the performance of the **Work** and up to the date of **Final Acceptance**, the **Contractor** shall be under an absolute obligation to protect the finished and unfinished **Work** against any damage, loss, injury, theft and/or vandalism and in the event of such damage, loss, injury, theft and/or vandalism, it shall promptly replace and/or repair such **Work** at the **Contractor's** sole cost and expense, as directed by the **Resident Engineer**. The obligation to deliver finished **Work** in strict accordance with the **Contract** prior to **Final Acceptance** shall be absolute and shall not be affected by the **Resident Engineer's** approval of, or failure to prohibit, the **Means and Methods of Construction** used by the **Contractor**.

7.2 During the performance of the **Work** and up to the date of **Final Acceptance**, the **Contractor** shall take all reasonable precautions to protect all persons and the property of the **City** and of others from damage, loss or injury resulting from the **Contractor's**, and/or its **Subcontractors'** operations under this **Contract**. The **Contractor's** obligation to protect shall include the duty to provide, place or replace, and adequately maintain at or about the **Site** suitable and sufficient protection such as lights, barricades, and enclosures.

7.3 The **Contractor** shall comply with the notification requirements set forth below in the event of any loss, damage or injury to **Work**, persons or property, or any accidents arising out of the operations of the **Contractor** and/or its **Subcontractors** under this **Contract**.

7.3.1 The **Contractor** shall make a full and complete report in writing to the **Resident Engineer** within three (3) **Days** after the occurrence.

7.3.2 The **Contractor** shall also send written notice of any such event to all insurance carriers that issued potentially responsive policies (including commercial general liability insurance carriers for events relating to the **Contractor's** own employees) no later than twenty (20) days after such event and again no later than twenty (20) days after the initiation of any claim and/or action resulting therefrom. Such notice shall contain the following information: the number of the insurance policy, the name of the Named Insured, the date and location of the incident, and the identity of the persons injured or property damaged. For any policy on which the **City** and/or the **Engineer, Architect, or Project Manager** are Additional Insureds, such notice shall expressly specify that "this notice is being given on behalf of the City of New York as Additional Insured, such other Additional Insureds, as well as the Named Insured."

7.3.2(a) Whenever such notice is sent under a policy on which the **City** is an Additional Insured, the **Contractor** shall provide copies of the notice to the **Comptroller, the Commissioner** and the **City Corporation Counsel**. The copy to the **Comptroller** shall be sent to the Insurance Unit, NYC Comptroller's Office, 1 Centre Street – Room 1222, New York, New York, 10007. The copy to the **Commissioner** shall be sent to the address set forth in Schedule A of the General Conditions. The copy to the **City Corporation Counsel** shall be sent to Insurance Claims Specialist, Affirmative Litigation Division, New York City Law Department, 100 Church Street, New York, New York 10007.

7.3.2(b) If the **Contractor** fails to provide any of the foregoing notices to any appropriate insurance carrier(s) in a timely and complete manner, the **Contractor** shall indemnify the **City** for all losses, judgments, settlements, and expenses, including reasonable attorneys' fees, arising from an insurer's disclaimer of coverage citing late notice by or on behalf of the **City**.

7.4 To the fullest extent permitted by law, the **Contractor** shall defend, indemnify, and hold the **City**, its employees, and officials (the "Indemnitees") harmless against any and all claims (including but not limited to claims asserted by any employee of the **Contractor** and/or its **Subcontractors**) and costs and expenses of whatever kind (including but not limited to payment or reimbursement of attorneys' fees and disbursements) allegedly arising out of or in any way related to the operations of the **Contractor** and/or its **Subcontractors** in the performance of this **Contract** or from the **Contractor's** and/or its **Subcontractors'** failure to comply with any of the provisions of this **Contract** or of the **Law**. Such costs and expenses shall include all those incurred in defending the underlying claim and those incurred in connection with the enforcement of this Article 7.4 by way of cross-claim, third-party claim, declaratory action or otherwise. The parties expressly agree that the indemnification obligation hereunder contemplates (1) full indemnity in the event of liability imposed against the Indemnitees without negligence and solely by reason of statute, operation of **Law** or otherwise; and (2) partial indemnity in the event of any actual negligence on the part of the Indemnitees either causing or contributing to the underlying claim (in which case, indemnification will be limited to any liability imposed over and above that percentage attributable to actual fault whether by statute, by operation of **Law**, or otherwise). Where partial indemnity is provided hereunder, all costs and expenses shall be indemnified on a pro rata basis.

7.4.1 Indemnification under Article 7.4 or any other provision of the **Contract** shall operate whether or not **Contractor** or its **Subcontractors** have placed and maintained the insurance specified under Article 22.

7.5 The provisions of this Article 7 shall not be deemed to create any new right of action in favor of third parties against the **Contractor** or the **City**.

CHAPTER III TIME PROVISIONS

ARTICLE 8. COMMENCEMENT AND PROSECUTION OF THE WORK

8.1 The **Contractor** shall commence the **Work** on the date specified in the **Notice to Proceed** or the **Order to Work**. The time for performance of the **Work** under the **Contract** shall be computed from the date specified in the **Notice to Proceed** or the **Order to Work**. **TIME BEING OF THE ESSENCE** to the **City**, the **Contractor** shall thereafter prosecute the **Work** diligently, using such **Means and Methods of Construction** as are in accord with Article 4 herein and as will assure its completion not later than the date specified in this **Contract**, or on the date to which the time for completion may be extended.

ARTICLE 9. PROGRESS SCHEDULES

9.1 To enable the **Work** to be performed in an orderly and expeditious manner, the **Contractor**, within fifteen (15) **Days** after the **Notice to Proceed** or **Order to Work**, unless otherwise directed by the **Engineer**, shall submit to the **Engineer** a proposed progress schedule based on the Critical Path Method in the form of a bar graph or in such other form as specified by the **Engineer**, and monthly cash flow requirements, showing:

9.1.1 The anticipated time of commencement and completion of each of the various operations to be performed under this **Contract**; and

9.1.2 The sequence and interrelation of each of these operations with the others and with those of other related contracts; and

9.1.3 The estimated time required for fabrication or delivery, or both, of all materials and equipment required for the **Work**, including the anticipated time for obtaining required approvals pursuant to Article 10; and

9.1.4 The estimated amount in dollars the **Contractor** will claim on a monthly basis.

9.2 The proposed schedule shall be revised as directed by the **Engineer**, until finally approved by the **Engineer**, and after such approval, subject to the provisions of Article 11, shall be strictly adhered to by the **Contractor**.

9.3 If the **Contractor** shall fail to adhere to the approved progress schedule, or to the schedule as revised pursuant to Article 11, it shall promptly adopt such other or additional **Means and Methods of Construction**, at its sole cost and expense, as will make up for the time lost and will assure completion in accordance with the approved progress schedule. The approval by the **City** of a progress schedule which is shorter than the time allotted under the **Contract** shall not create any liability for the **City** if the approved progress schedule is not met.

9.4 The **Contractor** will not receive any payments until the proposed progress schedule is submitted.

ARTICLE 10. REQUESTS FOR INFORMATION OR APPROVAL

10.1 From time to time as the **Work** progresses and in the sequence indicated by the approved progress schedule, the **Contractor** shall submit to the **Engineer** a specific request in writing for each item of information or approval required by the **Contractor**. These requests shall state the latest date upon which the information or approval is actually required by the **Contractor**, and shall be submitted in a reasonable time in advance thereof to provide the **Engineer** a sufficient time to act upon such submissions, or any necessary re-submissions thereof.

10.2 The **Contractor** shall not have any right to an extension of time on account of delays due to the **Contractor's** failure to submit requests for the required information or the required approval in accordance with the above requirements.

ARTICLE 11. NOTICE OF CONDITIONS CAUSING DELAY AND DOCUMENTATION OF DAMAGES CAUSED BY DELAY

11.1 After the commencement of any condition which is causing or may cause a delay in completion of the **Work**, including conditions for which the **Contractor** may be entitled to an extension of time; the following notifications and submittals are required:

11.1.1 Within seven (7) **Days** after the commencement of such condition, the **Contractor** must notify the **Engineer** in writing of the existence, nature and effect of such condition upon the approved progress schedule and the **Work**, and must state why and in what respects, if any, the condition is causing or may cause a delay.

11.1.2 If the **Contractor** shall claim to be sustaining damages for delay as provided for in this Article 11, within forty-five (45) **Days** from the time such damages are first incurred, and every thirty (30) **Days** thereafter for as long as such damages are being incurred, the **Contractor** shall submit to the **Commissioner** verified written statements of the details and the amounts of such damages, together with documentary evidence of such damages, ("statement of delay damages") as further detailed in Article 11.6. The **Contractor** may submit any of the above statements within such additional time as may be granted by the **Commissioner** in writing upon written request therefor. On failure of the **Contractor** to strictly comply with all of the foregoing provisions, such claims shall be deemed waived and no right to recover on such claims shall exist. Damages that the **Contractor** may claim in any action arising under or by reason of this **Contract** shall not be different from or in excess of the statements made and documentation provided pursuant to this Article 11.

11.1.3 Within 60 days of submission of the final verified statement of claims pursuant to Article 44, the **Commissioner** shall make a determination as to whether a compensable delay has occurred and, if so, the amount of compensation due the **Contractor**. Notwithstanding the above, the **Commissioner** may make a determination as to whether a compensable delay has occurred at any time after the **Contractor's** first submission of a statement of delay damages provided, however, that the amount of compensation due to the **Contractor** will not be determined until the **Commissioner** determines that the **Work** is delayed after the date set for substantial completion.

11.2 Failure of the **Contractor** to strictly comply with the requirements of Article 11.1.1 may, in the discretion of the **Commissioner**, be deemed sufficient cause to deny any extension of time on account of delay arising out of such condition. Failure of the **Contractor** to strictly comply with the requirements of Articles 11.1.1 and 11.1.2 shall be deemed a conclusive waiver by the **Contractor** of any and all claims for damages for delay arising from such condition and no right to recover on such claims shall exist.

11.3 When appropriate and directed by the **Engineer**, the progress schedule shall be revised by the **Contractor** until finally approved by the **Engineer**. The revised progress schedule must be strictly adhered to by the **Contractor**.

11.4 Compensable Delays

11.4.1 The **Contractor** agrees to make claim only for additional costs attributable to delay in the performance of this **Contract** necessarily extending the time for completion of the **Work** or resulting from acceleration directed by the **Commissioner** and required to maintain the **Project** schedule, occasioned solely by any act or omission to act of the **City** listed below. The **Contractor** also agrees that delay from any other cause shall be compensated, if at all, solely by an extension of time to complete the performance of the **Work**.

- 11.4.1.1 The failure of the **City** to take reasonable measures to coordinate and progress the **Work**, except that the **City** shall not be responsible for the **Contractor's** obligation to coordinate and progress the **Work** of its **Subcontractors**.
- 11.4.1.2 Extended delays attributable to the **City** in the review or issuance of change orders, in shop drawing reviews and approvals or as a result of the cumulative impact of multiple change orders, which have a verifiable impact on **Project** costs.
- 11.4.1.3 The unavailability of the **Site** for an extended period of time that significantly affects the scheduled completion of the **Contract**.

- 11.4.1.4 The issuance by the **Engineer** of a stop work order relative to a substantial portion of the **Work** for a period exceeding thirty (30) **Days**, that was not brought about through any action or omission of the **Contractor**.
- 11.4.1.5 Differing site conditions that were neither known nor reasonably ascertainable on a pre-bid inspection of the **Site** or review of the bid documents or other publicly available sources, and that are not ordinarily encountered in the **Project's** geographical area or neighborhood or in the type of **Work** to be performed.
- 11.4.1.6 Delays caused by the **City's** bad faith or its willful, malicious, or grossly negligent conduct;
- 11.4.1.7 Delays not contemplated by the parties;
- 11.4.1.8 Delays so unreasonable that they constitute an intentional abandonment of the **Contract** by the **City**; and
- 11.4.1.9 Delays resulting from the **City's** breach of a fundamental obligation of the **Contract**.

11.4.2 No claim may be made for any alleged delay in **Substantial Completion** of the **Work** by a date earlier than the date of **Substantial Completion** provided for in Schedule A unless there is a provision in the **Contract** providing for additional compensation for early completion. No claim may be made for any alleged delay in **Substantial Completion** of the **Work** if the work is substantially completed by the date of **Substantial Completion** provided for in Schedule A unless acceleration has been directed by the **Commissioner** to meet the date of **Substantial Completion** set forth in Schedule A.

11.4.3 The provisions of this Article 11 apply only to claims for additional costs attributable to delay and do not preclude determinations by the **Commissioner** allowing reimbursements for additional costs for **Extra Work** pursuant to Articles 25 and 26 of this **Contract**. To the extent that any cost attributable to delay is reimbursed as part of a change order, no additional claim for compensation under this Article 11 shall be allowed.

11.5 Non-Compensable Delays. The **Contractor** agrees to make no claim for, and is deemed to have included in its bid prices for the various items of the **Contract**, the extra/additional costs attributable to any delays caused by or attributable to the items set forth below. For such items, the **Contractor** shall be compensated, if at all, solely by an extension of time to complete the performance of the **Work**, in accordance with the provisions of Article 13. Such extensions of time will be granted, if at all, pursuant to the grounds set forth in Article 13.3.

11.5.1 The acts or omissions of any third parties, including but not limited to **Other Contractors**, public/ governmental bodies (other than **City Agencies**), utilities or private enterprises, who are disclosed in the **Contract Documents** or are ordinarily encountered or generally recognized as related to the **Work**;

11.5.2 Any situation which was within the contemplation of the parties at the time of entering into the **Contract**, including any delay indicated or disclosed in the **Contract Documents** or generally recognized as related to the nature of the **Work**, and/or the existence of any facility or appurtenance owned, operated or maintained by any third party, as indicated or disclosed in the **Contract Documents** or ordinarily encountered or generally recognized as related to the nature of the **Work**;

11.5.3 Restraining orders, injunctions or judgments issued by a court which were caused by a Contractor's submission, action or inaction or by a Contractor's **Means and Methods** of

Construction, or by third parties, unless such order, injunction or judgment was the result of an action or omission by the **City**;

11.5.4 Any labor boycott, strike, picketing, lockout or similar situation;

11.5.5 Any shortages of supplies or materials, or unavailability of equipment, required by the **Contract Work**;

11.5.6 Climatic conditions, storms, floods, droughts, tidal waves, fires, hurricanes, earthquakes, landslides or other catastrophes or acts of God, or acts of war or of the public enemy or terrorist acts, including the **City's** reasonable responses thereto; and

11.5.7 **Extra Work** which does not significantly affect the overall completion of the **Contract**, reasonable delays in the review or issuance of change orders or field orders and/or in shop drawing reviews or approvals.

11.6 Required Content of Submission of Statement of Delay Damages

11.6.1 In the verified written statement of delay damages required by Article 11.1.2, the following information shall be provided by the **Contractor**:

11.6.1.1 For each delay, the start and end dates of the claimed periods of delay and, in addition, a description of the operations that were delayed, an explanation of how they were delayed, and the reasons for the delay, including identifying the applicable act or omission of the **City** listed in Article 11.4.

11.6.1.2 A detailed factual statement of the claim providing all necessary dates, locations and items of **Work** affected by the claim.

11.6.1.3 The amount of additional compensation sought and a breakdown of that amount into categories as described in Article 26.2, subject to the limitations set forth in Article 11.7.

11.6.1.4 Any additional information requested by the **Commissioner**.

11.7 Recoverable Costs

11.7.1 Delay damages may be recoverable for the following costs actually and necessarily incurred in the performance of the **Work**:

11.7.1.1 Direct labor, including payroll taxes (subject to statutory wage caps) and supplemental benefits, based on time and materials records;

11.7.1.2 Necessary materials (including transportation to the **Site**), based on time and material records;

11.7.1.3 Reasonable rental value of necessary plant and equipment other than small tools, plus fuel/energy costs according to the applicable formula set forth in Articles 26.2.4 and/or 26.2.8, based on time and material records;

11.7.1.4 Insurance and bond costs;

11.7.1.5 Extended field office costs;

11.7.1.6 Extended **Site** overhead; and

11.7.1.7 Extended home office overhead.

11.7.2 Recoverable Subcontractor Costs. When the **Work** is performed by a **Subcontractor**, the **Contractor** may be paid the actual and necessary costs of such subcontracted **Work** as outlined above in Articles 11.7.1.1 through 11.7.1.6, and an

additional overhead of five (5%) percent of the costs outlined in Articles 11.7.1.1 through 11.7.1.3.

11.7.3 **Non-Recoverable Costs.** The parties agree that the **City** will have no liability for the following items and the **Contractor** agrees it shall make no claim for the following items:

11.7.3.1 Profit, or loss of anticipated or unanticipated profit;

11.7.3.2 Consequential damages, including but not limited to interest on monies in dispute, including interest which is paid on such monies, loss of bonding capacity, bidding opportunities, or interest in investment, or any resulting insolvency;

11.7.3.3 Indirect costs or expenses of any nature;

11.7.3.4 Direct or indirect costs attributable to performance of **Work** where the **Contractor**, because of situations or conditions within its control, has not progressed the **Work** in a satisfactory manner; and

11.7.3.5 Attorneys' fees and dispute and claims preparation expenses.

11.8 Determinations under this Article 11 are not subject to the jurisdiction of the Contract Dispute Resolution Board pursuant to the dispute resolution process set forth in Article 27.

11.9 If the parties agree, pursuant to Article 11.1.3 above, that a compensable delay has occurred and agree on the amount of compensation, payment may be made pursuant to a written change order. Payment pursuant to such change order is subject to pre-audit by the **Engineering Audit Officer**, and may be post-audited by the **Comptroller** and/or the **Agency**.

ARTICLE 12. COORDINATION WITH OTHER CONTRACTORS

12.1 During the progress of the **Work**, **Other Contractors** may be engaged in performing other work or may be awarded other contracts for additional work on this **Project**. In that event, the **Contractor** shall coordinate the **Work** to be done hereunder with the work of such **Other Contractors** and the **Contractor** shall fully cooperate with such **Other Contractors** and carefully fit its own **Work** to that provided under other contracts as may be directed by the **Engineer**. The **Contractor** shall not commit or permit any act which will interfere with the performance of work by any **Other Contractors**.

12.2 If the **Engineer** determines that the **Contractor** is failing to coordinate its **Work** with the work of **Other Contractors** as the **Engineer** has directed, then the **Commissioner** shall have the right to withhold any payments otherwise due hereunder until the **Contractor** completely complies with the **Engineer's** directions.

12.3 The **Contractor** shall notify the **Engineer** in writing if any **Other Contractor** on this **Project** is failing to coordinate its work with the **Work** of this **Contract**. If the **Engineer** finds such charges to be true, the **Engineer** shall promptly issue such directions to the **Other Contractor** with respect thereto as the situation may require. The **City** shall not, however, be liable for any damages suffered by any **Other Contractor's** failure to coordinate its work with the **Work** of this **Contract** or by reason of the **Other Contractor's** failure to promptly comply with the directions so issued by the **Engineer**, or by reason of any **Other Contractor's** default in performance, it being understood that the **City** does not guarantee the responsibility or continued efficiency of any contractor. The **Contractor** agrees to make no claim against

the City for any damages relating to or arising out of any directions issued by the **Engineer** pursuant to this Article 12 (including but not limited to the failure of any **Other Contractor** to comply or promptly comply with such directions), or the failure of the **Engineer** to issue any directions, or the failure of any **Other Contractor** to coordinate its work, or the default in performance of any **Other Contractor**.

12.4 The **Contractor** shall indemnify and hold the City harmless from any and all claims or judgments for damages and from costs and expenses to which the City may be subjected or which it may suffer or incur by reason of the **Contractor's** failure to comply with the **Engineer's** directions promptly; and the **Comptroller** shall have the right to exercise the powers reserved in Article 23 with respect to any claims which may be made for damages due to the **Contractor's** failure to comply with the **Engineer's** directions promptly. Insofar as the facts and Law relating to any claim would preclude the City from being completely indemnified by the **Contractor**, the City shall be partially indemnified by the **Contractor** to the fullest extent provided by Law.

12.5 Should the **Contractor** sustain any damage through any act or omission of any **Other Contractor** having a contract with the City for the performance of work upon the Site or of work which may be necessary to be performed for the proper prosecution of the Work to be performed hereunder, or through any act or omission of a subcontractor of such **Other Contractor**, the **Contractor** shall have no claim against the City for such damage, but shall have a right to recover such damage from the **Other Contractor** under the provision similar to the following provisions which apply to this Contract and have been or will be inserted in the contracts with such **Other Contractors**:

12.5.1 Should any **Other Contractor** having or who shall hereafter have a contract with the City for the performance of work upon the Site sustain any damage through any act or omission of the **Contractor** hereunder or through any act or omission of any **Subcontractor** of the **Contractor**, the **Contractor** agrees to reimburse such **Other Contractor** for all such damages and to defend at its own expense any action based upon such claim and if any judgment or claim (even if the allegations of the action are without merit) against the City shall be allowed the **Contractor** shall pay or satisfy such judgment or claim and pay all costs and expenses in connection therewith and agrees to indemnify and hold the City harmless from all such claims. Insofar as the facts and Law relating to any claim would preclude the City from being completely indemnified by the **Contractor**, the City shall be partially indemnified by the **Contractor** to the fullest extent provided by Law.

12.6 The City's right to indemnification hereunder shall in no way be diminished, waived or discharged by its recourse to assessment of liquidated damages as provided in Article 15, or by the exercise of any other remedy provided for by Contract or by Law.

ARTICLE 13. EXTENSION OF TIME FOR PERFORMANCE

13.1 If performance by the **Contractor** is delayed for a reason set forth in Article 13.3, the **Contractor** may be allowed a reasonable extension of time in conformance with this Article 13 and the PPB Rules.

13.2 Any extension of time may be granted only by the ACCO or by the Board for the Extension of Time (hereafter "Board") (as set forth below) upon written application by the **Contractor**.

13.3 Grounds for Extension: If such application is made, the **Contractor** shall be entitled to an extension of time for delay in completion of the Work caused solely:

13.3.1 By the acts or omissions of the City, its officials, agents or employees; or

13.3.2 By the act or omissions of **Other Contractors** on this **Project**; or

13.3.3 By supervening conditions entirely beyond the control of either party hereto (such as, but not limited to, acts of God or the public enemy, excessive inclement weather, war or other national emergency making performance temporarily impossible or illegal, or strikes or labor disputes not brought about by any act or omission of the **Contractor**).

13.3.4 The **Contractor** shall, however, be entitled to an extension of time for such causes only for the number of **Days** of delay which the **ACCO** or the Board may determine to be due solely to such causes, and then only if the **Contractor** shall have strictly complied with all of the requirements of Articles 9 and 10.

13.4 The **Contractor** shall not be entitled to receive a separate extension of time for each of several causes of delay operating concurrently, but, if at all, only for the actual period of delay in completion of the **Work** as determined by the **ACCO** or the Board, irrespective of the number of causes contributing to produce such delay. If one of several causes of delay operating concurrently results from any act, fault or omission of the **Contractor** or of its **Subcontractors** or **Materialmen**, and would of itself (irrespective of the concurrent causes) have delayed the **Work**, no extension of time will be allowed for the period of delay resulting from such act, fault or omission.

13.5 The determination made by the **ACCO** or the Board on an application for an extension of time shall be binding and conclusive on the **Contractor**.

13.6 The **ACCO** or the Board acting entirely within their discretion may grant an application for an extension of time for causes of delay other than those herein referred.

13.7 Permitting the **Contractor** to continue with the **Work** after the time fixed for its completion has expired, or after the time to which such completion may have been extended has expired, or the making of any payment to the **Contractor** after such time, shall in no way operate as a waiver on the part of the **City** of any of its rights under this **Contract**.

13.8 Application for Extension of Time:

13.8.1 Before the **Contractor's** time extension request will be considered, the **Contractor** shall notify the **ACCO** of the condition which allegedly has caused or is causing the delay, and shall submit a written application to the **ACCO** identifying:

13.8.1(a) The **Contractor**; the registration number; and **Project** description;

13.8.1(b) Liquidated damage assessment rate, as specified in the **Contract**;

13.8.1(c) Original total bid price;

13.8.1(d) The original **Contract** start date and completion date;

13.8.1(e) Any previous time extensions granted (number and duration); and

13.8.1(f) The extension of time requested.

13.8.2 In addition, the application for extension of time shall set forth in detail:

13.8.2(a) The nature of each alleged cause of delay in completing the **Work**;

13.8.2(b) The date upon which each such cause of delay began and ended and the number of **Days** attributable to each such cause;

13.8.2(c) A statement that the **Contractor** waives all claims except for those delineated in the application, and the particulars of any claims which the **Contractor** does not agree to waive. For time extensions for **Substantial Completion** and final completion payments, the application shall include a detailed statement of the dollar amounts of each element of claim item reserved; and

13.8.2(d) A statement indicating the **Contractor's** understanding that the time extension is granted only for purposes of permitting continuation of **Contract** performance and payment for **Work** performed and that the **City** retains its right to conduct an investigation and assess liquidated damages as appropriate in the future.

13.9 Analysis and Approval of Time Extensions:

13.9.1 For time extensions for partial payments, a written determination shall be made by the **ACCO** who may, for good and sufficient cause, extend the time for the performance of the **Contract** as follows:

13.9.1(a) If the **Work** is to be completed within six (6) months, the time for performance may be extended for sixty (60) **Days**;

13.9.1(b) If the **Work** is to be completed within less than one (1) year but more than six (6) months, an extension of ninety (90) **Days** may be granted;

13.9.1(c) If the **Contract** period exceeds one (1) year, besides the extension granted in Article 13.9.1(b), an additional thirty (30) **Days** may be granted for each multiple of six (6) months involved beyond the one (1) year period; or

13.9.1(d) If exceptional circumstances exist, the **ACCO** may extend the time for performance beyond the extensions in Articles 13.9.1(a), 13.9.1(b), and 13.9.1(c). In that event, the **ACCO** shall file with the Mayor's Office of Contract Services a written explanation of the exceptional circumstances.

13.9.2 For extensions of time for **Substantial Completion** and final completion payments, the **Engineer**, in consultation with the **ACCO**, shall prepare a written analysis of the delay (including a preliminary determination of the causes of delay, the beginning and end dates for each such cause of delay, and whether the delays are excusable under the terms of this **Contract**). The report shall be subject to review by and approval of the Board, which shall have authority to question its analysis and determinations and request additional facts or documentation. The report as reviewed and made final by the Board shall be made a part of the **Agency** contract file. Neither the report itself nor anything contained therein shall operate as a waiver or release of any claim the **City** may have against the **Contractor** for either actual or liquidated damages.

13.9.3 Approval Mechanism for Time Extensions for **Substantial Completion** or Final Completion Payments: An extension shall be granted only with the approval of the Board which is comprised of the **ACCO** of the **Agency**, the **City** Corporation Counsel, and the **Comptroller**, or their authorized representatives.

13.9.4 Neither the granting of any application for an extension of time to the **Contractor** or any **Other Contractor** on this **Project** nor the papers, records or reports related to any application for or grant of an extension of time or determination related thereto shall be referred to or offered in evidence by the **Contractor** or its attorneys in any action or proceeding.

13.10 No Damage for Delay: The **Contractor** agrees to make no claim for damages for delay in the performance of this **Contract** occasioned by any act or omission to act of the **City** or any of its representatives, except as provided for in Article 11.

ARTICLE 14. COMPLETION AND FINAL ACCEPTANCE OF THE WORK

14.1 Date for **Substantial Completion**: The **Contractor** shall substantially complete the **Work** within the time fixed in Schedule A of the General Conditions, or within the time to which such **Substantial Completion** may be extended.

14.2 Determining the Date of **Substantial Completion**: The **Work** will be deemed to be substantially complete when the two conditions set forth below have been met.

14.2.1 Inspection: The **Engineer** has inspected the **Work** and has made a written determination that it is substantially complete.

14.2.2 Approval of **Final Approved Punch List** and Date for **Final Acceptance**: Following inspection of the **Work**, the **Engineer** shall furnish the **Contractor** with a final punch list, specifying all items of **Work** to be completed and proposing dates for the completion of each specified item of **Work**. The **Contractor** shall then submit in writing to the **Engineer** within ten (10) **Days** of the **Engineer** furnishing the final punch list either acceptance of the dates or proposed alternative dates for the completion of each specified item of **Work**. If the **Contractor** proposes alternative dates, then, within a reasonable time after receipt, the **Engineer**, in a written notification to the **Contractor**, shall approve the **Contractor's** completion dates or, if they are unable to agree, the **Engineer** shall establish dates for the completion of each item of **Work**. If the **Contractor** neither accepts the dates nor proposes alternative dates within ten (10) **Days**, the schedule proposed by the **Engineer** shall be deemed accepted. The latest completion date specified shall be the date for **Final Acceptance** of the **Work**.

14.3 Date of **Substantial Completion**. The date of approval of the **Final Approved Punch List**, shall be the date of **Substantial Completion**. The date of approval of the **Final Approved Punch List** shall be either (a) if the **Contractor** approves the final punch list and proposed dates for completion furnished by the **Engineer**, the date of the **Contractor's** approval; or (b) if the **Contractor** neither accepts the dates nor proposes alternative dates, ten (10) **Days** after the **Engineer** furnishes the **Contractor** with a final punch list and proposed dates for completion; or (c) if the **Contractor** proposes alternative dates, the date that the **Engineer** sends written notification to the **Contractor** either approving the **Contractor's** proposed alternative dates or establishing dates for the completion for each item of **Work**.

14.4 Determining the Date of **Final Acceptance**: The **Work** will be accepted as final and complete as of the date of the **Engineer's** inspection if, upon such inspection, the **Engineer** finds that all items on the **Final Approved Punch List** are complete and no further **Work** remains to be done. The **Commissioner** will then issue a written determination of **Final Acceptance**.

14.5 Request for Inspection: Inspection of the **Work** by the **Engineer** for the purpose of **Substantial Completion** or **Final Acceptance** shall be made within ten (10) **Days** after receipt of the **Contractor's** written request therefor.

14.6 Request for Re-inspection: If upon inspection for the purpose of **Substantial Completion** or **Final Acceptance**, the **Engineer** determines that there are items of **Work** still to be performed, the **Contractor** shall promptly perform them and then request a re-inspection. If upon re-inspection, the **Engineer** determines that the **Work** is substantially complete or finally accepted, the date of such re-inspection shall be the date of **Substantial Completion** or **Final Acceptance**. Re-inspection by the **Engineer** shall be made within ten (10) **Days** after receipt of the **Contractor's** written request therefor.

14.7 Initiation of Inspection by the **Engineer**: If the **Contractor** does not request inspection or re-inspection of the **Work** for the purpose of **Substantial Completion** or **Final Acceptance**, the **Engineer** may initiate such inspection or re-inspection.

ARTICLE 15. LIQUIDATED DAMAGES

15.1 In the event the **Contractor** fails to substantially complete the **Work** within the time fixed for such **Substantial Completion** in Schedule A of the General Conditions, plus authorized time extensions, or if the **Contractor**, in the sole determination of the **Commissioner**, has abandoned the **Work**, the **Contractor** shall pay to the **City** the sum fixed in Schedule A of the General Conditions, for each and every **Day** that the time consumed in substantially completing the **Work** exceeds the time allowed therefor; which said sum, in view of the difficulty of accurately ascertaining the loss which the **City** will suffer by reason of delay in the **Substantial Completion** of the **Work** hereunder, is hereby fixed and agreed as the liquidated damages that the **City** will suffer by reason of such delay, and not as a penalty. This Article 15 shall also apply to the **Contractor** whether or not the **Contractor** is defaulted pursuant to Chapter X of this **Contract**. Neither the failure to assess liquidated damages nor the granting of any time extension shall operate as a waiver or release of any claim the **City** may have against the **Contractor** for either actual or liquidated damages.

15.2 Liquidated damages received hereunder are not intended to be nor shall they be treated as either a partial or full waiver or discharge of the **City's** right to indemnification, or the **Contractor's** obligation to indemnify the **City**, or to any other remedy provided for in this **Contract** or by **Law**.

15.3 The **Commissioner** may deduct and retain out of the monies which may become due hereunder, the amount of any such liquidated damages; and in case the amount which may become due hereunder shall be less than the amount of liquidated damages suffered by the **City**, the **Contractor** shall be liable to pay the difference.

ARTICLE 16. OCCUPATION OR USE PRIOR TO COMPLETION

16.1 Unless otherwise provided for in the **Specifications**, the **Commissioner** may take over, use, occupy or operate any part of the **Work** at any time prior to **Final Acceptance**, upon written notification to the **Contractor**. The **Engineer** shall inspect the part of the **Work** to be taken over, used, occupied, or operated, and will furnish the **Contractor** with a written statement of the **Work**, if any, which remains to be performed on such part. The **Contractor** shall not object to, nor interfere with, the **Commissioner's** decision to exercise the rights granted by Article 16. In the event the **Commissioner** takes over, uses, occupies, or operates any part of the **Work**:

16.1.1 the **Engineer** shall issue a written determination of **Substantial Completion** with respect to such part of the **Work**;

16.1.2 the **Contractor** shall be relieved of its absolute obligation to protect such part of the unfinished **Work** in accordance with Article 7;

16.1.3 the **Contractor's** guarantee on such part of the **Work** shall begin on the date of such use by the **City**; and;

16.1.4 the **Contractor** shall be entitled to a return of so much of the amount retained in accordance with Article 21 as it relates to such part of the **Work**, except so much thereof as may be retained under Articles 24 and 44.

CHAPTER IV SUBCONTRACTS AND ASSIGNMENTS

ARTICLE 17. SUBCONTRACTS

17.1 The **Contractor** shall not make subcontracts totaling an amount more than the percentage of the total **Contract** price fixed in Schedule A of the General Conditions, without prior written permission from the **Commissioner**. All subcontracts made by the **Contractor** shall be in writing. No **Work** may be performed by a **Subcontractor** prior to the **Contractor** entering into a written subcontract with the **Subcontractor** and complying with the provisions of this Article 17.

17.2 Before making any subcontracts, the **Contractor** shall submit a written statement to the **Commissioner** giving the name and address of the proposed **Subcontractor**; the portion of the **Work** and materials which it is to perform and furnish; the cost of the subcontract; the VENDEX questionnaire if required; the proposed subcontract if requested by the **Commissioner**; and any other information tending to prove that the proposed **Subcontractor** has the necessary facilities, skill, integrity, past experience, and financial resources to perform the **Work** in accordance with the terms and conditions of this **Contract**.

17.3 In addition to the requirements in Article 17.2, **Contractor** is required to list the **Subcontractor** in the web based Subcontractor Reporting System through the City's Payee Information Portal (PIP), available at www.nyc.gov/pip.¹ For each **Subcontractor** listed, **Contractor** is required to provide the following information: maximum contract value, description of **Subcontractor's** **Work**, start and end date of the subcontract and identification of the **Subcontractor's** industry. Thereafter, **Contractor** will be required to report in the system the payments made to each **Subcontractor** within 30 days of making the payment. If any of the required information changes throughout the Term of the **Contract**, **Contractor** will be required to revise the information in the system.

Failure of the **Contractor** to list a **Subcontractor** and/or to report **Subcontractor** payments in a timely fashion may result in the **Commissioner** declaring the **Contractor** in default of the **Contract** and will subject **Contractor** to liquidated damages in the amount of \$100 per day for each day that the **Contractor** fails to identify a **Subcontractor** along with the required information about the **Subcontractor** and/or fails to report payments to a **Subcontractor**, beyond the time frames set forth herein or in the notice from the **City**. Article 15 shall govern the issue of liquidated damages.

¹ In order to use the new system, a PIP account will be required. Detailed instructions on creating a PIP account and using the new system are also available at www.nyc.gov/pip. Additional assistance with PIP may be obtained by emailing the Financial Information Services Agency Help Desk at pip@fisa.nyc.gov.

17.4 If an approved **Subcontractor** elects to subcontract any portion of its subcontract, the proposed sub-subcontract shall be submitted in the same manner as directed above.

17.5 The **Commissioner** will notify the **Contractor** in writing whether the proposed **Subcontractor** is approved. If the proposed **Subcontractor** is not approved, the **Contractor** may submit another proposed **Subcontractor** unless the **Contractor** decides to do the **Work**. No **Subcontractor** shall be permitted to enter or perform any work on the **Site** unless approved.

17.6 Before entering into any subcontract hereunder, the **Contractor** shall provide the proposed **Subcontractor** with a complete copy of this document and inform the proposed **Subcontractor** fully and completely of all provisions and requirements of this **Contract** relating either directly or indirectly to the **Work** to be performed and the materials to be furnished under such subcontract, and every such **Subcontractor** shall expressly stipulate that all labor performed and materials furnished by the **Subcontractor** shall strictly comply with the requirements of this **Contract**.

17.7 Documents given to a prospective **Subcontractor** for the purpose of soliciting the **Subcontractor's** bid shall include either a copy of the bid cover or a separate information sheet setting forth the **Project** name, the **Contract** number (if available), the **Agency** (as noted in Article 2.1.6), and the **Project's** location.

17.8 The **Commissioner's** approval of a **Subcontractor** shall not relieve the **Contractor** of any of its responsibilities, duties, and liabilities hereunder. The **Contractor** shall be solely responsible to the **City** for the acts or defaults of its **Subcontractor** and of such **Subcontractor's** officers, agents, and employees, each of whom shall, for this purpose, be deemed to be the agent or employee of the **Contractor** to the extent of its subcontract.

17.9 If the **Subcontractor** fails to maintain the necessary facilities, skill, integrity, past experience, and financial resources (other than due to the **Contractor's** failure to make payments where required) to perform the **Work** in accordance with the terms and conditions of this **Contract**, the **Contractor** shall promptly notify the **Commissioner** and replace such **Subcontractor** with a newly approved **Subcontractor** in accordance with this Article 17.

17.10 The **Contractor** shall be responsible for ensuring that all **Subcontractors** performing **Work** at the **Site** maintain all insurance required by **Law**.

17.11 The **Contractor** shall promptly, upon request, file with the **Engineer** a conformed copy of the subcontract and its cost. The subcontract shall provide the following:

17.11.1 **Payment to Subcontractors:** The agreement between the **Contractor** and its **Subcontractor** shall contain the same terms and conditions as to method of payment for **Work**, labor, and materials, and as to retained percentages, as are contained in this **Contract**.

17.11.2 **Prevailing Rate of Wages:** The agreement between the **Contractor** and its **Subcontractor** shall include the prevailing wage rates and supplemental benefits to be paid in accordance with Labor Law Section 220.

17.11.3 **Section 6-123 of the Administrative Code:** Pursuant to the requirements of Section 6-123 of the Administrative Code, every agreement between the **Contractor** and a **Subcontractor** in excess of fifty thousand (\$50,000) dollars shall include a provision that the **Subcontractor** shall not engage in any unlawful discriminatory practice as defined in Title VIII of the Administrative Code (Section 8-101 *et seq.*).

17.11.4 All requirements required pursuant to federal and/or state grant agreement(s), if applicable to the **Work**.

17.12 The **Commissioner** may deduct from the amounts certified under this **Contract** to be due to the **Contractor**, the sum or sums due and owing from the **Contractor** to the **Subcontractors** according to the terms of the said subcontracts, and in case of dispute between the **Contractor** and its **Subcontractor**, or **Subcontractors**, as to the amount due and owing, the **Commissioner** may deduct and withhold from the amounts certified under this **Contract** to be due to the **Contractor** such sum or sums as may be claimed by such **Subcontractor**, or **Subcontractors**, in a sworn affidavit, to be due and owing until such time as such claim or claims shall have been finally resolved.

17.13 On contracts where performance bonds and payment bonds are executed, the **Contractor** shall include on each requisition for payment the following data: **Subcontractor's** name, value of the subcontract, total amount previously paid to **Subcontractor** for **Work** previously requisitioned, and the amount, including retainage, to be paid to the **Subcontractor** for **Work** included in the requisition.

17.14 On **Contracts** where performance bonds and payment bonds are not executed, the **Contractor** shall include with each requisition for payment submitted hereunder, a signed statement from each and every **Subcontractor** and/or **Materialman** for whom payment is requested in such requisition. Such signed statement shall be on the letterhead of the **Subcontractor** and/or **Materialman** for whom payment is requested and shall (i) verify that such **Subcontractor** and/or **Materialman** has been paid in full for all **Work** performed and/or material supplied to date, exclusive of any amount retained and any amount included on the current requisition, and (ii) state the total amount of retainage to date, exclusive of any amount retained on the current requisition.

ARTICLE 18. ASSIGNMENTS

18.1 The **Contractor** shall not assign, transfer, convey or otherwise dispose of this **Contract**, or the right to execute it, or the right, title or interest in or to it or any part thereof, or assign, by power of attorney or otherwise any of the monies due or to become due under this **Contract**, unless the previous written consent of the **Commissioner** shall first be obtained thereto, and the giving of any such consent to a particular assignment shall not dispense with the necessity of such consent to any further or other assignments.

18.2 Such assignment, transfer, conveyance or other disposition of this **Contract** shall not be valid until filed in the office of the **Commissioner** and the **Comptroller**, with the written consent of the **Commissioner** endorsed thereon or attached thereto.

18.3 Failure to obtain the previous written consent of the **Commissioner** to such an assignment, transfer, conveyance or other disposition, may result in the revocation and annulment of this **Contract**. The **City** shall thereupon be relieved and discharged from any further liability to the **Contractor**, its assignees, transferees or sublessees, who shall forfeit and lose all monies therefor earned under the **Contract**, except so much as may be required to pay the **Contractor's** employees.

18.4 The provisions of this clause shall not hinder, prevent, or affect an assignment by the **Contractor** for the benefit of its creditors made pursuant to the **Laws** of the State of New York.

18.5 This **Contract** may be assigned by the **City** to any corporation, agency or instrumentality having authority to accept such assignment.

**CHAPTER V
CONTRACTOR'S SECURITY AND GUARANTEE**

ARTICLE 19. SECURITY DEPOSIT

19.1 If performance and payment bonds are required, the City shall retain the bid security to ensure that the successful bidder executes the **Contract** and furnishes the required payment and performance security within ten (10) **Days** after notice of the award of the **Contract**. If the successful bidder fails to execute the **Contract** and furnish the required payment and performance security, the City shall retain such bid security as set forth in the Information for Bidders. If the successful bidder executes the **Contract** and furnishes the required payment and performance security, the City shall return the bid security within a reasonable time after the furnishing of such bonds and execution of the **Contract** by the City.

19.2 If performance and payment bonds are not required, the bid security shall be retained by the City as security for the Contractor's faithful performance of the **Contract**. If partial payments are provided, the bid security will be returned to the Contractor after the sum retained under Article 21 equals the amount of the bid security, subject to other provisions of this **Contract**. If partial payments are not provided, the bid security will be released when final payment is certified by the City for payment.

19.3 If the Contractor is declared in default under Article 48 prior to the return of the deposit, or if any claim is made such as referred to in Article 23, the amount of such deposit, or so much thereof as the **Comptroller** may deem necessary, may be retained and then applied by the **Comptroller**:

19.3.1 To compensate the City for any expense, loss or damage suffered or incurred by reason of or resulting from such default, including the cost of re-letting and liquidated damages; or

19.3.2 To indemnify the City against any and all claims.

ARTICLE 20. PAYMENT GUARANTEE

20.1 On **Contracts** where one hundred (100%) percent performance bonds and payment bonds are executed, this Article 20 does not apply.

20.2 In the event the terms of this **Contract** do not require the Contractor to provide a payment bond or where the **Contract** does not require a payment bond for one hundred (100%) percent of the **Contract** price, the City shall, in accordance with the terms of this Article 20, guarantee payment of all lawful claims for:

20.2.1 Wages and compensation for labor performed and/or services rendered; and

20.2.2 Materials, equipment, and supplies provided, whether incorporated into the **Work** or not, when demands have been filed with the City as provided hereinafter by any person, firm, or corporation which furnished labor, material, equipment, supplies, or any combination thereof, in connection with the **Work** performed hereunder (hereinafter referred to as the "beneficiary") at the direction of the City or the Contractor.

20.3 The provisions of Article 20.2 are subject to the following limitations and conditions:

20.3.1 If the **Contractor** provides a payment bond for a value that is less than one hundred (100%) percent of the value of the **Contract Work**, the payment bond provided by the **Contractor** shall be primary (and non-contributing) to the payment guarantee provided under this Article 20.

20.3.2 The guarantee is made for the benefit of all beneficiaries as defined in Article 20.2 provided that those beneficiaries strictly adhere to the terms and conditions of Article 20.3.4 and 20.3.5.

20.3.3 Nothing in this Article 20 shall prevent a beneficiary providing labor, services or material for the **Work** from suing the **Contractor** for any amounts due and owing the beneficiary by the **Contractor**.

20.3.4 Every person who has furnished labor or material, to the **Contractor** or to a **Subcontractor** of the **Contractor**, in the prosecution of the **Work** and who has not been paid in full therefor before the expiration of a period of ninety (90) **Days** after the date on which the last of the labor was performed or material was furnished by him/her for which the claim is made, shall have the right to sue on this payment guarantee in his/her own name for the amount, or the balance thereof, unpaid at the time of commencement of the action; provided, however, that a person having a direct contractual relationship with a **Subcontractor** of the **Contractor** but no contractual relationship express or implied with the **Contractor** shall not have a right of action upon the guarantee unless he/she shall have given written notice to the **Contractor** within one hundred twenty (120) **Days** from the date on which the last of the labor was performed or the last of the material was furnished, for which his/her claim is made, stating with substantial accuracy the amount claimed and the name of the party to whom the material was furnished or for whom the labor was performed. The notice shall be served by delivering the same personally to the **Contractor** or by mailing the same by registered mail, postage prepaid, in an envelope addressed to the **Contractor** at any place where it maintains an office or conducts its business; provided, however, that where such notice is actually received by the **Contractor** by other means, such notice shall be deemed sufficient.

20.3.5 Except as provided in Labor Law Section 220-g, no action on this payment guarantee shall be commenced after the expiration of the one-year limitations period set forth in Section 137(4)(b) of the State Finance Law.

20.3.6 The **Contractor** shall promptly forward to the **City** any notice or demand received pursuant to Article 20.3.4. The **Contractor** shall inform the **City** of any defenses to the notice or demand and shall forward to the **City** any documents the **City** requests concerning the notice or demand.

20.3.7 All demands made against the **City** by a beneficiary of this payment guarantee shall be presented to the **Engineer** along with all written documentation concerning the demand which the **Engineer** deems reasonably appropriate or necessary, which may include, but shall not be limited to: the subcontract; any invoices presented to the **Contractor** for payment; the notarized statement of the beneficiary that the demand is due and payable, that a request for payment has been made of the **Contractor** and that the demand has not been paid by the **Contractor** within the time allowed for such payment by the subcontract; and copies of any correspondence between the beneficiary and the **Contractor** concerning such demand. The **City** shall notify the **Contractor** that a demand has been made. The **Contractor** shall inform the **City** of any defenses to the demand and shall forward to the **City** any documents the **City** requests concerning the demand.

20.3.8 The City shall make payment only if, after considering all defenses presented by the Contractor, it determines that the payment is due and owing to the beneficiary making the demand.

20.3.9 No beneficiary shall be entitled to interest from the City, or to any other costs, including, but not limited to, attorneys' fees, except to the extent required by State Finance Law Section 137.

20.4 Upon the receipt by the City of a demand pursuant to this Article 20, the City may withhold from any payment otherwise due and owing to the Contractor under this Contract an amount sufficient to satisfy the demand.

20.4.1 In the event the City determines that the demand is valid, the City shall notify the Contractor of such determination and the amount thereof and direct the Contractor to immediately pay such amount to the beneficiary. In the event the Contractor, within seven (7) Days of receipt of such notification from the City, fails to pay the beneficiary, such failure shall constitute an automatic and irrevocable assignment of payment by the Contractor to the beneficiary for the amount of the demand determined by the City to be valid. The Contractor, without further notification or other process, hereby gives its unconditional consent to such assignment of payment to the beneficiary and authorizes the City, on its behalf, to take all necessary actions to implement such assignment of payment, including without limitation the execution of any instrument or documentation necessary to effectuate such assignment.

20.4.2 In the event that the amount otherwise due and owing to the Contractor by the City is insufficient to satisfy such demand, the City may, at its option, require payment from the Contractor of an amount sufficient to cover such demand and exercise any other right to require or recover payment which the City may have under Law or Contract.

20.4.3 In the event the City determines that the demand is invalid, any amount withheld pending the City's review of such demand shall be paid to the Contractor; provided, however, no lien has been filed. In the event a claim or an action has been filed, the terms and conditions set forth in Article 23 shall apply. In the event a lien has been filed, the parties will be governed by the provisions of the Lien Law of the State of New York.

20.5 The provisions of this Article 20 shall not prevent the City and the Contractor from resolving disputes in accordance with the PPB Rules, where applicable.

20.6 In the event the City determines that the beneficiary is entitled to payment pursuant to this Article 20, such determination and any defenses and counterclaims raised by the Contractor shall be taken into account in evaluating the Contractor's performance.

20.7 Nothing in this Article 20 shall relieve the Contractor of the obligation to pay the claims of all persons with valid and lawful claims against the Contractor relating to the Work.

20.8 The Contractor shall not require any performance, payment or other bonds of any Subcontractor if this Contract does not require such bonds of the Contractor.

20.9 The payment guarantee made pursuant to this Article 20 shall be construed in a manner consistent with Section 137 of the State Finance Law and shall afford to persons furnishing labor or materials to the Contractor or its Subcontractors in the prosecution of the Work under this Contract all of the rights and remedies afforded to such persons by such section, including but not limited to, the right

to commence an action against the City on the payment guarantee provided by this Article 20 within the one-year limitations period set forth in Section 137(4)(b).

ARTICLE 21. RETAINED PERCENTAGE

21.1 If this **Contract** requires one hundred (100%) percent performance and payment security, then as further security for the faithful performance of this **Contract**, the **Commissioner** shall deduct, and retain until the substantial completion of the **Work**, five (5%) percent of the value of **Work** certified for payment in each partial payment voucher.

21.2 If this **Contract** does not require one hundred (100%) percent performance and payment security and if the price for which this **Contract** was awarded does not exceed one million (\$1,000,000) dollars, then as further security for the faithful performance of this **Contract**, the **Commissioner** shall deduct, and retain until the substantial completion of the **Work**, five (5%) percent of the value of **Work** certified for payment in each partial payment voucher.

21.3 If this **Contract** does not require one hundred (100%) percent performance and payment security and if the price for which this **Contract** was awarded exceeds one million (\$1,000,000) dollars, then as further security for the faithful performance of this **Contract**, the **Commissioner** shall deduct, and retain until the substantial completion of the **Work**, up to ten (10%) percent of the value of **Work** certified for payment in each partial payment voucher. The percentage to be retained is set forth in Schedule A of the General Conditions.

ARTICLE 22. INSURANCE

22.1 Types of Insurance: The **Contractor** shall procure and maintain the following types of insurance if, and as indicated, in Schedule A of the General Conditions (with the minimum limits and special conditions specified in Schedule A). Such insurance shall be maintained from the date the **Contractor** is required to provide Proof of Insurance pursuant to Article 22.3.1 through the date of completion of all required **Work** (including punch list work as certified in writing by the **Resident Engineer**), except for insurance required pursuant to Article 22.1.4, which may terminate upon **Substantial Completion** of the **Contract**. All insurance shall meet the requirements set forth in this Article 22. Wherever this Article requires that insurance coverage be "at least as broad" as a specified form (including all ISO forms), there is no obligation that the form itself be used, provided that the **Contractor** can demonstrate that the alternative form or endorsement contained in its policy provides coverage at least as broad as the specified form.

22.1.1 Commercial General Liability Insurance: The **Contractor** shall provide Commercial General Liability Insurance covering claims for property damage and/or bodily injury, including death, which may arise from any of the operations under this **Contract**. Coverage under this insurance shall be at least as broad as that provided by the latest edition of Insurance Services Office ("ISO") Form CG 0001. Such insurance shall be "occurrence" based rather than "claims-made" and include, without limitation, the following types of coverage: premises operations; products and completed operations; contractual liability (including the tort liability of another assumed in a contract); broad form property damage; independent contractors; explosion, collapse and underground (XCU); construction means and methods; and incidental malpractice. Such insurance shall contain a "per project" aggregate limit, as specified in Schedule A, that applies separately to operations under this **Contract**.

22.1.1(a) Such Commercial General Liability Insurance shall name the **City** as an Additional Insured. Coverage for the **City** shall specifically include the **City's** officials and employees, be at least as broad as the latest edition of ISO Form CG 20 10 and provide completed operations coverage at least as broad as the latest edition of ISO Form CG 20 37.

22.1.1(b) Such Commercial General Liability Insurance shall name all other entities designated as additional insureds in Schedule A but only for claims arising from the **Contractor's** operations under this **Contract**, with coverage at least as broad as the latest edition of ISO Form CG 20 26.

22.1.1(c) If the **Work** requires a permit from the Department of Buildings pursuant to 1 RCNY Section 101-08, at http://www.nyc.gov/html/dob/downloads/rules/1_RCNY_101-08.pdf, the **Contractor** shall provide Commercial General Liability Insurance with limits of at least those required by 1 RCNY section 101-08. If the **Work** does not require such a permit, the minimum limits shall be those provided for in Schedule A.

22.1.1(d) If any of the **Work** includes repair of a waterborne vessel owned by or to be delivered to the **City**, such Commercial General Liability shall include, or be endorsed to include, Ship Repairer's Legal Liability Coverage to protect against, without limitation, liability arising from navigation of such vessels prior to delivery to and acceptance by the **City**.

22.1.2 Workers' Compensation Insurance, Employers' Liability Insurance, and Disability Benefits Insurance: The **Contractor** shall provide, and shall cause its **Subcontractors** to provide, Workers Compensation Insurance, Employers' Liability Insurance, and Disability Benefits Insurance in accordance with the **Laws** of the State of New York on behalf of all employees providing services under this **Contract** (except for those employees, if any, for which the **Laws** require insurance only pursuant to Article 22.1.3).

22.1.3 United States Longshoremen's and Harbor Workers Act and/or Jones Act Insurance: If specified in Schedule A of the General Conditions or if required by **Law**, the **Contractor** shall provide insurance in accordance with the United States Longshoremen's and Harbor Workers Act and/or the Jones Act, on behalf of all qualifying employees providing services under this **Contract**.

22.1.4 Builders Risk Insurance: If specified in Schedule A of the General Conditions, the **Contractor** shall provide Builders Risk Insurance on a completed value form for the total value of the **Work** through **Substantial Completion** of the **Work** in its entirety. Such insurance shall be provided on an All Risk basis and include coverage, without limitation, for windstorm (including named windstorm), storm surge, flood and earth movement. Unless waived by the **Commissioner**, it shall include coverage for ordinance and law, demolition and increased costs of construction, debris removal, pollutant clean up and removal, and expediting costs. Such insurance shall cover, without limitation, (a) all buildings and/or structures involved in the **Work**, as well as temporary structures at the **Site**, and (b) any property that is intended to become a permanent part of such building or structure, whether such property is on the **Site**, in transit or in temporary storage. Policies shall name the **Contractor** as Named Insured and list the **City** as both an Additional Insured and a Loss Payee as its interest may appear.

22.1.4(a) Policies of such insurance shall specify that, in the event a loss occurs at an occupied facility, occupancy of such facility is permitted without the consent of the issuing insurance company.

22.1.4(b) Such insurance may be provided through an Installation Floater, at the **Contractor's** option, if it otherwise conforms with the requirements of this Article 22.1.4.

22.1.5 Commercial Automobile Liability Insurance: The **Contractor** shall provide Commercial Automobile Liability Insurance for liability arising out of ownership, maintenance or use of any owned (if any), non-owned and hired vehicles to be used in connection with this **Contract**. Coverage shall be at least as broad as the latest edition of ISO Form CA0001. If vehicles are used for transporting hazardous materials, the Automobile Liability Insurance shall be endorsed to provide pollution liability broadened coverage for covered vehicles (endorsement CA 99 48) as well as proof of MCS 90.

22.1.6 Contractors Pollution Liability Insurance: If specified in Schedule A of the General Conditions, the **Contractor** shall maintain, or cause the **Subcontractor** doing such **Work** to maintain, Contractors Pollution Liability Insurance covering bodily injury and property damage. Such insurance shall provide coverage for actual, alleged or threatened emission, discharge, dispersal, seepage, release or escape of pollutants (including asbestos), including any loss, cost or expense incurred as a result of any cleanup of pollutants (including asbestos) or in the investigation, settlement or defense of any claim, action, or proceedings arising from the operations under this **Contract**. Such insurance shall be in the **Contractor's** name and list the **City** as an Additional Insured and any other entity specified in Schedule A. Coverage shall include, without limitation, (a) loss of use of damaged property or of property that has not been physically injured, (b) transportation, and (c) non-owned disposal sites.

22.1.6(a) Coverage for the **City** as Additional Insured shall specifically include the **City's** officials and employees and be at least as broad as provided to the **Contractor** for this **Project**.

22.1.6(b) If such insurance is written on a claims-made policy, such policy shall have a retroactive date on or before the effective date of this **Contract**, and continuous coverage shall be maintained, or an extended discovery period exercised, for a period of not less than three (3) years from the time the **Work** under this **Contract** is completed.

22.1.7 Marine Insurance:

22.1.7(a) Marine Protection and Indemnity Insurance: If specified in Schedule A of the General Conditions or if the **Contractor** engages in marine operations in the execution of any part of the **Work**, the **Contractor** shall maintain, or cause the **Subcontractor** doing such **Work** to maintain, Marine Protection and Indemnity Insurance with coverage at least as broad as Form SP-23. The insurance shall provide coverage for the **Contractor** or **Subcontractor** (whichever is doing this **Work**) and for the **City** (together with its officials and employees) and any other entity specified in Schedule A as an Additional Insured for bodily injury and property damage arising from marine operations under this **Contract**. Coverage shall include, without limitation, injury or death of crew members (if not fully provided through other insurance), removal of wreck, damage to piers, wharves and other fixed or floating objects and loss of or damage to any other vessel or craft, or to property on such other vessel or craft.

22.1.7(b) Hull and Machinery Insurance: If specified in Schedule A of the General Conditions or if the **Contractor** engages in marine operations in the execution of any part of the **Work**, the **Contractor** shall maintain, or cause the **Subcontractor** doing such **Work** to maintain, Hull and Machinery Insurance with coverage for the **Contractor** or **Subcontractor** (whichever is doing this **Work**) and for the **City** (together with its officials and employees) as Additional Insured at least as broad as the latest edition of American Institute Tug Form for all tugs used under this **Contract** and Collision Liability at least as broad as the latest edition of American Institute Hull Clauses.

22.1.7(c) Marine Pollution Liability Insurance: If specified in Schedule A of the General Conditions or if the **Contractor** engages in marine operations in the execution of any part of the **Work**, the **Contractor** shall maintain, or cause the **Subcontractor** doing such **Work** to maintain, Marine Pollution Liability Insurance covering itself (or the **Subcontractor** doing such **Work**) as Named Insured and the **City** (together with its officials and employees) and any other entity specified in Schedule A as an Additional Insured. Coverage shall be at least as broad as that provided by the latest edition of Water Quality Insurance Syndicate Form and include, without limitation, liability arising from the discharge or substantial threat of a discharge of oil, or from the release or threatened release of a hazardous substance including injury to, or economic losses resulting from, the destruction of or damage to real property, personal property or natural resources.

22.1.8 The **Contractor** shall provide such other types of insurance, at such minimum limits and with such conditions, as are specified in Schedule A of the General Conditions.

22.2 General Requirements for Insurance Coverage and Policies:

22.2.1 All required insurance policies shall be maintained with companies that may lawfully issue the required policy and have an A.M. Best rating of at least A-/VII or a Standard and Poor's rating of at least A, unless prior written approval is obtained from the **City** Corporation Counsel.

22.2.2 The **Contractor** shall be solely responsible for the payment of all premiums for all required policies and all deductibles and self-insured retentions to which such policies are subject, whether or not the **City** is an insured under the policy.

22.2.3 In his/her sole discretion, the **Commissioner** may, subject to the approval of the **Comptroller** and the **City** Corporation Counsel, accept Letters of Credit and/or custodial accounts in lieu of required insurance.

22.2.4 The **City's** limits of coverage for all types of insurance required pursuant to Schedule A of the General Conditions shall be the greater of (i) the minimum limits set forth in Schedule A or (ii) the limits provided to the **Contractor** as Named Insured under all primary, excess, and umbrella policies of that type of coverage.

22.2.5 The **Contractor** may satisfy its insurance obligations under this Article 22 through primary policies or a combination of primary and excess/umbrella policies, so long as all policies provide the scope of coverage required herein.

22.2.6 Policies of insurance provided pursuant to this Article 22 shall be primary and non-contributing to any insurance or self-insurance maintained by the **City**.

22.3 Proof of Insurance:

22.3.1 For all types of insurance required by Article 22.1 and Schedule A, except for insurance required by Articles 22.1.4 and 22.1.7, the **Contractor** shall file proof of insurance in accordance with this Article 22.3 within ten (10) **Days** of award. For insurance provided pursuant to Articles 22.1.4 and 22.1.7, proof shall be filed by a date specified by the **Commissioner** or ten (10) **Days** prior to the commencement of the portion of the **Work** covered by such policy, whichever is earlier.

22.3.2 For Workers' Compensation Insurance provided pursuant to Article 22.1.2, the **Contractor** shall submit one of the following forms: C-105.2 Certificate of Workers' Compensation Insurance; U-26.3 - State Insurance Fund Certificate of Workers' Compensation Insurance; Request for WC/DB Exemption (Form CE-200); equivalent or successor forms used by the New York State Workers' Compensation Board; or other proof of insurance in a form acceptable to the **Commissioner**. For Disability Benefits Insurance provided pursuant to Article 22.1.2, the Contractor shall submit DB-120.1 - Certificate Of Insurance Coverage Under The NYS Disability Benefits Law, Request for WC/DB Exemption (Form CE-200); equivalent or successor forms used by the New York State Workers' Compensation Board; or other proof of insurance in a form acceptable to the **Commissioner**. ACORD forms are not acceptable.

22.3.3 For policies provided pursuant to all of Article 22.1 other than Article 22.1.2, the **Contractor** shall submit one or more Certificates of Insurance on forms acceptable to the **Commissioner**. All such Certificates of Insurance shall certify (a) the issuance and effectiveness of such policies of insurance, each with the specified minimum limits (b) for insurance secured pursuant to Article 22.1.1 that the **City** and any other entity specified in Schedule A is an Additional Insured with coverage at least as broad as the most recent edition of ISO Forms CG 20 10, CG 20 37, and CG 20 26, as applicable; (c) in the event insurance is required pursuant to Article 22.1.6 and/or Article 22.1.7, that the **City** is an Additional Insured thereunder; (d) the company code issued to the insurance company by the National Association of Insurance Commissioners (the NAIC number); and (e) the number assigned to the **Contract** by the **City**. All such Certificates of Insurance shall be accompanied by either a duly executed "Certification by Broker" in the form contained in Part III of Schedule A or copies of all policies referenced in such Certificate of Insurance as certified by an authorized representative of the issuing insurance carrier. If any policy is not available at the time of submission, certified binders may be submitted until such time as the policy is available, at which time a certified copy of the policy shall be submitted.

22.3.4 Documentation confirming renewals of insurance shall be submitted to the **Commissioner** prior to the expiration date of coverage of policies required under this **Contract**. Such proofs of insurance shall comply with the requirements of Articles 22.3.2 and 22.3.3.

22.3.5 The **Contractor** shall be obligated to provide the **City** with a copy of any policy of insurance provided pursuant to this Article 22 upon the demand for such policy by the **Commissioner** or the **City** Corporation Counsel.

22.4 Operations of the Contractor:

22.4.1 The **Contractor** shall not commence the **Work** unless and until all required certificates have been submitted to and accepted by the **Commissioner**. Acceptance by the **Commissioner** of a certificate does not excuse the **Contractor** from securing insurance

consistent with all provisions of this Article 22 or of any liability arising from its failure to do so.

22.4.2 The **Contractor** shall be responsible for providing continuous insurance coverage in the manner, form, and limits required by this **Contract** and shall be authorized to perform **Work** only during the effective period of all required coverage.

22.4.3 In the event that any of the required insurance policies lapse, are revoked, suspended or otherwise terminated, for whatever cause, the **Contractor** shall immediately stop all **Work**, and shall not recommence **Work** until authorized in writing to do so by the **Commissioner**. Upon quitting the **Site**, except as otherwise directed by the **Commissioner**, the **Contractor** shall leave all plant, materials, equipment, tools, and supplies on the **Site**. **Contract** time shall continue to run during such periods and no extensions of time will be granted. The **Commissioner** may also declare the **Contractor** in default for failure to maintain required insurance.

22.4.4 In the event the **Contractor** receives notice, from an insurance company or other person, that any insurance policy required under this Article 22 shall be cancelled or terminated (or has been cancelled or terminated) for any reason, the **Contractor** shall immediately forward a copy of such notice to both the **Commissioner** and the New York City Comptroller, attn: Office of Contract Administration, Municipal Building, One Centre Street, room 1005, New York, New York 10007. Notwithstanding the foregoing, the **Contractor** shall ensure that there is no interruption in any of the insurance coverage required under this Article 22.

22.4.5 Where notice of loss, damage, occurrence, accident, claim or suit is required under an insurance policy maintained in accordance with this Article 22, the **Contractor** shall notify in writing all insurance carriers that issued potentially responsive policies of any such event relating to any operations under this **Contract** (including notice to Commercial General Liability insurance carriers for events relating to the **Contractor's** own employees) no later than 20 days after such event. For any policy where the **City** is an Additional Insured, such notice shall expressly specify that "this notice is being given on behalf of the City of New York as Insured as well as the Named Insured." Such notice shall also contain the following information: the number of the insurance policy, the name of the named insured, the date and location of the damage, occurrence, or accident, and the identity of the persons or things injured, damaged or lost. The **Contractor** shall simultaneously send a copy of such notice to the City of New York c/o Insurance Claims Specialist, Affirmative Litigation Division, New York City Law Department, 100 Church Street, New York, New York 10007.

22.4.6 In the event of any loss, accident, claim, action, or other event that does or can give rise to a claim under any insurance policy required under this Article 22, the **Contractor** shall at all times fully cooperate with the **City** with regard to such potential or actual claim.

22.5 **Subcontractor Insurance:** In the event the **Contractor** requires any **Subcontractor** to procure insurance with regard to any operations under this **Contract** and requires such **Subcontractor** to name the **Contractor** as an **Additional Insured** thereunder, the **Contractor** shall ensure that the **Subcontractor** name the **City**, including its officials and employees, as an **Additional Insured** with coverage at least as broad as the most recent edition of ISO Form CG 20 26.

22.6 Wherever reference is made in Article 7 or this Article 22 to documents to be sent to the **Commissioner** (e.g., notices, filings, or submissions), such documents shall be sent to the address set forth in Schedule A of the General Conditions. In the event no address is set forth in Schedule A, such documents are to be sent to the **Commissioner's** address as provided elsewhere in this **Contract**.

22.7 Apart from damages or losses covered by insurance provided pursuant to Articles 22.1.2, 22.1.3, or 22.1.5, the **Contractor** waives all rights against the **City**, including its officials and employees, for any damages or losses that are covered under any insurance required under this Article 22 (whether or not such insurance is actually procured or claims are paid thereunder) or any other insurance applicable to the operations of the **Contractor** and/or its employees, agents, or **Subcontractors**.

22.8 In the event the **Contractor** utilizes a self-insurance program to satisfy any of the requirements of this Article 22, the **Contractor** shall ensure that any such self-insurance program provides the **City** with all rights that would be provided by traditional insurance under this Article 22, including but not limited to the defense and indemnification obligations that insurers are required to undertake in liability policies.

22.9 Materiality/Non-Waiver: The **Contractor's** failure to secure policies in complete conformity with this Article 22, or to give an insurance company timely notice of any sort required in this **Contract** or to do anything else required by this Article 22 shall constitute a material breach of this **Contract**. Such breach shall not be waived or otherwise excused by any action or inaction by the **City** at any time.

22.10 Pursuant to General Municipal Law Section 108, this **Contract** shall be void and of no effect unless **Contractor** maintains Workers' Compensation Insurance for the term of this **Contract** to the extent required and in compliance with the New York State Workers' Compensation Law.

22.11 Other Remedies: Insurance coverage provided pursuant to this Article 22 or otherwise shall not relieve the **Contractor** of any liability under this **Contract**, nor shall it preclude the **City** from exercising any rights or taking such other actions available to it under any other provisions of this **Contract** or Law.

ARTICLE 23. MONEY RETAINED AGAINST CLAIMS

23.1 If any claim shall be made by any person or entity (including **Other Contractors** with the **City** on this **Project**) against the **City** or against the **Contractor** and the **City** for any of the following:

- (a) An alleged loss, damage, injury, theft or vandalism of any of the kinds referred to in Articles 7 and 12, plus the reasonable costs of defending the **City**, which in the opinion of the **Comptroller** may not be paid by an insurance company (for any reason whatsoever); or
- (b) An infringement of copyrights, patents or use of patented articles, tools, etc., as referred to in Article 57; or
- (c) Damage claimed to have been caused directly or indirectly by the failure of the **Contractor** to perform the **Work** in strict accordance with this **Contract**,

the amount of such claim, or so much thereof as the **Comptroller** may deem necessary, may be withheld by the **Comptroller**, as security against such claim, from any money due hereunder. The **Comptroller**, in his/her discretion, may permit the **Contractor** to substitute other satisfactory security in lieu of the monies so withheld.

23.2 If an action on such claim is timely commenced and the liability of the **City**, or the **Contractor**, or both, shall have been established therein by a final judgment of a court of competent jurisdiction, or if such claim shall have been admitted by the **Contractor** to be valid, the **Comptroller**

shall pay such judgment or admitted claim out of the monies retained by the **Comptroller** under the provisions of this Article 23, and return the balance, if any, without interest, to the **Contractor**.

ARTICLE 24. MAINTENANCE AND GUARANTY

24.1 The **Contractor** shall promptly repair, replace, restore or rebuild, as the **Commissioner** may determine, any finished **Work** in which defects of materials or workmanship may appear or to which damage may occur because of such defects, during the one (1) year period subsequent to the date of **Substantial Completion** (or use and occupancy in accordance with Article 16), except where other periods of maintenance and guaranty are provided for in Schedule A.

24.2 As security for the faithful performance of its obligations hereunder, the **Contractor**, upon filing its requisition for payment on **Substantial Completion**, shall deposit with the **Commissioner** a sum equal to one (1%) percent of the price (or the amount fixed in Schedule A of the General Conditions) in cash or certified check upon a state or national bank and trust company or a check of such bank and trust company signed by a duly authorized officer thereof and drawn to the order of the **Comptroller**, or obligations of the **City**, which the **Comptroller** may approve as of equal value with the sum so required.

24.3 In lieu of the above, the **Contractor** may make such security payment to the **City** by authorizing the **Commissioner** in writing to deduct the amount from the **Substantial Completion** payment which shall be deemed the deposit required above.

24.4 If the **Contractor** has faithfully performed all of its obligations hereunder the **Commissioner** shall so certify to the **Comptroller** within five (5) **Days** after the expiration of one (1) year from the date of **Substantial Completion** and acceptance of the **Work** or within thirty (30) **Days** after the expiration of the guarantee period fixed in the **Specifications**. The security payment shall be repaid to the **Contractor** without interest within thirty (30) **Days** after certification by the **Commissioner** to the **Comptroller** that the **Contractor** has faithfully performed all of its obligations hereunder.

24.5 Notice by the **Commissioner** to the **Contractor** to repair, replace, rebuild or restore such defective or damaged **Work** shall be timely, pursuant to this article, if given not later than ten (10) **Days** subsequent to the expiration of the one (1) year period or other periods provided for herein.

24.6 If the **Contractor** shall fail to repair, replace, rebuild or restore such defective or damaged **Work** promptly after receiving such notice, the **Commissioner** shall have the right to have the **Work** done by others in the same manner as provided for in the completion of a defaulted **Contract**, under Article 51.

24.7 If the security payment so deposited is insufficient to cover the cost of such **Work**, the **Contractor** shall be liable to pay such deficiency on demand by the **Commissioner**.

24.8 The **Engineer's** certificate setting forth the fair and reasonable cost of repairing, replacing, rebuilding or restoring any damaged or defective **Work** when performed by one other than the **Contractor**, shall be binding and conclusive upon the **Contractor** as to the amount thereof.

24.9 The **Contractor** shall obtain all manufacturers' warranties and guaranties of all equipment and materials required by this **Contract** in the name of the **City** and shall deliver same to the **Commissioner**. All of the **City's** rights and title and interest in and to said manufacturers' warranties and guaranties may be assigned by the **City** to any subsequent purchasers of such equipment and materials or lessees of the premises into which the equipment and materials have been installed.

**CHAPTER VI
CHANGES, EXTRA WORK, AND DOCUMENTATION OF CLAIM**

ARTICLE 25. CHANGES

25.1 Changes may be made to this **Contract** only as duly authorized in writing by the **Commissioner** in accordance with the **Law** and this **Contract**. All such changes, modifications, and amendments will become a part of the **Contract**. **Work** so ordered shall be performed by the **Contractor**.

25.2 **Contract** changes will be made only for **Work** necessary to complete the **Work** included in the original scope of the **Contract** and/or for non-material changes to the scope of the **Contract**. Changes are not permitted for any material alteration in the scope of **Work** in the **Contract**.

25.3 The **Contractor** shall be entitled to a price adjustment for **Extra Work** performed pursuant to a written change order. Adjustments to price shall be computed in one or more of the following ways:

25.3.1 By applicable unit prices specified in the **Contract**; and/or

25.3.2 By agreement of a fixed price; and/or

25.3.3 By time and material records; and/or

25.3.4 In any other manner approved by the **CCPO**.

25.4 All payments for change orders are subject to pre-audit by the **Engineering Audit Officer** and may be post-audited by the **Comptroller** and/or the **Agency**.

ARTICLE 26. METHODS OF PAYMENT FOR OVERRUNS AND EXTRA WORK

26.1 **Overrun of Unit Price Item:** An overrun is any quantity of a unit price item which the **Contractor** is directed to provide which is in excess of one hundred twenty-five (125%) percent of the estimated quantity for that item set forth in the bid schedule.

26.1.1 For any unit price item, the **Contractor** will be paid at the unit price bid for any quantity up to one hundred twenty-five (125%) percent of the estimated quantity for that item set forth in the bid schedule. If during the progress of the **Work**, the actual quantity of any unit price item required to complete the **Work** approaches the estimated quantity for that item, and for any reason it appears that the actual quantity of any unit price item necessary to complete the **Work** will exceed the estimated quantity for that item by twenty-five (25%) percent, the **Contractor** shall immediately notify the **Engineer** of such anticipated overrun. The **Contractor** shall not be compensated for any quantity of a unit price item provided which is in excess of one hundred twenty-five (125%) percent of the estimated quantity for that item set forth in the bid schedule without written authorization from the **Engineer**.

26.1.2 If the actual quantity of any unit price item necessary to complete the **Work** will exceed one hundred twenty five (125%) percent of the estimated quantity for that item set forth in the bid schedule, the **City** reserves the right and the **Contractor** agrees to negotiate a new unit price for such item. In no event shall such negotiated new unit price exceed the unit bid price. If the **City** and **Contractor** cannot agree on a new unit price, then the **City** shall order the **Contractor** and the **Contractor** agrees to provide additional quantities of the

item on the basis of time and material records for the actual and reasonable cost as determined under Article 26.2, but in no event at a unit price exceeding the unit price bid.

26.2 Extra Work: For **Extra Work** where payment is by agreement on a fixed price in accordance with Article 25.3.2, the price to be paid for such **Extra Work** shall be based on the fair and reasonable estimated cost of the items set forth below. For **Extra Work** where payment is based on time and material records in accordance with Article 25.3.3, the price to be paid for such **Extra Work** shall be the actual and reasonable cost of the items set forth below, calculated in accordance with the formula specified therein, if any.

26.2.1 Necessary materials (including transportation to the **Site**); plus

26.2.2 Necessary direct labor, including payroll taxes (subject to statutory wage caps) and supplemental benefits; plus

26.2.3 Sales and personal property taxes, if any, required to be paid on materials not incorporated into such **Extra Work**; plus

26.2.4 Reasonable rental value of **Contractor-owned** (or **Subcontractor-owned**, as applicable), necessary plant and equipment other than **Small Tools**, plus fuel/energy costs. Except for fuel costs for pick-up trucks which shall be reimbursed based on a consumption of five (5) gallons per shift, fuel costs shall be reimbursed based on actual costs or, in the absence of auditable documentation, the following fuel consumption formula per operating hour: $(.035) \times (\text{HP rating}) \times (\text{Fuel cost/gallon})$. Reasonable rental value is defined as the lower of either seventy-five percent of the monthly prorated rental rates established in "The AED Green Book, Rental Rates and Specifications for Construction Equipment" published by Equipment Watch (the "Green Book"), or seventy-five percent of the monthly prorated rental rates established in the "Rental Rate Blue Book for Construction Equipment" published by Equipment Watch (the "Blue Book") (the applicable Blue Book rate being for rental only without the addition of any operational costs listed in the Blue Book). The reasonable rental value is deemed to be inclusive of all operating costs except for fuel/energy consumption and equipment operator's wages/costs. For multiple shift utilization, reimbursement shall be calculated as follows: first shift shall be seventy-five (75%) percent of such rental rates; second shift shall be sixty (60%) percent of the first shift rate; and third shift shall be forty (40%) percent of the first shift rate. Equipment on standby shall be reimbursed at one-third (1/3) the prorated monthly rental rate. **Contractor-owned** (or **Subcontractor-owned**, as applicable) equipment includes equipment from rental companies affiliated with or controlled by the **Contractor** (or **Subcontractor**, as applicable), as determined by the **Commissioner**. In establishing cost reimbursement for non-operating **Contractor-owned** (or **Subcontractor-owned**, as applicable) equipment (scaffolding, sheeting systems, road plates, etc.), the **City** may restrict reimbursement to a purchase-salvage/life cycle basis if less than the computed rental costs; plus

26.2.5 Necessary installation and dismantling of such plant and equipment, including transportation to and from the **Site**, if any, provided that, in the case of non-**Contractor-owned** (or non-**Subcontractor-owned**, as applicable) equipment rented from a third party, the cost of installation and dismantling are not allowable if such costs are included in the rental rate; plus

26.2.6 Necessary fees charged by governmental entities; plus

26.2.7 Necessary construction-related service fees charged by non-governmental entities, such as landfill tipping fees; plus

26.2.8 Reasonable rental costs of non-**Contractor**-owned (or non-**Subcontractor**-owned, as applicable) necessary plant and equipment other than **Small Tools**, plus fuel/energy costs. Except for fuel costs for pick-up trucks which shall be reimbursed based on a consumption of five (5) gallons per shift, fuel costs shall be reimbursed based on actual costs or, in the absence of auditable documentation, the following fuel consumption formula per hour of operation: $(.035) \times (\text{HP rating}) \times (\text{Fuel cost/gallon})$. In lieu of renting, the **City** reserves the right to direct the purchase of non-operating equipment (scaffolding, sheeting systems, road plates, etc.), with payment on a purchase-salvage/life cycle basis, if less than the projected rental costs; plus

26.2.9 Workers' Compensation Insurance, and any insurance coverage expressly required by the **City** for the performance of the **Extra Work** which is different than the types of insurance required by Article 22 and Schedule A of the General Conditions. The cost of Workers' Compensation Insurance is subject to applicable payroll limitation caps and shall be based upon the carrier's Manual Rate for such insurance derived from the applicable class Loss Cost ("LC") and carrier's Lost Cost Multiplier ("LCM") approved by the New York State Department of Financial Services, and with the exception of experience rating, rate modifiers as promulgated by the New York Compensation Insurance Rating Board ("NYCIRB"); plus

26.2.10 Additional costs incurred as a result of the **Extra Work** for performance and payment bonds; plus

26.2.11 Twelve percent (12%) percent of the total of items in Articles 26.2.1 through 26.2.5 as compensation for overhead, except that no percentage for overhead will be allowed on **Payroll Taxes** or on the premium portion of overtime pay or on sales and personal property taxes. Overhead shall include without limitation, all costs and expenses in connection with administration, management superintendence, small tools, and insurance required by Schedule A of the General Conditions other than Workers' Compensation Insurance; plus

26.2.12 Ten (10%) percent of the total of items in Articles 26.2.1 through 26.2.5, plus the items in Article 26.2.11, as compensation for profit, except that no percentage for profit will be allowed on **Payroll Taxes** or on the premium portion of overtime pay or on sales and personal property taxes; plus

26.2.13 Five (5%) percent of the total of items in Articles 26.2.6 through 26.2.10 as compensation for overhead and profit.

26.3 Where the **Extra Work** is performed in whole or in part by other than the **Contractor's** own forces pursuant to Article 26.2, the **Contractor** shall be paid, subject to pre-audit by the **Engineering Audit Officer**, the cost of such **Work** computed in accordance with Article 26.2 above, plus an additional allowance of five (5%) percent to cover the **Contractor's** overhead and profit.

26.4 Where a change is ordered, involving both **Extra Work** and omitted or reduced **Contract Work**, the **Contract** price shall be adjusted, subject to pre-audit by the **EAO**, in an amount based on the difference between the cost of such **Extra Work** and of the omitted or reduced **Work**.

26.5 Where the **Contractor** and the **Commissioner** can agree upon a fixed price for **Extra Work** in accordance with Article 25.3.2 or another method of payment for **Extra Work** in accordance with Article

25.3.4, or for **Extra Work** ordered in connection with omitted **Work**, such method, subject to pre-audit by the **EAO**, may, at the option of the **Commissioner**, be substituted for the cost plus a percentage method provided in Article 26.2; provided, however, that if the **Extra Work** is performed by a **Subcontractor**, the **Contractor** shall not be entitled to receive more than an additional allowance of five (5%) percent for overhead and profit over the cost of such **Subcontractor's Work** as computed in accordance with Article 26.2.

ARTICLE 27. RESOLUTION OF DISPUTES

27.1 All disputes between the **City** and the **Contractor** of the kind delineated in this Article 27.1 that arise under, or by virtue of, this **Contract** shall be finally resolved in accordance with the provisions of this Article 27 and the **PPB Rules**. This procedure for resolving all disputes of the kind delineated herein shall be the exclusive means of resolving any such disputes.

27.1.1 This Article 27 shall not apply to disputes concerning matters dealt with in other sections of the **PPB Rules**, or to disputes involving patents, copyrights, trademarks, or trade secrets (as interpreted by the courts of New York State) relating to proprietary rights in computer software.

27.1.2 This Article 27 shall apply only to disputes about the scope of **Work** delineated by the **Contract**, the interpretation of **Contract** documents, the amount to be paid for **Extra Work** or disputed work performed in connection with the **Contract**, the conformity of the **Contractor's Work** to the **Contract**, and the acceptability and quality of the **Contractor's Work**; such disputes arise when the **Engineer, Resident Engineer, Engineering Audit Officer**, or other designee of the **Commissioner** makes a determination with which the **Contractor** disagrees.

27.2 All determinations required by this Article 27 shall be made in writing clearly stated, with a reasoned explanation for the determination based on the information and evidence presented to the party making the determination. Failure to make such determination within the time required by this Article 27 shall be deemed a non-determination without prejudice that will allow application to the next level.

27.3 During such time as any dispute is being presented, heard, and considered pursuant to this Article 27, the **Contract** terms shall remain in force and the **Contractor** shall continue to perform **Work** as directed by the **ACCO** or the **Engineer**. Failure of the **Contractor** to continue **Work** as directed shall constitute a waiver by the **Contractor** of its claim.

27.4 Presentation of Disputes to **Commissioner**.

Notice of Dispute and Agency Response. The **Contractor** shall present its dispute in writing ("Notice of Dispute") to the **Commissioner** within thirty (30) Days of receiving written notice of the determination or action that is the subject of the dispute. This notice requirement shall not be read to replace any other notice requirements contained in the **Contract**. The Notice of Dispute shall include all the facts, evidence, documents, or other basis upon which the **Contractor** relies in support of its position, as well as a detailed computation demonstrating how any amount of money claimed by the **Contractor** in the dispute was arrived at. Within thirty (30) Days after receipt of the detailed written submission comprising the complete Notice of Dispute, the **Engineer, Resident Engineer, Engineering Audit Officer**, or other designee of the **Commissioner** shall submit to the **Commissioner** all materials he or she deems pertinent to the dispute. Following initial submissions to the **Commissioner**, either party may demand of the other the production of any document or other material the demanding party believes may be relevant to the dispute. The requested party shall produce all relevant materials that are not otherwise

protected by a legal privilege recognized by the courts of New York State. Any question of relevancy shall be determined by the **Commissioner** whose decision shall be final. Willful failure of the **Contractor** to produce any requested material whose relevancy the **Contractor** has not disputed, or whose relevancy has been affirmatively determined, shall constitute a waiver by the **Contractor** of its claim.

27.4.1 **Commissioner Inquiry.** The **Commissioner** shall examine the material and may, in his or her discretion, convene an informal conference with the **Contractor**, the **ACCO**, and the **Engineer**, **Resident Engineer**, **Engineering Audit Officer**, or other designee of the **Commissioner** to resolve the issue by mutual consent prior to reaching a determination. The **Commissioner** may seek such technical or other expertise as he or she shall deem appropriate, including the use of neutral mediators, and require any such additional material from either or both parties as he or she deems fit. The **Commissioner's** ability to render, and the effect of, a decision hereunder shall not be impaired by any negotiations in connection with the dispute presented, whether or not the **Commissioner** participated therein. The **Commissioner** may or, at the request of any party to the dispute, shall compel the participation of any **Other Contractor** with a contract related to the **Work** of this **Contract**, and that **Contractor** shall be bound by the decision of the **Commissioner**. Any **Other Contractor** thus brought into the dispute resolution proceeding shall have the same rights and obligations under this Article 27 as the **Contractor** initiating the dispute.

27.4.2 **Commissioner Determination.** Within thirty (30) **Days** after the receipt of all materials and information, or such longer time as may be agreed to by the parties, the **Commissioner** shall make his or her determination and shall deliver or send a copy of such determination to the **Contractor**, the **ACCO**, and **Engineer**, **Resident Engineer**, **Engineering Audit Officer**, or other designee of the **Commissioner**, as applicable, together with a statement concerning how the decision may be appealed.

27.4.3 **Finality of Commissioner's Decision.** The **Commissioner's** decision shall be final and binding on all parties, unless presented to the Contract Dispute Resolution Board pursuant to this Article 27. The **City** may not take a petition to the Contract Dispute Resolution Board. However, should the **Contractor** take such a petition, the **City** may seek, and the Contract Dispute Resolution Board may render, a determination less favorable to the **Contractor** and more favorable to the **City** than the decision of the **Commissioner**.

27.5 **Presentation of Dispute to the Comptroller.** Before any dispute may be brought by the **Contractor** to the Contract Dispute Resolution Board, the **Contractor** must first present its claim to the **Comptroller** for his or her review, investigation, and possible adjustment.

27.5.1 **Time, Form, and Content of Notice.** Within thirty (30) **Days** of its receipt of a decision by the **Commissioner**, the **Contractor** shall submit to the **Comptroller** and to the **Commissioner** a Notice of Claim regarding its dispute with the **Agency**. The Notice of Claim shall consist of (i) a brief written statement of the substance of the dispute, the amount of money, if any, claimed and the reason(s) the **Contractor** contends the dispute was wrongly decided by the **Commissioner**; (ii) a copy of the written decision of the **Commissioner**; and (iii) a copy of all materials submitted by the **Contractor** to the **Agency**, including the Notice of Dispute. The **Contractor** may not present to the **Comptroller** any material not presented to the **Commissioner**, except at the request of the **Comptroller**.

27.5.2 **Response.** Within thirty (30) **Days** of receipt of the Notice of Claim, the **Agency** shall make available to the **Comptroller** a copy of all material submitted by the **Agency** to the **Commissioner** in connection with the dispute. The **Agency** may not present to the

Comptroller any material not presented to the **Commissioner** except at the request of the **Comptroller**.

27.5.3 Comptroller Investigation. The **Comptroller** may investigate the claim in dispute and, in the course of such investigation, may exercise all powers provided in Sections 7-201 and 7-203 of the Administrative Code. In addition, the **Comptroller** may demand of either party, and such party shall provide, whatever additional material the **Comptroller** deems pertinent to the claim, including original business records of the **Contractor**. Willful failure of the **Contractor** to produce within fifteen (15) **Days** any material requested by the **Comptroller** shall constitute a waiver by the **Contractor** of its claim. The **Comptroller** may also schedule an informal conference to be attended by the **Contractor**, **Agency** representatives, and any other personnel desired by the **Comptroller**.

27.5.4 Opportunity of Comptroller to Compromise or Adjust Claim. The **Comptroller** shall have forty-five (45) **Days** from his or her receipt of all materials referred to in Article 27.5.3 to investigate the disputed claim. The period for investigation and compromise may be further extended by agreement between the **Contractor** and the **Comptroller**, to a maximum of ninety (90) **Days** from the **Comptroller's** receipt of all materials. The **Contractor** may not present its petition to the Contract Dispute Resolution Board until the period for investigation and compromise delineated in this Article 27.5.4 has expired. In compromising or adjusting any claim hereunder, the **Comptroller** may not revise or disregard the terms of the **Contract** between the parties.

27.6 Contract Dispute Resolution Board. There shall be a Contract Dispute Resolution Board composed of:

27.6.1 The chief administrative law judge of the Office of Administrative Trials and Hearings (OATH) or his/her designated OATH administrative law judge, who shall act as chairperson, and may adopt operational procedures and issue such orders consistent with this Article 27 as may be necessary in the execution of the Contract Dispute Resolution Board's functions, including, but not limited to, granting extensions of time to present or respond to submissions;

27.6.2 The **CCPO** or his/her designee; any designee shall have the requisite background to consider and resolve the merits of the dispute and shall not have participated personally and substantially in the particular matter that is the subject of the dispute or report to anyone who so participated; and

27.6.3 A person with appropriate expertise who is not an employee of the **City**. This person shall be selected by the presiding administrative law judge from a prequalified panel of individuals, established and administered by OATH with appropriate background to act as decision-makers in a dispute. Such individual may not have a contract or dispute with the **City** or be an officer or employee of any company or organization that does, or regularly represents persons, companies, or organizations having disputes with the **City**.

27.7 Petition to the Contract Dispute Resolution Board. In the event the claim has not been settled or adjusted by the **Comptroller** within the period provided in this Article 27, the **Contractor**, within thirty (30) **Days** thereafter, may petition the Contract Dispute Resolution Board to review the **Commissioner's** determination.

27.7.1 Form and Content of Petition by Contractor. The **Contractor** shall present its dispute to the Contract Dispute Resolution Board in the form of a petition, which shall

include (i) a brief written statement of the substance of the dispute, the amount of money, if any, claimed, and the reason(s) the **Contractor** contends the dispute was wrongly decided by the **Commissioner**; (ii) a copy of the written Decision of the **Commissioner**, (iii) copies of all materials submitted by the **Contractor** to the Agency; (iv) a copy of the written decision of the **Comptroller**, if any, and (v) copies of all correspondence with, or written material submitted by the **Contractor**, to the **Comptroller**. The **Contractor** shall concurrently submit four (4) complete sets of the Petition: one set to the City Corporation Counsel (Attn: Commercial and Real Estate Litigation Division) and three (3) sets to the Contract Dispute Resolution Board at OATH's offices with proof of service on the City Corporation Counsel. In addition, the **Contractor** shall submit a copy of the written statement of the substance of the dispute, cited in (i) above, to both the **Commissioner** and the **Comptroller**.

27.7.2 Agency Response. Within thirty (30) **Days** of its receipt of the Petition by the City Corporation Counsel, the **Agency** shall respond to the brief written statement of the **Contractor** and make available to the Contract Dispute Resolution Board all material it submitted to the **Commissioner** and **Comptroller**. Three (3) complete copies of the **Agency** response shall be provided to the Contract Dispute Resolution Board and one to the **Contractor**. Extensions of time for submittal of the **Agency** response shall be given as necessary upon a showing of good cause or, upon consent of the parties, for an initial period of up to thirty (30) **Days**.

27.7.3 Further Proceedings. The Contract Dispute Resolution Board shall permit the **Contractor** to present its case by submission of memoranda, briefs, and oral argument. The Contract Dispute Resolution Board shall also permit the **Agency** to present its case in response to the **Contractor** by submission of memoranda, briefs, and oral argument. If requested by the City Corporation Counsel, the **Comptroller** shall provide reasonable assistance in the preparation of the **Agency's** case. Neither the **Contractor** nor the **Agency** may support its case with any documentation or other material that was not considered by the **Comptroller**, unless requested by the Contract Dispute Resolution Board. The Contract Dispute Resolution Board, in its discretion, may seek such technical or other expert advice as it shall deem appropriate and may seek, on its own or upon application of a party, any such additional material from any party as it deems fit. The Contract Dispute Resolution Board, in its discretion, may combine more than one dispute between the parties for concurrent resolution.

27.7.4 Contract Dispute Resolution Board Determination. Within forty-five (45) **Days** of the conclusion of all written submissions and oral arguments, the Contract Dispute Resolution Board shall render a written decision resolving the dispute. In an unusually complex case, the Contract Dispute Resolution Board may render its decision in a longer period, not to exceed ninety (90) **Days**, and shall so advise the parties at the commencement of this period. The Contract Dispute Resolution Board's decision must be consistent with the terms of the **Contract**. Decisions of the Contract Dispute Resolution Board shall only resolve matters before the Contract Dispute Resolution Board and shall not have precedential effect with respect to matters not before the Contract Dispute Resolution Board.

27.7.5 Notification of Contract Dispute Resolution Board Decision. The Contract Dispute Resolution Board shall send a copy of its decision to the **Contractor**, the **ACCO**, the Engineer, the **Comptroller**, the City Corporation Counsel, the **CCPO**, and the **PPB**. A decision in favor of the **Contractor** shall be subject to the prompt payment provisions of the **PPB Rules**. The Required Payment Date shall be thirty (30) **Days** after the date the parties are formally notified of the Contract Dispute Resolution Board's decision.

27.7.6 Finality of Contract Dispute Resolution Board Decision. The Contract Dispute Resolution

Board's decision shall be final and binding on all parties. Any party may seek review of the Contract Dispute Resolution Board's decision solely in the form of a challenge, filed within four (4) months of the date of the Contract Dispute Resolution Board's decision, in a court of competent jurisdiction of the State of New York, County of New York pursuant to Article 78 of the Civil Practice Law and Rules. Such review by the court shall be limited to the question of whether or not the Contract Dispute Resolution Board's decision was made in violation of lawful procedure, was affected by an error of Law, or was arbitrary and capricious or an abuse of discretion. No evidence or information shall be introduced or relied upon in such proceeding that was not presented to the Contract Dispute Resolution Board in accordance with this Article 27.

27.8 Any termination, cancellation, or alleged breach of the Contract prior to or during the pendency of any proceedings pursuant to this Article 27 shall not affect or impair the ability of the Commissioner or Contract Dispute Resolution Board to make a binding and final decision pursuant to this Article 27.

ARTICLE 28. RECORD KEEPING FOR EXTRA OR DISPUTED WORK OR WORK ON A TIME & MATERIALS BASIS

28.1 While the Contractor or any of its Subcontractors is performing Work on a time and material basis or Extra Work on a time and material basis ordered by the Commissioner under Article 25, or where the Contractor believes that it or any of its Subcontractors is performing Extra Work but a final determination by Agency has not been made, or the Contractor or any of its Subcontractors is performing disputed Work (whether on or off the Site), or complying with a determination or order under protest in accordance with Articles 11, 27, and 30, in each such case the Contractor shall furnish the Resident Engineer daily with three (3) copies of written statements signed by the Contractor's representative at the Site showing:

28.1.1 The name, trade, and number of each worker employed on such Work or engaged in complying with such determination or order, the number of hours employed, and the character of the Work each is doing; and

28.1.2 The nature and quantity of any materials, plant and equipment furnished or used in connection with the performance of such Work or compliance with such determination or order, and from whom purchased or rented.

28.2 A copy of such statement will be countersigned by the Resident Engineer, noting thereon any items not agreed to or questioned, and will be returned to the Contractor within two (2) Days after submission.

28.3 The Contractor and its Subcontractors, when required by the Commissioner, or the Comptroller, shall also produce for inspection, at the office of the Contractor or Subcontractor, any and all of its books, bid documents, financial statements, vouchers, records, daily job diaries and reports, and cancelled checks, and any other documents relating to showing the nature and quantity of the labor, materials, plant and equipment actually used in the performance of such Work, or in complying with such determination or order, and the amounts expended therefor, and shall permit the Commissioner and the Comptroller to make such extracts therefrom, or copies thereof, as they or either of them may desire.

28.4 In connection with the examination provided for herein, the Commissioner, upon demand therefor, will produce for inspection by the Contractor such records as the Agency may have with

respect to such **Extra Work** or disputed **Work** performed under protest pursuant to order of the **Commissioner**, except those records and reports which may have been prepared for the purpose of determining the accuracy and validity of the **Contractor's** claim.

28.5 Failure to comply strictly with these requirements shall constitute a waiver of any claim for extra compensation or damages on account of the performance of such **Work** or compliance with such determination or order.

ARTICLE 29. OMITTED WORK

29.1 If any **Contract Work** in a lump sum **Contract**, or if any part of a lump sum item in a unit price, lump sum, or percentage-bid **Contract** is omitted by the **Commissioner** pursuant to Article 33, the **Contract** price, subject to audit by the EAO, shall be reduced by a pro rata portion of the lump sum bid amount based upon the percent of **Work** omitted subject to Article 29.4. For the purpose of determining the pro rata portion of the lump sum bid amount, the bid breakdown submitted in accordance with Article 41 shall be considered, but shall not be the determining factor.

29.2 If the whole of a lump sum item or units of any other item is so omitted by the **Commissioner** in a unit price, lump sum, or percentage-bid **Contract**, then no payment will be made therefor except as provided in Article 29.4.

29.3 For units that have been ordered but are only partially completed, the unit price shall be reduced by a pro rata portion of the unit price bid based upon the percentage of **Work** omitted subject to Article 29.4.

29.4 In the event the **Contractor**, with respect to any omitted **Work**, has purchased any non-cancelable material and/or equipment that is not capable of use except in the performance of this **Contract** and has been specifically fabricated for the sole purpose of this **Contract**, but not yet incorporated into the **Work**, the **Contractor** shall be paid for such material and/or equipment in accordance with Article 64.2.1(b); provided, however, such payment is contingent upon the **Contractor's** delivery of such material and/or equipment in acceptable condition to a location designated by the **City**.

29.5 The **Contractor** agrees to make no claim for damages or for loss of overhead and profit with regard to any omitted **Work**.

ARTICLE 30. NOTICE AND DOCUMENTATION OF COSTS AND DAMAGES; PRODUCTION OF FINANCIAL RECORDS

30.1 If the **Contractor** shall claim to be sustaining damages by reason of any act or omission of the **City** or its agents, it shall submit to the **Commissioner** within forty-five (45) **Days** from the time such damages are first incurred, and every thirty (30) **Days** thereafter for as long as such damages are incurred, verified statements of the details and the amounts of such damages, together with documentary evidence of such damages. The **Contractor** may submit any of the above statements within such additional time as may be granted by the **Commissioner** in writing upon written request therefor. Failure of the **Commissioner** to respond in writing to a written request for additional time within thirty (30) **Days** shall be deemed a denial of the request. On failure of the **Contractor** to strictly comply with the foregoing provisions, such claims shall be deemed waived and no right to recover on such claims shall exist. Damages that the **Contractor** may claim in any action or dispute resolution procedure arising under or by reason of this **Contract** shall not be different from or in excess of the statements and documentation made pursuant to this Article 30.

30.2 In addition to the foregoing statements, the **Contractor** shall, upon notice from the **Commissioner**, produce for examination at the **Contractor's** office, by the **Engineer, Architect or Project Manager**, all of its books of account, bills, invoices, payrolls, subcontracts, time books, daily reports, bank deposit books, bank statements, check books, and cancelled checks, showing all of its acts and transactions in connection with or relating to or arising by reason of this **Contract**, and submit itself and persons in its employment, for examination under oath by any person designated by the **Commissioner** or **Comptroller** to investigate claims made or disputes against the **City** under this **Contract**. At such examination, a duly authorized representative of the **Contractor** may be present.

30.3 In addition to the statements required under Article 28 and this Article 30, the **Contractor** and/or its **Subcontractor** shall, within thirty (30) **Days** upon notice from the **Commissioner** or **Comptroller**, produce for examination at the **Contractor's** and/or **Subcontractor's** office, by a representative of either the **Commissioner** or **Comptroller**, all of its books of account, bid documents, financial statements, accountant workpapers, bills, invoices, payrolls, subcontracts, time books, daily reports, bank deposit books, bank statements, check books, and cancelled checks, showing all of its acts and transactions in connection with or relating to or arising by reason of this **Contract**. Further, the **Contractor** and/or its **Subcontractor** shall submit any person in its employment, for examination under oath by any person designated by the **Commissioner** or **Comptroller** to investigate claims made or disputes against the **City** under this **Contract**. At such examination, a duly authorized representative of the **Contractor** may be present.

30.4 Unless the information and examination required under Article 30.3 is provided by the **Contractor** and/or its **Subcontractor** upon thirty (30) **Days'** notice from the **Commissioner** or **Comptroller**, or upon the **Commissioner's** or **Comptroller's** written authorization to extend the time to comply, the **City** shall be released from all claims arising under, relating to or by reason of this **Contract**, except for sums certified by the **Commissioner** to be due under the provisions of this **Contract**. It is further stipulated and agreed that no person has the power to waive any of the foregoing provisions and that in any action or dispute resolution procedure against the **City** to recover any sum in excess of the sums certified by the **Commissioner** to be due under or by reason of this **Contract**, the **Contractor** must allege in its complaint and prove, at trial or during such dispute resolution procedure, compliance with the provisions of this Article 30.

30.5 In addition, after the commencement of any action or dispute resolution procedure by the **Contractor** arising under or by reason of this **Contract**, the **City** shall have the right to require the **Contractor** to produce for examination under oath, up until the trial of the action or hearing before the Contract Dispute Resolution Board, the books and documents described in Article 30.3 and submit itself and all persons in its employ for examination under oath. If this Article 30 is not complied with as required, then the **Contractor** hereby consents to the dismissal of the action or dispute resolution procedure.

CHAPTER VII
POWERS OF THE RESIDENT ENGINEER,
THE ENGINEER OR ARCHITECT AND THE COMMISSIONER

ARTICLE 31. THE RESIDENT ENGINEER

31.1 The **Resident Engineer** shall have the power to inspect, supervise, and control the performance of the **Work**, subject to review by the **Commissioner**. The **Resident Engineer** shall not, however, have the power to issue an **Extra Work** order, except as specifically designated in writing by the **Commissioner**.

ARTICLE 32. THE ENGINEER OR ARCHITECT OR PROJECT MANAGER

32.1 The **Engineer or Architect or Project Manager**, in addition to those matters elsewhere herein delegated to the **Engineer** and expressly made subject to his/her determination, direction or approval, shall have the power, subject to review by the **Commissioner**:

32.1.1 To determine the amount, quality, and location of the **Work** to be paid for hereunder; and

32.1.2 To determine all questions in relation to the **Work**, to interpret the **Contract Drawings, Specifications, and Addenda**, and to resolve all patent inconsistencies or ambiguities therein; and

32.1.3 To determine how the **Work** of this **Contract** shall be coordinated with **Work** of **Other Contractors** engaged simultaneously on this **Project**, including the power to suspend any part of the **Work**, but not the whole thereof; and

32.1.4 To make minor changes in the **Work** as he/she deems necessary, provided such changes do not result in a net change in the cost to the **City** or to the **Contractor** of the **Work** to be done under the **Contract**; and

32.1.5 To amplify the **Contract Drawings**, add explanatory information and furnish additional **Specifications** and drawings, consistent with this **Contract**.

32.2 The foregoing enumeration shall not imply any limitation upon the power of the **Engineer or Architect or Project Manager**, for it is the intent of this **Contract** that all of the **Work** shall generally be subject to his/her determination, direction, and approval, except where the determination, direction or approval of someone other than the **Engineer or Architect or Project Manager** is expressly called for herein.

32.3 The **Engineer or Architect or Project Manager** shall not, however, have the power to issue an **Extra Work** order, except as specifically designated in writing by the **Commissioner**.

ARTICLE 33. THE COMMISSIONER

33.1 The **Commissioner**, in addition to those matters elsewhere herein expressly made subject to his/her determination, direction or approval, shall have the power:

33.1.1 To review and make determinations on any and all questions in relation to this **Contract** and its performance; and

33.1.2 To modify or change this **Contract** so as to require the performance of **Extra Work** (subject, however, to the limitations specified in Article 25) or the omission of **Contract Work**; and

33.1.3 To suspend the whole or any part of the **Work** whenever in his/her judgment such suspension is required:

33.1.3(a) In the interest of the **City** generally; or

33.1.3(b) To coordinate the **Work** of the various contractors engaged on this **Project** pursuant to the provisions of Article 12; or

33.1.3(c) To expedite the completion of the entire **Project** even though the completion of this particular **Contract** may thereby be delayed.

ARTICLE 34. NO ESTOPPEL

34.1 Neither the **City** nor any **Agency**, official, agent or employee thereof, shall be bound, precluded or estopped by any determination, decision, approval, order, letter, payment or certificate made or given under or in connection with this **Contract** by the **City**, the **Commissioner**, the **Engineer**, the **Resident Engineer**, or any other official, agent or employee of the **City**, either before or after the final completion and acceptance of the **Work** and payment therefor:

34.1.1 From showing the true and correct classification, amount, quality or character of the **Work** actually done; or that any such determination, decision, order, letter, payment or certificate was untrue, incorrect or improperly made in any particular, or that the **Work**, or any part thereof, does not in fact conform to the requirements of this **Contract**; and

34.1.2 From demanding and recovering from the **Contractor** any overpayment made to it, or such damages as the **City** may sustain by reason of the **Contractor's** failure to perform each and every part of its **Contract**.

CHAPTER VIII LABOR PROVISIONS

ARTICLE 35. EMPLOYEES

35.1 The **Contractor** and its **Subcontractors** shall not employ on the **Work**:

35.1.1 Anyone who is not competent, faithful and skilled in the **Work** for which he/she shall be employed; and whenever the **Commissioner** shall inform the **Contractor**, in writing, that any employee is, in his/her opinion, incompetent, unfaithful or disobedient, that employee shall be discharged from the **Work** forthwith, and shall not again be employed upon it; or

35.1.2 Any labor, materials or means whose employment, or utilization during the course of this **Contract**, may tend to or in any way cause or result in strikes, work stoppages, delays, suspension of **Work** or similar troubles by workers employed by the **Contractor** or its **Subcontractors**, or by any of the trades working in or about the buildings and premises where **Work** is being performed under this **Contract**, or by **Other Contractors** or their **Subcontractors** pursuant to other contracts, or on any other building or premises owned or operated by the **City**, its **Agencies**, departments, boards or authorities. Any violation by the **Contractor** of this requirement may, upon certification of the **Commissioner**, be considered as proper and sufficient cause for declaring the **Contractor** to be in default, and for the **City** to take action against it as set forth in Chapter X of this **Contract**, or such other article of this **Contract** as the **Commissioner** may deem proper; or

35.1.3 In accordance with Section 220.3-e of the Labor Law of the State of New York (hereinafter "Labor Law"), the **Contractor** and its **Subcontractors** shall not employ on the **Work** any apprentice, unless he/she is a registered individual, under a bona fide program

registered with the New York State Department of Labor. The allowable ratio of apprentices to journey-level workers in any craft classification shall not be greater than the ratio permitted to the **Contractor** as to its work force on any job under the registered program. Any employee listed on a payroll at an apprentice wage rate, who is not registered as above, shall be paid the wage rate determined by the **Comptroller** of the **City** for the classification of **Work** actually performed. The **Contractor** or **Subcontractor** will be required to furnish written evidence of the registration of its program and apprentices as well as all the appropriate ratios and wage rates, for the area of the construction prior to using any apprentices on the **Contract Work**.

35.2 If the total cost of the **Work** under this **Contract** is at least two hundred fifty thousand (\$250,000) dollars, all laborers, workers, and mechanics employed in the performance of the **Contract** on the public work site, either by the **Contractor**, **Subcontractor** or other person doing or contracting to do the whole or a part of the **Work** contemplated by the **Contract**, shall be certified prior to performing any **Work** as having successfully completed a course in construction safety and health approved by the United States Department of Labor's Occupational Safety and Health Administration that is at least ten (10) hours in duration.

35.3 In accordance with Local Law Nos. 30-2012 and 33-2012, codified at sections 6-132 and 12-113 of the Administrative Code, respectively,

35.3.1 The **Contractor** shall not take an adverse personnel action with respect to an officer or employee in retaliation for such officer or employee making a report of information concerning conduct which such officer or employee knows or reasonably believes to involve corruption, criminal activity, conflict of interest, gross mismanagement or abuse of authority by any officer or employee relating to this **Contract** to (a) the Commissioner of the Department of Investigation, (b) a member of the New York City Council, the Public Advocate, or the **Comptroller**, or (c) the **CCPO**, **ACCO**, **Agency head**, or **Commissioner**.

35.3.2 If any of the **Contractor's** officers or employees believes that he or she has been the subject of an adverse personnel action in violation of Article 35.3.1, he or she shall be entitled to bring a cause of action against the **Contractor** to recover all relief necessary to make him or her whole. Such relief may include but is not limited to: (a) an injunction to restrain continued retaliation, (b) reinstatement to the position such employee would have had but for the retaliation or to an equivalent position, (c) reinstatement of full fringe benefits and seniority rights, (d) payment of two times back pay, plus interest, and (e) compensation for any special damages sustained as a result of the retaliation, including litigation costs and reasonable attorney's fees.

35.3.3 The **Contractor** shall post a notice provided by the **City** in a prominent and accessible place on any site where work pursuant to the **Contract** is performed that contains information about:

35.3.3(a) how its employees can report to the New York City Department of Investigation allegations of fraud, false claims, criminality or corruption arising out of or in connection with the **Contract**; and

35.3.3(b) the rights and remedies afforded to its employees under Administrative Code sections 7-805 (the New York City False Claims Act) and 12-113 (the Whistleblower Protection Expansion Act) for lawful acts taken in connection with the reporting of allegations of fraud, false claims, criminality or corruption in connection with the **Contract**.

35.3.4 For the purposes of this Article 35.3, "adverse personnel action" includes dismissal, demotion, suspension, disciplinary action, negative performance evaluation, any action resulting in loss of staff, office space, equipment or other benefit, failure to appoint, failure to promote, or any transfer or assignment or failure to transfer or assign against the wishes of the affected officer or employee.

35.3.5 This Article 35.3 is applicable to all of the **Contractor's Subcontractors** having subcontracts with a value in excess of \$100,000; accordingly, the **Contractor** shall include this rider in all subcontracts with a value a value in excess of \$100,000.

35.4 Article 35.3 is not applicable to this **Contract** if it is valued at \$100,000 or less. Articles 35.3.1, 35.3.2, 35.3.4, and 35.3.5 are not applicable to this **Contract** if it was solicited pursuant to a finding of an emergency.

ARTICLE 36. NO DISCRIMINATION

36.1 The **Contractor** specifically agrees, as required by Labor Law Section 220-e, as amended, that:

36.1.1 In the hiring of employees for the performance of **Work** under this **Contract** or any subcontract hereunder, neither the **Contractor**, **Subcontractor**, nor any person acting on behalf of such **Contractor** or **Subcontractor**, shall by reason of race, creed, color or national origin discriminate against any citizen of the State of New York who is qualified and available to perform the **Work** to which the employment relates;

36.1.2 Neither the **Contractor**, **Subcontractor**, nor any person on its behalf shall, in any manner, discriminate against or intimidate any employee hired for the performance of **Work** under this **Contract** on account of race, creed, color or national origin;

36.1.3 There may be deducted from the amount payable to the **Contractor** by the **City** under this **Contract** a penalty of fifty (\$50.00) dollars for each person for each **Day** during which such person was discriminated against or intimidated in violation of the provisions of this **Contract**; and

36.1.4 This **Contract** may be cancelled or terminated by the **City** and all moneys due or to become due hereunder may be forfeited, for a second or any subsequent violation of the terms or conditions of this Article 36.

36.1.5 This Article 36 covers all construction, alteration and repair of any public building or public work occurring in the State of New York and the manufacture, sale, and distribution of materials, equipment, and supplies to the extent that such operations are performed within the State of New York pursuant to this **Contract**.

36.2 The **Contractor** specifically agrees, as required by Section 6-108 of the Administrative Code, as amended, that:

36.2.1 It shall be unlawful for any person engaged in the construction, alteration or repair of buildings or engaged in the construction or repair of streets or highways pursuant to a **Contract** with the **City** or engaged in the manufacture, sale or distribution of materials, equipment or supplies pursuant to a **Contract** with the **City** to refuse to employ or to refuse to continue in any employment any person on account of the race, color or creed of such person.

36.2.2 It shall be unlawful for any person or any servant, agent or employee of any person, described in Article 36.1.2, to ask, indicate or transmit, orally or in writing, directly or indirectly, the race, color or creed or religious affiliation of any person employed or seeking employment from such person, firm or corporation.

36.2.3 Breach of the foregoing provisions shall be deemed a violation of a material provision of this **Contract**.

36.2.4 Any person, or the employee, manager or owner of or officer of such firm or corporation who shall violate any of the provisions of this Article 36.2 shall, upon conviction thereof, be punished by a fine of not more than one hundred (\$100.00) dollars or by imprisonment for not more than thirty (30) **Days**, or both.

36.3 This **Contract** is subject to the requirements of Executive Order No. 50 (1980) ("E.O. 50"), as revised, and the rules and regulations promulgated thereunder. No contract will be awarded unless and until these requirements have been complied with in their entirety. By signing this **Contract**, the **Contractor** agrees that it:

36.3.1 Will not engage in any unlawful discrimination against any employee or applicant for employment because of race, creed, color, national origin, sex, age, disability, marital status or sexual orientation with respect to all employment decisions including, but not limited to, recruitment, hiring, upgrading, demotion, downgrading, transfer, training, rates of pay or other forms of compensation, layoff, termination, and all other terms and conditions of employment; and

36.3.2 Will not engage in any unlawful discrimination in the selection of **Subcontractors** on the basis of the owner's race, color, creed, national origin, sex, age, disability, marital status or sexual orientation; and

36.3.3 Will state in all solicitations or advertisements for employees placed by or on behalf of the **Contractor** that all qualified applicants will receive consideration for employment without unlawful discrimination based on race, creed, color, national origin, sex, age, citizens status, disability, marital status, sexual orientation, or that it is an equal employment opportunity employer; and

36.3.4 Will send to each labor organization or representative of workers with which it has a collective bargaining agreement or other contract or memorandum of understanding, written notification of its equal employment opportunity commitments under E.O. 50 and the rules and regulations promulgated thereunder; and

36.3.5 Will furnish, before the award of the **Contract**, all information and reports, including an employment report, that are required by E.O. 50, the rules and regulations promulgated thereunder, and orders of the City Department of Business Services, Division of Labor Services (**DLS**) and will permit access to its books, records, and accounts by the **DLS** for the purposes of investigation to ascertain compliance with such rules, regulations, and orders.

36.4 The **Contractor** understands that in the event of its noncompliance with the nondiscrimination clauses of this **Contract** or with any of such rules, regulations, or orders, such noncompliance shall constitute a material breach of this **Contract** and noncompliance with E.O. 50 and the rules and regulations promulgated thereunder. After a hearing held pursuant to the rules of the **DLS**, the Director of the **DLS** may direct the **Commissioner** to impose any or all of the following sanctions:

36.4.1 Disapproval of the **Contractor**; and/or

36.4.2 Suspension or termination of the **Contract**; and/or

36.4.3 Declaring the **Contractor** in default; and/or

36.4.4 In lieu of any of the foregoing sanctions, the Director of the **DLS** may impose an employment program.

In addition to any actions taken under this **Contract**, failure to comply with E.O. 50 and the rules and regulations promulgated thereunder, in one or more instances, may result in a **City Agency** declaring the **Contractor** to be non-responsible in future procurements. The **Contractor** further agrees that it will refrain from entering into any **Contract** or **Contract** modification subject to E.O. 50 and the rules and regulations promulgated thereunder with a **Subcontractor** who is not in compliance with the requirements of E.O. 50 and the rules and regulations promulgated thereunder.

36.5 The **Contractor** specifically agrees, as required by Section 6-123 of the Administrative Code, that:

36.5.1 The **Contractor** will not engage in any unlawful discriminatory practice in violation of Title 8 of the Administrative Code; and

36.5.2 Any failure to comply with this Article 36.5 may subject the **Contractor** to the remedies set forth in Section 6-123 of the Administrative Code, including, where appropriate, sanctions such as withholding of payment, imposition of an employment program, finding the **Contractor** to be in default, cancellation of the **Contract**, or any other sanction or remedy provided by **Law** or **Contract**.

ARTICLE 37. LABOR LAW REQUIREMENTS

37.1 The **Contractor** shall strictly comply with all applicable provisions of the Labor Law, as amended. Such compliance is a material term of this **Contract**.

37.2 The **Contractor** specifically agrees, as required by Labor Law Sections 220 and 220-d, as amended, that:

37.2.1 **Hours of Work:** No laborer, worker, or mechanic in the employ of the **Contractor**, **Subcontractor** or other person doing or contracting to do the whole or a part of the **Work** contemplated by this **Contract** shall be permitted or required to work more than eight (8) hours in any one (1) **Day**, or more than five (5) **Days** in any one (1) week, except as provided in the Labor Law and in cases of extraordinary emergency including fire, flood, or danger to life or property, or in the case of national emergency when so proclaimed by the President of the United States of America.

37.2.2 In situations in which there are not sufficient laborers, workers, and mechanics who may be employed to carry on expeditiously the **Work** contemplated by this **Contract** as a result of such restrictions upon the number of hours and **Days** of labor, and the immediate commencement or prosecution or completion without undue delay of the **Work** is necessary for the preservation of the **Site** and/or for the protection of the life and limb of the persons using the same, such laborers, workers, and mechanics shall be permitted or required to

work more than eight (8) hours in any one (1) **Day**; or five (5) **Days** in any one (1) week; provided, however, that upon application of any **Contractor**, the **Commissioner** shall have first certified to the Commissioner of Labor of the State of New York (hereinafter "Commissioner of Labor") that such public **Work** is of an important nature and that a delay in carrying it to completion would result in serious disadvantage to the public; and provided, further, that such Commissioner of Labor shall have determined that such an emergency does in fact exist as provided in Labor Law Section 220.2.

37.2.3 Failure of the **Commissioner** to make such a certification to the Commissioner of Labor shall not entitle the **Contractor** to damages for delay or for any cause whatsoever.

37.2.4 Prevailing Rate of Wages: The wages to be paid for a legal day's **Work** to laborers, workers, or mechanics employed upon the **Work** contemplated by this **Contract** or upon any materials to be used thereon shall not be less than the "prevailing rate of wage" as defined in Labor Law Section 220, and as fixed by the **Comptroller** in the attached Schedule of Wage Rates and in updated schedules thereof. The prevailing wage rates and supplemental benefits to be paid are those in effect at the time the **Work** is being performed.

37.2.5 Requests for interpretation or correction in the Information for Bidders includes all requests for clarification of the classification of trades to be employed in the performance of the **Work** under this **Contract**. In the event that a trade not listed in the **Contract** is in fact employed during the performance of this **Contract**, the **Contractor** shall be required to obtain from the **Agency** the prevailing wage rates and supplementary benefits for the trades used and to complete the performance of this **Contract** at the price at which the **Contract** was awarded.

37.2.6 Minimum Wages: Except for employees whose wage is required to be fixed pursuant to Labor Law Section 220, all persons employed by the **Contractor** and any **Subcontractor** in the manufacture or furnishing of the supplies, materials, or equipment, or the furnishing of work, labor, or services, used in the performance of this **Contract**, shall be paid, without subsequent deduction or rebate unless expressly authorized by **Law**, not less than the sum mandated by **Law**.

37.3 Working Conditions: No part of the **Work**, labor or services shall be performed or rendered by the **Contractor** in any plants, factories, buildings or surroundings or under working conditions which are unsanitary or hazardous or dangerous to the health and safety of employees engaged in the performance of this **Contract**. Compliance with the safety, sanitary, and factory inspection **Laws** of the state in which the **Work** is to be performed shall be prima facie evidence of compliance with this Article 37.3.

37.4 Prevailing Wage Enforcement: The **Contractor** agrees to pay for all costs incurred by the **City** in enforcing prevailing wage requirements, including the cost of any investigation conducted by or on behalf of the **Agency** or the **Comptroller**, where the **City** discovers a failure to comply with any of the requirements of this Article 37 by the **Contractor** or its **Subcontractor(s)**. The **Contractor** also agrees that, should it fail or refuse to pay for any such investigation, the **Agency** is hereby authorized to deduct from a **Contractor's** account an amount equal to the cost of such investigation.

37.4.1 The Labor Law Section 220 and Section 220-d, as amended, provide that this **Contract** shall be forfeited and no sum paid for any **Work** done hereunder on a second conviction for willfully paying less than:

37.4.1(a) The stipulated prevailing wage scale as provided in Labor Law section 220, as amended, or

37.4.1(b) The stipulated minimum hourly wage scale as provided in Labor Law section 220-d, as amended.

37.4.2 For any breach or violation of either working conditions (Article 37.3) or minimum wages (Article 37.2.6) provisions, the party responsible therefor shall be liable to the City for liquidated damages, which may be withheld from any amounts due on any contracts with the City of such party responsible, or may be recovered in actions brought by the City Corporation Counsel in the name of the City, in addition to damages for any other breach of this Contract, for a sum equal to the amount of any underpayment of wages due to any employee engaged in the performance of this Contract. In addition, the Commissioner shall have the right to cancel contracts and enter into other contracts for the completion of the original contract, with or without public letting, and the original Contractor shall be liable for any additional cost. All sums withheld or recovered as deductions, rebates, refunds, or underpayment of wages hereunder, shall be held in a special deposit account and shall be paid without interest, on order of the Comptroller, directly to the employees who have been paid less than minimum rates of pay as set forth herein and on whose account such sums were withheld or recovered, provided that no claims by employees for such payments shall be entertained unless made within two (2) years from the date of actual notice to the Contractor of the withholding or recovery of such sums by the City.

37.4.3 A determination by the Comptroller that a Contractor and/or its Subcontractor willfully violated Labor Law Section 220 will be forwarded to the City's five District Attorneys for review.

37.4.4 The Contractor's or Subcontractor's noncompliance with this Article 37.4 and Labor Law Section 220 may result in an unsatisfactory performance evaluation and the Comptroller may also find and determine that the Contractor or Subcontractor willfully violated the New York Labor Law.

37.4.4(a) An unsatisfactory performance evaluation for noncompliance with this Article 37.4 may result in a determination that the Contractor is a non-responsible bidder on subsequent procurements with the City and thus a rejection of a future award of a contract with the City, as well as any other sanctions provided for by Law.

37.4.4(b) Labor Law Section 220-b, as amended, provides that when two (2) final determinations have been rendered against a Contractor or Subcontractor within any consecutive six (6) year period determining that such Contractor or Subcontractor has willfully failed to pay the prevailing rate of wages or to provide supplements in accordance with the Labor Law and this Article 37.4, whether such failures were concurrent or consecutive and whether or not such final determinations concerning separate public works projects are rendered simultaneously, such Contractor or Subcontractor shall be ineligible to submit a bid on or be awarded any public works contract with the City for a period of five (5) years from the second final determination. If the final determination involves the falsification of payroll records or the kickback of wages or supplements, the Contractor or Subcontractor shall be ineligible to submit a bid on or be awarded any public works contract with the City for a period of five (5) years from the first final determination.

37.4.4(c) Labor Law Section 220, as amended, provides that the Contractor or Subcontractor found to have violated this Article 37.4 may be directed to make payment of wages or supplements including interest found to be due, and the Contractor or Subcontractor may be directed to make payment of a further sum as

a civil penalty in an amount not exceeding twenty-five (25%) percent of the total amount found to be due.

37.5 The **Contractor** and its **Subcontractors** shall within ten (10) **Days** after mailing of a Notice of Award or written order, post in prominent and conspicuous places in each and every plant, factory, building, and structure where employees of the **Contractor** and its **Subcontractors** engaged in the performance of this **Contract** are employed, notices furnished by the **City**, in relation to prevailing wages and supplements, minimum wages, and other stipulations contained in Sections 220 and 220-h of the Labor Law, and the **Contractor** and its **Subcontractors** shall continue to keep such notices posted in such prominent and conspicuous places until **Final Acceptance** of the supplies, materials, equipment, or **Work**, labor, or services required to be furnished or rendered under this **Contract**.

37.6 The **Contractor** shall strictly comply with all of the provisions of Articles 37.6.1 through 37.6.5, and provide for all workers, laborers or mechanics in its employ, the following:

37.6.1 **Notices Posted At Site:** Post, in a location designated by the **City**, schedules of prevailing wages and supplements for this **Project**, a copy of all re-determinations of such schedules for the **Project**, the Workers' Compensation Law Section 51 notice, all other notices required by Law to be posted at the **Site**, the **City** notice that this **Project** is a public works project on which each worker is entitled to receive the prevailing wages and supplements for the occupation at which he or she is working, and all other notices which the **City** directs the **Contractor** to post. The **Contractor** shall provide a surface for such notices which is satisfactory to the **City**. The **Contractor** shall maintain and keep current such notices in a legible manner and shall replace any notice or schedule which is damaged, defaced, illegible or removed for any reason. The **Contractor** shall post such notices before commencing any **Work** on the **Site** and shall maintain such notices until all **Work** on the **Site** is complete; and

37.6.2 **Daily Site Sign-in Sheets:** Maintain daily **Site** sign-in sheets, and require that **Subcontractors** maintain daily **Site** sign-in sheets for its employees, which include blank spaces for an employee's name to be both printed and signed, job title, date started and Social Security number, the time the employee began work and the time the employee left work, until **Final Acceptance** of the supplies, materials, equipment, or **Work**, labor, or services to be furnished or rendered under this **Contract** unless exception is granted by the **Comptroller** upon application by the **Agency**. In the alternative, subject to the approval of the **CCPO**, the **Contractor** and **Subcontractor** may maintain an electronic or biometric sign-in system, which provides the information required by this Article 37.6.2; and

37.6.3 **Individual Employee Information Notices:** Distribute a notice to each worker, laborer or mechanic employed under this **Contract**, in a form provided by the **Agency**, that this **Project** is a public works project on which each worker, laborer or mechanic is entitled to receive the prevailing rate of wages and supplements for the occupation at which he or she is working. If the total cost of the **Work** under this **Contract** is at least two hundred fifty thousand (\$250,000) dollars, such notice shall also include a statement that each worker, laborer or mechanic must be certified prior to performing any **Work** as having successfully completed a course in construction safety and health approved by the United States Department of Labor's Occupational Safety and Health Administration that is at least ten (10) hours in duration. Such notice shall be distributed to each worker before he or she starts performing any **Work** of this **Contract** and with the first paycheck after July first of each year. "Worker, laborer or mechanic" includes employees of the **Contractor** and all **Subcontractors** and all employees of suppliers entering the **Site**. At the time of distribution, the **Contractor** shall have each worker, laborer or mechanic sign a statement, in a form provided by the **Agency**, certifying that the worker has received the notice required by this

Article 37.6.3, which signed statement shall be maintained with the payroll records required by this **Contract**; and

37.6.3(a) The **Contractor** and each **Subcontractor** shall notify each worker, laborer or mechanic employed under this **Contract** in writing of the prevailing rate of wages for their particular job classification. Such notification shall be given to every worker, laborer, and mechanic on their first pay stub and with every pay stub thereafter; and

37.6.4 **Site Laminated Identification Badges:** The **Contractor** shall provide laminated identification badges which include a photograph of the worker's, laborer's or mechanic's face and indicate the worker's, laborer's or mechanic's name, trade, employer's name, and employment starting date (month/day/year). Further, the **Contractor** shall require as a condition of employment on the **Site**, that each and every worker, laborer or mechanic wear the laminated identification badge at all times and that it may be seen by any representative of the **City**. The **Commissioner** may grant a written waiver from the requirement that the laminated identification badge include a photograph if the **Contractor** demonstrates that the identity of an individual wearing a laminated identification badge can be easily verified by another method; and

37.6.5 **Language Other Than English Used On Site:** Provide the **ACCO** notice when three (3) or more employees (worker and/or laborer and/or mechanic) on the **Site**, at any time, speak a language other than English. The **ACCO** will then provide the **Contractor** the notices described in Article 37.6.1 in that language or languages as may be required. The **Contractor** is responsible for all distributions under this Article 37; and

37.6.6 **Provision of Records:** The **Contractor** and **Subcontractor(s)** shall produce within five (5) **Days** on the **Site** of the **Work** and upon a written order of the **Engineer**, the **Commissioner**, the **ACCO**, the **Agency EAO**, or the **Comptroller**, such records as are required to be kept by this Article 37.6; and

37.6.7 The **Contractor** and **Subcontractor(s)** shall pay employees by check or direct deposit. If this **Contract** is for an amount greater than one million (\$1,000,000) dollars, checks issued by the **Contractor** to covered employees shall be generated by a payroll service or automated payroll system (an in-house system may be used if approved by the **Agency**). For any subcontract for an amount greater than seven hundred fifty thousand (\$750,000) dollars, checks issued by a **Subcontractor** to covered employees shall be generated by a payroll service or automated payroll system (an in-house system may be used if approved by the **Agency**); and

37.6.8 The failure of the **Contractor** or **Subcontractor(s)** to comply with the provisions of Articles 37.6.1 through 37.6.7 may result in the **Commissioner** declaring the **Contractor** in default and/or the withholding of payments otherwise due under the **Contract**.

37.7 The **Contractor** and its **Subcontractors** shall keep such employment and payroll records as are required by Section 220 of the Labor Law. The failure of the **Contractor** or **Subcontractor(s)** to comply with the provisions of this Article 37.7 may result in the **Commissioner** declaring the **Contractor** in default and/or the withholding of payments otherwise due under the **Contract**.

37.8 At the time the **Contractor** makes application for each partial payment and for final payment, the **Contractor** shall submit to the **Commissioner** a written payroll certification, in the form provided by this **Contract**, of compliance with the prevailing wage, minimum wage, and other provisions and stipulations required by Labor Law Section 220 and of compliance with the training requirements of

Labor Law Section 220-h set forth in Article 35.2. This certification of compliance shall be a condition precedent to payment and no payment shall be made to the **Contractor** unless and until each such certification shall have been submitted to and received by the **Commissioner**.

37.9 This **Contract** is executed by the **Contractor** with the express warranty and representation that the **Contractor** is not disqualified under the provisions of Section 220 of the Labor Law from the award of the **Contract**.

37.10 Any breach or violation of any of the foregoing shall be deemed a breach or violation of a material provision of this **Contract**, and grounds for cancellation thereof by the **City**.

ARTICLE 38. PAYROLL REPORTS

38.1 The **Contractor** and its **Subcontractor(s)** shall maintain on the **Site** during the performance of the **Work** the original payrolls or transcripts thereof which the **Contractor** and its **Subcontractor(s)** are required to maintain and shall submit such original payrolls or transcripts, subscribed and affirmed by it as true, within thirty (30) **Days** after issuance of its first payroll, and every thirty (30) **Days** thereafter, pursuant to Labor Law Section 220(3-a)(a)(iii). The **Contractor** and **Subcontractor(s)** shall submit such original payrolls or transcripts along with each and every payment requisition. If payment requisitions are not submitted at least once a month, the **Contractor** and its **Subcontractor(s)** shall submit original payrolls and transcripts both along with its payment requisitions and independently of its payment requisitions.

38.2 The **Contractor** shall maintain payrolls or transcripts thereof for six (6) years from the date of completion of the **Work** on this **Contract**. If such payrolls and transcripts are maintained outside of New York City after the completion of the **Work** and their production is required pursuant to this Article 38, the **Contractor** shall produce such records in New York City upon request by the **City**.

38.3 The **Contractor** and **Subcontractor(s)** shall comply with any written order, direction, or request made by the **Engineer**, the **Commissioner**, the **ACCO**, the **Agency EAO**, the **Agency Labor Law Investigator(s)**, or the **Comptroller**, to provide to the requesting party any of the following information and/or records within five (5) **Days** of such written order, direction, or request:

38.3.1 Such original payrolls or transcripts thereof subscribed and affirmed by it as true and the statements signed by each worker pursuant to this Chapter VIII; and/or

38.3.2 Attendance sheets for each **Day** on which any employee of the **Contractor** and/or any of the **Subcontractor(s)** performed **Work** on the **Site**, which attendance sheet shall be in a form acceptable to the **Agency** and shall provide information acceptable to the **Agency** to identify each such employee; and/or

38.3.3 Any other information to satisfy the **Engineer**, the **Commissioner**, the **ACCO**, the **Agency EAO**, the **Agency Labor Law Investigator(s)** or the **Comptroller**, that this Chapter VIII and the Labor Law, as to the hours of employment and prevailing rates of wages and/or supplemental benefits, are being observed.

38.4 The failure of the **Contractor** or **Subcontractor(s)** to comply with the provisions of Articles 38.1 and/or 38.2 may result in the **Commissioner** declaring the **Contractor** in default and/or the withholding of payments otherwise due under the **Contract**.

ARTICLE 39. DUST HAZARDS

39.1 Should a harmful dust hazard be created in performing the **Work** of this **Contract**, for the elimination of which appliances or methods have been approved by the Board of Standards and Appeals of the City of New York, such appliances and methods shall be installed, maintained, and effectively operated during the continuance of such harmful dust hazard. Failure to comply with this provision after notice shall make this **Contract** voidable at the sole discretion of the **City**.

CHAPTER IX PARTIAL AND FINAL PAYMENTS

ARTICLE 40. CONTRACT PRICE

40.1 The **City** shall pay, and the **Contractor** agrees to accept, in full consideration for the **Contractor's** performance of the **Work** subject to the terms and conditions hereof, the lump sum price or unit prices for which this **Contract** was awarded, plus the amount required to be paid for any **Extra Work** ordered by the **Commissioner** under Article 25, less credit for any **Work** omitted pursuant to Article 29.

ARTICLE 41. BID BREAKDOWN ON LUMP SUM

41.1 Within fifteen (15) **Days** after the commencement date specified in the **Notice to Proceed** or **Order to Work**, unless otherwise directed by the **Resident Engineer**, the **Contractor** shall submit to the **Resident Engineer** a breakdown of its bid price, or of lump sums bid for items of the **Contract**, showing the various operations to be performed under the **Contract**, as directed in the progress schedule required under Article 9, and the value of each of such operations, the total of such items to equal the lump sum price bid. Said breakdown must be approved in writing by the **Resident Engineer**.

41.2 No partial payment will be approved until the **Contractor** submits a bid breakdown that is acceptable to the **Resident Engineer**.

41.3 The **Contractor** shall also submit such other information relating to the bid breakdown as directed by the **Resident Engineer**. Thereafter, the breakdown may be used only for checking the **Contractor's** applications for partial payments hereunder, but shall not be binding upon the **City**, the **Commissioner**, or the **Engineer** for any purpose whatsoever.

ARTICLE 42. PARTIAL PAYMENTS

42.1 From time to time as the **Work** progresses satisfactorily, but not more often than once each calendar month (except where the **Commissioner** approves in writing the submission of invoices on a more frequent basis and for invoices relating to **Work** performed pursuant to a change order), the **Contractor** may submit to the **Engineer** a requisition for a partial payment in the prescribed form, which shall contain an estimate of the quantity and the fair value of the **Work** done during the payment period.

42.2 Partial payments may be made for materials, fixtures, and equipment in advance of their actual incorporation in the **Work**, as the **Commissioner** may approve, and upon the terms and conditions set forth in the General Conditions.

42.3 The **Contractor** shall also submit to the **Commissioner** in connection with every application for partial payment a verified statement in the form prescribed by the **Comptroller** setting forth the information required under Labor Law Section 220-a.

42.4 Within thirty (30) **Days** after receipt of a satisfactory payment application, and within sixty (60) **Days** after receipt of a satisfactory payment application in relation to **Work** performed pursuant to a change order, the **Engineer** will prepare and certify, and the **Commissioner** will approve, a voucher for a partial payment in the amount of such approved estimate, less any and all deductions authorized to be made by the **Commissioner** under the terms of this **Contract** or by **Law**.

ARTICLE 43. PROMPT PAYMENT

43.1 The Prompt Payment provisions of the **PPB Rules** in effect at the time of the bid will be applicable to payments made under this **Contract**. The provisions require the payment to the **Contractor** of interest on payments made after the required payment date, except as set forth in the **PPB Rules**.

43.2 The **Contractor** shall submit a proper invoice to receive payment, except where the **Contract** provides that the **Contractor** will be paid at predetermined intervals without having to submit an invoice for each scheduled payment.

43.3 Determination of interest due will be made in accordance with the **PPB Rules**.

43.4 If the **Contractor** is paid interest, the proportionate share(s) of that interest shall be forwarded by the **Contractor** to its **Subcontractor(s)**.

43.5 The **Contractor** shall pay each **Subcontractor** or **Materialman** not later than seven (7) **Days** after receipt of payment out of amounts paid to the **Contractor** by the **City** for **Work** performed by the **Subcontractor** or **Materialman** under this **Contract**.

43.5.1 If **Contractor** fails to make any payment to any **Subcontractor** or **Materialman** within seven (7) **Days** after receipt of payment by the **City** pursuant to this Article 43.5, then the **Contractor** shall pay interest on amounts due to such **Subcontractor** or **Materialman** at the rate of interest in effect on the date such payment is made by the **Contractor** computed in accordance with Section 756-b (1)(b) of the New York General Business Law. Accrual of interest shall commence on the **Day** immediately following the expiration of the seventh **Day** following receipt of payment by the **Contractor** from the **City** and shall end on the date on which payment is made.

43.6 The **Contractor** shall include in each of its subcontracts a provision requiring each **Subcontractor** to make payment to each of its **Subcontractors** or **Materialmen** for **Work** performed under this **Contract** in the same manner and within the same time period set forth above.

ARTICLE 44. SUBSTANTIAL COMPLETION PAYMENT

44.1 The **Contractor** shall submit with the **Substantial Completion** requisition:

44.1.1 A final verified statement of any pending Article 27 disputes in accordance with the **PPB Rules** and this **Contract** and any and all alleged claims against the **City**, in any way connected with or arising out of this **Contract** (including those as to which details may have been furnished pursuant to Articles 11, 27, 28, and 30) setting forth with respect to each

such claim the total amount thereof, the various items of labor and materials included therein, and the alleged value of each item; and if the alleged claim be one for delay, the alleged cause of each such delay, the period or periods of time, giving the dates when the **Contractor** claims the performance of the **Work** or a particular part thereof was delayed, and an itemized statement and breakdown of the amount claimed for each such delay.

44.1.1(a) With respect to each such claim, the **Commissioner**, the **Comptroller** and, in the event of litigation, the City Corporation Counsel shall have the same right to inspect, and to make extracts or copies of, the **Contractor's** books, vouchers, records, etc., as is referred to in Articles 11, 27, 28, and 30. Nothing contained in this Article 44.1.1(a) is intended to or shall relieve the **Contractor** from the obligation of complying strictly with Articles 11, 27, 28, and 30. The **Contractor** is warned that unless such claims are completely set forth as herein required, the **Contractor** upon acceptance of the **Substantial Completion** payment pursuant to this Article 44, will have waived any such claims.

44.1.2 A Final Approved Punch List.

44.1.3 Where required, a request for an extension of time to achieve **Substantial Completion** or final extension of time.

44.2 The **Commissioner** shall issue a voucher calling for payment of any part or all of the balance due for **Work** performed under the **Contract**, including monies retained under Article 21, less any and all deductions authorized to be made by the **Commissioner**, under this **Contract** or by **Law**, and less twice the amount the **Commissioner** considers necessary to ensure the completion of the balance of the **Work** by the **Contractor**. Such a payment shall be considered a partial and not a final payment. No **Substantial Completion** payment shall be made under this Article 44 where the **Contractor** failed to complete the **Work** within the time fixed for such completion in the Schedule A of the General Conditions, or within the time to which completion may have been extended, until an extension or extensions of time for the completion of **Work** have been acted upon pursuant to Article 13.

44.3 No further partial payments shall be made to the **Contractor** after **Substantial Completion**, except the **Substantial Completion** payment and payment pursuant to any **Contractor's** requisition that were properly filed with the **Commissioner** prior to the date of **Substantial Completion**; however, the **Commissioner** may grant a waiver for further partial payments after the date of **Substantial Completion** to permit payments for change order **Work** and/or release of retainage and deposits pursuant to Articles 21 and 24. Such waiver shall be in writing.

44.4 The **Contractor** acknowledges that nothing contained in this Article 44 is intended to or shall in any way diminish the force and effect of Article 13.

ARTICLE 45. FINAL PAYMENT

45.1 After completion and **Final Acceptance** of the **Work**, the **Contractor** shall submit all required certificates and documents, together with a requisition for the balance claimed to be due under the **Contract**, less the amount authorized to be retained for maintenance under Article 24. Such submission shall be within 90 days of the date of the **Commissioner's** written determination of **Final Acceptance**, or within such additional time as may be granted by the **Commissioner** in writing. If the **Contractor** fails to submit all required certificates and documents within the time allowed, no payment of the balance claimed shall be made to the **Contractor** and the **Contractor** shall be deemed to have forfeited its right to

payment of any balance claimed. A verified statement similar to that required in connection with applications for partial payments shall also be submitted to the **Commissioner**.

45.2 Amended Verified Statement of Claims: The **Contractor** shall also submit with the final requisition any amendments to the final verified statement of any pending dispute resolution procedures in accordance with the **PPB Rules** and this **Contract** and any and all alleged claims against the **City**, in any way connected with or arising out of this **Contract** (including those as to which details may have been furnished pursuant to Articles 11, 27, 28, and 30) that have occurred subsequent to **Substantial Completion**, setting forth with respect to each such claim the total amount thereof, the various items of labor and materials included therein, and the alleged value of each such item; and if the alleged claim be one for delay, the alleged cause of each such delay, the period or periods of time, giving the dates when the **Contractor** claims the performance of the **Work** or a particular part thereof was delayed, and an itemized statement and breakdown of the amount claimed for each such delay. With reference to each such claim, the **Commissioner**, the **Comptroller** and, in the event of litigation, the **City Corporation Counsel** shall have the same right to inspect, and to make extracts or copies of, the **Contractor's** books, vouchers, records, etc., as is referred to in Articles 11, 27, 28, and 30. Nothing contained in this Article 45.2, is intended to or shall relieve the **Contractor** from the obligation of complying strictly with Articles 11, 27, 28, and 30. The **Contractor** is warned that unless such claims are completely set forth as herein required, the **Contractor**, upon acceptance of the Final Payment pursuant to Article 46, will have waived any such claims.

45.3 Preparation of Final Voucher: Upon determining the balance due hereunder other than on account of claims, the **Engineer** will prepare and certify, for the **Commissioner's** approval, a voucher for final payment in that amount less any and all deductions authorized to be made by the **Commissioner** under this **Contract** or by **Law**. In the case of a lump sum **Contract**, the **Commissioner** shall certify the voucher for final payment within thirty (30) **Days** from the date of completion and acceptance of the **Work**, provided all requests for extensions of time have been acted upon.

45.3.1 All prior certificates and vouchers upon which partial payments were made, being merely estimates made to enable the **Contractor** to prosecute the **Work** more advantageously, shall be subject to correction in the final voucher, and the certification of the **Engineer** thereon and the approval of the **Commissioner** thereof, shall be conditions precedent to the right of the **Contractor** to receive any money hereunder. Such final voucher shall be binding and conclusive upon the **Contractor**.

45.3.2 Payment pursuant to such final voucher, less any deductions authorized to be made by the **Commissioner** under this **Contract** or by **Law**, shall constitute the final payment, and shall be made by the **Comptroller** within thirty (30) **Days** after the filing of such voucher in his/her office.

45.4 The **Contractor** acknowledges that nothing contained in this Article 45 is intended to or shall in any way diminish the force and effect of Article 13.

ARTICLE 46. ACCEPTANCE OF FINAL PAYMENT

46.1 The acceptance by the **Contractor**, or by anyone claiming by or through it, of the final payment, whether such payment be made pursuant to any judgment of any court, or otherwise, shall constitute and operate as a release of the **City** from any and all claims of and liability to the **Contractor** for anything heretofore done or furnished for the **Contractor** relating to or arising out of this **Contract** and the **Work** done hereunder, and for any prior act, neglect or default on the part of the **City** or any of its officials, agents or employees, excepting only a claim against the **City** for the amounts deducted or retained in accordance with the terms and provisions of this **Contract** or by **Law**, and excepting any

claims, not otherwise waived, or any pending dispute resolution procedures which are contained in the verified statement filed with the **Contractor's** substantial and final requisitions pursuant to Articles 44 and 45.

46.2 The **Contractor** is warned that the execution by it of a release, in connection with the acceptance of the final payment, containing language purporting to reserve claims other than those herein specifically excepted from the operation of this Article 46, or those for amounts deducted by the **Commissioner** from the final requisition or from the final payment as certified by the **Engineer** and approved by the **Commissioner**, shall not be effective to reserve such claims, anything stated to the **Contractor** orally or in writing by any official, agent or employee of the **City** to the contrary notwithstanding.

46.3 Should the **Contractor** refuse to accept the final payment as tendered by the **Comptroller**, it shall constitute a waiver of any right to interest thereon.

46.4 The **Contractor**, however, shall not be barred by this Article 46 from commencing an action for breach of **Contract** to the extent permitted by **Law** and by the terms of the **Contract** for any claims that are contained in the verified statement filed with the **Contractor's** substantial and final requisitions pursuant to Articles 44 and 45 or that arose after submission of the final payment requisition, provided that a detailed and verified statement of claim is served upon the contracting **Agency** and **Comptroller** not later than forty (40) **Days** after the making of such final payment by electronic funds transfer (EFT) or the mailing of such final payment. The statement shall specify the items upon which the claim will be based and any such claim shall be limited to such items.

ARTICLE 47. APPROVAL BY PUBLIC DESIGN COMMISSION

47.1 All works of art, including paintings, mural decorations, stained glass, statues, bas-reliefs, and other sculptures, monuments, fountains, arches, and other structures of a permanent character intended for ornament or commemoration, and every design of the same to be used in the performance of this **Contract**, and the design of all bridges, approaches, buildings, gates, fences, lamps, or structures to be erected, pursuant to the terms of this **Contract**, shall be submitted to the Art Commission, d/b/a the Public Design Commission of the City of New York, and shall be approved by the Public Design Commission prior to the erection or placing in position of the same. The final payment shall not become due or payable under this **Contract** unless and until the Public Design Commission shall certify that the design for the **Work** herein contracted for has been approved by the said Public Design Commission, and that the same has been executed in substantial accordance with the design so approved, pursuant to the provisions of Chapter 37, Section 854 of the **City Charter**, as amended.

CHAPTER X CONTRACTOR'S DEFAULT

ARTICLE 48. COMMISSIONER'S RIGHT TO DECLARE CONTRACTOR IN DEFAULT

48.1 In addition to those instances specifically referred to in other Articles herein, the **Commissioner** shall have the right to declare the **Contractor** in default of this **Contract** if:

48.1.1 The **Contractor** fails to commence **Work** when notified to do so by the **Commissioner**; or
if

48.1.2 The **Contractor** shall abandon the **Work**; or if

48.1.3 The **Contractor** shall refuse to proceed with the **Work** when and as directed by the **Commissioner**; or if

48.1.4 The **Contractor** shall, without just cause, reduce its working force to a number which, if maintained, would be insufficient, in the opinion of the **Commissioner**, to complete the **Work** in accordance with the progress schedule; or if

48.1.5 The **Contractor** shall fail or refuse to increase sufficiently such working force when ordered to do so by the **Commissioner**; or if

48.1.6 The **Contractor** shall sublet, assign, transfer, convert or otherwise dispose of this **Contract** other than as herein specified; or sell or assign a majority interest in the **Contractor**; or if

48.1.7 The **Contractor** fails to secure and maintain all required insurance; or if

48.1.8 A receiver or receivers are appointed to take charge of the **Contractor's** property or affairs; or if

48.1.9 The **Commissioner** shall be of the opinion that the **Contractor** is or has been unnecessarily or unreasonably or willfully delaying the performance and completion of the **Work**, or the award of necessary subcontracts, or the placing of necessary material and equipment orders; or if

48.1.10 The **Commissioner** shall be of the opinion that the **Contractor** is or has been willfully or in bad faith violating any of the provisions of this **Contract**; or if

48.1.11 The **Commissioner** shall be of the opinion that the **Work** cannot be completed within the time herein provided therefor or within the time to which such completion may have been extended; provided, however, that the impossibility of timely completion is, in the **Commissioner's** opinion, attributable to conditions within the **Contractor's** control; or if

48.1.12 The **Work** is not completed within the time herein provided therefor or within the time to which the **Contractor** may be entitled to have such completion extended; or if

48.1.13 Any statement or representation of the **Contractor** in the **Contract** or in any document submitted by the **Contractor** with respect to the **Work**, the **Project**, or the **Contract** (or for purposes of securing the **Contract**) was untrue or incorrect when made; or if

48.1.14 The **Contractor** or any of its officers, directors, partners, five (5%) percent shareholders, principals, or other persons substantially involved in its activities, commits any of the acts or omissions specified as the grounds for debarment in the **PPB Rules**.

48.2 Before the **Commissioner** shall exercise his/her right to declare the **Contractor** in default, the **Commissioner** shall give the **Contractor** an opportunity to be heard, upon not less than two (2) **Days** notice.

ARTICLE 49. EXERCISE OF THE RIGHT TO DECLARE DEFAULT

49.1 The right to declare the **Contractor** in default for any of the grounds specified or referred to in Article 48 shall be exercised by sending the **Contractor** a notice, signed by the **Commissioner**, setting forth the ground or grounds upon which such default is declared (hereinafter referred to as a "Notice of Default").

49.2 The **Commissioner's** determination that the **Contractor** is in default shall be conclusive, final, and binding on the parties and such a finding shall preclude the **Contractor** from commencing a plenary action for any damages relating to the **Contract**. If the **Contractor** protests the determination of the **Commissioner**, the **Contractor** may commence an action in a court of competent jurisdiction of the State of New York under Article 78 of the New York Civil Practice Law and Rules.

ARTICLE 50. QUITTING THE SITE

50.1 Upon receipt of such notice the **Contractor** shall immediately discontinue all further operations under this **Contract** and shall immediately quit the **Site**, leaving untouched all plant, materials, equipment, tools, and supplies then on the **Site**.

ARTICLE 51. COMPLETION OF THE WORK

51.1 The **Commissioner**, after declaring the **Contractor** in default, may then have the **Work** completed by such means and in such manner, by contract with or without public letting, or otherwise, as he/she may deem advisable, utilizing for such purpose such of the **Contractor's** plant, materials, equipment, tools, and supplies remaining on the **Site**, and also such **Subcontractors**, as he/she may deem advisable.

51.2 After such completion, the **Commissioner** shall make a certificate stating the expense incurred in such completion, which shall include the cost of re-letting and also the total amount of liquidated damages (at the rate provided for in the **Contract**) from the date when the **Work** should have been completed by the **Contractor** in accordance with the terms hereof to the date of actual completion of the **Work**. Such certificate shall be binding and conclusive upon the **Contractor**, its sureties, and any person claiming under the **Contractor**, as to the amount thereof.

51.3 The expense of such completion, including any and all related and incidental costs, as so certified by the **Commissioner**, and any liquidated damages assessed against the **Contractor**, shall be charged against and deducted out of monies which are earned by the **Contractor** prior to the date of default. Should the expense of such completion, as certified by the **Commissioner**, exceed the total sum which would have been payable under the **Contract** if it had been completed by the **Contractor**, any excess shall be paid by the **Contractor**.

ARTICLE 52. PARTIAL DEFAULT

52.1 In case the **Commissioner** shall declare the **Contractor** in default as to a part of the **Work** only, the **Contractor** shall discontinue such part, shall continue performing the remainder of the **Work** in strict conformity with the terms of this **Contract**, and shall in no way hinder or interfere with any **Other**

Contractor(s) or persons whom the **Commissioner** may engage to complete the **Work** as to which the **Contractor** was declared in default.

52.2 The provisions of this Chapter relating to declaring the **Contractor** in default as to the entire **Work** shall be equally applicable to a declaration of partial default, except that the **Commissioner** shall be entitled to utilize for completion of the part of the **Work** as to which the **Contractor** was declared in default only such plant, materials, equipment, tools, and supplies as had been previously used by the **Contractor** on such part.

ARTICLE 53. PERFORMANCE OF UNCOMPLETED WORK

53.1 In completing the whole or any part of the **Work** under the provisions of this Chapter X, the **Commissioner** shall have the power to depart from or change or vary the terms and provisions of this **Contract**, provided, however, that such departure, change or variation is made for the purpose of reducing the time or expense of such completion. Such departure, change or variation, even to the extent of accepting a lesser or different performance, shall not affect the conclusiveness of the **Commissioner's** certificate of the cost of completion referred to in Article 51, nor shall it constitute a defense to an action to recover the amount by which such certificate exceeds the amount which would have been payable to the **Contractor** hereunder but for its default.

ARTICLE 54. OTHER REMEDIES

54.1 In addition to the right to declare the **Contractor** in default pursuant to this Chapter X, the **Commissioner** shall have the absolute right, in his/her sole discretion and without a hearing, to complete or cause to be completed in the same manner as described in Articles 51 and 53, any or all unsatisfactory or uncompleted punch list **Work** that remains after the completion date specified in the **Final Approved Punch List**. A written notice of the exercise of this right shall be sent to the **Contractor** who shall immediately quit the **Site** in accordance with the provisions of Article 50.

54.2 The expense of completion permitted under Article 54.1, including any and all related and incidental costs, as so certified by the **Commissioner**, shall be charged against and deducted out of monies which have been earned by the **Contractor** prior to the date of the exercise of the right set forth in Article 54.1; the balance of such monies, if any, subject to the other provisions of this **Contract**, to be paid to the **Contractor** without interest after such completion. Should the expense of such completion, as certified by the **Commissioner**, exceed the total sum which would have been payable under the **Contract** if it had been completed by the **Contractor**, any excess shall be paid by the **Contractor**.

54.3 The previous provisions of this Chapter X shall be in addition to any and all other remedies available under **Law** or in equity.

54.4 The exercise by the **City** of any remedy set forth herein shall not be deemed a waiver by the **City** of any other legal or equitable remedy contained in this **Contract** or provided under **Law**.

**CHAPTER XI
MISCELLANEOUS PROVISIONS**

ARTICLE 55. CONTRACTOR'S WARRANTIES

55.1 In consideration of, and to induce, the award of this **Contract** to the **Contractor**, the **Contractor** represents and warrants:

55.1.1 That it is financially solvent, sufficiently experienced and competent to perform the **Work**; and

55.1.2 That the facts stated in its bid and the information given by it pursuant to the Information for Bidders is true and correct in all respects; and

55.1.3 That it has read and complied with all requirements set forth in the **Contract**.

ARTICLE 56. CLAIMS AND ACTIONS THEREON

56.1 Any claim, that is not subject to dispute resolution under the **PPB Rules** or this **Contract**, against the **City** for damages for breach of **Contract** shall not be made or asserted in any action, unless the **Contractor** shall have strictly complied with all requirements relating to the giving of notice and of information with respect to such claims, as herein before provided.

56.2 Nor shall any action be instituted or maintained on any such claims unless such action is commenced within six (6) months after **Substantial Completion**; except that:

56.2.1 Any claims arising out of events occurring after **Substantial Completion** and before **Final Acceptance** of the **Work** shall be asserted within six (6) months of **Final Acceptance** of the **Work**;

56.2.2 Any claims for monies deducted, retained or withheld under the provisions of this **Contract** shall be asserted within six (6) months after the date when such monies otherwise become due and payable hereunder; and

56.2.3 If the **Commissioner** exercises his/her right to terminate the **Contract** pursuant to Article 64, any such action shall be commenced within six (6) months of the date the **Commissioner** exercises said right.

ARTICLE 57. INFRINGEMENT

57.1 The **Contractor** shall be solely responsible for and shall defend, indemnify, and hold the **City** harmless from any and all claims (even if the allegations of the lawsuit are without merit) and judgments for damages and from costs and expenses to which the **City** may be subject to or which it may suffer or incur allegedly arising out of or in connection with any infringement by the **Contractor** of any copyright, trade secrets, trademark or patent rights or any other property or personal right of any third party by the **Contractor** and/or its **Subcontractors** in the performance or completion of the **Work**. Insofar as the facts or **Law** relating to any claim would preclude the **City** from being completely indemnified by the **Contractor**, the **City** shall be partially indemnified by the **Contractor** to the fullest extent permitted by **Law**.

ARTICLE 58. NO CLAIM AGAINST OFFICIALS, AGENTS OR EMPLOYEES

58.1 No claim whatsoever shall be made by the **Contractor** against any official, agent or employee of the **City** for, or on account of, anything done or omitted to be done in connection with this **Contract**.

ARTICLE 59. SERVICE OF NOTICES

59.1 The **Contractor** hereby designates the business address, fax number, and email address specified in its bid, as the place where all notices, directions or other communications to the **Contractor** may be delivered, or to which they may be mailed. Any notice, direction, or communication from either party to the other shall be in writing and shall be deemed to have been given when (i) delivered personally; (ii) sent by certified mail, return receipt requested; (iii) delivered by overnight or same day courier service in a properly addressed envelope with confirmation; or (iv) sent by fax or email and, unless receipt of the fax or e-mail is acknowledged by the recipient by fax or e-mail, deposited in a post office box regularly maintained by the United States Postal Service in a properly addressed, postage pre-paid envelope.

59.2 **Contractor's** notice address, email address, or fax number may be changed at any time by an instrument in writing, executed and acknowledged by the **Contractor**, and delivered to the **Commissioner**.

59.3 Nothing herein contained shall, however, be deemed to preclude or render inoperative the service of any notice, direction or other communication upon the **Contractor** personally, or, if the **Contractor** is a corporation, upon any officer thereof.

ARTICLE 60. UNLAWFUL PROVISIONS DEEMED STRICKEN FROM CONTRACT

60.1 If this **Contract** contains any unlawful provision not an essential part of the **Contract** and which shall not appear to have been a controlling or material inducement to the making thereof, the same shall be deemed of no effect and shall, upon notice by either party, be deemed stricken from the **Contract** without affecting the binding force of the remainder.

ARTICLE 61. ALL LEGAL PROVISIONS DEEMED INCLUDED

61.1 It is the intent and understanding of the parties to this **Contract** that each and every provision of **Law** required to be inserted in this **Contract** shall be and is inserted herein. Furthermore, it is hereby stipulated that every such provision is to be deemed to be inserted herein, and if, through mistake or otherwise, any such provision is not inserted, or is not inserted in correct form, then this **Contract** shall forthwith upon the application of either party be amended by such insertion so as to comply strictly with the **Law** and without prejudice to the rights of either party hereunder.

ARTICLE 62. TAX EXEMPTION

62.1 The **City** is exempt from payment of Federal, State, and local taxes, including sales and compensating use taxes of the State of New York and its cities and counties on all tangible personal property sold to the **City** pursuant to the provisions of this **Contract**. These taxes are not to be included in bids. However, this exemption does not apply to tools, machinery, equipment or other property leased by or to the **Contractor**, **Subcontractor** or **Materialman** or to tangible personal property which, even

though it is consumed, is not incorporated into the completed **Work** (consumable supplies) and tangible personal property that the **Contractor** is required to remove from the **Site** during or upon completion of the **Work**. The **Contractor** and its **Subcontractors** and **Materialmen** shall be responsible for and pay any and all applicable taxes, including sales and compensating use taxes, on such leased tools, machinery, equipment or other property and upon all such consumable supplies and tangible personal property that the **Contractor** is required to remove from the **Site** during or upon completion of the **Work**.

62.2 The **Contractor** agrees to sell and the **City** agrees to purchase all tangible personal property, other than consumable supplies and other tangible personal property that the **Contractor** is required to remove from the **Site** during or upon completion of the **Work**, that is required, necessary or proper for or incidental to the construction of the **Project** covered by this **Contract**. The sum paid under this **Contract** for such tangible personal property shall be in full payment and consideration for the sale of such tangible personal property.

62.2.1 The **Contractor** agrees to construct the **Project** and to perform all **Work**, labor and services rendered, necessary, proper or incidental thereto for the sum shown in the bid for the performance of such **Work**, labor, and services, and the sum so paid pursuant to this **Contract** for such **Work**, labor, and services, shall be in full consideration for the performance by the **Contractor** of all its duties and obligations under this **Contract** in connection with said **Work**, labor, and services.

62.3 20 NYCRR Section 541.3(d) provides that a **Contractor's** purchases of tangible personal property that is either incorporated into real property owned by a governmental entity or purchased for and sold to a governmental entity are exempt from sales and use tax. The **City** shall not pay sales tax for any such tangible personal property that it purchases from the **Contractor** pursuant to the **Contract**. With respect to such tangible personal property, the **Contractor**, at the request of the **City**, shall furnish to the **City** such bills of sale and other instruments as may be required by the **City**, properly executed, acknowledged and delivered assuring to the **City** title to such tangible personal property, free of liens and/or encumbrances, and the **Contractor** shall mark or otherwise identify all such tangible personal property as the property of the **City**.

62.4 Title to all tangible personal property to be sold by the **Contractor** to the **City** pursuant to the provisions of the **Contract** shall immediately vest in and become the sole property of the **City** upon delivery of such tangible personal property to the **Site**. Notwithstanding such transfer of title, the **Contractor** shall have the full and continuing responsibility to install such tangible personal property in accordance with the provisions of this **Contract**, protect it, maintain it in a proper condition and forthwith repair, replace and make good any damage thereto, theft or disappearance thereof, and furnish additional tangible personal property in place of any that may be lost, stolen or rendered unusable, without cost to the **City**, until such time as the **Work** covered by the **Contract** is fully accepted by the **City**. Such transfer of title shall in no way affect any of the **Contractor's** obligations hereunder. In the event that, after title has passed to the **City**, any of the tangible personal property is rejected as being defective or otherwise unsatisfactory, title to all such tangible personal property shall be deemed to have been transferred back to the **Contractor**.

62.5 The purchase by **Subcontractors** or **Materialmen** of tangible personal property to be sold hereunder shall be a purchase or procurement for resale to the **Contractor** (either directly or through other **Subcontractors**) and therefore not subject to the aforesaid sales and compensating use taxes, provided that the subcontracts and purchase agreements provide for the resale of such tangible personal property and that such subcontracts and purchase agreements are in a form similar to this **Contract** with respect to the separation of the sale of consumable supplies and tangible personal property that the **Contractor** is required to remove from the **Site** during or upon completion of the **Work** from the **Work** and labor, services, and any other matters to be provided, and provided further that the subcontracts and

purchase agreements provide separate prices for tangible personal property and all other services and matters. Such separation shall actually be followed in practice, including the separation of payments for tangible personal property from the payments for other **Work** and labor and other things to be provided.

62.6 The **Contractor** and its **Subcontractors** and **Materialmen** shall furnish a **Contractor Exempt Purchase Certificate** to all persons, firms or corporations from which they purchase tangible personal property for the performance of the **Work** covered by this **Contract**.

62.7 In the event any of the provisions of this Article 62 shall be deemed to be in conflict with any other provisions of this **Contract** or create any ambiguity, then the provisions of this Article 62 shall control.

ARTICLE 63. INVESTIGATION(S) CLAUSE

63.1 The parties to this **Contract** agree to cooperate fully and faithfully with any investigation, audit or inquiry conducted by a United States, a State of New York (State) or a **City** governmental agency or authority that is empowered directly or by designation to compel the attendance of witnesses and to examine witnesses under oath, or conducted by the Inspector General of a governmental agency that is a party in interest to the transaction, submitted bid, submitted proposal, contract, lease, permit or license that is the subject of the investigation, audit or inquiry.

63.2 If any person who has been advised that his/her statement, and any information from such statement, will not be used against him/her in any subsequent criminal proceeding refuses to testify before a grand jury or other governmental agency or authority empowered directly or by designation to compel the attendance of witnesses and to examine witnesses under oath concerning the award of or performance under any transaction, agreement, lease, permit, contract, or license entered into with the **City**, the State, or any political subdivision or public authority thereof, or the Port Authority of New York and New Jersey, or any local development corporation within the **City**, or any public benefit corporation organized under the **Laws** of the State of New York, or;

63.3 If any person refuses to testify for a reason other than the assertion of his/her privilege against self incrimination in an investigation, audit or inquiry conducted by a **City** or State governmental agency or authority empowered directly or by designation to compel the attendance of witnesses and to take testimony under oath, or by the Inspector General of the governmental agency that is a party in interest in, and is seeking testimony concerning the award of, or performance under any transaction, agreement, lease, permit, contract, or license entered into with the **City**, the State, or any political subdivision thereof or any local development corporation within the **City**, then;

63.4 The **Commissioner** whose **Agency** is a party in interest to the transaction, submitted bid, submitted proposal, contract, lease, permit, or license shall convene a hearing, upon not less than five (5) **Days'** written notice to the parties involved to determine if any penalties should attach for the failure of a person to testify.

63.5 If any non-governmental party to the hearing requests an adjournment, the **Commissioner** who convened the hearing may, upon granting the adjournment, suspend any contract, lease, permit, or license, pending the final determination pursuant to Article 63.7 without the **City** incurring any penalty or damages for delay or otherwise.

63.6 The penalties which may attach after a final determination by the **Commissioner** may include but shall not exceed:

63.6.1 The disqualification for a period not to exceed five (5) years from the date of an adverse determination for any person, or any entity of which such person was a member at the time the testimony was sought, from submitting bids for, or transacting business with, or entering into or obtaining any contract, lease, permit or license with or from the City; and/or

63.6.2 The cancellation or termination of any and all such existing City contracts, leases, permits or licenses that the refusal to testify concerns and that have not been assigned as permitted under this Contract, nor the proceeds of which pledged, to an unaffiliated and unrelated institutional lender for fair value prior to the issuance of the notice scheduling the hearing, without the City incurring any penalty or damages on account of such cancellation or termination; monies lawfully due for goods delivered, work done, rentals, or fees accrued prior to the cancellation or termination shall be paid by the City.

63.7 The **Commissioner** shall consider and address in reaching his/her determination and in assessing an appropriate penalty the factors in Articles 63.7.1 and 63.7.2. The **Commissioner** may also consider, if relevant and appropriate, the criteria established in Articles 63.7.3 and 63.7.4, in addition to any other information which may be relevant and appropriate:

63.7.1 The party's good faith endeavors or lack thereof to cooperate fully and faithfully with any governmental investigation or audit, including but not limited to the discipline, discharge, or disassociation of any person failing to testify, the production of accurate and complete books and records, and the forthcoming testimony of all other members, agents, assignees or fiduciaries whose testimony is sought.

63.7.2 The relationship of the person who refused to testify to any entity that is a party to the hearing, including but not limited to, whether the person whose testimony is sought has an ownership interest in the entity and/or the degree of authority and responsibility the person has within the entity.

63.7.3 The nexus of the testimony sought to the subject entity and its contracts, leases, permits or licenses with the City.

63.7.4 The effect a penalty may have on an unaffiliated and unrelated party or entity that has a significant interest in an entity subject to penalties under Article 63.6, provided that the party or entity has given actual notice to the **Commissioner** upon the acquisition of the interest, or at the hearing called for in Article 63.4, gives notice and proves that such interest was previously acquired. Under either circumstance the party or entity shall present evidence at the hearing demonstrating the potential adverse impact a penalty will have on such person or entity.

63.8 Definitions:

63.8.1 The term "license" or "permit" as used in this Article 63 shall be defined as a license, permit, franchise or concession not granted as a matter of right.

63.8.2 The term "person" as used in this Article 63 shall be defined as any natural person doing business alone or associated with another person or entity as a partner, director, officer, principal or employee.

63.8.3 The term "entity" as used in this Article 63 shall be defined as any firm, partnership, corporation, association, joint venture, or person that receives monies, benefits, licenses, leases, or permits from or through the City or otherwise transacts business with the City.

63.8.4 The term "member" as used in this Article 63 shall be defined as any person associated with another person or entity as a partner, director, officer, principal or employee.

63.9 In addition to and notwithstanding any other provision of this **Contract**, the **Commissioner** may in his/her sole discretion terminate this **Contract** upon not less than three (3) **Days**' written notice in the event the **Contractor** fails to promptly report in writing to the **Commissioner** of the Department of Investigations ("DOI") of the **City** any solicitation of money, goods, requests for future employment or other benefit or thing of value, by or on behalf of any employee of the **City** or other person, firm, corporation or entity for any purpose which may be related to the procurement or obtaining of this **Contract** by the **Contractor**, or affecting the performance of this **Contract**.

ARTICLE 64. TERMINATION BY THE CITY

64.1 In addition to termination pursuant to any other article of this **Contract**, the **Commissioner** may, at any time, terminate this **Contract** by written notice to the **Contractor**. In the event of termination, the **Contractor** shall, upon receipt of such notice, unless otherwise directed by the **Commissioner**:

64.1.1 Stop **Work** on the date specified in the notice;

64.1.2 Take such action as may be necessary for the protection and preservation of the **City's** materials and property;

64.1.3 Cancel all cancelable orders for material and equipment;

64.1.4 Assign to the **City** and deliver to the **Site** or another location designated by the **Commissioner**, any non-cancelable orders for material and equipment that is not capable of use except in the performance of this **Contract** and has been specifically fabricated for the sole purpose of this **Contract** and not incorporated in the **Work**;

64.1.5 Take no action which will increase the amounts payable by the **City** under this **Contract**.

64.2 In the event of termination by the **City** pursuant to this Article 64, payment to the **Contractor** shall be in accordance with Articles 64.2.1, 64.2.2 or 64.2.3, to the extent that each respective article applies.

64.2.1 Lump Sum Contracts or Items: On all lump sum **Contracts**, or on lump sum items in a **Contract**, the **City** will pay the **Contractor** the sum of the amounts described in Articles 64.2.1(a) and 64.2.1(b), less all payments previously made pursuant to this **Contract**. On lump sum **Contracts** only, the **City** will also pay the **Contractor** an additional sum as provided in Article 64.2.1(c).

64.2.1(a) For **Work** completed prior to the notice of termination, the **Contractor** shall be paid a pro rata portion of the lump sum bid amount, plus approved change orders, based upon the percent completion of the **Work**, as determined by the **Commissioner**. For the purpose of determining the pro rata portion of the lump sum bid amount to which the **Contractor** is entitled, the bid breakdown submitted in accordance with Article 41 shall be considered, but shall not be dispositive. The **Commissioner's** determination hereunder shall be final, binding, and conclusive.

64.2.1(b) For non-cancelable material and equipment that is not capable of use except in the performance of this **Contract** and has been specifically fabricated for the sole purpose of this **Contract**, but not yet incorporated in the **Work**, the **Contractor** shall be paid the lesser of the following, less salvage value:

64.2.1(b)(i) The Direct Cost, as defined in Article 64.2.4; or

64.2.1(b)(ii) The fair and reasonable value, if less than Direct Cost, of such material and equipment, plus necessary and reasonable delivery costs.

64.2.1(b)(iii) In addition, the **Contractor** shall be paid five (5%) percent of the amount described in Article 64.2.1(b)(i) or Article 64.2.1(b)(ii), whichever applies.

64.2.1(c) Except as otherwise provided in Article 64.2.1(d), on all lump sum **Contracts**, the **Contractor** shall be paid the percentage indicated below applied to the difference between the total lump sum bid amount and the total of all payments made prior to the notice of termination plus all payments allowed pursuant to Articles 64.2.1(a) and 64.2.1(b):

64.2.1(c)(i) Five (5%) percent of the first five million (\$5,000,000) dollars; and

64.2.1(c)(ii) Three (3%) percent of any amount between five million (\$5,000,000) dollars and fifteen million (\$15,000,000) dollars; plus

64.2.1(c)(iii) One (1%) percent of any amount over fifteen million (\$15,000,000) dollars.

64.2.1(d) In the event the **City** terminates a lump sum **Contract** pursuant to this Article 64 within ninety (90) **Days** after registration of the **Contract** with the **Comptroller**, the **Contractor** shall be paid one (1%) percent of the difference between the lump sum bid amount and the total of all payments made pursuant to this Article 64.2.

64.2.2 Unit Price Contracts or Items: On all unit price **Contracts**, or on unit price items in a **Contract**, the **City** will pay the **Contractor** the sum of the amounts described in Articles 64.2.2(a) and 64.2.2(b), less all payments previously made pursuant to this **Contract**:

64.2.2(a) For all completed units, the unit price stated in the **Contract**, and

64.2.2(b) For units that have been ordered but are only partially completed, the **Contractor** will be paid:

64.2.2(b)(i) A pro rata portion of the unit price stated in the **Contract** based upon the percent completion of the unit and

64.2.2(b)(ii) For non-cancelable material and equipment, payment will be made pursuant to Article 64.2.1(b).

64.2.3 Time and Materials Contracts or Items Based on Time and Material Records: On all **Contracts** or items in a **Contract** where payment for the **Work** is based on time and

material records, the **Contractor** shall be paid in accordance with Article 26, less all payments previously made pursuant to this **Contract**.

64.2.4 Direct Costs: Direct Costs as used in this Article 64.2 shall mean:

64.2.4(a) The actual purchase price of material and equipment, plus necessary and reasonable delivery costs,

64.2.4(b) The actual cost of labor involved in construction and installation at the **Site**, and

64.2.4(c) The actual cost of necessary bonds and insurance purchased pursuant to requirements of this **Contract** less any amounts that have been or should be refunded by the **Contractor's** sureties or insurance carriers.

64.2.4(d) Direct Costs shall not include overhead.

64.3 In no event shall any payments under this Article 64 exceed the **Contract** price for such items.

64.4 All payments pursuant to Article 64 shall be in the nature of liquidated damages and shall be accepted by the **Contractor** in full satisfaction of all claims against the **City**.

64.5 The **City** may deduct or set off against any sums due and payable pursuant to this Article 64, any deductions authorized by this **Contract** or by **Law** (including but not limited to liquidated damages) and any claims it may have against the **Contractor**. The **City's** exercise of the right to terminate the **Contract** pursuant to this Article 64 shall not impair or otherwise effect the **City's** right to assert any claims it may have against the **Contractor** in a plenary action.

64.6 Where the **Work** covered by the **Contract** has been substantially completed, as determined in writing by the **Commissioner**, termination of the **Work** shall be handled as an omission of **Work** pursuant to Articles 29 and 33, in which case a change order will be issued to reflect an appropriate reduction in the **Contract** sum, or if the amount is determined after final payment, such amount shall be paid by the **Contractor**.

ARTICLE 65. CHOICE OF LAW, CONSENT TO JURISDICTION AND VENUE

65.1 This **Contract** shall be deemed to be executed in the **City** regardless of the domicile of the **Contractor**, and shall be governed by and construed in accordance with the **Laws** of the State of New York and the **Laws** of the United States, where applicable.

65.2 The parties agree that any and all claims asserted against the **City** arising under this **Contract** or related thereto shall be heard and determined in the courts of the State of New York ("New York State Courts") located in the **City** and County of New York. To effect this **Contract** and intent, the **Contractor** agrees:

65.2.1 If the **City** initiates any action against the **Contractor** in Federal court or in a New York State Court, service of process may be made on the **Contractor** either in person, wherever such **Contractor** may be found, or by registered mail addressed to the **Contractor** at its address as set forth in this **Contract**, or to such other address as the **Contractor** may provide to the **City** in writing; and

65.2.2 With respect to any action between the **City** and the **Contractor** in a New York State Court, the **Contractor** hereby expressly waives and relinquishes any rights it might otherwise have:

65.2.2(a) To move to dismiss on grounds of forum non conveniens;

65.2.2(b) To remove to Federal Court; and

65.2.2(c) To move for a change of venue to a New York State Court outside New York County.

65.2.3 With respect to any action brought by the **City** against the **Contractor** in a Federal Court located in the **City**, the **Contractor** expressly waives and relinquishes any right it might otherwise have to move to transfer the action to a Federal Court outside the **City**.

65.2.4 If the **Contractor** commences any action against the **City** in a court located other than in the **City** and County of New York, upon request of the **City**, the **Contractor** shall either consent to a transfer of the action to a New York State Court of competent jurisdiction located in the **City** and County of New York or, if the Court where the action is initially brought will not or cannot transfer the action, the **Contractor** shall consent to dismiss such action without prejudice and may thereafter reinstate the action in a New York State Court of competent jurisdiction in New York County.

65.3 If any provision(s) of this Article 65 is held unenforceable for any reason, each and all other provision(s) shall nevertheless remain in full force and effect.

ARTICLE 66. PARTICIPATION IN AN INTERNATIONAL BOYCOTT

66.1 The **Contractor** agrees that neither the **Contractor** nor any substantially owned affiliated company is participating or shall participate in an international boycott in violation of the provisions of the Federal Export Administration Act of 1979, as amended, or the regulations of the United States Department of Commerce (Commerce Department) promulgated thereunder.

66.2 Upon the final determination by the Commerce Department or any other agency of the United States as to, or conviction of the **Contractor** or a substantially-owned affiliated company thereof for participation in an international boycott in violation of the provisions of the Export Administration Act of 1979, as amended, or the regulations promulgated thereunder, the **Comptroller** may, at his/her option, render forfeit and void this **Contract**.

66.3 The **Contractor** shall comply in all respects, with the provisions of Section 6-114 of the Administrative Code and the rules and regulations issued by the **Comptroller** thereunder.

ARTICLE 67. LOCALLY BASED ENTERPRISE PROGRAM

67.1 This **Contract** is subject to the requirements of Section 6-108.1 of the Administrative Code and regulations promulgated thereunder. No construction contract shall be awarded unless and until these requirements have been complied with in their entirety; however, compliance with this Article 67 is not required if the Agency sets Subcontractor Participation Goals for Minority- and Women-Owned Business Enterprises (M/WBEs).

67.2 Unless specifically waived by the **Commissioner** with the approval of the Division of Economic and Financial Opportunity of the City Department of Business Services, if any portion of the **Contract** is subcontracted, not less than ten (10%) percent of the total dollar amount of the **Contract** shall be awarded to locally based enterprises (LBEs); except that where less than ten (10%) percent of the total dollar amount of the **Contract** is subcontracted, such lesser percentage shall be so awarded.

67.3 The **Contractor** shall not require performance and payment bonds from LBE **Subcontractors**.

67.4 If the **Contractor** has indicated prior to award that no **Work** will be subcontracted, no **Work** shall be subcontracted without the prior approval of the **Commissioner**, which shall be granted only if the **Contractor** makes a good faith effort beginning at least six (6) weeks before the **Work** is to be performed to obtain LBE **Subcontractors** to perform the **Work**.

67.5 If the **Contractor** has not identified sufficient LBE **Subcontractors** prior to award, it shall sign a letter of compliance stating that it complies with Section 6-108.1 of the Administrative Code, recognizes that achieving the LBE requirement is a condition of its **Contract**, and shall submit documentation demonstrating its good faith efforts to obtain LBEs. After award, the **Contractor** shall begin to solicit LBE's to perform subcontracted **Work** at least six (6) weeks before the date such **Work** is to be performed and shall demonstrate that a good faith effort has been made to obtain LBEs on each subcontract until it meets the required percentage.

67.6 Failure of the **Contractor** to comply with the requirements of Section 6-108.1 of the Administrative Code and the regulations promulgated thereunder shall constitute a material breach of this **Contract**. Remedy for such breach may include the imposition of any or all of the following sanctions:

67.6.1 Reducing the **Contractor's** compensation by an amount equal to the dollar value of the percentage of the LBE subcontracting requirement not complied with;

67.6.2 Declaring the **Contractor** in default;

67.6.3 If the **Contractor** is an LBE, de-certifying and declaring the **Contractor** ineligible to participate in the LBE program for a period of up to three (3) years.

ARTICLE 68. ANTITRUST

68.1 The **Contractor** hereby assigns, sells, and transfers to the City all right, title, and interest in and to any claims and causes of action arising under the antitrust Laws of New York State or of the United States relating to the particular goods or services purchased or procured by the City under this **Contract**.

ARTICLE 69. MacBRIDE PRINCIPLES PROVISIONS

69.1 Notice To All Prospective **Contractors**:

69.1.1 Local Law No. 34 of 1991 became effective on September 10, 1991 and added Section 6-115.1 of the Administrative Code. The local Law provides for certain restrictions on **City Contracts** to express the opposition of the people of the City to employment discrimination practices in Northern Ireland to promote freedom of work-place opportunity.

69.1.2 Pursuant to Section 6-115.1, prospective **Contractors** for **Contracts** to provide goods or services involving an expenditure of an amount greater than ten thousand

(\$10,000.) dollars, or for construction involving an amount greater than fifteen thousand (\$15,000.) dollars, are asked to sign a rider in which they covenant and represent, as a material condition of their **Contract**, that any business operations in Northern Ireland conducted by the **Contractor** and any individual or legal entity in which the **Contractor** holds a ten (10%) percent or greater ownership interest in the **Contractor** will be conducted in accordance with the MacBride Principles of nondiscrimination in employment.

69.1.3 Prospective **Contractors** are not required to agree to these conditions. However, in the case of **Contracts** let by competitive sealed bidding, whenever the lowest responsible bidder has not agreed to stipulate to the conditions set forth in this notice and another bidder who has agreed to stipulate to such conditions has submitted a bid within five (5%) percent of the lowest responsible bid for a **Contract** to supply goods, services or contraction of comparable quality, the **Agency** shall refer such bids to the Mayor, the Speaker or other officials, as appropriate, who may determine, in accordance with applicable **Law**, that it is in the best interest of the **City** that the **Contract** be awarded to other than the lowest responsible pursuant to Section 313(b)(2) of the **City Charter**.

69.1.4 In the case of **Contracts** let by other than competitive sealed bidding, if a prospective **Contractor** does not agree to these conditions, no **Agency**, elected official or the **City Council** shall award the **Contract** to that bidder unless the **Agency** seeking to use the goods, services or construction certifies in writing that the **Contract** is necessary for the **Agency** to perform its functions and there is no other responsible **Contractor** who will supply goods, services or construction of comparable quality at a comparable price.

69.2 In accordance with Section 6-115.1 of the Administrative Code, the **Contractor** stipulates that such **Contractor** and any individual or legal entity in which the **Contractor** holds a ten (10%) percent or greater ownership interest in the **Contractor** either:

69.2.1 Have no business operations in Northern Ireland, or

69.2.2 Shall take lawful steps in good faith to conduct any business operations they have in Northern Ireland in accordance with the MacBride Principles, and shall permit independent monitoring of their compliance with such principles.

69.3 For purposes of this Article, the following terms shall have the following meanings:

69.3.1 "MacBride Principles" shall mean those principles relating to nondiscrimination in employment and freedom of work-place opportunity which require employers doing business in Northern Ireland to:

69.3.1(a) increase the representation of individuals from under-represented religious groups in the workforce, including managerial, supervisory, administrative, clerical and technical jobs;

69.3.1(b) take steps to promote adequate security for the protection of employees from under-represented religious groups both at the work-place and while traveling to and from **Work**;

69.3.1(c) ban provocative religious or political emblems from the workplace;

69.3.1(d) publicly advertise all job openings and make special recruitment efforts to attract applicants from under-represented religious groups;

69.3.1(e) establish layoff, recall, and termination procedures which do not in practice favor a particular religious group;

69.3.1(f) abolish all job reservations, apprenticeship restrictions and different employment criteria which discriminate on the basis of religion;

69.3.1(g) develop training programs that will prepare substantial numbers of current employees from under-represented religious groups for skilled jobs, including the expansion of existing programs and the creation of new programs to train, upgrade, and improve the skills of workers from under-represented religious groups;

69.3.1(h) establish procedures to assess, identify, and actively recruit employees from under-represented religious groups with potential for further advancement; and

69.3.1(i) appoint a senior management staff member to oversee affirmative action efforts and develop a timetable to ensure their full implementation.

69.4 The **Contractor** agrees that the covenants and representations in Article 69.2 are material conditions to this **Contract**. In the event the **Agency** receives information that the **Contractor** who made the stipulation required by this Article 69 is in violation thereof, the **Agency** shall review such information and give the **Contractor** an opportunity to respond. If the **Agency** finds that a violation has occurred, the **Agency** shall have the right to declare the **Contractor** in default in default and/or terminate this **Contract** for cause and procure supplies, services or **Work** from another source in the manner the **Agency** deems proper. In the event of such termination, the **Contractor** shall pay to the **Agency**, or the **Agency** in its sole discretion may withhold from any amounts otherwise payable to the **Contractor**, the difference between the **Contract** price for the uncompleted portion of this **Contract** and the cost to the **Agency** of completing performance of this **Contract** either itself or by engaging another **Contractor** or **Contractors**. In the case of a requirement **Contract**, the **Contractor** shall be liable for such difference in price for the entire amount of supplies required by the **Agency** for the uncompleted term of **Contractor's Contract**. In the case of a construction **Contract**, the **Agency** shall also have the right to hold the **Contractor** in partial or total default in accordance with the default provisions of this **Contract**, and/or may seek debarment or suspension of the **Contractor**. The rights and remedies of the **Agency** hereunder shall be in addition to, and not in lieu of, any rights and remedies the **Agency** has pursuant to this **Contract** or by operation of **Law**.

ARTICLE 70. ELECTRONIC FILING/NYC DEVELOPMENT HUB

70.1 The **Contractor** shall electronically file all alteration type-2 and alteration type-3 applications via the New York City Development Hub Web site, except applications for the following types of minor alterations: enlargements, curb cuts, legalizations, fire alarms, builders pavement plans, and jobs filed on Landmark Preservation Commission calendared properties. All such filings must be professionally certified. Information about electronic filing via the New York City Development Hub is available on the City Department of Buildings Web site at www.nyc.gov/buildings.

ARTICLE 71. PROHIBITION OF TROPICAL HARDWOODS

71.1 Tropical hardwoods, as defined in Section 165 of the New York State Finance Law (Finance Law), shall not be utilized in the performance of this **Contract** except as expressly permitted by Section 165 of the Finance Law.

ARTICLE 72. CONFLICTS OF INTEREST

72.1 Section 2604 of the City Charter and other related provisions of the City Charter, the Administrative Code, and the Penal Law are applicable under the terms of this Contract in relation to conflicts of interest and shall be extended to **Subcontractors** authorized to perform **Work**, labor and services pursuant to this Contract and further, it shall be the duty and responsibility of the **Contractor** to so inform its respective **Subcontractors**. Notice is hereby given that, under certain circumstances, penalties may be invoked against the donor as well as the recipient of any form of valuable gift.

ARTICLE 73. MERGER CLAUSE

73.1 The written **Contract** herein, contains all the terms and conditions agreed upon by the parties hereto, and no other agreement, oral or otherwise, regarding the subject matter of this **Contract** shall be deemed to exist or to bind any of the parties hereto, or to vary any of the terms contained herein.

ARTICLE 74. STATEMENT OF WORK

74.1 The **Contractor** shall furnish all labor and materials and perform all **Work** in strict accordance with the **Specifications** and **Addenda** thereto, numbered 7.

ARTICLE 75. COMPENSATION TO BE PAID TO CONTRACTOR

75.1 The City will pay and the **Contractor** will accept in full consideration for the performance of the **Contract**, subject to additions and deductions as provided herein, the total sum of: Two million, One hundred thirty Dollars, (\$2,130,068.30), this said sum being the amount at which the **Contract** was awarded to the **Contractor** at a public letting thereof, based upon the **Contractor's** bid for the **Contract**. Three thousand Sixty eight dollars 30/100.

ARTICLE 76. ELECTRONIC FUNDS TRANSFER

76.1 In accordance with Section 6-107.1 of the Administrative Code, the **Contractor** agrees to accept payments under this **Contract** from the **City** by electronic funds transfer (EFT). An EFT is any transfer of funds, other than a transaction originated by check, draft or similar paper instrument, which is initiated through an electronic terminal, telephonic instrument or computer or magnetic tape so as to order, instruct or authorize a financial institution to debit or credit an account. Prior to the first payment made under this **Contract**, the **Contractor** shall designate one financial institution or other authorized payment agent and shall complete the attached "EFT Vendor Payment Enrollment Form" in order to provide the Commissioner of the City Department of Finance with information necessary for the **Contractor** to receive electronic funds transfer payments through a designated financial institution or authorized payment agent. The crediting of the amount of a payment to the appropriate account on the books of a financial institution or other authorized payment agent designated by the **Contractor** shall constitute full satisfaction by the **City** for the amount of the payment under this **Contract**. The account information supplied by the **Contractor** to facilitate the electronic funds transfer shall remain confidential to the fullest extent provided by **Law**.

76.2 The **Commissioner** may waive the application of the requirements of this Article 76 to payments on contracts entered into pursuant to Section 315 of the City Charter. In addition, the Commissioner of the Department of Finance and the Comptroller may jointly issue standards pursuant to

which the Agency may waive the requirements of this Article 76 for payment in the following circumstances: (i) for individuals or classes of individuals for whom compliance imposes a hardship; (ii) for classifications or types of checks; or (iii) in other circumstances as may be necessary in the interest of the City.

ARTICLE 77. RECORDS RETENTION

77.1 The Contractor agrees to retain all books, records, and other documents relevant to this Contract for six years after the final payment or termination of this Contract, whichever is later. City, state, and federal auditors and any other persons duly authorized by the City shall have full access to and the right to examine any such books, records, and other documents during the retention period.

ARTICLE 78. PARTICIPATION BY MINORITY-OWNED AND WOMEN-OWNED BUSINESS ENTERPRISES IN CITY PROCUREMENT

NOTICE TO ALL PROSPECTIVE CONTRACTORS

ARTICLE I. M/WBE PROGRAM

Local Law No. 129 of 2005 added and Local Law 1 of 2013 amended Section 6-129 of the Administrative Code of the City of New York (hereinafter "Section 6-129"). Section 6-129 establishes the program for participation in City procurement ("M/WBE Program") by minority-owned business enterprises ("MBEs") and women-owned business enterprises ("WBEs"), certified in accordance with Section 1304 of the New York City Charter. As stated in Section 6-129, the intent of the program is to address the impact of discrimination on the City's procurement process, and to promote the public interest in avoiding fraud and favoritism in the procurement process, increasing competition for City business, and lowering contract costs. The contract provisions contained herein are pursuant to Section 6-129, and the rules of the Department of Small Business Services ("DSBS") promulgated thereunder.

If this Contract is subject to the M/WBE Program established by Section 6-129, the specific requirements of MBE and/or WBE participation for this Contract are set forth in Schedule B of the Contract (entitled the "M/WBE Utilization Plan"), and are detailed below. The Contractor must comply with all applicable MBE and WBE requirements for this Contract.

All provisions of Section 6-129 are hereby incorporated in the Contract by reference and all terms used herein that are not defined herein shall have the meanings given such terms in Section 6-129. Article I, Part A, below, sets forth provisions related to the participation goals for construction, standard and professional services contracts. Article I, Part B, below, sets forth miscellaneous provisions related to the M/WBE Program.

PART A

PARTICIPATION GOALS FOR CONSTRUCTION, STANDARD AND PROFESSIONAL SERVICES CONTRACTS OR TASK ORDERS

1. The MBE and/or WBE Participation Goals established for this Contract or Task Orders issued pursuant to this Contract, ("Participation Goals"), as applicable, are set forth on Schedule B, Part I to this Contract (see Page 1, line 1 Total Participation Goals) or will be set forth on Schedule B, Part I to Task Orders issued pursuant to this Contract, as applicable.

The **Participation Goals** represent a percentage of the total dollar value of the Contract or Task Order, as applicable, that may be achieved by awarding subcontracts to firms certified with New York City Department of Small Business Services as MBEs and/or WBEs, and/or by crediting the participation of prime contractors and/or qualified joint ventures as provided in Section 3 below, unless the goals have been waived or modified by Agency in accordance with Section 6-129 and Part A, Sections 10 and 11 below, respectively.

2. If **Participation Goals** have been established for this Contract or Task Orders issued pursuant to this Contract, Contractor agrees or shall agree as a material term of the Contract that Contractor shall be subject to the **Participation Goals**, unless the goals are waived or modified by Agency in accordance with Section 6-129 and Part A, Sections 10 and 11 below, respectively.

3. If **Participation Goals** have been established for this Contract or Task Order issued pursuant to this Contract, a Contractor that is an MBE and/or WBE shall be permitted to count its own participation toward fulfillment of the relevant **Participation Goal**, provided that in accordance with Section 6-129 the value of Contractor's participation shall be determined by subtracting from the total value of the Contract or Task Order, as applicable, any amounts that the Contractor pays to direct subcontractors (as defined in Section 6-129(c)(13)), and provided further that a Contractor that is certified as both an MBE and a WBE may count its own participation either toward the goal for MBEs or the goal for WBEs, but not both.

A Contractor that is a qualified joint venture (as defined in Section 6-129(c)(30)) shall be permitted to count a percentage of its own participation toward fulfillment of the relevant **Participation Goal**. In accordance with Section 6-129, the value of Contractor's participation shall be determined by subtracting from the total value of the Contract or Task Order, as applicable, any amounts that Contractor pays to direct subcontractors, and then multiplying the remainder by the percentage to be applied to total profit to determine the amount to which an MBE or WBE is entitled pursuant to the joint venture agreement, provided that where a participant in a joint venture is certified as both an MBE and a WBE, such amount shall be counted either toward the goal for MBEs or the goal for WBEs, but not both.

4. A. If **Participation Goals** have been established for this Contract, a prospective contractor shall be required to submit with its bid or proposal, as applicable, a completed Schedule B, M/WBE Utilization Plan, Part II (see Pages 2-4) indicating: (a) whether the contractor is an MBE or WBE, or qualified joint venture; (b) the percentage of work it intends to award to direct subcontractors; and (c) in cases where the contractor intends to award direct subcontracts, a description of the type and dollar value of work designated for participation by MBEs and/or WBEs, and the time frames in which such work is scheduled to begin and end. In the event that this M/WBE Utilization Plan indicates that the bidder or proposer, as applicable, does not intend to meet the **Participation Goals**, the bid or proposal, as applicable, shall be deemed non-responsive, unless Agency has granted the bidder or proposer, as applicable, a pre-award waiver of the Participation Goals in accordance with Section 6-129 and Part A, Section 10 below.

B. (i) If this Contract is for a master services agreement or other requirements type contract that will result in the issuance of Task Orders that will be individually registered ("Master Services Agreement") and is subject to M/WBE **Participation Goals**, a prospective contractor shall be required to submit with its bid or proposal, as applicable, a completed Schedule B, M/WBE Participation Requirements for Master Services Agreements That Will Require Individually Registered Task Orders, Part II (page 2) indicating the prospective contractor's certification and required affirmations to make all reasonable good faith efforts to meet participation goals established on each individual Task Order issued pursuant to this Contract, or if a partial waiver is obtained or such goals are modified by the Agency, to meet the modified **Participation Goals** by soliciting and obtaining the participation of certified MBE and/or WBE firms. In the event that the Schedule B indicates that the bidder or proposer, as applicable, does not intend to meet the **Participation Goals** that may be established on Task Orders issued pursuant to this Contract, the bid or proposal, as applicable, shall be deemed nonresponsive.

(ii) **Participation Goals** on a Master Services Agreement will be established for individual Task Orders issued after the Master Services Agreement is awarded. If **Participation Goals** have been established on a Task Order, a contractor shall be required to submit a Schedule B – M/WBE Utilization Plan For Independently Registered Task Orders That Are Issued Pursuant to Master Services Agreements, Part II (see Pages 2-4) indicating: (a) whether the contractor is an MBE or WBE, or qualified joint venture; (b) the percentage of work it intends to award to direct subcontractors; and (c) in cases where the contractor intends to award direct subcontracts, a description of the type and dollar value of work designated for participation by MBEs and/or WBEs, and the time frames in which such work is scheduled to begin and end. The contractor must engage in good faith efforts to meet the **Participation Goals** as established for the Task Order unless Agency has granted the contractor a pre-award waiver of the Participation Goals in accordance with Section 6-129 and Part A, Section 10 below.

C. THE BIDDER/PROPOSER MUST COMPLETE THE SCHEDULE B INCLUDED HEREIN (SCHEDULE B, PART II). A SCHEDULE B SUBMITTED BY THE BIDDER/PROPOSER WHICH DOES NOT INCLUDE THE VENDOR CERTIFICATION AND REQUIRED AFFIRMATIONS (SEE SECTION V OF PART II) WILL BE DEEMED TO BE NON-RESPONSIVE, UNLESS A FULL WAIVER OF THE PARTICIPATION GOALS IS GRANTED (SCHEDULE B, PART III). IN THE EVENT THAT THE CITY DETERMINES THAT THE BIDDER/PROPOSER HAS SUBMITTED A SCHEDULE B WHERE THE VENDOR CERTIFICATION AND REQUIRED AFFIRMATIONS ARE COMPLETED BUT OTHER ASPECTS OF THE SCHEDULE B ARE NOT COMPLETE, OR CONTAIN A COPY OR COMPUTATION ERROR THAT IS AT ODDS WITH THE VENDOR CERTIFICATION AND AFFIRMATIONS, THE BIDDER/PROPOSER WILL BE NOTIFIED BY THE AGENCY AND WILL BE GIVEN FOUR (4) CALENDAR DAYS FROM RECEIPT OF NOTIFICATION TO CURE THE SPECIFIED DEFICIENCIES AND RETURN A COMPLETED SCHEDULE B TO THE AGENCY. FAILURE TO DO SO WILL RESULT IN A DETERMINATION THAT THE BID/PROPOSAL IS NON-RESPONSIVE. RECEIPT OF NOTIFICATION IS DEFINED AS THE DATE NOTICE IS E-MAILED OR FAXED (IF THE BIDDER/PROPOSER HAS PROVIDED AN E-MAIL ADDRESS OR FAX NUMBER), OR NO LATER THAN FIVE (5) CALENDAR DAYS FROM THE DATE OF MAILING OR UPON DELIVERY, IF DELIVERED.

5. Where an M/WBE Utilization Plan has been submitted, the Contractor shall, within 30 days of issuance by Agency of a notice to proceed, submit a list of proposed persons or entities to which it intends to award subcontracts within the subsequent 12 months. In the case of multiyear contracts, such list shall also be submitted every year thereafter. The Agency may also require the Contractor to report periodically about the contracts awarded by its direct subcontractors to indirect subcontractors (as defined in Section 6-129(c)(22)). **PLEASE NOTE: If this Contract is a public works project subject to GML §101(5) (i.e., a contract valued at or below \$3M for projects in New York City) or if the Contract is subject to a project labor agreement in accordance with Labor Law §222, and the bidder is required to identify at the time of bid submission its intended subcontractors for the Wicks trades (plumbing and gas fitting; steam heating, hot water heating, ventilating and air conditioning (HVAC); and electric wiring), the Contractor must identify all those to which it intends to award construction subcontracts for any portion of the Wicks trade work at the time of bid submission, regardless of what point in the life of the contract such subcontracts will occur. In identifying intended subcontractors in the bid submission, bidders may satisfy any Participation Goals established for this Contract by proposing one or more subcontractors that are MBEs and/or WBEs for any portion of the Wicks trade work. In the event that the Contractor's selection of a subcontractor is disapproved, the Contractor shall have a reasonable time to propose alternate subcontractors.**

6. MBE and WBE firms must be certified by DSBS in order for the Contractor to credit such firms' participation toward the attainment of the **Participation Goals**. Such certification must occur prior to the

firms' commencement of work. A list of MBE and WBE firms may be obtained from the DSBS website at www.nyc.gov/buycertified, by emailing DSBS at buyer@sbs.nyc.gov, by calling (212) 513-6356, or by visiting or writing DSBS at 110 William St., New York, New York, 10038, 7th floor. Eligible firms that have not yet been certified may contact DSBS in order to seek certification by visiting www.nyc.gov/getcertified, emailing MWBE@sbs.nyc.gov, or calling the DSBS certification helpline at (212) 513-6311. A firm that is certified as both an MBE and a WBE may be counted either toward the goal for MBEs or the goal for WBEs, but not both. No credit shall be given for participation by a graduate MBE or graduate WBE, as defined in Section 6-129(c)(20).

7. Where an **M/WBE Utilization Plan** has been submitted, the Contractor shall, with each voucher for payment, and/or periodically as Agency may require, submit statements, certified under penalty of perjury, which shall include, but not be limited to,: the total amount the Contractor paid to its direct subcontractors, and, where applicable pursuant to Section 6-129(j), the total amount direct subcontractors paid to indirect subcontractors; the names, addresses and contact numbers of each MBE or WBE hired as a subcontractor by the Contractor, and, where applicable, hired by any of the Contractor's direct subcontractors; and the dates and amounts paid to each MBE or WBE. The Contractor shall also submit, along with its voucher for final payment: the total amount it paid to subcontractors, and, where applicable pursuant to Section 6-129(j), the total amount its direct subcontractors paid directly to their indirect subcontractors; and a final list, certified under penalty of perjury, which shall include the name, address and contact information of each subcontractor that is an MBE or WBE, the work performed by, and the dates and amounts paid to each.

8. If payments made to, or work performed by, MBEs or WBEs are less than the amount specified in the Contractor's **M/WBE Utilization Plan**, Agency shall take appropriate action, in accordance with Section 6-129 and Article II below, unless the Contractor has obtained a modification of its **M/WBE Utilization Plan** in accordance with Section 6-129 and Part A, Section 11 below.

9. Where an **M/WBE Utilization Plan** has been submitted, and the Contractor requests a change order the value of which exceeds the greater of 10 percent of the Contract or Task Order, as applicable, or \$500,000, Agency shall review the scope of work for the Contract or Task Order, as applicable, and the scale and types of work involved in the change order, and determine whether the **Participation Goals** should be modified.

10. Pre-award waiver of the **Participation Goals**. (a) A bidder or proposer, or contractor with respect to a Task Order, may seek a pre-award full or partial waiver of the **Participation Goals** in accordance with Section 6-129, which requests that Agency change one or more **Participation Goals** on the grounds that the **Participation Goals** are unreasonable in light of the availability of certified firms to perform the services required, or by demonstrating that it has legitimate business reasons for proposing a lower level of subcontracting in its **M/WBE Utilization Plan**.

(b) To apply for a full or partial waiver of the **Participation Goals**, a bidder, proposer, or contractor, as applicable, must complete Part III (Page 5) of Schedule B and submit such request no later than seven (7) calendar days prior to the date and time the bids, proposals, or Task Orders are due, in writing to the Agency by email at poped@ddc.nyc.gov or via facsimile at (718) 391-1886. Bidders, proposers, or contractors, as applicable, who have submitted requests will receive an Agency response by no later than two (2) calendar days prior to the due date for bids, proposals, or Task Orders; provided, however, that if that date would fall on a weekend or holiday, an Agency response will be provided by close-of-business on the business day before such weekend or holiday date.

(c) If the Agency determines that the **Participation Goals** are unreasonable in light of the availability of certified firms to perform the services required, it shall revise the solicitation and extend the deadline for bids and proposals, or revise the Task Order, as applicable.

(d) Agency may grant a full or partial waiver of the **Participation Goals** to a bidder, proposer or contractor, as applicable, who demonstrates—before submission of the bid, proposal or Task Order, as applicable—that it has legitimate business reasons for proposing the level of subcontracting in its **M/WBE Utilization Plan**. In making its determination, Agency shall consider factors that shall include, but not be limited to, whether the bidder, proposer or contractor, as applicable, has the capacity and the bona fide intention to perform the Contract without any subcontracting, or to perform the Contract without awarding the amount of subcontracts represented by the **Participation Goals**. In making such determination, Agency may consider whether the **M/WBE Utilization Plan** is consistent with past subcontracting practices of the bidder, proposer or contractor, as applicable, whether the bidder, proposer or contractor, as applicable, has made efforts to form a joint venture with a certified firm, and whether the bidder, proposer, or contractor, as applicable, has made good faith efforts to identify other portions of the Contract that it intends to subcontract.

11. Modification of **M/WBE Utilization Plan**. (a) A Contractor may request a modification of its **M/WBE Utilization Plan** after award of this Contract. **PLEASE NOTE: If this Contract is a public works project subject to GML §101(5) (i.e., a contract valued at or below \$3M for projects in New York City) or if the Contract is subject to a project labor agreement in accordance with Labor Law §222, and the bidder is required to identify at the time of bid submission its intended subcontractors for the Wicks trades (plumbing and gas fitting; steam heating, hot water heating, ventilating and air conditioning (HVAC); and electric wiring), the Contractor may request a Modification of its M/WBE Utilization Plan as part of its bid submission.** The Agency may grant a request for Modification of a Contractor's **M/WBE Utilization Plan** if it determines that the Contractor has established, with appropriate documentary and other evidence, that it made reasonable, good faith efforts to meet the **Participation Goals**. In making such determination, Agency shall consider evidence of the following efforts, as applicable, along with any other relevant factors:

- (i) The Contractor advertised opportunities to participate in the Contract, where appropriate, in general circulation media, trade and professional association publications and small business media, and publications of minority and women's business organizations;
- (ii) The Contractor provided notice of specific opportunities to participate in the Contract, in a timely manner, to minority and women's business organizations;
- (iii) The Contractor sent written notices, by certified mail or facsimile, in a timely manner, to advise MBEs or WBEs that their interest in the Contract was solicited;
- (iv) The Contractor made efforts to identify portions of the work that could be substituted for portions originally designated for participation by MBEs and/or WBEs in the **M/WBE Utilization Plan**, and for which the Contractor claims an inability to retain MBEs or WBEs;
- (v) The Contractor held meetings with MBEs and/or WBEs prior to the date their bids or proposals were due, for the purpose of explaining in detail the scope and requirements of the work for which their bids or proposals were solicited;
- (vi) The Contractor made efforts to negotiate with MBEs and/or WBEs as relevant to perform specific subcontracts, or act as suppliers or service providers;
- (vii) Timely written requests for assistance made by the Contractor to Agency's **M/WBE liaison officer** and to **DSBS**;
- (viii) Description of how recommendations made by **DSBS** and Agency were acted upon and an explanation of why action upon such recommendations did not lead to the desired level of participation of MBEs and/or WBEs.

Agency's **M/WBE officer** shall provide written notice to the Contractor of the determination.

(b) The Agency may modify the **Participation Goals** when the scope of the work has been changed by the Agency in a manner that affects the scale and types of work that the Contractor indicated in its **M/WBE Utilization Plan** would be awarded to subcontractors.

12. If this Contract is for an indefinite quantity of construction, standard or professional services or is a requirements type contract and the Contractor has submitted an **M/WBE Utilization Plan** and has committed to subcontract work to MBEs and/or WBEs in order to meet the **Participation Goals**, the Contractor will not be deemed in violation of the M/WBE Program requirements for this Contract with regard to any work which was intended to be subcontracted to an MBE and/or WBE to the extent that the Agency has determined that such work is not needed.

13. If **Participation Goals** have been established for this Contract or a Task Order issued pursuant to this Contract, at least once annually during the term of the Contract or Task Order, as applicable, Agency shall review the Contractor's progress toward attainment of its M/WBE Utilization Plan, including but not limited to, by reviewing the percentage of work the Contractor has actually awarded to MBE and/or WBE subcontractors and the payments the Contractor made to such subcontractors.

14. If **Participation Goals** have been established for this Contract or a Task Order issued pursuant to this Contract, Agency shall evaluate and assess the Contractor's performance in meeting those goals, and such evaluation and assessment shall become part of the Contractor's overall contract performance evaluation.

PART B: MISCELLANEOUS

1. The Contractor shall take notice that, if this solicitation requires the establishment of an **M/WBE Utilization Plan**, the resulting contract may be audited by DSBS to determine compliance with Section 6-129. See §6-129(e)(10). Furthermore, such resulting contract may also be examined by the City's Comptroller to assess compliance with the **M/WBE Utilization Plan**.

2. Pursuant to DSBS rules, construction contracts that include a requirement for an **M/WBE Utilization Plan** shall not be subject to the law governing Locally Based Enterprises set forth in Section 6-108.1 of the Administrative Code of the City of New York.

3. DSBS is available to assist contractors and potential contractors in determining the availability of MBEs and/or WBEs to participate as subcontractors, and in identifying opportunities that are appropriate for participation by MBEs and/or WBEs in contracts.

4. Prospective contractors are encouraged to enter into qualified joint venture agreements with MBEs and/or WBEs as defined by Section 6-129(c)(30).

5. By submitting a bid or proposal the Contractor hereby acknowledges its understanding of the M/WBE Program requirements set forth herein and the pertinent provisions of Section 6-129, and any rules promulgated thereunder, and if awarded this Contract, the Contractor hereby agrees to comply with the M/WBE Program requirements of this Contract and pertinent provisions of Section 6-129, and any rules promulgated thereunder, all of which shall be deemed to be material terms of this Contract. The Contractor hereby agrees to make all reasonable, good faith efforts to solicit and obtain the participation of MBEs and/or WBEs to meet the required **Participation Goals**.

ARTICLE II. ENFORCEMENT

1. If Agency determines that a bidder or proposer, as applicable, has, in relation to this procurement, violated Section 6-129 or the DSBS rules promulgated pursuant to Section 6-129, Agency may disqualify such bidder or proposer, as applicable, from competing for this Contract and the Agency may revoke such bidder's or proposer's prequalification status, if applicable.

2. Whenever Agency believes that the Contractor or a subcontractor is not in compliance with Section 6-129 or the DSBS rules promulgated pursuant to Section 6-129, or any provision of this Contract that implements Section 6-129, including, but not limited to any **M/WBE Utilization Plan**, Agency shall send a written notice to the Contractor describing the alleged noncompliance and offering the Contractor an opportunity to be heard. Agency shall then conduct an investigation to determine whether such Contractor or subcontractor is in compliance.

3. In the event that the Contractor has been found to have violated Section 6-129, the DSBS rules promulgated pursuant to Section 6-129, or any provision of this Contract that implements Section 6-129, including, but not limited to, any **M/WBE Utilization Plan**, Agency may determine that one of the following actions should be taken:

- (a) entering into an agreement with the Contractor allowing the Contractor to cure the violation;
- (b) revoking the Contractor's pre-qualification to bid or make proposals for future contracts;
- (c) making a finding that the Contractor is in default of the Contract;
- (d) terminating the Contract;
- (e) declaring the Contractor to be in breach of Contract;
- (f) withholding payment or reimbursement;
- (g) determining not to renew the Contract;
- (h) assessing actual and consequential damages;
- (i) assessing liquidated damages or reducing fees, provided that liquidated damages may be based on amounts representing costs of delays in carrying out the purposes of the **M/WBE Program**, or in meeting the purposes of the Contract, the costs of meeting utilization goals through additional procurements, the administrative costs of investigation and enforcement, or other factors set forth in the Contract;
- (j) exercising rights under the Contract to procure goods, services or construction from another contractor and charge the cost of such contract to the Contractor that has been found to be in noncompliance; or
- (k) taking any other appropriate remedy.

4. If an **M/WBE Utilization Plan** has been submitted, and pursuant to this Article II, Section 3, the Contractor has been found to have failed to fulfill its **Participation Goals** contained in its **M/WBE Utilization Plan** or the **Participation Goals** as modified by Agency pursuant to Article I, Part A, Section 11, Agency may assess liquidated damages in the amount of ten percent (10%) of the difference between the dollar amount of work required to be awarded to MBE and/or WBE firms to meet the **Participation Goals** and the dollar amount the Contractor actually awarded and paid, and/or credited, to MBE and/or WBE firms. In view of the difficulty of accurately ascertaining the loss which the City will suffer by reason of Contractor's failure to meet the **Participation Goals**, the foregoing amount is hereby fixed and agreed as the liquidated damages that the City will suffer by reason of such failure, and not as a penalty. Agency may deduct and retain out of any monies which may become due under this Contract the amount of any such liquidated damages; and in case the amount which may become due under this Contract shall be less than the amount of liquidated damages suffered by the City, the Contractor shall be liable to pay the difference.

5. Whenever Agency has reason to believe that an MBE and/or WBE is not qualified for certification, or is participating in a contract in a manner that does not serve a commercially useful function (as defined in Section 6-129(c)(8)), or has violated any provision of Section 6-129, Agency shall notify the Commissioner of DSBS who shall determine whether the certification of such business enterprise should be revoked.

6. Statements made in any instrument submitted to Agency pursuant to Section 6-129 shall be submitted under penalty of perjury and any false or misleading statement or omission shall be grounds for the application of any applicable criminal and/or civil penalties for perjury. The making of a false or fraudulent statement by an MBE and/or WBE in any instrument submitted pursuant to Section 6-129 shall, in addition, be grounds for revocation of its certification.

7. The Contractor's record in implementing its M/WBE Utilization Plan shall be a factor in the evaluation of its performance. Whenever Agency determines that a Contractor's compliance with an M/WBE Utilization Plan has been unsatisfactory, Agency shall, after consultation with the City Chief Procurement Officer, file an advice of caution form for inclusion in VENDEX as caution data.

Deputy

IN WITNESS WHEREOF, the Commissioner, on behalf of the City of New York, and the Contractor, have executed this agreement in quadruplicate, two parts of which are to remain with the Commissioner, another to be filed with the Comptroller of the City, and the fourth to be delivered to the Contractor.

THE CITY OF NEW YORK

By: [Signature]
Deputy Commissioner

CONTRACTOR:

By: [Signature]
(Member of Firm or Officer of Corporation)

Title: Vice President

(Where Contractor is a Corporation, add):
Attest:

[Signature]
Secretary

(Seal)

ACKNOWLEDGEMENT OF PRINCIPAL, IF A CORPORATION

State of New York County of Queens ss:

On this 1st day of Feb, 2014, before me personally came Joseph Pizzarisso to me known who, being by me duly sworn did depose and say that he resides at 2747 Judith Ave. ~~2747 Judith Ave. Bellmore NY 11706~~ that he is the Vice President of the corporation described in and which executed the foregoing instrument; that he knows the seal of said corporation; that one of the seals affixed to said instrument is such seal; that it was so affixed by order of the directors of said corporation, and that he signed his name thereto by like order.

SIMONE SMITH
Commissioner of Deeds
City of New York No. 4-6780
Certificate Filed in New York County
Commission Expires 01/01/18

Simone Smith
Notary Public or Commissioner of Deeds

ACKNOWLEDGEMENT OF PRINCIPAL, IF A PARTNERSHIP

State of _____ County of _____ ss:

On this _____ day of _____, _____, before me personally appeared _____ to me known, and known to me to be one of the members of the firm of _____ described in and who executed the foregoing instrument; and he acknowledged to me that he executed the same as and for the act and deed of said firm.

Notary Public or Commissioner of Deeds

ACKNOWLEDGEMENT OF PRINCIPAL, IF AN INDIVIDUAL

State of _____ County of _____ ss:

On this _____ day of _____, _____, before me personally appeared _____ to me known, and known to me to be the person described in and who executed the foregoing instrument; and acknowledged that he executed the same.

Notary Public or Commissioner of Deeds

ACKNOWLEDGEMENT BY COMMISSIONER

State of New York County of Queens ss:

On this 2nd day of Feb, 2016, before me personally came Eric Mafarlane to me known, and known to be the Deputy Commissioner of the Department of Design and Construction of The City of New York, the person described as such in and who as such executed the foregoing instrument and acknowledged to me that he executed the same as Deputy Commissioner for the purposes therein mentioned.

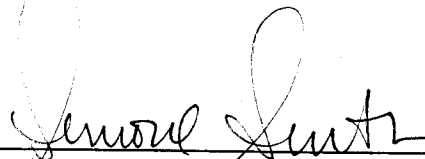

Notary Public or Commissioner of Deeds

SIMONE SMITH
Commissioner of Deeds
City of New York No. 4-6780
Certificate Filed in New York County
Commission Expires 01/16/16

AUTHORITY

MAYOR'S CERTIFICATE NO. CBX
BUDGET DIRECTOR'S CERTIFICATE NO.

DATED
DATED

APPROPRIATION
COMMISSIONER'S CERTIFICATE

In conformity with the provisions of Section 6-101 of the Administrative Code of the City of New York, it is hereby certified that the estimated cost of the work, materials and supplies required by the within Contract, amounting to

Two million One hundred thirty thousand
Sixty eight dollars 30/100

Dollars (\$) 2,130,068.30

is chargeable to the fund of the Department of Design and Construction entitled Code

HWPEdSF1

Department of Design and Construction

I hereby certify that the specifications contained herein comply with the terms and conditions of the BUDGET.

G. [Signature]
Deputy Commissioner

COMPTROLLER'S CERTIFICATE

The City of New York _____

Pursuant to the provisions of Section 6-101 of the Administrative Code of the City of New York, I hereby certify that there remains unapplied and unexpended a balance of the above mentioned fund applicable to this Contract sufficient to pay the estimated expense of executing the same viz:

\$ _____

Comptroller

Performance Bond #1 (Pages 92 to 95): Use if the total contract price is \$5 Million Or Less. Performance Bond #1 has been approved by the U.S. Small Business Administration ("SBA") for participation in its Bond Guarantee Program.

PERFORMANCE BOND #1 (Page 1)

PERFORMANCE BOND #1

KNOW ALL PERSONS BY THESE PRESENTS:

That we, J. Pizzirusso Landscaping Corp

7104 Avenue W

Brooklyn, NY 11234-6647

hereinafter referred to as the "Principal,"
and, Endurance American Insurance Company

7104 Avenue W

Brooklyn, NY 11234-6647

hereinafter referred to as the "Surety" ("Sureties") are held and firmly bound to THE CITY OF NEW YORK, hereinafter referred to as the "City" or to its successors and assigns in the penal sum of Two Million One Hundred Thirty Thousand Sixty-Eight Dollars and 30/100 - - -

(\$2,130,068.30) Dollars, lawful money of the United States for the payment of which said sum of money well and truly to be made, we, and each of us, bind ourselves, our heirs, executors, administrators, successors and assigns, jointly and severally, firmly by these presents.

WHEREAS, the Principal is about to enter, or has entered, into a Contract in writing with the City for

FMS ID: HWPEDSF1/E-PIN: 85015B0051001/DDC PIN: 8502013HW0079C - Multi-Site Pedestrian Safety - 31st Street & 39th Avenue, Etc. Borough of Queens.

a copy of which Contract is annexed to and hereby made a part of this bond as though herein set forth in full;

NOW, THEREFORE, the conditions of this obligation are such that if the Principal, his or its representatives or assigns, shall well and faithfully perform the said Contract and all modifications, amendments, additions and alterations thereto that may hereafter be made, according to its terms and its true intent and meaning, including repair and or replacement of defective work and guarantees of maintenance for the periods stated in the Contract, and shall fully indemnify and save harmless the City from all cost and damage which it may suffer by reason of the Principal's default of the Contract, and shall fully reimburse and repay the City for all outlay and expense which the City may incur in making

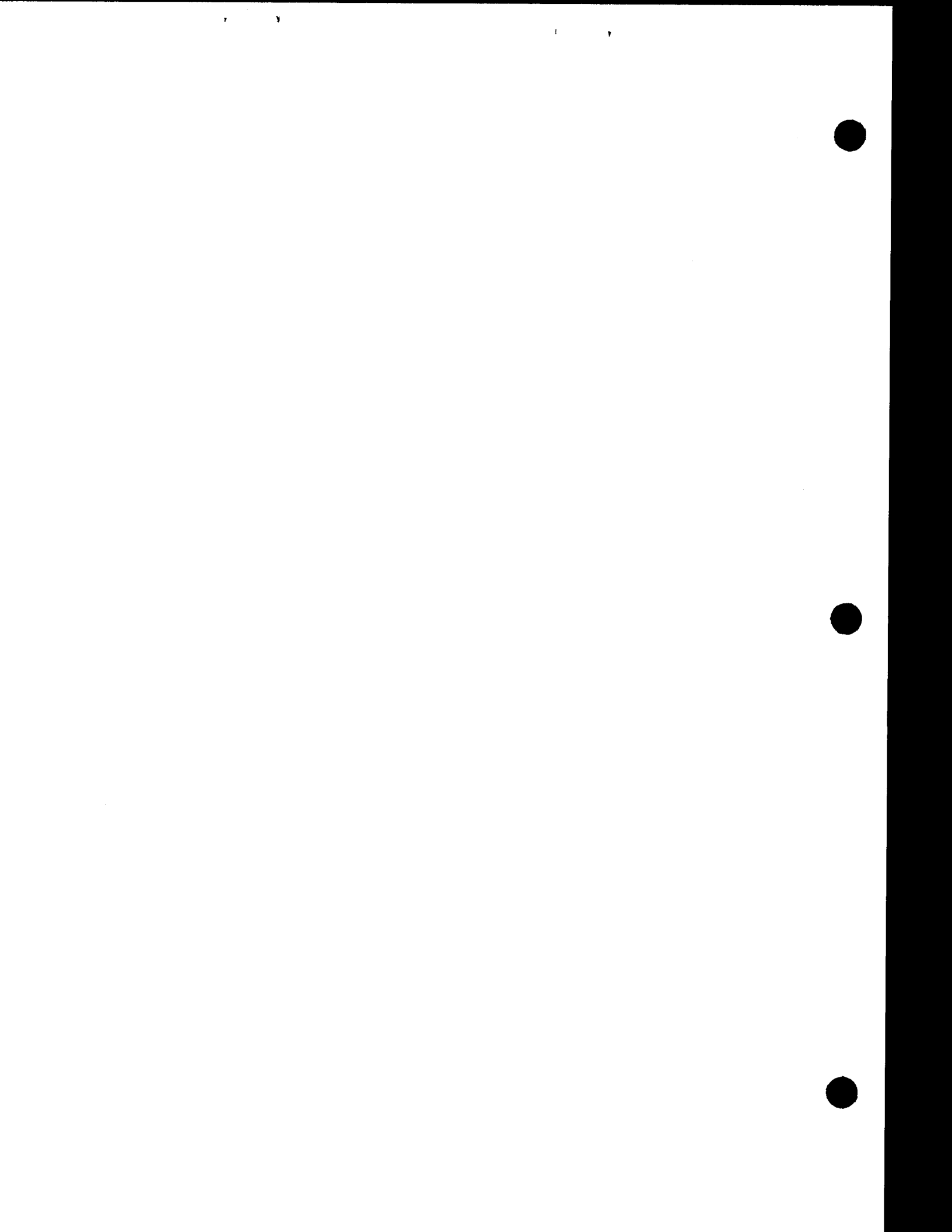

Performance Bond #1 (Pages 92 to 95): Use if the total contract price is \$5 Million Or Less. Performance Bond #1 has been approved by the U.S. Small Business Administration ("SBA") for participation in its Bond Guarantee Program.

PERFORMANCE BOND #1 (Page 2)

good any such default and shall protect the said City of New York against, and pay any and all amounts, damages, cost and judgments which may or shall be recovered against said City or its officers or agents or which the said City of New York may be called upon to pay any person or corporation by reason of any damages arising or growing out of the Principal's default of the Contract, then this obligation shall be null and void, otherwise to remain in full force and effect.

The Surety (Sureties), for value received, hereby stipulates and agrees, upon written notice from the City that the City has determined that the Principal is in default of the Contract, to (1) pay the City the cost to complete the contract as determined by the City in excess of the balance of the Contract held by the City, plus any damages or costs to which the City is entitled, up to the full amount of the above penal sum, (2) fully perform and complete the Work to be performed under the Contract, pursuant to the terms, conditions, and covenants thereof, or (3) tender a completion Contractor that is acceptable to the City. The Surety (Sureties) further agrees, at its option, either to notify the City that it elects to pay the city the cost of completion plus any applicable damages and costs under option (1) above, or to commence and diligently perform the Work specified in the Contract, including physical site work, within twenty-five (25) business days after written notice thereof from the City and, if the Surety elects to fully perform and complete the Work, then to complete all Work within the time set forth in the Contract or such other time as agreed to between the City and Surety in accordance with the Contract. If the Surety elects to tender payment pursuant to (1) above, then the Surety shall tender such amount within fifteen (15) business days notification from the City of the cost of completion. The Surety and the City reserve all rights and defenses each may have against the other; provided, however, that the Surety expressly agrees that its reservation of rights shall not provide a basis for non-performance of its obligation to pay the City the cost of completion, to commence and complete all Work as provided herein, or to tender a completion contractor.

The Surety (Sureties), for value received, for itself and its successors and assigns, hereby stipulates and agrees that the obligation of said Surety (Sureties) and its bond shall be in no way impaired or affected by any extension of time, modification, omission, addition, or change in or to the said Contract or the Work to be performed thereunder, or by any payment thereunder before the time required therein, or by any waiver of any provisions thereof, or any moneys due or to become due thereunder; and said Surety (Sureties) does hereby waive notice of any and all of such extensions, modifications, omissions, additions, changes, payments, and waivers, and hereby expressly stipulates and agrees that any and all things done and omitted to be done by and in relation to subcontractors shall have the same effect as to said Surety (Sureties) as though done or omitted to be done by or in relation to said Principal. Notwithstanding the above, if the City makes payments to the Principal before the time required by the contract that in the aggregate exceed \$100,000 or 10% of the Contract price, whichever is less, and that have not become earned prior to the Principal being found to be in default, then all payments made to the Principal before the time required by the Contract shall be added to the remaining contract value available to be paid for the completion of the Contract as if such sums had not been paid to the Principal, but shall not provide a basis for non-performance of its obligation to pay the City the cost of completion, to commence and to complete all Work as provided herein, or to tender a completion contractor.



Performance Bond #1 (Pages 92 to 95): Use if the total contract price is \$5 Million Or Less. Performance Bond #1 has been approved by the U.S. Small Business Administration ("SBA") for participation in its Bond Guarantee Program.

PERFORMANCE BOND #1 (Page 3)

IN WITNESS WHEREOF, The Principal and the Surety (Sureties) have hereunto set their hands and seals, and such of them as are corporations have caused their corporate seals to be hereunto affixed and these presents to be signed by their proper officers, this

_____ 21st _____ day of _____ January _____, 2016 _____
(Seal)

J. Pizzirusso Landscaping Corp. _____ (L.S.)

Principal

By: _____
Joseph Pizzirusso, Vice-President

(Seal)

Surety

Endurance American Insurance Company

By: Victoria Rivera _____
Victoria Rivera, Attorney-in-Fact

(Seal)

Surety

By: _____

(Seal)

Surety

By: _____

(Seal)

Surety

By: _____

(Seal)

Surety

By: _____

Bond Premium Rate _____

Bond Premium Cost _____

If the Contractor (Principal) is a partnership, the bond should be signed by each of the individuals who are partners.

If the Contractor (Principal) is a corporation, the bond should be signed in its correct corporate name by a duly authorized officer, agent, or attorney-in-fact.

There should be executed an appropriate number of counterparts of the bond corresponding to the number of counterparts of the Contract.

1950-1951
1952-1953
1954-1955
1956-1957
1958-1959
1960-1961
1962-1963
1964-1965
1966-1967
1968-1969
1970-1971
1972-1973
1974-1975
1976-1977
1978-1979
1980-1981
1982-1983
1984-1985
1986-1987
1988-1989
1990-1991
1992-1993
1994-1995
1996-1997
1998-1999
2000-2001
2002-2003
2004-2005
2006-2007
2008-2009
2010-2011
2012-2013
2014-2015
2016-2017
2018-2019
2020-2021
2022-2023
2024-2025

Performance Bond #1 (Pages 92 to 95): Use if the total contract price is \$5 Million Or Less. Performance Bond #1 has been approved by the U.S. Small Business Administration ("SBA") for participation in its Bond Guarantee Program.

PERFORMANCE BOND #1 (Page 4)

ACKNOWLEDGMENT OF PRINCIPAL IF A CORPORATION

State of New York County of _____ ss:

On this _____ day of January, 2016 before me personally came Joseph Pizzirusso to me known, who, being by me duly sworn did depose and say that he/she resides at _____

_____ ; that he/she is the Vice-President of the corporation described in and which executed the foregoing instrument; and that he/she signed his/her name to the foregoing instrument by order of the directors of said corporation as the duly authorized and binding act thereof.

Joanna Cascio
Notary Public or Commissioner of Deeds.

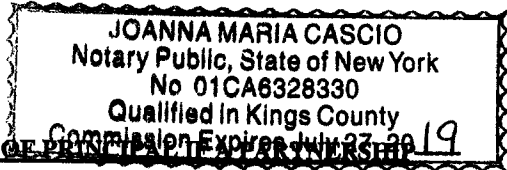

ACKNOWLEDGMENT OF PRINCIPAL IF AN INDIVIDUAL

State of _____ County of _____ ss:

On this _____ day of _____, 20 _____ before me personally came _____ to me known, who, being by me duly sworn did depose and say that he/she resides at _____

_____ ; that he/she is _____ partner of _____, a limited/general partnership existing under the laws of the State of _____, the partnership described in and which executed the foregoing instrument; and that he/she signed his/her name to the foregoing instrument as the duly authorized and binding act of said partnership.

Notary Public or Commissioner of Deeds.

ACKNOWLEDGMENT OF PRINCIPAL IF AN INDIVIDUAL

State of _____ County of _____ ss:

On this _____ day of _____, 20 _____ before me personally came _____ to me known, who, being by me duly sworn did depose and say that he/she resides at _____

_____ and that he/she is the individual whose name is subscribed to the within instrument and acknowledged to me that by his/her signature on the instrument, said individual executed the instrument.

Notary Public or Commissioner of Deeds

Each executed bond should be accompanied by: (a) appropriate acknowledgments of the respective parties; (b) appropriate duly certified copy of Power of Attorney or other certificate of authority where bond is executed by agent, officer or other representative of Principal or Surety; (c) a duly certified extract from By-Laws or resolutions of Surety under which Power of Attorney or other certificate of authority of its agent, officer or representative was issued, and (d) certified copy of latest published financial statement of assets and liabilities of Surety.

Affix Acknowledgments and Justification of Sureties.



ACKNOWLEDGEMENT OF SURETY

STATE OF New York)
COUNTY OF Erie) ss
CITY OF BUFFALO)

On this 21st day of January in the year 2016, before me personally
came Victoria Rivera, to me known, who, being by me duly sworn, did depose
and say that he/she/they reside (s) Buffalo, NY, that he/she/they (is) (are) the
Attorney-in-Fact duly appointed of the Endurance American Insurance Company
the corporation described in and which executed the above instrument; that he/she/they
know(s) the seal of said corporation; that the seal affixed to said instrument is such corporate
seal; that it was so affixed by authority of the board of directors of said corporation, and that
he/she/they signed his/her/their name(s) thereto by like authority.

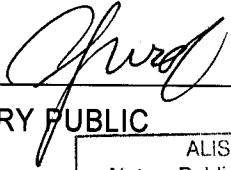

NOTARY PUBLIC

ALISSA J WOLF Notary Public, State of New York No. 01WO6284714 Qualified in Erie County Commission Expires June 24, 20____
--



POWER OF ATTORNEY

Know all Men by these Presents, that ENDURANCE AMERICAN INSURANCE COMPANY, a Delaware corporation (the "Corporation"), with offices at 750 Third Avenue, New York, New York 10017, has made, constituted and appointed and by these presents, does make, constitute and appoint

LORIANN FAY, TIMOTHY M. TOOLE, VICTORIA RIVERA, ALISSA J. WOLF

its true and lawful Attorney(s)-in-fact, at BUFFALO in the State of NY and each of them to have full power to act without the other or others, to make, execute, seal and deliver for and on its behalf bonds, undertakings or obligations in surety or co-surety with others, also to execute and deliver on its behalf renewals, extensions, agreements, waivers, consents or stipulations relating to such aforesaid bonds, undertakings or obligations provided, however, that no single bond or undertaking so made, executed and delivered shall obligate the Corporation for any portion of the penal sum thereof in excess of the sum of SEVEN MILLION FIVE HUNDRED THOUSAND Dollars (\$7,500,000.00).

Such bonds and undertakings for said purposes, when duly executed by said attorney(s)-in-fact, shall be binding upon the Corporation as fully and to the same extent as if signed by the President of the Corporation under its corporate seal attested by its Corporate Secretary.88

This appointment is made under and by authority of certain resolutions adopted by the Board of Directors of the Corporation by unanimous written consent on the 21st day of July, 2011, a copy of which appears below under the heading entitled "Certificate".

88

This Power of Attorney is signed and sealed by facsimile under and by authority of the following resolution adopted by the Board of Directors of the Corporation by unanimous written consent on the 21st day of July, 2011 and said resolution has not since been revoked, amended or repealed:

RESOLVED, that in granting powers of attorney pursuant to certain resolutions adopted by the Board of Directors of the Corporation by unanimous written consent on the 21st day of July, 2011, the signature of such directors and officers and the seal of the Corporation may be affixed to any such power of attorney or certificate relating thereto by facsimile, and any such power of attorney or certificate bearing such facsimile signature or seal shall be valid and binding upon the Corporation in the future with respect to any bond or undertaking to which it is attached.

This Power of Attorney shall expire and all authority hereunder shall terminate without notice at 12:01 a.m. (Standard Timer where said attorney(s)-in-fact is authorized to act.) JUNE 21ST, 2016.

IN WITNESS WHEREOF, the Corporation has caused these presents to be duly signed and its corporate seal to be hereunto affixed and attested this 22ND day of JUNE, 2015 at New York, New York. (Corporate Seal)

ENDURANCE AMERICAN INSURANCE COMPANY

ATTEST
Alfred N. Wright, Senior Vice President

By
Ronald Diggs, Vice President

STATE OF NEW YORK ss: MANHATTAN
COUNTY OF NEW YORK

On the 22ND day of JUNE, 2015 before me personally came RONALD DIGGS to me known, who being by me duly sworn, did depose and say that (s)he resides in HELLERTOWN, PENNSYLVANIA that (s)he is a VICE PRESIDENT of ENDURANCE AMERICAN INSURANCE COMPANY, the corporation described in and which executed the above instrument; that (s)he knows the seal of said corporation; that the seal affixed to said instrument is such corporate seal; that it was so affixed by order of the Board of Directors of said corporation, and that (s)he signed his (her) name thereto by like order. (Notarial Seal)

.....
Anie Licari, Notary Public - My Commission Expires: October 29, 2016

CERTIFICATE

STATE OF NEW YORK ss: MANHATTAN
COUNTY OF NEW YORK

I, Doug Worman, the Chief Executive Officer of ENDURANCE AMERICAN INSURANCE COMPANY, a Delaware Corporation (the "Corporation"), hereby certify:

- 1. That the original power of attorney of which the foregoing is a copy was duly executed on behalf of the Corporation and has not since been revoked, amended or modified; that the undersigned has compared the foregoing copy thereof with the original power of attorney, and that the same is a true and correct copy of the original power of attorney and of the whole thereof;
- 2. The following are resolutions which were adopted by the Board of Directors of the Corporation by unanimous written consent on the 21st day of July, 2011 and said resolutions have not since been revoked, amended or modified:

"RESOLVED, that each of the individuals named below is authorized to make, execute, seal and deliver for and on behalf of the Corporation any and all bonds, undertakings or obligations in surety or co-surety with others and to execute and deliver for and on behalf of the Corporation renewals, extensions, agreements, waivers, consents or stipulations relating to such aforesaid bonds, undertakings or obligations:

ALFRED N. WRIGHT, RONALD DIGGS

And

RESOLVED FURTHER, that each of the individuals named above is authorized to appoint attorneys-in-fact for the purpose of making, executing, sealing and delivering bonds, undertakings or obligations in surety or co-surety for and on behalf of the Corporation.

- 3. The undersigned further certifies that the above resolutions are true and correct copies of the resolutions as so recorded and of the whole thereof.

IN WITNESS WHEREOF, I have hereunto set my hand and affixed the corporate seal this 21st day of January, 2016. (Corporate Seal)

.....
Doug Worman, Chief Executive Officer of U.S. Insurance



ENDURANCE AMERICAN INSURANCE COMPANY
Balance Sheet - Statutory - Basis
December 31, 2014

Assets:	
Bonds	\$ 300,479,343
Common stocks	90,259,052
Cash	28,823,471
Receivable for securities	7,034,443
Total cash and invested assets	<u>426,596,309</u>
Agents' balances or uncollected premiums	611,326,868
Reinsurance recoverable on loss and loss adjustment expense payments	188,836,551
Funds held by or deposited with reinsurers companies	12,577,282
Current federal and foreign income tax recoverable	222,552
Investment income due and accrued	1,380,223
Receivables from parent, subsidiaries and affiliates	2,916,663
Total admitted assets	<u>\$ 1,243,856,448</u>
Liabilities:	
Loss and loss adjustment expenses	\$ 204,125,794
Reinsurance payable on paid loss and loss adjustment expenses	330,820,037
Unearned premiums	78,904,134
Ceded reinsurance premiums payable	357,992,680
Provision for reinsurance	1,037,000
Payable to parent, subsidiaries and affiliates	6,457,166
Payable for securities	14,792,578
Other liabilities	8,525,697
Total liabilities	<u>1,002,655,086</u>
Capital and surplus:	
Common capital stock	6,000,000
Gross paid in and contributed surplus	531,153,297
Unassigned funds (surplus)	<u>(295,951,935)</u>
Total capital and surplus	<u>241,201,362</u>
Total liabilities and capital and surplus	<u>\$ 1,243,856,448</u>

I, Stan Osofsky, Treasurer of Endurance American Insurance Company (the "Company") do hereby certify that to the best of my knowledge and belief, the foregoing is a full and true Statutory Statement of Admitted Assets, Liabilities, Capital and Surplus of the Company as of December 31, 2014 prepared in conformity with accounting practices prescribed or permitted by the State of Delaware Department of Insurance. The foregoing statement should not be taken as a complete statement of financial condition of the Company. Such a statement is available upon request at the Company's office located at 4 Manhattanville Road, 3rd Floor, Purchase, NY 10577.

IN WITNESS WHEREOF, I have hereunto set my hand and affixed the seal of the Company at New York, New York.

 Stan Osofsky, Treasurer

Subscribed and sworn to before me this 12th day of March, 2015

ROSE CHARLES
 Notary Public, State of New York
 No. 02CH172944
 Qualified in New York County
 My Commission Expires Aug 12, 2015





Payment Bond (Pages 100 to 103): Use for any contract for which a Payment Bond is required.

PAYMENT BOND (Page 1)

PAYMENT BOND

KNOW ALL PERSONS BY THESE PRESENTS, That we, J. Pizzirusso Landscaping Corp

7104 Avenue W

Brooklyn, NY 11234-6647

hereinafter referred to as the "Principal", and Endurance American Insurance Company

750 Third Avenue, 2nd Floor

New York, NY 10017-9014

hereinafter referred to as the "Surety" ("Sureties") are held and firmly bound to THE CITY OF NEW YORK, hereinafter referred to as the "City" or to its successors and assigns, in the penal sum of

Two Million One Hundred Thirty Thousand Sixty-Eight Dollars and 30/100 - - -

(\$2,130,068.30) Dollars, lawful money of the United States, for the payment of which said sum of money well and truly to be made, we, and each of us, bind ourselves, our heirs, executors, administrators, successors and assigns, jointly and severally, firmly by these presents.

WHEREAS, the Principal is about to enter, or has entered, into a Contract in writing with the City for

FMS ID: HWPEDSF1/E-PIN: 85015B0051001/DDC PIN: 8502013HW0079C - Multi-Site Pedestrian Safety - 31st Street & 39th

Avenue, Etc. Borough of Queens.

a copy of which Contract is annexed to and hereby made a part of this bond as though herein set forth in full;

NOW, THEREFORE, the conditions of this obligation are such that if the Principal, his or its representatives or assigns and other Subcontractors to whom Work under this Contract is sublet and his or their successors and assigns shall promptly pay or cause to be paid all lawful claims for

(a) Wages and compensation for labor performed and services rendered by all persons engaged in the prosecution of the Work under said Contract, and any amendment or extension thereof or addition thereto, whether such persons be agents servants or employees of the Principal or any such Subcontractor, including all persons so engaged who perform the work of laborers or mechanics at or in the vicinity of the site



Payment Bond (Pages 100 to 103): Use for any contract for which a Payment Bond is required.

PAYMENT BOND (Page 2)

of the Project regardless of any contractual relationship between the Principal or such Subcontractors, or his or their successors or assigns, on the one hand and such laborers or mechanics on the other, but not including office employees not regularly stationed at the site of the project; and

(b) Materials and supplies (whether incorporated in the permanent structure or not), as well as teams, fuels, oils, implements or machinery furnished, used or consumed by said Principal or any subcontractor at or in the vicinity of the site of the Project in the prosecution of the Work under said Contract and any amendment or extension thereof or addition thereto; then this obligation shall be void, otherwise to remain in full force and effect.

This bond is subject to the following additional conditions, limitations and agreements:

(a) The Principal and Surety (Sureties) agree that this bond shall be for the benefit of any materialmen or laborer having a just claim, as well as the City itself.

(b) All persons who have performed labor, rendered services or furnished materials and supplies, as aforesaid, shall have a direct right of action against the Principal and his, its or their successors and assigns, and the Surety (Sureties) herein, or against either or both or any of them and their successors and assigns. Such persons may sue in their own name, and may prosecute the suit to judgment and execution without the necessity of joining with any other persons as party plaintiff.

(c) The Principal and Surety (Sureties) agree that neither of them will hold the City liable for any judgment for costs of otherwise, obtained by either or both of them against a laborer or materialman in a suit brought by either a laborer or materialman under this bond for moneys allegedly due for performing work or furnishing material.

(d) The Surety (Sureties) or its successors and assigns shall not be liable for any compensation recoverable by an employee or laborer under the Workmen's Compensation Law.

(e) In no event shall the Surety (Sureties), or its successors or assigns, be liable for a greater sum than the penalty of this bond or be subject to any suit, action or proceeding hereon that is instituted by any person, firm, or corporation hereunder later than two years after the complete performance of said Contract and final settlement thereof.

The Principal, for himself and his successors and assigns, and the Surety (Sureties), for itself and its successors and assigns, do hereby expressly waive any objection that might be interposed as to the right of the City to require a bond containing the foregoing provisions, and they do hereby further expressly waive any defense which they or either of them might interpose to an action brought hereon by any person, firm or corporation, including subcontractors, materialmen and third persons, for work, labor, services, supplies or material performed rendered, or furnished as aforesaid upon the ground that there is no law authorizing the City to require the foregoing provisions to be placed in this bond.

And the Surety (Sureties), for value received, for itself and its successors and assigns, hereby stipulates and agrees that the obligation of said Surety (Sureties), and its bonds shall be in no way impaired or affected by any extension of time, modification, omission, addition, or change in or of the said Contract or the work to be performed thereunder, or by any payment thereunder before the time required therein, or by any waiver of any provisions thereof, or by any assignment, subletting or other transfer thereof or of any part thereof, or of any Work to be performed, or any moneys due to become due thereunder and said Surety (Sureties) does hereby waive notice of any and all of such extensions, modifications, omissions, additions, changes, payments, waivers, assignments, subcontracts and transfers, and hereby expressly stipulates and agrees that any and all things done and omitted to be done by and in relation to assignees, Subcontractors, and other transferees shall have the same effect as to said Surety (Sureties) as though done or omitted to be done or in relation to said Principal.



Payment Bond (Pages 100 to 103): Use for any contract for which a Payment Bond is required.

PAYMENT BOND (Page 3)

IN WITNESS WHEREOF, the Principal and the Surety (Sureties) have hereunto set their hands and seals, and such of them as are corporations have caused their corporate seals to be hereunto affixed and these presents to be signed by their proper officers, this 21st day of January, 2016.

(Seal) J. Pizzirusso Landscaping Corp. (L.S.)
Principal
By: [Signature]
Joseph Pizzirusso, Vice-President

(Seal) Endurance American Insurance Company
Surety
By: [Signature]
Victoria Rivera, Attorney-in-Fact

(Seal) _____
Surety
By: _____

(Seal) _____
Surety
By: _____

(Seal) _____
Surety
By: _____

If the Contractor (Principal) is a partnership, the bond should be signed by each of the individuals who are partners.

If the Contractor (Principal) is a corporation, the bond should be signed in its correct corporate name by a duly authorized officer, agent, or attorney-in-fact.

There should be executed an appropriate number of counterparts of the bond corresponding to the number of counterparts of the Contract.



Payment Bond (Pages 100 to 103): Use for any contract for which a Payment Bond is required.

PAYMENT BOND (Page 4)

ACKNOWLEDGMENT OF PRINCIPAL, IF A CORPORATION

State of New York County of _____ ss:

On this _____ day of January, 2016, before me personally came Joseph Pizzirusso to me known, who, being by me duly sworn did depose and say that he resides at _____ that he is the Vice-President of the corporation described in and which executed the foregoing instrument; that he knows the seal of said corporation; that one of the seals affixed to said instrument is such seal; that it was so affixed by order of the directors of said corporation, and that he signed his name thereto by like order.

JOANNA MARIA CASCIO
Notary Public, State of New York
No 01CA6328330
Qualified in Kings County
Commission Expires July 27, 2019

Joanna Cascio
Notary Public or Commissioner of Deeds

ACKNOWLEDGMENT OF PRINCIPAL, IF A PARTNERSHIP

State of _____ County of _____ ss:

On this _____ day of _____, _____, before me personally appeared _____ to me known, and known to me to be one of the members of the firm of _____ described in and who executed the foregoing instrument; and he acknowledged to me that he executed the same as and for the act and deed of said firm.

Notary Public or Commissioner of Deeds

ACKNOWLEDGMENT OF PRINCIPAL, IF AN INDIVIDUAL

State of _____ County of _____ ss:

On this _____ day of _____, _____, before me personally appeared _____ to me known, and known to me to be the person described in and who executed the foregoing instrument; and acknowledged that he executed the same.

Notary Public or Commissioner of Deeds

Each executed bond should be accompanied by: (a) appropriate acknowledgments of the respective parties; (b) appropriate duly certified copy of Power of Attorney or other certificate of authority where bond is executed by agent, officer or other representative of Principal or Surety; (c) a duly certified extract from By-Laws or resolutions of Surety under which Power of Attorney or other certificate of authority of its agent, officer or representative was issued, and (d) certified copy of latest published financial statement of assets and liabilities of Surety.

Affix Acknowledgments and Justification of Sureties.

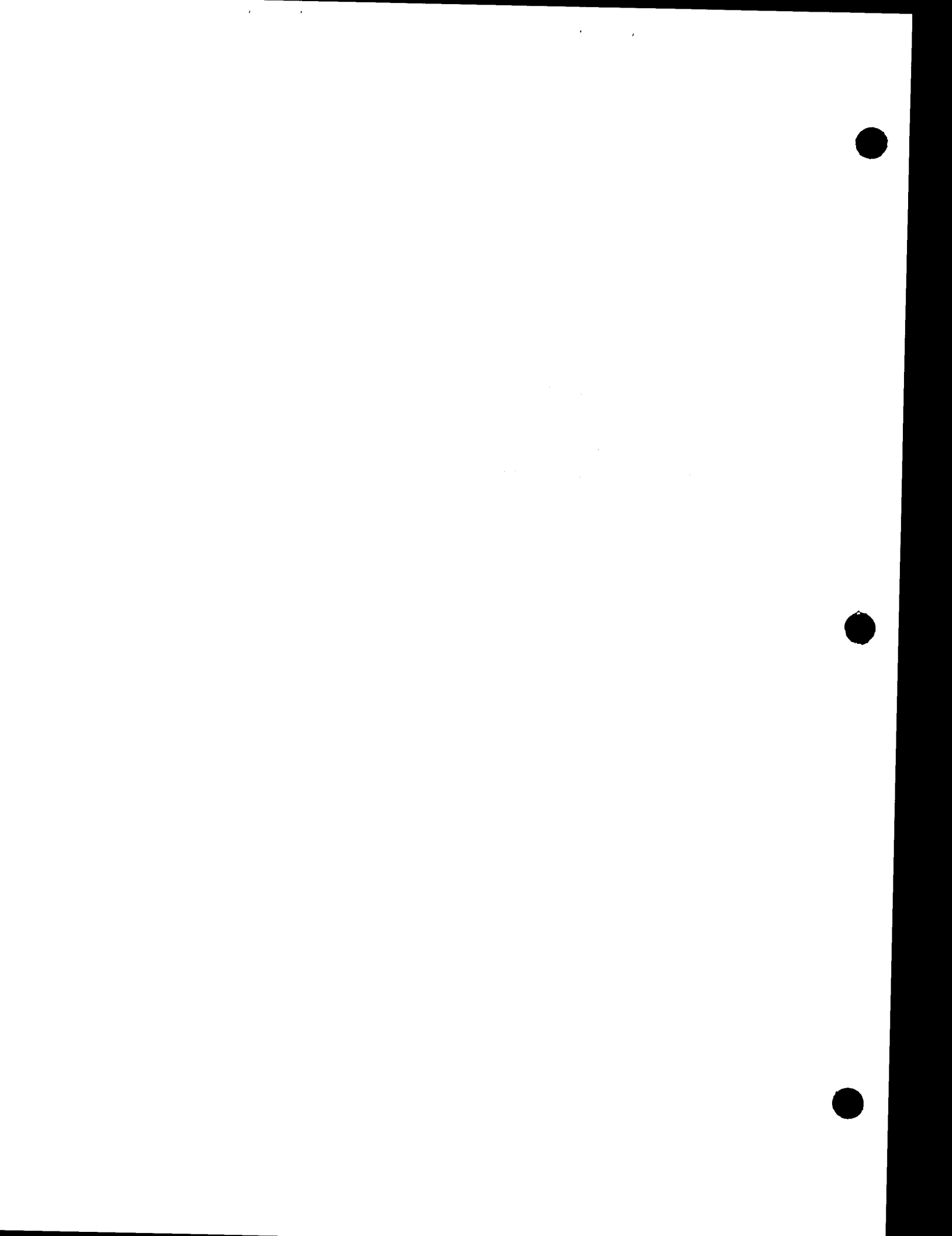

ACKNOWLEDGEMENT OF SURETY

STATE OF New York)
COUNTY OF Erie) ss
CITY OF BUFFALO)

On this 21st day of January in the year 2016, before me personally came Victoria Rivera, to me known, who, being by me duly sworn, did depose and say that he/she/they reside (s) Buffalo, NY, that he/she/they (is) (are) the Attorney-in-Fact duly appointed of the Endurance American Insurance Company the corporation described in and which executed the above instrument; that he/she/they know(s) the seal of said corporation; that the seal affixed to said instrument is such corporate seal; that it was so affixed by authority of the board of directors of said corporation, and that he/she/they signed his/her/their name(s) thereto by like authority.



NOTARY PUBLIC

ALISSA J WOLF
Notary Public, State of New York
No. 01WO6284714
Qualified in Erie County
Commission Expires June 24, 2017



POWER OF ATTORNEY

Know all Men by these Presents, that ENDURANCE AMERICAN INSURANCE COMPANY, a Delaware corporation (the "Corporation"), with offices at 750 Third Avenue, New York, New York 10017, has made, constituted and appointed and by these presents, does make, constitute and appoint

LORIANN FAY, TIMOTHY M. TOOLE, VICTORIA RIVERA, ALISSA J. WOLF

its true and lawful Attorney(s)-in-fact, at BUFFALO in the State of NY and each of them to have full power to act without the other or others, to make, execute, seal and deliver for and on its behalf bonds, undertakings or obligations in surety or co-surety with others, also to execute and deliver on its behalf renewals, extensions, agreements, waivers, consents or stipulations relating to such aforesaid bonds, undertakings or obligations provided, however, that no single bond or undertaking so made, executed and delivered shall obligate the Corporation for any portion of the penal sum thereof in excess of the sum of SEVEN MILLION FIVE HUNDRED THOUSAND Dollars (\$7,500,000.00).

Such bonds and undertakings for said purposes, when duly executed by said attorney(s)-in-fact, shall be binding upon the Corporation as fully and to the same extent as if signed by the President of the Corporation under its corporate seal attested by its Corporate Secretary.87

This appointment is made under and by authority of certain resolutions adopted by the Board of Directors of the Corporation by unanimous written consent on the 21st day of July, 2011, a copy of which appears below under the heading entitled "Certificate".

87

This Power of Attorney is signed and sealed by facsimile under and by authority of the following resolution adopted by the Board of Directors of the Corporation by unanimous written consent on the 21st day of July, 2011 and said resolution has not since been revoked, amended or repealed:

RESOLVED, that in granting powers of attorney pursuant to certain resolutions adopted by the Board of Directors of the Corporation by unanimous written consent on the 21st day of July, 2011, the signature of such directors and officers and the seal of the Corporation may be affixed to any such power of attorney or any certificate relating thereto by facsimile, and any such power of attorney or certificate bearing such facsimile signature or seal shall be valid and binding upon the Corporation in the future with respect to any bond or undertaking to which it is attached.

This Power of Attorney shall expire and all authority hereunder shall terminate without notice at 12:01 a.m. (Standard Timer where said attorney(s)-in-fact is authorized to act.) JUNE 21st, 2016.

IN WITNESS WHEREOF, the Corporation has caused these presents to be duly signed and its corporate seal to be hereunto affixed and attested this 22ND day of JUNE, 2015 at New York, New York.
(Corporate Seal) ENDURANCE AMERICAN INSURANCE COMPANY

AP [Signature]
Alfred N. Wright, Senior Vice President

By [Signature]
Ronald Diggs, Vice President

STATE OF NEW YORK ss: MANHATTAN
COUNTY OF NEW YORK

On the 22ND day of JUNE, 2015 before me personally came RONALD DIGGS to me known, who being by me duly sworn, did depose and say that (s)he resides in HELPERTOWN, PENNSYLVANIA that (s)he is a VICE PRESIDENT of ENDURANCE AMERICAN INSURANCE COMPANY, the corporation described in and which executed the above instrument; that (s)he knows the seal of said corporation; that the seal affixed to this instrument is such corporate seal; that it was so affixed by order of the Board of Directors of said corporation, and that (s)he signed his (her) name thereto by like order.
(Notarial Seal)

[Signature]
Anie Licari, Notary Public - My Commission Expires: October 29, 2015

CERTIFICATE

STATE OF NEW YORK ss: MANHATTAN
COUNTY OF NEW YORK

I, Doug Worman, the Chief Executive Officer of ENDURANCE AMERICAN INSURANCE COMPANY, a Delaware Corporation (the "Corporation"), hereby certify:

- 1. That the original power of attorney of which the foregoing is a copy was duly executed on behalf of the Corporation and has not since been revoked, amended or modified; that the undersigned has compared the foregoing copy thereof with the original power of attorney, and that the same is a true and correct copy of the original power of attorney and of the whole thereof;
- 2. The following are resolutions which were adopted by the Board of Directors of the Corporation by unanimous written consent on the 21st day of July, 2011 and said resolutions have not since been revoked, amended or modified:

"RESOLVED, that each of the individuals named below is authorized to make, execute, seal and deliver for and on behalf of the Corporation any and all bonds, undertakings or obligations in surety or co-surety with others and to execute and deliver for and on behalf of the Corporation renewals, extensions, agreements, waivers, consents or stipulations relating to such aforesaid bonds, undertakings or obligations:

ALFRED N. WRIGHT, RONALD DIGGS

And

RESOLVED FURTHER, that each of the individuals named above is authorized to appoint attorneys-in-fact for the purpose of making, executing, sealing and delivering bonds, undertakings or obligations in surety or co-surety with others on behalf of the Corporation.

- 3. The undersigned further certifies that the above resolutions are true and correct copies of the resolutions as so recorded and of the whole thereof.

IN WITNESS WHEREOF, I have hereunto set my hand and affixed the corporate seal this 21st day of January, 2016.

(Corporate Seal) ENDURANCE AMERICAN INSURANCE COMPANY
Doug Worman, Chief Executive Officer of U.S. Insurance



ENDURANCE AMERICAN INSURANCE COMPANY
Balance Sheet - Statutory - Basis
December 31, 2014

Assets:	
Bonds	\$ 300,479,343
Common stocks	90,259,052
Cash	28,823,471
Receivable for securities	7,034,443
Total cash and invested assets	<u>426,596,309</u>
Agents' balances or uncollected premiums	611,326,868
Reinsurance recoverable on loss and loss adjustment expense payments	188,836,551
Funds held by or deposited with reinsures companies	12,577,282
Current federal and foreign income tax recoverable	222,552
Investment income due and accrued	1,380,223
Receivables from parent, subsidiaries and affiliates	2,916,663
Total admitted assets	<u>\$ 1,243,856,448</u>
Liabilities:	
Loss and loss adjustment expenses	\$ 204,125,794
Reinsurance payable on paid loss and loss adjustment expenses	330,820,037
Unearned premiums	78,904,134
Ceded reinsurance premiums payable	357,992,680
Provision for reinsurance	1,037,000
Payable to parent, subsidiaries and affiliates	6,457,166
Payable for securities	14,792,578
Other liabilities	8,525,697
Total liabilities	<u>1,002,655,086</u>
Capital and surplus:	
Common capital stock	6,000,000
Gross paid in and contributed surplus	531,153,297
Unassigned funds (surplus)	(295,951,935)
Total capital and surplus	<u>241,201,362</u>
Total liabilities and capital and surplus	<u>\$ 1,243,856,448</u>

I, Stan Osofsky, Treasurer of Endurance American Insurance Company (the "Company") do hereby certify that to the best of my knowledge and belief, the foregoing is a full and true Statutory Statement of Admitted Assets, Liabilities, Capital and Surplus of the Company as of December 31, 2014 prepared in conformity with accounting practices prescribed or permitted by the State of Delaware Department of Insurance. The foregoing statement should not be taken as a complete statement of financial condition of the Company. Such a statement is available upon request at the Company's office located at 4 Manhattanville Road, 3rd Floor, Purchase, NY 10577.

IN WITNESS WHEREOF, I have hereunto set my hand and affixed the seal of the Company at New York, New York.

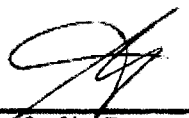
 Stan Osofsky, Treasurer

Subscribed and sworn to before me this 12th day of March, 2015

ROSE CHARLES
 Notary Public, State of New York
 No. 02CH172944
 Qualified in New York County
 My Commission Expires Aug 13, 2015







New York State Insurance Fund

Workers' Compensation & Disability Benefits Specialists Since 1914

199 CHURCH STREET, NEW YORK, N.Y. 10007-1100

Phone: (212) 587-5545

CERTIFICATE OF WORKERS' COMPENSATION INSURANCE

***** 113539578

J.PIZZIRUSSO LANDSCAPING CORP.
7104 AVENUE W
BROOKLYN NY 11234

POLICYHOLDER J.PIZZIRUSSO LANDSCAPING CORP. 7104 AVENUE W BROOKLYN NY 11234		CERTIFICATE HOLDER NYC DDC 30-30 THOMSON AVE 1 FLOOR LONG ISLAND CITY NY 11101	
POLICY NUMBER K 858 023-5	CERTIFICATE NUMBER 223816	PERIOD COVERED BY THIS CERTIFICATE 03/20/2015 TO 03/20/2017	DATE 1/28/2016

THIS IS TO CERTIFY THAT THE POLICYHOLDER NAMED ABOVE IS INSURED WITH THE NEW YORK STATE INSURANCE FUND UNDER POLICY NO. 858 023-5 UNTIL 03/20/2017, COVERING THE ENTIRE OBLIGATION OF THIS POLICYHOLDER FOR WORKERS' COMPENSATION UNDER THE NEW YORK WORKERS' COMPENSATION LAW WITH RESPECT TO ALL OPERATIONS IN THE STATE OF NEW YORK, EXCEPT AS INDICATED BELOW, AND, WITH RESPECT TO OPERATIONS OUTSIDE OF NEW YORK, TO THE POLICYHOLDER'S REGULAR NEW YORK STATE EMPLOYEES ONLY.

IF SAID POLICY IS CANCELLED, OR CHANGED PRIOR TO 03/20/2017 IN SUCH MANNER AS TO AFFECT THIS CERTIFICATE, 10 DAYS WRITTEN NOTICE OF SUCH CANCELLATION WILL BE GIVEN TO THE CERTIFICATE HOLDER ABOVE. NOTICE BY REGULAR MAIL SO ADDRESSED SHALL BE SUFFICIENT COMPLIANCE WITH THIS PROVISION. THE NEW YORK STATE INSURANCE FUND DOES NOT ASSUME ANY LIABILITY IN THE EVENT OF FAILURE TO GIVE SUCH NOTICE.

THIS POLICY DOES NOT COVER CLAIMS OR SUITS THAT ARISE FROM BODILY INJURY SUFFERED BY THE OFFICERS OF THE INSURED CORPORATION.

J PIZZIRUSSO LANDSCAPING CORP
JOHN PIZZIRUSSO
JOSEPH PIZZIRUSSO

THIS CERTIFICATE DOES NOT APPLY TO THOSE JOB SITES WHICH ARE COVERED BY OTHER INSURANCE AND ARE SPECIFICALLY EXCLUDED BY ENDORSEMENT.

THIS CERTIFICATE IS ISSUED AS A MATTER OF INFORMATION ONLY AND CONFERS NO RIGHTS NOR INSURANCE COVERAGE UPON THE CERTIFICATE HOLDER. THIS CERTIFICATE DOES NOT AMEND, EXTEND OR ALTER THE COVERAGE AFFORDED BY THE POLICY.

NEW YORK STATE INSURANCE FUND

DIRECTOR, INSURANCE FUND UNDERWRITING

This certificate can be validated on our web site at <https://www.nysif.com/cert/certval.asp> or by calling (888) 875-5790
VALIDATION NUMBER: 781712778





CERTIFICATE OF LIABILITY INSURANCE

DATE (MM/DD/YYYY)

1/29/2016

THIS CERTIFICATE IS ISSUED AS A MATTER OF INFORMATION ONLY AND CONFERS NO RIGHTS UPON THE CERTIFICATE HOLDER. THIS CERTIFICATE DOES NOT AFFIRMATIVELY OR NEGATIVELY AMEND, EXTEND OR ALTER THE COVERAGE AFFORDED BY THE POLICIES BELOW. THIS CERTIFICATE OF INSURANCE DOES NOT CONSTITUTE A CONTRACT BETWEEN THE ISSUING INSURER(S), AUTHORIZED REPRESENTATIVE OR PRODUCER, AND THE CERTIFICATE HOLDER.

IMPORTANT: If the certificate holder is an ADDITIONAL INSURED, the policy(ies) must be endorsed. If SUBROGATION IS WAIVED, subject to the terms and conditions of the policy, certain policies may require an endorsement. A statement on this certificate does not confer rights to the certificate holder in lieu of such endorsement(s).

PRODUCER Admiral Insurance Brokerage Corp. 6833 Shore Road Brooklyn NY 11220	CONTACT NAME:	PHONE (A/C. No. Ext): (718) 241-8500	FAX (A/C. No.): (718) 241-8520
	E-MAIL ADDRESS: info@useadmiral.com		
INSURED J Pizzirusso Landscaping Corp. 7104 Avenue W Brooklyn NY 11234	INSURER(S) AFFORDING COVERAGE		NAIC #
	INSURER A: National Union Fire Ins		
	INSURER B:		
	INSURER C:		
	INSURER D:		
INSURER E:			
INSURER F:			

COVERAGES

CERTIFICATE NUMBER: 15-16 Umbrella

REVISION NUMBER:

THIS IS TO CERTIFY THAT THE POLICIES OF INSURANCE LISTED BELOW HAVE BEEN ISSUED TO THE INSURED NAMED ABOVE FOR THE POLICY PERIOD INDICATED. NOTWITHSTANDING ANY REQUIREMENT, TERM OR CONDITION OF ANY CONTRACT OR OTHER DOCUMENT WITH RESPECT TO WHICH THIS CERTIFICATE MAY BE ISSUED OR MAY PERTAIN, THE INSURANCE AFFORDED BY THE POLICIES DESCRIBED HEREIN IS SUBJECT TO ALL THE TERMS, EXCLUSIONS AND CONDITIONS OF SUCH POLICIES. LIMITS SHOWN MAY HAVE BEEN REDUCED BY PAID CLAIMS.

INSR LTR	TYPE OF INSURANCE	ADDL SUBR INSD WVD	POLICY NUMBER	POLICY EFF (MM/DD/YYYY)	POLICY EXP (MM/DD/YYYY)	LIMITS
	COMMERCIAL GENERAL LIABILITY <input type="checkbox"/> CLAIMS-MADE <input type="checkbox"/> OCCUR GEN'L AGGREGATE LIMIT APPLIES PER: <input type="checkbox"/> POLICY <input type="checkbox"/> PRO-JECT <input type="checkbox"/> LOC OTHER:					EACH OCCURRENCE \$ DAMAGE TO RENTED PREMISES (Ea occurrence) \$ MED EXP (Any one person) \$ PERSONAL & ADV INJURY \$ GENERAL AGGREGATE \$ PRODUCTS - COMP/OP AGG \$ \$
	AUTOMOBILE LIABILITY <input type="checkbox"/> ANY AUTO <input type="checkbox"/> ALL OWNED AUTOS <input type="checkbox"/> HIRED AUTOS <input type="checkbox"/> SCHEDULED AUTOS <input type="checkbox"/> NON-OWNED AUTOS					COMBINED SINGLE LIMIT (Ea accident) \$ BODILY INJURY (Per person) \$ BODILY INJURY (Per accident) \$ PROPERTY DAMAGE (Per accident) \$ \$
A	<input checked="" type="checkbox"/> UMBRELLA LIAB <input type="checkbox"/> EXCESS LIAB <input type="checkbox"/> DED <input type="checkbox"/> RETENTION \$	<input type="checkbox"/> OCCUR <input type="checkbox"/> CLAIMS-MADE	020463548	5/23/2015	5/23/2016	EACH OCCURRENCE \$ 10,000,000 AGGREGATE \$ 10,000,000 \$ PER STATUTE OTH-ER
	WORKERS COMPENSATION AND EMPLOYERS' LIABILITY ANY PROPRIETOR/PARTNER/EXECUTIVE OFFICER/MEMBER EXCLUDED? (Mandatory in NH) If yes, describe under DESCRIPTION OF OPERATIONS below	<input type="checkbox"/> Y/N <input type="checkbox"/> N/A				E.L. EACH ACCIDENT \$ E.L. DISEASE - EA EMPLOYEE \$ E.L. DISEASE - POLICY LIMIT \$

DESCRIPTION OF OPERATIONS / LOCATIONS / VEHICLES (ACORD 101, Additional Remarks Schedule, may be attached if more space is required)

Re Project ID: HWPEDSF1, DDC PIN: 85015B0051001 - Multi-site Pedestrian Safety involving the following intersaectations: 31st Street and 39th Avenue in the Borough of Queens. City of New York including its officials and employees are listed as additional insured per contract #HWPEDSF1.

CERTIFICATE HOLDER

City of New York
Department of Design and Construction
30-30 Thomson Ave.
1st Floor
Long Island City, NY 11101

CANCELLATION

SHOULD ANY OF THE ABOVE DESCRIBED POLICIES BE CANCELLED BEFORE THE EXPIRATION DATE THEREOF, NOTICE WILL BE DELIVERED IN ACCORDANCE WITH THE POLICY PROVISIONS.

AUTHORIZED REPRESENTATIVE

Mary Urrico/RSTONE

© 1988-2014 ACORD CORPORATION. All rights reserved





CERTIFICATE OF LIABILITY INSURANCE RD

DATE (MM/DD/YYYY)
01/28/2016

THIS CERTIFICATE IS ISSUED AS A MATTER OF INFORMATION ONLY AND CONFERS NO RIGHTS UPON THE CERTIFICATE HOLDER. THIS CERTIFICATE DOES NOT AFFIRMATIVELY OR NEGATIVELY AMEND, EXTEND OR ALTER THE COVERAGE AFFORDED BY THE POLICIES BELOW. THIS CERTIFICATE OF INSURANCE DOES NOT CONSTITUTE A CONTRACT BETWEEN THE ISSUING INSURER(S), AUTHORIZED REPRESENTATIVE OR PRODUCER, AND THE CERTIFICATE HOLDER.

IMPORTANT: If the certificate holder is an ADDITIONAL INSURED, the policy(ies) must be endorsed. If SUBROGATION IS WAIVED, subject to the terms and conditions of the policy, certain policies may require an endorsement. A statement on this certificate does not confer rights to the certificate holder in lieu of such endorsement(s).

PRODUCER GEORGE R GROSSMANN, LUTC FARM FAMILY CASUALTY INSURANCE COMPANY 4250 VETERANS MEMORIAL HIGHWAY HOLBROOK, NY 11741	CONTACT NAME ROSALBA DE ROBERTIS	FAX (A/C. No.) 631-439-4651
	PHONE (A/C. No. Ext.) 631-439-4650	E-MAIL ADDRESS:
INSURED J PIZZIRUSSO LANDSCAPING CORP. 7104 AVENUE W BROOKLYN, NY 11234	INSURER(S) AFFORDING COVERAGE	
	INSURER A: FARM FAMILY CASUALTY INSURANC CO.	NAIC # 13803
	INSURER B:	
	INSURER C:	
	INSURER D:	
	INSURER E: INSURER F:	

COVERAGES CERTIFICATE NUMBER: **119797** REVISION NUMBER:

THIS IS TO CERTIFY THAT THE POLICIES OF INSURANCE LISTED BELOW HAVE BEEN ISSUED TO THE INSURED NAMED ABOVE FOR THE POLICY PERIOD INDICATED. NOTWITHSTANDING ANY REQUIREMENT, TERM OR CONDITION OF ANY CONTRACT OR OTHER DOCUMENT WITH RESPECT TO WHICH THIS CERTIFICATE MAY BE ISSUED OR MAY PERTAIN, THE INSURANCE AFFORDED BY THE POLICIES DESCRIBED HEREIN IS SUBJECT TO ALL THE TERMS, EXCLUSIONS AND CONDITIONS OF SUCH POLICIES. LIMITS SHOWN SHOWN MAY HAVE BEEN REDUCED BY PAID CLAIMS.

INSR LTR	TYPE OF INSURANCE	ADDL INSR	SUBR WVD	POLICY NUMBER	POLICY EFF (MM/DD/YYYY)	POLICY EXP (MM/DD/YYYY)	LIMITS
A	GENERAL LIABILITY			3124X0083	03/21/2015	03/21/2016	EACH OCCURRENCE \$ 1,000,000
	<input checked="" type="checkbox"/> COMMERCIAL GENERAL LIABILITY						DAMAGE TO RENTED PREMISES (Ea occurrence) \$ 50,000
	<input type="checkbox"/> CLAIMS-MADE <input checked="" type="checkbox"/> OCCUR						MED EXP (Any one person) \$ 5,000
	GEN'L AGGREGATE LIMIT APPLIES PER:						PERSONAL & ADV INJURY \$ 1,000,000
	<input type="checkbox"/> POLICY <input type="checkbox"/> PRO-JECT <input type="checkbox"/> LOC						GENERAL AGGREGATE \$ 2,000,000
	AUTOMOBILE LIABILITY						PRODUCTS - COM/OP AGG \$ 2,000,000
	<input type="checkbox"/> ANY AUTO						\$
	<input type="checkbox"/> ALL OWNED AUTOS	<input type="checkbox"/> SCHEDULED AUTOS					COMBINED SINGLE LIMIT (Ea accident) \$
	<input type="checkbox"/> HIRED AUTOS	<input type="checkbox"/> NON-OWNED AUTOS					BODILY INJURY (Per person) \$
	UMBRELLA LIAB	<input type="checkbox"/> OCCUR					BODILY INJURY (Per accident) \$
	EXCESS LIAB	<input type="checkbox"/> CLAIMS-MADE					PROPERTY DAMAGE (Per accident) \$
	DED	RETENTION \$					\$
	WORKERS COMPENSATION AND EMPLOYERS' LIABILITY						EACH OCCURRENCE \$
	ANY PROPRIETOR/PARTNER/EXECUTIVE OFFICER/MEMBER EXCLUDED? (Mandatory in NH)	<input type="checkbox"/> Y <input checked="" type="checkbox"/> N	N/A				AGGREGATE \$
	DESCRIPTION OF OPERATIONS below						WC STATU-TORY LIMITS
							OTH-ER
							E.L. EACH ACCIDENT \$
							E.L. DISEASE - EA EMPLOYEE \$
							E.L. DISEASE - POLICY LIMIT \$

DESCRIPTION OF OPERATIONS / LOCATIONS / VEHICLES (Attach ACORD 101, Additional Remarks Schedule, if more space is required)
CITY OF NEW YORK INCLUDING ITS OFFICIALS AND EMPLOYEES ARE LISTED AS ADDITIONAL INSURED PER CONTRACT # HWPEDSF1.

CERTIFICATE HOLDER NYC DDC 30-30 THOMSON AVE 1ST FLOOR LONG ISLAND CITY, NY 11101	CANCELLATION SHOULD ANY OF THE ABOVE DESCRIBED POLICIES BE CANCELLED BEFORE THE EXPIRATION DATE THEREOF, NOTICE WILL BE DELIVERED IN ACCORDANCE WITH THE POLICY PROVISIONS. AUTHORIZED REPRESENTATIVE
--	---



SCHEDULE A
(GENERAL CONDITIONS TO CONSTRUCTION CONTRACT)
(GENERAL CONDITIONS RELATING TO ARTICLE 22 - INSURANCE)

PART III. BROKER'S CERTIFICATION

Pursuant to Article 22.3.3 of the Contract, every Certificate of Insurance must be accompanied by either the following certification by the broker setting forth the following text and required information and signatures or certified copies of all policies referenced in the Certificate of Insurance.

CERTIFICATION BY BROKER

The undersigned insurance broker represents to the City of New York that the attached Certificate of Insurance is accurate in all material respects, and that the described insurance is effective as of the date of this Certification.

ADMIRAL INSURANCE BROKERAGE CORP.
[Name of broker (typewritten)]

6833 SHORE RD., BROOKLYN, NY 11220
[Address of broker (typewritten)]

info@useadmiral.com
[Email address of broker (typewritten)]

(P) 718-241-8500 (F) 718-241-8520
[Phone number/Fax number of broker (typewritten)]

Mary Urrico
[Signature of authorized official or broker]

MARY URRICO - BROKER
[Name and title of authorized official (typewritten)]

State of NEW YORK)
) ss.:
County of KINGS)

Sworn to before me this 29th day of JANUARY, 2016

C. [Signature]
NOTARY PUBLIC FOR THE STATE OF NEW YORK

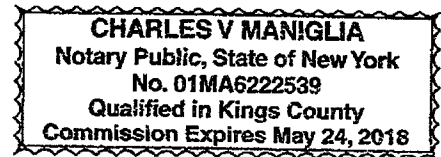



SCHEDULE OF WORKMEN, MECHANICS AND LABORERS

The following is a list of classifications for workmen, mechanics and laborers which are anticipated to be employed in the performance of work under this contract, followed by a schedule of the prevailing wage rates and supplemental benefits for all classifications as established by the Comptroller of the City of New York.

Request for interpretation or correction under Subsection A of Section No. 3 in the Information for Bidders includes all requests for clarification of the classification of trades to be employed in the performance of the work under this contract.

In the event that a trade not listed in the classification of trades required to be used at the time of the award of the contract is in fact employed during the performance of this contract, the Contractor shall be required to obtain from the agency the prevailing wage rates and supplementary benefits for the trades used and to complete the performance of this contract at the price at which the contract was awarded.

<u>CODE</u>	<u>CLASSIFICATION</u>
15 42 001	Rigger
15 42 002	Sign Erector
16 11 001	Gardener
16 11 002	Tree Pruner
16 11 003	Tree Remover
16 11 011	Asphalt Raker (Highway & Paving)
16 11 012	Tamper (Highway & Paving)
16 11 013	Curbsetter (Highway & Paving)
16 11 014	Formsetter (Highway & Paving)
16 11 015	Rammerman (Highway & Paving)
16 11 016	Laborer (Highway & Paving)
16 11 017	ALL OTHER TITLES (Highway & Paving)
16 23 001	Laborer
16 23 002	Operating Engineer (Heavy Construction-Maintenance)
16 23 003	Junior Operating Engineer
16 23 004	Junior Operating Engineer
16 23 005	Junior Operating Engineer
16 23 006	Fireman (Heavy Construction)
16 23 007	Oiler (Heavy Construction)
16 23 051	Surveyor-Heavy Construction
16 23 052	Surveyor-Heavy Construction-Instrument Man
16 23 053	Surveyor-Heavy Construction-Rodman
16 23 057	Surveyor-Land Surveying-Party Chief
16 23 058	Surveyor-Land Surveying-Instrument Man
16 23 059	Surveyor-Land Surveying-Rodman

<u>CODE</u>	<u>CLASSIFICATION</u>
16 23 061	Operating Engineer-Road & Heavy Construction
16 23 062	Operating Engineer-Paving
16 23 063	Operating Engineer-Concrete
16 23 071	Teamster-Heavy Equipment Trailer Driver
16 23 072	Teamster-Dump Truck Driver
16 23 073	Teamster-Flat Bed Trailer Driver (3-Axle)
16 23 074	Teamster-Redi-Mix (Sand and Gravel)
16 29 011	Drill Runners
17 11 001	Plumbers
17 21 001	Painter (Brush & Roller)
17 31 001	Electrician
17 41 001	Bricklayer
17 41 002	Mason Tender
17 41 004	Cement Mason
17 42 002	Metallic Lather
17 51 001	Carpenter
17 51 002	Dock Builder
17 71 001	Cement & Concrete Worker
17 91 001	Structural Iron Worker
17 95 001	Barman
17 96 021	Derrickmen & Riggers
17 99 001	Ornamental Iron Worker
17 99 002	Sandblaster
17 99 005	Pointers (Waterproofer)
17 99 011	Welders

Each classification may include trainees depending upon project staffing schedules and as required by the terms of this contract.

OFFICE OF THE COMPTROLLER, CITY OF NEW YORK
§220 PREVAILING WAGE SCHEDULE

LABOR LAW §220 PREVAILING WAGE SCHEDULE

Workers, Laborers and Mechanics employed on a public work project must receive not less than the prevailing rate of wage and benefits for the classification of work performed by each upon such public work. Pursuant to Labor Law §220 the Comptroller of the City of New York has promulgated this schedule solely for Workers, Laborers and Mechanics engaged by private contractors on New York City public work contracts.

This schedule is a compilation of separate determinations of the prevailing rate of wage and supplements made by the Comptroller for each trade classification listed herein pursuant to New York State Labor Law section 220 (5). The source of the wage and supplement rates, whether a collective bargaining agreement, survey data or other, is listed at the end of each classification.

Agency Chief Contracting Officers should contact the Bureau of Labor Law's Classification Unit with any questions concerning trade classifications, prevailing rates or prevailing practices with respect to procurement on New York City public works contracts. Contractors are advised to review the Comptroller's Prevailing Wage Schedule before bidding on public works contracts. Contractors with questions concerning trade classifications, prevailing rates or prevailing practices with respect to public works contracts in the procurement stage must contact the contracting agency responsible for the procurement.

Any error as to compensation under the prevailing wage law or other information as to trade classification, made by the contracting agency in the contract documents or in any other communication, will not preclude a finding against the contractor of prevailing wage violation.

Any questions concerning trade classifications, prevailing rates or prevailing practices on New York City public works contracts that have already been awarded may be directed to the Bureau of Labor Law's Classification Unit by calling (212) 669-7974. All callers must have the agency name and contract registration number available when calling with questions on public works contracts. Please direct all other compliance issues to: Bureau of Labor Law, Attn: Wasyl Kinach, P.E., Office of the Comptroller, 1 Centre Street, Room 1122, New York, N.Y. 10007; Fax (212) 669-4002.

The appropriate schedule of prevailing wages and benefits must be posted at all public work sites pursuant to Labor Law §220 (3-a) (a).

This schedule is applicable to work performed during the effective period, unless otherwise noted. Changes to this schedule are published on our web site www.comptroller.nyc.gov. Contractors must pay the wages and supplements in effect when the worker, laborer, mechanic performs the work. Preliminary schedules for future one-year periods appear in the City Record on or about June 1 each succeeding year. Final schedules appear on or about July 1 in the City Record and on our web site www.comptroller.nyc.gov.

The Comptroller's Office has attempted to include all overtime, shift and night differential, Holiday, Saturday, Sunday or other premium time work. However, this schedule does not set forth every prevailing practice with respect to such rates with which employers must comply. All such practices are nevertheless part of the employer's prevailing wage obligation and contained in the collective bargaining agreements of the prevailing wage unions. These collective bargaining agreements are available for inspection by appointment. Requests for appointments may be made by calling (212) 669-4443, Monday through Friday between the hours of 9 a.m. and 5 p.m.

OFFICE OF THE COMPTROLLER, CITY OF NEW YORK
§220 PREVAILING WAGE SCHEDULE

Prevailing rates and ratios for apprentices are attached to this schedule in the Appendix. Pursuant to Labor Law §220 (3-e), only apprentices who are individually registered in a bona fide program to which the employer contractor is a participant, registered with the New York State Department of Labor, may be employed on a public work project. Workers who are not journey persons or not registered apprentices pursuant to Labor Law §220 (3-e) may not be substituted for apprentices and must be paid as journey persons.

Public Work construction, reconstruction, demolition, excavation, rehabilitation, repair, renovation, alteration, or improvement contracts awarded pursuant to a Project Labor Agreement ("PLA") in accordance with Labor Law section 222 may have different labor standards for shift, premium and overtime work. Please refer to the PLA's pre-negotiated labor agreements for wage and benefit rates applicable to work performed outside of the regular workday. More information is available at the Mayor's Office of Contract Services (MOCS) web page at <http://www.nyc.gov/html/mocs/html/vendors/pla.shtml>.

All the provisions of Labor Law section 220 remain applicable to PLA work including, but not limited to, the enforcement of prevailing wage requirements by the Comptroller; however, we will enforce shift, premium, overtime and other non-standard rates as they appear in a project's pre-negotiated labor agreement.

In order to meet their obligation to provide prevailing supplemental benefits to each covered employee, employers must either:

- 1) Provide bona-fide benefits which cost the employer no less than the prevailing supplemental benefits rate; or
- 2) Supplement the employee's hourly wage by an amount no less than the prevailing supplemental benefits rate; or
- 3) Provide a combination of bona-fide benefits and wage supplements which cost the employer no less than the prevailing supplemental benefits rate in total.

Particular attention should be given to the supplemental benefits requirement. Although in most instances the payment or provision for supplemental benefits is for each hour worked, some classifications require the payment or provision of supplemental benefits for each hour paid. Consequently, some prevailing practices require benefits to be purchased at the overtime, shift differential, Holiday, Saturday, Sunday or other premium time rate.

Benefits are paid for **EACH HOUR WORKED** unless otherwise noted.

Wasył Kinach, P.E.
Director of Classifications
Bureau of Labor Law

OFFICE OF THE COMPTROLLER, CITY OF NEW YORK
§220 PREVAILING WAGE SCHEDULE

TABLE OF CONTENTS

<u>CLASSIFICATION</u>	<u>PAGE</u>
ASBESTOS HANDLER	5
BLASTER	5
BOILERMAKER.....	7
BRICKLAYER.....	8
CARPENTER - BUILDING COMMERCIAL	9
CARPENTER - HEAVY CONSTRUCTION WORK	10
CEMENT & CONCRETE WORKER.....	11
CEMENT MASON.....	11
CORE DRILLER	12
DERRICKPERSON AND RIGGER	14
DIVER.....	14
DOCKBUILDER - PILE DRIVER.....	15
DRIVER: TRUCK (TEAMSTER)	16
ELECTRICIAN	18
ELECTRICIAN - ALARM TECHNICIAN.....	22
ELECTRICIAN-STREET LIGHTING WORKER	23
ELEVATOR CONSTRUCTOR	24
ELEVATOR REPAIR & MAINTENANCE.....	25
ENGINEER	26
ENGINEER - CITY SURVEYOR AND CONSULTANT.....	31
ENGINEER - FIELD (BUILDING CONSTRUCTION)	32
ENGINEER - FIELD (HEAVY CONSTRUCTION)	33
ENGINEER - FIELD (STEEL ERECTION)	34
ENGINEER - OPERATING	35
FLOOR COVERER.....	42
GLAZIER	43
GLAZIER - REPAIR & MAINTENANCE	44
HEAT AND FROST INSULATOR	45
HOUSE WRECKER.....	46
IRON WORKER - ORNAMENTAL.....	47
IRON WORKER - STRUCTURAL.....	48
LABORER	48
LANDSCAPING	49
MARBLE MECHANIC.....	51
MASON TENDER	52

**OFFICE OF THE COMPTROLLER, CITY OF NEW YORK
§220 PREVAILING WAGE SCHEDULE**

MASON TENDER (INTERIOR DEMOLITION WORKER)	53
METALLIC LATHER	54
MILLWRIGHT	55
MOSAIC MECHANIC	56
PAINTER	57
PAINTER - SIGN	57
PAINTER - STRIPER	58
PAINTER - STRUCTURAL STEEL	59
PAPERHANGER	60
PAVER AND ROADBUILDER	61
PLASTERER	63
PLASTERER - TENDER	63
PLUMBER	64
PLUMBER (MECHANICAL EQUIPMENT AND SERVICE)	65
PLUMBER (RESIDENTIAL RATES FOR 1, 2 AND 3 FAMILY HOME CONSTRUCTION)	66
PLUMBER: PUMP & TANK	67
POINTER - WATERPROOFER, CAULKER MECHANIC (EXTERIOR BUILDING RENOVATION)	67
ROOFER	68
SANDBLASTER - STEAMBLASTER	69
SHEET METAL WORKER	70
SHEET METAL WORKER - SPECIALTY	71
SHIPYARD WORKER	72
SIGN ERECTOR	73
STEAMFITTER	74
STEAMFITTER - REFRIGERATION AND AIR CONDITIONER	75
STONE MASON - SETTER	77
TAPER	78
TELECOMMUNICATION WORKER	79
TILE FINISHER	80
TILE LAYER - SETTER	80
TIMBERPERSON	81
TUNNEL WORKER	82
WELDER	84

OFFICE OF THE COMPTROLLER, CITY OF NEW YORK
§220 PREVAILING WAGE SCHEDULE

ASBESTOS HANDLER

(Hazardous Material; Disturbs, removes, encapsulates, repairs, or encloses friable asbestos material)

Asbestos Handler

Effective Period: 7/1/2014 - 6/30/2015

Wage Rate per Hour: \$36.00

Supplemental Benefit Rate per Hour: \$15.45

Overtime

Time and one half the regular rate after an 8 hour day.

Time and one half the regular rate for Sunday.

Time and one half the regular hourly rate after 40 hours in any work week.

Overtime Holidays

Time and one half the regular rate for work on the following holiday(s).

New Year's Day

Good Friday

Memorial Day

Independence Day

Labor Day

Thanksgiving Day

Christmas Day

Easter

Paid Holidays

None

(Local #78 and Local #12A)

BLASTER

Blaster

Effective Period: 7/1/2014 - 6/30/2015

Wage Rate per Hour: \$45.70

Supplemental Benefit Rate per Hour: \$39.69

Blaster (Hydraulic)

Effective Period: 7/1/2014 - 6/30/2015

Wage Rate per Hour: \$46.49

Supplemental Benefit Rate per Hour: \$39.69

OFFICE OF THE COMPTROLLER, CITY OF NEW YORK
§220 PREVAILING WAGE SCHEDULE

Blaster - Trac Drill Hydraulic

Effective Period: 7/1/2014 - 6/30/2015
Wage Rate per Hour: \$41.20
Supplemental Benefit Rate per Hour: \$39.69

Blaster - Wagon: Air Trac: Quarry Bar: Drillrunners

Effective Period: 7/1/2014 - 6/30/2015
Wage Rate per Hour: \$40.44
Supplemental Benefit Rate per Hour: \$39.69

Blaster - Operators of Jack Hammers

Chippers: Spaders: Concrete Breakers: and all other pneumatic tools of like usage: Walk Behind Self Propelled Hydraulic Asphalt and Concrete Breakers: Hydro (Water) Demolition

Effective Period: 7/1/2014 - 6/30/2015
Wage Rate per Hour: \$39.43
Supplemental Benefit Rate per Hour: \$39.69

Blaster - Powder Carriers

Effective Period: 7/1/2014 - 6/30/2015
Wage Rate per Hour: \$35.66
Supplemental Benefit Rate per Hour: \$39.69

Blaster - Hydraulic Trac Drill Chuck Tender

Effective Period: 7/1/2014 - 6/30/2015
Wage Rate per Hour: \$34.42
Supplemental Benefit Rate per Hour: \$39.69

Blaster - Chuck Tender & Nipper

Effective Period: 7/1/2014 - 6/30/2015
Wage Rate per Hour: \$33.69
Supplemental Benefit Rate per Hour: \$39.69

Blaster - Magazine Keepers: (Watch Person)

Effective Period: 7/1/2014 - 6/30/2015
Wage Rate per Hour: \$20.30
Supplemental Benefit Rate per Hour: \$39.69

Overtime Description

Magazine Keepers:

OFFICE OF THE COMPTROLLER, CITY OF NEW YORK
§220 PREVAILING WAGE SCHEDULE

Time and one half for work performed in excess of forty (40) hours per week and for work performed on Saturdays, Sundays and Holidays.

All Other Employees:

Time and one-half for the first eight hours of work on Saturday and for Make-up Time. Double time for all hours over eight Monday through Friday (except make-up hours) and for all hours worked on Sunday and Holidays.

Overtime

Double time the regular rate after an 8 hour day.
Time and one half the regular rate for Saturday.
Double time the regular rate for Sunday.

Overtime Holidays

Double time the regular rate for work on the following holiday(s).

New Year's Day
Memorial Day
Independence Day
Labor Day
Columbus Day
Presidential Election Day
Thanksgiving Day
Christmas Day

Paid Holidays

None

Shift Rates

A single shift shall be 8 hours plus an unpaid lunch, starting at 8:00 A.M (or between 6:00 A.M. and 10:00 A.M. on weekdays). When two (2) shifts are employed, each shift shall be 8 hours plus ½ hour unpaid lunch. When three (3) shifts are employed, each shift will work seven and one-half (7 ½) hours, but will be paid for eight (8) hours, since only one-half (½) hour is allowed for mealtime. When two (2) or more shifts are employed, single time will be paid for each shift. The first 8 hours of any and all work performed Monday through Friday inclusive of any off-shift shall be at the single time rate.

(Local #29)

BOILERMAKER

Boilermaker

Effective Period: 7/1/2014 - 6/30/2015

Wage Rate per Hour: \$50.45

Supplemental Benefit Rate per Hour: \$41.31

Supplemental Note: For time and one half overtime - \$61.37; For double overtime - \$81.43.

Overtime Description

For Repair and Maintenance work:

Time and one half the regular rate after an 8 hour day.
Time and one half the regular rate for Saturday.

OFFICE OF THE COMPTROLLER, CITY OF NEW YORK
§220 PREVAILING WAGE SCHEDULE

Double time the regular rate for Sunday.
For New Construction work:
Double time the regular rate after an 8 hour day.
Double time the regular time rate for Saturday.
Double time the regular rate for Sunday.

Overtime Holidays

Double time the regular rate for work on the following holiday(s).

New Year's Day
President's Day
Memorial Day
Independence Day
Columbus Day
Election Day
Veteran's Day
Thanksgiving Day
Christmas Day

Quadruple time the regular rate for work on the following holiday(s).

Labor Day

Paid Holidays

Good Friday
Day after Thanksgiving
Day before Christmas
Day before New Year's Day

Shift Rates

When shifts are required, the first shift shall work eight (8) hours at the regular straight-time hourly rate. The second shift shall work seven and one-half (7 ½) hours and receive eight hours at the regular straight time hourly rate plus twenty-five cents (\$0.25) per hour. The third shift shall work seven (7) hours and receive eight hours at the regular straight time hourly rate plus fifty cents (\$0.50) per hour. A thirty (30) minute lunch period shall not be considered as time worked. Work in excess of the above shall be paid overtime at the appropriate new construction work or repair work overtime wage and supplemental benefit hourly rate.

(Local #5)

BRICKLAYER

Bricklayer

Effective Period: 7/1/2014 - 6/30/2015

Wage Rate per Hour: \$47.78

Supplemental Benefit Rate per Hour: \$28.03

Overtime

Time and one half the regular rate after a 7 hour day.
Time and one half the regular rate for Saturday.
Double time the regular rate for Sunday.

OFFICE OF THE COMPTROLLER, CITY OF NEW YORK
§220 PREVAILING WAGE SCHEDULE

Saturday may be used as a make-up day at straight time when a day is lost during that week to inclement weather.

Overtime Holidays

Double time the regular rate for work on the following holiday(s).

New Year's Day
Memorial Day
Independence Day
Labor Day
Thanksgiving Day
Christmas Day

Paid Holidays

None

Shift Rates

Overtime rates to be paid outside the regular scheduled work day.

(Bricklayer District Council)

CARPENTER - BUILDING COMMERCIAL

Building Commercial

Effective Period: 7/1/2014 - 6/30/2015

Wage Rate per Hour: **\$49.88**

Supplemental Benefit Rate per Hour: **\$44.10**

Overtime

Time and one half the regular rate after an 8 hour day.

Time and one half the regular rate for Saturday.

Double time the regular rate for Sunday.

Saturday may be used as a make-up day at straight time when a day is lost during that week to inclement weather.

Overtime Holidays

Double time the regular rate for work on the following holiday(s).

New Year's Day
Washington's Birthday
Memorial Day
Independence Day
Labor Day
Columbus Day
Presidential Election Day
Thanksgiving Day
Day after Thanksgiving
Christmas Day

OFFICE OF THE COMPTROLLER, CITY OF NEW YORK
\$220 PREVAILING WAGE SCHEDULE

Paid Holidays

None

Shift Rates

The second shift will receive one hour at the double time rate of pay for the last hour of the shift; eight hours pay for seven hours of work, nine hours pay for eight hours of work. There must be a first shift in order to work a second shift.

(Carpenters District Council)

CARPENTER - HEAVY CONSTRUCTION WORK
(Construction of Engineering Structures and Building Foundations)

Heavy Construction Work

Effective Period: 7/1/2014 - 6/30/2015

Wage Rate per Hour: \$48.35

Supplemental Benefit Rate per Hour: \$46.12

Overtime

Time and one half the regular rate after an 8 hour day.

Time and one half the regular rate for Saturday.

Double time the regular rate for Sunday.

Saturday may be used as a make-up day at straight time when a day is lost during that week to inclement weather.

Overtime Holidays

Double time the regular rate for work on the following holiday(s).

New Year's Day

President's Day

Memorial Day

Independence Day

Labor Day

Columbus Day

Presidential Election Day

Thanksgiving Day

Christmas Day

Paid Holidays

None

Shift Rates

Off shift work commencing between 5:00 P.M. and 11:00 P.M. shall work eight and one half hours allowing for one half hour for lunch. The wage rate shall be 113% of the straight time hourly wage rate.

OFFICE OF THE COMPTROLLER, CITY OF NEW YORK
§220 PREVAILING WAGE SCHEDULE

(Carpenters District Council)

CEMENT & CONCRETE WORKER

Cement & Concrete Worker

Effective Period: 7/1/2014 - 6/30/2015

Wage Rate per Hour: \$42.38

Supplemental Benefit Rate per Hour: \$26.17

Supplemental Note: \$28.92 on Saturdays; \$31.67 on Sundays & Holidays

Overtime Description

Time and one half the regular rate after 7 hour day (time and one half the regular rate after an 8 hour day when working with Dockbuilders on pile cap forms and for work below street level to the top of the foundation wall, not to exceed 2 feet or 3 feet above the sidewalk-brick shelf, when working on the foundation and structure.)

Overtime

Time and one half the regular rate for Saturday.

Double time the regular rate for Sunday.

Overtime Holidays

Double time the regular rate for work on the following holiday(s).

New Year's Day

President's Day

Good Friday

Memorial Day

Independence Day

Labor Day

Columbus Day

Presidential Election Day

Thanksgiving Day

Christmas Day

Paid Holidays

1/2 day before Christmas Day

1/2 day before New Year's Day

Shift Rates

On shift work extending over a twenty-four hour period, all shifts are paid at straight time.

(Cement Concrete Workers District Council)

CEMENT MASON

Cement Mason

OFFICE OF THE COMPTROLLER, CITY OF NEW YORK
§220 PREVAILING WAGE SCHEDULE

Effective Period: 7/1/2014 - 6/30/2015

Wage Rate per Hour: **\$38.88**

Supplemental Benefit Rate per Hour: **\$39.80**

Supplemental Note: For time and one half overtime - \$49.05; For double overtime - \$58.30

Overtime Description

Time and one-half the regular rate after an 8 hour day, double time the regular rate after 10 hours. Time and one-half the regular rate on Saturday, double time the regular rate after 10 hours. Double time the regular rate on Sunday.

Overtime Holidays

Double time the regular rate for work on the following holiday(s).

New Year's Day

President's Day

Good Friday

Memorial Day

Independence Day

Labor Day

Columbus Day

Presidential Election Day

Thanksgiving Day

Christmas Day

Paid Holidays

Any worker who reports to work on Christmas Eve or New Year's Eve pursuant to his employer's instruction shall be entitled to three (3) hours afternoon pay without working.

Shift Rates

For an off shift day, (work at times other than the regular 7:00 A.M. to 3:30 P.M. work day) a cement mason shall be paid at the regular hourly rate plus a 25% per hour differential. Four Days a week at Ten (10)hour day.

Local #780)

CORE DRILLER

Core Driller

Effective Period: 7/1/2014 - 6/30/2015

Wage Rate per Hour: **\$35.71**

Supplemental Benefit Rate per Hour: **\$21.69**

Core Driller Helper

Effective Period: 7/1/2014 - 6/30/2015

Wage Rate per Hour: **\$28.60**

Supplemental Benefit Rate per Hour: **\$21.69**

OFFICE OF THE COMPTROLLER, CITY OF NEW YORK
§220 PREVAILING WAGE SCHEDULE

Core Driller Helper(Third year in the industry)

Effective Period: 7/1/2014 - 6/30/2015
Wage Rate per Hour: **\$25.74**
Supplemental Benefit Rate per Hour: **\$21.69**

Core Driller Helper (Second year in the industry)

Effective Period: 7/1/2014 - 6/30/2015
Wage Rate per Hour: **\$22.88**
Supplemental Benefit Rate per Hour: **\$21.69**

Core Driller Helper (First year in the industry)

Effective Period: 7/1/2014 - 6/30/2015
Wage Rate per Hour: **\$20.02**
Supplemental Benefit Rate per Hour: **\$21.69**

Overtime Description

Time and one half the regular rate for work on a holiday plus Holiday pay when worked.

Overtime

Time and one half the regular rate after an 8 hour day.
Time and one half the regular rate for Saturday.
Double time the regular rate for Sunday.
Time and one half the regular rate for work on the following holiday(s).

Paid Holidays

New Year's Day
Memorial Day
Independence Day
Labor Day
Thanksgiving Day
Christmas Day

Shift Rates

The shift day shall be the continuous eight and one-half (8½) hours from 6:00 A.M. to 2:30 P.M. and from 2:30 P.M. to 11:00 P.M., including one-half (½) hour of employees regular rate of pay for lunch. When two (2) or more shifts are employed, single time shall be paid for each shift, but those employees employed on a shift other than from 8:00 A.M. to 5:00 P.M. shall, in addition, receive seventy-five cents (\$0.75) per hour differential for each hour worked. When three (3) shifts are needed, each shift shall work seven and one-half (7 ½) hours paid for eight (8) hours of labor and be permitted one-half (½) hour for mealtime.

(Carpenters District Council)

OFFICE OF THE COMPTROLLER, CITY OF NEW YORK
\$220 PREVAILING WAGE SCHEDULE

DERRICKPERSON AND RIGGER

Derrick Person & Rigger

Effective Period: 7/1/2014 - 6/30/2015

Wage Rate per Hour: \$42.25

Supplemental Benefit Rate per Hour: \$47.81

Supplemental Note: The above supplemental rate applies for work performed in Manhattan, Bronx, Brooklyn and Queens. \$49.23 - For work performed in Staten Island.

Overtime Description

The first two hours of overtime on weekdays and the first seven hours of work on Saturdays are paid at time and one half for wages and supplemental benefits. All additional overtimes is paid at double time for wages and supplemental benefits. Deduct \$1.42 from the Staten Island hourly benefits rate before computing overtime.

Overtime

Double time the regular rate for Sunday.

Overtime Holidays

Double time the regular rate for work on the following holiday(s).

- New Year's Day
- Washington's Birthday
- Good Friday
- Memorial Day
- Independence Day
- Labor Day
- Thanksgiving Day
- Christmas Day

Paid Holidays

1/2 day on Christmas Eve if work is performed in the A.M.

Local #197)

DIVER

Diver (Marine)

Effective Period: 7/1/2014 - 6/30/2015

Wage Rate per Hour: \$61.30

Supplemental Benefit Rate per Hour: \$46.12

Diver Tender (Marine)

Effective Period: 7/1/2014 - 6/30/2015

Wage Rate per Hour: \$43.45

Supplemental Benefit Rate per Hour: \$46.12

OFFICE OF THE COMPTROLLER, CITY OF NEW YORK
§220 PREVAILING WAGE SCHEDULE

Overtime

Time and one half the regular rate after an 8 hour day.

Time and one half the regular rate for Saturday.

Double time the regular rate for Sunday.

Saturday may be used as a make-up day at straight time when a day is lost during that week to inclement weather.

Overtime Holidays

Double time the regular rate for work on the following holiday(s).

New Year's Day

President's Day

Memorial Day

Independence Day

Labor Day

Columbus Day

Presidential Election Day

Thanksgiving Day

Christmas Day

Paid Holidays

None

Shift Rates

When three shifts are utilized each shift shall work seven and one half-hours (7 1/2 hours) and paid for 8 hours, allowing for one half hour for lunch.

(Carpenters District Council)

DOCKBUILDER - PILE DRIVER

Dockbuilder - Pile Driver

Effective Period: 7/1/2014 - 6/30/2015

Wage Rate per Hour: \$48.35

Supplemental Benefit Rate per Hour: \$46.12

Overtime

Time and one half the regular rate after an 8 hour day.

Time and one half the regular rate for Saturday.

Double time the regular rate for Sunday.

Saturday may be used as a make-up day at straight time when a day is lost during that week to inclement weather.

Overtime Holidays

Double time the regular rate for work on the following holiday(s).

New Year's Day

President's Day

OFFICE OF THE COMPTROLLER, CITY OF NEW YORK
\$220 PREVAILING WAGE SCHEDULE

Memorial Day
Independence Day
Labor Day
Columbus Day
Presidential Election Day
Thanksgiving Day
Christmas Day

Paid Holidays

None

Shift Rates

Off shift work commencing between 5:00 P.M. and 11:00 P.M. shall work eight and one half hours allowing for one half hour for lunch. The wage rate shall be 113% of the straight time hourly wage rate.

(Carpenters District Council)

DRIVER: TRUCK (TEAMSTER)

Driver - Dump Truck

Effective Period: 7/1/2014 - 6/30/2015

Wage Rate per Hour: **\$38.86**

Supplemental Benefit Rate per Hour: **\$40.44**

Supplemental Note: Over 40 hours worked: time and one half rate \$16.94, double time rate \$22.59

Driver - Tractor Trailer

Effective Period: 7/1/2014 - 6/30/2015

Wage Rate per Hour: **\$38.88**

Supplemental Benefit Rate per Hour: **\$41.70**

Supplemental Note: For over 40 hours worked: at time and one half - \$15.90; at double time - \$21.21

Driver - Euclid & Turnapull Operator

Effective Period: 7/1/2014 - 6/30/2015

Wage Rate per Hour: **\$39.44**

Supplemental Benefit Rate per Hour: **\$41.70**

Supplemental Note: Over 40 hours worked: time and one half rate \$15.90, double time rate \$21.21

Overtime Description

For Paid Holidays: Holiday pay for all holidays shall be prorated based two hours per day for each day worked in the holiday week, not to exceed 8 hours of holiday pay. For Thanksgiving week, the prorated share shall be 5 1/3 hours of holiday pay for each day worked in Thanksgiving week.

Overtime

Time and one half the regular rate after an 8 hour day.

OFFICE OF THE COMPTROLLER, CITY OF NEW YORK
§220 PREVAILING WAGE SCHEDULE

Time and one half the regular rate for Saturday.
Double time the regular rate for Sunday.

Overtime Holidays

Double time the regular rate for work on the following holiday(s).

New Year's Day
President's Day
Memorial Day
Independence Day
Labor Day
Columbus Day
Veteran's Day
Thanksgiving Day
Day after Thanksgiving
Christmas Day

Paid Holidays

New Year's Day
President's Day
Memorial Day
Independence Day
Labor Day
Columbus Day
Veteran's Day
Thanksgiving Day
Day after Thanksgiving
Christmas Day

Driver Redi-Mix (Sand & Gravel)

Effective Period: 7/1/2014 - 6/30/2015

Wage Rate per Hour: \$36.05

Supplemental Benefit Rate per Hour: \$38.60

Supplemental Note: Over 40 hours worked: time and one half rate \$13.53, double time rate \$18.04

Overtime Description

For Paid Holidays: Employees working two (2) days in the calendar week in which the holiday falls are to paid for these holidays, provided they shape each remaining workday during that calendar week.

Overtime

Time and one half the regular rate after an 8 hour day.
Time and one half the regular rate for Saturday.
Double time the regular rate for Sunday.

Overtime Holidays

Double time the regular rate for work on the following holiday(s).

President's Day
Columbus Day
Veteran's Day

OFFICE OF THE COMPTROLLER, CITY OF NEW YORK
§220 PREVAILING WAGE SCHEDULE

Triple time the regular rate for work on the following holiday(s).

New Year's Day
Memorial Day
Independence Day
Labor Day
Thanksgiving Day
Christmas Day

Paid Holidays

New Year's Day
President's Day
Memorial Day
Independence Day
Labor Day
Columbus Day
Election Day
Thanksgiving Day
Christmas Day

(Local #282)

ELECTRICIAN

(Including all low voltage cabling carrying data; video; and voice in combination with data and or video.)

Electrician "A" (Regular Day)

Effective Period: 7/1/2014 - 5/12/2015

Wage Rate per Hour: \$53.00

Supplemental Benefit Rate per Hour: \$47.54

Effective Period: 5/13/2015 - 6/30/2015

Wage Rate per Hour: \$54.00

Supplemental Benefit Rate per Hour: \$50.03

Electrician "A" (Regular Day Overtime)

Effective Period: 7/1/2014 - 5/12/2015

Wage Rate per Hour: \$79.50

Supplemental Benefit Rate per Hour: \$50.86

Effective Period: 5/13/2015 - 6/30/2015

Wage Rate per Hour: \$81.00

Supplemental Benefit Rate per Hour: \$53.41

OFFICE OF THE COMPTROLLER, CITY OF NEW YORK
\$220 PREVAILING WAGE SCHEDULE

Electrician "A" (Day Shift)

Effective Period: 7/1/2014 - 5/12/2015

Wage Rate per Hour: \$53.00

Supplemental Benefit Rate per Hour: \$47.54

Effective Period: 5/13/2015 - 6/30/2015

Wage Rate per Hour: \$54.00

Supplemental Benefit Rate per Hour: \$50.03

Electrician "A" (Day Shift Overtime After 8 hours)

Effective Period: 7/1/2014 - 5/12/2015

Wage Rate per Hour: \$79.50

Supplemental Benefit Rate per Hour: \$50.86

Effective Period: 5/13/2015 - 6/30/2015

Wage Rate per Hour: \$81.00

Supplemental Benefit Rate per Hour: \$53.41

Electrician "A" (Swing Shift)

Effective Period: 7/1/2014 - 5/12/2015

Wage Rate per Hour: \$62.19

Supplemental Benefit Rate per Hour: \$54.07

Effective Period: 5/13/2015 - 6/30/2015

Wage Rate per Hour: \$63.36

Supplemental Benefit Rate per Hour: \$56.94

Electrician "A" (Swing Shift Overtime After 7.5 hours)

Effective Period: 7/1/2014 - 5/12/2015

Wage Rate per Hour: \$93.29

Supplemental Benefit Rate per Hour: \$57.97

Effective Period: 5/13/2015 - 6/30/2015

Wage Rate per Hour: \$95.04

Supplemental Benefit Rate per Hour: \$60.91

Electrician "A" (Graveyard Shift)

Effective Period: 7/1/2014 - 5/12/2015

Wage Rate per Hour: \$69.66

Supplemental Benefit Rate per Hour: \$59.59

Effective Period: 5/13/2015 - 6/30/2015

Wage Rate per Hour: \$70.97

Supplemental Benefit Rate per Hour: \$62.78

OFFICE OF THE COMPTROLLER, CITY OF NEW YORK
§220 PREVAILING WAGE SCHEDULE

Electrician "A" (Graveyard Shift Overtime After 7 hours)

Effective Period: 7/1/2014 - 5/12/2015

Wage Rate per Hour: \$104.49

Supplemental Benefit Rate per Hour: \$63.96

Effective Period: 5/13/2015 - 6/30/2015

Wage Rate per Hour: \$106.46

Supplemental Benefit Rate per Hour: \$67.23

Overtime

Time and one half the regular rate after a 7 hour day.

Time and one half the regular rate for Saturday.

Time and one half the regular rate for Sunday.

Overtime Holidays

Time and one half the regular rate for work on a holiday.

New Year's Day

Martin Luther King Jr. Day

President's Day

Memorial Day

Independence Day

Labor Day

Columbus Day

Veteran's Day

Thanksgiving Day

Day after Thanksgiving

Christmas Day

Paid Holidays

None

Shift Rates

When so elected by the Employer, one or more shifts of at least five days duration may be scheduled as follows:

Day Shift: 8:00 am to 4:30 pm, Swing Shift 4:30 pm to 12:30 am, Graveyard Shift: 12:30 am to 8:00 am.

For multiple shifts of temporary light and/or power, the temporary light and/or power employee shall be paid for 8 hours at the straight time rate. For three or less workers performing 8 hours temporary light and/or power the supplemental benefit rate is \$23.63. Effective 5/13/2015 - \$24.39.

Electrician "M" (First 8 hours)

"M" rated work shall be defined as jobbing: electrical work of limited duration and scope, also consisting of repairs and/or replacement of electrical and tele-data equipment. Includes all work necessary to retrofit, service, maintain and repair all kinds of lighting fixtures and local lighting controls and washing and cleaning of foregoing fixtures.

OFFICE OF THE COMPTROLLER, CITY OF NEW YORK
§220 PREVAILING WAGE SCHEDULE

Effective Period: 7/1/2014 - 5/12/2015

Wage Rate per Hour: \$27.00

Supplemental Benefit Rate per Hour: \$20.32

First and Second Year "M" Wage Rate Per Hour - Hired on or before 5/10/07: \$26.30

First and Second Year "M" Supplemental Rate- Hired on or before 5/10/07: \$19.96

First and Second Year "M" Wage Rate Per Hour - Hired after 5/10/07: \$22.50

First and Second Year "M" Supplemental Rate- Hired after 5/10/07: \$18.06

Effective Period: 5/13/2015 - 6/30/2015

Wage Rate per Hour: \$27.50

Supplemental Benefit Rate per Hour: \$20.82

First and Second Year "M" Wage Rate Per Hour - Hired on or before 5/10/07: \$26.80

First and Second Year "M" Supplemental Rate- Hired on or before 5/10/07: \$20.46

First and Second Year "M" Wage Rate Per Hour - Hired after 5/10/07: \$23.00

First and Second Year "M" Supplemental Rate- Hired after 5/10/07: \$18.56

Electrician "M" (Overtime After First 8 hours)

"M" rated work shall be defined as jobbing: electrical work of limited duration and scope, also consisting of repairs and/or replacement of electrical and tele-data equipment. Includes all work necessary to retrofit, service, maintain and repair all kinds of lighting fixtures and local lighting controls and washing and cleaning of foregoing fixtures.

Effective Period: 7/1/2014 - 5/12/2015

Wage Rate per Hour: \$40.50

Supplemental Benefit Rate per Hour: \$22.01

First and Second Year "M" Wage Rate Per Hour - Hired on or before 5/10/07: \$39.45

First and Second Year "M" Supplemental Rate- Hired on or before 5/10/07: \$21.61

First and Second Year "M" Wage Rate Per Hour - Hired after 5/10/07: \$33.75

First and Second Year "M" Supplemental Rate- Hired after 5/10/07: \$19.47

Effective Period: 5/13/2015 - 6/30/2015

Wage Rate per Hour: \$41.25

Supplemental Benefit Rate per Hour: \$22.54

First and Second Year "M" Wage Rate Per Hour - Hired on or before 5/10/07: \$40.20

First and Second Year "M" Supplemental Rate- Hired on or before 5/10/07: \$22.14

First and Second Year "M" Wage Rate Per Hour - Hired after 5/10/07: \$34.50

First and Second Year "M" Supplemental Rate- Hired after 5/10/07: \$20.00

Overtime

Time and one half the regular rate after an 8 hour day.

Time and one half the regular rate for Saturday.

Time and one half the regular rate for Sunday.

Overtime Holidays

Time and one half the regular rate for work on the following holiday(s).

New Year's Day

Martin Luther King Jr. Day

President's Day

Memorial Day

Independence Day

Labor Day

OFFICE OF THE COMPTROLLER, CITY OF NEW YORK
\$220 PREVAILING WAGE SCHEDULE

Columbus Day
Veteran's Day
Thanksgiving Day
Day after Thanksgiving
Christmas Day

Paid Holidays

None

(Local #3)

ELECTRICIAN - ALARM TECHNICIAN

(Scope of Work - Inspect, test, repair, and replace defective, malfunctioning, or broken devices, components and controls of Fire, Burglar and Security Systems)

Alarm Technician

Effective Period: 7/1/2014 - 6/30/2015

Wage Rate per Hour: \$30.40

Supplemental Benefit Rate per Hour: \$13.90

Supplemental Note: \$12.40 only after 8 hours worked in a day

Overtime Description

Time and one half the regular rate for work on the following holidays: Columbus Day, Veterans Day, Day after Thanksgiving.

Double time the regular rate for work on the following holidays: New Year's day, Martin Luther King Jr. Day, President's Day, Memorial Day, Independence Day, Labor Day, Thanksgiving Day, Christmas Day.

Overtime

Time and one half the regular rate after an 8 hour day.

Time and one half the regular rate for Saturday.

Double time the regular rate for Sunday.

Paid Holidays

New Year's Day
Martin Luther King Jr. Day
President's Day
Memorial Day
Independence Day
Labor Day
Columbus Day
Veteran's Day
Thanksgiving Day
Day after Thanksgiving
Christmas Day

OFFICE OF THE COMPTROLLER, CITY OF NEW YORK
\$220 PREVAILING WAGE SCHEDULE

Shift Rates

Night Differential is based upon a ten percent (10%) differential between the hours of 4:00 P.M. and 12:30 A.M. and a fifteen percent (15%) differential for the hours 12:00 A.M. to 8:00 A.M.

Vacation

At least 1 year of employment.....ten (10) days
5 years or more of employment.....fifteen (15) days
10 years of employment.....twenty (20) days
Plus one Personal Day per year

Sick Days:
One day per Year

(Local #3)

ELECTRICIAN-STREET LIGHTING WORKER

Electrician - Electro Pole Electrician

Effective Period: 7/1/2014 - 5/19/2015
Wage Rate per Hour: **\$53.00**
Supplemental Benefit Rate per Hour: **\$49.34**

Effective Period: 5/20/2015 - 6/30/2015
Wage Rate per Hour: **\$54.00**
Supplemental Benefit Rate per Hour: **\$51.86**

Electrician - Electro Pole Foundation Installer

Effective Period: 7/1/2014 - 5/19/2015
Wage Rate per Hour: **\$40.18**
Supplemental Benefit Rate per Hour: **\$37.73**

Effective Period: 5/20/2015 - 6/30/2015
Wage Rate per Hour: **\$40.93**
Supplemental Benefit Rate per Hour: **\$39.46**

Electrician - Electro Pole Maintainer

Effective Period: 7/1/2014 - 5/19/2015
Wage Rate per Hour: **\$34.40**
Supplemental Benefit Rate per Hour: **\$34.00**

Effective Period: 5/20/2015 - 6/30/2015
Wage Rate per Hour: **\$35.05**
Supplemental Benefit Rate per Hour: **\$35.51**

OFFICE OF THE COMPTROLLER, CITY OF NEW YORK
§220 PREVAILING WAGE SCHEDULE

Overtime Description

Electrician - Electro Pole Electrician: Time and one half the regular rate after a 7 hour day and after 5 consecutive days worked per week.

Electrician - Electro Pole Foundation Installer: Time and one half the regular rate after 8 hours within a 24 hour period and Saturday and Sunday.

Electrician - Electro Pole Maintainer: Time and one half the regular rate after a 7 hour day and after 5 consecutive days worked per week. Saturdays and Sundays may be used as a make-up day at straight time when a day is lost during the week to inclement weather.

Overtime Holidays

Time and one half the regular rate for work on the following holiday(s).

New Year's Day

Martin Luther King Jr. Day

President's Day

Memorial Day

Independence Day

Labor Day

Columbus Day

Veteran's Day

Thanksgiving Day

Day after Thanksgiving

Christmas Day

Paid Holidays

None

(Local #3)

ELEVATOR CONSTRUCTOR

Elevator Constructor

Effective Period: 7/1/2014 - 3/16/2015

Wage Rate per Hour: \$58.23

Supplemental Benefit Rate per Hour: \$29.47

Effective Period: 3/17/2015 - 6/30/2015

Wage Rate per Hour: \$59.55

Supplemental Benefit Rate per Hour: \$31.07

Overtime Description

For New Construction: work performed after 7 or 8 hour day, Saturday, Sunday or between 4:30pm and 7:00am shall be paid at double time rate.

Existing buildings: work performed after an 8 hour day, Saturday, Sunday or between 5:30pm and 7:00 am shall be paid time and one half.

Overtime

OFFICE OF THE COMPTROLLER, CITY OF NEW YORK
§220 PREVAILING WAGE SCHEDULE

Double time the regular rate for work on the following holiday(s).

Paid Holidays

New Year's Day
President's Day
Good Friday
Memorial Day
Independence Day
Labor Day
Columbus Day
Veteran's Day
Thanksgiving Day
Day after Thanksgiving
Christmas Day

Vacation

Employer contributes 8% of regular basic hourly rate as vacation pay for employees with more than 15 years of service, and 6% for employees with 5 to 15 years of service, and 4% for employees with less than 5 years of service.

(Local #1)

ELEVATOR REPAIR & MAINTENANCE

Elevator Service/Modernization Mechanic

Effective Period: 7/1/2014 - 3/16/2015

Wage Rate per Hour: \$46.00

Supplemental Benefit Rate per Hour: \$28.78

Effective Period: 3/17/2015 - 6/30/2015

Wage Rate per Hour: \$46.92

Supplemental Benefit Rate per Hour: \$30.91

Overtime Description

For Service Work: Double time - all work performed on Sundays, Holidays, and between midnight and 7:00am.

Overtime

Time and one half the regular rate after an 8 hour day.

Time and one half the regular rate for Saturday.

Time and one half the regular rate for Sunday.

Time and one half the regular rate for work on a holiday plus the day's pay.

Paid Holidays

New Year's Day
President's Day
Good Friday
Memorial Day
Independence Day

OFFICE OF THE COMPTROLLER, CITY OF NEW YORK
§220 PREVAILING WAGE SCHEDULE

Labor Day
Columbus Day
Veteran's Day
Thanksgiving Day
Day after Thanksgiving
Christmas Day

Shift Rates

For Modernization Work (4pm to 12:30am) - regularly hourly rate plus a (15%) fifteen percent differential.

Vacation

Employer contributes 8% of regular basic hourly rate as vacation pay for employees with more than 15 years of service, and 6% for employees with 5 to 15 years of service, and 4% for employees with less than 5 years of service.

(Local #1)

ENGINEER

Engineer - Heavy Construction Operating Engineer I

Cherry pickers 20 tons and over and Loaders (rubber tired and/or tractor type with a manufacturer's minimum rated capacity of six cubic yards and over).

Effective Period: 7/1/2014 - 6/30/2015

Wage Rate per Hour: \$61.05

Supplemental Benefit Rate per Hour: \$31.93

Supplemental Note: \$57.46 on overtime

Shift Wage Rate: \$97.68

Engineer - Heavy Construction Operating Engineer II

Backhoes, Basin Machines, Groover, Mechanical Sweepers, Bobcat, Boom Truck, Barrier Transport (Barrier Mover) & machines of similar nature. Operation of Churn Drills and machines of a similar nature, Stetco Silent Hoist and machines of similar nature, Vac-Alls, Meyers Machines, John Beam and machines of a similar nature, Ross Carriers and Travel Lifts and machines of a similar nature, Bulldozers, Scrapers and Turn-a-Pulls: Tugger Hoists (Used exclusively for handling excavated material); Tractors with attachments, Hyster and Roustabout Cranes, Cherry pickers. Austin Western, Grove and machines of a similar nature, Scoopmobiles, Monorails, Conveyors, Trenchers: Loaders-Rubber Tired and Tractor: Barber Greene and Eimco Loaders and Eimco Backhoes; Mighty Midget and similar breakers and Tampers, Curb and Gutter Pavers and Motor Patrol, Motor Graders and all machines of a similar nature. Locomotives 10 Tons or under. Mini-Max, Break-Tech and machines of a similar nature; Milling machines, robotic and demolition machines and machines of a similar nature, shot blaster, skid steer machines and machines of a similar nature including bobcat, pile rig rubber-tired excavator (37,000 lbs. and under), 2 man auger.

Effective Period: 7/1/2014 - 6/30/2015

Wage Rate per Hour: \$59.24

Supplemental Benefit Rate per Hour: \$31.93

Supplemental Note: \$57.46 on overtime

Shift Wage Rate: \$94.78

OFFICE OF THE COMPTROLLER, CITY OF NEW YORK
§220 PREVAILING WAGE SCHEDULE

Engineer - Heavy Construction Operating Engineer III

Minor Equipment such as Tractors, Post Hole Diggers, Ditch Witch (Walk Behind), Road Finishing Machines, Rollers five tons and under, Tugger Hoists, Dual Purpose Trucks, Fork Lifts, and Dempsey Dumpers, Fireperson.

Effective Period: 7/1/2014 - 6/30/2015
Wage Rate per Hour: \$56.22
Supplemental Benefit Rate per Hour: \$31.93
Supplemental Note: \$57.46 on overtime
Shift Wage Rate: \$89.95

Engineer - Heavy Construction Maintenance Engineer I

Installing, Repairing, Maintaining, Dismantling and Manning of all equipment including Steel Cutting, Bending and Heat Sealing Machines, Mechanical Heaters, Grout Pumps, Bentonite Pumps & Plants, Screening Machines, Fusion Coupling Machines, Tunnel Boring Machines Moles and Machines of a similar nature, Power Packs, Mechanical Hydraulic Jacks; all drill rigs including but not limited to Churn, Rotary Caisson, Raised Bore & Drills of a similar nature; Personnel, Inspection & Safety Boats or any boats used to perform functions of same, Mine Hoists, Whirlies, all Climbing Cranes, all Tower Cranes, including but not limited to Truck Mounted and Crawler Type and machines of similar nature; Maintaining Hydraulic Drills and machines of a similar nature; Well Point System-Installation and dismantling; Burning, Welding, all Pumps regardless of size and/or motor power, except River Cofferdam Pumps and Wells Point Pumps; Motorized Buggies (three or more); equipment used in the cleaning and televising of sewers, but not limited to jet-rodder/vacuum truck, vacall/vactor, closed circuit television inspection equipment; high powered water pumps, jet pumps; screed machines and concrete finishing machines of a similar nature; vermeers.

Effective Period: 7/1/2014 - 6/30/2015
Wage Rate per Hour: \$58.97
Supplemental Benefit Rate per Hour: \$31.93
Supplemental Note: \$57.46 on overtime
Shift Wage Rate: \$94.35

Engineer - Heavy Construction Maintenance Engineer II

On Base Mounted Tower Cranes

Effective Period: 7/1/2014 - 6/30/2015
Wage Rate per Hour: \$77.30
Supplemental Benefit Rate per Hour: \$31.93
Supplemental Note: \$57.46 on overtime
Shift Wage Rate: \$123.68

Engineer - Heavy Construction Maintenance Engineer III

On Generators, Light Towers

Effective Period: 7/1/2014 - 6/30/2015
Wage Rate per Hour: \$39.10
Supplemental Benefit Rate per Hour: \$31.93
Supplemental Note: \$57.46 on overtime

OFFICE OF THE COMPTROLLER, CITY OF NEW YORK
§220 PREVAILING WAGE SCHEDULE

Shift Wage Rate: \$62.56

Engineer - Heavy Construction Maintenance Engineer IV

On Pumps and Mixers including mud sucking

Effective Period: 7/1/2014 - 6/30/2015

Wage Rate per Hour: \$40.11

Supplemental Benefit Rate per Hour: \$31.93

Supplemental Note: \$57.46 on overtime

Shift Wage Rate: \$64.18

Engineer - Heavy Construction Oilers I

Gradalls, Cold Planer Grader, Concrete Pumps, Driving Truck Cranes, Driving and Operating Fuel and Grease Trucks.

Effective Period: 7/1/2014 - 6/30/2015

Wage Rate per Hour: \$53.22

Supplemental Benefit Rate per Hour: \$31.93

Supplemental Note: \$57.46 on overtime

Shift Wage Rate: \$85.15

Engineer - Heavy Construction Oilers II

All gasoline, electric, diesel or air operated Shovels, Draglines, Backhoes, Keystones, Pavers, Guniting Machines, Battery of Compressors, Crawler Cranes, two-person Trenching Machines.

Effective Period: 7/1/2014 - 6/30/2015

Wage Rate per Hour: \$36.97

Supplemental Benefit Rate per Hour: \$31.93

Supplemental Note: \$57.46 on overtime

Shift Wage Rate: \$59.15

Engineer - Steel Erection Maintenance Engineers

Derrick, Travelers, Tower, Crawler Tower and Climbing Cranes

Effective Period: 7/1/2014 - 6/30/2015

Wage Rate per Hour: \$57.05

Supplemental Benefit Rate per Hour: \$31.93

Supplemental Note: \$57.46 on overtime

Shift Wage Rate: \$91.28

Engineer - Steel Erection Oiler I

On a Truck Crane

Effective Period: 7/1/2014 - 6/30/2015

Wage Rate per Hour: \$53.43

OFFICE OF THE COMPTROLLER, CITY OF NEW YORK
§220 PREVAILING WAGE SCHEDULE

Supplemental Benefit Rate per Hour: \$31.93
Supplemental Note: \$57.46 on overtime
Shift Wage Rate: \$85.49

Engineer - Steel Erection Oiler II

On a Crawler Crane

Effective Period: 7/1/2014 - 6/30/2015
Wage Rate per Hour: \$40.84
Supplemental Benefit Rate per Hour: \$31.93
Supplemental Note: \$57.46 on overtime
Shift Wage Rate: \$65.34

Overtime Description

On jobs of more than one shift, if the next shift employee fails to report for work through any cause over which the employer has no control, the employee on duty who works the next shift continues to work at the single time rate.

Overtime

Double time the regular rate after an 8 hour day.
Double time the regular time rate for Saturday.
Double time the regular rate for Sunday.
Double time the regular rate for work on the following holiday(s).

Paid Holidays

New Year's Day
Lincoln's Birthday
President's Day
Memorial Day
Independence Day
Labor Day
Columbus Day
Veteran's Day
Thanksgiving Day
Day after Thanksgiving
Christmas Day

Employees must work at least one day in the payroll week in which the holiday occurs to receive the paid holiday

Engineer - Building Work Maintenance Engineers I

Installing, repairing, maintaining, dismantling (of all equipment including: Steel Cutting and Bending Machines, Mechanical Heaters, Mine Hoists, Climbing Cranes, Tower Cranes, Linden Peine, Lorain, Liebherr, Mannes, or machines of a similar nature, Well Point Systems, Deep Well Pumps, Concrete Mixers with loading Device, Concrete Plants, Motor Generators when used for temporary power and lights), skid steer machines of a similar nature including bobcat.

Effective Period: 7/1/2014 - 6/30/2015
Wage Rate per Hour: \$54.04

OFFICE OF THE COMPTROLLER, CITY OF NEW YORK
§220 PREVAILING WAGE SCHEDULE

Supplemental Benefit Rate per Hour: \$31.93
Supplemental Note: \$57.46 on overtime

Engineer - Building Work Maintenance Engineers II

On Pumps, Generators, Mixers and Heaters

Effective Period: 7/1/2014 - 6/30/2015
Wage Rate per Hour: \$42.10
Supplemental Benefit Rate per Hour: \$31.93
Supplemental Note: \$57.46 on overtime

Engineer - Building Work Oilers I

All gasoline, electric, diesel or air operated Gradealls: Concrete Pumps, Overhead Cranes in Power Houses:
Their duties shall be to assist the Engineer in oiling, greasing and repairing of all machines; Driving Truck
Cranes: Driving and Operating Fuel and Grease Trucks, Cherrypickers (hydraulic cranes) over 70,000 GVW, and
machines of a similar nature.

Effective Period: 7/1/2014 - 6/30/2015
Wage Rate per Hour: \$51.40
Supplemental Benefit Rate per Hour: \$31.93
Supplemental Note: \$57.46 on overtime

Engineer - Building Work Oilers II

Oilers on Crawler Cranes, Backhoes, Trenching Machines, Gunite Machines, Compressors (three or more in
Battery).

Effective Period: 7/1/2014 - 6/30/2015
Wage Rate per Hour: \$38.31
Supplemental Benefit Rate per Hour: \$31.93
Supplemental Note: \$57.46 on overtime

Overtime Description

On jobs of more than one shift, if an Employee fails to report for work through any cause over which the
Employer has no control, the Employee on duty will continue to work at the rate of single time.

Overtime

Double time the regular rate after an 8 hour day.
Double time the regular time rate for Saturday.
Double time the regular rate for Sunday.
Double time the regular rate for work on the following holiday(s).

Paid Holidays

New Year's Day
Lincoln's Birthday
President's Day
Memorial Day
Independence Day
Labor Day

OFFICE OF THE COMPTROLLER, CITY OF NEW YORK
§220 PREVAILING WAGE SCHEDULE

Columbus Day
Veteran's Day
Thanksgiving Day
Christmas Day

Employees must work at least one day in the payroll week in which the holiday occurs to receive the paid holiday

Shift Rates

Off Shift: double time the regular hourly rate.

(Local #15)

ENGINEER - CITY SURVEYOR AND CONSULTANT

Party Chief

Effective Period: 7/1/2014 - 6/30/2015

Wage Rate per Hour: \$35.55

Supplemental Benefit Rate per Hour: \$17.65

Instrument Person

Effective Period: 7/1/2014 - 6/30/2015

Wage Rate per Hour: \$29.41

Supplemental Benefit Rate per Hour: \$17.65

Rodperson

Effective Period: 7/1/2014 - 6/30/2015

Wage Rate per Hour: \$25.54

Supplemental Benefit Rate per Hour: \$17.65

Overtime Description

Overtime Benefit Rate - \$23.63 per hour (time & one half) \$29.95 per hour (double time).
Time and one half the regular rate after an 8 hour day, Time and one half the regular rate for Saturday for the first eight hours worked, Double time the regular time rate for Saturday for work performed in excess of eight hours, Double time the regular rate for Sunday and Double time the regular rate for work on a holiday.

Paid Holidays

New Year's Day
Lincoln's Birthday
President's Day
Memorial Day
Independence Day
Labor Day
Columbus Day
Veteran's Day
Thanksgiving Day
Day after Thanksgiving

OFFICE OF THE COMPTROLLER, CITY OF NEW YORK
§220 PREVAILING WAGE SCHEDULE

Christmas Day

Employees must work at least one day in the payroll week in which the holiday occurs to receive the paid holiday

(Operating Engineer Local #15-D)

ENGINEER - FIELD (BUILDING CONSTRUCTION)
(Construction of Building Projects, Concrete Superstructures, etc.)

Field Engineer - BC Party Chief

Effective Period: 7/1/2014 - 6/30/2015

Wage Rate per Hour: \$55.40

Supplemental Benefit Rate per Hour: \$30.62

Supplemental Note: Overtime Benefit Rate - \$42.73 per hour (time & one half) \$54.84 per hour (double time).

Field Engineer - BC Instrument Person

Effective Period: 7/1/2014 - 6/30/2015

Wage Rate per Hour: \$43.10

Supplemental Benefit Rate per Hour: \$30.62

Supplemental Note: Overtime Benefit Rate - \$42.73 per hour (time & one half) \$54.84 per hour (double time).

Field Engineer - BC Rodperson

Effective Period: 7/1/2014 - 6/30/2015

Wage Rate per Hour: \$27.96

Supplemental Benefit Rate per Hour: \$30.62

Supplemental Note: Overtime Benefit Rate - \$42.73 per hour (time & one half) \$54.84 per hour (double time).

Overtime Description

Time and one half the regular rate after a 7 hour work and time and one half the regular rate for Saturday for the first seven hours worked, Double time the regular time rate for Saturday for work performed in excess of seven hours, Double time the regular rate for Sunday and Double time the regular rate for work on a holiday.

Paid Holidays

New Year's Day

President's Day

Good Friday

Memorial Day

Independence Day

Labor Day

Columbus Day

Veteran's Day

Thanksgiving Day

Christmas Day

Employees must work at least one day in the payroll week in which the holiday occurs to receive the paid holiday

OFFICE OF THE COMPTROLLER, CITY OF NEW YORK
§220 PREVAILING WAGE SCHEDULE

(Operating Engineer Local #15-D)

ENGINEER - FIELD (HEAVY CONSTRUCTION)
(Construction of Roads, Tunnels, Bridges, Sewers, Building Foundations,
Engineering Structures etc.)

Field Engineer - HC Party Chief

Effective Period: 7/1/2014 - 6/30/2015

Wage Rate per Hour: \$62.61

Supplemental Benefit Rate per Hour: \$30.62

Supplemental Note: Overtime benefit rate - \$42.73 per hour (time & one half), \$54.84 per hour (double time).

Field Engineer - HC Instrument Person

Effective Period: 7/1/2014 - 6/30/2015

Wage Rate per Hour: \$46.00

Supplemental Benefit Rate per Hour: \$30.62

Supplemental Note: Overtime benefit rate - \$42.73 per hour (time & one half), \$54.84 per hour (double time).

Field Engineer - HC Rodperson

Effective Period: 7/1/2014 - 6/30/2015

Wage Rate per Hour: \$38.61

Supplemental Benefit Rate per Hour: \$30.62

Supplemental Note: Overtime benefit rate - \$42.73 per hour (time & one half), \$54.84 per hour (double time).

Overtime Description

Time and one half the regular rate after an 8 hour day, Time and one half the regular rate for Saturday for the first eight hours worked, Double time the regular time rate for Saturday for work performed in excess of eight hours, Double time the regular rate for Sunday and Double time the regular rate for work on a holiday.

Paid Holidays

New Year's Day

Lincoln's Birthday

President's Day

Memorial Day

Independence Day

Labor Day

Columbus Day

Veteran's Day

Thanksgiving Day

Christmas Day

Employees must work at least one day in the payroll week in which the holiday occurs to receive the paid holiday

OFFICE OF THE COMPTROLLER, CITY OF NEW YORK
§220 PREVAILING WAGE SCHEDULE

(Operating Engineer Local #15-D)

ENGINEER - FIELD (STEEL ERECTION)

Field Engineer - Steel Erection Party Chief

Effective Period: 7/1/2014 - 6/30/2015

Wage Rate per Hour: \$58.50

Supplemental Benefit Rate per Hour: \$30.62

Supplemental Note: Overtime benefit rate - \$42.73 per hour (time & one half), \$54.84 per hour (double time).

Field Engineer - Steel Erection Instrument Person

Effective Period: 7/1/2014 - 6/30/2015

Wage Rate per Hour: \$45.53

Supplemental Benefit Rate per Hour: \$30.62

Supplemental Note: Overtime benefit rate - \$42.73 per hour (time & one half), \$54.84 per hour (double time).

Field Engineer - Steel Erection Rodperson

Effective Period: 7/1/2014 - 6/30/2015

Wage Rate per Hour: \$30.43

Supplemental Benefit Rate per Hour: \$30.62

Supplemental Note: Overtime benefit rate - \$42.73 per hour (time & one half), \$54.84 per hour (double time).

Overtime Description

Time and one half the regular rate for Saturday for the first eight hours worked.

Double time the regular rate for Saturday for work performed in excess of eight hours.

Overtime

Time and one half the regular rate after an 8 hour day.

Double time the regular rate for Sunday.

Double time the regular rate for work on the following holiday(s).

Paid Holidays

New Year's Day

Lincoln's Birthday

President's Day

Memorial Day

Independence Day

Labor Day

Columbus Day

Veteran's Day

Thanksgiving Day

Christmas Day

Employees must work at least one day in the payroll week in which the holiday occurs to receive the paid holiday

OFFICE OF THE COMPTROLLER, CITY OF NEW YORK
§220 PREVAILING WAGE SCHEDULE

(Operating Engineer Local #15-D)

ENGINEER - OPERATING

Operating Engineer - Road & Heavy Construction I

Back Filling Machines, Cranes, Mucking Machines and Dual Drum Paver.

Effective Period: 7/1/2014 - 6/30/2015

Wage Rate per Hour: \$67.70

Supplemental Benefit Rate per Hour: \$28.60

Supplemental Note: \$51.75 overtime hours

Shift Wage Rate: \$108.32

Operating Engineer - Road & Heavy Construction II

Backhoes, Power Shovels, Hydraulic Clam Shells, Steel Erection, Moles and machines of a similar nature.

Effective Period: 7/1/2014 - 6/30/2015

Wage Rate per Hour: \$70.10

Supplemental Benefit Rate per Hour: \$28.60

Supplemental Note: 51.75 overtime hours

Shift Wage Rate: \$112.16

Operating Engineer - Road & Heavy Construction III

Mine Hoists, Cranes, etc. (Used as Mine Hoists)

Effective Period: 7/1/2014 - 6/30/2015

Wage Rate per Hour: \$72.34

Supplemental Benefit Rate per Hour: \$28.60

Supplemental Note: \$51.75 overtime hours

Shift Wage Rate: \$115.74

Operating Engineer - Road & Heavy Construction IV

Gradealls, Keystones, Cranes on land or water (with digging buckets), Bridge Cranes, Vermeer Cutter and machines of a similar nature, Trenching Machines.

Effective Period: 7/1/2014 - 6/30/2015

Wage Rate per Hour: \$70.63

Supplemental Benefit Rate per Hour: \$28.60

Supplemental Note: \$51.75 overtime hours

Shift Wage Rate: \$113.01

Operating Engineer - Road & Heavy Construction V

OFFICE OF THE COMPTROLLER, CITY OF NEW YORK
§220 PREVAILING WAGE SCHEDULE

Pile Drivers & Rigs (employing Dock Builder foreperson): Derrick Boats, Tunnel Shovels.

Effective Period: 7/1/2014 - 6/30/2015
Wage Rate per Hour: \$69.23
Supplemental Benefit Rate per Hour: \$28.60
Supplemental Note: \$51.75 overtime hours
Shift Wage Rate: \$110.77

Operating Engineer - Road & Heavy Construction VI

Mixers (Concrete with loading attachment), Concrete Pavers, Cableways, Land Derricks, Power Houses (Low Air Pressure Units).

Effective Period: 7/1/2014 - 6/30/2015
Wage Rate per Hour: \$65.76
Supplemental Benefit Rate per Hour: \$28.60
Supplemental Note: \$51.75 overtime hours
Shift Wage Rate: \$105.22

Operating Engineer - Road & Heavy Construction VII

Barrier Movers , Barrier Transport and Machines of a Similar Nature.

Effective Period: 7/1/2014 - 6/30/2015
Wage Rate per Hour: \$53.08
Supplemental Benefit Rate per Hour: \$28.60
Supplemental Note: \$51.75 overtime hours
Shift Wage Rate: \$84.93

Operating Engineer - Road & Heavy Construction VIII

Utility Compressors

Effective Period: 7/1/2014 - 6/30/2015
Wage Rate per Hour: \$41.18
Supplemental Benefit Rate per Hour: \$28.60
Supplemental Note: \$51.75 overtime hours
Shift Wage Rate: \$51.93

Operating Engineer - Road & Heavy Construction IX

Horizontal Boring Rig

Effective Period: 7/1/2014 - 6/30/2015
Wage Rate per Hour: \$62.53
Supplemental Benefit Rate per Hour: \$28.60
Supplemental Note: \$51.75 overtime hours
Shift Wage Rate: \$100.05

OFFICE OF THE COMPTROLLER, CITY OF NEW YORK
§220 PREVAILING WAGE SCHEDULE

Operating Engineer - Road & Heavy Construction X

Elevators (manually operated as personnel hoist).

Effective Period: 7/1/2014 - 6/30/2015
Wage Rate per Hour: \$57.46
Supplemental Benefit Rate per Hour: \$28.60
Supplemental Note: \$51.75 overtime hours
Shift Wage Rate: \$91.94

Operating Engineer - Road & Heavy Construction XI

Compressors (Portable 3 or more in battery), Driving of Truck Mounted Compressors, Well-point Pumps, Tugger Machines Well Point Pumps, Churn Drill.

Effective Period: 7/1/2014 - 6/30/2015
Wage Rate per Hour: \$44.63
Supplemental Benefit Rate per Hour: \$28.60
Supplemental Note: \$51.75 overtime hours
Shift Wage Rate: \$71.41

Operating Engineer - Road & Heavy Construction XII

All Drills and Machines of a similar nature.

Effective Period: 7/1/2014 - 6/30/2015
Wage Rate per Hour: \$66.45
Supplemental Benefit Rate per Hour: \$28.60
Supplemental Note: \$51.75 overtime hours
Shift Wage Rate: \$106.32

Operating Engineer - Road & Heavy Construction XIII

Concrete Pumps, Concrete Plant, Stone Crushers, Double Drum Hoist, Power Houses (other than above).

Effective Period: 7/1/2014 - 6/30/2015
Wage Rate per Hour: \$64.34
Supplemental Benefit Rate per Hour: \$28.60
Supplemental Note: \$51.75 overtime hours
Shift Wage Rate: \$102.94

Operating Engineer - Road & Heavy Construction XIV

Concrete Mixer

Effective Period: 7/1/2014 - 6/30/2015
Wage Rate per Hour: \$61.53
Supplemental Benefit Rate per Hour: \$28.60
Supplemental Note: \$51.75 overtime hours
Shift Wage Rate: \$98.45

OFFICE OF THE COMPTROLLER, CITY OF NEW YORK
§220 PREVAILING WAGE SCHEDULE

Operating Engineer - Road & Heavy Construction XV

Compressors (Portable Single or two in Battery, not over 100 feet apart), Pumps (River Cofferdam) and Welding Machines, Push Button Machines, All Engines Irrespective of Power (Power-Pac) used to drive auxiliary equipment, Air, Hydraulic, etc.

Effective Period: 7/1/2014 - 6/30/2015

Wage Rate per Hour: \$41.44

Supplemental Benefit Rate per Hour: \$28.60

Supplemental Note: \$51.75 overtime hours

Shift Wage Rate: \$66.30

Operating Engineer - Road & Heavy Construction XVI

Concrete Breaking Machines, Hoists (Single Drum), Load Masters, Locomotives (over ten tons) and Dinkies over ten tons, Hydraulic Crane-Second Engineer.

Effective Period: 7/1/2014 - 6/30/2015

Wage Rate per Hour: \$58.74

Supplemental Benefit Rate per Hour: \$28.60

Supplemental Note: \$51.85 overtime hours

Shift Wage Rate: \$93.98

Operating Engineer - Road & Heavy Construction XVII

On-Site concrete plant engineer, On-site Asphalt Plant Engineer, and Vibratory console.

Effective Period: 7/1/2014 - 6/30/2015

Wage Rate per Hour: \$59.21

Supplemental Benefit Rate per Hour: \$28.60

Supplemental Note: \$51.75 overtime hours

Shift Wage Rate: \$94.74

Operating Engineer - Road & Heavy Construction XVIII

Tower Crane

Effective Period: 7/1/2014 - 6/30/2015

Wage Rate per Hour: \$85.00

Supplemental Benefit Rate per Hour: \$28.60

Supplemental Note: \$51.75 overtime hours

Shift Wage Rate: \$136.00

Operating Engineer - Paving I

Asphalt Spreaders, Autogrades (C.M.I.), Roto/Mil

Effective Period: 7/1/2014 - 6/30/2015

Wage Rate per Hour: \$65.76

OFFICE OF THE COMPTROLLER, CITY OF NEW YORK
§220 PREVAILING WAGE SCHEDULE

Supplemental Benefit Rate per Hour: **\$28.60**
Supplemental Note: \$51.75 overtime hours
Shift Wage Rate: **\$105.22**

Operating Engineer - Paving II

Asphalt Roller

Effective Period: 7/1/2014 - 6/30/2015
Wage Rate per Hour: **\$64.04**
Supplemental Benefit Rate per Hour: **\$28.60**
Supplemental Note: \$51.75 overtime hours
Shift Wage Rate: **\$102.46**

Operating Engineer - Paving III

Asphalt Plants

Effective Period: 7/1/2014 - 6/30/2015
Wage Rate per Hour: **\$54.17**
Supplemental Benefit Rate per Hour: **\$28.60**
Supplemental Note: \$51.75 overtime hours
Shift Wage Rate: **\$86.67**

Operating Engineer - Concrete I

Cranes

Effective Period: 7/1/2014 - 6/30/2015
Wage Rate per Hour: **\$70.32**
Supplemental Benefit Rate per Hour: **\$28.60**
Supplemental Note: \$51.75 overtime hours

Operating Engineer - Concrete II

Compressors

Effective Period: 7/1/2014 - 6/30/2015
Wage Rate per Hour: **\$41.76**
Supplemental Benefit Rate per Hour: **\$28.60**
Supplemental Note: \$51.75 overtime hours

Operating Engineer - Concrete III

Micro-traps (Negative Air Machines), Vac-All Remediation System.

Effective Period: 7/1/2014 - 6/30/2015
Wage Rate per Hour: **\$56.16**
Supplemental Benefit Rate per Hour: **\$28.60**
Supplemental Note: \$51.75 overtime hours

OFFICE OF THE COMPTROLLER, CITY OF NEW YORK
§220 PREVAILING WAGE SCHEDULE

Operating Engineer - Steel Erection I

Three Drum Derricks

Effective Period: 7/1/2014 - 6/30/2015

Wage Rate per Hour: \$73.37

Supplemental Benefit Rate per Hour: \$28.60

Supplemental Note: \$51.75 overtime hours

Shift Wage Rate: \$117.39

Operating Engineer - Steel Erection II

Cranes, 2 Drum Derricks, Hydraulic Cranes, Fork Lifts and Boom Trucks.

Effective Period: 7/1/2014 - 6/30/2015

Wage Rate per Hour: \$70.50

Supplemental Benefit Rate per Hour: \$28.60

Supplemental Note: \$51.75 overtime hours

Shift Wage Rate: \$112.80

Operating Engineer - Steel Erection III

Compressors, Welding Machines.

Effective Period: 7/1/2014 - 6/30/2015

Wage Rate per Hour: \$41.84

Supplemental Benefit Rate per Hour: \$28.60

Supplemental Note: \$51.75 overtime hours

Shift Wage Rate: \$66.94

Operating Engineer - Steel Erection IV

Compressors - Not Combined with Welding Machine.

Effective Period: 7/1/2014 - 6/30/2015

Wage Rate per Hour: \$39.85

Supplemental Benefit Rate per Hour: \$28.60

Supplemental Note: \$51.75 overtime hours

Shift Wage Rate: \$63.76

Operating Engineer - Building Work I

Forklifts, Plaster (Platform machine), Plaster Bucket, Concrete Pump and all other equipment used for hoisting material.

Effective Period: 7/1/2014 - 6/30/2015

Wage Rate per Hour: \$57.82

Supplemental Benefit Rate per Hour: \$28.60

Supplemental Note: \$51.75 overtime hours

OFFICE OF THE COMPTROLLER, CITY OF NEW YORK
§220 PREVAILING WAGE SCHEDULE

Operating Engineer - Building Work II

Compressors, Welding Machines (Cutting Concrete-Tank Work), Paint Spraying, Sandblasting, Pumps (with the exclusion of Concrete Pumps), All Engines irrespective of Power (Power-Pac) used to drive Auxiliary Equipment, Air, Hydraulic, Jacking System, etc.

Effective Period: 7/1/2014 - 6/30/2015

Wage Rate per Hour: \$43.28

Supplemental Benefit Rate per Hour: \$28.60

Supplemental Note: \$51.75 overtime hours

Operating Engineer - Building Work III

Double Drum

Effective Period: 7/1/2014 - 6/30/2015

Wage Rate per Hour: \$65.83

Supplemental Benefit Rate per Hour: \$28.60

Supplemental Note: \$51.75 overtime hours

Operating Engineer - Building Work IV

Stone Derrick, Cranes, Hydraulic Cranes Boom Trucks.

Effective Period: 7/1/2014 - 6/30/2015

Wage Rate per Hour: \$69.74

Supplemental Benefit Rate per Hour: \$28.60

Supplemental Note: \$51.75 overtime hours

Operating Engineer - Building Work V

Dismantling and Erection of Cranes, Relief Engineer.

Effective Period: 7/1/2014 - 6/30/2015

Wage Rate per Hour: \$64.26

Supplemental Benefit Rate per Hour: \$28.60

Supplemental Note: \$51.75 overtime hours

Operating Engineer - Building Work VI

4 Pole Hoist, Single Drum Hoists.

Effective Period: 7/1/2014 - 6/30/2015

Wage Rate per Hour: \$63.58

Supplemental Benefit Rate per Hour: \$28.60

Supplemental Note: \$51.75 overtime hours

Operating Engineer - Building Work VII

OFFICE OF THE COMPTROLLER, CITY OF NEW YORK
§220 PREVAILING WAGE SCHEDULE

Rack & Pinion and House Cars

Effective Period: 7/1/2014 - 6/30/2015

Wage Rate per Hour: \$50.53

Supplemental Benefit Rate per Hour: \$28.60

Supplemental Note: \$51.75 overtime hours

For New House Car projects started after 7/1/11 only: Wage Rate per Hour \$40.31

Overtime Description

On jobs of more than one shift, if an Employee fails to report for work through any cause over which the Employer has no control, the Employee on duty will continue to work at the rate of single time.

For House Cars and Rack & Pinion only: Overtime paid at time and one-half for all hours in excess of eight hours in a day, Saturday, Sunday and Holidays worked.

Overtime

Double time the regular rate after an 8 hour day.

Double time the regular time rate for Saturday.

Double time the regular rate for Sunday.

Double time the regular rate for work on the following holiday(s).

Paid Holidays

New Year's Day

Lincoln's Birthday

President's Day

Memorial Day

Independence Day

Labor Day

Columbus Day

Veteran's Day

Thanksgiving Day

Day after Thanksgiving

Christmas Day

Employees must work at least one day in the payroll week in which the holiday occurs to receive the paid holiday

Shift Rates

For Steel Erection Only: Shifts may be worked at the single time rate at other than the regular working hours (8:00 A.M. to 4:30 P.M.) on the following work ONLY: Heavy construction jobs on work below the street level, over railroad tracks and on building jobs.

(Operating Engineer Local #14)

FLOOR COVERER

(Interior vinyl composition tile, sheath vinyl linoleum and wood parquet tile including site preparation and synthetic turf not including site preparation)

Floor Coverer

OFFICE OF THE COMPTROLLER, CITY OF NEW YORK
§220 PREVAILING WAGE SCHEDULE

Effective Period: 7/1/2014 - 6/30/2015
Wage Rate per Hour: \$49.88
Supplemental Benefit Rate per Hour: \$44.10

Overtime

Time and one half the regular rate after an 8 hour day.
Time and one half the regular rate for Saturday.
Double time the regular rate for Sunday.

Overtime Holidays

Double time the regular rate for work on the following holiday(s).
New Year's Day
President's Day
Memorial Day
Independence Day
Labor Day
Columbus Day
Presidential Election Day
Thanksgiving Day
Day after Thanksgiving
Christmas Day

Paid Holidays

1/2 day on Christmas Eve if work is performed in the A.M.
1/2 day on New Year's Eve if work is performed in the A.M.

Shift Rates

Two shifts may be utilized with the first shift working 8:00 A.M. to the end of the shift at the straight time of pay.
The second shift will receive one hour at double time rate for the last hour of the shift. (eight for seven, nine for eight).

(Carpenters District Council)

GLAZIER
(New Construction, Remodeling, and Alteration)

Glazier

Effective Period: 7/1/2014 - 10/31/2014
Wage Rate per Hour: \$42.50
Supplemental Benefit Rate per Hour: \$35.09
Supplemental Note: Supplemental Benefit Overtime Rate: \$43.59

Effective Period: 11/1/2014 - 6/30/2015
Wage Rate per Hour: \$42.85
Supplemental Benefit Rate per Hour: \$35.59

OFFICE OF THE COMPTROLLER, CITY OF NEW YORK
§220 PREVAILING WAGE SCHEDULE

Supplemental Note: Supplemental Benefit Overtime Rate: \$44.09

Overtime Description

An optional 8th hour can be worked at straight time rate. If 9th hour is worked, then both hours or more (8th & 9th or more) will be at the double time rate of pay.

Overtime

Double time the regular rate after a 7 hour day.
Double time the regular time rate for Saturday.
Double time the regular rate for Sunday.

Overtime Holidays

Double time the regular rate for work on the following holiday(s).

New Year's Day
President's Day
Memorial Day
Independence Day
Labor Day
Thanksgiving Day
Day after Thanksgiving
Christmas Day

Paid Holidays

None

Shift Rates

Shifts shall be any 7 hours beyond 4:00 P.M. for which the glazier shall receive 8 hours pay for 7 hours worked.

(Local #1281)

GLAZIER - REPAIR & MAINTENANCE

(For the Installation of Glass - All repair and maintenance work on a particular building, whenever performed, where the total cumulative contract value is under \$105,000. Except where enumerated (i.e. plate glass windows) does not apply to non-residential buildings.)

Craft Jurisdiction for repair, maintenance and fabrication

Plate glass replacement, Residential glass replacement, Residential mirrors and shower doors, Storm windows and storm doors, Residential replacement windows, Herculite door repairs, Door closer repairs, Retrofit apartment house (non commercial buildings), Glass tinting.

Effective Period: 7/1/2014 - 6/30/2015

Wage Rate per Hour: \$23.60

Supplemental Benefit Rate per Hour: \$19.04

OFFICE OF THE COMPTROLLER, CITY OF NEW YORK
\$220 PREVAILING WAGE SCHEDULE

Overtime

Time and one half the regular rate after an 8 hour day.
Double time the regular rate for Sunday.
Time and one half the regular hourly rate after 40 hours in any work week.

Paid Holidays

New Year's Day
President's Day
Memorial Day
Independence Day
Labor Day
Thanksgiving Day
Day after Thanksgiving
Christmas Day

(Local #1281)

HEAT AND FROST INSULATOR

Heat & Frost Insulator

Effective Period: 7/1/2014 - 6/30/2015
Wage Rate per Hour: \$56.98
Supplemental Benefit Rate per Hour: \$34.81

Overtime Description

Double time shall be paid for supplemental benefits during overtime work.
8th hour paid at time and one half.

Overtime

Double time the regular rate after an 8 hour day.
Double time the regular time rate for Saturday.
Double time the regular rate for Sunday.

Overtime Holidays

Double time the regular rate for work on the following holiday(s).
New Year's Day
Martin Luther King Jr. Day
President's Day
Memorial Day
Independence Day
Columbus Day
Veteran's Day
Thanksgiving Day
Day after Thanksgiving
Christmas Day

Double time the regular rate for work on the following holiday(s).
Labor Day

OFFICE OF THE COMPTROLLER, CITY OF NEW YORK
§220 PREVAILING WAGE SCHEDULE

Paid Holidays

None

Shift Rates

The first shift shall work seven hours at the regular straight time rate. The second and third shift shall work seven hours the regular straight time hourly rate plus a fourteen percent wage and benefit premium. Off hour work in occupied or retail buildings may be worked on weekdays with an increment of \$1.00 per hour and eight hours pay for seven (7) hours worked. Double time will apply for over seven (7) hours worked on weekdays, weekends or holidays.

(Local #12)

**HOUSE WRECKER
(TOTAL DEMOLITION)**

House Wrecker - Tier A

On all work sites the first, second, eleventh and every third House Wrecker thereafter will be Tier A House Wreckers (i.e. 1st, 2nd, 11th, 14th etc). Other House Wreckers may be Tier B House Wreckers.

Effective Period: 7/1/2014 - 6/30/2015

Wage Rate per Hour: \$34.51

Supplemental Benefit Rate per Hour: \$25.59

House Wrecker - Tier B

Effective Period: 7/1/2014 - 6/30/2015

Wage Rate per Hour: \$24.02

Supplemental Benefit Rate per Hour: \$19.12

Overtime

Time and one half the regular rate after an 8 hour day.

Time and one half the regular rate for Saturday.

Double time the regular rate for Sunday.

Overtime Holidays

Double time the regular rate for work on the following holiday(s).

New Year's Day

President's Day

Memorial Day

Independence Day

Labor Day

Thanksgiving Day

Christmas Day

OFFICE OF THE COMPTROLLER, CITY OF NEW YORK
§220 PREVAILING WAGE SCHEDULE

Paid Holidays

None

(Mason Tenders District Council)

IRON WORKER - ORNAMENTAL

Iron Worker - Ornamental

Effective Period: 7/1/2014 - 6/30/2015

Wage Rate per Hour: \$42.70

Supplemental Benefit Rate per Hour: \$45.77

Supplemental Note: Supplemental benefits are to be paid at the applicable overtime rate when overtime is in effect.

Overtime Description

Time and one half the regular rate after a 7 hour day for a maximum of two hours on any regular work day (the 8th and 9th hour) and double time shall be paid for all work on a regular work day thereafter, time and one half the regular rate for Saturday for the first seven hours of work and double time shall be paid for all work on a Saturday thereafter.

Overtime

Double time the regular rate for Sunday.

Overtime Holidays

Double time the regular rate for work on the following holiday(s).

New Year's Day

President's Day

Memorial Day

Independence Day

Labor Day

Thanksgiving Day

Christmas Day

Paid Holidays

None

Shift Rates

For off shift work - 8 hours pay for 7 hours of work. When two or three shifts are employed on a job, Monday through Friday, the workday for each shift shall be seven hours and paid for ten and one-half hours at the single time rate. When two or three shifts are worked on Saturday, Sunday or holidays, each shift shall be seven hours and paid fifteen and three-quarters hours.

(Local #580)

OFFICE OF THE COMPTROLLER, CITY OF NEW YORK
§220 PREVAILING WAGE SCHEDULE

IRON WORKER - STRUCTURAL

Iron Worker - Structural

Effective Period: 7/1/2014 - 6/30/2015

Wage Rate per Hour: \$47.75

Supplemental Benefit Rate per Hour: \$65.35

Supplemental Note: Supplemental benefits are to be paid at the applicable overtime rate when overtime is in effect.

Overtime Description

Monday through Friday- the first eight hours are paid at straight time, the 9th and 10th hours are paid at time and one-half the regular rate, all additional weekday overtime is paid at double the regular rate. Saturdays- the first eight hours are paid at time and one-half the regular rate, double time thereafter. Sunday-all shifts are paid at double time.

Overtime

Time and one half the regular rate after an 8 hour day.

Time and one half the regular rate for Saturday.

Double time the regular rate for Sunday.

Overtime Holidays

Double time the regular rate for work on the following holiday(s).

New Year's Day

Good Friday

Memorial Day

Independence Day

Labor Day

Thanksgiving Day

Christmas Day

Paid Holidays

1/2 day on Christmas Eve if work is performed in the A.M.

1/2 day on New Year's Eve if work is performed in the A.M.

Shift Rates

Monday through Friday - First Shift: First eight hours are paid at straight time, the 9th & 10th hours are paid at time and a half, double time paid thereafter. Second and third Shifts: First eight hours are paid at time and one-half, double time thereafter. Saturdays: All shifts, first eight hours paid at time and one-half, double time thereafter: Sunday all shifts are paid at double time.

Local #40 & #361)

LABORER

Foundation, Concrete, Excavating, Street Pipe Layer and Common)

OFFICE OF THE COMPTROLLER, CITY OF NEW YORK
§220 PREVAILING WAGE SCHEDULE

Laborer

Excavation and foundation work for buildings, heavy construction, engineering work, and hazardous waste removal in connection with the above work. Landscaping tasks in connection with heavy construction work, engineering work and building projects. Projects include, but are not limited to pollution plants, sewers, parks, subways, bridges, highways, etc.

Effective Period: 7/1/2014 - 6/30/2015

Wage Rate per Hour: \$39.85

Supplemental Benefit Rate per Hour: \$34.88

Overtime

Time and one half the regular rate after an 8 hour day.

Time and one half the regular rate for Saturday.

Double time the regular rate for Sunday.

Overtime Holidays

Double time the regular rate for work on the following holiday(s).

New Year's Day

Memorial Day

Independence Day

Labor Day

Columbus Day

Presidential Election Day

Thanksgiving Day

Christmas Day

Paid Holidays

Labor Day

Thanksgiving Day

Shift Rates

When two shifts are employed, single time rate shall be paid for each shift. When three shifts are found necessary, each shift shall work seven and one half hours (7 ½), but shall be paid for eight (8) hours of labor, and be permitted one half hour for lunch.

(Local #731)

LANDSCAPING

(Landscaping tasks, as well as tree pruning, tree removing, spraying and maintenance in connection with the planting of street trees and the planting of trees in city parks but not when such activities are performed as part of, or in connection with, other construction or reconstruction projects.)

Landscaper (Above 6 years experience)

OFFICE OF THE COMPTROLLER, CITY OF NEW YORK
\$220 PREVAILING WAGE SCHEDULE

Effective Period: 7/1/2014 - 6/30/2015
Wage Rate per Hour: \$25.75
Supplemental Benefit Rate per Hour: \$13.80

Landscaper (3 - 6 years experience)

Effective Period: 7/1/2014 - 6/30/2015
Wage Rate per Hour: \$24.75
Supplemental Benefit Rate per Hour: \$13.80

Landscaper (up to 3 years experience)

Effective Period: 7/1/2014 - 6/30/2015
Wage Rate per Hour: \$22.25
Supplemental Benefit Rate per Hour: \$13.80

Groundperson

Effective Period: 7/1/2014 - 6/30/2015
Wage Rate per Hour: \$22.25
Supplemental Benefit Rate per Hour: \$13.80

Tree Remover / Pruner

Effective Period: 7/1/2014 - 6/30/2015
Wage Rate per Hour: \$30.75
Supplemental Benefit Rate per Hour: \$13.80

Landscaper Sprayer (Pesticide Applicator)

Effective Period: 7/1/2014 - 6/30/2015
Wage Rate per Hour: \$20.75
Supplemental Benefit Rate per Hour: \$13.80

Watering - Plant Maintainer

Effective Period: 7/1/2014 - 6/30/2015
Wage Rate per Hour: \$15.75
Supplemental Benefit Rate per Hour: \$13.80

Overtime Description

For all overtime work performed, supplemental benefits shall include an additional seventy-five (\$0.75) cents per hour.

Overtime

Time and one half the regular rate after an 8 hour day.
Time and one half the regular rate for Saturday.
Double time the regular rate for Sunday.
Time and one half the regular rate for work on a holiday plus the day's pay.

OFFICE OF THE COMPTROLLER, CITY OF NEW YORK
§220 PREVAILING WAGE SCHEDULE

Paid Holidays

New Year's Day
Memorial Day
Independence Day
Labor Day
Thanksgiving Day
Christmas Day

Shift Rates

Work performed on a 4pm to 12am shift has a 15% differential. Work performed on a 12am to 8am shift has a 20% differential.

(Local #175)

MARBLE MECHANIC

Marble Setter

Effective Period: 7/1/2014 - 12/31/2014
Wage Rate per Hour: **\$50.85**
Supplemental Benefit Rate per Hour: **\$34.21**

Effective Period: 1/1/2015 - 6/30/2015
Wage Rate per Hour: **\$51.15**
Supplemental Benefit Rate per Hour: **\$34.87**

Marble Finisher

Effective Period: 7/1/2014 - 12/31/2014
Wage Rate per Hour: **\$39.99**
Supplemental Benefit Rate per Hour: **\$33.34**

Effective Period: 1/1/2015 - 6/30/2015
Wage Rate per Hour: **\$40.26**
Supplemental Benefit Rate per Hour: **\$33.90**

Marble Polisher

Effective Period: 7/1/2014 - 12/31/2014
Wage Rate per Hour: **\$35.96**
Supplemental Benefit Rate per Hour: **\$25.92**

Effective Period: 1/1/2015 - 6/30/2015
Wage Rate per Hour: **\$36.25**
Supplemental Benefit Rate per Hour: **\$26.28**

OFFICE OF THE COMPTROLLER, CITY OF NEW YORK
§220 PREVAILING WAGE SCHEDULE

Overtime Description

Supplemental Benefit contributions are to be made at the applicable overtime rates. Time and one half the regular rate after a 7 hour day or time and one half the regular rate after an 8 hour day - chosen by Employer at the start of the project and then would last for the full duration of the project.

Overtime

Time and one half the regular rate for Saturday.
Double time the regular rate for Sunday.

Overtime Holidays

Double time the regular rate for work on the following holiday(s).

New Year's Day
President's Day
Good Friday
Memorial Day
Independence Day
Labor Day
Columbus Day
Veteran's Day
Thanksgiving Day
Day after Thanksgiving
Christmas Day

Paid Holidays

None

(Local #7)

MASON TENDER

Mason Tender

Effective Period: 7/1/2014 - 6/30/2015

Wage Rate per Hour: \$36.05

Supplemental Benefit Rate per Hour: \$26.74

Overtime

Time and one half the regular rate after an 8 hour day.
Time and one half the regular rate for Saturday.
Double time the regular rate for Sunday.
Saturday may be used as a make-up day at straight time when a day is lost during that week to inclement weather.

Overtime Holidays

Double time the regular rate for work on the following holiday(s).

New Year's Day
President's Day

OFFICE OF THE COMPTROLLER, CITY OF NEW YORK
§220 PREVAILING WAGE SCHEDULE

Memorial Day
Independence Day
Labor Day
Thanksgiving Day
Christmas Day

Paid Holidays

None

Shift Rates

The Employer may work two (2) shifts with the first shift at the straight time wage rate and the second shift receiving eight (8) hours paid for seven (7) hours work at the straight time wage rate.

(Local #79)

MASON TENDER (INTERIOR DEMOLITION WORKER)

(The erection, building, moving, servicing and dismantling of enclosures, scaffolding, barricades, protection and site safety structures etc., on Interior Demolition jobs.)

Mason Tender Tier A

Effective Period: 7/1/2014 - 6/30/2015

Wage Rate per Hour: **\$34.99**

Supplemental Benefit Rate per Hour: **\$21.10**

Mason Tender Tier B

On Interior Demolition job sites 33 1/3 % of the employees shall be classified as Tier A Interior Demolition Workers and 66 2/3 % shall be classified as Tier B Interior Demolition Workers; provided that the employer may employ more than 33 1/3 % Tier A Interior Demolition Workers on the job site. Where the number of employees on a job site is not divisible by 3, the first additional employee (above the number of employees divisible by three) shall be a Tier B Interior Demolition Worker, and the second additional employee shall be a Tier A Interior Demolition Worker.

Effective Period: 7/1/2014 - 6/30/2015

Wage Rate per Hour: **\$24.18**

Supplemental Benefit Rate per Hour: **\$15.42**

Overtime

Time and one half the regular rate after an 8 hour day.

Time and one half the regular rate for Sunday.

Overtime Holidays

Public time the regular rate for work on the following holiday(s).

New Year's Day

OFFICE OF THE COMPTROLLER, CITY OF NEW YORK
§220 PREVAILING WAGE SCHEDULE

President's Day
Memorial Day
Independence Day
Labor Day
Thanksgiving Day
Christmas Day

Paid Holidays

None

(Local #79)

METALLIC LATHER

Metallic Lather

Effective Period: 7/1/2014 - 6/30/2015

Wage Rate per Hour: \$42.03

Supplemental Benefit Rate per Hour: \$41.07

Supplemental Note: Supplemental benefits for overtime are paid at the appropriate overtime rate.

Overtime Description

Overtime would be time and one half the regular rate after a seven (7) or eight (8) hours workday, which would be set at the start of the job.

Overtime

Time and one half the regular rate for Saturday.

Double time the regular rate for Sunday.

Overtime Holidays

Double time the regular rate for work on the following holiday(s).

New Year's Day

Washington's Birthday

Good Friday

Memorial Day

Independence Day

Labor Day

Columbus Day

Presidential Election Day

Thanksgiving Day

Christmas Day

Paid Holidays

1/2 day on Christmas Eve if work is performed in the A.M.

1/2 day on New Year's Eve if work is performed in the A.M.

Shift Rates

OFFICE OF THE COMPTROLLER, CITY OF NEW YORK
§220 PREVAILING WAGE SCHEDULE

There shall be either two (2) or three (3) shifts, each shift shall be eight (8) hours with nine (9) hours pay, including one half (½) hour for lunch. Off-Hour Start shall commence after 3:30 P.M. and shall conclude by 6:00 A.M. The first consecutive seven (7) hours shall be at straight time with a differential of twelve dollars (\$12.00) per hour. Fringes shall be paid at the straight time rate.

(Local #46)

MILLWRIGHT

Millwright

Effective Period: 7/1/2014 - 6/30/2015

Wage Rate per Hour: \$48.44

Supplemental Benefit Rate per Hour: \$50.52

Overtime

Time and one half the regular rate after an 8 hour day.

Time and one half the regular rate for Saturday.

Double time the regular rate for Sunday.

Saturday may be used as a make-up day at straight time when a day is lost during that week to inclement weather.

Overtime Holidays

Double time the regular rate for work on the following holiday(s).

New Year's Day

President's Day

Good Friday

Memorial Day

Independence Day

Labor Day

Columbus Day

Presidential Election Day

Thanksgiving Day

Christmas Day

Paid Holidays

1/2 day on Christmas Eve if work is performed in the A.M.

1/2 day on New Year's Eve if work is performed in the A.M.

Shift Rates

The first shift shall receive the straight time rate of pay. The second shift receives the straight time rate of pay plus fifteen (15%) per cent. Members of the second shift shall be allowed one half hour to eat, with this time being included in the hours of the workday established. There must be a first shift to work a second shift. All additional hours worked shall be paid at the time and one-half rate of pay plus fifteen (15%) per cent for weekday hours.

(Local #740)

OFFICE OF THE COMPTROLLER, CITY OF NEW YORK
§220 PREVAILING WAGE SCHEDULE

MOSAIC MECHANIC

Mosaic Mechanic - Mosaic & Terrazzo Mechanic

Effective Period: 7/1/2014 - 6/30/2015

Wage Rate per Hour: \$45.23

Supplemental Benefit Rate per Hour: \$36.59

Supplemental Note: Supplemental benefits for overtime to be paid at the rate of \$47.56 per hour.

Mosaic Mechanic - Mosaic & Terrazzo Finisher

Effective Period: 7/1/2014 - 6/30/2015

Wage Rate per Hour: \$43.63

Supplemental Benefit Rate per Hour: \$36.57

Supplemental Note: Supplemental benefits for overtime to be paid at the rate of \$47.54 per hour.

Mosaic Mechanic - Machine Operator Grinder

Effective Period: 7/1/2014 - 6/30/2015

Wage Rate per Hour: \$43.63

Supplemental Benefit Rate per Hour: \$36.57

Supplemental Note: Supplemental benefits for overtime to be paid at the rate of \$47.54 per hour.

Overtime

Time and one half the regular rate after a 7 hour day.

Time and one half the regular rate for Saturday.

Double time the regular rate for Sunday.

Overtime Holidays

Double time the regular rate for work on the following holiday(s).

New Year's Day

Washington's Birthday

Good Friday

Independence Day

Labor Day

Columbus Day

Veteran's Day

Thanksgiving Day

Day after Thanksgiving

Christmas Day

Paid Holidays

None

Local #7)

PAINTER

Painter - Brush & Roller

Effective Period: 7/1/2014 - 6/30/2015

Wage Rate per Hour: **\$39.50**

Supplemental Benefit Rate per Hour: **\$26.12**

Supplemental Note: \$30.75 on overtime

Spray & Scaffold / Decorative / Sandblast

Effective Period: 7/1/2014 - 6/30/2015

Wage Rate per Hour: **\$42.50**

Supplemental Benefit Rate per Hour: **\$26.12**

Supplemental Note: \$30.75 on overtime

Overtime

Time and one half the regular rate after a 7 hour day.

Time and one half the regular rate for Saturday.

Time and one half the regular rate for Sunday.

Overtime Holidays

Time and one half the regular rate for work on the following holiday(s).

New Year's Day

President's Day

Memorial Day

Independence Day

Labor Day

Columbus Day

Thanksgiving Day

Christmas Day

Paid Holidays

None

(District Council of Painters #9)

PAINTER - SIGN

Designer

Effective Period: 7/1/2014 - 6/30/2015

Wage Rate per Hour: **\$36.15**

Supplemental Benefit Rate per Hour: **\$9.66**

Journeyperson

OFFICE OF THE COMPTROLLER, CITY OF NEW YORK
§220 PREVAILING WAGE SCHEDULE

Effective Period: 7/1/2014 - 6/30/2015

Wage Rate per Hour: \$33.62

Supplemental Benefit Rate per Hour: \$9.66

Overtime

Time and one half the regular rate after an 8 hour day.

Time and one half the regular rate for Saturday.

Time and one half the regular rate for Sunday.

Double time the regular rate for work on the following holiday(s).

Paid Holidays

New Year's Day

President's Day

Memorial Day

Independence Day

Labor Day

Columbus Day

Election Day

Thanksgiving Day

Day after Thanksgiving

Christmas Day

Shift Rates

All work performed outside the regular 8 hour work day (either 7:00 A.M to 3:30 P.M or 8:00 A.M. to 4:30 P.M) shall be paid at time and one half the regular hourly rate.

(Local #8A-28A)

PAINTER - STRIPER

Striper (paint)

Effective Period: 7/1/2014 - 6/30/2015

Wage Rate per Hour: \$34.00

Supplemental Benefit Rate per Hour: \$12.60

Supplemental Note: Overtime Supplemental Benefit rate - \$8.35 New Hire Rate (0-3 months) - \$0.00

Lineperson (thermoplastic)

Effective Period: 7/1/2014 - 6/30/2015

Wage Rate per Hour: \$38.00

Supplemental Benefit Rate per Hour: \$12.60

Supplemental Note: Overtime Supplemental Benefit rate - \$8.35; New Hire Rate (0-3 months) - \$0.00

Overtime

Time and one half the regular rate after an 8 hour day.

Time and one half the regular rate for Saturday.

OFFICE OF THE COMPTROLLER, CITY OF NEW YORK
§220 PREVAILING WAGE SCHEDULE

Double time the regular rate for Sunday.
Time and one half the regular rate for work on the following holiday(s).

Paid Holidays

New Year's Day
Good Friday
Memorial Day
Independence Day
Labor Day
Columbus Day
Presidential Election Day
Thanksgiving Day
Day after Thanksgiving
Christmas Day

Shift Rates

Employees hired before April 1, 2003: 15% night shift premium differential for work commenced at 9:00 PM or later.

Vacation

Employees with one to two years service shall accrue vacation based on hours worked: 250 hours worked - 1 day vacation; 500 hours worked - 2 days vacation; 750 hours worked - 3 days vacation; 900 hours worked - 4 days vacation; 1,000 hours worked - 5 days vacation. Employees with two to five years service receive two weeks vacation. Employees with five to twenty years service receive three weeks vacation. Employees with twenty to twenty-five years service receive four weeks vacation. Employees with 25 or more years service receive five weeks vacation. Vacation must be taken during winter months. 2 Personal Days except employees hired after 4/1/12 who do not have 2 years of service.

(Local #917)

PAINTER - STRUCTURAL STEEL

Painters on Structural Steel

Effective Period: 7/1/2014 - 9/30/2014

Wage Rate per Hour: \$47.00

Supplemental Benefit Rate per Hour: \$33.58

Effective Period: 10/1/2014 - 6/30/2015

Wage Rate per Hour: \$48.75

Supplemental Benefit Rate per Hour: \$34.58

Painter - Power Tool

Effective Period: 7/1/2014 - 9/30/2014

Wage Rate per Hour: \$53.00

Supplemental Benefit Rate per Hour: \$33.58

Effective Period: 10/1/2014 - 6/30/2015

OFFICE OF THE COMPTROLLER, CITY OF NEW YORK
§220 PREVAILING WAGE SCHEDULE

Wage Rate per Hour: **\$54.75**

Supplemental Benefit Rate per Hour: **\$34.58**

Overtime Description

Supplemental Benefits shall be paid for each hour worked, up to forty (40) hours per week for the period of May 1st to November 15th or up to fifty (50) hours per week for the period of November 16th to April 30th.

Overtime

Time and one half the regular rate after a 7 hour day.

Time and one half the regular rate for Saturday.

Time and one half the regular rate for Sunday.

Overtime Holidays

Double time the regular rate for work on the following holiday(s).

New Year's Day

Memorial Day

Independence Day

Labor Day

Thanksgiving Day

Christmas Day

Paid Holidays

None

Shift Rates

Regular hourly rates plus a ten per cent (10%) differential

(Local #806)

PAPERHANGER

Paperhanger

Effective Period: 7/1/2014 - 6/30/2015

Wage Rate per Hour: **\$41.08**

Supplemental Benefit Rate per Hour: **\$29.23**

Supplemental Note: Supplemental benefits are to be paid at the appropriate straight time and overtime rate.

Overtime

Time and one half the regular rate after a 7 hour day.

Time and one half the regular rate for Saturday.

Time and one half the regular rate for Sunday.

Overtime Holidays

Time and one half the regular rate for work on the following holiday(s).

New Year's Day

President's Day

OFFICE OF THE COMPTROLLER, CITY OF NEW YORK
§220 PREVAILING WAGE SCHEDULE

Memorial Day
Independence Day
Labor Day
Thanksgiving Day
Day after Thanksgiving
Christmas Day

Paid Holidays

None

Shift Rates

Evening shift - 4:30 P.M. to 12:00 Midnight (regular rate of pay); any work performed before 7:00 A.M. shall be at time and one half the regular base rate of pay.

(District Council of Painters #9)

PAVER AND ROADBUILDER

Paver & Roadbuilder - Formsetter

Effective Period: 7/1/2014 - 6/30/2015
Wage Rate per Hour: **\$44.19**
Supplemental Benefit Rate per Hour: **\$35.15**

Paver & Roadbuilder - Laborer

Paving and road construction work, regardless of material used, including but not limited to preparation of job sites, removal of old surfaces, asphalt and/or concrete, by whatever method, including but not limited to milling; laying of concrete; laying of asphalt for temporary, patchwork, and utility paving (but not production paving); site preparation and incidental work before the installation of rubberized materials and similar surfaces; installation and repair of temporary construction fencing; slurry seal coating, maintenance of safety surfaces; play equipment installation, and other related work.

Effective Period: 7/1/2014 - 6/30/2015
Wage Rate per Hour: **\$40.32**
Supplemental Benefit Rate per Hour: **\$35.15**

Production Paver & Roadbuilder - Screed Person

(Production paving is asphalt paving when using a paving machine or on a project where a paving machine is traditionally used)

Adjustment of paving machinery on production paving jobs.

Effective Period: 7/1/2014 - 6/30/2015
Wage Rate per Hour: **\$45.24**
Supplemental Benefit Rate per Hour: **\$35.15**

OFFICE OF THE COMPTROLLER, CITY OF NEW YORK
§220 PREVAILING WAGE SCHEDULE

Production Paver & Roadbuilder - Raker

Effective Period: 7/1/2014 - 6/30/2015
Wage Rate per Hour: **\$44.73**
Supplemental Benefit Rate per Hour: **\$35.15**

Production Paver & Roadbuilder - Shoveler

General laborer (except removal of surfaces - see Paver and Roadbuilder-Laborer) including but not limited to tamper, AC paint and liquid tar work.

Effective Period: 7/1/2014 - 6/30/2015
Wage Rate per Hour: **\$41.44**
Supplemental Benefit Rate per Hour: **\$35.15**

Overtime Description

Veteran's Day is a Paid Holiday for employees working on production paving.

If an employee works New Year's Day or Christmas Day, they receive the single time rate plus 25%.

Employees who work on a holiday listed below receive the straight time rate plus one day's pay for the holiday.

Overtime

Time and one half the regular rate after an 8 hour day.
Time and one half the regular rate for Saturday.
Double time the regular rate for Sunday.

Paid Holidays

Memorial Day
Independence Day
Labor Day
Presidential Election Day
Thanksgiving Day

Shift Rates

When two shifts are employed, the work period for each shift shall be a continuous eight (8) hours. When three shifts are employed, each shift will work seven and one half (7 ½) hours but will be paid for eight (8) hours since only one half (1/2) hour is allowed for meal time.

When two or more shifts are employed, single time will be paid for each shift.

Night Work - On night work, the first eight (8) hours of work will be paid for at the single time rate, except that production paving work shall be paid at 15% over the single time rate for the screed person, rakers and shovelers directly involved only. All other workers will be exempt. Hours worked over eight (8) hours during said shift shall be paid for at the time and one-half rate.

Local #1010)

OFFICE OF THE COMPTROLLER, CITY OF NEW YORK
§220 PREVAILING WAGE SCHEDULE

PLASTERER

Plasterer

Effective Period: 7/1/2014 - 6/30/2015

Wage Rate per Hour: **\$42.43**

Supplemental Benefit Rate per Hour: **\$27.95**

Overtime

Time and one half the regular rate after a 7 hour day.

Time and one half the regular rate for Saturday.

Double time the regular rate for Sunday.

Saturday may be used as a make-up day at straight time when a day is lost during that week to inclement weather.

Overtime Holidays

Double time the regular rate for work on the following holiday(s).

New Year's Day

Martin Luther King Jr. Day

President's Day

Good Friday

Memorial Day

Independence Day

Labor Day

Columbus Day

Presidential Election Day

Thanksgiving Day

Christmas Day

Paid Holidays

None

Shift Rates

When it is not possible to conduct alteration work during regular work hours, in a building occupied by tenants, said work shall proceed on a shift basis: however work over seven (7) hours in any twenty four (24) hour period, the time after seven (7) hours shall be considered overtime.

The second shift shall start at a time between 3:30 p.m. and 7:00 p.m. and shall consist of seven (7) working hours and shall receive eight (8) hours of wages and benefits at the straight time rate. The workers on the second shift shall be allowed one-half (½) hour to eat with this time being included in the seven (7) hours of work.

(Local #530)

PLASTERER - TENDER

Plasterer - Tender

Effective Period: 7/1/2014 - 6/30/2015

OFFICE OF THE COMPTROLLER, CITY OF NEW YORK
§220 PREVAILING WAGE SCHEDULE

Wage Rate per Hour: **\$35.53**

Supplemental Benefit Rate per Hour: **\$26.31**

Overtime

Time and one half the regular rate after an 8 hour day.

Time and one half the regular rate for Saturday.

Double time the regular rate for Sunday.

Saturday may be used as a make-up day at straight time when a day is lost during that week to inclement weather.

Overtime Holidays

Double time the regular rate for work on the following holiday(s).

New Year's Day

Washington's Birthday

Memorial Day

Independence Day

Labor Day

Presidential Election Day

Thanksgiving Day

Christmas Day

Paid Holidays

None

Shift Rates

When work commences outside regular work hours, workers receive an hour additional (differential) wage and supplement payment. Eight hours pay for seven hours work or nine hours pay for eight hours work.

(Mason Tenders District Council)

PLUMBER

Plumber

Effective Period: 7/1/2014 - 6/30/2015

Wage Rate per Hour: **\$65.27**

Supplemental Benefit Rate per Hour: **\$25.78**

Supplemental Note: Overtime supplemental benefit rate per hour: **\$40.78**

Plumber - Temporary Services

Temporary Services - When there are no Plumbers on the job site, there may be three shifts designed to cover the entire twenty-four hour period, including weekends if necessary, at the following rate straight time.

Effective Period: 7/1/2014 - 6/30/2015

Wage Rate per Hour: **\$52.24**

Supplemental Benefit Rate per Hour: **\$20.20**

OFFICE OF THE COMPTROLLER, CITY OF NEW YORK
§220 PREVAILING WAGE SCHEDULE

Overtime Description

Double time the regular rate after a 7 hour day - unless for new construction site work where the plumbing contract price is \$1.5 million or less, the hours of labor can be 8 hours per day at the employers option. On Alteration jobs when other mechanical trades at the site are working an eighth hour at straight time, then the plumber shall also work an eighth hour at straight time.

Overtime

Double time the regular time rate for Saturday.
Double time the regular rate for Sunday.

Overtime Holidays

Double time the regular rate for work on the following holiday(s).

New Year's Day
President's Day
Memorial Day
Independence Day
Labor Day
Columbus Day
Veteran's Day
Thanksgiving Day
Day after Thanksgiving
Christmas Day

Shift Rates

Shift work, when directly specified in public agency or authority documents where plumbing contract is \$8 million or less, will be permitted. 30% shift premium shall be paid for wages and fringe benefits for 4:00 pm and midnight shifts Monday to Friday. 50% shift premium shall be paid for wages and fringe benefits for 4:00 pm and midnight shift work performed on weekends. For shift work on holidays, double time wages and fringe benefits shall be paid.

(Plumbers Local #1)

PLUMBER (MECHNICAL EQUIPMENT AND SERVICE)

(Mechanical Equipment and Service work shall include any repair and/or replacement of the present plumbing system.)

Plumber

Effective Period: 7/1/2014 - 6/30/2015

Wage Rate per Hour: \$38.27

Supplemental Benefit Rate per Hour: \$12.84

Overtime

Time and one half the regular rate after an 8 hour day.

Time and one half the regular rate for Saturday.

Time and one half the regular rate for Sunday.

OFFICE OF THE COMPTROLLER, CITY OF NEW YORK
§220 PREVAILING WAGE SCHEDULE

Overtime Holidays

Time and one half the regular rate for work on the following holiday(s).

New Year's Day
President's Day
Memorial Day
Independence Day
Thanksgiving Day
Day after Thanksgiving
Christmas Day

Paid Holidays

None

(Plumbers Local # 1)

PLUMBER (RESIDENTIAL RATES FOR 1, 2 AND 3 FAMILY HOME CONSTRUCTION)

Effective Period: 7/1/2014 - 6/30/2015

Wage Rate per Hour: \$45.19

Supplemental Benefit Rate per Hour: \$18.79

Overtime

Double time the regular rate after an 8 hour day.
Double time the regular time rate for Saturday.
Double time the regular rate for Sunday.

Overtime Holidays

Double time the regular rate for work on the following holiday(s).

New Year's Day
President's Day
Memorial Day
Independence Day
Labor Day
Columbus Day
Veteran's Day
Thanksgiving Day
Day after Thanksgiving
Christmas Day

Paid Holidays

None

Shift Rates

30% shift premium shall be paid for wages and fringe benefits for 4:00 pm and midnight shifts Monday to Friday.
50% shift premium shall be paid for wages and fringe benefits for 4:00 pm and midnight shift work performed on weekends. For shift work on holidays, double time wages and fringe benefits shall be paid.

OFFICE OF THE COMPTROLLER, CITY OF NEW YORK
\$220 PREVAILING WAGE SCHEDULE

(Plumbers Local #1)

PLUMBER: PUMP & TANK
Oil Trades (Installation and Maintenance)

Plumber - Pump & Tank

Effective Period: 7/1/2014 - 6/30/2015

Wage Rate per Hour: \$62.83

Supplemental Benefit Rate per Hour: \$21.37

Overtime

Time and one half the regular rate after an 8 hour day.

Time and one half the regular rate for Saturday.

Time and one half the regular rate for Sunday.

Overtime Holidays

Time and one half the regular rate for work on the following holiday(s).

New Year's Day

President's Day

Memorial Day

Independence Day

Labor Day

Columbus Day

Veteran's Day

Thanksgiving Day

Day after Thanksgiving

Christmas Day

Paid Holidays

None

Shift Rates

All work outside the regular workday (8:00 A.M. to 3:30 P.M.) is to be paid at time and one half the regular hourly rate

(Plumbers Local #1)

POINTER - WATERPROOFER, CAULKER MECHANIC (EXTERIOR BUILDING RENOVATION)

Pointer - Waterproofer, Caulker Mechanic

OFFICE OF THE COMPTROLLER, CITY OF NEW YORK
§220 PREVAILING WAGE SCHEDULE

Effective Period: 7/1/2014 - 6/30/2015

Wage Rate per Hour: \$47.41

Supplemental Benefit Rate per Hour: \$24.40

Overtime

Time and one half the regular rate after an 8 hour day.

Time and one half the regular rate for Saturday.

Time and one half the regular rate for Sunday.

Saturday may be used as a make-up day at straight time when a day is lost during that week to inclement weather.

Overtime Holidays

Time and one half the regular rate for work on the following holiday(s).

New Year's Day

Martin Luther King Jr. Day

President's Day

Memorial Day

Independence Day

Labor Day

Thanksgiving Day

Christmas Day

Paid Holidays

None

Shift Rates

All work outside the regular work day (an eight hour workday between the hours of 6:00 A.M. and 4:30 P.M.) is to be paid at time and one half the regular rate.

(Bricklayer District Council)

ROOFER

Roofer

Effective Period: 7/1/2014 - 6/30/2015

Wage Rate per Hour: \$40.70

Supplemental Benefit Rate per Hour: \$28.67

Overtime

Time and one half the regular rate after an 8 hour day.

Time and one half the regular rate for Saturday.

Time and one half the regular rate for Sunday.

Overtime Holidays

Time and one half the regular rate for work on the following holiday(s).

New Year's Day

OFFICE OF THE COMPTROLLER, CITY OF NEW YORK
§220 PREVAILING WAGE SCHEDULE

President's Day
Memorial Day
Independence Day
Labor Day
Presidential Election Day
Thanksgiving Day
Christmas Day

Paid Holidays

None

Shift Rates

Second shift - Regular hourly rate plus a 10% differential. Third shift - Regular hourly rate plus a 15% differential.

(Local #8)

**SANDBLASTER - STEAMBLASTER
(Exterior Building Renovation)**

Sandblaster / Steamblaster

Effective Period: 7/1/2014 - 6/30/2015
Wage Rate per Hour: **\$47.41**
Supplemental Benefit Rate per Hour: **\$24.40**

Overtime

Time and one half the regular rate after an 8 hour day.
Time and one half the regular rate for Saturday.
Time and one half the regular rate for Sunday.
Saturday may be used as a make-up day at straight time when a day is lost during that week to inclement weather.

Overtime Holidays

Time and one half the regular rate for work on the following holiday(s).
New Year's Day
Martin Luther King Jr. Day
President's Day
Memorial Day
Independence Day
Labor Day
Thanksgiving Day
Christmas Day

Paid Holidays

None

Shift Rates

OFFICE OF THE COMPTROLLER, CITY OF NEW YORK
§220 PREVAILING WAGE SCHEDULE

All work outside the regular work day (an eight hour workday between the hours of 6:00 A.M. and 4:30 P.M.) is to be paid at time and one half the regular rate.

(Bricklayer District Council)

SHEET METAL WORKER

Sheet Metal Worker

Effective Period: 7/1/2014 - 6/30/2015

Wage Rate per Hour: **\$46.21**

Supplemental Benefit Rate per Hour: **\$43.89**

Supplemental Note: Supplemental benefit contributions are to be made at the applicable overtime rates.

Sheet Metal Worker - Fan Maintenance

(The temporary operation of fans or blowers in new or existing buildings for heating and/or ventilation, and/or air conditioning prior to the completion of the project.)

Effective Period: 7/1/2014 - 6/30/2015

Wage Rate per Hour: **\$36.97**

Supplemental Benefit Rate per Hour: **\$43.89**

Sheet Metal Worker - Duct Cleaner

Effective Period: 7/1/2014 - 6/30/2015

Wage Rate per Hour: **\$12.90**

Supplemental Benefit Rate per Hour: **\$8.07**

Overtime

Time and one half the regular rate after a 7 hour day.

Time and one half the regular rate for Saturday.

Double time the regular rate for Sunday.

Overtime Holidays

Double time the regular rate for work on the following holiday(s).

New Year's Day

Martin Luther King Jr. Day

President's Day

Memorial Day

Independence Day

Labor Day

Columbus Day

Veteran's Day

Thanksgiving Day

Day after Thanksgiving

Christmas Day

OFFICE OF THE COMPTROLLER, CITY OF NEW YORK
§220 PREVAILING WAGE SCHEDULE

Paid Holidays

None

Shift Rates

Work that can only be performed outside regular working hours (seven hours of work between 7:30 A.M. and 3:30 P.M.) - First shift (work between 3:30 P.M. and 11:30 P.M.) - 10% differential above the established hourly rate. Second shift (work between 11:30 P.M. and 7:30 A.M.) - 15% differential above the established hourly rate.

For Fan Maintenance: On all full shifts of fan maintenance work the straight time hourly rate of pay will be paid for each shift, including nights, Saturdays, Sundays, and holidays. No journey person engaged in fan maintenance shall work in excess of forty (40) hours in any work week.

(Local #28)

**SHEET METAL WORKER - SPECIALTY
(Decking & Siding)**

Sheet Metal Specialty Worker

The first worker to perform this work must be paid at the rate of the Sheet Metal Worker. The second and third workers shall be paid the Specialty Worker Rate. The ratio of One Sheet Metal Worker, then Two Specialty Workers shall be utilized thereafter.

Effective Period: 7/1/2014 - 6/30/2015

Wage Rate per Hour: **\$40.78**

Supplemental Benefit Rate per Hour: **\$23.38**

Supplemental Note: Supplemental benefit contributions are to be made at the applicable overtime rates.

Overtime

Time and one half the regular rate after an 8 hour day.

Time and one half the regular rate for Saturday.

Double time the regular rate for Sunday.

Overtime Holidays

Double time the regular rate for work on the following holiday(s).

New Year's Day

Martin Luther King Jr. Day

President's Day

Memorial Day

Independence Day

Labor Day

Columbus Day

Veteran's Day

Thanksgiving Day

Christmas Day

Paid Holidays

OFFICE OF THE COMPTROLLER, CITY OF NEW YORK
\$220 PREVAILING WAGE SCHEDULE

None

(Local #28)

SHIPYARD WORKER

Shipyard Mechanic - First Class

Effective Period: 7/1/2014 - 6/30/2015

Wage Rate per Hour: \$23.83

Supplemental Benefit Rate per Hour: \$2.87

Shipyard Mechanic - Second Class

Effective Period: 7/1/2014 - 6/30/2015

Wage Rate per Hour: \$15.44

Supplemental Benefit Rate per Hour: \$2.54

Shipyard Laborer - First Class

Effective Period: 7/1/2014 - 6/30/2015

Wage Rate per Hour: \$19.28

Supplemental Benefit Rate per Hour: \$2.69

Shipyard Laborer - Second Class

Effective Period: 7/1/2014 - 6/30/2015

Wage Rate per Hour: \$12.36

Supplemental Benefit Rate per Hour: \$2.43

Shipyard Dockhand - First Class

Effective Period: 7/1/2014 - 6/30/2015

Wage Rate per Hour: \$22.68

Supplemental Benefit Rate per Hour: \$2.82

Shipyard Dockhand - Second Class

Effective Period: 7/1/2014 - 6/30/2015

Wage Rate per Hour: \$14.22

Supplemental Benefit Rate per Hour: \$2.50

Overtime Description

Work performed on holiday is paid double time the regular hourly wage rate plus holiday pay.

OFFICE OF THE COMPTROLLER, CITY OF NEW YORK
§220 PREVAILING WAGE SCHEDULE

Overtime

Time and one half the regular rate after an 8 hour day.
Time and one half the regular rate for Saturday.
Double time the regular rate for Sunday.
Time and one half the regular hourly rate after 40 hours in any work week.

Paid Holidays

New Year's Day
Martin Luther King Jr. Day
President's Day
Good Friday
Memorial Day
Independence Day
Labor Day
Thanksgiving Day
Day after Thanksgiving
Christmas Day

Based on Survey Data

SIGN ERECTOR
(Sheet Metal, Plastic, Electric, and Neon)

Sign Erector

Effective Period: 7/1/2014 - 6/30/2015
Wage Rate per Hour: \$44.20
Supplemental Benefit Rate per Hour: \$44.10

Overtime

Time and one half the regular rate after a 7 hour day.
Time and one half the regular rate for Saturday.
Time and one half the regular rate for Sunday.
Time and one half the regular rate for work on the following holiday(s).

Paid Holidays

New Year's Day
Washington's Birthday
Memorial Day
Independence Day
Labor Day
Columbus Day
Election Day
Thanksgiving Day
Day after Thanksgiving
Christmas Day

OFFICE OF THE COMPTROLLER, CITY OF NEW YORK
\$220 PREVAILING WAGE SCHEDULE

Shift Rates

Time and one half the regular hourly rate is to be paid for all hours worked outside the regular workday either (7:00 A.M. through 2:30 P.M.) or (8:00 A.M. through 3:30 P.M.)

(Local #137)

STEAMFITTER

Steamfitter I

Effective Period: 7/1/2014 - 6/30/2015

Wage Rate per Hour: \$53.25

Supplemental Benefit Rate per Hour: \$51.04

Supplemental Note: Overtime supplemental benefit rate: \$101.34

Overtime

Double time the regular rate after a 7 hour day.

Double time the regular time rate for Saturday.

Double time the regular rate for Sunday.

Overtime Holidays

Double time the regular rate for work on the following holiday(s).

New Year's Day

President's Day

Memorial Day

Independence Day

Labor Day

Columbus Day

Veteran's Day

Thanksgiving Day

Day after Thanksgiving

Christmas Day

Paid Holidays

None

Shift Rates

Work performed between 3:30 P.M. and 7:00 A.M. and on Saturdays, Sundays and Holidays shall be at double time the regular hourly rate and paid at the overtime supplemental benefit rate above.

Steamfitter II

For heating, ventilation, air conditioning and mechanical public works contracts with a dollar value not to exceed \$15,000,000 and for fire protection/sprinkler public works contracts not to exceed \$1,500,000.

OFFICE OF THE COMPTROLLER, CITY OF NEW YORK
§220 PREVAILING WAGE SCHEDULE

Effective Period: 7/1/2014 - 6/30/2015

Wage Rate per Hour: \$53.25

Supplemental Benefit Rate per Hour: \$51.04

Supplemental Note: Overtime supplemental benefit rate: \$101.34

Overtime

Double time the regular rate after an 8 hour day.

Double time the regular time rate for Saturday.

Double time the regular rate for Sunday.

Overtime Holidays

Double time the regular rate for work on the following holiday(s).

New Year's Day

President's Day

Memorial Day

Independence Day

Labor Day

Columbus Day

Veteran's Day

Thanksgiving Day

Day after Thanksgiving

Christmas Day

Paid Holidays

None

Shift Rates

May be performed outside of the regular workday except Saturday, Sunday and Holidays. A shift shall consist of eight working hours. All work performed in excess of eight hours shall be paid at double time. No shift shall commence after 7:00 P.M. on Friday or 7:00 P.M. the day before holidays. All work performed after 12:01 A.M. Saturday or 12:01 A.M. the day before a Holiday will be paid at double time. When shift work is performed the wage rate for regular time worked is a thirty percent premium together with fringe benefits.

On Transit Authority projects, where work is performed in the vicinity of tracks all shift work on weekends and holidays may be performed at the regular shift rates.

Local #638

STEAMFITTER - REFRIGERATION AND AIR CONDITIONER (Maintenance and Installation Service Person)

Refrigeration and Air Conditioner Mechanic

Effective Period: 7/1/2014 - 6/30/2015

Wage Rate per Hour: \$38.30

Supplemental Benefit Rate per Hour: \$12.76

OFFICE OF THE COMPTROLLER, CITY OF NEW YORK
§220 PREVAILING WAGE SCHEDULE

Refrigeration and Air Conditioner Service Person V

Effective Period: 7/1/2014 - 6/30/2015

Wage Rate per Hour: \$31.47

Supplemental Benefit Rate per Hour: \$11.55

Refrigeration and Air Conditioner Service Person IV

Effective Period: 7/1/2014 - 6/30/2015

Wage Rate per Hour: \$26.07

Supplemental Benefit Rate per Hour: \$10.52

Refrigeration and Air Conditioner Service Person III

Filter changing and maintenance thereof, oil and greasing, tower and coil cleaning, scraping and painting, general housekeeping, taking of water samples.

Effective Period: 7/1/2014 - 6/30/2015

Wage Rate per Hour: \$22.38

Supplemental Benefit Rate per Hour: \$9.76

Refrigeration and Air Conditioner Service Person II

Filter changing and maintenance thereof, oil and greasing, tower and coil cleaning, scraping and painting, general housekeeping, taking of water samples.

Effective Period: 7/1/2014 - 6/30/2015

Wage Rate per Hour: \$18.56

Supplemental Benefit Rate per Hour: \$9.06

Refrigeration and Air Conditioner Service Person I

Filter changing and maintenance thereof, oil and greasing, tower and coil cleaning, scraping and painting, general housekeeping, taking of water samples.

Effective Period: 7/1/2014 - 6/30/2015

Wage Rate per Hour: \$13.57

Supplemental Benefit Rate per Hour: \$8.30

Overtime

Time and one half the regular rate after an 8 hour day.

Time and one half the regular rate for Saturday.

Double time the regular rate for Sunday.

Overtime Holidays

Double time the regular rate for work on the following holiday(s).

New Year's Day

Independence Day

Labor Day

Veteran's Day

OFFICE OF THE COMPTROLLER, CITY OF NEW YORK
§220 PREVAILING WAGE SCHEDULE

Thanksgiving Day
Christmas Day

Double time and one half the regular rate for work on the following holiday(s).

Martin Luther King Jr. Day
President's Day
Memorial Day
Columbus Day

Paid Holidays

New Year's Day
Martin Luther King Jr. Day
President's Day
Memorial Day
Independence Day
Labor Day
Columbus Day
Veteran's Day
Thanksgiving Day
Christmas Day

(Local #638B)

STONE MASON - SETTER

Stone Mason - Setters

Effective Period: 7/1/2014 - 6/30/2015

Wage Rate per Hour: **\$46.56**

Supplemental Benefit Rate per Hour: **\$36.40**

Overtime

Time and one half the regular rate after a 7 hour day.

Time and one half the regular rate for Saturday.

Double time the regular rate for Sunday.

Overtime Holidays

Double time the regular rate for work on the following holiday(s).

New Year's Day
Washington's Birthday
Good Friday
Memorial Day
Independence Day
Labor Day
Thanksgiving Day
Christmas Day

Paid Holidays

day on Christmas Eve if work is performed in the A.M.

OFFICE OF THE COMPTROLLER, CITY OF NEW YORK
§220 PREVAILING WAGE SCHEDULE

Shift Rates

For all work outside the regular workday (8:00 A.M. to 3:30 P.M. Monday through Friday), the pay shall be straight time plus a ten percent (10%) differential.

(Bricklayers District Council)

TAPER

Drywall Taper

Effective Period: 7/1/2014 - 12/30/2014

Wage Rate per Hour: **\$45.32**

Supplemental Benefit Rate per Hour: **\$22.66**

Effective Period: 12/31/2014 - 6/30/2015

Wage Rate per Hour: **\$45.82**

Supplemental Benefit Rate per Hour: **\$22.66**

Overtime

Time and one half the regular rate after a 7 hour day.

Time and one half the regular rate for Saturday.

Time and one half the regular rate for Sunday.

Overtime Holidays

Time and one half the regular rate for work on the following holiday(s).

New Year's Day

Martin Luther King Jr. Day

President's Day

Good Friday

Memorial Day

Independence Day

Labor Day

Columbus Day

Thanksgiving Day

Christmas Day

Paid Holidays

Any worker who reports to work on Christmas Eve or New Year's Eve pursuant to his employer's instruction shall be entitled to three (3) hours afternoon pay without working.

Shift Rates

Time and one half the regular rate outside the regular work hours (8:00 A.M. through 3:30 P.M.)

(Local #1974)

**TELECOMMUNICATION WORKER
(Voice Installation Only)**

Telecommunication Worker

Effective Period: 7/1/2014 - 6/30/2015

Wage Rate per Hour: \$39.18

Supplemental Benefit Rate per Hour: \$13.19

Supplemental Note: The above rate applies for Manhattan, Bronx, Brooklyn, Queens. \$12.64 for Staten Island only.

Overtime

Time and one half the regular rate after a 7 hour day.

Time and one half the regular rate for Saturday.

Time and one half the regular rate for Sunday.

Overtime Holidays

Time and one half the regular rate for work on the following holiday(s).

New Year's Day

Lincoln's Birthday

Washington's Birthday

Memorial Day

Independence Day

Labor Day

Columbus Day

Election Day

Veteran's Day

Thanksgiving Day

Christmas Day

Paid Holidays

New Year's Day

Lincoln's Birthday

Washington's Birthday

Memorial Day

Independence Day

Labor Day

Columbus Day

Election Day

Veteran's Day

Thanksgiving Day

Christmas Day

Employees have the option of observing either Martin Luther King's Birthday or the day after Thanksgiving instead of Lincoln's Birthday

Shift Rates

For any workday that starts before 8A.M. or ends after 6P.M. there is a 10% differential for the applicable worker's hourly rate.

OFFICE OF THE COMPTROLLER, CITY OF NEW YORK
§220 PREVAILING WAGE SCHEDULE

Vacation

After 6 months.....one week.
After 12 months but less than 7 years.....two weeks.
After 7 or more but less than 15 years.....three weeks.
After 15 years or more but less than 25 years.....four weeks.

(C.W.A.)

TILE FINISHER

Tile Finisher

Effective Period: 7/1/2014 - 6/30/2015

Wage Rate per Hour: \$38.80

Supplemental Benefit Rate per Hour: \$28.03

Overtime

Time and one half the regular rate after a 7 hour day.
Time and one half the regular rate for Saturday.
Double time the regular rate for Sunday.

Overtime Holidays

Double time the regular rate for work on the following holiday(s).

New Year's Day
President's Day
Good Friday
Memorial Day
Independence Day
Labor Day
Columbus Day
Veteran's Day
Thanksgiving Day
Day after Thanksgiving
Christmas Day

Paid Holidays

None

Shift Rates

Off shift work day (work performed outside the regular 8:00 A.M. to 3:30 P.M. workday): shift differential of one and one quarter (1¼) times the regular straight time rate of pay for the seven hours of actual off-shift work.

Local #7)

TILE LAYER - SETTER

OFFICE OF THE COMPTROLLER, CITY OF NEW YORK
§220 PREVAILING WAGE SCHEDULE

Tile Layer - Setter

Effective Period: 7/1/2014 - 6/30/2015

Wage Rate per Hour: \$49.88

Supplemental Benefit Rate per Hour: \$32.36

Overtime

Time and one half the regular rate after a 7 hour day.

Time and one half the regular rate for Saturday.

Double time the regular rate for Sunday.

Overtime Holidays

Double time the regular rate for work on the following holiday(s).

New Year's Day

President's Day

Good Friday

Memorial Day

Independence Day

Labor Day

Columbus Day

Veteran's Day

Thanksgiving Day

Day after Thanksgiving

Christmas Day

Shift Rates

Off shift work day (work performed outside the regular 8:00 A.M. to 3:30 P.M. workday): shift differential of one and one quarter (1¼) times the regular straight time rate of pay for the seven hours of actual off-shift work.

(Local #7)

TIMBERPERSON

Timberperson

Effective Period: 7/1/2014 - 6/30/2015

Wage Rate per Hour: \$44.33

Supplemental Benefit Rate per Hour: \$45.39

Overtime

Time and one half the regular rate after an 8 hour day.

Time and one half the regular rate for Saturday.

Double time the regular rate for Sunday.

Saturday may be used as a make-up day at straight time when a day is lost during that week to inclement weather.

Time and one half the regular hourly rate after 40 hours in any work week.

Overtime Holidays

OFFICE OF THE COMPTROLLER, CITY OF NEW YORK
§220 PREVAILING WAGE SCHEDULE

Double time the regular rate for work on the following holiday(s).

New Year's Day
President's Day
Memorial Day
Independence Day
Labor Day
Columbus Day
Presidential Election Day
Thanksgiving Day
Christmas Day

Paid Holidays

None

Shift Rates

Off shift work commencing between 5:00 P.M. and 11:00 P.M. shall work eight and one half hours allowing for one half hour for lunch. The wage rate shall be 113% of the straight time hourly wage rate.

(Local #1536)

TUNNEL WORKER

Blasters, Mucking Machine Operators (Compressed Air Rates)

Effective Period: 7/1/2014 - 6/30/2015

Wage Rate per Hour: \$54.20

Supplemental Benefit Rate per Hour: \$48.20

Tunnel Workers (Compressed Air Rates)

Effective Period: 7/1/2014 - 6/30/2015

Wage Rate per Hour: \$52.31

Supplemental Benefit Rate per Hour: \$46.59

Top Nipper (Compressed Air Rates)

Effective Period: 7/1/2014 - 6/30/2015

Wage Rate per Hour: \$51.35

Supplemental Benefit Rate per Hour: \$45.78

Outside Lock Tender, Outside Gauge Tender, Muck Lock Tender (Compressed Air Rates)

Effective Period: 7/1/2014 - 6/30/2015

Wage Rate per Hour: \$50.42

Supplemental Benefit Rate per Hour: \$44.91

OFFICE OF THE COMPTROLLER, CITY OF NEW YORK
§220 PREVAILING WAGE SCHEDULE

Bottom Bell & Top Bell Signal Person: Shaft Person (Compressed Air Rates)

Effective Period: 7/1/2014 - 6/30/2015
Wage Rate per Hour: \$50.42
Supplemental Benefit Rate per Hour: \$44.92

Changehouse Attendant: Powder Watchperson (Compressed Air Rates)

Effective Period: 7/1/2014 - 6/30/2015
Wage Rate per Hour: \$43.94
Supplemental Benefit Rate per Hour: \$42.55

Blasters (Free Air Rates)

Effective Period: 7/1/2014 - 6/30/2015
Wage Rate per Hour: \$51.72
Supplemental Benefit Rate per Hour: \$46.03

Tunnel Workers (Free Air Rates)

Effective Period: 7/1/2014 - 6/30/2015
Wage Rate per Hour: \$49.48
Supplemental Benefit Rate per Hour: \$44.06

All Others (Free Air Rates)

Effective Period: 7/1/2014 - 6/30/2015
Wage Rate per Hour: \$45.73
Supplemental Benefit Rate per Hour: \$40.75

Microtunneling (Free Air Rates)

Effective Period: 7/1/2014 - 6/30/2015
Wage Rate per Hour: \$39.58
Supplemental Benefit Rate per Hour: \$35.25

Overtime Description

For Repair-Maintenance Work on Existing Equipment and Facilities - Time and one half the regular rate after a 7 hour day, or for Saturday, or for Sunday. Double time the regular rate for work on a holiday.
For Small-Bore Micro Tunneling Machines - Time and one-half the regular rate shall be paid for all overtime.

Overtime

Double time the regular rate after an 8 hour day.
Double time the regular time rate for Saturday.
Double time the regular rate for Sunday.
Double time the regular rate for work on the following holiday(s).

Paid Holidays
New Year's Day

**OFFICE OF THE COMPTROLLER, CITY OF NEW YORK
§220 PREVAILING WAGE SCHEDULE**

**Lincoln's Birthday
President's Day
Memorial Day
Independence Day
Labor Day
Columbus Day
Election Day
Veteran's Day
Thanksgiving Day
Christmas Day**

(Local #147)

**WELDER
TO BE PAID AT THE RATE OF THE JOURNEYPERSON IN THE TRADE
PERFORMING THE WORK.**

OFFICE OF THE COMPTROLLER

CITY OF NEW YORK

220 APPRENTICESHIP PREVAILING WAGE SCHEDULE

APPENDIX

Pursuant to Labor Law §220 (3-e), only apprentices who are individually registered in a bona fide program to which the employer contractor is a participant and registered with the New York State Department of Labor, may be employed on a public work project.

Any employee listed on a payroll at an apprentice wage rate, who is not registered as above, shall be paid the journey person wage rate for the classification of work he actually performed.

Apprentice ratios are established to ensure the proper safety, training and supervision of apprentices. A ratio establishes the number of journey workers required for each apprentice in a program and on a job site. Ratios are interpreted as follows: in the case of a 1:1, 1:4 ratio, there must be one journey worker for the first apprentice, and four additional journey workers for each subsequent apprentice.

TABLE OF CONTENTS

<u>CLASSIFICATION</u>	<u>PAGE</u>
ASBESTOS HANDLER.....	3
BOILERMAKER	3
BRICKLAYER	4
CARPENTER	5
CEMENT MASON	6
CEMENT AND CONCRETE WORKER.....	6
DERRICKPERSON & RIGGER (STONE).....	7
DOCKBUILDER/PILE DRIVER.....	8
ELECTRICIAN.....	8
ELEVATOR CONSTRUCTOR	11
ELEVATOR REPAIR & MAINTENANCE.....	12
ENGINEER.....	13
ENGINEER - OPERATING.....	14
FLOOR COVERER.....	14
GLAZIER.....	15
HEAT & FROST INSULATOR	16
HOUSE WRECKER.....	17
IRON WORKER - ORNAMENTAL	17
IRON WORKER - STRUCTURAL.....	18
LABORER (FOUNDATION, CONCRETE, EXCAVATING, STREET PIPE LAYER & COMMON)....	19
MARBLE MECHANICS.....	19
MASON TENDER.....	21
METALLIC LATHER	21
MILLWRIGHT	22
PAVER AND ROADBUILDER	23
PAINTER.....	24
PAINTER - STRUCTURAL STEEL.....	24
PLASTERER.....	25
PLUMBER.....	26
POINTER - WATERPROOFER, CAULKER MECHANIC (EXTERIOR BUILDING RENOVATION) .	27
ROOFER	27
SHEET METAL WORKER	28
SIGN ERECTOR	29
STEAMFITTER.....	31
STONE MASON - SETTER.....	31
TAPER.....	32
TILE LAYER - SETTER.....	33
TIMBERPERSON.....	33

ASBESTOS HANDLER

(Ratio of Apprentice Journeyperson: 1 to 1, 1 to 3)

Asbestos Handler (First 1000 Hours)

Effective Period: 7/1/2014 - 6/30/2015
Wage Rate Per Hour: 78% of Journeyperson's rate
Supplemental Benefit Rate Per Hour: \$15.45

Asbestos Handler (Second 1000 Hours)

Effective Period: 7/1/2014 - 6/30/2015
Wage Rate Per Hour: 80% of Journeyperson's rate
Supplemental Benefit Rate Per Hour: \$15.45

Asbestos Handler (Third 1000 Hours)

Effective Period: 7/1/2014 - 6/30/2015
Wage Rate Per Hour: 83% of Journeyperson's rate
Supplemental Benefit Rate Per Hour: \$15.45

Asbestos Handler (Fourth 1000 Hours)

Effective Period: 7/1/2014 - 6/30/2015
Wage Rate Per Hour: 89% of Journeyperson's rate
Supplemental Benefit Rate Per Hour: \$15.45

(Local #78)

BOILERMAKER

(Ratio of Apprentice to Journeyperson: 1 to 1, 1 to 3)

Boilermaker (First Year)

Effective Period: 7/1/2014 - 6/30/2015
Wage Rate Per Hour: 65% of Journeyperson's rate
Supplemental Benefit Rate Per Hour: \$29.74

Boilermaker (Second Year: 1st Six Months)

Effective Period: 7/1/2014 - 6/30/2015
Wage Rate Per Hour: 75% of Journeyperson's rate
Supplemental Benefit Rate Per Hour: \$31.40

OFFICE OF THE COMPTROLLER, CITY OF NEW YORK
\$220 APPRENTICESHIP PREVAILING WAGE SCHEDULE

Boilermaker (Second Year: 2nd Six Months)

Effective Period: 7/1/2014 - 6/30/2015
Wage Rate Per Hour: 75% of Journeyman's rate
Supplemental Benefit Rate Per Hour: \$33.05

Boilermaker (Third Year: 1st Six Months)

Effective Period: 7/1/2014 - 6/30/2015
Wage Rate Per Hour: 80% of Journeyman's rate
Supplemental Benefit Rate Per Hour: \$34.69

Boilermaker (Third Year: 2nd Six Months)

Effective Period: 7/1/2014 - 6/30/2015
Wage Rate Per Hour: 85% of Journeyman's rate
Supplemental Benefit Rate Per Hour: \$36.34

Boilermaker (Fourth Year: 1st Six Months)

Effective Period: 7/1/2014 - 6/30/2015
Wage Rate Per Hour: 90% of Journeyman's rate
Supplemental Benefit Rate Per Hour: \$38.00

Boilermaker (Fourth Year: 2nd Six Months)

Effective Period: 7/1/2014 - 6/30/2015
Wage Rate Per Hour: 95% of Journeyman's rate
Supplemental Benefit Rate Per Hour: \$39.65

(Local #5)

BRICKLAYER

(Ratio of Apprentice to Journeyman: 1 to 1, 1 to 4)

Bricklayer (First 750 Hours)

Effective Period: 7/1/2014 - 6/30/2015
Wage Rate Per Hour: 50% of Journeyman's rate
Supplemental Benefit Rate Per Hour: \$17.10

Bricklayer (Second 750 Hours)

Effective Period: 7/1/2014 - 6/30/2015
Wage Rate Per Hour: 60% of Journeyman's rate

OFFICE OF THE COMPTROLLER, CITY OF NEW YORK
\$220 APPRENTICESHIP PREVAILING WAGE SCHEDULE

Supplemental Benefit Rate Per Hour: \$17.10

Bricklayer (Third 750 Hours)

Effective Period: 7/1/2014 - 6/30/2015
Wage Rate Per Hour: 70% of Journeyperson's rate
Supplemental Benefit Rate Per Hour: \$17.10

Bricklayer (Fourth 750 Hours)

Effective Period: 7/1/2014 - 6/30/2015
Wage Rate Per Hour: 80% of Journeyperson's rate
Supplemental Benefit Rate Per Hour: \$17.10

Bricklayer (Fifth 750 Hours)

Effective Period: 7/1/2014 - 6/30/2015
Wage Rate Per Hour: 90% of Journeyperson's rate
Supplemental Benefit Rate Per Hour: \$17.10

Bricklayer (Sixth 750 Hours)

Effective Period: 7/1/2014 - 6/30/2015
Wage Rate Per Hour: 95% of Journeyperson's rate
Supplemental Benefit Rate Per Hour: \$17.10

(Bricklayer District Council)

CARPENTER

(Ratio of Apprentice to Journeyperson: 1 to 1, 1 to 4)

Carpenter (First Year)

Effective Period: 7/1/2014 - 6/30/2015
Wage Rate Per Hour: 40% of Journeyperson's rate
Supplemental Benefit Rate Per Hour: \$30.25

Carpenter (Second Year)

Effective Period: 7/1/2014 - 6/30/2015
Wage Rate Per Hour: 50% of Journeyperson's rate
Supplemental Benefit Rate Per Hour: \$30.25

Carpenter (Third Year)

Effective Period: 7/1/2014 - 6/30/2015

OFFICE OF THE COMPTROLLER, CITY OF NEW YORK
\$220 APPRENTICESHIP PREVAILING WAGE SCHEDULE

Wage Rate Per Hour: 65% of Journeyperson's rate
Supplemental Benefit Rate Per Hour: \$30.25

Carpenter (Fourth Year)

Effective Period: 7/1/2014 - 6/30/2015
Wage Rate Per Hour: 80% of Journeyperson's rate
Supplemental Benefit Rate Per Hour: \$30.25

(Carpenters District Council)

CEMENT MASON
(Ratio of Apprentice to Journeyperson: 1 to 1, 1 to 4)

Cement Mason (First Year)

Effective Period: 7/1/2014 - 6/30/2015
Wage and Supplemental Rate Per Hour: 50% of Journeyperson's Rate

Cement Mason (Second Year)

Effective Period: 7/1/2014 - 6/30/2015
Wage and Supplemental Rate Per Hour: 60% of Journeyperson's Rate

Cement Mason (Third Year)

Effective Period: 7/1/2014 - 6/30/2015
Wage and Supplemental Rate Per Hour: 70% of Journeyperson's Rate

(Local #780)

CEMENT AND CONCRETE WORKER
(Ratio of Apprentice to Journeyperson: 1 to 1, 1 to 3)

Cement & Concrete Worker (0 - 500 hours)

Effective Period: 7/1/2014 - 6/30/2015
Wage Rate Per Hour: 50% of Journeyperson's rate
Supplemental Benefit Rate Per Hour: \$18.04

Cement & Concrete Worker (501 - 1000 hours)

OFFICE OF THE COMPTROLLER, CITY OF NEW YORK
§220 APPRENTICESHIP PREVAILING WAGE SCHEDULE

Effective Period: 7/1/2014 - 6/30/2015
Wage Rate Per Hour: 65% of Journeyman's rate
Supplemental Benefit Rate Per Hour: \$18.87

Cement & Concrete Worker (1001 - 2000 hours)

Effective Period: 7/1/2014 - 6/30/2015
Wage Rate Per Hour: 65% of Journeyman's rate
Supplemental Benefit Rate Per Hour: \$24.25

Cement & Concrete Worker (2001 - 4000 hours)

Effective Period: 7/1/2014 - 6/30/2015
Wage Rate Per Hour: 80% of Journeyman's rate
Supplemental Benefit Rate Per Hour: \$25.07

(Cement Concrete Workers District Council)

**DERRICKPERSON & RIGGER (STONE)
(Ratio of Apprentice to Journeyman: 1 to 1, 1 to 4)**

Derrickperson & Rigger (stone) - First Year

Effective Period: 7/1/2014 - 6/30/2015
Wage Rate Per Hour: 50% of Journeyman's rate
Supplemental Benefit Rate Per Hour: 50% of Journeyman's rate

Derrickperson & Rigger (stone) - Second Year: 1st Six Months

Effective Period: 7/1/2014 - 6/30/2015
Wage Rate Per Hour: 70% of Journeyman's rate
Supplemental Benefit Rate Per Hour: 75% of Journeyman's rate

Derrickperson & Rigger (stone) - Second Year: 2nd Six Months

Effective Period: 7/1/2014 - 6/30/2015
Wage Rate Per Hour: 80% of Journeyman's rate
Supplemental Benefit Rate Per Hour: 75% of Journeyman's rate

Derrickperson & Rigger (stone) - Third Year

Effective Period: 7/1/2014 - 6/30/2015
Wage Rate Per Hour: 90% of Journeyman's rate
Supplemental Benefit Rate Per Hour: 75% of Journeyman's rate

OFFICE OF THE COMPTROLLER, CITY OF NEW YORK
§220 APPRENTICESHIP PREVAILING WAGE SCHEDULE

(Local #197)

DOCKBUILDER/PILE DRIVER
(Ratio of Apprentice to Journeyperson: 1 to 1, 1 to 6)

Dockbuilder/Pile Driver (First Year)

Effective Period: 7/1/2014 - 6/30/2015
Wage Rate Per Hour: 40% of Journeyperson's rate
Supplemental Benefit Rate Per Hour: \$31.26

Dockbuilder/Pile Driver (Second Year)

Effective Period: 7/1/2014 - 6/30/2015
Wage Rate Per Hour: 50% of Journeyperson's rate
Supplemental Benefit Rate Per Hour: \$31.26

Dockbuilder/Pile Driver (Third Year)

Effective Period: 7/1/2014 - 6/30/2015
Wage Rate Per Hour: 65% of Journeyperson's rate
Supplemental Benefit Rate Per Hour: \$31.26

Dockbuilder/Pile Driver (Fourth Year)

Effective Period: 7/1/2014 - 6/30/2015
Wage Rate Per Hour: 80% of Journeyperson's rate
Supplemental Benefit Rate Per Hour: \$31.26

(Carpenters District Council)

ELECTRICIAN
(Ratio of Apprentice to Journeyperson: 1 to 1, 1 to 3)

Electrician (First Term: 0-6 Months)

Effective Period: 7/1/2014 - 5/12/2015
Wage Rate per Hour: \$12.50
Supplemental Benefit Rate per Hour: \$11.10
Overtime Supplemental Rate Per Hour: \$11.93

OFFICE OF THE COMPTROLLER, CITY OF NEW YORK
§220 APPRENTICESHIP PREVAILING WAGE SCHEDULE

Effective Period: 5/13/2015 - 6/30/2015
Wage Rate per Hour: \$13.00
Supplemental Benefit Rate per Hour: \$11.61
Overtime Supplemental Rate Per Hour: \$12.47

Electrician (First Term: 7-12 Months)

Effective Period: 7/1/2014 - 5/12/2015
Wage Rate per Hour: \$13.50
Supplemental Benefit Rate per Hour: \$11.62
Overtime Supplemental Rate Per Hour: \$12.51

Effective Period: 5/13/2015 - 6/30/2015
Wage Rate per Hour: \$14.00
Supplemental Benefit Rate per Hour: \$12.12
Overtime Supplemental Rate Per Hour: \$13.04

Electrician (Second Term: 0-6 Months)

Effective Period: 7/1/2014 - 5/12/2015
Wage Rate per Hour: \$14.50
Supplemental Benefit Rate per Hour: \$12.13
Overtime Supplemental Rate Per Hour: \$13.08

Effective Period: 5/13/2015 - 6/30/2015
Wage Rate per Hour: \$15.00
Supplemental Benefit Rate per Hour: \$12.63
Overtime Supplemental Rate Per Hour: \$13.62

Electrician (Second Term: 7-12 Months)

Effective Period: 7/1/2014 - 5/12/2015
Wage Rate per Hour: \$15.50
Supplemental Benefit Rate per Hour: \$12.64
Overtime Supplemental Rate Per Hour: \$13.66

Effective Period: 5/13/2015 - 6/30/2015
Wage Rate per Hour: \$16.00
Supplemental Benefit Rate per Hour: \$13.14
Overtime Supplemental Rate Per Hour: \$14.19

Electrician (Third Term: 0-6 Months)

Effective Period: 7/1/2014 - 5/12/2015
Wage Rate per Hour: \$16.50
Supplemental Benefit Rate per Hour: \$13.15
Overtime Supplemental Rate Per Hour: \$14.23

Effective Period: 5/13/2015 - 6/30/2015
Wage Rate per Hour: \$17.00

OFFICE OF THE COMPTROLLER, CITY OF NEW YORK
\$220 APPRENTICESHIP PREVAILING WAGE SCHEDULE

Supplemental Benefit Rate per Hour: \$13.65
Overtime Supplemental Rate Per Hour: \$14.77

Electrician (Third Term: 7-12 Months)

Effective Period: 7/1/2014 - 5/12/2015
Wage Rate per Hour: \$17.50
Supplemental Benefit Rate per Hour: \$13.65
Overtime Supplemental Rate Per Hour: \$14.81

Effective Period: 5/13/2015 - 6/30/2015
Wage Rate per Hour: \$18.00
Supplemental Benefit Rate per Hour: \$14.16
Overtime Supplemental Rate Per Hour: \$15.34

Electrician (Fourth Term: 0-6 Months)

Effective Period: 7/1/2014 - 5/12/2015
Wage Rate per Hour: \$18.50
Supplemental Benefit Rate per Hour: \$14.16
Overtime Supplemental Rate Per Hour: \$15.38

Effective Period: 5/13/2015 - 6/30/2015
Wage Rate per Hour: \$19.00
Supplemental Benefit Rate per Hour: \$14.67
Overtime Supplemental Rate Per Hour: \$15.92

Electrician (Fourth Term: 7-12 Months)

Effective Period: 7/1/2014 - 5/12/2015
Wage Rate per Hour: \$20.50
Supplemental Benefit Rate per Hour: \$15.18
Overtime Supplemental Rate Per Hour: \$16.53

Effective Period: 5/13/2015 - 6/30/2015
Wage Rate per Hour: \$21.00
Supplemental Benefit Rate per Hour: \$15.68
Overtime Supplemental Rate Per Hour: \$17.07

Electrician (Fifth Term: 0-12 Months - Hired on or after 5/10/07)

Effective Period: 7/1/2014 - 5/12/2015
Wage Rate per Hour: \$22.50
Supplemental Benefit Rate per Hour: \$18.06
Overtime Supplemental Rate Per Hour: \$19.47

Effective Period: 5/13/2015 - 6/30/2015
Wage Rate per Hour: \$23.00
Supplemental Benefit Rate per Hour: \$18.56
Overtime Supplemental Rate Per Hour: \$20.00

OFFICE OF THE COMPTROLLER, CITY OF NEW YORK
§220 APPRENTICESHIP PREVAILING WAGE SCHEDULE

Electrician (Fifth Term: 13-18 Months - Hired on or after 5/10/07)

Effective Period: 7/1/2014 - 5/12/2015
Wage Rate per Hour: \$27.00
Supplemental Benefit Rate per Hour: \$20.32
Overtime Supplemental Rate Per Hour: \$22.01

Effective Period: 5/13/2015 - 6/30/2015
Wage Rate per Hour: \$27.50
Supplemental Benefit Rate per Hour: \$20.82
Overtime Supplemental Rate Per Hour: \$22.54

Electrician (Fifth Term: 0-18 Months - Hired before 5/10/07)

Effective Period: 7/1/2014 - 5/12/2015
Wage Rate per Hour: \$26.30
Supplemental Benefit Rate per Hour: \$19.96
Overtime Supplemental Rate Per Hour: \$21.61

Effective Period: 5/13/2015 - 6/30/2015
Wage Rate per Hour: \$26.80
Supplemental Benefit Rate per Hour: \$20.46
Overtime Supplemental Rate Per Hour: \$22.14

Overtime Description

Overtime Wage paid at time and one half the regular rate
For "A" rated Apprentices (work in excess of 7 hours per day)
For "M" rated Apprentices (work in excess of 8 hours per day)

(Local #3)

ELEVATOR CONSTRUCTOR
(Ratio of Apprentice to Journeyman: 1 to 1, 1 to 2)

Elevator (Constructor) - First Year

Effective Period: 7/1/2014 - 3/16/2015
Wage Rate Per Hour: 50% of Journeyman's rate
Supplemental Rate Per Hour: \$25.46

Effective Period: 3/17/2015 - 6/30/2015
Wage Rate Per Hour: 50% of Journeyman's rate
Supplemental Rate Per Hour: \$26.94

OFFICE OF THE COMPTROLLER, CITY OF NEW YORK
\$220 APPRENTICESHIP PREVAILING WAGE SCHEDULE

Elevator (Constructor) - Second Year

Effective Period: 7/1/2014 - 3/16/2015
Wage Rate Per Hour: 55% of Journeyperson's rate
Supplemental Rate Per Hour: \$25.86

Effective Period: 3/17/2015 - 6/30/2015
Wage Rate Per Hour: 55% of Journeyperson's rate
Supplemental Rate Per Hour: \$27.35

Elevator (Constructor) - Third Year

Effective Period: 7/1/2014 - 3/16/2015
Wage Rate Per Hour: 65% of Journeyperson's rate
Supplemental Rate Per Hour: \$26.66

Effective Period: 3/17/2015 - 6/30/2015
Wage Rate Per Hour: 65% of Journeyperson's rate
Supplemental Rate Per Hour: \$28.17

Elevator (Constructor) - Fourth Year

Effective Period: 7/1/2014 - 3/16/2015
Wage Rate Per Hour: 75% of Journeyperson's rate
Supplemental Rate Per Hour: \$27.46

Effective Period: 3/17/2015 - 6/30/2015
Wage Rate Per Hour: 75% of Journeyperson's rate
Supplemental Rate Per Hour: \$29.00

(Local #1)

ELEVATOR REPAIR & MAINTENANCE
(Ratio of Apprentice to Journeyperson: 1 to 1, 1 to 2)

Elevator Service/Modernization Mechanic (First Year)

Effective Period: 7/1/2014 - 3/16/2015
Wage Rate Per Hour: 50% of Journeyperson's rate
Supplemental Benefit Per Hour: \$24.85

Effective Period: 3/17/2015 - 6/30/2015
Wage Rate Per Hour: 50% of Journeyperson's rate
Supplemental Benefit Per Hour: \$26.87

Elevator Service/Modernization Mechanic (Second Year)

OFFICE OF THE COMPTROLLER, CITY OF NEW YORK.
§220 APPRENTICESHIP PREVAILING WAGE SCHEDULE

Effective Period: 7/1/2014 - 3/16/2015
Wage Rate Per Hour: 55% of Journeyman's rate
Supplemental Benefit Per Hour: \$25.24

Effective Period: 3/17/2015 - 6/30/2015
Wage Rate Per Hour: 55% of Journeyman's rate
Supplemental Benefit Per Hour: \$27.27

Elevator Service/Modernization Mechanic (Third Year)

Effective Period: 7/1/2014 - 3/16/2015
Wage Rate Per Hour: 65% of Journeyman's rate
Supplemental Benefit Per Hour: \$26.02

Effective Period: 3/17/2015 - 6/30/2015
Wage Rate Per Hour: 65% of Journeyman's rate
Supplemental Benefit Per Hour: \$28.08

Elevator Service/Modernization Mechanic (Fourth Year)

Effective Period: 7/1/2014 - 3/16/2015
Wage Rate Per Hour: 75% of Journeyman's rate
Supplemental Benefit Per Hour: \$26.81

Effective Period: 3/17/2015 - 6/30/2015
Wage Rate Per Hour: 75% of Journeyman's rate
Supplemental Benefit Per Hour: \$28.89

(Local #1)

ENGINEER
(Ratio of Apprentice to Journeyman: 1 to 1, 1 to 5)

Engineer - First Year

Effective Period: 7/1/2014 - 6/30/2015
Wage Rate per Hour: \$22.49
Supplemental Benefit Rate per Hour: \$20.68

Engineer - Second Year

Effective Period: 7/1/2014 - 6/30/2015
Wage Rate per Hour: \$28.11
Supplemental Benefit Rate per Hour: \$20.68

Engineer - Third Year

OFFICE OF THE COMPTROLLER, CITY OF NEW YORK
\$220 APPRENTICESHIP PREVAILING WAGE SCHEDULE

Effective Period: 7/1/2014 - 6/30/2015
Wage Rate per Hour: \$20.92
Supplemental Benefit Rate per Hour: \$20.68

Engineer - Fourth Year

Effective Period: 7/1/2014 - 6/30/2015
Wage Rate per Hour: \$33.73
Supplemental Benefit Rate per Hour: \$20.68

(Local #15)

ENGINEER - OPERATING

(Ratio of Apprentice to Journeyman: 1 to 1, 1 to 5)

Operating Engineer - First Year

Effective Period: 7/1/2014 - 6/30/2015
Wage Rate Per Hour 40% of Journeyman's Rate
Supplemental Benefit Per Hour: \$18.60

Operating Engineer - Second Year

Effective Period: 7/1/2014 - 6/30/2015
Wage Rate Per Hour: 50% of Journeyman's Rate
Supplemental Benefit Per Hour: \$18.60

Operating Engineer - Third Year

Effective Period: 7/1/2014 - 6/30/2015
Wage Rate Per Hour: 60% of Journeyman's Rate
Supplemental Benefit Per Hour: \$18.60

(Local #14)

FLOOR COVERER

(Ratio of Apprentice to Journeyman: 1 to 1, 1 to 4)

Floor Coverer (First Year)

OFFICE OF THE COMPTROLLER, CITY OF NEW YORK
§220 APPRENTICESHIP PREVAILING WAGE SCHEDULE

Effective Period: 7/1/2014 - 6/30/2015
Wage Rate Per Hour: 40% of Journeyman's rate
Supplemental Rate Per Hour: \$30.25

Floor Coverer (Second Year)

Effective Period: 7/1/2014 - 6/30/2015
Wage Rate Per Hour: 50% of Journeyman's rate
Supplemental Rate Per Hour: \$30.25

Floor Coverer (Third Year)

Effective Period: 7/1/2014 - 6/30/2015
Wage Rate Per Hour: 65% of Journeyman's rate
Supplemental Rate Per Hour: \$30.25

Floor Coverer (Fourth Year)

Effective Period: 7/1/2014 - 6/30/2015
Wage Rate Per Hour: 80% of Journeyman's rate
Supplemental Rate Per Hour: \$30.25

(Carpenters District Council)

GLAZIER
(Ratio of Apprentice to Journeyman: 1 to 1, 1 to 3)

Glazier (First Year)

Effective Period: 7/1/2014 - 10/31/2014
Wage Rate Per Hour: 40% of Journeyman's rate
Supplemental Rate Per Hour: \$12.97

Effective Period: 11/1/2014 - 6/30/2015
Wage Rate Per Hour: 40% of Journeyman's rate
Supplemental Rate Per Hour: \$13.12

Glazier (Second Year)

Effective Period: 7/1/2014 - 6/30/2015
Wage Rate Per Hour: 50% of Journeyman's rate
Supplemental Rate Per Hour: \$22.25

Glazier (Third Year)

OFFICE OF THE COMPTROLLER, CITY OF NEW YORK
§220 APPRENTICESHIP PREVAILING WAGE SCHEDULE

Effective Period: 7/1/2014 - 10/31/2014
Wage Rate Per Hour: 60% of Journeyperson's rate
Supplemental Rate Per Hour: \$24.75

Effective Period: 11/1/2014 - 6/30/2015
Wage Rate Per Hour: 60% of Journeyperson's rate
Supplemental Rate Per Hour: \$25.10

Glazier (Fourth Year)

Effective Period: 7/1/2014 - 10/31/2014
Wage Rate Per Hour: 80% of Journeyperson's rate
Supplemental Rate Per Hour: \$29.87

Effective Period: 11/1/2014 - 6/30/2015
Wage Rate Per Hour: 80% of Journeyperson's rate
Supplemental Rate Per Hour: \$30.02

(Local #1281)

HEAT & FROST INSULATOR
(Ratio of Apprentice to Journeyperson: 1 to 1, 1 to 4)

Heat & Frost Insulator (First Year)

Effective Period: 7/1/2014 - 6/30/2015
Wage and Supplemental Rate Per Hour: 40% of Journeyperson's rate

Heat & Frost Insulator (Second Year)

Effective Period: 7/1/2014 - 6/30/2015
Wage and Supplemental Rate Per Hour: 60% of Journeyperson's rate

Heat & Frost Insulator (Third Year)

Effective Period: 7/1/2014 - 6/30/2015
Wage and Supplemental Rate Per Hour: 70% of Journeyperson's rate

Heat & Frost Insulator (Fourth Year)

Effective Period: 7/1/2014 - 6/30/2015
Wage and Supplemental Rate Per Hour: 80% of Journeyperson's rate

Local #12)

**HOUSE WRECKER
(TOTAL DEMOLITION)
(Ratio of Apprentice to Journeyman: 1 to 1, 1 to 3)**

House Wrecker - First Year

Effective Period: 7/1/2014 - 6/30/2015
Wage Rate per Hour: \$20.52
Supplemental Benefit Rate per Hour: \$16.60

House Wrecker - Second Year

Effective Period: 7/1/2014 - 6/30/2015
Wage Rate per Hour: \$21.67
Supplemental Benefit Rate per Hour: \$16.60

House Wrecker - Third Year

Effective Period: 7/1/2014 - 6/30/2015
Wage Rate per Hour: \$23.27
Supplemental Benefit Rate per Hour: \$16.60

House Wrecker - Fourth Year

Effective Period: 7/1/2014 - 6/30/2015
Wage Rate per Hour: \$25.83
Supplemental Benefit Rate per Hour: \$16.60

(Mason Tenders District Council)

**IRON WORKER - ORNAMENTAL
(Ratio of Apprentice to Journeyman: 1 to 1, 1 to 4)**

Iron Worker (Ornamental) - 1st Ten Months

Effective Period: 7/1/2014 - 6/30/2015
Wage Rate Per Hour: 50% of Journeyman's rate
Supplemental Rate Per Hour: \$35.15

Iron Worker (Ornamental) - 11 -16 Months

OFFICE OF THE COMPTROLLER, CITY OF NEW YORK
\$220 APPRENTICESHIP PREVAILING WAGE SCHEDULE

Effective Period: 7/1/2014 - 6/30/2015
Wage Rate Per Hour: 55% of Journeyman's rate
Supplemental Rate Per Hour: \$36.21

Iron Worker (Ornamental) - 17 - 22 Months

Effective Period: 7/1/2014 - 6/30/2015
Wage Rate Per Hour: 60% of Journeyman's rate
Supplemental Rate Per Hour: \$37.27

Iron Worker (Ornamental) - 23 - 28 Months

Effective Period: 7/1/2014 - 6/30/2015
Wage Rate Per Hour: 70% of Journeyman's rate
Supplemental Rate Per Hour: \$39.40

Iron Worker (Ornamental) - 29 - 36 Months

Effective Period: 7/1/2014 - 6/30/2015
Wage Rate Per Hour: 80% of Journeyman's rate
Supplemental Rate Per Hour: \$41.52

(Local #580)

IRON WORKER - STRUCTURAL
(Ratio of Apprentice to Journeyman: 1 to 1, 1 to 6)

Iron Worker (Structural) - 1st Six Months

Effective Period: 7/1/2014 - 6/30/2015
Wage Rate per Hour: \$24.98
Supplemental Benefit Rate per Hour: \$45.53

Iron Worker (Structural) - 7- 18 Months

Effective Period: 7/1/2014 - 6/30/2015
Wage Rate per Hour: \$25.58
Supplemental Benefit Rate per Hour: \$45.53

Iron Worker (Structural) - 19 - 36 months

Effective Period: 7/1/2014 - 6/30/2015
Wage Rate per Hour: \$26.18
Supplemental Benefit Rate per Hour: \$45.53

OFFICE OF THE COMPTROLLER, CITY OF NEW YORK
§220 APPRENTICESHIP PREVAILING WAGE SCHEDULE

(Local #40 and #361)

LABORER (FOUNDATION, CONCRETE, EXCAVATING, STREET PIPE LAYER & COMMON)

(Ratio Apprentice to Journeyman: 1 to 1, 1 to 3)

Laborer (Foundation, Concrete, Excavating, Street Pipe Layer & Common) - First 1000 hours

Effective Period: 7/1/2014 - 6/30/2015
Wage Rate Per Hour: 50% of Journeyman's rate
Supplemental Rate Per Hour: \$34.88

Laborer (Foundation, Concrete, Excavating, Street Pipe Layer & Common) - Second 1000 hours

Effective Period: 7/1/2014 - 6/30/2015
Wage Rate Per Hour: 60% of Journeyman's rate
Supplemental Rate Per Hour: \$34.88

Laborer (Foundation, Concrete, Excavating, Street Pipe Layer & Common) - Third 1000 hours

Effective Period: 7/1/2014 - 6/30/2015
Wage Rate Per Hour: 75% of Journeyman's rate
Supplemental Rate Per Hour: \$34.88

Laborer (Foundation, Concrete, Excavating, Street Pipe Layer & Common) - Fourth 1000 hours

Effective Period: 7/1/2014 - 6/30/2015
Wage Rate Per Hour: 90% of Journeyman's rate
Supplemental Rate Per Hour: \$34.88

(Local #731)

MARBLE MECHANICS

(Ratio of Apprentice to Journeyman: 1 to 1, 1 to 4)

OFFICE OF THE COMPTROLLER, CITY OF NEW YORK
§220 APPRENTICESHIP PREVAILING WAGE SCHEDULE

Cutters & Setters - First 750 Hours

Effective Period: 7/1/2014 - 6/30/2015
Wage and Supplemental Rate Per Hour: 50% of Journeyperson's rate

NO BENEFITS PAID DURING THE FIRST TWO MONTHS (PROBATIONARY PERIOD)

Cutters & Setters - Second 750 Hours

Effective Period: 7/1/2014 - 6/30/2015
Wage and Supplemental Rate Per Hour: 55% of Journeyperson's rate

Cutters & Setters - Third 750 Hours

Effective Period: 7/1/2014 - 6/30/2015
Wage and Supplemental Rate Per Hour: 65% of Journeyperson's rate

Cutters & Setters - Fourth 750 Hours

Effective Period: 7/1/2014 - 6/30/2015
Wage and Supplemental Rate Per Hour: 75% of Journeyperson's rate

Cutters & Setters - Fifth 750 Hours

Effective Period: 7/1/2014 - 6/30/2015
Wage and Supplemental Rate Per Hour: 85% of Journeyperson's rate

Cutters & Setters - Sixth 750 Hours

Effective Period: 7/1/2014 - 6/30/2015
Wage and Supplemental Rate Per Hour: 95% of Journeyperson's rate

Polishers & Finishers - First 750 Hours

Effective Period: 7/1/2014 - 6/30/2015
Wage and Supplemental Rate Per Hour: 50% of Journeyperson's rate

NO BENEFITS PAID DURING THE FIRST TWO MONTHS (PROBATIONARY PERIOD)

Polishers & Finishers - Second 750 Hours

Effective Period: 7/1/2014 - 6/30/2015
Wage and Supplemental Rate Per Hour: 60% of Journeyperson's rate

Polishers & Finishers - Third 750 Hours

Effective Period: 7/1/2014 - 6/30/2015
Wage and Supplemental Rate Per Hour: 75% of Journeyperson's rate

Polishers & Finishers - Fourth 750 Hours

OFFICE OF THE COMPTROLLER, CITY OF NEW YORK
§220 APPRENTICESHIP PREVAILING WAGE SCHEDULE

Effective Period: 7/1/2014 - 6/30/2015
Wage and Supplemental Rate Per Hour: 90% of Journeyperson's rate

(Local #7)

MASON TENDER
(Ratio of Apprentice to Journeyperson: 1 to 1, 1 to 3)

Mason Tender - First Year

Effective Period: 7/1/2014 - 6/30/2015
Wage Rate per Hour: \$20.99
Supplemental Benefit Rate per Hour: \$17.86

Mason Tender - Second Year

Effective Period: 7/1/2014 - 6/30/2015
Wage Rate per Hour: \$22.14
Supplemental Benefit Rate per Hour: \$17.86

Mason Tender - Third Year

Effective Period: 7/1/2014 - 6/30/2015
Wage Rate per Hour: \$23.84
Supplemental Benefit Rate per Hour: \$17.86

Mason Tender - Fourth Year

Effective Period: 7/1/2014 - 6/30/2015
Wage Rate per Hour: \$26.50
Supplemental Benefit Rate per Hour: \$17.86

(Local #79)

METALLIC LATHER
(Ratio of Apprentice to Journeyperson: 1 to 1, 1 to 3)

Metallic Lather (First Year -Called Prior to 6/29/11)

OFFICE OF THE COMPTROLLER, CITY OF NEW YORK
\$220 APPRENTICESHIP PREVAILING WAGE SCHEDULE

Effective Period: 7/1/2014 - 6/30/2015
Wage Rate per Hour: \$28.11
Supplemental Benefit Rate per Hour: \$22.79

Metallic Lather (Second Year - Called Prior to 6/29/11)

Effective Period: 7/1/2014 - 6/30/2015
Wage Rate per Hour: \$32.71
Supplemental Benefit Rate per Hour: \$24.44

Metallic Lather (Third Year - Called Prior to 6/29/11)

Effective Period: 7/1/2014 - 6/30/2015
Wage Rate per Hour: \$37.77
Supplemental Benefit Rate per Hour: \$25.59

Metallic Lather (First Year -Called On Or After 6/29/11)

Effective Period: 7/1/2014 - 6/30/2015
Wage Rate per Hour: \$17.71
Supplemental Benefit Rate per Hour: \$19.85

Metallic Lather (Second Year - Called On Or After 6/29/11)

Effective Period: 7/1/2014 - 6/30/2015
Wage Rate per Hour: \$22.81
Supplemental Benefit Rate per Hour: \$19.85

Metallic Lather (Third Year - Called On Or After 6/29/11)

Effective Period: 7/1/2014 - 6/30/2015
Wage Rate per Hour: \$27.91
Supplemental Benefit Rate per Hour: \$19.85

(Local #46)

MILLWRIGHT

(Ratio of Apprentice to Journeyperson: 1 to 1, 1 to 4)

Millwright (First Year)

Effective Period: 7/1/2014 - 6/30/2015
Wage Rate per Hour: \$26.64

OFFICE OF THE COMPTROLLER, CITY OF NEW YORK
§220 APPRENTICESHIP PREVAILING WAGE SCHEDULE

Supplemental Benefit Rate per Hour: \$32.84

Millwright (Second Year)

Effective Period: 7/1/2014 - 6/30/2015
Wage Rate per Hour: \$31.49
Supplemental Benefit Rate per Hour: \$36.18

Millwright (Third Year)

Effective Period: 7/1/2014 - 6/30/2015
Wage Rate per Hour: \$36.33
Supplemental Benefit Rate per Hour: \$40.66

Millwright (Fourth Year)

Effective Period: 7/1/2014 - 6/30/2015
Wage Rate per Hour: \$46.02
Supplemental Benefit Rate per Hour: \$46.24

(Local #740)

**PAVER AND ROADBUILDER
(Ratio of Apprentice to Journeyman: 1 to 1, 1 to 3)**

Paver and Roadbuilder - First Year (Minimum 1000 hours)

Effective Period: 7/1/2014 - 6/30/2015
Wage Rate per Hour: \$26.61
Supplemental Benefit Rate per Hour: \$16.50

Paver and Roadbuilder - Second Year (Minimum 1000 hours)

Effective Period: 7/1/2014 - 6/30/2015
Wage Rate per Hour: \$28.22
Supplemental Benefit Rate per Hour: \$16.50

(Local #1010)

OFFICE OF THE COMPTROLLER, CITY OF NEW YORK
§220 APPRENTICESHIP PREVAILING WAGE SCHEDULE

PAINTER
(Ratio of Apprentice to Journeyman: 1 to 1, 1 to 3)

Painter - Brush & Roller - First Year

Effective Period: 7/1/2014 - 6/30/2015
Wage Rate per Hour: \$15.80
Supplemental Benefit Rate per Hour: \$11.88

Painter - Brush & Roller - Second Year

Effective Period: 7/1/2014 - 6/30/2015
Wage Rate per Hour: \$19.75
Supplemental Benefit Rate per Hour: \$15.73

Painter - Brush & Roller - Third Year

Effective Period: 7/1/2014 - 6/30/2015
Wage Rate per Hour: \$23.70
Supplemental Benefit Rate per Hour: \$18.64

Painter - Brush & Roller - Fourth Year

Effective Period: 7/1/2014 - 6/30/2015
Wage Rate per Hour: \$31.60
Supplemental Benefit Rate per Hour: \$24.02

(District Council of Painters)

PAINTER - STRUCTURAL STEEL
(Ratio of Apprentice to Journeyman: 1 to 1, 1 to 3)

Painters - Structural Steel (First Year)

Effective Period: 7/1/2014 - 6/30/2015
Wage and Supplemental Rate Per Hour: 40% of Journeyman's rate

Painters - Structural Steel (Second Year)

Effective Period: 7/1/2014 - 6/30/2015
Wage and Supplemental Rate Per Hour: 60% of Journeyman's rate

OFFICE OF THE COMPTROLLER, CITY OF NEW YORK
§220 APPRENTICESHIP PREVAILING WAGE SCHEDULE

Painters - Structural Steel (Third Year)

Effective Period: 7/1/2014 - 6/30/2015
Wage and Supplemental Rate Per Hour: 80% of Journeyperson's rate

(Local #806)

PLASTERER
(Ratio of Apprentice to Journeyperson: 1 to 1, 1 to 3)

Plasterer - First Year: 1st Six Months

Effective Period: 7/1/2014 - 6/30/2015
Wage Rate Per Hour: 40% of Journeyperson's rate
Supplemental Rate Per Hour: \$15.76

Plasterer - First Year: 2nd Six Months

Effective Period: 7/1/2014 - 6/30/2015
Wage Rate Per Hour: 45% of Journeyperson's rate
Supplemental Rate Per Hour: \$16.24

Plasterer - Second Year: 1st Six Months

Effective Period: 7/1/2014 - 6/30/2015
Wage Rate Per Hour: 55% of Journeyperson's rate
Supplemental Rate Per Hour: \$18.21

Plasterer - Second Year: 2nd Six Months

Effective Period: 7/1/2014 - 6/30/2015
Wage Rate Per Hour: 60% of Journeyperson's rate
Supplemental Rate Per Hour: \$19.29

Plasterer - Third Year: 1st Six Months

Effective Period: 7/1/2014 - 6/30/2015
Wage Rate Per Hour: 70% of Journeyperson's rate
Supplemental Rate Per Hour: \$21.46

Plasterer - Third Year: 2nd Six Months

Effective Period: 7/1/2014 - 6/30/2015
Wage Rate Per Hour: 75% of Journeyperson's rate
Supplemental Rate Per Hour: \$22.54

OFFICE OF THE COMPTROLLER, CITY OF NEW YORK
\$220 APPRENTICESHIP PREVAILING WAGE SCHEDULE

(Local #530)

PLUMBER

(Ratio of Apprentice to Journeyperson: 1 to 1, 1 to 3)

Plumber - First Year: 1st Six Months

Effective Period: 7/1/2014 - 6/30/2015

Wage Rate per Hour: \$14.00

Supplemental Benefit Rate per Hour: \$0.71

Plumber - First Year: 2nd Six Months

Effective Period: 7/1/2014 - 6/30/2015

Wage Rate per Hour: \$14.00

Supplemental Benefit Rate per Hour: \$2.96

Plumber - Second Year

Effective Period: 7/1/2014 - 6/30/2015

Wage Rate per Hour: \$23.87

Supplemental Benefit Rate per Hour: \$11.46

Plumber - Third Year

Effective Period: 7/1/2014 - 6/30/2015

Wage Rate per Hour: \$25.97

Supplemental Benefit Rate per Hour: \$11.46

Plumber - Fourth Year

Effective Period: 7/1/2014 - 6/30/2015

Wage Rate per Hour: \$28.82

Supplemental Benefit Rate per Hour: \$11.46

Plumber - Fifth Year: 1st Six Months

Effective Period: 7/1/2014 - 6/30/2015

Wage Rate per Hour: \$30.22

Supplemental Benefit Rate per Hour: \$11.46

Plumber - Fifth Year: 2nd Six Months

OFFICE OF THE COMPTROLLER, CITY OF NEW YORK
\$220 APPRENTICESHIP PREVAILING WAGE SCHEDULE

Effective Period: 7/1/2014 - 6/30/2015
Wage Rate per Hour: \$42.29
Supplemental Benefit Rate per Hour: \$11.46

(Plumbers Local #1)

**POINTER - WATERPROOFER, CAULKER MECHANIC (EXTERIOR BUILDING
RENOVATION)**

(Ratio of Apprentice to Journeyman: 1 to 1, 1 to 4)

Pointer - Waterproofer, Caulker Mechanic - First Year

Effective Period: 7/1/2014 - 6/30/2015
Wage Rate per Hour: \$25.01
Supplemental Benefit Rate per Hour: \$4.75

Pointer - Waterproofer, Caulker Mechanic - Second Year

Effective Period: 7/1/2014 - 6/30/2015
Wage Rate per Hour: \$27.25
Supplemental Benefit Rate per Hour: \$9.70

Pointer - Waterproofer, Caulker Mechanic - Third Year

Effective Period: 7/1/2014 - 6/30/2015
Wage Rate per Hour: \$32.24
Supplemental Benefit Rate per Hour: \$12.45

Pointer - Waterproofer, Caulker Mechanic - Fourth Year

Effective Period: 7/1/2014 - 6/30/2015
Wage Rate per Hour: \$38.66
Supplemental Benefit Rate per Hour: \$12.45

(Bricklayer District Council)

ROOFER

(Ratio of Apprentice to Journeyman: 1 to 1, 1 to 2)

OFFICE OF THE COMPTROLLER, CITY OF NEW YORK
§220 APPRENTICESHIP PREVAILING WAGE SCHEDULE

Rofer - First Year

Effective Period: 7/1/2014 - 6/30/2015
Wage and Supplemental Rate Per Hour: 35% of Journeyperson's Rate

Rofer - Second Year

Effective Period: 7/1/2014 - 6/30/2015
Wage and Supplemental Rate Per Hour: 50% of Journeyperson's Rate

Rofer - Third Year

Effective Period: 7/1/2014 - 6/30/2015
Wage and Supplemental Rate Per Hour: 60% of Journeyperson's Rate

Rofer - Fourth Year

Effective Period: 7/1/2014 - 6/30/2015
Wage and Supplemental Rate Per Hour: 75% of Journeyperson's Rate

(Local #8)

SHEET METAL WORKER
(Ratio of Apprentice to Journeyperson: 1 to 1, 1 to 3)

Sheet Metal Worker (0-6 Months)

Effective Period: 7/1/2014 - 6/30/2015
Wage Rate Per Hour: 25% of Journeyperson's rate
Supplemental Rate Per Hour: \$6.15

Sheet Metal Worker (7-18 Months)

Effective Period: 7/1/2014 - 6/30/2015
Wage Rate Per Hour: 35% of Journeyperson's rate
Supplemental Rate Per Hour: \$16.21

Sheet Metal Worker (19-30 Months)

Effective Period: 7/1/2014 - 6/30/2015
Wage Rate Per Hour: 45% of Journeyperson's rate
Supplemental Rate Per Hour: \$22.23

Sheet Metal Worker (31-36 Months)

OFFICE OF THE COMPTROLLER, CITY OF NEW YORK
§220 APPRENTICESHIP PREVAILING WAGE SCHEDULE

Effective Period: 7/1/2014 - 6/30/2015
Wage Rate Per Hour: 55% of Journeyman's rate
Supplemental Rate Per Hour: \$26.16

Sheet Metal Worker (37-42 Months)

Effective Period: 7/1/2014 - 6/30/2015
Wage Rate Per Hour: 60% of Journeyman's rate
Supplemental Rate Per Hour: \$28.13

Sheet Metal Worker (43-48 Months)

Effective Period: 7/1/2014 - 6/30/2015
Wage Rate Per Hour: 70% of Journeyman's rate
Supplemental Rate Per Hour: \$32.09

Sheet Metal Worker (49-54 Months)

Effective Period: 7/1/2014 - 6/30/2015
Wage Rate Per Hour: 75% of Journeyman's rate
Supplemental Rate Per Hour: \$34.07

Sheet Metal Worker (55-60 Months)

Effective Period: 7/1/2014 - 6/30/2015
Wage Rate Per Hour: 80% of Journeyman's rate
Supplemental Rate Per Hour: \$36.03

(Local #28)

SIGN ERECTOR

(Ratio of Apprentice to Journeyman: 1 to 1, 1 to 4)

Sign Erector - First Year: 1st Six Months

Effective Period: 7/1/2014 - 6/30/2015
Wage Rate Per Hour: 35% of Journeyman's rate
Supplemental Rate Per Hour: \$5.96

Sign Erector - First Year: 2nd Six Months

Effective Period: 7/1/2014 - 6/30/2015
Wage Rate Per Hour: 40% of Journeyman's rate
Supplemental Rate Per Hour: \$6.75

Sign Erector - Second Year: 1st Six Months

OFFICE OF THE COMPTROLLER, CITY OF NEW YORK
§220 APPRENTICESHIP PREVAILING WAGE SCHEDULE

Effective Period: 7/1/2014 - 6/30/2015
Wage Rate Per Hour: 45% of Journeyman's rate
Supplemental Rate Per Hour: \$7.55

Sign Erector - Second Year: 2nd Six Months

Effective Period: 7/1/2014 - 6/30/2015
Wage Rate Per Hour: 50% of Journeyman's rate
Supplemental Rate Per Hour: \$8.34

Sign Erector - Third Year: 1st Six Months

Effective Period: 7/1/2014 - 6/30/2015
Wage Rate Per Hour: 55% of Journeyman's rate
Supplemental Rate Per Hour: \$9.13

Sign Erector - Third Year: 2nd Six Months

Effective Period: 7/1/2014 - 6/30/2015
Wage Rate Per Hour: 60% of Journeyman's rate
Supplemental Rate Per Hour: \$9.92

Sign Erector - Fourth Year: 1st Six Months

Effective Period: 7/1/2014 - 6/30/2015
Wage Rate Per Hour: 65% of Journeyman's rate
Supplemental Rate Per Hour: \$10.72

Sign Erector - Fourth Year: 2nd Six Months

Effective Period: 7/1/2014 - 6/30/2015
Wage Rate Per Hour: 70% of Journeyman's rate
Supplemental Rate Per Hour: \$11.51

Sign Erector - Fifth Year

Effective Period: 7/1/2014 - 6/30/2015
Wage Rate Per Hour: 75% of Journeyman's rate
Supplemental Rate Per Hour: \$12.30

Sign Erector - Sixth Year

Effective Period: 7/1/2014 - 6/30/2015
Wage Rate Per Hour: 80% of Journeyman's rate
Supplemental Rate Per Hour: \$12.30

(Local #137)

STEAMFITTER

(Ratio of Apprentice to Journeyman: 1 to 1, 1 to 3)

Steamfitter - First Year

Effective Period: 7/1/2014 - 6/30/2015
Wage Rate and Supplemental Per Hour: 40% of Journeyman's rate

Steamfitter - Second Year

Effective Period: 7/1/2014 - 6/30/2015
Wage Rate and Supplemental Rate Per Hour: 50% of Journeyman's rate.

Steamfitter - Third Year

Effective Period: 7/1/2014 - 6/30/2015
Wage Rate and Supplemental Rate per Hour: 65% of Journeyman's rate.

Steamfitter - Fourth Year

Effective Period: 7/1/2014 - 6/30/2015
Wage Rate and Supplemental Rate Per Hour: 80% of Journeyman's rate.

Steamfitter - Fifth Year

Effective Period: 7/1/2014 - 6/30/2015
Wage Rate and Supplemental Rate Per Hour: 85% of Journeyman's rate.

(Local #638)

STONE MASON - SETTER

(Ratio Apprentice of Journeyman: 1 to 1, 1 to 2)

Stone Mason - Setters - First 750 Hours

Effective Period: 7/1/2014 - 6/30/2015
Wage and Supplemental Rate Per Hour: 50% of Journeyman's rate

Stone Mason - Setters - Second 750 Hours

Effective Period: 7/1/2014 - 6/30/2015
Wage Rate Per Hour: 60% of Journeyman's rate

OFFICE OF THE COMPTROLLER, CITY OF NEW YORK
§220 APPRENTICESHIP PREVAILING WAGE SCHEDULE

Supplemental Rate Per Hour: 50% of Journeyperson's rate

Stone Mason - Setters - Third 750 Hours

Effective Period: 7/1/2014 - 6/30/2015

Wage Rate Per Hour: 70% of Journeyperson's rate

Supplemental Rate Per Hour: 50% of Journeyperson's rate

Stone Mason - Setters - Fourth 750 Hours

Effective Period: 7/1/2014 - 6/30/2015

Wage Rate Per Hour: 80% of Journeyperson's rate

Supplemental Rate Per Hour: 50% of Journeyperson's rate

Stone Mason - Setters - Fifth 750 Hours

Effective Period: 7/1/2014 - 6/30/2015

Wage Rate Per Hour: 90% of Journeyperson's rate

Supplemental Rate Per Hour: 50% of Journeyperson's rate

Stone Mason - Setters - Sixth 750 Hours

Effective Period: 7/1/2014 - 6/30/2015

Wage Rate Per Hour: 100% of Journeyperson's rate

Supplemental Rate Per Hour: 50% of Journeyperson's rate

(Bricklayers District Council)

TAPER

(Ratio of Apprentice to Journeyperson: 1 to 1, 1 to 4)

Drywall Taper - First Year

Effective Period: 7/1/2014 - 6/30/2015

Wage and Supplemental Rate Per Hour: 40% of Journeyperson's rate

Drywall Taper - Second Year

Effective Period: 7/1/2014 - 6/30/2015

Wage and Supplemental Rate Per Hour: 60% of Journeyperson's rate

Drywall Taper - Third Year

Effective Period: 7/1/2014 - 6/30/2015

Wage and Supplemental Rate Per Hour: 80% of Journeyperson's rate

OFFICE OF THE COMPTROLLER, CITY OF NEW YORK
§220 APPRENTICESHIP PREVAILING WAGE SCHEDULE

(Local #1974)

TILE LAYER - SETTER
(Ratio of Apprentice to Journeyman: 1 to 1, 1 to 4)

Tile Layer - Setter - First 750 Hours

Effective Period: 7/1/2014 - 6/30/2015
Wage and Supplemental Rate Per Hour: 50% of Journeyman's rate

Tile Layer - Setter - Second 750 Hours

Effective Period: 7/1/2014 - 6/30/2015
Wage and Supplemental Rate Per Hour: 55% of Journeyman's rate

Tile Layer - Setter - Third 750 Hours

Effective Period: 7/1/2014 - 6/30/2015
Wage and Supplemental Rate Per Hour: 65% of Journeyman's rate

Tile Layer - Setter - Fourth 750 Hours

Effective Period: 7/1/2014 - 6/30/2015
Wage and Supplemental Rate Per Hour: 75% of Journeyman's rate

Tile Layer - Setter - Fifth 750 Hours

Effective Period: 7/1/2014 - 6/30/2015
Wage and Supplemental Rate Per Hour: 85% of Journeyman's rate

Tile Layer - Setter - Sixth 750 Hours

Effective Period: 7/1/2014 - 6/30/2015
Wage and Supplemental Rate Per Hour: 95% of Journeyman's rate

(Local #7)

TIMBERPERSON
(Ratio of Apprentice to Journeyman: 1 to 1, 1 to 6)

OFFICE OF THE COMPTROLLER, CITY OF NEW YORK
§220 APPRENTICESHIP PREVAILING WAGE SCHEDULE

Timberperson - First Year

Effective Period: 7/1/2014 - 6/30/2015
Wage Rate Per Hour: 40% of Journeyperson's rate
Supplemental Rate Per Hour: \$30.89

Timberperson - Second Year

Effective Period: 7/1/2014 - 6/30/2015
Wage Rate Per Hour: 50% of Journeyperson's rate
Supplemental Rate Per Hour: \$30.89

Timberperson - Third Year

Effective Period: 7/1/2014 - 6/30/2015
Wage Rate Per Hour: 65% of Journeyperson's rate
Supplemental Rate Per Hour: \$30.89

Timberperson - Fourth Year

Effective Period: 7/1/2014 - 6/30/2015
Wage Rate Per Hour: 80% of Journeyperson's rate
Supplemental Rate Per Hour: \$30.89

(Local #1536)

OFFICE OF THE COMPTROLLER, CITY OF NEW YORK
§6-109 PREVAILING WAGE SCHEDULE

NYC ADMINISTRATIVE CODE § 6-109 SCHEDULE OF "LIVING WAGES"

Contractors who provide the following services to the City of New York must post a copy of this Living Wage Schedule at their work site(s) as required by New York City Administrative Code § 6-109:

- Building Services,
- Day Care Services,
- Food Services,
- Head Start Services,
- Homecare Services,
- Services to Persons with Cerebral Palsy, and
- Temporary Services.

In accordance with NYC Administrative Code § 6-109, the Comptroller of the City of New York promulgated this schedule of living wages for the above services on contracts for non-emergency work in excess of the small purchase limit set by the Procurement Policy Board; contracting agencies must annex this schedule to such contracts.

This schedule is a compilation of separate determinations of the prevailing rate of wage and supplements made by the Comptroller for each trade classification listed herein pursuant to New York City Administrative Code section 6-109. The source of the wage and supplement rates, whether a collective bargaining agreement, survey data or other, is listed at the end of each classification.

A city service contractor or subcontractor that provides homecare services, day care services, head start services or services to persons with cerebral palsy must pay its covered employees that directly render such services in performance of the city service contract or subcontract no less than the living wage and must provide its employees health benefits (supplemental benefits) or must supplement their hourly wage rate by an amount no less than the health benefits supplement rate. This requirement applies for each hour that the employee works performing the city service contract or subcontract.

A city service contractor or subcontractor that provides building services, food services or temporary services must pay its employees that are engaged in performing the city service contract or subcontract no less than the living wage or the prevailing wage, whichever is greater. Where the living wage is greater than the prevailing wage, the city service contractor or subcontractor must either provide its employees health benefits or must supplement their hourly wage rate by an amount no less than the health benefits supplement rate. Where the prevailing wage is greater than the living wage, the city service contractor or subcontractor must provide its employees the prevailing wage and supplements. These requirements apply for each hour that the employee works performing the city service contract or subcontract.

The appropriate schedule of living wages must be posted at all work sites pursuant to NYC Administrative Code 6-109.

OFFICE OF THE COMPTROLLER, CITY OF NEW YORK
§6-109 PREVAILING WAGE SCHEDULE

The schedule is applicable for work performed during the effective period, unless otherwise noted. You will be notified of any changes to this schedule by addenda published on our web site www.comptroller.nyc.gov. Schedules for future one-year periods will be published annually in the City Record on or about July 1st of each succeeding year and on our web site www.comptroller.nyc.gov.

The living wage rate and the health benefit supplement rate are known through June 30 of each year and those rates are listed in this schedule.

The living wage rates listed in this schedule may not include all hourly wage calculations for overtime, shift differential, Holiday, Saturday, Sunday or other premium time work. Similarly, this schedule does not set forth every living wage practice with which employers must comply.

Some of the rates in this schedule are based on collective bargaining agreements. These agreements are available for inspection by appointment. Requests for appointments may be made by calling (212) 669-4443, Monday through Friday between the hours of 9 a.m. and 5 p.m.

Answers to questions concerning prevailing wage practices may be obtained from the Classification Unit by calling (212) 669-7974. Please direct all other compliance issues to; Bureau of Labor Law, Attn: Wasyl Kinach, P.E., Office of the Comptroller, 1 Centre Street, Room 1122, New York, N.Y. 10007; Fax (212) 669-4002.

Contractors are solely responsible for maintaining original payroll records, which delineate, among other things, the hours each employee worked within a given classification. Contractors using rates and/or classifications not promulgated by the Comptroller do so at their own risk. Additionally, prior to bid, an agency's chief contracting officer must contact the Bureau of Labor Law to obtain a wage determination for a work classification not published in this schedule.

The information listed below is intended to assist you in meeting your living wage and prevailing wage obligation. Contractors are advised to review the Comptroller's Living Wage Schedule prior to submitting a bid for City work. Any wage rate error made by the contracting agency in the contract documents will not preclude a finding against the contractor for an underpayment of the applicable living wage or the applicable prevailing wage.

This schedule sets forth the living wage and benefit rates required to be annexed to and form part of the contract specifications for work covered by New York City Administrative Code § 6-109. Contractors performing such work are required to pay not less than the rates specified in this schedule for the applicable trade or occupation.

Benefits are paid for EACH HOUR WORKED unless otherwise noted.

Wasyl Kinach, P.E.
Director of Classifications
Bureau of Labor Law

OFFICE OF THE COMPTROLLER, CITY OF NEW YORK
§6-109 PREVAILING WAGE SCHEDULE

TABLE OF CONTENTS

<u>CLASSIFICATION</u>	<u>PAGE</u>
BUILDING CLEANER AND MAINTAINER (OFFICE).....	4
BUILDING CLEANER AND MAINTAINER (RESIDENTIAL).....	4
CLEANER (PARKING GARAGE).....	4
DAY CARE SERVICES.....	4
FOOD SERVICE EMPLOYEES.....	4
GARDENER.....	5
HEAD START SERVICES.....	5
HOMECARE SERVICES.....	6
SECURITY GUARD (ARMED).....	6
SECURITY GUARD (UNARMED).....	6
SERVICES TO PERSONS WITH CEREBRAL PALSY.....	6
TEMPORARY OFFICE SERVICES.....	7
WINDOW CLEANER.....	8

OFFICE OF THE COMPTROLLER, CITY OF NEW YORK
§6-109 PREVAILING WAGE SCHEDULE

BUILDING CLEANER AND MAINTAINER (OFFICE)

For the above building service classification, see the Labor Law Section 230 Schedule.

BUILDING CLEANER AND MAINTAINER (RESIDENTIAL)

For the above building service classification, see the Labor Law Section 230 Schedule.

CLEANER (PARKING GARAGE)

For the above building service classification, see the Labor Law Section 230 Schedule.

DAY CARE SERVICES

Day Care Services

'Day Care Services' means provision of day care services through the city's center-based day care program administered under contract with the city's Administration for Children's Services. No other day care programs shall be covered, including family-based day care programs administered by city-contracted day care centers.

Effective Period: 7/1/2014 - 6/30/2015

Wage Rate per Hour: \$10.00

Supplemental Benefit Rate per Hour: \$1.50

(NYC Administrative Code §6-109)

FOOD SERVICE EMPLOYEES

Cook

Effective Period: 7/1/2014 - 6/30/2015

Wage Rate per Hour: \$16.35

Supplemental Benefit Rate per Hour: \$1.63

Cafeteria Attendant

OFFICE OF THE COMPTROLLER, CITY OF NEW YORK
§6-109 PREVAILING WAGE SCHEDULE

Effective Period: 7/1/2014 - 6/30/2015
Wage Rate per Hour: \$10.41
Supplemental Benefit Rate per Hour: \$1.63

Counter Attendant

Effective Period: 7/1/2014 - 6/30/2015
Wage Rate per Hour: \$11.00
Supplemental Benefit Rate per Hour: \$1.63

Kitchen Helper / Dishwasher

Effective Period: 7/1/2014 - 6/30/2015
Wage Rate per Hour: \$9.99
Supplemental Benefit Rate per Hour: \$1.63

Overtime

Time and one half the regular hourly rate after 40 hours in any work week.

(Based on data from NYS Department of Labor Occupational Employment Statistics and US Department of Labor Bureau of Labor Statistics)

GARDENER

For the above building service classification, see the Labor Law Section 230 Schedule.

HEAD START SERVICES

Head Start Services

'Head Start Services' means provision of head start services through the city's center-based head start program administered under contract with the city's Administration for Children's Services. No other head start programs shall be covered.

Effective Period: 7/1/2014 - 6/30/2015
Wage Rate per Hour: \$10.00
Supplemental Benefit Rate per Hour: \$1.50

(NYC Administrative Code §6-109)

OFFICE OF THE COMPTROLLER, CITY OF NEW YORK
§6-109 PREVAILING WAGE SCHEDULE

HEMOCARE SERVICES

Home Care Services

'Homecare Services' means the provision of homecare services under the city's Medicaid Personal Care/Home Attendant or Housekeeping Programs, including but not limited to the In-Home Services for the Elderly Programs administered by the Department for the Aging.

For homecare services provided under the Personal Care Services program, the wage and supplemental benefit rate above shall apply only as long as the state and federal government maintain their combined aggregate proportionate share of funding and approved rates for homecare services in effect as of the date of the enactment of this section.

For contractors or subcontractors providing homecare services, the supplemental benefit rate may be waived by the terms of a bona fide collective bargaining agreement with respect to employees who have never worked a minimum of eighty (80) hours per month for two consecutive months for that covered employer, but such provision may not be waived for any employee once a minimum of eighty (80) hours for two consecutive months has been achieved.

Effective Period: 7/1/2014 - 6/30/2015

Wage Rate per Hour: \$10.00

Supplemental Benefit Rate per Hour: \$1.50

(NYC Administrative Code §6-109)

SECURITY GUARD (ARMED)

For the above building service classification, see the Labor Law Section 230 Schedule.

SECURITY GUARD (UNARMED)

For the above building service classification, see the Labor Law Section 230 Schedule.

SERVICES TO PERSONS WITH CEREBRAL PALSY

Services To Person With Cerebral Palsy

'Services to Persons with Cerebral Palsy' means provision of services which enable persons with cerebral palsy and related disabilities to lead independent and productive lives through an agency that provides health care, education, employment, housing and technology resources to such persons under contract with the city or the department of education.

Effective Period: 7/1/2014 - 6/30/2015

Wage Rate per Hour: \$10.00

OFFICE OF THE COMPTROLLER, CITY OF NEW YORK
§6-109 PREVAILING WAGE SCHEDULE

Supplemental Benefit Rate per Hour: \$1.50

(NYC Administrative Code §6-109)

TEMPORARY OFFICE SERVICES

Administrative Assistant

Effective Period: 7/1/2014 - 6/30/2015
Wage Rate per Hour: \$33.29
Supplemental Benefit Rate per Hour: None

Cashier

Effective Period: 7/1/2014 - 6/30/2015
Wage Rate per Hour: \$11.50
Supplemental Benefit Rate per Hour: None

Clerk (various)

Effective Period: 7/1/2014 - 6/30/2015
Wage Rate per Hour: \$14.82
Supplemental Benefit Rate per Hour: None

Computer Assistant

Effective Period: 7/1/2014 - 6/30/2015
Wage Rate per Hour: \$19.94
Supplemental Benefit Rate per Hour: None

Data Entry Operator

Effective Period: 7/1/2014 - 6/30/2015
Wage Rate per Hour: \$16.44
Supplemental Benefit Rate per Hour: None

Receptionist

Effective Period: 7/1/2014 - 6/30/2015
Wage Rate per Hour: \$15.03
Supplemental Benefit Rate per Hour: None

Secretary (various)

Effective Period: 7/1/2014 - 6/30/2015
Wage Rate per Hour: \$19.31

OFFICE OF THE COMPTROLLER, CITY OF NEW YORK
§6-109 PREVAILING WAGE SCHEDULE

Supplemental Benefit Rate per Hour: None

Word Processor

Effective Period: 7/1/2014 - 6/30/2015

Wage Rate per Hour: \$18.49

Supplemental Benefit Rate per Hour: None

Overtime

Time and one half the regular hourly rate after 40 hours in any work week.

(Based on data from NYS Department of Labor Occupational Employment Statistics and US Department of Labor Bureau of Labor Statistics or NYC Administrative Code §6-109)

WINDOW CLEANER

For the above building service classification, see the Labor Law Section 230 Schedule.



Leonard A. Mancusi
SENIOR ASSISTANT COMPTROLLER

THE CITY OF NEW YORK
OFFICE OF THE COMPTROLLER
1 CENTRE STREET ROOM 1120
NEW YORK, N.Y. 10007-2341

TELEPHONE: (212) 669-6666
FAX NUMBER: (212) 669-6666

ALAN G. HEVESI
COMPTROLLER

MEMORANDUM

November 6, 2000

To Agency Chief Contracting Officers

From: Leonard A. Mancusi

Re: Security at Construction Sites

Prior to the enactment of Administrative Code §6-109, security guards on construction sites were not subject to prevailing wages. Security guards under the New York State labor law are covered under §230 which provides that prevailing wages are to be paid for security guards in existing buildings. §6-109 of the Administrative Code which was enacted in 1996 closed this loophole by including all security guards working pursuant to a city contract as a prevailing wage trade.

Although some construction contract boilerplate language has been amended to include §6-109, sub-contractors performing security services have advised us that they were not aware of this provision and, since traditionally, security guards were not a covered trade on construction sites, and they were not advised by a prime contractor that they would have to pay prevailing wages, they have not been doing so.

To avoid the possibility of issuing stop payments against prime contractors for the failure of their security service sub-contractors to pay

prevailing wages, we suggest that you write to all your existing security guard sub-contractors and their primes and in the future, upon approval of a security guard sub-contractor, advise the contractors of their obligation to pay prevailing wages under §6-109 of the Administrative Code.

As always, your cooperation is appreciated.

-LAM:er
ACCO.SECURITY AT SITES





NEW YORK CITY DEPARTMENT OF
DESIGN + CONSTRUCTION

**INFRASTRUCTURE DIVISION
BUREAU OF DESIGN**

VOLUME 2 OF 3

Contractor.

Dated _____, 20__

**APPROVED AS TO FORM
CERTIFIED AS TO LEGAL AUTHORITY**

Acting Corporation Counsel

Dated _____, 20__





NEW YORK CITY DEPARTMENT OF
DESIGN + CONSTRUCTION

**INFRASTRUCTURE DIVISION
BUREAU OF DESIGN**

VOLUME 2 OF 3

PROJECT ID: HWPEDSF1

MULTI-SITE PEDESTRIAN SAFETY
WHICH INCLUDES THE FOLLOWING INTERSECTIONS:

- 31ST STREET AND 39TH AVENUE
- 31ST STREET AND 36TH AVENUE
- 31ST STREET AND BROADWAY

INCLUDING BUS BULBOUTS, CURB EXTENSIONS, BUS PADS,
PEDESTRIAN RAMPS, CATCH BASINS, PAVEMENT MARKINS,
STREET LIGHTING, AND TRAFFIC SIGNAL WORK

Together With All Work Incidental Thereto
BOROUGH OF QUEENS
CITY OF NEW YORK

J. Pizzirusso Landscaping Corp.
Contractor.

Dated _____, 20____

APPROVED AS TO FORM
CERTIFIED AS TO LEGAL AUTHORITY

[Signature]
Acting Corporation Counsel

12-5-14
JP

Dated December 5, 2014



**THE CITY OF NEW YORK
DEPARTMENT OF DESIGN AND CONSTRUCTION
DIVISION OF INFRASTRUCTURE**

30-30 THOMSON AVENUE
LONG ISLAND CITY, NEW YORK 11101-3045
TELEPHONE (718) 391-1000
WEBSITE www.nyc.gov/buildnyc

VOLUME 3 OF 3

**SCHEDULE A
ADDENDA NOS. 1 TO 4**

FOR FURNISHING ALL LABOR AND MATERIALS NECESSARY AND REQUIRED FOR

PROJECT ID: HWPEDSF1

**MULTI-SITE PEDESTRIAN SAFETY
WHICH INCLUDES THE FOLLOWING INTERSECTIONS:**

**31ST STREET AND 39TH AVENUE
31ST STREET AND 36TH AVENUE
31ST STREET AND BROADWAY**

**INCLUDING BUS BULBOUTS, CURB EXTENSIONS, BUS PADS,
PEDESTRIAN RAMPS, CATCH BASINS, PAVEMENT MARKINGS,
STREET LIGHTING, AND TRAFFIC SIGNAL WORK**

**Together With All Work Incidental Thereto
BOROUGH OF QUEENS
CITY OF NEW YORK**

FOR THE DEPARTMENT OF TRANSPORTATION
PREPARED BY
THE RBA GROUP

OCTOBER 22, 2014

NYS DOT PIN X772.58
Fed. Aid Project No. _____

Bid Opening 11:00 A.M. on
Location 1st Floor Bid Room, 30-30 Thomson Ave., Long Island City, N.Y. 11101

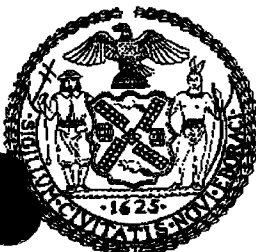

5-074



SPECIFICATIONS AND STANDARDS OF NEW YORK CITY

The following New York City Department of Transportation (NYCDOT) reference documents are available on-line at:

http://www.nyc.gov/html/ddc/html/pubs/pubs_infrastdts.shtml or for purchase between 9:00 A.M. and 3:00 P.M. at 55 Water St., Ground Floor, NYC, N.Y. 10041. Contact: Ms Vivian Valdez, Tel. (212) 839-9434

1. NYCDOT Standard Highway Specifications, November 1, 2010
2. NYCDOT Standard Highway Details of Construction, July 1, 2010
3. NYCDOT Division of Street Lighting Specifications
4. NYCDOT Division of Street Lighting Standard Drawings
5. NYCDOT Standard Specifications for Traffic Signals
6. NYCDOT Standard Drawings for Traffic Signals

The following reference documents for New York City Department of Environmental Protection (NYCDEP) are available on-line at:

http://www.nyc.gov/html/ddc/html/pubs/pubs_infrastdts.shtml or for pick up between 8:00 A.M. and 4:00 P.M. at 30-30 Thomson Avenue, 3rd Floor, Division of Infrastructure, Long Island City, N.Y. 11101. Contact: Mr. Waqar Ahmad, Tel. (718) 391-2056

1. NYCDEP Standard Sewer and Water Main Specifications, July 1, 2014
2. NYCDEP Instructions for Concrete Specifications, Jan. 92
3. NYCDEP General Specification 11-Concrete, November 1991
4. NYCDEP Sewer Design Standards, (September 2007) Revised January 2009

The following reference documents for New York City Department of Environmental Protection (NYCDEP) are available on-line at:

http://www.nyc.gov/html/ddc/html/pubs/pubs_infrastdts.shtml or for pick up between 8:00 A.M. and 4:00 P.M. at 30-30 Thomson Avenue, 3rd Floor, Division of Infrastructure, Long Island City, N.Y. 11101. Contact: Mr. Robert Kuhlmann, Tel. (718) 391-2145

1. NYCDEP Water Main Standard Drawings
2. Specifications for Trunk Main Work, dated July 2014
3. Standards for Green Infrastructure, latest version, available only on-line at: http://www.nyc.gov/html/dep/pdf/green_infrastructure/bioswales-standard-designs.pdf

Water main work material specifications are available at the Department of Environmental Protection, 59-17 Junction Boulevard, 3rd Floor Low-Rise Building, Flushing, N.Y. 11373-5108.

Contact: Mr. Tarlock Sahansra, P.E., Tel. (718) 595-5302
E-mail: TSAHANSRA@DEP.NYC.GOV

Standard Specifications and Drawings for Fire Department Communications facilities of New York City are available at 87 Union Street, Engineering Office, Brooklyn, N.Y. 11231-1416.

Contact: Mr. Ed Durkin, Tel. (718) 624-3752

Tree Planting Standards of the City of New York Parks & Recreation are available at the following Department of Parks & Recreation website:

<http://www.nycgovparks.org/pagefiles/53/Tree-Planting-Standards.pdf>

SPECIFICATIONS AND STANDARDS OF PRIVATE UTILITIES

The Following reference document for Private Utility Work is available for pick up between 8:30 A.M. and 4:00 P.M. at 30-30 Thomson Avenue, First Floor Bid Procurement Room, L.I.C., N.Y. 11101.

1. CET SPECIFICATIONS AND SKETCHES dated November 2010

(NO TEXT ON THIS PAGE)

SCHEDULE A**(GENERAL CONDITIONS TO CONSTRUCTION CONTRACT
(INCLUDING GENERAL CONDITIONS RELATED TO ARTICLE 22 – INSURANCE)****PART I. REQUIRED INFORMATION**

<p align="center"><u>INFORMATION FOR BIDDERS SECTION 26 BID SECURITY</u></p> <p><u>The Contractor shall obtain a bid security in the amount indicated to the right.</u></p>	See Attachment 1 (page A-1 of the Bid Booklet).
<p align="center"><u>INFORMATION FOR BIDDERS SECTION 26 PERFORMANCE AND PAYMENT BONDS</u></p> <p><u>The Contractor shall obtain performance and payment bonds in the amount indicated to the right.</u></p>	See Attachment 1 (page A-1 of the Bid Booklet).
<p align="center"><u>CONTRACT ARTICLE 14. DATE FOR SUBSTANTIAL COMPLETION</u></p> <p><u>The Contractor shall substantially complete the Work in the number of calendar days indicated to the right.</u></p>	See Page SA-4
<p align="center"><u>CONTRACT ARTICLE 15. LIQUIDATED DAMAGES</u></p> <p><u>If the Contractor fails to substantially complete the Work within the time fixed for substantial completion plus authorized time extensions or if the Contractor, in the sole determination of the Commissioner, has abandoned the Work, the Contractor shall pay to the City the amount indicated to the right.</u></p>	\$ <u>900</u> for each consecutive calendar day over substantial completion time
<p align="center"><u>CONTRACT ARTICLE 17. SUB-CONTRACTOR</u></p> <p><u>The Contractor shall not make subcontracts totaling an amount more than the percentage of the total Contract price indicated to the right.</u></p>	Not to exceed <u>50</u> % of the Contract price
<p align="center"><u>CONTRACT ARTICLE 21. RETAINAGE</u></p> <p><u>The Commissioner shall deduct and retain until the substantial completion of the Work the percent value of the Work indicated to the right.</u></p>	<u>0</u> % of the value of the Work

<p align="center"><u>CONTRACT ARTICLE 22.</u> <u>(Per Directions Below)</u></p>	<p>See pages SA-5 through SA-11</p>
<p align="center"><u>CONTRACT ARTICLE 24.</u> <u>DEPOSIT GUARANTEE</u></p> <p>As security for the faithful performance of its obligations, the Contractor, upon filing its requisition for payment on Substantial Completion, shall deposit with the Commissioner a sum equal to the percentage of the Contract price indicated to the right.</p>	<p>1% of Contract price</p>
<p align="center"><u>CONTRACT ARTICLE 24.</u> <u>PERIOD OF GUARANTEE</u></p> <p>Periods of maintenance and guarantee other than the period set forth in Article 24.1 are indicated to the right.</p>	<p>Eighteen (12) Months, excluding Trees Twenty-four (24) Months for Tree Planting</p>
<p align="center"><u>CONTRACT ARTICLE 74.</u> <u>STATEMENT OF WORK</u></p> <p>The Contractor shall furnish all labor and materials and perform all Work in strict accordance with the Contract Drawings, Specifications, and all Addenda thereto.</p>	<p>See Contract Article 74</p>
<p align="center"><u>CONTRACT ARTICLE 75.</u> <u>COMPENSATION TO BE PAID TO CONTRACTOR</u></p> <p>The City shall pay and the Contractor shall accept in full consideration for the performance of the Contract, subject to additions and deductions as provided in Contract Article 75, this said sum being the amount at which the Contract was awarded to the Contractor at a public letting thereof, based upon the Contractor's bid for the Contract.</p>	<p>See Contract Article 75</p>
<p align="center"><u>CONTRACT ARTICLE 78.</u> <u>PARTICIPATION BY MINORITY-OWNED AND WOMEN-OWNED BUSINESS ENTERPRISES IN CITY PROCUREMENT</u></p>	<p>See M/WBE Utilization Plan in the Bid Booklet</p>

<p style="text-align: center;"><u>STANDARD HIGHWAY SPECIFICATIONS</u> <u>SECTION 6.40</u> <u>LIQUIDATED DAMAGES FOR</u> <u>ENGINEER'S FIELD OFFICE</u></p> <p>If the Contractor fails to satisfactorily provide the field office and all equipment specified in Section 6.40 - Engineer's Field Office, and/or if a cited deficiency exceed seventy two (72) hours after notice from the Engineer in writing, or is permitted to recur, liquidated damages will be assessed in the amount specified herein for each subsequent calendar day or part thereof that a cited deficiency resulting in nonpayment, as described in Section 6.40.5, is not corrected.</p>	<p>\$ <u>250.00</u> for each calendar day of deficiency</p>
<p style="text-align: center;"><u>STANDARD HIGHWAY SPECIFICATIONS</u> <u>SECTION 6.70</u> <u>LIQUIDATED DAMAGES FOR</u> <u>MAINTENANCE AND PROTECTION OF TRAFFIC</u></p>	<p>\$ <u>250.00</u> for each instance of failure to comply with the Maintenance and Protection of Traffic requirements within three (3) hours after written notice from the Engineer</p> <p>\$ <u>500.00</u> for each and every hour of failing to open the entire width of roadway to traffic the morning following a night/weekend work operation</p>
<p style="text-align: center;"><u>STANDARD HIGHWAY SPECIFICATIONS</u> <u>SECTION 7.13</u> <u>LIQUIDATED DAMAGES FOR</u> <u>MAINTENANCE OF SITE</u></p> <p>If the Contractor fails to comply, within three (3) consecutive hours after written notice from the Engineer, with the requirements of Section 7.13 - Maintenance of Site, the Contractor shall pay to the City of New York, until such notice has been complied with or rescinded, the sum specified above per calendar day, for each instance of such failure, as liquidated damages and not as a penalty, for such default.</p>	<p>\$ <u>250.00</u> for each calendar day, for each occurrence</p>

Date for Substantial Completion (Reference: Article 14)

The Contractor shall substantially complete the Work within the Final Contract Duration determined in accordance with the terms and conditions set forth herein.

The Base Contract Duration for this project is 365 consecutive calendar days ("ccds").

The Final Contract Duration shall be the Base Contract Duration when a check mark is indicated before the word "NO", below, and shall be the Base Contract Duration adjusted by the table set forth below when a check mark is indicated before the word "YES", below.

YES NO

When the Final Contract Duration is indicated above to be adjusted by the table below, the table may increase the Base Contract Duration depending on the date of scheduled substantial completion to avoid a scheduled substantial completion of the Work during the winter months. The date of scheduled substantial completion shall be determined by adding the Base Contract Duration to the date specified to commence work in the written Notice to Proceed. The Final Contract Duration shall then be determined as follows:

- (a) Find the row that corresponds to the month of substantial completion based on the Base Contract Duration added to the date specified to commence work in the written Notice to Proceed.
- (b) Find the number of days to be added to the Base Contract Duration in the table below. Add that number of days to the Base Contract Duration to obtain the Final Contract Duration in consecutive calendar days.

Month of Substantial Completion based on the Base Contract Duration	Number of Days of adjustment
January	150
February	120
March	90
April	60
May	30
June	0
July	0
August	0
September	0
October	0
November –December 15	0
December 16 – December 31	180

In addition, should Item No. 9.30, "Storm Water Pollution Prevention," exist in the Contract and the required Storm Water Pollution Prevention Plan (SWPPP) does not conform to NYSDEC's recommended Standards, an additional 60 ccd shall be added to the above Final Contract Duration.

(GENERAL CONDITIONS RELATING TO ARTICLE 22 – INSURANCE)**PART II. TYPES OF INSURANCE, MINIMUM LIMITS AND SPECIAL CONDITIONS**

Note: All certificate(s) of insurance submitted pursuant to Contract Article 22.3.3 must be accompanied by a Certification by Broker consistent with Part III below and include the following information:

- For each insurance policy, the name and NAIC number of issuing company, number of policy, and effective dates;
- Policy limits consistent with the requirements listed below;
- Additional insureds or loss payees consistent with the requirements listed below; and
- The number assigned to the Contract by the City (in the “Description of Operations” field).

Insurance indicated by a blackened box (■) or by X in a □ to left will be required under this contract

Types of Insurance (per Article 22 in its entirety, including listed paragraph)	Minimum Limits and Special Conditions
■ Commercial General Liability Art. 22.1.1	<p>The minimum limits shall be \$ <u>3,000,000</u> per occurrence and \$ <u>6,000,000</u> per project aggregate applicable to this Contract.</p> <p>Additional Insureds:</p> <ol style="list-style-type: none"> 1. City of New York, including its officials and employees, with coverage at least as broad as ISO Form CG 20 10 and CG 20 37, and 2. All person(s) or organization(s), if any, that Article 22.1.1(b) of the Contract requires to be named as Additional Insured(s), with coverage at least as broad as ISO Form CG 20 26. The Additional Insured endorsement shall either specify the entity’s name, if known, or the entity’s title (e.g., Project Manager). 3. The New York City Transit Authority (NYCTA), Manhattan and Bronx Surface Transit Operation Authority (MaBSTOA), Staten Island Rapid Transit Operation Authority (SIRTOA), Metropolitan Transportation Authority (MTA), its subsidiaries and affiliated companies. The Contractor shall furnish two (2) certificates of insurance to and the policy shall be endorsed to provide thirty (30) days advance notice to the Director, Risk Management, MTA Risk and Insurance Management Standards, Enforcement and Claims Unit, 2 Broadway, 21st Floor, New York, NY 10004, of any material change and/or cancellation. 4. New York State, including its officials and employees, 5. FHWA, including its officials and employees.

<input checked="" type="checkbox"/> Workers' Compensation	Art. 22.1.2	<p>Workers' Compensation, Employers' Liability, and Disability Benefits Insurance: Statutory per New York State law without regard to jurisdiction.</p> <p>Note: The following forms are acceptable: (1) New York State Workers' Compensation Board Form No. C-105.2, (2) State Insurance Fund Form No. U-26.3, (3) New York State Workers' Compensation Board Form No. DB-120.1 and (4) Request for WC/DB Exemption Form No. CE-200. The City will not accept an ACORD form as proof of Workers' Compensation or Disability Insurance.</p> <p>Jones Act and U.S. Longshoremen's and Harbor Workers' Compensation Act: Statutory per U.S. Law.</p> <p><input checked="" type="checkbox"/> Additional Requirements:</p> <p>(1) NYCT "OUTSIDE CONTRACT" INSURANCE REQUIREMENTS: Workers' Compensation Insurance (including Employer's Liability Insurance) with limits of not less than \$2,000,000, which limit may be met by a combination of primary and excess insurance meeting the statutory limits of New York State.</p> <p>(2) Two (2) certificates of such insurance shall be furnished to the Director, Risk Management, MTA Risk and Insurance Management Standards, Enforcement and Claims Unit, 2 Broadway, 21st Floor, New York, NY 10004.</p>
<input checked="" type="checkbox"/> Disability Benefits Insurance	Art. 22.1.2	
<input checked="" type="checkbox"/> Employers' Liability	Art. 22.1.2	
<input type="checkbox"/> Jones Act	Art. 22.1.3	
<input type="checkbox"/> U.S. Longshoremen's and Harbor Workers Compensation Act	Art. 22.1.3	

<input type="checkbox"/> Builders' Risk	Art. 22.1.4	<p>100 % of total value of Work</p> <p>Contractor the Named Insured; the City both an Additional Insured and one of the loss payees as its interests may appear.</p> <p>If the Work does not involve construction of a new building or gut renovation work, the Contractor may provide an installation floater in lieu of Builders Risk insurance.</p> <p>Note: Builders Risk Insurance may terminate upon Substantial Completion of the Work in its entirety.</p>
<input checked="" type="checkbox"/> Commercial Auto Liability	Art. 22.1.5	<p>\$ <u>2,000,000</u> per accident combined single limit</p> <p>If vehicles are used for transporting hazardous materials, the Contractor shall provide pollution liability broadened coverage for covered vehicles (endorsement CA 99 48) as well as proof of MCS 90</p> <p>Additional Insureds:</p> <ol style="list-style-type: none"> (1) City of New York, including its officials and employees, and (2) The New York City Transit Authority (NYCTA), Manhattan and Bronx Surface Transit Operation Authority (MaBSTOA), Staten Island Rapid Transit Operation Authority (SIRTOA), Metropolitan Transportation Authority (MTA), its subsidiaries and affiliated companies. (3) New York State, including its officials and employees, and, (4). FHWA, including its officials and employees.

<input type="checkbox"/> Contractors Pollution Liability Art. 22.1.6	\$ _____ per occurrence \$ _____ aggregate Additional Insureds: 1. City of New York, including its officials and employees, and 2. _____ 3. _____
<input type="checkbox"/> Marine Protection and Indemnity Art. 22.1.7(a)	\$ _____ each occurrence \$ _____ aggregate Additional Insureds: 1. City of New York, including its officials and employees, and 2. _____ 3. _____
<input type="checkbox"/> Hull and Machinery Insurance Art. 22.1.7(b)	\$ _____ per occurrence \$ _____ aggregate Additional Insureds: 1. City of New York, including its officials and employees, and 2. _____ 3. _____
<input type="checkbox"/> Marine Pollution Liability Art. 22.1.7(c)	\$ _____ per occurrence \$ _____ aggregate Additional Insureds: 1. City of New York, including its officials and employees, and 2. _____ 3. _____

[OTHER]

Art. 22.1.8

■ Railroad Protection Liability Policy

(ISO-RIMA or equivalent form) approved by Permitter covering the work to be performed at the designated site and affording protection for damages arising out of bodily injury or death, physical damage to or destruction of property, including damage to the Insured's own property and conforming to the following:

- Policy Endorsement CG 28 31 - Pollution Exclusion Amendment is required to be endorsed onto the policy when environmental-related work and/or exposures exist.
- Indicate the Name and address of the Contractor to perform the work, the Contract # and the name of the railroad property where the work is being performed and the Agency Permit.
- Evidence of Railroad Protective Liability Insurance, must be provided in the form of the Original Policy. A detailed Insurance Binder (ACORD or Manuscript Form) will be accepted pending issuance of the Original Policy, which must be provided within 30 days of the Binder Approval.

\$ 2,000,000 per occurrence

\$ 6,000,000 annual aggregate

Named Insureds:

1. New York City Transit Authority (NYCTA), the Manhattan and Bronx Surface Transit Operation Authority (MaBSTOA), the Staten Island Rapid Transit Operation Authority (SIRTOA), MTA Capital Construction Co., the Metropolitan Transportation Authority (MTA) including its subsidiaries and affiliates, and the City of New York (as Owner) and all other indemnified parties.

[OTHER]

Art. 22.1.8

Professional Liability

- A. The Contractor's Professional Engineer shall maintain and submit evidence of Professional Liability Insurance in the minimum amount of \$1,000,000 per claim. The policy or policies shall include an endorsement to cover the liability assumed by the Contractor under this Contract arising out of the negligent performance of professional services or caused by an error, omission or negligent act of the Contractor's Professional Engineer or anyone employed by the Contractor's Professional Engineer.
- B. Claims-made policies will be accepted for Professional Liability Insurance. All such policies shall have an extended reporting period option or automatic coverage of not less than two (2) years. If available as an option, the Contractor's Professional Engineer shall purchase extended reporting period coverage effective on cancellation or termination of such insurance unless a new policy is secured with a retroactive date, including at least the last policy year.

[OTHER]

Art. 22.1.8

Engineer's Field Office

Section 6.40, Standard Highway Specifications

Fire insurance, extended coverage and vandalism, malicious mischief and burglary, and theft insurance coverage in the amount of \$40,000

[OTHER]

Art. 22.1.8

The Following Additional Insurance Must Be Provided:

Umbrella/Excess Liability Insurance - The Contractor shall provide Umbrella/Excess Liability Insurance in the minimum amount of \$10,000,000 per Occurrence and \$10,000,000 in Aggregate. The policy terms and condition should be at least as broad as the underlying policies. The underlying policies should comply with the insurance provision as outlined by the contract. Defense cost should be in addition to the limit of liability. The City of New York, including its officials and employees, should be included as additional insured as respects to the noted project.

SCHEDULE A

(GENERAL CONDITIONS TO CONSTRUCTION CONTRACT)

PART IV. ADDRESS OF COMMISSIONER

Wherever reference is made in Article 7 or Article 22 to documents to be sent to the **Commissioner** (e.g., notices, filings, or submissions), such documents shall be sent to the address set forth below or, in the absence of such address, to the **Commissioner's** address as provided elsewhere in this **Contract**.

DDC Director, Insurance Risk Manager

30 – 30 Thomson Avenue, 4th Floor (IDCNY Building)

Long Island City, NY 11101

ATTACH TO CONTRACT DOCUMENTS

THE CITY OF NEW YORK
DEPARTMENT OF DESIGN AND CONSTRUCTION
INFRASTRUCTURE DIVISION
BUREAU OF DESIGN

PROJECT ID: HWPEDSF1

MULTI-SITE PEDESTRIAN SAFETY
WHICH INCLUDES THE FOLLOWING INTERSECTIONS:

31ST STREET AND 39TH AVENUE
31ST STREET AND 36TH AVENUE
31ST STREET AND BROADWAY

INCLUDING BUS BULBOUTS, CURB EXTENSIONS, BUS PADS,
PEDESTRIAN RAMPS, CATCH BASINS, PAVEMENT MARKINS,
STREET LIGHTING, AND TRAFFIC SIGNAL WORK

Together With All Work Incidental Thereto
BOROUGH OF QUEENS
CITY OF NEW YORK

ADDENDUM NO. 1

DATED: February 24, 2014

THIS ADDENDUM IS HEREBY MADE A PART OF THE CONTRACT DOCUMENTS

The New York City Department of Transportation Standard Highway Specifications, dated November 1, 2010, (which include, but are not limited to, "General Conditions", "Basic Materials of Construction", "Combined Materials of Construction", "Construction Methods", "Inspection and Testing of Materials, Adjustments for Deficiencies, and Maintenance", and "Supplemental Construction Methods"), as modified by addenda issued prior to the opening of bids, shall apply to and become a part of the contract.

All references contained herein are to the New York City Department of Transportation, Standard Highway Specifications, dated November 1, 2010. The said Specifications are hereby revised. Included hereunder are the following REVISIONS:

1. Amendments to Standard Highway Specifications, Volume I
2. Amendments to Standard Highway Specifications, Volume II, including Section 7.88 (Revised) and new Sections 6.44 PO and 6.52 CG.
3. New Sections
4. Special Provisions

1. AMENDMENTS TO STANDARD HIGHWAY SPECIFICATIONS, VOLUME I

The following amendments to the Contract Requirements shall become a part of and apply to the contract:

[Added 12-09-2010]

1. Refer to Page 15, **Subsection 1.06.23.(C) CONFORMANCE WITH FEDERAL, STATE AND CITY AGENCIES;**

Add the following new paragraphs:

"The Contractor is notified that all vehicles that are owned, leased or operated by the Contractor or its subcontractors and used in connection with the Project shall comply with the following requirement:

Every truck, tractor, and tractor-trailer or semitrailer combination, having a gross vehicle weight rating of twenty-six thousand pounds or more, and a conventional cab configuration in which more than half of the engine length is forward of the foremost point of the windshield base, and the steering wheel hub is in the forward quarter of the vehicle length shall be equipped with a convex mirror on the front of such vehicle or combination of vehicles. Such convex mirror shall be adjusted so as to enable the operator of such vehicle or combination of vehicles to see all points on an imaginary horizontal line which is three feet above the road, is one foot directly forward from the midpoint of the front of such vehicle or combination of vehicles, and extends the full width of the front of such vehicle or combination of vehicles.

Any vehicle that does not comply with this provision may be prohibited from entering the Project site and/or supplying equipment or materials to the Project. The Contractor shall not be entitled to any damages as a result of such prohibition."

[Added 01-09-2011]

2. Refer to Page 240, **Subsection 4.16.5.(B) STUMP REMOVAL;**
Delete **Subsection 4.16.5.(B) STUMP REMOVAL**, in its entirety;
Substitute the following revised **Subsection 4.16.5.(B)**:

"(B) STUMP REMOVAL

1. Tree stumps designated to be removed and their roots shall be completely excavated to a minimum depth of three (3) feet below the existing grade. A portable stump cutter may be required in some locations. It may be necessary to remove concrete, asphalt, pavers, and/or other types of material surrounding the base of the stump. All excess debris, including chips from tree stumps, shall be removed and disposed of by the Contractor, away from the site prior to backfilling and the area shall be restored by completion of the workday, to the satisfaction of the Engineer. The disposal of tree stumps by burning in open fires will not be permitted.

2. All voids and excavations left after the removal of the stump and roots shall be backfilled to grade with clean earth fill. Fill shall be placed and compacted to a minimum of 95 percent of Standard Proctor Maximum Density by acceptable methods to the satisfaction of the Engineer. Where paving blocks exist, they are to be reset to the existing grade as directed.

3. Maximum safety and care must be used by Contractor during stump removal. The Contractor shall carefully protect against damage all existing trees, plants, curbs, sidewalks and utilities and other features to remain. The Contractor is responsible for locating and protecting underground utilities from damage during stump removal procedures. During stump grinding operations, plywood must be used to protect adjacent vehicles, real property, and pedestrians. If, when removing stumps, existing sidewalks or curbs are disturbed, the Contractor shall restore and/or reset these sidewalks and curbs, at no additional cost to the City. Restoration work shall be done to match the existing, to the satisfaction of the Engineer. All damaged trees, curbs, sidewalks, real property, vehicles and utilities must be addressed within three (3) days."

[Added 04-18-2011]

3. Refer to Pages 218 and 219, **Subsection 4.13.4.(H) PIGMENT;**
Delete the first three (3) paragraphs on page 219:
Substitute the following revised three (3) paragraphs:

"Where the color of the concrete is required to simulate the color of dark gray bluestone, the concrete shall be integrally pigmented to produce a gray color equivalent to: Davis Colors No. 884-3%; Lansco Color No. 437 "Strong Black" 5 lbs. per 94 lbs. Light Grey Portland Cement and 3 parts sand; L.M. Scofield "Cool Black No. 4"; Bayferrox Limestone 330, 2 lbs. per 94 lbs. Light Gray Portland Cement; or an approved equivalent, unless otherwise specified.

Where the color of the concrete is required to simulate the color of light to medium gray granite, the concrete shall be integrally pigmented to produce a gray color equal to: Davis Colors No. 884-1%; Lansco Color No. 437 "Strong Black" 2.5 lbs. per 94 lbs. Light Grey Portland Cement and 3 parts sand; L.M. Scofield "Cool Black No. 1"; Bayferrox Silver 330, 1 lb. per 94 lbs. Light Gray Portland Cement; or an approved equivalent, unless otherwise specified.

Where the sidewalk is designated to have a saw cut joint finish the color of the concrete shall be integrally pigmented to produce a gray color equivalent to L.M. Scofield "Landmarks Grey" K-157-4; L.M. Scofield "Cool Black No. 4"; Davis Colors No. 884-3%; Lansco Color No. 437 "Strong Black" 5 lbs. per 94 lbs. Light Grey Portland Cement and 3 parts sand; Bayferrox NYC Landmark Commission Gray, 3.5 lbs. per 94 lbs. Light Gray Portland Cement; or an approved equivalent, unless otherwise specified."

[Added 07-01-2011]

4. Refer to Page 14, **Subsection 1.06.23.(A) PERMITS;**
Delete line (b) under the first paragraph;
Substitute the following text:

"(b) Any planned work requiring a DOT Construction Permit that may potentially be within 100 feet of a bridge structure will be placed on a Bridge Hold. If any proposed work is within 100 feet of a bridge structure, permittees must submit a scaled drawing showing the work and exact location, along with the following:

- Plan layout of the project area.
- The scope of work.
- The contractor's means and methods.
- Indicate if work will be done of the bridge itself or its abutments, and the type of work.

If the work is more than 100 feet away from the bridge structure, permittees may send a certification by e-mail stating so. Either response must be sent to the Division of Bridges at bridgeshold@dot.nyc.gov for review and release prior to commencing work. Emergency work will not be placed on hold and shall proceed in accordance with the New York City Highway Rules, section 2-11 (g);

(c) Permits from the Department of Sanitation for use of City landfills;"

[Added 07-27-2011]

5. Refer to Page 37, **Subsection 1.06.46.(A) 6. Sign Graphics;**
Delete article "a." beginning with the words "All visual components of the sign are in an Adobe *.pdf file, . . ." and ending with the words ". . . DDC to the Contractor (on a CD or via E-mail) for printing.", in its entirety;
Substitute the following revised article "a":

"a. All visual components of the sign are in an Adobe *.pdf file, which is provided by the Commissioner's representative. The file is not to be altered for composition, type font or image from the version provided by DDC. The Commissioner's representative shall provide a complete file with data and image. The digital file shall be provided by DDC to the Contractor (on a CD or via E-mail) for printing."

[Added 09-27-2012]

6. Refer to Page 36, **Subsection 1.06.46. Project Sign;**
Delete the words "Unless otherwise specified in the Special Provisions of the contract, the following shall apply:";
Substitute the following revised text:

"The Contractor is notified that he shall be required to furnish, install, maintain, and remove, when directed, Construction Project Information Signs (CPIS) as per Sec. 2-02(c)(4) and (5) of the NYC DOT Highway Rule and the cost shall be deemed included under all scheduled items of the contract. In addition, unless otherwise specified in the Special Provisions of the contract, the following Project Sign shall also apply:"

[Added 04-08-2013]

7. Refer to Page 200, **Subsection 4.11.2.(B), first paragraph, sixth line;**
Delete the word "porcelain,".

8. Refer to Page 201, **Subsection 4.11.3.(B) FILL AND BACKFILL, second and third paragraphs;**
Delete the second and third paragraphs under Subsection 4.11.3.(B), in their entirety;
Substitute the following revised two paragraphs:

"Glass or Recycled Porcelain Aggregate (RPA) from recycling facilities that meets the requirements of **Subsection 4.11.3.(E)** for Glass and **Subsection 4.11.3.(F)** for RPA shall be considered suitable material for mixing with fill provided the Contractor maintains the gradations specified herein. However, glass shall not be placed in contact with synthetic liners, geogrids, geotextiles or other geosynthetics.

Glass and/or RPA incorporated into fill shall be thoroughly mixed with other suitable material so that glass, RPA or combination of both constitutes no more than 30 percent by volume anywhere in the fill as visually determined by the Engineer."

9. Refer to Page 202, Subsection 4.11.3. (E) GLASS;
Add the following new Subsection 4.11.3. (F) RECYCLED PORCELAIN
AGGREGATE (RPA) :

“(F) RECYCLED PORCELAIN AGGREGATE (RPA)

All porcelain to be used as RPA shall be crushed by a New York City Department of Environmental Protection (NYCDEP) approved recycling facility to a maximum particle size of 3/8 inch and graded to meet the gradation specified above for use in either fill, backfill or select fill, as may be required. RPA from any other source will not be permitted. The NYCDEP approved recycling facility will also certify that the RPA being furnished is free from organic material and other unsuitable material.

Should the Contractor desire to use RPA in his fill or backfill material, he shall contact Mr. Vasy Kravchuk at NYCDEP (Tel. No. 718-595-7512) to determine the availability of RPA and from which recycling facility it can be obtained.

The Contractor shall be required to make arrangement with the recycling plant, at least two (2) weeks in advance of when he would need the material, to schedule the time, date and quantity available for pickup. The Contractor shall be required to furnish the recycling facility with a complete list of his trucks involved in transporting the material, which shall include the name of the registered owner (Contractor), Consumer Affairs or DOS Permit numbers, body license plate number, and truck volume. This information must be supplied to the facility prior to the start of picking up the RPA.

Weight ticket receipt slips given by the recycling facility to each truck driver picking up RPA shall be collected by the Contractor and given to the Engineer upon delivering fill or backfill material to the site that contains RPA, and the Contractor agrees and warrants that in obtaining the RPA that such material has originated only from a NYCDEP approved recycling plant and it has not been mixed with porcelain material from any other source.

The Contractor shall be required to transport said material from the approved recycling facility to his yard for storage and mixing with his fill material; however, there is not guarantee that the material will actually be available.

The Contractor is advised that there is no guarantee that RPA will in fact be available for his use from a NYCDEP approved recycling plant and he shall make no claim against the City for loss of anticipated profits should the material not be available upon request by the Contractor.

All excess RPA not used in the fill or backfill shall remain the property of the DDC Contractor.

The Contractor must comply with all rules and regulations of the Department of Transportation and the Department of Environmental Protections governing the use of RPA in its fill and backfill material.”

10. Refer to Pages 218 and 219, Subsection 4.13.4. (H) PIGMENTING,
first four paragraphs;
Delete the first four paragraphs under Subsection 4.13.4. (H), in
their entirety;
Substitute the following revised four paragraphs:

“Where pigmenting is specified, the concrete sidewalks shall be pigmented with an admixture complying with the requirements of **Section 2.19** and the following requirements:

‘Commercial Gray’: In commercial districts C4-4 through C4-7, C5 and C6, as defined in the Zoning Resolution of the City of New York, and in areas under the jurisdiction of the Lower Manhattan Development Corporation the color of the concrete shall be integrally pigmented to produce a gray color equivalent to L.M. Scofield ‘Landmarks Grey’ K-157-4; L.M. Scofield ‘Cool Black No. 4’; Davis Colors No. 884-3%; Lansco Color No. 437 ‘Strong Black’ 5 lbs. per 94 lbs. Light Grey Portland Cement and 3 parts sand; Bayferrox NYC Landmark Commission Gray, 3.5 lbs. per 94 lbs. Light Grey Portland Cement; or an approved equivalent, unless otherwise specified.

'Bluestone': Where the color of the concrete is required to simulate the color of dark gray bluestone, the concrete shall be integrally pigmented to produce a gray color equivalent to: Davis Colors No. 884-3%; Lansco Color No. 437 'Strong Black' 5 lbs. per 94 lbs. Light Grey Portland Cement and 3 parts sand; L.M. Scofield 'Cool Black No. 4'; Bayferrox Limestone 330, 2 lbs. per 94 lbs. Light Gray Portland Cement; or an approved equivalent, unless otherwise specified.

'Granite': Where the color of the concrete is required to simulate the color of light to medium gray granite, the concrete shall be integrally pigmented to produce a gray color equal to: Davis Colors No. 884-1%; Lansco Color No. 437 'Strong Black' 2.5 lbs. per 94 lbs. Light Grey Portland Cement and 3 parts sand; L.M. Scofield 'Cool Black No. 1'; Bayferrox Silver 330, 1 lb. per 94 lbs. Light Gray Portland Cement; or an approved equivalent, unless otherwise specified."

[Added 05-24-2013]

11. Refer to Page 14, **Subsection 1.06.23.(A) PERMITS**, first paragraph as modified by Article 4 on page A1-1b;
Add the following new text:

"(d) All necessary permits from the Department of Environmental Protection which may include, but are not limited to, permits for use of City water."

12. Refer to Page 14, **Subsection 1.06.23.(A) PERMITS**, second paragraph;
Add the following as the third paragraph:

"No fee permits for use of City water necessary to complete roadway pavement reconstruction project in conjunction with installation of sewers and/or water mains, will be issued by the Department of Environmental Protection. However, for all other type projects (such as installation of sidewalks, installation of pedestrian ramps, pavement milling, resurfacing, rehabilitation of retaining walls, and bridge reconstruction type projects) the Contractor will be required to obtain the water use permit at its own cost."

[Added 08-05-2013]

13. Refer to page 116, second paragraph up from the bottom of the page, first line;
Change the words "Concrete of Type IA and IIA shall have ..." to read "Concrete of Type IA, IIA and IIIA shall have ..."

[Added 09-04-2013]

14. Refer to page 100, **Subsection 3.01.3.(C)1.(c)**;
Delete the last two lines of text beginning with the words "The proportion of reclaimed asphalt pavement permitted within each mix ...";
Substitute the following sentence: "The proportion of reclaimed asphalt pavement permitted within each mix shall be not less than 30 percent for the top and bottom courses as per Local Law #71 of 2011."

15. Refer to page 110, **Subsection 3.05.2.(A), Table 3.05-I**;
Insert the following text at the bottom of **Table 3.05-I**:

"Note: The above proportions shown for non-High-Early mixes shall be modified by pozzolan substitutes as per **Subsection 3.05.4**."

16. Refer to page 112, **Subsection 3.05.3.(C)**, second paragraph;
Delete the second paragraph in its entirety;
Substitute the following paragraph:

"Water shall be potable and drawn from municipal water mains."

17. Refer to page 113, first line of text, beginning with the words
"condition making up one (1) cubic yard of concrete.";
Insert the following sentence between the words "condition making up one
(1) cubic yard of concrete." and "The range of water-cement ratio within which the ...":

"The calculated yield of the mix shall be within \pm 2% of the Theoretical (1) cubic yard."

18. Refer to Page 113, second paragraph beginning with the words "The
Contractor may substitute Portland cement . . .";
Delete the second paragraph under **Subsection 3.05.4.**, in its
entirety;

Substitute the following revised paragraph:

"With the exception of high-early strength concrete, the Contractor shall be required to substitute Portland cement with pozzolans (Fly Ash or GGBFS) such that the maximum amount of Portland cement per cubic yard of concrete does not exceed 400 pounds, and with the use of an approved non-corrosive, non-chloride admixture as required to obtain a minimum compressive strength of 3,000 psi in seven (7) days. For high-early strength concrete the Contractor may substitute Portland cement with pozzolans (Fly Ash or GGBFS), pound for pound, up to 20% (or up to 25% for tidal/sea water spray areas) of the weight of cement specified for any concrete mixture provided the Contractor can obtain a minimum compressive strength of 3,000 p.s.i. in three (3) days. The Contractor, immediately following but not later than eight weeks after the date of the Contractor's Notice to Proceed, shall file with the Engineer, Age-Strength data of the job mix he proposes to use for the various ambient temperatures anticipated during the period of concrete placement. This data shall be presented in both tabular and graphical form for those various ambient temperatures with a maximum setting period of seven (7) days for Class B-32 concrete or seventy-two (72) hours for High-Early Strength Concrete."

19. Refer to Page 115, **TABLE 3.05-III - INGREDIENT MATERIALS**;
Change in the third row, second column, the type of Portland
Cement from "Type III*" to read "Type II or Type III*"

20. Refer to page 132, **Subsection 3.06.3.(D)**;
Change the words "Water shall be drawn from mains owned by The City of New York." to
read "Water shall be potable and drawn from municipal water mains."

21. Refer to page 133, **Subsection 3.07.3.(D)**;
Change the words "Water shall be drawn from mains owned by or supplying water to The
City of New York." to read "Water shall be potable and drawn from municipal water
mains."

22. Refer to page 134, **Subsection 3.08.4.(D)**;
Change the words "Water shall be drawn from mains owned by or supplying water to The
City of New York." to read "Water shall be potable and drawn from municipal water
mains."

23. Refer to Page 166, **Subsection 4.05.2. (A)** ;
Delete **Subsection 4.05.2. (A)**, in their entirety;
Substitute the following revised **Subsection 4.05.2. (A)** :

“(A) Concrete Pavement shall be of the following types:

- Type 1--Non-reinforced
- Type 2--Reinforced (Unpigmented or pigmented if specified)
- Type 3--High Early Strength Reinforced (Unpigmented or pigmented if specified)

Type 2 and Type 3 pavements shall consist of a concrete surface course, which shall be unpigmented or pigmented if specified, laid on a concrete base course, which may or may not be pigmented at the Contractor's option, while the base course is still plastic, of the thickness shown on the Contract Drawings, with reinforcement placed between the surface and base courses.”

24. Refer to Page 166, **Subsection 4.05.3. (A)** ;
Insert the following new **Subsection 4.05.3. (A1)** :

“(A1) PIGMENTING

Where pigmenting is specified, the surface course of the concrete bus pad shall be pigmented with an admixture complying with Section 2.19 and the following requirements:

Where the color of the concrete is required to simulate the red color of the Red Bus Lane Pavement Overlay (Item 6.44 POR in Section 6.44 PO), the surface course concrete shall be integrally pigmented to produce a red color equivalent to Scofield's quarry red.

Except for the use of an air-entraining agent complying with ASTM Designation C 260 and water reducing admixtures complying with ASTM Designation C 494 used in combination with the Pigment Admixture as per the pigment manufacturer's instruction, no other admixtures (including, but not limited to, calcium chloride) shall be used unless stated in writing by the manufacturer of the Pigment Admixture to be of no consequence to the colorfastness of the concrete mixture and is approved by the Engineer.

All pigmented concrete at different locations shall be identical, unless otherwise directed. Variations in color/tint/hue will not be acceptable. Therefore, the same brand and type of cement and the same source and type of aggregate shall be used throughout the project.

Prior to the mix design being made, the cement intended for use shall be checked to determine that its lightness/darkness is similar to the cement used in the original approved sample. The Pigmented Admixture shall be added in the standard proportion specified by the manufacturer.”

25. Refer to Page 170, **Subsection 4.05.5. (A) GENERAL** ;
Insert the following two new paragraphs:

“For pigmented concrete, the Contractor shall within eight weeks of the notice to proceed, submit the name of its proposed roadway installer upon which his bid is based, along with their respective work history experience in placing pigmented concrete. The installer shall have documented experience in working with pigmented concrete.

Prior to making any field samples and the placing of any pigmented concrete, the Contractor, its concrete supplier, installer, cement producer, laboratory, the pigmented admixture's representative, and the Engineer shall meet and agree on the specifications and methods of handling the pigmented concrete.”

26. Refer to Page 183, **Subsection 4.05.9. PRICES TO COVER**, 4th line;
Insert in the fourth line, the words "pigment when specified" between the
words "specifications, including, but not limited to," and "furnishing and installing...":

27. Refer to Page 183, **Subsection 4.05.9. PRICES TO COVER**;
Insert the following two new Items to the list of Item Nos. at the
bottom of **Subsection 4.05.9**:

"4.05 ACP	REINFORCED CONCETE PAVEMENT (BUS STOPS)(PIGMENTED)	C.Y.
4.05 AXP	HIGH-EARLY STRENGTH REINFORCED CONCRETE PAVEMENT (BUS STOPS)(PIGMENTED)	C.Y."

2. AMENDMENTS TO STANDARD HIGHWAY SPECIFICATIONS, VOLUME II

[Added 01-25-2012]

1. Refer to Pages 365 and 366, **Subsection 6.40.2.(C)(c)(1) Personal Computer(s) - Workstation Configuration;**

Delete the text under **Subsections (a), (b), (c), (d), (h), (i), and (m)**, in their entirety;

Substitute the following revised text:

- "(a) Make and Model: Dell; HP; Gateway; Acer; or, an approved equivalent. (Note: an approved equivalent requires written approval of the Assistant Commissioner of ITS.)
- (b) Processor: i5-2400 (6MB Cache, 3.1GHz) or faster computer - Single Processor.
- (c) System Ram: Minimum of 4GB (Gigabytes) Dual Channel DDR3 SDRAM at 1333MHz - 2 DIMMSs
- (d) Hard Disk Drive(s): 500 GB (Gigabytes) Serial ATA (7200RPM) w/DataBurst Cache, or larger."
- "(h) Video Display Card: HD Graphics (VGA, HDMI) with a minimum of 64 MB of RAM.
- (i) Monitor: 22" W, 23.0 Inch VIS, Widescreen, VGA/DVI LCD Monitor."
- "(m) Software Requirements: Microsoft Windows 7 Professional SP1, 64 bit; Microsoft Office Professional 2010; Microsoft Project 2010; Adobe Acrobat reader; Anti-Virus software package with 2 year updates subscription; and, either Auto Cad 2012 LT or Microsoft Visio 2010 Standard Edition, as directed by the Engineer."

- ~~2. Refer to Page 366, **Subsection 6.40.2.(C)(c)(2)(b)**;~~

~~Delete the text under **Subsection (b)**, which begins with the words
"(b) One (1) 600 DPI HP Laser Jet . . .", in its entirety;~~

~~Substitute the following revised text:~~

- ~~"(b) One (1) 600 DPI HP Color Laser Jet all-in-one Printer/Scanner/Copier/Fax (twelve (12) pages per minute or faster) with one (1) Extra Paper Tray (Legal Size) networked to all office computers."~~

3. Refer to Page 367, **Subsection 6.40.3. SPECIFIC REQUIREMENTS FOR ENGINEERS FIELD OFFICE (TYPE A, B, C, CU, D OR DU)**, first paragraph;
Delete the text in the first paragraph of **Subsection 6.40.3.**, in its entirety;
Substitute the following revised text:

6.40.3. SPECIFIC REQUIREMENTS FOR ENGINEER'S FIELD OFFICE (TYPE A, B, C, CU, D, OR DU). In addition to the general requirements, each type of Field Office shall have the minimum floor area indicated in Table 6.40-1 calculated based on usable area only, excluding any loss factors. Loss factors are defined as those areas such as lobby, sidewalk window ledge, elevator shafts and stairways. The Contractor shall provide and maintain furnishings for each type of Field Office in the quantity specified in Table 6.40-1. The furnishings shall be new or used equipment satisfactory to the Engineer:

4. Refer to Page 368, TABLE 6.40-I, ADDITIONAL REQUIREMENTS SPECIFIC REQUIREMENTS;
Delete the requirements for a Photocopy Machine shown in the 15th row of TABLE 6.40-I, in its entirety;
Substitute the following revised requirements:

Photocopying Machine – Stand-alone, heavy duty, electric, dry-process color photocopying type with a minimum production rate of 70 pages per minute and an adequate supply of copy paper, toner, etc. The machine shall be capable of duplex copying paper sizes of 8-1/2 x 11 inches, 8-1/2 x 14 inches and 11 x 17 inches, and have separate trays for each paper size. It shall have a document feeder, collator, stapler, and the capability to reduce/enlarge copies between each paper size. The supply of each size copy paper, toner, etc. shall be replenished and the machines shall be maintained for the duration of the contract by the Contractor as required by the Engineer. Make and model can be Minolta, Canon, IBM, Epson, or an approved equivalent, and shall be networked to the office computers.	1	1	1	1	1	1
---	---	---	---	---	---	---

5. Refer to Page 368, TABLE 6.40-I, ADDITIONAL REQUIREMENTS SPECIFIC REQUIREMENTS;
Insert the following two additional requirements:

Heavy duty commercial grade diamond cut shredder with automatic start. The shredder shall be able to receive 8-1/2 inch wide paper and shred a minimum of 15 sheets simultaneously along with CDs and staples.	1	1	1	1	1	1
Projector – 1080p LCD with a min. of 2200 ANSI Lumens, 1920 x 1080, 16:9, 40,000:1 contrast ratio, HDMI, VGA, USB, and a 10 feet diagonal, 16:9 Projection Screen.	-	-	1	1	1	1

6. Refer to Page 496, Subsection 7.20.4. **METHODS**, last paragraph beginning with the words "When directed by the Engineer, due to the original conditions . . .";
Add the following sentence to the end of the last paragraph under **Subsection 7.20.4:**

"However, if the owner at his own expense supplies the replacement frame and doors or hatch covers the Contractor shall install the replacement frame and doors or hatch covers under this Item 7.20, as a basement access reset, in lieu of the steel safety closure plate."

[Added 07-16-2012]

7. Refer to Page 365, **Subsection 6.40.2.(C)(c)(1) "Personal Computer(s) - Workstation Configuration"**;
Delete the text under **Subsections (g) and (k)**, in their entirety;
Substitute the following revised text:

- "(g) I/O Ports: Must have at least one (1) Serial Port, one (1) Parallel Port, and three (3) USB Ports.
- (k) Network Interface: Integrated 10/100/1000 Ethernet card."

8. Refer to Page 366, **Subsection 6.40.2.(C)(c)(2) "All field offices requiring computers shall be provided with the following:"**;
Delete the text under **Subsection (a)**, in its entirety;
Substitute the following revised text:

- "(a) One (1) broad-band internet service account. Wideband Internet connectivity at a minimum throughput of 15 Mbps download and 5 Mbps upload is required at each field office location with 1-5 staffers. For larger field offices see table below for minimum required upload speeds. Telephone service should be bundled together with Internet connectivity. Because of throughput requirements Verizon FIOS is the preferred connectivity provider where available.

Office Personnel #	Upload Speeds (Minimum)
1 - 5	5 Mbps
6 - 10	10 Mbps
11 - 15	15 Mbps
16 - 20 ...	20 Mbps

This account will be active for the life of the project. The e-mail name for the account shall be the DDC Field Office/project Id (e.g. FLD K HWK666 McGuinness@earthlink.com)."

[Added 08-09-2012]

9. Refer to Page 366, **Subsection 6.40.2.(C)(c)(2)(b)**, as amended by Article 2 on page A1-2 of this Addendum;
Delete the text under **Subsection (b)**, in its entirety;
Substitute the following words: **"(b) (No Text)."**

10. Refer to Page 368, TABLE 6.40-I, ADDITIONAL REQUIREMENTS SPECIFIC REQUIREMENTS;
Delete the requirements for a Photocopy Machine shown in the 15th row of TABLE 6.40-I, as modified by Article 4 on page A1-2a of this Addendum, in its entirety;
Substitute the following revised requirements:

Photocopying Machine – Stand-alone, heavy duty, electric, dry-process color photocopying type with color scan and send capability via e-mail, a minimum production rate of 70 pages per minute and an adequate supply of copy paper, toner, etc. The machine shall be capable of duplex copying paper sizes of 8-1/2 x 11 inches, 8-1/2 x 14 inches and 11 x 17 inches, and have separate trays for each paper size. It shall have a document feeder, collator, stapler, and the capability to reduce/enlarge copies between each paper size. The supply of each size copy paper, toner, etc. shall be replenished and the machines shall be maintained for the duration of the contract by the Contractor as required by the Engineer. Make and model can be Minolta, Canon, IBM, Epson, or an approved equivalent, and shall be networked to the office computers.	1	1	1	1	1	1
--	---	---	---	---	---	---

[Added 11-26-2012]

11. Refer to Pages 504 through 508, **SECTION 7.88 - Rodent and Waterbug Pest Control**;
Delete **Section 7.88**, in its entirety;
Substitute SECTION 7.88 (Revised), as contained on the following pages A1-2d through A1-2i.

[Added 02-08-2013]

12. (NO TEXT)

SECTION 7.88 (Revised)
Rodent and Waterbug Pest Control

7.88.1. DESCRIPTION. The Contractor shall provide all labor, materials, plant and equipment, and incidentals required to survey and monitor rodent activity and control any infestation or outbreak of rodents and waterbugs (American cockroaches) within the project limit.

7.88.2. MATERIALS. All materials shall be approved by the New York State Department of Environmental Conservation and comply with the New York City Health Code for the intended usage.

Rodenticide weatherproof bait blocks shall be multiple dose anticoagulants such as Chlorophacinone or Diphacinone, or single feed rodenticides such as ContraMeal, ContractBait block, Quintox pellets or TalonG pellets, or an approved equivalent.

Tamper proof bait station boxes shall be designed to exclude other mammals and shall be used with poisoned bait to attract rats. Information on "tamper proof bait station boxes" is available from the NYC Bureau of Regulatory & Environmental Health Services, Pest Control Office (718-956-7103/4).

Live traps shall be of proper dimensions for trapping rats and shall not be used with poisoned bait.

Insecticide bait shall be a residual type such as phenol methyl carbamate (2%) bait or an approved equivalent.

(A) SUBMITTALS

Prior to commencement of construction activities the Contractor shall submit to the Engineer manufacturer's installation instructions for all materials required for rodent and waterbug pest control work and product data which shall include illustrations, catalog data, product characteristics, typical use, performance, and limitation criteria of all rodent and waterbug pest control materials required.

7.88.3. PERSONNEL. The Contractor shall employ two independent licensed exterminators: one to engage in survey and monitoring work to establish the level of infestation of rodents and insects and provide recommendations for specific Integrated Pest Management (IPM) actions, and one to execute the rodent and waterbug pest control work to deal with such infestations. All pest control personnel employed by each exterminator company must be supervised by an exterminator licensed in categories 7A & 8. The Contractor shall submit the names and license credentials of the two exterminator companies to the Engineer for approval prior to the commencement of any work under this section.

7.88.4. METHODS. Application and dosage of all materials shall be done in strict compliance with the manufacturer's recommendations. All surveying, monitoring, baiting, and/or live trapping work shall be performed in the presence of the Engineer, without which no payment will be made under this Section.

(A) GENERAL

The Contractor's construction activity is expected to disturb any established rodent and/or waterbug population that may exist within the project limits, possibly causing their dispersion. The Contractor shall take all appropriate action to eliminate and/or control these populations within the construction corridor: the construction corridor shall be defined as being the full width of streets under the contract and intersecting streets up to the limits of construction, from property line to property line, excluding buildings and under sidewalk building vaults.

Under the Maintenance of Site requirements for the contract, any unsanitary conditions, such as uncollected garbage or debris, resulting from the Contractor's activities which will provide food and shelter to the resident rodent population shall be corrected by the Contractor immediately after notification of such condition by the Engineer. Non-compliance shall be subject to the application of the "Nonconformance" provisions of the Item for Maintenance of Site, and no payment will be made for any additional application of rodenticide or insecticide needed to control resultant infestations.

(B) SURVEY AND MONITORING WORK

(1) Prior to Construction - The Contractor's designated survey and monitoring exterminator shall execute a survey of the project area and estimate the level of rodent (Norway rat, House mouse) infestation and the waterbug population within the construction corridor. An appropriate sample of utility manholes (sewer, electrical, telephone, etc.) and catch basins should be opened and surveyed to the satisfaction of the Engineer. Contractor shall maintain all survey records in the manner described in 7.88.6., Records and Reports.

(2) During Construction - The Contractor shall monitor the rodent activity through trapping (snap, glue traps or live traps), fecal count methods, and inspection of the conditions of all installed baits every week during construction activity or as otherwise directed by the Engineer. Contractor shall maintain all monitoring records in the manner described in 7.88.6., Records and Reports.

(C) RODENT CONTROL WORK

(1) Wetlands, Woodlands and Areas Within Seventy-five (75') feet of a Stream. In wetlands, woodlands and areas adjacent to a stream, special precautions must be taken to protect water quality and to ensure the safety of other wildlife. To prevent poisoned bait from entering streams, no poisoned bait shall be used in areas within seventy-five (75') feet of either streambank. Live traps must be used in these seventy-five (75') feet buffer zone areas and within wetland and woodland areas.

(2) Outside Wetland Areas, Woodland Areas and Beyond Seventy-five (75') feet of a Stream. In areas outside the seventy-five foot zone of protection adjacent to streams, and areas outside wetlands and woodlands, tamper proof bait stations with poisoned bait shall be established during the period of construction and any consumed or decomposed bait shall be replenished as directed.

Rodent control shall be achieved in two stages as follows:

Stage I. At least one month prior to initiation of the construction work, and periodically thereafter, live traps and/or rodenticide bait, as directed above, shall be placed at locations [e.g., burrows, utility manholes (sewer, electrical, phone, etc.), and catch basins] that are inaccessible to pets, human beings, children and other non-target species, particularly wildlife (e.g., birds) in the construction corridor. Locations of initial bait placement and quantities of bait shall be determined by the survey and monitoring exterminator's written report of his survey and monitoring results, or as otherwise directed by the Engineer.

Stage II. During Construction - Infested sites as determined by the survey and monitoring exterminator's monitoring report shall be baited and/or rebaited, and live traps shall be collected and replaced, the rates and quantities of which shall be determined by the written monitoring reports submitted weekly or as otherwise directed by the Engineer in consultation with the City's Office of Pest Control.

The baiting exterminator shall be responsible for collecting and disposing of all trapped and poisoned rodents found in live traps and tamper proof bait stations. The baiting exterminator shall also be responsible for posting and maintaining signs announcing the baiting of each particular location.

The Contractor, under his maintenance of site operations, shall be responsible for the immediate collection and disposal of any visible rodent remains found on streets or sidewalk within the project limits. Any visible remains shall be placed into double plastic bags. No more than five (5) carcasses shall be placed into each bag. Each bag shall be a minimum of 3 mils thick, black plastic. No additional payment will be made for this work.

It is anticipated that public complaints will be addressed to the Engineer's Field Office. The Contractor, where directed by the Engineer, shall take appropriate Integrated Pest Management (IPM) actions, such as baiting, trapping, proofing, etc., to remedy the source of a complaint within the next six (6) hours of normal working time, which is defined herein, for the purposes of this section, as 7 A.M. to 6 P.M. on Mondays through Saturdays.

(D) WATERBUG (AMERICAN COCKROACH) CONTROL

Infested sites (e.g., sewers) shall be baited at least 2 times per month with insecticides, or as directed by the Engineer in consultation with the exterminator monitoring the work and the City's Office of Pest Control.

7.88.5. EDUCATION & TRAINING. The Contractor shall post notices in all Construction Bulletin Boards advising workers, employees, and residents to call the Engineer's Field Office to report rodent and waterbug infestations. The Contractor shall provide and distribute literature pertaining to IPM techniques of rodent control to affected businesses and superintendents of nearby residential buildings to ensure their participation in maintaining their establishments free of unsanitary conditions, harborage removal and rodent proofing.

Prior to application of any chemicals, the Contractor shall furnish copies or sample labels for each pesticide, antidote information, and Material Data Safety Sheets (MSDS) for each chemical used.

7.88.6. RECORDS AND REPORTS.

(A) GENERAL

The Contractor shall be responsible for assigning within the construction corridor an identifying number to each manhole, catch basin, and other location where bait and/or live trap placement and/or waterbug control work is proposed by the survey and monitoring exterminator. The Contractor shall then provide that list of locations and corresponding reference numbers along with a drawing showing the locations, as a reference for the exterminator(s) performing the work, to indicate locations of bait placement and waterbug control work and rodent and waterbug activity (droppings, bait consumed, dead rodents, etc.).

(B) SURVEY AND MONITORING WORK

(1) Prior to Construction - Contractor shall submit to the Engineer, for approval, a written survey report including proposed IPM procedures, including specific materials, quantities, locations, methods, and time schedule for the implementation of the exterminating work. The written report shall also include a survey with a drawing (provided by the Contractor) marked with locations indicating all signs of rodent (Norway rat, House mouse) infestation and waterbug activity discovered during the execution of the survey indicating that rodent and waterbug pest control work is necessary.

(2) During Construction - Based on monitoring results, Contractor shall submit to the Engineer a weekly written monitoring report identifying all locations and conditions of installed bait and/or other rodent control work. The monitoring report shall also include any other recommended IPM techniques, such as baiting, trapping, proofing, etc., proposed for rodent and waterbug pest control.

The survey and monitoring exterminator shall keep a record of all rodent and waterbug infestation surveys s/he has conducted. The Contractor shall be required to submit a copy of all survey and monitoring reports to the Engineer each week, prior to payment.

(C) RODENT AND WATERBUG CONTROL WORK

The baiting exterminator shall maintain records of all locations baited along with the type and quantity of rodenticide and insecticide bait used. These records will be kept by the City Inspector. A weekly report shall be prepared, signed and certified by the approved licensed exterminator, and such reports shall be submitted to the Engineer each week, prior to payment.

7.88.7. NONCONFORMANCE. If the Contractor fails to perform as directed to control the rodent and/or waterbug population at any location within the project limits for a period of more than one week, the Engineer will correct the adverse conditions by any means he deems appropriate, including but not limited to, the use of "outside services" and shall deduct the cost of the corrective work from any monies due to the Contractor. The deducted cost of this work shall be in addition to the non-payment for rodent and waterbug pest control.

7.88.8. MEASUREMENT.

(A) RODENT INFESTATION SURVEY AND MONITORING

The quantity to be measured for payment under Item No. 7.88 AA, RODENT INFESTATION SURVEY AND MONITORING, shall be a Lump Sum measurement.

(B) RODENT BAIT STATIONS

The quantity to be measured for payment under Item No. 7.88 AB, RODENT BAIT STATIONS, shall be the number of tamper-proof rodent bait station boxes and/or live traps satisfactorily installed or reinstalled after inspection within the construction corridor, as approved by the Engineer. However, the initial baiting, and subsequent rebaiting as may be required, of any bait station will be paid for under Item 7.88 AC.

(C) BAITING OF RODENT BAIT STATIONS

The quantity to be measured for payment under Item No. 7.88 AC, BAITING OF RODENT BAIT STATIONS, shall be the number of tamper-proof rodent bait station boxes, utility manholes, catch basins, or other locations approved by the Engineer, satisfactorily baited or rebaited to replenish consumed or decomposed bait within the construction corridor, as approved by the Engineer.

(D) WATERBUG BAIT APPLICATION

The quantity to be measured for payment under Item No. 7.88 AD, WATERBUG BAIT APPLICATIONS, shall be the number of blocks satisfactorily treated with insecticide bait within the construction corridor, as approved by the Engineer. A block shall be defined as the area of street, measured between property lines, from intersection to intersection. Each rebaiting of any block shall be considered as a new block for measurement purposes.

7.88.9. PRICES TO COVER.

(A) RODENT INFESTATION SURVEY AND MONITORING

Payment will be made at the lump sum price bid for RODENT INFESTATION SURVEY AND MONITORING which shall include the cost of furnishing all the labor, materials, plant, equipment (traps, etc.), insurance, and other incidentals required, including but not limited to providing all required maintenance of traffic equipment, to perform a rodent infestation survey of the project area and then monitor the site each week for rodent activity, all in accordance with the specifications and the directions of the Engineer.

Ten (10%) percent of the lump sum price bid will be paid when the initial survey of the project area has been completed and the written survey report has been submitted to the satisfaction of the Engineer. The remainder will be paid in proportion to the percentage of contract completion.

(B) RODENT BAIT STATIONS

The Contract price bid for RODENT BAIT STATIONS shall be a unit price per each tamper proof bait station box and/ or live trap installed or reinstalled after inspection and shall cover the cost of furnishing all labor, materials, plant, equipment (bait stations, etc.), insurance, and other incidentals, including but not limited to providing all required maintenance of traffic equipment, required to control the rodent population found within the project limits in accordance with the specifications and the directions of the Engineer.

In addition to the payment for Rodent Bait Stations installed or reinstalled under this Item 7.88 AB, the Contractor will also be paid for each baiting or rebaiting, when required, of each bait station, under Item No. 7.88 AC.

(C) BAITING OF RODENT BAIT STATIONS

The Contract price bid for BAITING OF RODENT BAIT STATIONS shall be a unit price per each bait station, utility manhole, catch basin or other location approved by the Engineer satisfactorily baited or rebaited, when required, and shall cover the cost of furnishing all labor, materials, plant, equipment (bait), insurance, and other incidentals, in accordance with the specifications and directions of the Engineer. Installation or resetting of the bait station will be paid for under Item 7.88 AB.

(D) WATERBUG BAIT APPLICATION

The Contract price bid for WATERBUG BAIT APPLICATION shall be a unit price per block treated by the exterminator and shall include the cost of furnishing all the labor, materials, plant, equipment (bait, etc.), insurance, and other incidentals, including but not limited to providing all required maintenance of traffic equipment, necessary to control the waterbug population found within the project limits for the duration of the contract in accordance with the specifications and the directions of the Engineer.

Payment will be made under:

Item No.	Item	Pay Unit
7.88 AA	RODENT INFESTATION SURVEY AND MONITORING	L.S.
7.88 AB	RODENT BAIT STATIONS	EACH
7.88 AC	BAITING OF RODENT BAIT STATIONS	EACH
7.88 AD	WATERBUG BAIT APPLICATION	BLOCK

[Added 05-24-2013]

13. Refer to Page 366, **Subsection 6.40.2.(C) (c) (1) (m) Software Requirements**, as modified by Article 1 on page A1-2;
Delete the text under **Subsection (m)**, in its entirety;
Substitute the following revised text:

“(m) **Software Requirements:** Microsoft Windows 7 Professional SP1, 32 bit; Microsoft Office Professional 2010; Microsoft Project 2010; Adobe Acrobat reader; Anti-Virus software package with 2 year updates subscription; and, either Auto Cad LT or Microsoft Visio Standard Edition, as directed by the Engineer.”

[Added 09-04-2013]

14. Refer to Page 384, the end of **Section 6.44 - White and Yellow Thermoplastic Reflectorized Pavement Markings**;
Insert new **SECTION 6.44 PO**, after **Section 6.44**, as contained on the following pages A1-2k through A1-2m.

[Added 02-10-2014]

15. Refer to Pages 393 and 394, **SECTION 6.52 - Uniformed Full-Time Flagperson**;
Delete **Section 6.52** on pages 393 and 394, but do not delete examples on pages 395 and 396;
Substitute **SECTION 6.52 CG**, as contained on the following pages A1-2n and A1-2o.

**SECTION 6.44 PO
Lane Pavement Overlay**

6.44PO.1. DESCRIPTION. This section describes the furnishing and application of an approved Green Asphalt Pavement Color Scheme along designated bicycle lanes and Brick-Red Asphalt Pavement Color Scheme matching Quest's StreetBondCL Terracotta color along designated Select Bus Service (SBS) lanes, as indicated in the Contract Drawings or as directed by the Engineer.

6.44PO.2. REFERENCES.

- A. ASTM D-4541 Standard Test Method for Pull-Off Strength of Coatings Using Portable Adhesion Tester.
- B. ASTM D-4060 Test Method for Abrasion Resistance of Organic Coatings by the Taber Abrasion.
- C. ASTM D-522-93A Standard Test Method for Mandrel Bend Test of Attached Organic Coatings.
- D. ASTM G-155 QUV Accelerated Weathering Environment. Standard Practice for Operating Fluorescent Light Apparatus for UV Exposure of Nonmetallic Materials.
- E. ASTM D-2486 MEK rub test for chemical resistance.
- F. ASTM D-570 Standard Test Method for water absorption of plastics.
- G. ASTM E-303 British Pendulum test for friction.
- H. EPA 24 ASTM D3960-05 Volatile Organic Compounds.

6.44PO.3. SUBMITTALS.

- A. A copy of the current year accreditation certificate available from the Contractor or subcontractor who will be performing this work, or written verification from the coating supplier that the Contractor or subcontractor is qualified to perform this Work.
- B. Written and published specification for the application of the selected asphalt pavement coating.
- C. Confirmation of coating color.
- D. Proof of coating performance through a Certificate of Analysis or equivalent document as provided by the Contractor or the coating supplier.

6.44PO.4. MATERIALS.

The following table outlines minimum performance properties of a typical asphalt pavement coating.

Characteristic	Test Specification	Measured result
Durability: Taber Abrasion resistance	ASTM D-4060 7 day cure, H-10 wheel (wet test)	< 5.0 g/1000
Water sensitivity	ASTM D-570 Water absorption after 9 days: Remaining absorption after 1 hour of recovery:	< 10% < 1.0%
Color stability	ASTM G-155 QUV 2,000 hours (CIE units)	New York City Bike Lane Green $\Delta E < 1.5$
Color stability	ASTM G-155 QUV 2,000 hours (CIE units)	Brick color $\Delta E < 1.5$

Flexibility: Mandrel Bend	ASTM D-522-93A Flexibility as measured by Mandrel bend 0.5mm thick sample passes 10 mm at 21°C 0.5mm thick sample passes 125mm at -18°C	
Chemical resistance	ASTM D-2486 Modified MEK scrubs 16 dry mils, number of scrubs until 50% substrate exposed	>5000
Adhesion to Asphalt	ASTM D-4541	Substrate Failure
Friction Wet	ASTM E-303 British Pendulum Tester	>55
Environmental Sensitivity	EPA 24 ASTM D-3960-05 Volatile Organic Compounds	VOC < 150

These properties shall be evidenced by Certificates of Analysis produced by an independent qualified testing facility.

Green Bicycle and Red Bus Lane Pavement Overlays furnished by the following manufacturers, or approved equivalent, are acceptable for use in this contract:

Ennis Paint, Inc.
1509 S. Kaufman Street
Ennis, TX 75119

Integrated Pavement Concepts, Inc.
102-17957 55th Avenue
Surrey, BC Canada V3S 6C4

Crafco, Inc.
420 N. Roosevelt Avenue
Chandler, AZ 85226

6.44PO.5. METHODS. The asphalt pavement coating system shall be applied to the pavement in accordance with the manufacturer's specification. In its hardened state the color shall be as specified, and as approved by the Engineer. The material shall present a marking whose color and chemical resistance will not degrade under normal exposure to calcium chloride, sodium chloride or automotive oils and fuels. Color pigments used shall remain stable under exposure to ultra violet light. A minimum of four (4) layers of coating material shall be applied to the pavement surface.

The Contractor shall be required to use the proper equipment in the application of the asphalt pavement coating, as per the recommendation of the coating supplier, and as approved by the Engineer.

Asphalt pavement must be stable, well compacted and generally in excellent condition for the application of the asphalt pavement coating to be successful. The Engineer shall make the final determination as to the suitability of the existing asphalt pavement.

The asphalt pavement surface shall be dry and free from all foreign matter, including but not limited to dirt, dust, de-icing materials, and chemical residue.

The asphalt pavement coating shall only be applied in the correct environmental conditions as instructed by the coating supplier, and as approved by the Engineer.

Refer to the instructions provided by the coating supplier regarding when the painted lane may be opened to traffic. Wait time is typically a function of the dry rate of the coating, and climate conditions.

The Engineer may, at his discretion, require the Contractor to remove all extraneous marks on the pavement made by the agents or employees of the Contractor, or made by others due to improper control or protection of the work area by the Contractor, his agents or employees. Any installation which, in the opinion of the Engineer, is not acceptable, whether by reason of poor workmanship, poor appearance, poor performance, poor materials, improper width or improper alignment, shall be reworked by the Contractor at no cost to the City. The Contractor shall replace rejected installation as directed by the Engineer, within fifteen (15) days after receiving written notification of the rejection of such completed work.

6.44PO.6. MEASUREMENT. The quantities to be measured for payment shall be the number of square yards of Lane Pavement Overlay, of each color, placed as specified to the satisfaction of the Engineer.

6.44PO.7. PRICES TO COVER. The unit prices bid per square yard of Green Bicycle Lane Pavement Overlay and Red Bus Lane Pavement Overlay shall cover the cost of all labor, materials, plant, equipment, insurance, and necessary incidentals required including, but not limited to, testing, cleaning, preparation of surfaces, and application of the lane pavement overlay materials, all in accordance with the contract plans and specifications, and as directed by the Engineer.

Payment will be made under:

Item No.	Item	Pay Unit
6.44 POG	GREEN BICYCLE LANE PAVEMENT OVERLAY	S.Y.
6.44 POR	RED BUS LANE PAVEMENT OVERLAY	S.Y.

SECTION 6.52 CG

Crossing Guard

6.52CG.1. INTENT. This section describes the employment of full-time uniformed crossing guards to direct and detour traffic.

6.52CG.2. DESCRIPTION. The Contractor shall furnish an adequate number of competent crossing guards to control vehicular and pedestrian traffic when it is necessary to maintain alternating one-way traffic in one lane of a two-way roadway, and at all other locations where construction operations, construction vehicles and equipment, and temporary traffic patterns related to the construction operations require positive temporary traffic control for safe, efficient traffic operations.

6.52CG.3. METHODS. All crossing guards, whether paid for under this item or not, shall be proficient in speaking, writing and reading English and adequately trained in controlling vehicular and pedestrian traffic by a recognized training program such as that provided by the American Traffic Safety Services Association, the National Safety Council, unions or construction industry associations, or by an individual who holds a current certification as a flagger training instructor from such a program.

All crossing guards, whether paid for under this item or not, their apparel, hand-signaling devices, and procedures to be used by them shall be in compliance with the requirements of Chapter 6E. FLAGGER CONTROL, in the Federal "Manual on Uniform Traffic Control Devices for Streets and Highways" 2009 Edition, or later edition, and shall each be equipped with an active two-way radio.

Prior to the start of crossing guard operations, the Contractor shall provide to the Engineer a list of certified crossing guards to be used in the contract, identifying the source of crossing guard training for each individual. When requested by the Engineer, crossing guards shall demonstrate their competency in crossing guard procedures. Crossing guards not competent in controlling vehicular and pedestrian traffic procedures to the satisfaction of the Engineer shall be retrained or replaced at once. Each crossing guard paid under this item must be a full-time crossing guard. If any worker performing services under this item is also assigned the task of directing construction equipment (as per attached Example #2, worker acting as a flagperson 'A') or any laborer tasks, then such worker shall be deemed to be subject to the provisions of Labor Law §220 Prevailing Wage Schedule and will not be paid for under this Item.

6.52CG.4. MEASUREMENT. The quantity to be measured for payment shall be the number of person-hours of uniformed crossing guard service actually performed, as authorized by the Engineer. Laborers who are not full-time crossing guard will not be measured for payment as crossing guards under this or any other item. Each uniformed crossing guard shall be required to work a minimum of eight (8) hours a day and the Contractor will be given a minimum of twelve (12) hours advanced notice by the Engineer as to when to furnish a crossing guard.

6.52CG.5. PRICE TO COVER. The contract price per person-hour shall cover the cost of all labor, materials, equipment, and insurance necessary to employ a uniformed full-time crossing guard, and equip him/her with safety vests, hard hats, and signaling devices, including all other incidental costs necessary to control and detour traffic, as shown on the Contract Drawings, the Examples #1 and #2 on pages 395 and 396 (excluding worker acting as a flagperson "A" in Example #2), or as directed by the Engineer.

Payment for flagperson "A" in Example #2, shall be deemed to be included under other items of work, as appropriate.

Where there is no scheduled item for Crossing Guard, the cost of furnishing Crossing Guards as required shall be deemed included in the unit price bid for the Maintenance and Protection of Traffic item.

Payment will be made under:

Item No.	Item	Pay Unit
6.52 CG	CROSSING GUARD	PERSON-HOUR (P/HR)

[Added 02-24-2014]

16. Refer to Pages 480 and 481, **Subsection 7.13.2.(B) MAINTENANCE OF STREETS**, 4th paragraph, beginning with the words "The Contractor shall maintain the traveled way . . . ;
Delete the 4th paragraph, in its entirety;
Substitute the following text:

"The Contractor shall maintain the traveled way in such a condition and conduct operations in such a manner that snow and ice may be readily removed by others as and when necessary, and in such a manner that proper drainage is provided for the melting of snow in the banks resulting from normal plowing. However, the Contractor will not be responsible for snow or ice removal on the pavement or traveled way opened for public usage, except within the limits of the work zone(s) which may include, but is not be limited to, stairways, promenades, esplanade areas, and sidewalk, including those fronting his office and the Engineer's field office all of which will be the responsibility of the Contractor."

3. NEW SECTIONS

SECTION 6.52 FED
Uniformed Flagperson

6.52FED.1. INTENT. This section describes the employment of uniformed flagpersons to direct and detour traffic.

6.52FED.2. DESCRIPTION. The Contractor shall furnish an adequate number of flagpersons to control vehicular and pedestrian traffic when it is necessary to maintain alternating one-way traffic in one lane of a two-way roadway, and at all other locations where construction operations, construction vehicles and equipment, and temporary traffic patterns related to the construction operations require positive temporary traffic control for safe, efficient traffic operations.

6.52FED.3. METHODS. All flagpersons shall be English speaking and adequately trained in flagging operations by a recognized training program such as that provided by the American Traffic Safety Services Association, the National Safety Council, unions or construction industry associations, or by an individual who holds a current certification as a flagger training instructor from such a program.

All flagpersons, their apparel, hand-signaling devices, active two-way radios, and procedures to be used by them shall be in compliance with the requirements of Chapter 6E. FLAGGER CONTROL, in the Federal "Manual on Uniform Traffic Control Devices for Streets and Highways" 2009 Edition, or later edition.

Prior to the start of flagging operations, the Contractor shall provide to the Engineer a list of certified flagpersons to be used in the contract, identifying the source of flagger training for each individual. When requested by the Engineer, flagpersons shall demonstrate their competency in flagging procedures. Flagpersons not competent in flagging procedures to the satisfaction of the Engineer shall be retrained or replaced at once.

Flagpersons are to be paid not less than the most recent prevailing wages rates established for Laborers as set by the NYC Comptroller or the US Department of Labor, whichever is higher at the time the work is being performed.

The Contractor will be given a minimum of 12 hours advanced notice by the Engineer as to when to furnish a flagperson.

6.52FED.4. METHOD OF MEASUREMENT. The fixed price lump sum shown in the bid proposal for this item shall be considered the price bid, although actual payment will be based on the authorized work performed by the Uniformed Flagpersons. The fixed sum is not to be altered in any manner by the bidder.

It is agreed that the quantity to be measured for payment shall be the number of person-hours of uniformed flagperson service actually performed, as authorized by the Engineer.

Laborers who are not uniformed flagperson will not be measured for payment as flagperson under this item.

6.52FED.5. BASIS OF PAYMENT. The Contract price for this item shall be a lump sum price for the work performed under this item and shall be equal to the total sum of the amount of

wages paid for all authorized Uniformed Flagpersons performing vehicular and pedestrian traffic management, with a twelve (12%) percent markup for Overhead, except that no percentage for overhead will be allowed on Payroll Taxes or on the premium portion of overtime pay or on sales and personal property taxes; plus ten (10%) as compensation for Profit, except that no percentage for profit will be allowed on Payroll Taxes or on the premium portion of overtime pay or on sales and personal property taxes; as described in Article 26 of the Standard Construction Contract.

Overhead shall include without limitation, all costs and expenses in connection with administration, management superintendence, and all material costs for their apparel, hand-signaling devices, active two-way radios, and any other equipment required, and insurance required by Schedule A of the General Conditions other than Workers' Compensation Insurance.

The hourly rate per person-hour shall be the prevailing wage rate for Laborers in effect at the time of the work to control and detour traffic, as shown on the Contract Drawings or as directed by the Engineer.

The Contactor shall be required to submit to the Engineer satisfactory evidence of payment on a New York State certified payroll report forms. No retainage will be withheld by the Department on such payments made under this section.

The total estimated cost of this item is the "fixed sum" amount shown for this item in the Bid Schedule. No guarantee is given that the actual total cost for this item will in fact be the "fixed sum" amount. The "fixed sum" amount is included in the total bid solely to insure that sufficient monies will be available to pay the Contractor for these services.

The "fixed sum" is for bidding purposes only and shall not be varied in the bid. The Contractor will be paid for the actual amount regardless of the fixed sum, which may be more or less than the fixed sum amount.

The Contractor shall maintain separate books of accounts and shall not charge any portion of the cost of wages for Uniformed Flagpersons to another part of the work. Payment and partial payments under this item shall be treated separately from the rest of the contract items.

The New York State certified payroll report forms shall be submitted to the Engineer on a monthly basis and shall include the signed copies of the daily report.

Payment will be made under:

Item No.	Item	Pay Unit
6.52 FED	UNIFORMED FLAGPERSON	FIXED SUM

**SECTION 7.50 ST
STEEL BENCH**

7.50 ST.1. DESCRIPTION. Under these items, the Contractor shall furnish and install each bench in accordance with the Contract Drawings, the specifications and directions of the Engineer.

7.50 ST.2. MATERIALS.

(A) Bench shall be manufactured by Landscape Forms, Inc., 431 Lawndale Avenue, Kalamazoo, Michigan 49048. Toll Free: (800) 521-2546. Phone (269) 381-0396. Fax (269) 381-3455. Website: www.landscapeforms.com. E-mail denises@landscapeforms.com, Attn.: Denise Smith.

(B) Bench Distributors:

1. Landscape Forms, Inc.
431 Lawndale Avenue
Kalamazoo, Michigan 49048
(800) 521-2546; (269) 381-0396
MAdinolfi@aof.com

2. Arenson Furniture Rental
1115 Broadway
New York, 10010
(212) 633-2400
denises@landscapeforms.com

3. AFD Contract Furniture Inc.
810 7th Avenue,
New York NY, 10019
(212) 721-7100
tcohen@afd-inc.com

4. Empire Office Inc.
105 Madison Ave. #15
New York, NY 10016

(212) 607-5566
lwoodie@empireoffice.com

5. or other approved supplier.

(C) **STYLES:**

BACKED BENCH

"QASF0886-001"

- Length: 89-1/4 inches
- Seat Height: 18 inches
- Seat Depth: 19 inches
- Seat Width: 22 inches
- Seat Radius: 79 inches

BACKLESS BENCH

"QASF0886-002"

- Length: 89-1/4 inches
- Seat Height: 17-3/4 inches
- Seat Depth: 22-5/8 inches
- Seat Width: 22-5/8 inches
- Seat Radius: 79 inches

BACKED BENCH
"QASF0886-001"

BACKLESS BENCH
"QASF0886-002"

- Arm Height: 24-7/8 inches
- Back Radius: 70 inches
- Back Angle: 9-1/2 degrees
- Seat Included Angle: 98-1/2 degrees
- Height: 34 inches

- Arm Height: 24-7/8 inches

- (D) **MOUNTING:** Bench legs shall have steel anchor tabs to allow for surface mounting of bench.
- (E) **HARDWARE:** Anchor bolts used to secure the benches to pavements shall be either stainless steel or hot-dipped galvanized steel. Type and dimensions of all bolts, nuts, and washers shall be as indicated on the Contract Drawings. Threads of all bolts shall have the ends upset after installation of nuts so as to render the connection vandal resistant.

7.50 ST.3. METHODS.

- (A) **DELIVERY, STORAGE, AND HANDLING.** Deliver materials to site in manufacturer's original, unopened containers and packaging, with labels clearly identifying product name and manufacturer. All material shall be bundled and fully supported during shipping and storage to prevent creep.

Material manufacturer's directions for storage and use shall be adhered to. Material surfaces shall be protected during shipment so as to arrive mar and scratch free in the field.

Keep materials in manufacturer's original, unopened containers and packaging until installation. Any damage or excessively scratched will be rejected and replaced with new. All material must be straight and true when placed in the construction. Store any and all tooling, fixtures, process drawings and project files until last project phase is complete. Deliver all tooling, fixtures and documentation to the Engineer upon completion of the work.

- (B) **INSTALLATION.** Benches shall be uniquely fabricated and pre-assembled before being installed in their final location in the work. Benches shall be installed in their final position and properly secured in place, as indicated on the Contract Drawings.

Protect installed product to ensure that, except for normal weathering, benches will be without damage or deterioration at time of Substantial Completion.

- (C) **TOUCHUP AND REPAIR:** For all clean welds, bolted connections, and minor damage caused by transportation and installation of metal powder coated surface, the touch-up finish shall be in conformance with manufacturer's recommendations. Provide touch-up such that the repair is not visible from a distance of six feet (6'). The touch up color shall match the color of the powder coat.

7.50 ST.4. SUBMITTALS. All submittals shall be as per **Section 1.06.31** of the NYC Department of Transportation's Standard Highway Specifications, and in accordance with the following requirements:

(A) **WARRANTY:** The manufacturer guarantees a standard warranty that the products will be free from defects in material and/or workmanship for a period of three years from the date of invoice.

7.50 ST.5. MEASUREMENT. The quantity of Steel Bench to be paid for under this item shall be the number of Steel Bench(s) of each type installed at the site to the satisfaction of the Engineer.

7.50 ST.6. PRICES TO COVER. The price bid shall be a unit price for each type of Steel Bench and shall include the cost of all labor, materials, plant, equipment, insurance, and incidentals necessary, including, but not limited to, all painting, hardware, anchors, and the furnishing of a complete prototype sample; all in accordance with the Contract Drawings, the specifications and the directions of the Engineer.

Excavation and concrete shall paid for under their respective Contract Items.

Payment will be made under:

Item No.	Item	Pay Unit
7.50 ST	STEEL BENCH BACKED	EACH
7.50 STB	STEEL BENCH BACKLESS	EACH

ITEM 637.95 20 – FIELD INFORMATION MANAGEMENT SYSTEM

DESCRIPTION:

This work shall consist of providing a fully operational field information collection and management system and support services.

MATERIALS:

The field information management system shall include all the components, and adhere to, the specifications in Attachment A attached to this specification.

The Contractor is required to have the vendor of the field information management system on call for support services for the duration of the contract.

CONSTRUCTION DETAILS:

The Contractor shall provide and maintain a field information management system with access made available to parties as designated by the Engineer. The Contractor shall make the system fully operational, including training, prior to the project first working day.

The system shall be maintained and remain in service until either: (a) the Engineer requests its removal in writing, (b) the NYCDOT relinquishes the Engineer's field office and the field information management system is relinquished as part of the Engineer's field office, or (c) the later of either thirty (30) days after the final contract acceptance date or thirty (30) days after the date the Contractor provided the last documentation necessary for processing the final contract acceptance.

Ownership of the software supplied by the Contractor shall remain the property of New York City Department of Transportation (NYCDOT). All data is the property of NYCDOT and shall be provided in a useable format at the completion of the contract.

The Contractor shall maintain the information management system vendor account in good standing to prevent service interruptions for the duration of the project.

METHOD OF MEASUREMENT:

The field information management system will be measured on a fixed price Dollar Cents pay unit basis.

BASIS OF PAYMENT:

The pay item is a 'draw down' item. As materials are supplied, the receipts for the materials shall be submitted to the Engineer (Note: 'materials' includes all software, software customizations, labor, services, and service contracts provided to furnish and maintain all of the components of the system). The Contractor will be reimbursed for receipted costs of materials plus five percent (5%) for profit and overhead.

ITEM 637.95 20 – FIELD INFORMATION MANAGEMENT SYSTEM

The total cost shown in the itemized proposal for this pay item will be considered the price bid even though payment will be made only for actual materials supplied, with profit and overhead. The unit price amount is not to be altered in any manner by the bidder. Should the bidder alter the amount shown, the altered figure will be disregarded, and the original price will be used to determine the total amount bid for the contract.

Payment will be made under:

Item No.	Item	Pay Unit
637.9520	FIELD INFORMATION MANAGEMENT SYSTEM	F.S.

ITEM 637.95 20 – FIELD INFORMATION MANAGEMENT SYSTEM

ATTACHMENT A

This pay item shall include supplying a cloud based field information management system with the following capabilities.

ACCESS

- Accessible from any internet connected desktop and laptop through a vendor supported browser
- Accessible from vendor supported mobile tablets (ex. Apple iPad)

SYSTEM FUNCTIONALITY

The system will provide the following functionality in real time to all authorized users:

- **Field Recording**
 - o Work Report (Inspector Reports) progress tracking quantity, labor, equipment, field sketches, forms, etc.
 - o Engineer Reports (EIC Journals) with automatically integrated Work Reports
 - o Punch List Issue tracking with Ball In Court, Priority and Due Date assignment
- **Cost Control**
 - o Generate Payment Estimate (Progress Payment) with thresholds to warn Engineer of the following payment scenarios: Quantity Over Authorized Quantity, Quantity Over Material Acceptance Restriction, Charge to Contractor Recorded, Force Account Estimate limit, Field Change Payment Recorded, Major Item Over Run, Minor Item Over Run and Material Partial Payment Recorded
 - o Material Acceptance Tracking Module
 - o Material Partial Payment (MOH/Stockpile) Module
 - o Contract Change Order Module
 - o Field Change Payment Tracking
 - o DBE Tracking
 - o Retainage Tracking
 - o Provide electronic data input into NYSDOT CEES system
 - o Project Close Out Milestone tracking and CEES based Close Out Reports
 - o CEES based Reporting Module
- **Document Control (all with Ball in Court, Priority, Due Date and electronic notifications for electronic communication between project participants)**
 - o Request For Information (RFI) Module
 - o Submittal Module
 - o Submittal Package Module
 - o Transmittal Module
 - o Meeting Minutes Module
 - o Messages Module
 - o File Cabinet for storage of (Photos, Videos, Forms, Contract Documents, Specifications and all project files)
 - Ability to electronically load files into File Cabinet via upload and/or email into from web based email systems
 - o Plan Module. (Ability to view, organize and submit/approve original & marked up plans)
- **Scheduling**
 - o Display current approved CMP schedule
 - o Ability to record activities against CPM schedule
 - o Ability to export actual activities used information into Scheduling Software

ITEM 637.95 20 – FIELD INFORMATION MANAGEMENT SYSTEM

- **Archive. Provide automated conversion of Project records into text selectable PDF files organized into standard folder structure for storage and/or printing**
- **Provide continual (when and wherever wireless service is reasonably available) two-way synchronization between all components of the system**
 - o **Provide offline option for vendor approved mobile device**
- **Integrated Search Module**
- **Support/Help Module**

DATA REQUIREMENTS

The following information is required for Project Set Up

- **Searchable Contract Plans and Proposal**
- **Searchable Standard Specifications**
- **Searchable common Data Resources (MURK Manuals, Standard Sheets, Engineering Instructions, etc.)**
- **Initial CPM Schedule**
- **Field User Forms**

DATA STORAGE /TRANSFER

- **Data shall be stored and maintained on a cloud based server with regular secondary location backups**
- **Continual access to system shall be available from the office and field office shall be provided (via internet)**
- **Raw data will be made available to NYCDOT through provided API**
- **All data shall be transferred to NYCDOT in a useable electronic format at the end of the contract**

MAINTENANCE /SERVICE

- **Any as-needed maintenance/service/upgrades shall be provided in a timely manner**
- **Software is able to be customized for NYCDOT direction**

TRAINING

- **In-person training on the use of the systems shall be provided**
- **Continuous help call support also shall be available for the duration of the contract**
- **Training and support services shall be performed by a qualified representative from the field information management system vendor**

4. SPECIAL PROVISIONS

The following shall become a part of and apply to the Contract:

A. LINES AND GRADES. The Contractor shall furnish lines and grades in accordance with Section 1.06.27 of the Standard Specifications, except that survey controls established for this project may no longer exist and the Contractor shall be required to re-establish the survey control information using official Borough Survey Control Monuments and Bench Marks, where they exist. The Contractor shall check with Topographic Section of the Borough President's Office as to the reliability and accuracy of the data to be used for lines and grades.

B. SPECIFIC TRAFFIC STIPULATIONS. Under this contract, the Contractor shall perform the work in strict accordance with the requirements of Section 6.70 in the Standard Highway Specifications, specific traffic stipulations as called for on the plans, OCMC Traffic Stipulations attached to the end of these Special Provisions, and the directions of the Engineer. In case of a conflict, the Engineer's decision shall be final.

In addition, the cost of compliance with requirements of the OCMC Traffic Stipulations, unless otherwise provided for, shall be deemed included in the prices bid for all scheduled items.

C. HOLIDAY CONSTRUCTION EMBARGO. A special Holiday Construction Embargo shall be in effect on the Friday of the week preceding Thanksgiving Day week from 6:00 AM to 11:59 PM and again from the Monday of Thanksgiving Day week from 6:00 AM through January 2, at 11:59 PM. Roadway and sidewalk construction activities will be restricted during the embargo period on the streets listed below*.

Any permits issued prior to the date of this notice, for work during this embargo period on the streets listed below which do not already have the permit stipulation "410" are hereby suspended for the period noted above. All permittees must comply with this embargo unless a special waiver is granted by OCMC. Waiver requests must be filed at least thirteen days before Thanksgiving Day, in the Permit Office by filing a "Request for Roadway/Sidewalk Permits During Embargo Periods" and submitting supporting documentation. Waiver requests should only be submitted for critical reasons for a specific project. If a waiver is granted, the applicant will be notified so they can apply for the approved permits. Waivers **are not** required for ongoing Building Construction Activity Permits which already include the "410" permit stipulation. Waiver request forms may be obtained at any Permit Office or on the Department of Transportation's website at: <http://www.nyc.gov/html/dot/downloads/pdf/holidayembapp.pdf>

* Please note that this embargo only applies to NYCDOT construction permits.

* List of street and maps of the affected locations are available by borough on the Department of Transportation's website at: <http://www.nyc.gov/html/dot/html/motorist/trafalrt.shtml>

Prior to this embargo period all necessary measures must be taken so that all roadways and sidewalks are in proper condition to allow for the expeditious and safe movement of vehicular, bicycle and pedestrian traffic. Tool carts, cable reels, containers, and material stored on roadways must be removed during the embargo period.

The opening of utility access covers is prohibited on any of the streets noted below between the hours of 6:00 AM and midnight unless the utility or Contractor files for an Emergency Authorization Number as required by section 2-07 of the Department of Transportation's Highway Rules. The planned opening of utility access covers may occur during the hours of 12:01 AM and 5:59 AM where no authorization number is required.

Temporary restoration of the streets and sidewalks and removal thereof, if required for the Holiday Embargo period, will be paid for under the appropriate scheduled items.

No extension of time due to the shutdown period will be granted to the Contractor for completion of the work.

D. DISPOSAL OF EXCESS EXCAVATED MATERIAL. All excess excavated material, with the exception of contaminated material, shall become the property of the Contractor and shall be properly disposed of away from the site, at the Contractor's expense. Contaminated material shall be disposed of separately in accordance with contract requirements.

E. N.Y.C. TRANSIT INSURANCE. The Contractor (Permittee) shall indemnify and save harmless the City of New York and the New York City Transit (Permitter) in accordance with the following "Insurance Requirements" and proof that the necessary insurance is in effect will be required before work can commence:

NYCT "OUTSIDE CONTRACT" INSURANCE REQUIREMENTS

1. The Permittee at its sole cost and expense shall carry or cause to be carried and shall maintain at all times during the period of performance under this Agreement policies of insurance as herein below set forth below:
 - (A) Workers' Compensation Insurance (including Employer's Liability Insurance) with limits as specified in Schedule A, which limit may be met by a combination of primary and excess insurance meeting the statutory limits of New York State. The policy shall be endorsed to include Longshoreman's and Harbor Workers' Compensation Act/Maritime Coverage Endorsement and/or Jones Act Endorsement when applicable.
 - (B) Commercial General Liability Insurance (I.S.O. 2001 Form or equivalent) approved by Permitter in the Permittee's name with limits of liability as specified in Schedule A for each occurrence on a combined single limit basis for injuries to

persons (including death) and damages to property. The limits may be provided in the form of a primary policy or combination of primary and umbrella/excess policy. When the minimum contract amounts can only be met when applying the umbrella/excess policy; the Umbrella/Excess Policy must follow form of the underlying policy and be extended to "drop down" to become primary in the event primary limits are reduced or aggregate limits are exhausted. Such insurance shall be primary and non-contributory to any other valid and collectable insurance and must be exhausted before implicating any Permittor/MTA policy available.

Such policy should be written on an occurrence form; and shall include:

- Contractual coverage for liability assumed by the Permittee under this agreement;
- Personal and Advertising Injury Coverage;
- Products-Completed. Operations;
- Independent Contractors Coverage;
- "XCU" coverage (Explosion, Collapse, and Underground Hazards) where necessary;
- Contractual Liability Exclusion, applicable to construction or demolition operations to be performed within 50 feet of railroad tracks, must be voided, where necessary; and,
- Additional Insured Endorsement (I.S.O. Form CG 20 26 07/04 version or equivalent) approved the Permittor naming:

New York City Transit Authority (NYCTA), the Manhattan and Bronx Surface Transit Operating Authority (MaBSTOA), the Staten Island Rapid Transit Operating Authority (SlRTOA), MTA Capital Construction Co., the Metropolitan Transportation Authority (MTA) including its subsidiaries and affiliates, and the City of New York (as Owner).

- (C) Business Automobile Liability Insurance Policy - (I.S.O. Form CA 00 01 10 01 or equivalent) approved by the Permittor is required if Permittee's vehicle enters Permittor property. The insurance must be in the name of the Permittee or its contractor entering the Permittor property with limits of liability in the amount specified in Scheule "A" for claims for bodily injuries (including death) to persons and for damage to property arising out of the ownership, maintenance or use of any owned, hired or non-owned motor vehicle.

- (D) Railroad Protective Liability Insurance policy shall be required as specified in Schedule A.
- (E) Environmental/Pollution Exposures

In the event environmental or pollution exposures exist, the Permittee shall require the environmental contractor or subcontractor to provide the applicable insurance covering such exposure. The limits and type of insurance provided shall be satisfactory to the Permitter and will be confirmed to the parties prior to the start of the work.

2. General Requirements Applicable to Insurance Policies

- a) All of the insurance required by this Article shall be with Companies licensed or authorized to do business in the State of New York with an A.M. Best Company rating of not less than A-/VII or better and reasonably approved by the Permitter/MTA and shall deliver evidence of such policies.
- b) Except for Workers Compensation, all references to forms and coverages referred to above shall be the most recent used by the Insurance Services Office, Inc. (ISO") or equivalent forms approved by the Insurance Department of the State of New York, provided, however, that excess coverages may be written on forms reasonably acceptable to Permitter containing provisions other than those contained in ISO forms but otherwise conforming in substance to the requirements of this Article.
- c) The Permittee or its Contractor performing the work shall furnish evidence of all policies before any work is started to the permitter:

For NYCT Contract Inspection
C/O Mr. John Malvasio
Director, MOW Engineering
130 Livingston Street, Room 8044F
Brooklyn, NY 11201
Telephone: (718) 694-1358

These policies must: (i) be written in accordance with the requirements of the paragraphs above, as applicable; (ii) be endorsed in form acceptable to include a provision that the policy will not be canceled, materially changed, or not renewed, unless otherwise indicated herein, at least thirty (30) days prior written notice to the Permitter c/o MTA Risk and Insurance Management (MTA RIM) Department - Standards, Enforcement & Claims Unit, 2 Broadway - 21st floor, New York, NY 10004; and (iii) state or be endorsed to provide that the coverage afforded under the contractor's policies shall apply on a primary and not on an excess or contributing basis with any policies which may be available to the Permitter/MTA, and also that the contractor's policies, primary and excess, must

be exhausted before implicating any Permitter/MTA policy available. (iv) In addition, contractor's policies shall state or be endorsed to provide that, if a subcontractor's policy contains any provision that may adversely affect whether contractor's policies are primary and must be exhausted before implicating any Permitter/MTA policy available, contractor's and subcontractor's policies shall nevertheless be primary and must be exhausted before implicating any Permitter/MTA policy available. Except for Professional Liability, policies written on claims made basis are not acceptable. At least two (2) weeks prior to the expiration of the policies, contractor shall endeavor to provide evidence of renewal or replacement policies of insurance, with terms and limits no less favorable than the expiring policies. Except as otherwise indicated in the detailed coverage paragraphs below, self insured retentions and policy deductibles shall not exceed \$100,000, unless such increased deductible or retention is approved by Permitter/MTA. The Permittee shall be responsible for all claim expense and loss payments within the deductible or self-insured retention. The insurance monetary limits required herein may be met through the combined use of the insured's primary and umbrella/excess policies.

- d) Certificates of Insurance may be supplied as evidence of policies of the above policies, except for Policy (D) Railroad Protective Liability Insurance Policy. However, if requested by the Permitter, the Permittee shall deliver to the Authority, within forty-five (45) days of request, a copy of such policies, certified by the insurance carrier as being true and complete. The Railroad Protective Liability Insurance Policy must be provided in the form of the Original Policy. A detailed Insurance Binder may be provided, ACORD or Manuscript Form, pending issuance of the Original Policy. The Original Policy must be submitted to MTA RIM within 30 days of the Binder Approval.
- e) If a Certificate of Insurance is submitted, it must: (1) be provided on the Permitter Certificate of Insurance Form or MTA Certificate of Insurance Form for Joint Agency Agreements; (2) be signed by an authorized representative of the insurance carrier or producer and notarized; (3) disclose any deductible, self-insured retention, sub-limit, aggregate limit or any exclusions to the policy that materially change the coverage; (4) indicate the Additional Insureds and Named Insureds as required herein, along with a physical copy of the Additional Insured Endorsement (I.S.O. Form CG 20 26 07/04 version or equivalent), as applicable and the endorsement(s) must include policy number(s); (5) reference the Contract by number on the face of the certificate; and (6) expressly reference the inclusion of all required endorsements.

- f) The minimum amounts of insurance required in the detail description of policies (A), (B), (C), and (D) above shall not be construed to limit the extent of the Permittee's liability under this Agreement.
- g) If, at any time during the period of this Agreement, insurance as required is not in effect, or proof thereof is not provided to the Permitter, the Permitter shall have the options to: (i) direct the Permittee to suspend work or operation with no additional cost or extension of time due on account thereof; or (ii) treat such failure as an Event of Default.

F. CONTRACT ITEMS THAT INCLUDE BACKFILL AS A PART OF THEIR WORK. The following shall pertain to all contract items that have backfill as a part of their work: Backfilling shall comply with Subsection 4.11.3 of the Standard Specifications and no additional payment will be made for any Highway or Street Lighting work item requiring Contractor to furnish additional fill material to meet these requirements when backfilling.

G. NOISE CONTROL. The Contractor is directed to Title 24, Chapter 2 of the Administration Code of the City of New York, known as the "New York City Noise Code" by the Department of Environmental Protection. The provisions of this code and its most recent additions and revisions shall apply to this contract. In the event of a conflict between the requirements of the New York City Noise Code and the requirements of Noise Control contained in these special notes, the more stringent of the two shall apply.

The Contractor shall plan and carry out work on this Project to ensure that the noise from construction equipment and activities does not exceed the limits specified herein. The noise abatement operations and conditions specified shall be carried out by the Contractor to limit noise in project and adjacent areas. The Contractor shall conduct a continuous educational effort for the workers on the site to ensure that they are aware of their roles in minimizing noise propagating from the site.

In order to monitor noise abatement operations the Contractor shall employ services of "Noise Control Specialist" for the duration of construction activity. The contractor shall submit qualifications and experience of the prospective specialist/firm to the Engineer for prior approval. The specialist/firm must satisfy the eligibility requirements of qualifications and work experience as required by the N.Y.C.D.E.P.

The monitoring protocol shall be as follows:

- (a) There shall be one outdoor and one indoor monitoring station for each work area or 1,000 ft. of street length whichever is less.

- (b) Monitoring of noise level shall be done prior to start of construction and during construction for each station at the same work hours specified in the contract.
- (c) Locations of monitoring stations shall be recommended by the noise control specialist for approval of the Engineer.
- (d) Engineer shall provide indoor station locations to the contractor after ascertaining availability of the said station from the Community Board.

Should the Contractor fail to carry out the noise abatement operations and conditions specified herein, the Engineer shall have the authority to suspend all work until such time as the Engineer deems that the Contractor has complied with the requirements.

The following additional requirements for noise control shall apply to this contract:

1. Noise Level Requirements for Construction Equipment

- (a) The Contractor shall ensure that all Contractor and Subcontractor equipment, of the types listed in Table A to be used on-site for a total duration greater than 5 days, shall be tested for compliance with the stated noise emission limits during the first day of use on the construction site or at an alternative site acceptable to the Engineer.
- (b) All equipment as described in (a) above shall be re-tested at 6 month intervals while in use on site.
- (c) All compliance tests shall be performed by the Contractor.
- (d) For each piece of equipment tested, the Contractor shall provide a noise report to the Engineer as shown in Figure A.
- (e) Equipment of the types listed in Table A, as described above, shall not be used on-site without valid certificates of noise compliance.
- (f) The Contractor shall provide to the Engineer two noise meters meeting the requirements of Section 2(d) herein. Two acoustic calibrators of the type recommended by the meter manufacturer shall also be provided.

TABLE A

CONSTRUCTION EQUIPMENT NOISE EMISSION LIMITS:
MEASURED AT 50 FEET FROM CONSTRUCTION EQUIPMENT

<u>Equipment Category</u>	<u>Noise Level, dBA(SLOW)</u>
Auger	83
Backhoe	80
Bar Bender	80
Cherry Picker	80
Chain Saw	86
Compactor	80
Compressor	70
Concrete Mixer	86
Concrete Pump	82
Concrete or Diamond Saw	90
Crane	86
Crawler Miller	90
Dozer	86
Front End Loader	80
Generator	82
Gradall	86
Grader	86
Jackhammer	88
Man Lift	80
Mounted Impact Hammer	95
Paver	86
Pneumatic Tools	86
Roller	80
Scraper	86
Shotcrete Liner (tire-mounted)	79
Striper (walk-behind)	80
Tractor	84
Traffic Line Remover	80
Truck (including truck-mounted equipment)	84
Vibrator	80
Vibratory Pile Driver	95
All Other Equipment with Engines	
Larger than 3750W	86
Impact Pile Driver	105 dBC(FAST)

FIGURE A

CERTIFICATE OF EQUIPMENT NOISE COMPLIANCE

Contractor Name: _____
Contract Name & Number: _____

Equipment Type: _____
Manufacturer & Model Number: _____
Identification Number: _____
Rated Power & Capacity: _____
Operating Condition During Test: _____

Measured Sound Levels at 6 to 15 meters:

Measured Values and Distance:

Engine-Powered or Concrete-Breaking Equipment:
Right Side: _____ dBA (SLOW), at _____ meters
Left Side: _____ dBA (SLOW), at _____ meters

Impact Pile Driving Equipment:
Right Side: _____ dBC (FAST), at _____ meters
Left Side: _____ dBC (FAST), at _____ meters

Equivalent Values at 50 Feet Distance:

Engine-Powered or Concrete-Breaking Equipment:
Right Side: _____ dBA (SLOW).
Left Side: _____ dBA (SLOW).

Impact Pile Driving Equipment:
Right Side: _____ dBC (FAST).
Left Side: _____ dBC (FAST).

Maximum Values Allowed for this Equipment: _____ dBA (SLOW) at 15 meters
_____ dBC (FAST) at 15 meters

If equipment sound level exceeds maximum value allowed, indicate action taken to achieve compliance:

Name, Work Address & Phone No. _____
of NYSDOT Inspector _____

Authorized Signature: _____ Date: _____

CONTRACTOR'S ACCEPTANCE: _____ Date: _____

2. Noise Level Test Procedures of Construction Equipment

- (a) All engine-powered equipment shall be operated by the Contractor or Contractor's representative at high idle (maximum governed rpm) under full load conditions during the tests.
- (b) Portable and mounted impact hammers, such as hoe rams and jackhammers to be used to concrete breaking, shall be tested during the first day of actual operation at the construction site under maximum load conditions as rated by the equipment manufacturer.
- (c) Pile driving equipment shall be tested at the construction site under maximum load conditions as rated by the manufacturer.
- (d) All noise certification measurements shall be performed with an instrument that is in compliance with the criteria for a Type 1 (Precision) or Type 2 (General Purpose) Sound Level Meter as defined in the current revision of ANSI Standard S1.4. An acoustic calibrator of the type recommended by the sound level meter manufacturer shall be used prior to all measurements.
- (e) If possible, measurements shall be made at 50 feet (± 1.5 feet) from the right and left sides of the equipment casing, at a height of 5 feet above ground level, with the equipment operating as indicated in items (a), (b) or (c) above for a minimum period of 1 minute. Measurements made at less than 50 feet, because of space limitations at the test site, shall be reduced by the values given in Table B to estimate the 50-foot sound level.

TABLE BADJUSTMENTS FOR CLOSE-IN EQUIPMENT NOISE MEASUREMENTS

Measurement Values to be Subtracted from Measured Sound Level
Distance (Feet) to Estimate Sound Level at 50 Feet (dBA)

20 to under 21	8
21 to under 23	7
23 to under 26	6
26 to under 29	5
29 to under 33	4
33 to under 37	3
37 to under 41	2
41 to under 47	1
47 to under 50	0

3. Compliance with Equipment Noise Level Requirements

- (a) The Engineer shall retain a copy of the noise report from the Contractor with each piece of equipment used on the project of the types listed in Table A. The report shall be on the form shown in Figure A with certification by the noise control specialist hired by the contractor that equipment noise emissions do not exceed those prescribed.
- (b) If the noise levels obtained during the tests exceed those specified in Table A the Contractor shall promptly modify or alter such equipment and retest, or substitute other equipment to meet the noise level requirements.
- (c) Upon compliance, (including the certification date and equipment identification number) the Engineer will keep the noise reports readily available on file in the Construction field office for inspection upon request.
- (d) The Certification of Noise Compliance will remain valid for a period of 6 months only. Delays caused by certification refusal or by time lost in improving the rejected equipment or finding alternate acceptable equipment shall not be a basis for any monetary or time delay claims or for avoidance of late completion penalties.
- (e) All equipment shall be subject to spot noise level testing by the Engineer at his discretion as necessary to determine that the equipment in use meets the requirements specified in Table A. For this purpose, the Contractor shall furnish noise-measurement instrumentation that complies with the standards specified in paragraph 2. (d). If such tests are requested by the Engineer, the Contractor shall locate and operate the equipment as directed by the Engineer so as to facilitate the measurements. The Engineer shall provide the Contractor with a copy of the results of the measurements. If such tests demonstrate that any equipment does not comply with the requirements specified in Table A, its Certificate of Noise Compliance shall be revoke and equipment shall be taken out of use until compliance is achieved. A new Certificate of Noise Compliance will then be issued.

4. Construction Noise Level Exposure Limits

- (a) In no case shall the public be exposed to construction noise levels exceeding 100 dBA (SLOW) or to impulsive noise levels exceeding 125 dBC (FAST).
- (b) Construction activities shall be conducted in such a manner that the equivalent noise level (Leq) over any one-hour period does not exceed 85 dBA at any noise-sensitive locations (e.g. residence and hotels).

5. Construction Noise Level Exposure Test Procedures

- (a) All noise exposure measurements will be performed with an integrating sound level meter. An acoustic calibrator will be used prior to all measurements.
- (b) The measurement microphone of the sound level meter shall be fitted with an appropriate windscreen, and will be located 1.5 meters above the ground and at least 5 feet away from the nearest sound-reflective surface for the tests.
- (c) Noise exposure measurements will be taken at noise-sensitive locations closest to the construction activities at least once each week and as dictated by construction activities. Measurement periods at each location shall be a minimum of one hour.
- (d) Construction noise exposure measurements will coincide with periods of maximum noise-generating construction activity, and will be performed during the construction phase or activity that the greatest potential to create annoyance or to exceed the noise exposure limits.

6. Compliance with Construction Noise Level Exposure Limits

- (a) Construction noise exposure data will be collected by the Contractor on a weekly basis. The noise report will include (1) a sketch indicating the locations of the measurements and of all nearby construction equipment operating during the measurement period, (2) the measured maximum A-weighted noise level at each location, in terms of dBA (SLOW), (3) the measured maximum C-weighted noise level, in terms of dBC (FAST) and (4) the measured one-hour Leq (in dBA).
- (b) In the event that the measured noise levels exceed the limits specified in paragraph 4 above, the Engineer will immediately notify the Contractor and the Contractor shall implement corrective actions as directed by the Engineer.
- (c) All construction activities will be subject to spot noise level testing by the Engineer at his discretion as necessary to determine that the noise levels meet the exposure limits specified in paragraph 4 above. If such tests demonstrate that the noise levels exceed the specified limits, the Contractor shall implement corrective actions as directed by the Engineer.

7. General Requirements for Construction Equipment Noise Control

- (a) The Contractor shall minimize the use of impact devices, such as jackhammers, pavement breakers, and hoe rams. Where possible, concrete crushers or pavement saws shall be used

rather than hoe rams for tasks such as grillage removal and pavement demolition.

- (b) All pneumatic impact tools and equipment used at the construction site shall have intake and exhaust mufflers recommended by the manufacturers thereof, to meet relevant noise ordinance limitations.
 - (c) All impact devices (i.e. jackhammers and pavement breakers) shall be equipped with acoustically attenuating shields or shrouds recommended by the manufacturers thereof, to meet relevant noise ordinance limitations.
 - (d) Hoppers, conveyors transfer points, storage bins, and chutes shall be lined or covered with sound-deadening material.
 - (e) The Contractor shall minimize the use of air or gasoline-driven hand tools.
 - (f) All other equipment, including internal combustion engines, shall have mufflers and shield paneling recommended by the manufacturers thereof.
8. General Operational Requirements for Construction Noise Control
- (a) The Contractor shall operate equipment so as to minimize banging, clattering, buzzing, and other annoying types of noises, especially near noise-sensitive locations.
 - (b) The Contractor, to the extent feasible, shall configure the construction site in a manner that keeps noisier equipment and activities as far as possible from noise-sensitive locations and nearby buildings.
 - (c) The Contractor shall minimize noise from the use of backup alarms near residential buildings by using self-adjusting, ambient noise-sensitive backup alarms that meet OSHA regulations.
 - (d) In no case shall the above restrictions limit the Contractor's responsibility for compliance with all applicable Federal, state and local safety ordinances and regulations and other sections of these construction specifications.
9. Acoustic Shed Requirements
- (a) All noise-generating mechanical equipment that is operated by the Contractor at any time other than weekdays between the hours of 7:00 a.m. and 6:00 p.m. shall be enclosed within an acoustic shed. Such equipment includes, but is not limited to, generators for traffic sign boards and lighting.

- (b) Acoustic sheds shall consist of three-sided, closed-top enclosures, oriented such that the open end of the shed faces away from residential or hotel buildings.
- (c) The shed shall be constructed of 0.5 inch plywood sheeting, or other acceptable material weighing at least 1.5 pounds per square foot, on timber framing with no gaps at joints or corners. Gaps between the bottom edge of the shed panels and the ground shall not exceed 1 inch in width and shall be closed off with solid strips of rubber, neoprene or other suitably dense material.
- (d) The inside of the shed shall be lined with glass fiber or mineral wool type sound-absorbing material at least 2 inches thick, protected by wire mesh or perforated sheets that have at least 30 percent open area.

10. Cost of Work

- (a) The cost of all labor, materials, equipment, insurance necessary for noise abatement measures as described in this section, any necessary modifications of construction methods or equipment and any delays to construction due to work suspension due to non-compliance with noise control requirements or due to necessary modifications to construction methods for compliance with the noise control requirements is deemed included in the prices bid for the items of work for which the equipment is used.

H. SCHEDULING PRESENTATION. The Contractor shall submit construction schedule in the form of a bar chart using "Microsoft Project 2010", or in an approved equivalent program which shall be directly and fully translatable into Microsoft Project 2010 format, within seven days of the initial Pre-Construction Meeting. Each bar in the chart shall show dates the Contractor plans to start and complete each construction activity after the initial Pre-Construction Meeting. Bar chart shall show the order and interdependence of all activities necessary to complete the work and the sequence in which activity is to be accomplished as planned by the Contractor and in accordance with all subcontractors or suppliers whose work shall be shown on the bar chart. The Contractor shall submit the bar chart for the Engineer's review and revise it, if required, until approved by the Engineer.

The Contractor shall submit weekly progress status update reports or as otherwise directed by the Engineer. The Contractor shall submit updated bar chart every month. The revised bar chart shall be made in the same form and detail as the original submittal and shall be accompanied by an explanation of the reasons for the revisions all of which shall be subject to approval by the Engineer.

I. ACCELERATED PROJECT SCHEDULE AND COMBINATION OF STAGES.

Contractor shall plan and/or stage its work schedule using all hours/days available. Contractor is advised that all applicable unit prices shall include, for the purpose of this contract, all overtime costs, premium time costs, shift differentials required to complete construction within the specified "Time(s) of Completion" stipulated in this contract.

Contractor shall be permitted to accelerate this project, to combine stages and/or work sequences. Any such changes shall be shown in the construction schedule, to be furnished in accordance with the General Provisions of the Standard Specifications and the above "SCHEDULING PRESENTATION" Article, and shall be submitted for approval of the Engineer.

J. NO EXTENSION OF TIME FOR WINTER SHUT-DOWN. Where the Contractor's approved work schedule for installing sidewalk, curb, roadway base and/or pavement falls within the winter period of December 1st through April 1st, the Contractor will NOT be granted an extension of time for completion of this contract due to the winter shut-down period, unless otherwise provided in Schedule A.

K. PRIVATE UTILITY HARDWARE ADJUSTMENTS will be performed by the owning utility company or its agent, at its expense. The Contractor shall notify the utility company 72 hours prior to start of work at each location where its hardware requires adjustment.

L. SURVEY MONUMENTS. When working in the vicinity of survey monument the Contractor shall hand excavate per Item 8.02 A and 8.02 B at City Survey Monuments, for a distance of five (5) feet around each monument, as directed by the Engineer.

M. RESTORATION OF ADJACENT AREAS. The Contractor shall be required to remove all form work. In planting strip areas, the Contractor shall be required to restore areas damaged as a result of his operations, to the satisfaction of the Engineer, with sod. The Contractor shall also, as directed by the Engineer, make safe adjacent areas to his work, such as: restoring missing or damaged pavement markings that were removed or damaged as a result of the Contractor's operations (as per requirements of Section 6.44 in the Standard Specifications); resetting granite blocks in tree pits; and, applying asphaltic concrete mixture (Item 4.02 CB) where badly broken sidewalk or curb may create a dangerous condition just outside his area of operation, where and when directed by the Engineer.

All restoration work shall be done to the satisfaction of the Engineer.

N. THE CONTRACTOR IS NOTIFIED that for use of City water under this project the Contractor shall be required to obtain a water use permit from the Department of Environmental Protection at the Contractor's own cost.

O. THE CONTRACTOR IS NOTIFIED that the fuel cost per gallon used in the formula under Sub-Article 26.2.8 of the Standard Construction Contract for **Extra Work** will be derived from the fuel price index for the United States East Coast published weekly by the United States Energy Information Administration ("USEIA"), and available on its website at <http://www.eia.gov/petroleum/gasdiesel/>. The USEIA-published cost per gallon for the applicable fuel on the East Coast for the week in which the first day of each calendar quarter during the contract term occurs (i.e., January 1st, April 1st, July 1st and September 1st) will be used in the reimbursement formula for all **Extra Work** invoiced that was performed during that calendar quarter. Should the USEIA stop publishing this fuel price index, the fuel cost per gallon will be determined by reference to a substitute index to be agreed upon by the Contractor and the City.

P. THE CONTRACTOR IS NOTIFIED that wherever the Item No. "6.52" and words "flagger" and "flagperson" are used in the Contract Documents and Drawings it shall mean the Item No. "6.52 FED" and the words "Uniformed Flagperson".

Q. START OF CONTRACT WORK. The Contractor is notified that a Notice To Proceed (NTP) date will be issued for work to commence within 21 to 30 Days of Contract Registration.

R. PRICES TO INCLUDE. No direct payment will be made for costs incurred in complying with the foregoing Special Provisions, unless otherwise provided. Said costs will be deemed to have been included in the prices bid for all the scheduled contract items.



Department of Transportation

POLLY TROTTEBERG, Commissioner

OCMC TRAFFIC STIPULATIONS

July 31, 2014

OCMC FILE NO: QEC 14-311
 CONTRACT NO: HWPEDSF1
 PROJECT: MULTI-SITE PEDESTRIAN SAFETY

LOCATION(S): VARIOUS LOCATIONS

PERMISSION IS HEREBY GRANTED TO THE NEW YORK CITY DEPARTMENT OF DESIGN AND CONSTRUCTION AND ITS DULY AUTHORIZED AGENT, TO ENTER UPON AND RESTRICT THE FLOW OF TRAFFIC AT THE ABOVE LOCATION(S) FOR THE PURPOSE OF CARRYING OUT THE ABOVE NOTED PROJECT, SUBJECT TO THE STIPULATIONS, AS NOTED BELOW:

A. SPECIAL STIPULATIONS

1. **EMBARGOES** – A CONSTRUCTION EMBARGO WILL APPLY TO THOSE LOCATIONS BELOW WHICH FALL WITHIN THE **HOLIDAY EMBARGO** OR ANY OTHER SPECIAL EVENT EMBARGOES SUCH AS PUBLISHED BY THE BUREAU OF PERMIT MANAGEMENT AND CONSTRUCTION CONTROL.
2. **BIKE LANES** – IF WORK IS IN OR AFFECTING A BIKE LANE, THE PERMITTEE MUST POST ADVANCE WARNING SIGNS 350 FEET AND 200 FEET PRIOR TO THE WORK ZONE STATING "**CONSTRUCTION IN BIKE LANE AHEAD PROCEED WITH CAUTION**", AND ALSO POST A SIGN AT THE WORK ZONE STATING "**CONSTRUCTION IN BIKE LANE PROCEED WITH CAUTION**". SUCH SIGNS SHALL BE ORANGE, 3' X 3', DIAMOND-SHAPED WITH 4" BLACK LETTERING. SIGNS SHALL BE POSTED IN ACCORDANCE WITH THE FEDERAL MANUAL ON UNIFORM TRAFFIC CONTROL DEVICES (MUTCD).
3. **BIKE SHARE STATIONS**: THE PERMITTEE SHALL NOT REMOVE, RELOCATE, DAMAGE OR DISRUPT THE OPERATION OF EXISTING BIKE SHARE STATIONS WITHOUT FIRST CONTACTING NYC BIKE SHARE AT 855-245-3311 FOR THEIR REQUIREMENTS PRIOR TO COMMENCING WORK.
4. **BUS STOPS** – THE PERMITTEE SHALL PROVIDE WRITTEN NOTICE TO NYC DOT OCMC AND NEW YORK CITY TRANSIT (NYCT) A MINIMUM OF FIVE (5) WEEKS IN ADVANCE FOR LANE/STREET CLOSURES THAT AFFECT BUS ROUTES/BUS STOPS.
5. **STREET LIGHTS / TRAFFIC SIGNALS**: THE PERMITTEE SHALL NOT REMOVE OR RELOCATE EXISTING STREET LIGHTS OR TRAFFIC SIGNALS WITHOUT FIRST OBTAINING APPROVAL FROM NYCDOT STREET LIGHTING / TRAFFIC SIGNALS UNIT.
6. **TRAFFIC CAMERAS, DETECTION/COMMUNICATION EQUIPMENT**: IF AT ANY TIME DURING THE APPROVED WORK, THE PERMITTEE ENCOUNTERS TRAFFIC SURVEILLANCE CAMERAS, DETECTION EQUIPMENT OR ANY TYPE OF COMMUNICATION EQUIPMENT (WIRELESS OR HARD-WIRED) ON ANY NYC DOT FACILITY, THAT IS NOT INCLUDED ON THE DESIGN/BUILD DRAWINGS, THE PERMITTEE SHALL IMMEDIATELY NOTIFY NYC DOT TRAFFIC MANAGEMENT BY PHONE AT 718-433-3390 OR 718-433-3340 AND VIA EMAIL AT TMC@DOT.NYC.GOV AND AWAIT DIRECTION PRIOR TO CONTINUING WORK.
7. **METERS** – THE PERMITTEE SHALL NOT REMOVE OR RELOCATE PARKING METERS WITHOUT FIRST OBTAINING APPROVAL FROM NYCDOT PARKING METER DIVISION AT 718-894-8651.
8. **TEST PITS** – THE BELOW TRAFFIC STIPULATIONS DO NOT APPLY TO TEST PIT WORK RELATED TO THIS CONTRACT. WORK HOURS AND OTHER REQUIREMENTS FOR TEST PIT OPERATIONS MAY DIFFER FROM THE STIPULATIONS IDENTIFIED BELOW. THE PERMITTEE SHALL BE REQUIRED TO OBTAIN SEPARATE PERMITS RELATED TO TEST PITS.
9. **TEMPORARY PARKING REGULATIONS/PAVEMENT MARKINGS** – THE PERMITTEE IS REQUIRED TO INSTALL, MAINTAIN AND REMOVE ALL NECESSARY TEMPORARY PARKING AND REGULATORY SIGNS AND PAVEMENT MARKINGS, AND RESTORE THEIR ORIGINAL CONDITION PER NYC DOT STANDARDS, PRIOR TO EXPIRATION OF THEIR PERMITS. THE PERMITTEE OR AGENCY PERFORMING PUBLIC OUTREACH SHALL POST AND MAINTAIN ADVISORY SIGNS A MINIMUM OF 48 HOURS PRIOR TO CHANGING EXISTING PARKING REGULATION SIGNS TO APPROVED TEMPORARY CONSTRUCTION PARKING REGULATION SIGNS. THE ADVISORY SIGNS SHOULD BE POSTED ON ALL POLES AND DRIVE RAILS ON THE SEGMENT AFFECTED, INDICATING THE DATE OF THE CHANGE, THE NEW REGULATIONS AND A TELEPHONE NUMBER TO OBTAIN MORE INFORMATION.
10. **ACCESS TO ABUTTING PROPERTIES** – THE PERMITTEE SHALL COORDINATE ALL ACTIVITIES WITH ABUTTING PROPERTY OWNERS TO ENSURE ACCESS IS PROVIDED TO/FROM ENTRANCES/DRIVEWAYS AT ALL TIMES.
11. **AUTHORIZED PARKING** – PRIOR TO PERFORMING WORK WHICH IMPACTS AUTHORIZED PARKING, THE PERMITTEE SHALL SUBMIT IN WRITING, AND COPY OCMC-STREETS, A REQUEST TO OCCUPY SPACE CURRENTLY USED BY AUTHORIZED VEHICLES. APPROVAL MUST BE RECEIVED FROM AUTHORIZED PARKING PRIOR TO OCCUPYING THESE AREAS.

NYC Department of Transportation
 Bureau of Permit Management and Construction Control
 55 Water Street – 7th Floor, New York, NY 10041
 T: 212.839.9621 F: 212-839-8970
www.nyc.gov/dot

OCMC FILE NO: QEC 14-311
 CONTRACT NO: HWPEDSF1
 PROJECT: MULTI-SITE PEDESTRIAN SAFETY

July 31, 2014
 Page 2 of 4

12. **NOTIFICATION** – THE PERMITEE MUST AT LEAST TWO (2) WORKING DAYS BEFORE THE START OF CONSTRUCTION NOTIFY THE NYC FIRE DEPARTMENT, NYC POLICE DEPARTMENT, NYCEMS, LOCAL COMMUNITY BOARD, BOROUGH PRESIDENT'S OFFICE-CHIEF ENGINEER, NYCDOT OCMC OFFICE, AND ALL ABUTTING PROPERTY OWNERS.
13. **CONSTRUCTION INFORMATIONAL SIGNS** – THIS PROJECT REQUIRES A CONSTRUCTION PROJECT INFORMATIONAL SIGN (CPIS) IN ACCORDANCE WITH NYCDOT HIGHWAY RULE SECTION 2-02 (4) AND (5). CRITERIA AND A PROTOTYPE FOR THIS SIGN MAY BE FOUND ON THE NYCDOT WEBSITE AT:

[HTTP://WWW.NYC.GOV/HTML/DOT/DOWNLOADS/PDF/DOT_CPIS_DIRECTIONS.PDF](http://www.nyc.gov/html/dot/downloads/pdf/dot_cpis_directions.pdf)

14. **ENHANCED MITIGATIONS**
- o "NO STANDING ANYTIME-TEMPORARY CONSTRUCTION" SIGNS AND TEMPORARY PAVEMENT MARKINGS SHALL BE INSTALLED AND MAINTAINED AS WARRANTED BY THE MAINTENANCE AND PROTECTION OF TRAFFIC (MPT) REQUIRED TO FACILITATE TRAFFIC MOVEMENTS THROUGH THE WORK ZONE. ALL TEMPORARY SIGNS AND PAVEMENT MARKINGS SHALL BE REMOVED UPON COMPLETION OF THE PROJECT.
 - o **COMMUNITY OUTREACH** SHALL BE PROVIDED FOR THE DURATION OF THE PROJECT.

B. MAINTENANCE AND PROTECTION OF TRAFFIC

NOTE:

- NYCCDC MUST PERFORM ALL WORK IN COORDINATION WITH NYCT (CONTRACT NUMBERS A-36915, A-36954 AND A-36953) AND OBTAIN CONCURRENCE FROM NYCT FOR APPROVAL TO WORK IN SAME AREA AS NYCT. SHOULD TWO PROJECTS OCCUR SIMULTANEOUSLY OCMC WILL REQUIRE WRITTEN APPROVAL FROM NYCT PRIOR TO ISSUING ANY CONSTRUCTION PERMITS.
- MUST ACCOMMODATE TRUCK DELIVERIES TO BUSINESSES THAT ARE WITHIN THE CONSTRUCTION ZONE.

31ST STREET BETWEEN 40TH AVENUE AND 38TH AVENUE

31ST STREET BETWEEN 35TH AVENUE AND 37TH AVENUE

31ST STREET BETWEEN 34TH AVENUE AND 31ST AVENUE

39TH AVENUE BETWEEN 30TH STREET AND 32ND STREET

36TH AVENUE BETWEEN 30TH STREET AND 32ND STREET

BROADWAY BETWEEN 30TH STREET AND 32ND STREET

- Work hours shall be as follows: 7:00 AM to 6:00 PM, Monday – Friday
8:00 AM to 6:00 PM, Saturday
9:00 AM to 6:00 PM, Sunday
- The Permittee shall maintain a minimum 5-foot clear path on the sidewalk for pedestrian access at all times.
- The Permittee shall occupy a maximum of 8 feet adjacent to the curb.
- The Permittee must maintain one 11 foot lane on one-way streets and two 11 foot lanes on two-way streets for traffic at all times.
- The Permittee may close one pedestrian crosswalk during working hours with signage and flaggers. After working hours all crosswalks are restored for pedestrians.

INTERSECTION OF 31ST STREET AND 39TH AVENUE

INTERSECTION OF 31ST STREET AND 36TH AVENUE

INTERSECTION OF 31ST STREET AND BROADWAY

- Work hours shall be as follows: 7:00 AM to 6:00 PM, Monday – Friday
8:00 AM to 6:00 PM, Saturday
9:00 AM to 6:00 PM, Sunday
- The Permittee shall maintain a minimum 5-foot clear path on the sidewalk for pedestrian access at all times.
- The Permittee must maintain one 11 foot lane on one-way streets and two 11 foot lanes on two-way streets for traffic at all times.
- The contractor must restore the full width of the roadway after working hours.
- The Permittee may close one pedestrian crosswalk during working hours with signage and flaggers. After working hours all crosswalks are restored for pedestrians.

OCMC FILE NO: QEC 14-311
 CONTRACT NO: HWPEDSF1
 PROJECT: MULTI-SITE PEDESTRIAN SAFETY

July 31, 2014
 Page 3 of 4

C. GENERAL NOTES

1. **THIS IS NOT A PERMIT.** THIS STIPULATION SHEET MUST BE SUBMITTED WITH ALL REQUESTS FOR PERMITS PERTAINING TO THE ABOVE CONTRACT AND PRESENT AT THE WORK SITE ALONG WITH ALL ACTIVE CONSTRUCTION PERMITS WHEN THE APPROVED WORK IS BEING PERFORMED.
2. THE CONTRACTOR MUST COMPLY WITH ALL CONSTRUCTION EMBARGOS ISSUED BY THE NYCDOT INCLUDING THE HOLIDAY EMBARGO.
3. THE CONTRACTOR SHALL COMPLY WITH ALL REQUIREMENTS OF THE NYCDOT SPECIAL EVENTS UNIT AS IDENTIFIED BELOW:
 - A. STREET FAIRS / FESTIVALS**
 - ALL EXCAVATIONS MUST BE PLATED WITH SKID RESISTANT PLATES.
 - PLATES MUST BE RECESSED AND FLUSH WITH PAVEMENT.
 - ALL PAVEMENT DEFECTS MUST BE CORRECTED WITHIN OR ADJACENT TO THE WORK ZONE.
 - THE CONTRACTOR IS RESPONSIBLE FOR ANY DEFECTS WITHIN THE IMMEDIATE VICINITY IF NYCDOT STREET & ARTERIAL MAINTENANCE CANNOT MAKE REPAIRS DUE TO PROJECT INTERFERENCE (AS DETERMINED BY NYCDOT).
 - ALL EQUIPMENT, TRAILERS AND MATERIAL STORAGE MUST BE REMOVED.
 - B. RUNNING / WALKING / BIKING EVENTS**
 - ALL EXCAVATIONS MUST BE BACKFILLED AND PAVED OR PLATES MUST BE RECESSED AND PAVED OVER FLUSH WITH PAVEMENT.
 - ALL PAVEMENT DEFECTS MUST BE CORRECTED WITHIN OR ADJACENT TO THE WORK ZONE.
 - THE CONTRACTOR IS RESPONSIBLE FOR ANY DEFECTS WITHIN THE IMMEDIATE VICINITY IF NYCDOT STREET & ARTERIAL MAINTENANCE CANNOT MAKE REPAIRS DUE TO PROJECT INTERFERENCE (AS DETERMINED BY NYCDOT).
 - ALL EQUIPMENT, TRAILERS AND MATERIAL STORAGE MUST BE REMOVED.
 - C. PARADES**
 - ALL EXCAVATIONS MUST BE BACKFILLED AND PAVED OR PLATES MUST BE RECESSED AND PAVED OVER FLUSH WITH PAVEMENT.
 - FORMATION AND DISPERSAL AREA PLATES MUST BE RECESSED AND FLUSH WITH PAVEMENT (PLATES MUST BE SKID RESISTANT).
 - ALL PAVEMENT DEFECTS MUST BE CORRECTED WITHIN OR ADJACENT TO THE WORK ZONE.
 - THE CONTRACTOR IS RESPONSIBLE FOR ANY DEFECTS WITHIN THE IMMEDIATE VICINITY IF NYCDOT STREET & ARTERIAL MAINTENANCE CANNOT MAKE REPAIRS DUE TO PROJECT INTERFERENCE (AS DETERMINED BY NYCDOT).
 - ALL EQUIPMENT, TRAILERS AND MATERIAL STORAGE MUST BE REMOVED.
 - D. MAYORAL EVENTS**
 - ALL EXCAVATIONS MUST BE BACKFILLED AND PAVED OR PLATES MUST BE RECESSED AND PAVED OVER FLUSH WITH PAVEMENT.
 - ALL PAVEMENT DEFECTS MUST BE CORRECTED WITHIN OR ADJACENT TO THE WORK ZONE.
 - THE CONTRACTOR IS RESPONSIBLE FOR ANY DEFECTS WITHIN THE IMMEDIATE VICINITY IF NYCDOT STREET & ARTERIAL MAINTENANCE CANNOT MAKE REPAIRS DUE TO PROJECT INTERFERENCE (AS DETERMINED BY NYCDOT).
 - ALL EQUIPMENT, TRAILERS AND MATERIAL STORAGE MUST BE REMOVED.
4. ALL RELOCATION WORK BY THE UTILITIES SUCH AS; CON EDISON, TELEPHONE, GAS AND CABLE COMPANIES SHALL PRECEDE THE CONTRACTORS' START OF WORK ON ALL AFFECTED ROADWAYS IN THE IMPACTED CONTRACT AREA.
5. THE CONTRACTOR IS ADVISED THAT OTHER CONTRACTORS MAY BE WORKING IN THE GENERAL AREA DURING THE TERM OF THIS STIPULATION. IN WHICH EVENT, THE CONTRACTOR MAY REQUIRE MODIFICATIONS BY THE OCMC-STREETS.
6. THE PERMITTEE IS NOT AUTHORIZED TO ENTER, OCCUPY OR USE ANY PUBLICLY-OWNED OR PRIVATELY OWNED, NON-PAVED, LANDSCAPE OR NON-LANDSCAPED LOCATION WITHOUT SPECIFIC WRITTEN PERMISSION. WHEN THE LOCATION IS WITHIN THE RIGHT-OF-WAY OF A LIMITED-ACCESS ARTERIAL HIGHWAY, **WRITTEN** APPROVAL FROM THE NYCDOT OCMC-HIGHWAYS IS REQUIRED. WHEN THE LOCATION IS WITHIN THE RIGHT-OF-WAY OF A PUBLIC STREET OR PUBLIC PARK, **WRITTEN** APPROVAL FROM THE NEW YORK CITY DEPARTMENT OF TRANSPORTATION OR NEW YORK CITY DEPARTMENT OF PARKS AND RECREATION IS REQUIRED. WHEN THE LOCATION IS WITHIN THE RIGHT-OF-WAY OF ANY OTHER JURISDICTION SUCH AS PRIVATE PROPERTY, STATE, FEDERAL ETC., IT IS THE PERMITTEE'S RESPONSIBILITY TO DETERMINE THE PROPERTY OWNER AND OBTAIN THE WRITTEN APPROVAL.
7. THE PERMITTEE SHALL ADHERE TO THE NYCDOT BUREAU OF BRIDGES' SPECIAL PROVISIONS FOR LANDSCAPE PROTECTION, MAINTENANCE AND RESTORATION, ITEMS 1.18.15 THROUGH 1.18.19, WHENEVER AND WHEREVER ANY OF THE PERMITTEE'S ACTIVITIES OCCUR WITHIN A LIMITED ACCESS ARTERIAL HIGHWAY RIGHT - OF - WAY.
8. NO DEVIATION OR DEPARTURE FROM THESE STIPULATIONS WILL BE PERMITTED WITHOUT THE PRIOR WRITTEN APPROVAL FROM THE OCMC-STREETS. REQUEST FOR SUCH MODIFICATIONS SHALL BE SUBMITTED TO THE OFFICE OF THE OCMC-STREETS, NEW YORK CITY DEPARTMENT OF TRANSPORTATION, A MINIMUM OF TWENTY (20) DAYS IN ADVANCE FOR CONSIDERATION.
9. FOR ANY CONSTRUCTION ACTIVITY RESULTING IN THE FULL CLOSURE OF A ROADWAY FOR MORE THAN 180 CONSECUTIVE CALENDAR DAYS, THE CONTRACTOR MUST PRODUCE AND SUBMIT A COMMUNITY REASSESSMENT, IMPACT AND AMELIORATION (CRIA) STATEMENT TO NYCDOT PLANNING AND OBTAIN THEIR APPROVAL BEFORE APPLYING FOR PERMITS, IN COMPLIANCE WITH THE PROVISIONS OF **LOCAL LAW 24 STREET CLOSURE LAW.**
10. FOR THIS PROJECT THE CONTRACTOR SHALL FURNISH, INSTALL AND MAINTAIN ALL NECESSARY ADVANCE WARNING AND DETOUR SIGNS, TEMPORARY CONTROL DEVICES, BARRICADES, LIGHTS AND FLASHING ARROW BOARDS IN ACCORDANCE WITH THE "MANUAL ON

OCMC FILE NO: QEC 14-311
CONTRACT NO: HWPEDSF1
PROJECT: MULTI-SITE PEDESTRIAN SAFETY

July 31, 2014
Page 4 of 4

UNIFORM TRAFFIC CONTROL DEVICES," THE TYPICAL SCHEMES INCLUDED IN THIS SPECIFICATION; AND AS ORDERED BY THE ENGINEER-IN-CHARGE AND THE OCMC-STREETS.

11. THE CONTRACTOR SHALL BE RESPONSIBLE FOR IDENTIFYING HIS CONSTRUCTION SIGNAGE. THE IDENTIFICATION SHALL INCLUDE THE CONTRACTOR'S NAME, SPONSORING AGENCY NAME AND THE CONTRACT NUMBER. THE IDENTIFICATION SHALL BE PLACED ON THE BACK OF THE SIGN. THE LETTERING SHALL BE THREE (3) INCHES HIGH.
12. THE OCMC-STREETS RESERVES THE RIGHT TO VOID OR MODIFY THESE STIPULATIONS SHOULD CONSTRUCTION FAIL TO COMMENCE WITHIN TWO (2) YEARS OF THE SIGNED DATE OF THESE STIPULATIONS.

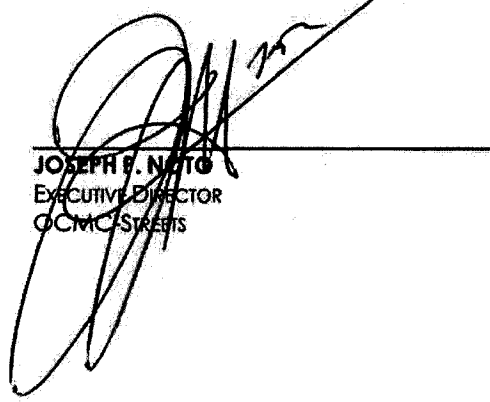

JOSEPH F. NOTO
EXECUTIVE DIRECTOR
OCMC-STREETS



XIOMARA AGUILERA
PROJECT MANAGER
OCMC-STREETS



THE CITY OF NEW YORK Department of Sanitation

S. ELIZABETH SEARLE
Assistant Commissioner
for Legal Affairs

Bureau of Legal Affairs
44 Beaver Street
New York, NY 10004
Telephone (212) 837-8110
FAX (212) 837-8243

Department of Sanitation Rules and Regulations Governing Non-Putrescible Solid Waste Transfer Stations

INTERPRETIVE MEMORANDUM # 2 February 14, 1995

*Subject: Temporary Storage and Processing of Construction and Demolition Debris
by New York City Agency Contractors*

Contractors performing construction work for New York City agencies may be required to excavate dirt, concrete, rock, gravel and similar materials ("construction materials") from a contract site or to remove from a contract site construction materials resulting from construction, demolition, alteration, repair or renovation of structures, streets or buildings. On street construction projects, construction materials required to be excavated or removed may also include asphalt. The purpose of this Interpretive Memorandum is to (a) define the circumstances under which the Department of Sanitation (the "Department") will not deem its Rules and Regulations Governing Non-Putrescible Solid Waste Transfer Stations (the "Rules") to apply to the temporary storage, processing and/or stockpiling (collectively, "stockpiling") of such construction materials and (b) the procedure for ensuring such exemption. It is the responsibility of the contracting agency to oversee its contractors' compliance with the Rules and with this Interpretive Memorandum.

1. When No Transfer Station Permit is Required

Where a City contractor has:

- (a) set aside an area of a contract site for stockpiling construction materials excavated from and/or intended for that site; or
- (b) received written approval from the contracting agency for an off-site stockpiling location,

the Department will not deem such stockpiling location a transfer station and will not require the contractor to obtain a transfer station permit so long as:

- (c) no construction materials or debris from off the contract site are received at the designated location for subsequent transfer to another location (other than the contract site); and
- (d) the temporary stockpiling location is clearly described as such in the contract or clearly approved by the construction agency and designated as such in writing to the Department by the agency; and
- (e) the construction agency represents in writing to the Department that such agency will monitor the temporary stockpiling location and ensure its clean-up and restoration pursuant to the procedures set out in this memorandum.



Help Reduce
New York's Waste.



Example: Street Construction Projects

As part of a contract for street construction, the contractor may be working at one end of a street and using an area at the other end of the street for the temporary stockpiling of construction materials. Both ends of the street are part of the construction contract site. In addition, the contractor may have leased an off-site location for temporary stockpiling of materials, which, following processing, will be reincorporated into the contract site, with some portion of the remainder designated for delivery to a Department disposal facility. Neither location will be regulated by the Department as a transfer station so long as the procedures set out in this memorandum are followed.

2. Procedure for Exemption.

Upon a City construction agency's approval of any location to be designated as a temporary processing, storage or stockpiling area, that agency must determine that (a) its contract with the contractor provides for clean-up and restoration of such area by, for example, the contractor's posting of a restoration bond and/or by contractual set-off and (b) the agency has adequate procedures for monitoring the designated area to ensure that it does not violate the provisions set forth in this memorandum and that such location is cleaned up and restored at the completion of the contract work.

The City construction agency must submit an official letter to the Department acknowledging compliance with both (a) and (b) immediately above and representing that the agency will ensure the contractor's compliance. The letter to be submitted must be in substantially the following form, addressed to the Director, Bureau of Waste Disposal, Department of Sanitation, 125 Worth Street, Room 726, New York, NY 10013:

"The New York City Department of _____ (the "Agency") has awarded a construction contract to _____ (Contractor) _____ (the "Contractor") for work to be performed at _____ (Contract Site) _____.

a. This Agency has approved the following locations to be used by the Contractor for the temporary storage, processing and/or stockpiling of construction materials (the "Stockpiling Locations") excavated from the construction site or intended for the construction site:

b. The terms of the contract require the Contractor to clean up and restore the Stockpiling Locations, whether on or off the contract site, at or before the completion of the contract work.

c. This Agency assumes responsibility for the monitoring of Stockpiling Locations to ensure that only materials received from and/or intended for the construction site are stockpiled at such locations and we will enforce clean-up and restoration of such Locations at the end of their use for temporary stockpiling or at the termination of the contract, whichever occurs earlier, through restoration

bonding requirements and/or contractual set-off provisions such that the costs of clean-up and restoration will not become a charge to the Department or the City. "

3. When a Transfer Station Permit is Required

A transfer station permit will be required under any circumstances other than those outlined above. Except in the specifically defined circumstances set forth in this memorandum, any operator of a location or facility which receives, processes, stores or stockpiles construction and demolition debris or fill material for purposes of transfer to another location, including to a New York City Department of Sanitation facility, and whether or not under contract to the Department for the delivery of such materials, will be fully subject to the Department's transfer station rules and liable for enforcement for violations.

PROJECT ID: HWPEDSF1

MULTI-SITE PEDESTRIAN SAFETY
WHICH INCLUDES THE FOLLOWING INTERSECTIONS:

31ST STREET AND 39TH AVENUE
31ST STREET AND 36TH AVENUE
31ST STREET AND BROADWAY

INCLUDING BUS BULBOUTS, CURB EXTENSIONS, BUS PADS,
PEDESTRIAN RAMPS, CATCH BASINS, PAVEMENT MARKINS,
STREET LIGHTING, AND TRAFFIC SIGNAL WORK

Together With All Work Incidental Thereto
BOROUGH OF QUEENS
CITY OF NEW YORK

ADDENDUM NO. 2

DATED: May 2, 2014

THIS ADDENDUM IS HEREBY MADE A PART OF THE CONTRACT DOCUMENTS

1. Any substantial modification of the Contract shall be subject to approval by the State Commissioner of Transportation and the Federal Highway Administration, in addition to the City agencies involved.
2. The Contractor shall be responsible for compliance with all the provisions of the following Schedules of Federal and State requirements which are hereby made a part of the original contract documents and are annexed hereto:

- Attachment "A" - Required Contract Provisions for Federal-Aid Construction Contracts - FHWA 1273
- Attachment "B" - New York State Contract Requirements - including Worker's Compensation and Liability Insurance, Appendix A - Standard Clauses for New York State Contracts, Labor and Employment, Non-Assignment of Agreement, Non-Collusive Bidding Certifications, Debarment History Certification, Appendix C (Disclosure of Lobbying Activities)
- Attachment "C" - Assurance of Non-Discrimination, Subcontracts, Appendix A-1 Supplemental Title VI Provisions (Civil Rights Act)
- Attachment "D" - Provisions Relating to the NYS Labor Law, Prevailing Wages, and the Use of Convict Labor and Materials on Federal & State Contracts
- Attachment "E" - "Buy America" Requirements & Waivers
- Attachment "F" - Equal Employment Opportunity Requirements
- Attachment "G" - NO TEXT
- Attachment "H" - Disadvantaged Business Enterprises Requirements for Federal Aid Contracts
- Attachment "I" - Requirements Regarding Training in Federal Aid Contracts - Training Special Provision
- Attachment "J" - NO TEXT
- Attachment "K" - Changed Conditions and Disputed Work Provisions, Extra Force Account Work, Dispute Compensation and Record Keeping, Differing Site Conditions, Suspensions of Work, Significant Changes in the Character of the Work Provisions
- Attachment "L" - Contractor Initiated Value Engineering Change Proposals (CIVEC)
- Attachment "M" - NO TEXT
- Attachment "N" - Itemized Proposal
- Attachment "O" - US DOT Hotline / NYS Inspector General Hotline
- Attachment "P" - Prompt Payments by the Contractor / Civil Rights Monitoring and Reporting
- Attachment "Q" - Appendix 2 - Iran Divestment Act

In addition to compliance with the above Federal and State requirements, the Contractor shall also be required to comply with all City requirements as depicted in the Information for Bidders and Standard Construction Contract herein. Wherever a conflict may exist, the Federal Regulations shall take precedence.

3. The Contractor shall not pay less than the highest minimum hourly rates as set forth by Federal, State or City laws.
4. The Contractor shall maintain his records in conformity with the current NYSDOT "Manual for Uniform Record Keeping", referred to as MURK, copies of which are available on line at the NYSDOT website www.dot.ny.gov/publications.
5. In accordance with 23 US C315 and Order 1321.1C, FHWA Directives Management, issued January 6, 2010, the construction work performed under this Contract shall be available to be subject to inspection at all times by the New York State Department of Transportation and the Federal Highway Administration.
6. Amendments to Information for Bidders:

- a) Refer to Page 6, SECTION 20. Low Tie Bids;
Delete Article 20 in its entirety and substitute the words
"20. (NO TEXT)."
- b) Refer to Pages 6 and 7, Subsection 21.(C), Rejection of All
Bids and Negotiation With All Responsible Bidders;
Delete Sub-Article 21.(C) in its entirety and substitute the
words "(C) (NO TEXT)."
- c) Refer to Pages 8 and 9, SECTION 26. Bid, Performance and
Payment Security;
Add the following:

"(F) Bidders are hereby advised that the apparent low Bidder, as determined at the bid opening or subsequently notified that its firm is the low Bidder, will be required to submit within seven (7) days a complete DBE Pre-Award Utilization Package in compliance with SECTION 102-12H of the NEW YORK STATE DEPARTMENT OF TRANSPORTATION STANDARD SPECIFICATIONS using their approved civil rights reporting software called EBO. For EBO software see Attachment 'P', CIVIL RIGHTS MONITORING AND REPORTING. Failure to submit the above documents within the specified seven (7) days after the date of the bids may be cause for a determination of non-responsiveness."

- d) Refer to Page 9, SECTION 27. Failure to Execute Contract, 6th,
7th and 8th lines;
Delete the sentence beginning with the words: "No plea of mistake in
such..." in its entirety.

- e) Refer to Page 10, SECTION 30. Labor Law Requirements, Sub-Article (A) General:
Add the following at the end of the Sub-Article (A): "This provision shall apply to subcontractors also."

- f) Refer to Page 11, Subsection 33.(B), Variations from Engineer's Estimate;
Delete Subsection 33.(B) in its entirety. See Attachment "K", Page A2-K2 and A2-K3, Significant Changes in the Character of Work, Sub-Article 3.(iv)(B).

- g) Refer to Pages 12 and 13, SECTION 37. Locally Based Enterprise Requirements (LBE);
Delete the SECTION, in its entirety. See Attachment "H" Disadvantaged Business Enterprise Utilization Requirements.

7. Amendments to Standard Construction Contract:

- a) Refer to Page 5, Sub-Article 5.2, "Procurement Policy Board Rules";
Delete the second sentence starting with the words: "In the event of..." and ending with the words "...shall take precedence."

- b) Refer to Pages 11 and 12, ARTICLE 7. PROTECTION OF WORK AND OF PERSONS AND PROPERTY; NOTICES AND INDEMNIFICATION;
Add the following:

"7.6 In addition to the requirements stipulated herein, all work performed under this Contract shall comply with the safety and health standards of the Occupational Safety and Health Administration (OSHA) of the U.S. Department of Labor."

- c) Refer to Page 13, Sub-Article 9.3;
Delete the first sentence starting with the words: "If the Contractor..." and ending with the words "...progress schedule."

- d) Refer to Pages 22 and 23, ARTICLE 16. OCCUPATION OR USE PRIOR TO COMPLETION;
Delete Sub-Article 16.1.4, in its entirety.

- e) Refer to Pages 23 and 24, ARTICLE 17. SUBCONTRACTS;
Delete Sub-Article 17.11.1, in its entirety;
Substitute the following revised Article 17.11.1:

"17.11.1 Payment to **Subcontractors**: The agreement between the **Contractor** and its **Subcontractors** shall contain the same terms and conditions as to method of payment for **Work**, labor, and materials, as are contained in this **Contract**."

- f) Refer to Page 26, ARTICLE 19. SECURITY DEPOSIT;
Delete Sub-Article 19.2, in its entirety;
Substitute the following Sub-Article 19.2:

"19.2 If performance and payment bonds are not required, the bid security shall be retained by the **City** as security for the **Contractor's** faithful performance of the Contract. If partial payments are provided, the bid security will be returned to the **Contractor** subject to the other provisions of this **Contract**. If partial payments are not provided, the bid security will be released when final payment is certified by the **City** for payment."

- g) Refer to Page 29, ARTICLE 21. RETAINED PERCENTAGE;
Delete Article 21, in its entirety;
Substitute the following:

"ARTICLE 21. (NO TEXT)"

- h) Refer to Page 36, ARTICLE 24. MAINTENANCE AND GUARANTY;
Add the following to Sub-Article 24.9:

"On any contract, which requires the furnishing and/or installing of electrical or mechanical equipment, the **Contractor** shall provide the following:

- (1) Manufacturer's warranties or guarantees on all electrical and mechanical equipment, consistent with those provided as customary trade practice.
- (2) Contractor's warranties or guarantees providing for satisfactory in-service operation of the mechanical and electrical equipment and related components for a period not less than one (1) year following project acceptance."

- i) Refer to Page 37, ARTICLE 25. CHANGES;
Add the following paragraph:

"25.5 Extra Work: It is anticipated that the preliminary engineering and the preparation of plans, specifications and contract documents have been performed with sufficient thoroughness, accuracy and care, and that changes and extra work during the construction can be held to a minimum and limited almost exclusively to revisions and additions necessitated by conditions that could not reasonably be anticipated before the project was advertised for bids or force account operations commenced."

- j) Refer to Pages 50, 51 and 52, ARTICLE 36. NO DISCRIMINATION;
Change in Paragraph 36.1.1, 4th line, "citizen of the State of New York"
to "person";
Delete Paragraphs 36.1.3, 36.1.4, 36.2.2 and 36.2.4 in their
entireties;
Add "or sex or age" to the expression "race, creed, color or national
origin", and "or sex or age" to the expression "race, color or
creed", wherever these expressions appear in Article 36.

- k) Refer to Page 59, ARTICLE 43. PROMPT PAYMENT;
Add the following sentence to the end of Sub-Article 43.5:

"The Contractor shall not hold any retainage, but may deduct an amount necessary to satisfy any claims, liens or judgements against a Subcontractor or materialman which have not been fully discharged."

- l) Refer to Pages 59 and 60, ARTICLE 44. SUBSTANTIAL COMPLETION
PAYMENT;
Delete Sub-Articles 44.2 and 44.3, in their entirety;
Substitute the following:

"44.2 The **Commissioner** shall issue a voucher calling for payment of any part or all of the balance due for **Work** performed under the **Contract**, less any and all deductions authorized to be made by the **Commissioner**, under this **Contract** or by **Law**, and less twice the amount the **Commissioner** considers necessary to ensure the completion of the balance of the **Work** by the **Contractor**. Such a payment shall be considered a Partial and not a Final Payment. No **Substantial Completion** payment shall be made under this Article 44 where the **Contractor** shall fail to complete the **Work** within the time fixed for such completion in the Schedule A of the General Conditions, or within the time to which completion may have been extended, until an extension or extensions of time for the completion of **Work** have been acted upon pursuant to Article 13.

44.3 No further partial payments shall be made to the **Contractor** after **Substantial Completion**, except the **Substantial Completion** payment and **Contractor's** requisition that were properly filed with the **Commissioner** prior to the date of **Substantial Completion**; however, the **Commissioner** may grant a waiver for further partial payments after the date of **Substantial Completion** to permit payments for change order **Work**. Such waiver shall be in writing."

- m) Refer to Pages 60 and 61, ARTICLE 45. FINAL PAYMENT;
Delete Sub-Article 45.1, in its entirety;
Substitute the following:

"45.1 After completion and **Final Acceptance** of the **Work**, the **Contractor** shall submit all required certificates and documents, together with a requisition for the balance claimed to be due under the **Contract**. Such submission shall be within 90 days of the date of the **Commissioner's** written determination of **Final Acceptance**, or within such additional time as may be granted by the **Commissioner** in writing. If the **Contractor** fails to submit all required certificates and documents within the time allowed, no payment of the balance claimed shall be made to the **Contractor** and the **Contractor** shall be deemed to have forfeited its right to payment of any balance claimed. A verified statement similar to that required in connection with applications for partial payments shall also be submitted to the **Commissioner**."

- n) Refer to Page 67, ARTICLE 59. SERVICE OF NOTICES;
Delete the words "deposited in a post office box regularly
maintained by the United States Postal Service in a
properly addressed, postage prepaid envelope".

- o) Refer to Pages 71, 72 and 73, ARTICLE 64. TERMINATION BY THE CITY;
Delete the text of the 1st paragraph;
Substitute the following:

"64.1 In addition to termination pursuant to any other article of this Contract, the Commissioner may, by written notice, terminate the Contract or any portion thereof after determining that for reasons beyond either Department or Contractor control it is not feasible to proceed with or complete the work as originally contracted for, and that termination would therefore be in the public interest. Such reasons for termination may include, but need not be necessarily limited to, executive orders of the President relating to prosecution of war or national defense, national emergency which creates a serious shortage of materials, orders from duly constituted authorities relating to energy conservation, and restraining orders or injunctions obtained by third-party citizen action resulting from national or local laws or regulations, or where the issuance of such order or injunction is primarily caused by acts or omissions of persons or agencies other than the Contractor, or where the orderly progression of a project is interfered with or delayed by acts or omissions of persons or agencies other than the Contractor. The Contractor specifically understands that the issuance of such notice by the Commissioner shall be conclusive as to its necessity. In such event the Contractor shall upon receipt of such notice:"

- p) Refer to Pages 74 and 75, ARTICLE 67. LOCALLY BASED ENTERPRISE PROGRAM;
Delete Article 67, in its entirety. See Attachment "H"
Disadvantaged Business Enterprise Utilization
Requirements.
- q) Refer to Pages 75, 76 and 77, ARTICLE 69. MacBRIDE PRINCIPLES PROVISIONS;
Delete Article 69, in its entirety, and Substitute the following "ARTICLE 69. (NO TEXT)"
- r) Refer to Page 78, ARTICLE 75. COMPENSATION TO BE PAID TO CONTRACTOR;
Delete Article 75, in its entirety and Substitute the following "ARTICLE 75. (NO TEXT)".

- s) Add the following to Pages 92, 93, 94, 95, 96, 97, 98, and 99,
PERFORMANCE BOND:

"Prior to or at the time of execution of the contract, successful bidder must deliver to the City of New York an executed bond equal to one hundred percent (100%) of the contract price, to secure the faithful performance of the contract, and an executed bond in an amount equal to one hundred percent (100%) of the contract price, as security for the payment of all persons performing labor or furnishing materials in connection with this contract, prepared on the forms of bonds authorized by The City of New York, and made a part of the contract documents, copies of which are annexed hereto, and having as surety thereunder such surety company or companies as are approved by The City of New York and are authorized to do business in the State of New York. Premium of such bonds shall be included in the base bid.

In lieu of a performance and completion bond and labor and material bond, a contractor may deposit with the Comptroller, money or obligations of The City of New York which the Comptroller shall approve as of equal value with the amount of the performance and completion bond required.

Whenever a contractor deposits obligations of The City of New York, in lieu of a performance and completion bond and a labor and material bond, it shall be with the understanding that the Comptroller of the City of New York, or his successors, may sell and use the proceeds thereof, for any purpose for which the principal or surety on such bond would be liable under the terms of the contract. If money is deposited with the Comptroller, the Contractor shall not be entitled to receive interest on such money from The City of New York.

If the bidder to whom the contract is awarded refuses to execute it, or fails to furnish the required security and insurance within ten (10) days after receipt of notice to him of the award, the amount of his deposit, or as much thereof as may be applicable to the amount of the award made to him, shall be forfeited and shall be retained by the City as liquidated damages."

8. Amendments to General Conditions of the Standard Highway Specifications:

- a) Refer to Page 14 of the Standard Highway Specifications,
Article 1.06.23. Rules, Laws, and Requirements;
Add the following:

"Certain items of work are to be performed in accordance with the general specifications of the following departments of the City of New York:

Bureau of Traffic Operations
Police Department
Fire Department
Department of Environmental Protection
Bureau of Water Supply and Sewer Operations
Street Lighting

Copies of these specifications may be examined at their offices."

- b) Refer to Pages 16 and 17 of the Standard Highway Specifications, Article 1.06.23.(G) Rules Governing Navigation, last paragraph;
Delete the word "asbestos" wherever it occurs.

 - c) Refer to Pages 36, 37 and 38, of the Standard Highway Specifications, Article 1.06.46. Project Sign;
Delete the Article 1.06.46, in its entirety;
Substitute the following:

"1.06.46. Project Sign. No project signs will be required on this project."

 - d) Refer to Page 40 of the Standard Highway Specifications, Sub-Article 1.06.48.(C) Access Ramps, 2nd paragraph, 1st line;
Change the maximum grade from "one (1) vertical on three (3) horizontal" to "one (1) vertical on six (6) horizontal".
9. Amendments to the Standard Highway Specifications:
- a) Refer to Page 83, Subsection 2.18.3(A), 4th paragraph;
Change "." to "," after "... and Appeals";
Add the following words: "and the health standards of OSHA of the U.S. Department of Labor."

 - b) Refer to Page 187, Subsection 4.06.12;
Delete the Subsection 4.06.12, in its entirety and substitute the words "**4.06.12. (NO TEXT).**" The use of rubble aggregate will not be permitted.
10. The Contractor is hereby notified that this is a City contract funded through apportionment available under Title 23, U.S. Code, as amended, and that the contract will be awarded by the City of New York, subject to the approval of the Commissioner of the New York State Department of Transportation and the Federal Highway Administration. Furthermore, no extensions in time for completion or other changes affecting the contract work can be granted by the City of New York without concurrence of the State of New York and approval of the Federal Highway Administration.

11. All reference to the delivery of salvageable materials to a designated City-owned yard do not apply to this Contract. All salvageable materials designated by the Engineer shall be stored on site for pick-up by City forces.

12. Wherever references are made within these specifications to "race, creed, color, national origin or sex," they shall be construed to include "sexual orientation and marital status".

REQUIRED CONTRACT PROVISIONS FEDERAL-AID CONSTRUCTION CONTRACTS

- I. General
- II. Nondiscrimination
- III. Nonsegregated Facilities
- IV. Davis-Bacon and Related Act Provisions
- V. Contract Work Hours and Safety Standards Act Provisions
- VI. Subletting or Assigning the Contract
- VII. Safety: Accident Prevention
- VIII. False Statements Concerning Highway Projects
- IX. Implementation of Clean Air Act and Federal Water Pollution Control Act
- X. Compliance with Governmentwide Suspension and Debarment Requirements
- XI. Certification Regarding Use of Contract Funds for Lobbying

ATTACHMENTS

A. Employment and Materials Preference for Appalachian Development Highway System or Appalachian Local Access Road Contracts (included in Appalachian contracts only)

I. GENERAL

1. Form FHWA-1273 must be physically incorporated in each construction contract funded under Title 23 (excluding emergency contracts solely intended for debris removal). The contractor (or subcontractor) must insert this form in each subcontract and further require its inclusion in all lower tier subcontracts (excluding purchase orders, rental agreements and other agreements for supplies or services).

The applicable requirements of Form FHWA-1273 are incorporated by reference for work done under any purchase order, rental agreement or agreement for other services. The prime contractor shall be responsible for compliance by any subcontractor, lower-tier subcontractor or service provider.

Form FHWA-1273 must be included in all Federal-aid design-build contracts, in all subcontracts and in lower tier subcontracts (excluding subcontracts for design services, purchase orders, rental agreements and other agreements for supplies or services). The design-builder shall be responsible for compliance by any subcontractor, lower-tier subcontractor or service provider.

Contracting agencies may reference Form FHWA-1273 in bid proposal or request for proposal documents, however, the Form FHWA-1273 must be physically incorporated (not referenced) in all contracts, subcontracts and lower-tier subcontracts (excluding purchase orders, rental agreements and other agreements for supplies or services related to a construction contract).

2. Subject to the applicability criteria noted in the following sections, these contract provisions shall apply to all work performed on the contract by the contractor's own organization and with the assistance of workers under the contractor's immediate superintendence and to all work performed on the contract by piecework, station work, or by subcontract.

ATTACHMENT "A"

3. A breach of any of the stipulations contained in these Required Contract Provisions may be sufficient grounds for withholding of progress payments, withholding of final payment, termination of the contract, suspension / debarment or any other action determined to be appropriate by the contracting agency and FHWA.

4. Selection of Labor: During the performance of this contract, the contractor shall not use convict labor for any purpose within the limits of a construction project on a Federal-aid highway unless it is labor performed by convicts who are on parole, supervised release, or probation. The term Federal-aid highway does not include roadways functionally classified as local roads or rural minor collectors.

II. NONDISCRIMINATION

The provisions of this section related to 23 CFR Part 230 are applicable to all Federal-aid construction contracts and to all related construction subcontracts of \$10,000 or more. The provisions of 23 CFR Part 230 are not applicable to material supply, engineering, or architectural service contracts.

In addition, the contractor and all subcontractors must comply with the following policies: Executive Order 11246, 41 CFR 60, 29 CFR 1625-1627, Title 23 USC Section 140, the Rehabilitation Act of 1973, as amended (29 USC 794), Title VI of the Civil Rights Act of 1964, as amended, and related regulations including 49 CFR Parts 21, 26 and 27; and 23 CFR Parts 200, 230, and 633.

The contractor and all subcontractors must comply with: the requirements of the Equal Opportunity Clause in 41 CFR 60-1.4(b) and, for all construction contracts exceeding \$10,000, the Standard Federal Equal Employment Opportunity Construction Contract Specifications in 41 CFR 60-4.3.

Note: The U.S. Department of Labor has exclusive authority to determine compliance with Executive Order 11246 and the policies of the Secretary of Labor including 41 CFR 60, and 29 CFR 1625-1627. The contracting agency and the FHWA have the authority and the responsibility to ensure compliance with Title 23 USC Section 140, the Rehabilitation Act of 1973, as amended (29 USC 794), and Title VI of the Civil Rights Act of 1964, as amended, and related regulations including 49 CFR Parts 21, 26 and 27; and 23 CFR Parts 200, 230, and 633.

The following provision is adopted from 23 CFR 230, Appendix A, with appropriate revisions to conform to the U.S. Department of Labor (US DOL) and FHWA requirements.

1. Equal Employment Opportunity: Equal employment opportunity (EEO) requirements not to discriminate and to take affirmative action to assure equal opportunity as set forth under laws, executive orders, rules, regulations (28 CFR 35, 29 CFR 1630, 29 CFR 1625-1627, 41 CFR 60 and 49 CFR 27) and orders of the Secretary of Labor as modified by the provisions prescribed herein, and imposed pursuant to 23 U.S.C. 140 shall constitute the EEO and specific affirmative action standards for the contractor's project activities under this contract. The provisions of the Americans with Disabilities Act of 1990 (42 U.S.C. 12101 et seq.) set forth under 28 CFR 35 and 29 CFR 1630 are incorporated by reference in this contract. In the execution of this contract, the contractor agrees to comply with the following minimum specific requirement activities of EEO:

ATTACHMENT "A"

a. The contractor will work with the contracting agency and the Federal Government to ensure that it has made every good faith effort to provide equal opportunity with respect to all of its terms and conditions of employment and in their review of activities under the contract.

b. The contractor will accept as its operating policy the following statement:

"It is the policy of this Company to assure that applicants are employed, and that employees are treated during employment, without regard to their race, religion, sex, color, national origin, age or disability. Such action shall include: employment, upgrading, demotion, or transfer; recruitment or recruitment advertising; layoff or termination; rates of pay or other forms of compensation; and selection for training, including apprenticeship, pre-apprenticeship, and/or on-the-job training."

2. EEO Officer: The contractor will designate and make known to the contracting officers an EEO Officer who will have the responsibility for and must be capable of effectively administering and promoting an active EEO program and who must be assigned adequate authority and responsibility to do so.

3. Dissemination of Policy: All members of the contractor's staff who are authorized to hire, supervise, promote, and discharge employees, or who recommend such action, or who are substantially involved in such action, will be made fully cognizant of, and will implement, the contractor's EEO policy and contractual responsibilities to provide EEO in each grade and classification of employment. To ensure that the above agreement will be met, the following actions will be taken as a minimum:

a. Periodic meetings of supervisory and personnel office employees will be conducted before the start of work and then not less often than once every six months, at which time the contractor's EEO policy and its implementation will be reviewed and explained. The meetings will be conducted by the EEO Officer.

b. All new supervisory or personnel office employees will be given a thorough indoctrination by the EEO Officer, covering all major aspects of the contractor's EEO obligations within thirty days following their reporting for duty with the contractor.

c. All personnel who are engaged in direct recruitment for the project will be instructed by the EEO Officer in the contractor's procedures for locating and hiring minorities and women.

d. Notices and posters setting forth the contractor's EEO policy will be placed in areas readily accessible to employees, applicants for employment and potential employees.

e. The contractor's EEO policy and the procedures to implement such policy will be brought to the attention of employees by means of meetings, employee handbooks, or other appropriate means.

4. Recruitment: When advertising for employees, the contractor will include in all advertisements for employees the notation: "An Equal Opportunity Employer." All such advertisements will be placed in publications having a large circulation among minorities and women in the area from which the project work force would normally be derived.

a. The contractor will, unless precluded by a valid bargaining agreement, conduct systematic and direct recruitment through public and private employee referral sources likely to yield qualified minorities and women. To meet this requirement, the contractor will identify sources of

ATTACHMENT "A"

potential minority group employees, and establish with such identified sources procedures whereby minority and women applicants may be referred to the contractor for employment consideration.

b. In the event the contractor has a valid bargaining agreement providing for exclusive hiring hall referrals, the contractor is expected to observe the provisions of that agreement to the extent that the system meets the contractor's compliance with EEO contract provisions. Where implementation of such an agreement has the effect of discriminating against minorities or women, or obligates the contractor to do the same, such implementation violates Federal nondiscrimination provisions.

c. The contractor will encourage its present employees to refer minorities and women as applicants for employment. Information and procedures with regard to referring such applicants will be discussed with employees.

5. Personnel Actions: Wages, working conditions, and employee benefits shall be established and administered, and personnel actions of every type, including hiring, upgrading, promotion, transfer, demotion, layoff, and termination, shall be taken without regard to race, color, religion, sex, national origin, age or disability. The following procedures shall be followed:

a. The contractor will conduct periodic inspections of project sites to insure that working conditions and employee facilities do not indicate discriminatory treatment of project site personnel.

b. The contractor will periodically evaluate the spread of wages paid within each classification to determine any evidence of discriminatory wage practices.

c. The contractor will periodically review selected personnel actions in depth to determine whether there is evidence of discrimination. Where evidence is found, the contractor will promptly take corrective action. If the review indicates that the discrimination may extend beyond the actions reviewed, such corrective action shall include all affected persons.

d. The contractor will promptly investigate all complaints of alleged discrimination made to the contractor in connection with its obligations under this contract, will attempt to resolve such complaints, and will take appropriate corrective action within a reasonable time. If the investigation indicates that the discrimination may affect persons other than the complainant, such corrective action shall include such other persons. Upon completion of each investigation, the contractor will inform every complainant of all of their avenues of appeal.

6. Training and Promotion:

a. The contractor will assist in locating, qualifying, and increasing the skills of minorities and women who are applicants for employment or current employees. Such efforts should be aimed at developing full journey level status employees in the type of trade or job classification involved.

b. Consistent with the contractor's work force requirements and as permissible under Federal and State regulations, the contractor shall make full use of training programs, i.e., apprenticeship, and on-the-job training programs for the geographical area of contract performance. In the event a special provision for training is provided under this contract, this subparagraph will be superseded as indicated in the special provision. The contracting agency

may reserve training positions for persons who receive welfare assistance in accordance with 23 U.S.C. 140(a).

c. The contractor will advise employees and applicants for employment of available training programs and entrance requirements for each.

d. The contractor will periodically review the training and promotion potential of employees who are minorities and women and will encourage eligible employees to apply for such training and promotion.

7. Unions: If the contractor relies in whole or in part upon unions as a source of employees, the contractor will use good faith efforts to obtain the cooperation of such unions to increase opportunities for minorities and women. Actions by the contractor, either directly or through a contractor's association acting as agent, will include the procedures set forth below:

a. The contractor will use good faith efforts to develop, in cooperation with the unions, joint training programs aimed toward qualifying more minorities and women for membership in the unions and increasing the skills of minorities and women so that they may qualify for higher paying employment.

b. The contractor will use good faith efforts to incorporate an EEO clause into each union agreement to the end that such union will be contractually bound to refer applicants without regard to their race, color, religion, sex, national origin, age or disability.

c. The contractor is to obtain information as to the referral practices and policies of the labor union except that to the extent such information is within the exclusive possession of the labor union and such labor union refuses to furnish such information to the contractor, the contractor shall so certify to the contracting agency and shall set forth what efforts have been made to obtain such information.

d. In the event the union is unable to provide the contractor with a reasonable flow of referrals within the time limit set forth in the collective bargaining agreement, the contractor will, through independent recruitment efforts, fill the employment vacancies without regard to race, color, religion, sex, national origin, age or disability; making full efforts to obtain qualified and/or qualifiable minorities and women. The failure of a union to provide sufficient referrals (even though it is obligated to provide exclusive referrals under the terms of a collective bargaining agreement) does not relieve the contractor from the requirements of this paragraph. In the event the union referral practice prevents the contractor from meeting the obligations pursuant to Executive Order 11246, as amended, and these special provisions, such contractor shall immediately notify the contracting agency.

8. Reasonable Accommodation for Applicants / Employees with Disabilities: The contractor must be familiar with the requirements for and comply with the Americans with Disabilities Act and all rules and regulations established there under. Employers must provide reasonable accommodation in all employment activities unless to do so would cause an undue hardship.

9. Selection of Subcontractors, Procurement of Materials and Leasing of Equipment: The contractor shall not discriminate on the grounds of race, color, religion, sex, national origin, age or disability in the selection and retention of subcontractors, including procurement of materials and leases of equipment. The contractor shall take all necessary and reasonable steps to ensure nondiscrimination in the administration of this contract.

ATTACHMENT "A"

a. The contractor shall notify all potential subcontractors and suppliers and lessors of their EEO obligations under this contract.

b. The contractor will use good faith efforts to ensure subcontractor compliance with their EEO obligations.

10. Assurance Required by 49 CFR 26.13(b):

a. The requirements of 49 CFR Part 26 and the State DOT's U.S. DOT-approved DBE program are incorporated by reference.

b. The contractor or subcontractor shall not discriminate on the basis of race, color, national origin, or sex in the performance of this contract. The contractor shall carry out applicable requirements of 49 CFR Part 26 in the award and administration of DOT-assisted contracts. Failure by the contractor to carry out these requirements is a material breach of this contract, which may result in the termination of this contract or such other remedy as the contracting agency deems appropriate.

11. Records and Reports: The contractor shall keep such records as necessary to document compliance with the EEO requirements. Such records shall be retained for a period of three years following the date of the final payment to the contractor for all contract work and shall be available at reasonable times and places for inspection by authorized representatives of the contracting agency and the FHWA.

a. The records kept by the contractor shall document the following:

(1) The number and work hours of minority and non-minority group members and women employed in each work classification on the project;

(2) The progress and efforts being made in cooperation with unions, when applicable, to increase employment opportunities for minorities and women; and

(3) The progress and efforts being made in locating, hiring, training, qualifying, and upgrading minorities and women;

b. The contractors and subcontractors will submit an annual report to the contracting agency each July for the duration of the project, indicating the number of minority, women, and non-minority group employees currently engaged in each work classification required by the contract work. This information is to be reported on Form FHWA-1391. The staffing data should represent the project work force on board in all or any part of the last payroll period preceding the end of July. If on-the-job training is being required by special provision, the contractor will be required to collect and report training data. The employment data should reflect the work force on board during all or any part of the last payroll period preceding the end of July.

III. NONSEGREGATED FACILITIES

This provision is applicable to all Federal-aid construction contracts and to all related construction subcontracts of \$10,000 or more.

The contractor must ensure that facilities provided for employees are provided in such a manner that segregation on the basis of race, color, religion, sex, or national origin cannot result. The

contractor may neither require such segregated use by written or oral policies nor tolerate such use by employee custom. The contractor's obligation extends further to ensure that its employees are not assigned to perform their services at any location, under the contractor's control, where the facilities are segregated. The term "facilities" includes waiting rooms, work areas, restaurants and other eating areas, time clocks, restrooms, washrooms, locker rooms, and other storage or dressing areas, parking lots, drinking fountains, recreation or entertainment areas, transportation, and housing provided for employees. The contractor shall provide separate or single-user restrooms and necessary dressing or sleeping areas to assure privacy between sexes.

IV. DAVIS-BACON AND RELATED ACT PROVISIONS

This section is applicable to all Federal-aid construction projects exceeding \$2,000 and to all related subcontracts and lower-tier subcontracts (regardless of subcontract size). The requirements apply to all projects located within the right-of-way of a roadway that is functionally classified as Federal-aid highway. This excludes roadways functionally classified as local roads or rural minor collectors, which are exempt. Contracting agencies may elect to apply these requirements to other projects.

The following provisions are from the U.S. Department of Labor regulations in 29 CFR 5.5 "Contract provisions and related matters" with minor revisions to conform to the FHWA-1273 format and FHWA program requirements.

1. Minimum wages

a. All laborers and mechanics employed or working upon the site of the work, will be paid unconditionally and not less often than once a week, and without subsequent deduction or rebate on any account (except such payroll deductions as are permitted by regulations issued by the Secretary of Labor under the Copeland Act (29 CFR part 3)), the full amount of wages and bona fide fringe benefits (or cash equivalents thereof) due at time of payment computed at rates not less than those contained in the wage determination of the Secretary of Labor which is attached hereto and made a part hereof, regardless of any contractual relationship which may be alleged to exist between the contractor and such laborers and mechanics.

Contributions made or costs reasonably anticipated for bona fide fringe benefits under section 1(b)(2) of the Davis-Bacon Act on behalf of laborers or mechanics are considered wages paid to such laborers or mechanics, subject to the provisions of paragraph 1.d. of this section; also, regular contributions made or costs incurred for more than a weekly period (but not less often than quarterly) under plans, funds, or programs which cover the particular weekly period, are deemed to be constructively made or incurred during such weekly period. Such laborers and mechanics shall be paid the appropriate wage rate and fringe benefits on the wage determination for the classification of work actually performed, without regard to skill, except as provided in 29 CFR 5.5(a)(4). Laborers or mechanics performing work in more than one classification may be compensated at the rate specified for each classification for the time actually worked therein: Provided, That the employer's payroll records accurately set forth the time spent in each classification in which work is performed. The wage determination (including any additional classification and wage rates conformed under paragraph 1.b. of this section) and the Davis-Bacon poster (WH-1321) shall be posted at all times by the contractor and its subcontractors at the site of the work in a prominent and accessible place where it can be easily seen by the workers.

ATTACHMENT "A"

b. (1) The contracting officer shall require that any class of laborers or mechanics, including helpers, which is not listed in the wage determination and which is to be employed under the contract shall be classified in conformance with the wage determination. The contracting officer shall approve an additional classification and wage rate and fringe benefits therefore only when the following criteria have been met:

(i) The work to be performed by the classification requested is not performed by a classification in the wage determination; and

(ii) The classification is utilized in the area by the construction industry; and

(iii) The proposed wage rate, including any bona fide fringe benefits, bears a reasonable relationship to the wage rates contained in the wage determination.

(2) If the contractor and the laborers and mechanics to be employed in the classification (if known), or their representatives, and the contracting officer agree on the classification and wage rate (including the amount designated for fringe benefits where appropriate), a report of the action taken shall be sent by the contracting officer to the Administrator of the Wage and Hour Division, Employment Standards Administration, U.S. Department of Labor, Washington, DC 20210. The Administrator, or an authorized representative, will approve, modify, or disapprove every additional classification action within 30 days of receipt and so advise the contracting officer or will notify the contracting officer within the 30-day period that additional time is necessary.

(3) In the event the contractor, the laborers or mechanics to be employed in the classification or their representatives, and the contracting officer do not agree on the proposed classification and wage rate (including the amount designated for fringe benefits, where appropriate), the contracting officer shall refer the questions; including the views of all interested parties and the recommendation of the contracting officer, to the Wage and Hour Administrator for determination. The Wage and Hour Administrator, or an authorized representative, will issue a determination within 30 days of receipt and so advise the contracting officer or will notify the contracting officer within the 30-day period that additional time is necessary.

(4) The wage rate (including fringe benefits where appropriate) determined pursuant to paragraphs 1.b.(2) or 1.b.(3) of this section, shall be paid to all workers performing work in the classification under this contract from the first day on which work is performed in the classification.

c. Whenever the minimum wage rate prescribed in the contract for a class of laborers or mechanics includes a fringe benefit which is not expressed as an hourly rate, the contractor shall either pay the benefit as stated in the wage determination or shall pay another bona fide fringe benefit or an hourly cash equivalent thereof.

d. If the contractor does not make payments to a trustee or other third person, the contractor may consider as part of the wages of any laborer or mechanic the amount of any costs reasonably anticipated in providing bona fide fringe benefits under a plan or program, Provided, That the Secretary of Labor has found, upon the written request of the contractor, that the applicable standards of the Davis-Bacon Act have been met. The Secretary of Labor may require the contractor to set aside in a separate account assets for the meeting of obligations under the plan or program.

2. Withholding

The contracting agency shall upon its own action or upon written request of an authorized representative of the Department of Labor, withhold or cause to be withheld from the contractor under this contract, or any other Federal contract with the same prime contractor, or any other federally-assisted contract subject to Davis-Bacon prevailing wage requirements, which is held by the same prime contractor, so much of the accrued payments or advances as may be considered necessary to pay laborers and mechanics, including apprentices, trainees, and helpers, employed by the contractor or any subcontractor the full amount of wages required by the contract. In the event of failure to pay any laborer or mechanic, including any apprentice, trainee, or helper, employed or working on the site of the work, all or part of the wages required by the contract, the contracting agency may, after written notice to the contractor, take such action as may be necessary to cause the suspension of any further payment, advance, or guarantee of funds until such violations have ceased.

3. Payrolls and basic records

a. Payrolls and basic records relating thereto shall be maintained by the contractor during the course of the work and preserved for a period of three years thereafter for all laborers and mechanics working at the site of the work. Such records shall contain the name, address, and social security number of each such worker, his or her correct classification, hourly rates of wages paid (including rates of contributions or costs anticipated for bona fide fringe benefits or cash equivalents thereof of the types described in section 1(b)(2)(B) of the Davis-Bacon Act), daily and weekly number of hours worked, deductions made and actual wages paid. Whenever the Secretary of Labor has found under 29 CFR 5.5(a)(1)(iv) that the wages of any laborer or mechanic include the amount of any costs reasonably anticipated in providing benefits under a plan or program described in section 1(b)(2)(B) of the Davis-Bacon Act, the contractor shall maintain records which show that the commitment to provide such benefits is enforceable, that the plan or program is financially responsible, and that the plan or program has been communicated in writing to the laborers or mechanics affected, and records which show the costs anticipated or the actual cost incurred in providing such benefits. Contractors employing apprentices or trainees under approved programs shall maintain written evidence of the registration of apprenticeship programs and certification of trainee programs, the registration of the apprentices and trainees, and the ratios and wage rates prescribed in the applicable programs.

b. (1) The contractor shall submit weekly for each week in which any contract work is performed a copy of all payrolls to the contracting agency. The payrolls submitted shall set out accurately and completely all of the information required to be maintained under 29 CFR 5.5(a)(3)(i), except that full social security numbers and home addresses shall not be included on weekly transmittals. Instead the payrolls shall only need to include an individually identifying number for each employee (e.g. , the last four digits of the employee's social security number). The required weekly payroll information may be submitted in any form desired. Optional Form WH-347 is available for this purpose from the Wage and Hour Division Web site at <http://www.dol.gov/esa/whd/forms/wh347instr.htm> or its successor site. The prime contractor is responsible for the submission of copies of payrolls by all subcontractors. Contractors and subcontractors shall maintain the full social security number and current address of each covered worker, and shall provide them upon request to the contracting agency for transmission to the State DOT, the FHWA or the Wage and Hour Division of the Department of Labor for purposes of an investigation or audit of compliance with prevailing wage requirements. It is not a violation of this section for a prime contractor to require a subcontractor to provide addresses

ATTACHMENT "A"

and social security numbers to the prime contractor for its own records, without weekly submission to the contracting agency..

(2) Each payroll submitted shall be accompanied by a "Statement of Compliance," signed by the contractor or subcontractor or his or her agent who pays or supervises the payment of the persons employed under the contract and shall certify the following:

(i) That the payroll for the payroll period contains the information required to be provided under §5.5 (a)(3)(ii) of Regulations, 29 CFR part 5, the appropriate information is being maintained under §5.5 (a)(3)(i) of Regulations, 29 CFR part 5, and that such information is correct and complete;

(ii) That each laborer or mechanic (including each helper, apprentice, and trainee) employed on the contract during the payroll period has been paid the full weekly wages earned, without rebate, either directly or indirectly, and that no deductions have been made either directly or indirectly from the full wages earned, other than permissible deductions as set forth in Regulations, 29 CFR part 3;

(iii) That each laborer or mechanic has been paid not less than the applicable wage rates and fringe benefits or cash equivalents for the classification of work performed, as specified in the applicable wage determination incorporated into the contract.

(3) The weekly submission of a properly executed certification set forth on the reverse side of Optional Form WH-347 shall satisfy the requirement for submission of the "Statement of Compliance" required by paragraph 3.b.(2) of this section.

(4) The falsification of any of the above certifications may subject the contractor or subcontractor to civil or criminal prosecution under section 1001 of title 18 and section 231 of title 31 of the United States Code.

c. The contractor or subcontractor shall make the records required under paragraph 3.a. of this section available for inspection, copying, or transcription by authorized representatives of the contracting agency, the State DOT, the FHWA, or the Department of Labor, and shall permit such representatives to interview employees during working hours on the job. If the contractor or subcontractor fails to submit the required records or to make them available, the FHWA may, after written notice to the contractor, the contracting agency or the State DOT, take such action as may be necessary to cause the suspension of any further payment, advance, or guarantee of funds. Furthermore, failure to submit the required records upon request or to make such records available may be grounds for debarment action pursuant to 29 CFR 5.12.

4. Apprentices and trainees

a. Apprentices (programs of the USDOL).

Apprentices will be permitted to work at less than the predetermined rate for the work they performed when they are employed pursuant to and individually registered in a bona fide apprenticeship program registered with the U.S. Department of Labor, Employment and Training Administration, Office of Apprenticeship Training, Employer and Labor Services, or with a State Apprenticeship Agency recognized by the Office, or if a person is employed in his or her first 90 days of probationary employment as an apprentice in such an apprenticeship program, who is not individually registered in the program, but who has been certified by the Office of

Apprenticeship Training, Employer and Labor Services or a State Apprenticeship Agency (where appropriate) to be eligible for probationary employment as an apprentice.

The allowable ratio of apprentices to journeymen on the job site in any craft classification shall not be greater than the ratio permitted to the contractor as to the entire work force under the registered program. Any worker listed on a payroll at an apprentice wage rate, who is not registered or otherwise employed as stated above, shall be paid not less than the applicable wage rate on the wage determination for the classification of work actually performed. In addition, any apprentice performing work on the job site in excess of the ratio permitted under the registered program shall be paid not less than the applicable wage rate on the wage determination for the work actually performed. Where a contractor is performing construction on a project in a locality other than that in which its program is registered, the ratios and wage rates (expressed in percentages of the journeyman's hourly rate) specified in the contractor's or subcontractor's registered program shall be observed.

Every apprentice must be paid at not less than the rate specified in the registered program for the apprentice's level of progress, expressed as a percentage of the journeymen hourly rate specified in the applicable wage determination. Apprentices shall be paid fringe benefits in accordance with the provisions of the apprenticeship program. If the apprenticeship program does not specify fringe benefits, apprentices must be paid the full amount of fringe benefits listed on the wage determination for the applicable classification. If the Administrator determines that a different practice prevails for the applicable apprentice classification, fringes shall be paid in accordance with that determination.

In the event the Office of Apprenticeship Training, Employer and Labor Services, or a State Apprenticeship Agency recognized by the Office, withdraws approval of an apprenticeship program, the contractor will no longer be permitted to utilize apprentices at less than the applicable predetermined rate for the work performed until an acceptable program is approved.

b. Trainees (programs of the USDOL).

Except as provided in 29 CFR 5.16, trainees will not be permitted to work at less than the predetermined rate for the work performed unless they are employed pursuant to and individually registered in a program which has received prior approval, evidenced by formal certification by the U.S. Department of Labor, Employment and Training Administration.

The ratio of trainees to journeymen on the job site shall not be greater than permitted under the plan approved by the Employment and Training Administration.

Every trainee must be paid at not less than the rate specified in the approved program for the trainee's level of progress, expressed as a percentage of the journeyman hourly rate specified in the applicable wage determination. Trainees shall be paid fringe benefits in accordance with the provisions of the trainee program. If the trainee program does not mention fringe benefits, trainees shall be paid the full amount of fringe benefits listed on the wage determination unless the Administrator of the Wage and Hour Division determines that there is an apprenticeship program associated with the corresponding journeyman wage rate on the wage determination which provides for less than full fringe benefits for apprentices. Any employee listed on the payroll at a trainee rate who is not registered and participating in a training plan approved by the Employment and Training Administration shall be paid not less than the applicable wage rate on the wage determination for the classification of work actually performed. In addition, any trainee performing work on the job site in excess of the ratio permitted under the registered program

ATTACHMENT "A"

shall be paid not less than the applicable wage rate on the wage determination for the work actually performed.

In the event the Employment and Training Administration withdraws approval of a training program, the contractor will no longer be permitted to utilize trainees at less than the applicable predetermined rate for the work performed until an acceptable program is approved.

c. Equal employment opportunity. The utilization of apprentices, trainees and journeymen under this part shall be in conformity with the equal employment opportunity requirements of Executive Order 11246, as amended, and 29 CFR part 30.

d. Apprentices and Trainees (programs of the U.S. DOT).

Apprentices and trainees working under apprenticeship and skill training programs which have been certified by the Secretary of Transportation as promoting EEO in connection with Federal-aid highway construction programs are not subject to the requirements of paragraph 4 of this Section IV. The straight time hourly wage rates for apprentices and trainees under such programs will be established by the particular programs. The ratio of apprentices and trainees to journeymen shall not be greater than permitted by the terms of the particular program.

5. Compliance with Copeland Act requirements. The contractor shall comply with the requirements of 29 CFR part 3, which are incorporated by reference in this contract.

6. Subcontracts. The contractor or subcontractor shall insert Form FHWA-1273 in any subcontracts and also require the subcontractors to include Form FHWA-1273 in any lower tier subcontracts. The prime contractor shall be responsible for the compliance by any subcontractor or lower tier subcontractor with all the contract clauses in 29 CFR 5.5.

7. Contract termination: debarment. A breach of the contract clauses in 29 CFR 5.5 may be grounds for termination of the contract, and for debarment as a contractor and a subcontractor as provided in 29 CFR 5.12.

8. Compliance with Davis-Bacon and Related Act requirements. All rulings and interpretations of the Davis-Bacon and Related Acts contained in 29 CFR parts 1, 3, and 5 are herein incorporated by reference in this contract.

9. Disputes concerning labor standards. Disputes arising out of the labor standards provisions of this contract shall not be subject to the general disputes clause of this contract. Such disputes shall be resolved in accordance with the procedures of the Department of Labor set forth in 29 CFR parts 5, 6, and 7. Disputes within the meaning of this clause include disputes between the contractor (or any of its subcontractors) and the contracting agency, the U.S. Department of Labor, or the employees or their representatives.

10. Certification of eligibility.

a. By entering into this contract, the contractor certifies that neither it (nor he or she) nor any person or firm who has an interest in the contractor's firm is a person or firm ineligible to be awarded Government contracts by virtue of section 3(a) of the Davis-Bacon Act or 29 CFR 5.12(a)(1).

b. No part of this contract shall be subcontracted to any person or firm ineligible for award of a Government contract by virtue of section 3(a) of the Davis-Bacon Act or 29 CFR 5.12(a)(1).

c. The penalty for making false statements is prescribed in the U.S. Criminal Code, 18 U.S.C. 1001.

V. CONTRACT WORK HOURS AND SAFETY STANDARDS ACT

The following clauses apply to any Federal-aid construction contract in an amount in excess of \$100,000 and subject to the overtime provisions of the Contract Work Hours and Safety Standards Act. These clauses shall be inserted in addition to the clauses required by 29 CFR 5.5(a) or 29 CFR 4.6. As used in this paragraph, the terms laborers and mechanics include watchmen and guards.

1. Overtime requirements. No contractor or subcontractor contracting for any part of the contract work which may require or involve the employment of laborers or mechanics shall require or permit any such laborer or mechanic in any workweek in which he or she is employed on such work to work in excess of forty hours in such workweek unless such laborer or mechanic receives compensation at a rate not less than one and one-half times the basic rate of pay for all hours worked in excess of forty hours in such workweek.

2. Violation; liability for unpaid wages; liquidated damages. In the event of any violation of the clause set forth in paragraph (1.) of this section, the contractor and any subcontractor responsible therefor shall be liable for the unpaid wages. In addition, such contractor and subcontractor shall be liable to the United States (in the case of work done under contract for the District of Columbia or a territory, to such District or to such territory), for liquidated damages. Such liquidated damages shall be computed with respect to each individual laborer or mechanic, including watchmen and guards, employed in violation of the clause set forth in paragraph (1.) of this section, in the sum of \$10 for each calendar day on which such individual was required or permitted to work in excess of the standard workweek of forty hours without payment of the overtime wages required by the clause set forth in paragraph (1.) of this section.

3. Withholding for unpaid wages and liquidated damages. The FHWA or the contacting agency shall upon its own action or upon written request of an authorized representative of the Department of Labor withhold or cause to be withheld, from any moneys payable on account of work performed by the contractor or subcontractor under any such contract or any other Federal contract with the same prime contractor, or any other federally-assisted contract subject to the Contract Work Hours and Safety Standards Act, which is held by the same prime contractor, such sums as may be determined to be necessary to satisfy any liabilities of such contractor or subcontractor for unpaid wages and liquidated damages as provided in the clause set forth in paragraph (2.) of this section.

4. Subcontracts. The contractor or subcontractor shall insert in any subcontracts the clauses set forth in paragraph (1.) through (4.) of this section and also a clause requiring the subcontractors to include these clauses in any lower tier subcontracts. The prime contractor shall be responsible for compliance by any subcontractor or lower tier subcontractor with the clauses set forth in paragraphs (1.) through (4.) of this section.

VI. SUBLETTING OR ASSIGNING THE CONTRACT

This provision is applicable to all Federal-aid construction contracts on the National Highway System.

ATTACHMENT "A"

1. The contractor shall perform with its own organization contract work amounting to not less than 30 percent (or a greater percentage if specified elsewhere in the contract) of the total original contract price, excluding any specialty items designated by the contracting agency. Specialty items may be performed by subcontract and the amount of any such specialty items performed may be deducted from the total original contract price before computing the amount of work required to be performed by the contractor's own organization (23 CFR 635.116).

a. The term "perform work with its own organization" refers to workers employed or leased by the prime contractor, and equipment owned or rented by the prime contractor, with or without operators. Such term does not include employees or equipment of a subcontractor or lower tier subcontractor, agents of the prime contractor, or any other assignees. The term may include payments for the costs of hiring leased employees from an employee leasing firm meeting all relevant Federal and State regulatory requirements. Leased employees may only be included in this term if the prime contractor meets all of the following conditions:

(1) the prime contractor maintains control over the supervision of the day-to-day activities of the leased employees;

(2) the prime contractor remains responsible for the quality of the work of the leased employees;

(3) the prime contractor retains all power to accept or exclude individual employees from work on the project; and

(4) the prime contractor remains ultimately responsible for the payment of predetermined minimum wages, the submission of payrolls, statements of compliance and all other Federal regulatory requirements.

b. "Specialty Items" shall be construed to be limited to work that requires highly specialized knowledge, abilities, or equipment not ordinarily available in the type of contracting organizations qualified and expected to bid or propose on the contract as a whole and in general are to be limited to minor components of the overall contract.

2. The contract amount upon which the requirements set forth in paragraph (1) of Section VI is computed includes the cost of material and manufactured products which are to be purchased or produced by the contractor under the contract provisions.

3. The contractor shall furnish (a) a competent superintendent or supervisor who is employed by the firm, has full authority to direct performance of the work in accordance with the contract requirements, and is in charge of all construction operations (regardless of who performs the work) and (b) such other of its own organizational resources (supervision, management, and engineering services) as the contracting officer determines is necessary to assure the performance of the contract.

4. No portion of the contract shall be sublet, assigned or otherwise disposed of except with the written consent of the contracting officer, or authorized representative, and such consent when given shall not be construed to relieve the contractor of any responsibility for the fulfillment of the contract. Written consent will be given only after the contracting agency has assured that each subcontract is evidenced in writing and that it contains all pertinent provisions and requirements of the prime contract.

5. The 30% self-performance requirement of paragraph (1) is not applicable to design-build contracts; however, contracting agencies may establish their own self-performance requirements.

VII. SAFETY: ACCIDENT PREVENTION

This provision is applicable to all Federal-aid construction contracts and to all related subcontracts.

1. In the performance of this contract the contractor shall comply with all applicable Federal, State, and local laws governing safety, health, and sanitation (23 CFR 635). The contractor shall provide all safeguards, safety devices and protective equipment and take any other needed actions as it determines, or as the contracting officer may determine, to be reasonably necessary to protect the life and health of employees on the job and the safety of the public and to protect property in connection with the performance of the work covered by the contract.
2. It is a condition of this contract, and shall be made a condition of each subcontract, which the contractor enters into pursuant to this contract, that the contractor and any subcontractor shall not permit any employee, in performance of the contract, to work in surroundings or under conditions which are unsanitary, hazardous or dangerous to his/her health or safety, as determined under construction safety and health standards (29 CFR 1926) promulgated by the Secretary of Labor, in accordance with Section 107 of the Contract Work Hours and Safety Standards Act (40 U.S.C. 3704).
3. Pursuant to 29 CFR 1926.3, it is a condition of this contract that the Secretary of Labor or authorized representative thereof, shall have right of entry to any site of contract performance to inspect or investigate the matter of compliance with the construction safety and health standards and to carry out the duties of the Secretary under Section 107 of the Contract Work Hours and Safety Standards Act (40 U.S.C.3704).

VIII. FALSE STATEMENTS CONCERNING HIGHWAY PROJECTS

This provision is applicable to all Federal-aid construction contracts and to all related subcontracts.

In order to assure high quality and durable construction in conformity with approved plans and specifications and a high degree of reliability on statements and representations made by engineers, contractors, suppliers, and workers on Federal-aid highway projects, it is essential that all persons concerned with the project perform their functions as carefully, thoroughly, and honestly as possible. Willful falsification, distortion, or misrepresentation with respect to any facts related to the project is a violation of Federal law. To prevent any misunderstanding regarding the seriousness of these and similar acts, Form FHWA-1022 shall be posted on each Federal-aid highway project (23 CFR 635) in one or more places where it is readily available to all persons concerned with the project:

18 U.S.C. 1020 reads as follows:

"Whoever, being an officer, agent, or employee of the United States, or of any State or Territory, or whoever, whether a person, association, firm, or corporation, knowingly makes any false statement, false representation, or false report as to the character, quality, quantity, or cost of the material used or to be used, or the quantity or quality of the work performed or to be performed, or the cost thereof in connection with the submission of plans, maps, specifications, contracts, or costs of construction on any highway or related project submitted for approval to the Secretary of Transportation; or

ATTACHMENT "A"

Whoever knowingly makes any false statement, false representation, false report or false claim with respect to the character, quality, quantity, or cost of any work performed or to be performed, or materials furnished or to be furnished, in connection with the construction of any highway or related project approved by the Secretary of Transportation; or

Whoever knowingly makes any false statement or false representation as to material fact in any statement, certificate, or report submitted pursuant to provisions of the Federal-aid Roads Act approved July 1, 1916, (39 Stat. 355), as amended and supplemented;

Shall be fined under this title or imprisoned not more than 5 years or both."

IX. IMPLEMENTATION OF CLEAN AIR ACT AND FEDERAL WATER POLLUTION CONTROL ACT

This provision is applicable to all Federal-aid construction contracts and to all related subcontracts.

By submission of this bid/proposal or the execution of this contract, or subcontract, as appropriate, the bidder, proposer, Federal-aid construction contractor, or subcontractor, as appropriate, will be deemed to have stipulated as follows:

1. That any person who is or will be utilized in the performance of this contract is not prohibited from receiving an award due to a violation of Section 508 of the Clean Water Act or Section 306 of the Clean Air Act.
2. That the contractor agrees to include or cause to be included the requirements of paragraph (1) of this Section X in every subcontract, and further agrees to take such action as the contracting agency may direct as a means of enforcing such requirements.

X. CERTIFICATION REGARDING DEBARMENT, SUSPENSION, INELIGIBILITY AND VOLUNTARY EXCLUSION

This provision is applicable to all Federal-aid construction contracts, design-build contracts, subcontracts, lower-tier subcontracts, purchase orders, lease agreements, consultant contracts or any other covered transaction requiring FHWA approval or that is estimated to cost \$25,000 or more – as defined in 2 CFR Parts 180 and 1200.

1. Instructions for Certification – First Tier Participants:

- a. By signing and submitting this proposal, the prospective first tier participant is providing the certification set out below.
- b. The inability of a person to provide the certification set out below will not necessarily result in denial of participation in this covered transaction. The prospective first tier participant shall submit an explanation of why it cannot provide the certification set out below. The certification or explanation will be considered in connection with the department or agency's determination whether to enter into this transaction. However, failure of the prospective first tier participant to furnish a certification or an explanation shall disqualify such a person from participation in this transaction.

ATTACHMENT "A"

c. The certification in this clause is a material representation of fact upon which reliance was placed when the contracting agency determined to enter into this transaction. If it is later determined that the prospective participant knowingly rendered an erroneous certification, in addition to other remedies available to the Federal Government, the contracting agency may terminate this transaction for cause of default.

d. The prospective first tier participant shall provide immediate written notice to the contracting agency to whom this proposal is submitted if any time the prospective first tier participant learns that its certification was erroneous when submitted or has become erroneous by reason of changed circumstances.

e. The terms "covered transaction," "debarred," "suspended," "ineligible," "participant," "person," "principal," and "voluntarily excluded," as used in this clause, are defined in 2 CFR Parts 180 and 1200. "First Tier Covered Transactions" refers to any covered transaction between a grantee or subgrantee of Federal funds and a participant (such as the prime or general contract). "Lower Tier Covered Transactions" refers to any covered transaction under a First Tier Covered Transaction (such as subcontracts). "First Tier Participant" refers to the participant who has entered into a covered transaction with a grantee or subgrantee of Federal funds (such as the prime or general contractor). "Lower Tier Participant" refers any participant who has entered into a covered transaction with a First Tier Participant or other Lower Tier Participants (such as subcontractors and suppliers).

f. The prospective first tier participant agrees by submitting this proposal that, should the proposed covered transaction be entered into, it shall not knowingly enter into any lower tier covered transaction with a person who is debarred, suspended, declared ineligible, or voluntarily excluded from participation in this covered transaction, unless authorized by the department or agency entering into this transaction.

g. The prospective first tier participant further agrees by submitting this proposal that it will include the clause titled "Certification Regarding Debarment, Suspension, Ineligibility and Voluntary Exclusion-Lower Tier Covered Transactions," provided by the department or contracting agency, entering into this covered transaction, without modification, in all lower tier covered transactions and in all solicitations for lower tier covered transactions exceeding the \$25,000 threshold.

h. A participant in a covered transaction may rely upon a certification of a prospective participant in a lower tier covered transaction that is not debarred, suspended, ineligible, or voluntarily excluded from the covered transaction, unless it knows that the certification is erroneous. A participant is responsible for ensuring that its principals are not suspended, debarred, or otherwise ineligible to participate in covered transactions. To verify the eligibility of its principals, as well as the eligibility of any lower tier prospective participants, each participant may, but is not required to, check the Excluded Parties List System website (<https://www.epls.gov/>), which is compiled by the General Services Administration.

i. Nothing contained in the foregoing shall be construed to require the establishment of a system of records in order to render in good faith the certification required by this clause. The knowledge and information of the prospective participant is not required to exceed that which is normally possessed by a prudent person in the ordinary course of business dealings.

j. Except for transactions authorized under paragraph (f) of these instructions, if a participant in a covered transaction knowingly enters into a lower tier covered transaction with a person who is suspended, debarred, ineligible, or voluntarily excluded from participation in this

ATTACHMENT "A"

transaction, in addition to other remedies available to the Federal Government, the department or agency may terminate this transaction for cause or default.

* * * * *

2. Certification Regarding Debarment, Suspension, Ineligibility and Voluntary Exclusion – First Tier Participants:

a. The prospective first tier participant certifies to the best of its knowledge and belief, that it and its principals:

(1) Are not presently debarred, suspended, proposed for debarment, declared ineligible, or voluntarily excluded from participating in covered transactions by any Federal department or agency;

(2) Have not within a three-year period preceding this proposal been convicted of or had a civil judgment rendered against them for commission of fraud or a criminal offense in connection with obtaining, attempting to obtain, or performing a public (Federal, State or local) transaction or contract under a public transaction; violation of Federal or State antitrust statutes or commission of embezzlement, theft, forgery, bribery, falsification or destruction of records, making false statements, or receiving stolen property;

(3) Are not presently indicted for or otherwise criminally or civilly charged by a governmental entity (Federal, State or local) with commission of any of the offenses enumerated in paragraph (a)(2) of this certification; and

(4) Have not within a three-year period preceding this application/proposal had one or more public transactions (Federal, State or local) terminated for cause or default.

b. Where the prospective participant is unable to certify to any of the statements in this certification, such prospective participant shall attach an explanation to this proposal.

2. Instructions for Certification - Lower Tier Participants:

(Applicable to all subcontracts, purchase orders and other lower tier transactions requiring prior FHWA approval or estimated to cost \$25,000 or more - 2 CFR Parts 180 and 1200)

a. By signing and submitting this proposal, the prospective lower tier is providing the certification set out below.

b. The certification in this clause is a material representation of fact upon which reliance was placed when this transaction was entered into. If it is later determined that the prospective lower tier participant knowingly rendered an erroneous certification, in addition to other remedies available to the Federal Government, the department, or agency with which this transaction originated may pursue available remedies, including suspension and/or debarment.

c. The prospective lower tier participant shall provide immediate written notice to the person to which this proposal is submitted if at any time the prospective lower tier participant learns that its certification was erroneous by reason of changed circumstances.

d. The terms "covered transaction," "debarred," "suspended," "ineligible," "participant," "person," "principal," and "voluntarily excluded," as used in this clause, are defined in 2 CFR

Parts 180 and 1200. You may contact the person to which this proposal is submitted for assistance in obtaining a copy of those regulations. "First Tier Covered Transactions" refers to any covered transaction between a grantee or subgrantee of Federal funds and a participant (such as the prime or general contract). "Lower Tier Covered Transactions" refers to any covered transaction under a First Tier Covered Transaction (such as subcontracts). "First Tier Participant" refers to the participant who has entered into a covered transaction with a grantee or subgrantee of Federal funds (such as the prime or general contractor). "Lower Tier Participant" refers any participant who has entered into a covered transaction with a First Tier Participant or other Lower Tier Participants (such as subcontractors and suppliers).

e. The prospective lower tier participant agrees by submitting this proposal that, should the proposed covered transaction be entered into, it shall not knowingly enter into any lower tier covered transaction with a person who is debarred, suspended, declared ineligible, or voluntarily excluded from participation in this covered transaction, unless authorized by the department or agency with which this transaction originated.

f. The prospective lower tier participant further agrees by submitting this proposal that it will include this clause titled "Certification Regarding Debarment, Suspension, Ineligibility and Voluntary Exclusion-Lower Tier Covered Transaction," without modification, in all lower tier covered transactions and in all solicitations for lower tier covered transactions exceeding the \$25,000 threshold.

g. A participant in a covered transaction may rely upon a certification of a prospective participant in a lower tier covered transaction that is not debarred, suspended, ineligible, or voluntarily excluded from the covered transaction, unless it knows that the certification is erroneous. A participant is responsible for ensuring that its principals are not suspended, debarred, or otherwise ineligible to participate in covered transactions. To verify the eligibility of its principals, as well as the eligibility of any lower tier prospective participants, each participant may, but is not required to, check the Excluded Parties List System website (<https://www.epls.gov/>), which is compiled by the General Services Administration.

h. Nothing contained in the foregoing shall be construed to require establishment of a system of records in order to render in good faith the certification required by this clause. The knowledge and information of participant is not required to exceed that which is normally possessed by a prudent person in the ordinary course of business dealings.

i. Except for transactions authorized under paragraph e of these instructions, if a participant in a covered transaction knowingly enters into a lower tier covered transaction with a person who is suspended, debarred, ineligible, or voluntarily excluded from participation in this transaction, in addition to other remedies available to the Federal Government, the department or agency with which this transaction originated may pursue available remedies, including suspension and/or debarment.

* * * * *

**Certification Regarding Debarment, Suspension, Ineligibility and Voluntary Exclusion--
Lower Tier Participants:**

1. The prospective lower tier participant certifies, by submission of this proposal, that neither it nor its principals is presently debarred, suspended, proposed for debarment, declared ineligible, or voluntarily excluded from participating in covered transactions by any Federal department or agency.

ATTACHMENT "A"

2. Where the prospective lower tier participant is unable to certify to any of the statements in this certification, such prospective participant shall attach an explanation to this proposal.

* * * * *

XI. CERTIFICATION REGARDING USE OF CONTRACT FUNDS FOR LOBBYING

This provision is applicable to all Federal-aid construction contracts and to all related subcontracts which exceed \$100,000 (49 CFR 20).

1. The prospective participant certifies, by signing and submitting this bid or proposal, to the best of his or her knowledge and belief, that:

a. No Federal appropriated funds have been paid or will be paid, by or on behalf of the undersigned, to any person for influencing or attempting to influence an officer or employee of any Federal agency, a Member of Congress, an officer or employee of Congress, or an employee of a Member of Congress in connection with the awarding of any Federal contract, the making of any Federal grant, the making of any Federal loan, the entering into of any cooperative agreement, and the extension, continuation, renewal, amendment, or modification of any Federal contract, grant, loan, or cooperative agreement.

b. If any funds other than Federal appropriated funds have been paid or will be paid to any person for influencing or attempting to influence an officer or employee of any Federal agency, a Member of Congress, an officer or employee of Congress, or an employee of a Member of Congress in connection with this Federal contract, grant, loan, or cooperative agreement, the undersigned shall complete and submit Standard Form-LLL, "Disclosure Form to Report Lobbying," in accordance with its instructions.

2. This certification is a material representation of fact upon which reliance was placed when this transaction was made or entered into. Submission of this certification is a prerequisite for making or entering into this transaction imposed by 31 U.S.C. 1352. Any person who fails to file the required certification shall be subject to a civil penalty of not less than \$10,000 and not more than \$100,000 for each such failure.

3. The prospective participant also agrees by submitting its bid or proposal that the participant shall require that the language of this certification be included in all lower tier subcontracts, which exceed \$100,000 and that all such recipients shall certify and disclose accordingly.

ATTACHMENT A - EMPLOYMENT AND MATERIALS PREFERENCE FOR APPALACHIAN DEVELOPMENT HIGHWAY SYSTEM OR APPALACHIAN LOCAL ACCESS ROAD CONTRACTS

This provision is applicable to all Federal-aid projects funded under the Appalachian Regional Development Act of 1965.

1. During the performance of this contract, the contractor undertaking to do work which is, or reasonably may be, done as on-site work, shall give preference to qualified persons who regularly reside in the labor area as designated by the DOL wherein the contract work is situated, or the subregion, or the Appalachian counties of the State wherein the contract work is situated, except:

a. To the extent that qualified persons regularly residing in the area are not available.

b. For the reasonable needs of the contractor to employ supervisory or specially experienced personnel necessary to assure an efficient execution of the contract work.

c. For the obligation of the contractor to offer employment to present or former employees as the result of a lawful collective bargaining contract, provided that the number of nonresident persons employed under this subparagraph (1c) shall not exceed 20 percent of the total number of employees employed by the contractor on the contract work, except as provided in subparagraph (4) below.

2. The contractor shall place a job order with the State Employment Service indicating (a) the classifications of the laborers, mechanics and other employees required to perform the contract work, (b) the number of employees required in each classification, (c) the date on which the participant estimates such employees will be required, and (d) any other pertinent information required by the State Employment Service to complete the job order form. The job order may be placed with the State Employment Service in writing or by telephone. If during the course of the contract work, the information submitted by the contractor in the original job order is substantially modified, the participant shall promptly notify the State Employment Service.

3. The contractor shall give full consideration to all qualified job applicants referred to him by the State Employment Service. The contractor is not required to grant employment to any job applicants who, in his opinion, are not qualified to perform the classification of work required.

4. If, within one week following the placing of a job order by the contractor with the State Employment Service, the State Employment Service is unable to refer any qualified job applicants to the contractor, or less than the number requested, the State Employment Service will forward a certificate to the contractor indicating the unavailability of applicants. Such certificate shall be made a part of the contractor's permanent project records. Upon receipt of this certificate, the contractor may employ persons who do not normally reside in the labor area to fill positions covered by the certificate, notwithstanding the provisions of subparagraph (1c) above.

5. The provisions of 23 CFR 633.207(e) allow the contracting agency to provide a contractual preference for the use of mineral resource materials native to the Appalachian region.

6. The contractor shall include the provisions of Sections 1 through 4 of this Attachment A in every subcontract for work which is, or reasonably may be, done as on-site work.

WORKER'S COMPENSATION AND LIABILITY INSURANCE

The CONTRACTOR agrees to procure and maintain, until final acceptance by the City of the work covered by this Agreement, insurance of the kinds and in amounts hereinafter provided in insurance companies authorized to do business in the State of New York, covering all operations under this Agreement whether performed by him or subcontractors. Before commencing the work, the CONTRACTOR shall furnish to the COMMISSIONER and to the City of New York a certificate or certificates, in form satisfactory to the COMMISSIONER and to the CITY, showing that he has complied with this requirement, which certificate or certificates, shall provide that the policies shall not be changed or cancelled until thirty (30) days written notice has been given to the COMMISSIONER and to the City of New York. The kinds and amounts of insurance required are as specified in Schedule "A" shown on Pages SA-1 to SA-10, in Volume 3 of 3.

This Agreement shall be void and of no force and effect unless the Contractor shall provide coverage for the benefit of, and keep covered during the life of this agreement, such employees as are required to be covered by the provisions of the Worker's Compensation Law. (State Finance Law Section 142)

NO FURTHER TEXT ON THIS PAGE

APPENDIX A

STANDARD CLAUSES FOR NEW YORK STATE CONTRACTS

TABLE OF CONTENTS

	Page
1. Executory Clause	3
2. Non-Assignment Clause	3
3. Comptroller's Approval	3
4. Workers' Compensation Benefits	3
5. Non-Discrimination Requirements	3
6. Wage and Hours Provisions	3
7. Non-Collusive Bidding Certification	4
8. International Boycott Prohibition	4
9. Set-Off Rights	4
10. Records	4
11. Identifying Information and Privacy Notification	4
12. Equal Employment Opportunities For Minorities and Women	4-5
13. Conflicting Terms	5
14. Governing Law	5
15. Late Payment	5
16. No Arbitration	5
17. Service of Process	5
18. Prohibition on Purchase of Tropical Hardwoods	5-6
19. MacBride Fair Employment Principles	6
20. Omnibus Procurement Act of 1992	6
21. Reciprocity and Sanctions Provisions	6
22. Compliance with New York State Information Security Breach and Notification Act	6
23. Compliance with Consultant Disclosure Law	6
24. Procurement Lobbying	7
25. Certification of Registration to Collect Sales and Compensating Use Tax by Certain State Contractors, Affiliates and Subcontractors	7
26. Iran Divestment Act	7

STANDARD CLAUSES FOR NYS CONTRACTS

The parties to the attached contract, license, lease, amendment or other agreement of any kind (hereinafter, "the contract" or "this contract") agree to be bound by the following clauses which are hereby made a part of the contract (the word "Contractor" herein refers to any party

2. NON-ASSIGNMENT CLAUSE. In accordance with Section 138 of the State Finance Law, this contract may not be assigned by the Contractor or its right, title or interest therein assigned, transferred, conveyed, sublet or otherwise disposed of without the State's previous written consent, and attempts to do so are null and void. Notwithstanding the foregoing, such prior written consent of an assignment of a contract let pursuant to Article XI of the State Finance Law may be waived at the discretion of the contracting agency and with the concurrence of the State Comptroller where the original contract was subject to the State Comptroller's approval, where the assignment is due to a reorganization, merger or consolidation of the Contractor's business entity or enterprise. The State retains its right to approve an assignment and to require that any Contractor demonstrate its responsibility to do business with the State. The Contractor may, however, assign its right to receive payments without the State's prior written consent unless this contract concerns Certificates of Participation pursuant to Article 5-A of the State Finance Law.

3. COMPTROLLER'S APPROVAL. In accordance with Section 112 of the State Finance Law (or, if this contract is with the State University or City University of New York, Section 355 or Section 6218 of the Education Law), if this contract exceeds \$50,000 (or the minimum thresholds agreed to by the Office of the State Comptroller for certain S.U.N.Y. and C.U.N.Y. contracts), or if this is an amendment for any amount to a contract which, as so amended, exceeds said statutory amount, or if, by this contract, the State agrees to give something other than money when the value or reasonably estimated value of such consideration exceeds \$10,000, it shall not be valid, effective or binding upon the State until it has been approved by the State Comptroller and filed in his office. Comptroller's approval of contracts let by the Office of General Services is required when such contracts exceed \$85,000 (State Finance Law Section 163.6-a). However, such pre-approval shall not be required for any contract established as a centralized contract through the Office of General Services or for a purchase order or other transaction issued under such centralized contract.

4. WORKERS' COMPENSATION BENEFITS. In accordance with Section 142 of the State Finance Law, this contract shall be void and of no force and effect unless the Contractor shall provide and maintain coverage during the life of this contract for the benefit of such employees as are required to be covered by the provisions of the Workers' Compensation Law.

other than the State, whether a contractor, licenser, licensee, lessor, lessee or any other party):

1. EXECUTORY CLAUSE. In accordance with Section 41 of the State Finance Law, the State shall have no liability under this contract to the Contractor or to anyone else beyond funds appropriated and available for this contract.

5. NON-DISCRIMINATION REQUIREMENTS. To the extent required by Article 15 of the Executive Law (also known as the Human Rights Law) and all other State and Federal statutory and constitutional non-discrimination provisions, the Contractor will not discriminate against any employee or applicant for employment because of race, creed, color, sex (including gender identity or expression), national origin, sexual orientation, military status, age, disability, predisposing genetic characteristics, marital status or domestic violence victim status. Furthermore, in accordance with Section 220-e of the Labor Law, if this is a contract for the construction, alteration or repair of any public building or public work or for the manufacture, sale or distribution of materials, equipment or supplies, and to the extent that this contract shall be performed within the State of New York, Contractor agrees that neither it nor its subcontractors shall, by reason of race, creed, color, disability, sex, or national origin: (a) discriminate in hiring against any New York State citizen who is qualified and available to perform the work; or (b) discriminate against or intimidate any employee hired for the performance of work under this contract. If this is a building service contract as defined in Section 230 of the Labor Law, then, in accordance with Section 239 thereof, Contractor agrees that neither it nor its subcontractors shall by reason of race, creed, color, national origin, age, sex or disability: (a) discriminate in hiring against any New York State citizen who is qualified and available to perform the work; or (b) discriminate against or intimidate any employee hired for the performance of work under this contract. Contractor is subject to fines of \$50.00 per person per day for any violation of Section 220-e or Section 239 as well as possible termination of this contract and forfeiture of all moneys due hereunder for a second or subsequent violation.

6. WAGE AND HOURS PROVISIONS. If this is a public work contract covered by Article 8 of the Labor Law or a building service contract covered by Article 9 thereof, neither Contractor's employees nor the employees of its subcontractors may be required or permitted to work more than the number of hours or days stated in said statutes, except as otherwise provided in the Labor Law and as set forth in prevailing wage and supplement schedules issued by the State Labor Department. Furthermore, Contractor and its subcontractors must pay at least the prevailing wage rate and pay or provide the prevailing supplements, including the premium rates for overtime pay, as determined by the State Labor Department in accordance with the Labor Law. Additionally, effective April 28, 2008, if this is a public work contract covered by Article 8 of the Labor Law, the Contractor understands and agrees that the filing of payrolls in a manner

consistent with Subdivision 3-a of Section 220 of the Labor Law shall be a condition precedent to payment by the State of any State approved sums due and owing for work done upon the project.

7. NON-COLLUSIVE BIDDING CERTIFICATION. In accordance with Section 139-d of the State Finance Law, if this contract was awarded based upon the submission of bids, Contractor affirms, under penalty of perjury, that its bid was arrived at independently and without collusion aimed at restricting competition. Contractor further affirms that, at the time Contractor submitted its bid, an authorized and responsible person executed and delivered to the State a non-collusive bidding certification on Contractor's behalf.

8. INTERNATIONAL BOYCOTT PROHIBITION. In accordance with Section 220-f of the Labor Law and Section 139-h of the State Finance Law, if this contract exceeds \$5,000, the Contractor agrees, as a material condition of the contract, that neither the Contractor nor any substantially owned or affiliated person, firm, partnership or corporation has participated, is participating, or shall participate in an international boycott in violation of the federal Export Administration Act of 1979 (50 USC App. Sections 2401 et seq.) or regulations thereunder. If such Contractor, or any of the aforesaid affiliates of Contractor, is convicted or is otherwise found to have violated said laws or regulations upon the final determination of the United States Commerce Department or any other appropriate agency of the United States subsequent to the contract's execution, such contract, amendment or modification thereto shall be rendered forfeit and void. The Contractor shall so notify the State Comptroller within five (5) business days of such conviction, determination or disposition of appeal (2NYCRR 105.4).

9. SET-OFF RIGHTS. The State shall have all of its common law, equitable and statutory rights of set-off. These rights shall include, but not be limited to, the State's option to withhold for the purposes of set-off any moneys due to the Contractor under this contract up to any amounts due and owing to the State with regard to this contract, any other contract with any State department or agency, including any contract for a term commencing prior to the term of this contract, plus any amounts due and owing to the State for any other reason including, without limitation, tax delinquencies, fee delinquencies or monetary penalties relative thereto. The State shall exercise its set-off rights in accordance with normal State practices including, in cases of set-off pursuant to an audit, the finalization of such audit by the State agency, its representatives, or the State Comptroller.

10. RECORDS. The Contractor shall establish and maintain complete and accurate books, records, documents, accounts and other evidence directly pertinent to performance under this contract (hereinafter, collectively, "the Records"). The Records must be kept for the balance of the calendar year in

which they were made and for six (6) additional years thereafter. The State Comptroller, the Attorney General and any other person or entity authorized to conduct an examination, as well as the agency or agencies involved in this contract, shall have access to the Records during normal business hours at an office of the Contractor within the State of New York or, if no such office is available, at a mutually agreeable and reasonable venue within the State, for the term specified above for the purposes of inspection, auditing and copying. The State shall take reasonable steps to protect from public disclosure any of the Records which are exempt from disclosure under Section 87 of the Public Officers Law (the "Statute") provided that: (i) the Contractor shall timely inform an appropriate State official, in writing, that said records should not be disclosed; and (ii) said records shall be sufficiently identified; and (iii) designation of said records as exempt under the Statute is reasonable. Nothing contained herein shall diminish, or in any way adversely affect, the State's right to discovery in any pending or future litigation.

11. IDENTIFYING INFORMATION AND PRIVACY NOTIFICATION.

(a) Identification Number(s). Every invoice or New York State Claim for Payment submitted to a New York State agency by a payee, for payment for the sale of goods or services or for transactions (e.g., leases, easements, licenses, etc.) related to real or personal property must include the payee's identification number. The number is any or all of the following: (i) the payee's Federal employer identification number, (ii) the payee's Federal social security number, and/or (iii) the payee's Vendor Identification Number assigned by the Statewide Financial System. Failure to include such number or numbers may delay payment. Where the payee does not have such number or numbers, the payee, on its invoice or Claim for Payment, must give the reason or reasons why the payee does not have such number or numbers.

(b) Privacy Notification. (1) The authority to request the above personal information from a seller of goods or services or a lessor of real or personal property, and the authority to maintain such information, is found in Section 5 of the State Tax Law. Disclosure of this information by the seller or lessor to the State is mandatory. The principal purpose for which the information is collected is to enable the State to identify individuals, businesses and others who have been delinquent in filing tax returns or may have understated their tax liabilities and to generally identify persons affected by the taxes administered by the Commissioner of Taxation and Finance. The information will be used for tax administration purposes and for any other purpose authorized by law. (2) The personal information is requested by the purchasing unit of the agency contracting to purchase the goods or services or lease the real or personal property covered by this contract or lease. The information is maintained in the Statewide Financial System by the Vendor Management Unit within the Bureau of State Expenditures, Office of the State Comptroller, 110 State Street, Albany, New York 12236.

12. EQUAL EMPLOYMENT OPPORTUNITIES FOR MINORITIES AND WOMEN.

In accordance with Section 312 of the Executive Law and 5 NYCRR 143, if this contract is: (i) a written agreement or purchase order instrument, providing for a total expenditure in excess of \$25,000.00, whereby a contracting agency is committed to expend or does expend funds in return for labor, services, supplies, equipment, materials or any combination of the foregoing, to be performed for, or rendered or furnished to the contracting agency; or (ii) a written agreement in excess of \$100,000.00 whereby a contracting agency is committed to expend or does expend funds for the acquisition, construction, demolition, replacement, major repair or renovation of real property and improvements thereon; or (iii) a written agreement in excess of \$100,000.00 whereby the owner of a State assisted housing project is committed to expend or does expend funds for the acquisition, construction, demolition, replacement, major repair or renovation of real property and improvements thereon for such project, then the following shall apply and by signing this agreement the Contractor certifies and affirms that it is Contractor's equal employment opportunity policy that:

(a) The Contractor will not discriminate against employees or applicants for employment because of race, creed, color, national origin, sex, age, disability or marital status, shall make and document its conscientious and active efforts to employ and utilize minority group members and women in its work force on State contracts and will undertake or continue existing programs of affirmative action to ensure that minority group members and women are afforded equal employment opportunities without discrimination. Affirmative action shall mean recruitment, employment, job assignment, promotion, upgradings, demotion, transfer, layoff, or termination and rates of pay or other forms of compensation;

(b) at the request of the contracting agency, the Contractor shall request each employment agency, labor union, or authorized representative of workers with which it has a collective bargaining or other agreement or understanding, to furnish a written statement that such employment agency, labor union or representative will not discriminate on the basis of race, creed, color, national origin, sex, age, disability or marital status and that such union or representative will affirmatively cooperate in the implementation of the Contractor's obligations herein; and

(c) the Contractor shall state, in all solicitations or advertisements for employees, that, in the performance of the State contract, all qualified applicants will be afforded equal employment opportunities without discrimination because of race, creed, color, national origin, sex, age, disability or marital status.

Contractor will include the provisions of "a", "b", and "c" above, in every subcontract over \$25,000.00 for the

construction, demolition, replacement, major repair, renovation, planning or design of real property and improvements thereon (the "Work") except where the Work is for the beneficial use of the Contractor. Section 312 does not apply to: (i) work, goods or services unrelated to this contract; or (ii) employment outside New York State. The State shall consider compliance by a contractor or subcontractor with the requirements of any federal law concerning equal employment opportunity which effectuates the purpose of this section. The contracting agency shall determine whether the imposition of the requirements of the provisions hereof duplicate or conflict with any such federal law and if such duplication or conflict exists, the contracting agency shall waive the applicability of Section 312 to the extent of such duplication or conflict. Contractor will comply with all duly promulgated and lawful rules and regulations of the Department of Economic Development's Division of Minority and Women's Business Development pertaining hereto.

13. CONFLICTING TERMS. In the event of a conflict between the terms of the contract (including any and all attachments thereto and amendments thereof) and the terms of this Appendix A, the terms of this Appendix A shall control.

14. GOVERNING LAW. This contract shall be governed by the laws of the State of New York except where the Federal supremacy clause requires otherwise.

15. LATE PAYMENT. Timeliness of payment and any interest to be paid to Contractor for late payment shall be governed by Article 11-A of the State Finance Law to the extent required by law.

16. NO ARBITRATION. Disputes involving this contract, including the breach or alleged breach thereof, may not be submitted to binding arbitration (except where statutorily authorized), but must, instead, be heard in a court of competent jurisdiction of the State of New York.

17. SERVICE OF PROCESS. In addition to the methods of service allowed by the State Civil Practice Law & Rules ("CPLR"), Contractor hereby consents to service of process upon it by registered or certified mail, return receipt requested. Service hereunder shall be complete upon Contractor's actual receipt of process or upon the State's receipt of the return thereof by the United States Postal Service as refused or undeliverable. Contractor must promptly notify the State, in writing, of each and every change of address to which service of process can be made. Service by the State to the last known address shall be sufficient. Contractor will have thirty (30) calendar days after service hereunder is complete in which to respond.

18. PROHIBITION ON PURCHASE OF TROPICAL HARDWOODS. The Contractor certifies and warrants that all wood products to be used under this contract award will be

in accordance with, but not limited to, the specifications and provisions of Section 165 of the State Finance Law, (Use of Tropical Hardwoods) which prohibits purchase and use of tropical hardwoods, unless specifically exempted, by the State or any governmental agency or political subdivision or public benefit corporation. Qualification for an exemption under this law will be the responsibility of the contractor to establish to meet with the approval of the State.

In addition, when any portion of this contract involving the use of woods, whether supply or installation, is to be performed by any subcontractor, the prime Contractor will indicate and certify in the submitted bid proposal that the subcontractor has been informed and is in compliance with specifications and provisions regarding use of tropical hardwoods as detailed in §165 State Finance Law. Any such use must meet with the approval of the State; otherwise, the bid may not be considered responsive. Under bidder certifications, proof of qualification for exemption will be the responsibility of the Contractor to meet with the approval of the State.

19. MACBRIDE FAIR EMPLOYMENT PRINCIPLES (APPLICABLE ONLY IN NON-FEDERAL AID NEW YORK STATE CONTRACTS). In accordance with the MacBride Fair Employment Principles (Chapter 807 of the Laws of 1992), the Contractor hereby stipulates that the Contractor either (a) has no business operations in Northern Ireland, or (b) shall take lawful steps in good faith to conduct any business operations in Northern Ireland in accordance with the MacBride Fair Employment Principles (as described in Section 165 of the New York State Finance Law), and shall permit independent monitoring of compliance with such principles.

20. OMNIBUS PROCUREMENT ACT OF 1992 (APPLICABLE ONLY IN NON-FEDERAL AID NEW YORK STATE CONTRACTS). It is the policy of New York State to maximize opportunities for the participation of New York State business enterprises, including minority and women-owned business enterprises as bidders, subcontractors and suppliers on its procurement contracts.

Information on the availability of New York State subcontractors and suppliers is available from:

NYS Department of Economic Development
Division for Small Business
Albany, New York 12245
Telephone: 518-292-5100
Fax: 518-292-5884
email: opa@esd.ny.gov

A directory of certified minority and women-owned business enterprises is available from:

NYS Department of Economic Development
Division of Minority and Women's Business Development
633 Third Avenue
New York, NY 10017
212-803-2414
email: mwb certification@esd.ny.gov
<https://ny.newnycontracts.com/FrontEnd/VendorSearchPublic.asp>

The Omnibus Procurement Act of 1992 requires that by signing this bid proposal or contract, as applicable, Contractors certify that whenever the total bid amount is greater than \$1 million:

(a) The Contractor has made reasonable efforts to encourage the participation of New York State Business Enterprises as suppliers and subcontractors, including certified minority and women-owned business enterprises, on this project, and has retained the documentation of these efforts to be provided upon request to the State;

(b) The Contractor has complied with the Federal Equal Opportunity Act of 1972 (P.L. 92-261), as amended;

(c) The Contractor agrees to make reasonable efforts to provide notification to New York State residents of employment opportunities on this project through listing any such positions with the Job Service Division of the New York State Department of Labor, or providing such notification in such manner as is consistent with existing collective bargaining contracts or agreements. The Contractor agrees to document these efforts and to provide said documentation to the State upon request; and

(d) The Contractor acknowledges notice that the State may seek to obtain offset credits from foreign countries as a result of this contract and agrees to cooperate with the State in these efforts.

21. RECIPROCITY AND SANCTIONS PROVISIONS. Bidders are hereby notified that if their principal place of business is located in a country, nation, province, state or political subdivision that penalizes New York State vendors, and if the goods or services they offer will be substantially produced or performed outside New York State, the Omnibus Procurement Act 1994 and 2000 amendments (Chapter 684 and Chapter 383, respectively) require that they be denied contracts which they would otherwise obtain. NOTE: As of May 15, 2002, the list of discriminatory jurisdictions subject to this provision includes the states of South Carolina, Alaska, West Virginia, Wyoming, Louisiana and Hawaii. Contact NYS Department of Economic Development for a current list of jurisdictions subject to this provision.

22. COMPLIANCE WITH NEW YORK STATE INFORMATION SECURITY BREACH AND

NOTIFICATION ACT. Contractor shall comply with the provisions of the New York State Information Security Breach and Notification Act (General Business Law Section 899-aa; State Technology Law Section 208).

23. COMPLIANCE WITH CONSULTANT DISCLOSURE LAW. If this is a contract for consulting services, defined for purposes of this requirement to include analysis, evaluation, research, training, data processing, computer programming, engineering, environmental, health, and mental health services, accounting, auditing, paralegal, legal or similar services, then, in accordance with Section 163 (4-g) of the State Finance Law (as amended by Chapter 10 of the Laws of 2006), the Contractor shall timely, accurately and properly comply with the requirement to submit an annual employment report for the contract to the agency that awarded the contract, the Department of Civil Service and the State Comptroller.

24. PROCUREMENT LOBBYING. To the extent this agreement is a "procurement contract" as defined by State Finance Law Sections 139-j and 139-k, by signing this agreement the contractor certifies and affirms that all disclosures made in accordance with State Finance Law Sections 139-j and 139-k are complete, true and accurate. In the event such certification is found to be intentionally false or intentionally incomplete, the State may terminate the agreement by providing written notification to the Contractor in accordance with the terms of the agreement.

25. CERTIFICATION OF REGISTRATION TO COLLECT SALES AND COMPENSATING USE TAX BY CERTAIN STATE CONTRACTORS, AFFILIATES AND SUBCONTRACTORS.

To the extent this agreement is a contract as defined by Tax Law Section 5-a, if the contractor fails to make the certification required by Tax Law Section 5-a or if during the term of the contract, the Department of Taxation and Finance or the covered agency, as defined by Tax Law 5-a, discovers that the certification, made under penalty of perjury, is false, then such failure to file or false certification shall be a material breach of this contract and this contract may be terminated, by providing written notification to the Contractor in accordance with the terms of the agreement, if the covered agency determines that such action is in the best interest of the State.

26. IRAN DIVESTMENT ACT. By entering into this Agreement, Contractor certifies in accordance with State Finance Law §165-a that it is not on the "Entities Determined to be Non-Responsive Bidders/Offerers pursuant to the New York State Iran Divestment Act of 2012" ("Prohibited Entities List") posted at:
<http://www.ogs.ny.gov/about/regs/docs/ListofEntities.pdf>

Contractor further certifies that it will not utilize on this Contract any subcontractor that is identified on the Prohibited

Entities List. Contractor agrees that should it seek to renew or extend this Contract, it must provide the same certification at the time the Contract is renewed or extended. Contractor also agrees that any proposed Assignee of this Contract will be required to certify that it is not on the Prohibited Entities List before the contract assignment will be approved by the State.

During the term of the Contract, should the state agency receive information that a person (as defined in State Finance Law §165-a) is in violation of the above-referenced certifications, the state agency will review such information and offer the person an opportunity to respond. If the person fails to demonstrate that it has ceased its engagement in the investment activity which is in violation of the Act within 90 days after the determination of such violation, then the state agency shall take such action as may be appropriate and provided for by law, rule, or contract, including, but not limited to, imposing sanctions, seeking compliance, recovering damages, or declaring the Contractor in default.

The state agency reserves the right to reject any bid, request for assignment, renewal or extension for an entity that appears on the Prohibited Entities List prior to the award, assignment, renewal or extension of a contract, and to pursue a responsibility review with respect to any entity that is awarded a contract and appears on the Prohibited Entities list after contract award.

LABOR AND EMPLOYMENT

The provisions of NYS Labor Law, as amended, and referred to in §102-08, *Standard Clauses for All New York State Contracts*, shall be applicable. On contracts financed with Federal-Aid, any provisions of NYS Labor Law that are in conflict with mandatory Federal-Aid construction contract compliance requirements, as contained in 23 CFR 635.117 are superseded. Any provisions of NYS Labor Law that are not in conflict with mandatory Federal-Aid construction contract compliance requirements or the Davis-Bacon Act, but are more restrictive, shall apply.

The Contractor shall directly employ those members of its own organization. Employee leasing and other similar arrangements under which workers are employed by another organization will only be considered under a subcontract approved in accordance with §108-05, *Subletting or Assigning the Contract*.

A. Wages. The Department will provide the Contractor with prevailing wage rate schedules. When both State and Federal wage rate schedules are provided, the Contractor shall pay the higher of the two wages and supplemental (fringe) benefits. If prevailing wage rate schedules are attached, all onsite work shall be paid prevailing wages. The Contractor shall ensure that workers are paid the appropriate wages and supplemental (fringe) benefits. The Contractor shall obtain periodic wage rate schedule updates from the NYS Department of Labor (NYSDOL). Wage rate amendments and supplements are available on the NYSDOL web site at www.labor.state.ny.us. All changes or clarification of labor classification(s) and applicability of prevailing wage rates shall be obtained in writing from the Office of the Director, NYSDOL Bureau of Public Work. The Contractor shall include the cost of changes in wage rate schedules and supplements (fringes) over the contract duration in the contract bid prices.

On-site Contractor or Subcontractor employees shall be paid prevailing wages required under the Davis-Bacon Act. In accordance with 29 CFR 5.2(l), "site of the work" is defined as the physical place or places where the construction called for in the contract will remain when work on it has been completed. Facilities such as fabrication plants, mobile factories, batch plants, borrow pits, etc. are part of the site of the work provided that they are dedicated exclusively to the performance of the contract. Not included in the site of the work are facilities whose continuance in operation are determined wholly without regard to a particular contract. Such permanent, previously established facilities are not a part of the "site of the work," even where the operations for a period of time may be dedicated exclusively to the performance of a contract.

In accordance with NYS Labor Law, Sections 220 and 220-d:

1. No laborer, worker, or mechanic, in the employ of the Contractor, Subcontractor or other person doing or contracting to do the whole or any part of the work contemplated by the contract shall be permitted or required to work more than eight (8) hours in any one calendar day or more than five days in any one week, except in the emergencies set forth in the Labor Law.
2. The wages paid for a legal day's work shall be not less than the prevailing rate of wages as defined by law.
3. The minimum hourly rate of wages to be paid shall not be less than that stated in the contract documents, and any redetermination of the prevailing rate of wages after the contract is approved shall be deemed to be incorporated herein by reference as of the effective date of redetermination and shall form a part of these contract documents.
4. The contract may be forfeited and no sum paid for any work done thereunder on a second conviction for willfully paying less than:
 - a. the stipulated wage scale as provided in Labor Law, §220 (3), as amended, or;
 - b. the stipulated minimum hourly wage scale as provided in Labor Law, §220-d, as amended.

B. Overtime Dispensation. All bidders, in submitting their bids, should base their bids and work progression on the assumption that Overtime Dispensation pursuant to Article 8 of the New York State Labor Law, for any workers, laborers, and mechanics to work more than 8 hours in any one calendar day or more than 5 days in any one week will not be granted for any operation for the contract duration. Regardless of approval or disapproval of overtime by the NYSDOL, no adjustment will be made in any bid prices.

Subsequent to award, where the contract proposal has imposed specific scheduling and/or phasing requirements or where it is determined by the Department to be in the best interest of the public, the Department may process, for approval by the NYSDOL, requests for overtime dispensation on certain specific operations

The Contractor shall submit requests for overtime dispensation to the Department on Form PW- 30, Application for Dispensation for Hours, which will be provided by the Engineer upon request. The Department will review applications for overtime dispensation submitted by the Contractor associated with contracts subject to (A+B) Bidding, Incentive/Disincentive (I/D) or Lane Rental work favorably, but the application should not request more than 60 hours per week. The 60 hours per week may be either 6 - 10 hour days or 5 - 12 hour days. Overtime dispensations will be supported by the Department to advance Department goals and priorities, subject to specific circumstances and conditions associated with each contract.

The Department cannot guarantee that the NYSDOL will grant dispensation from restrictions pursuant to the provisions of Article 8 of the State Labor Law, however with the Department's certification, it is anticipated that they will act favorably, provided that the Contractor is in compliance with Labor Law requirements at the time of application.

C. Payrolls. The Contractor shall furnish the Engineer, each week, a certified payroll and statement of compliance with respect to the wages paid each of its employees, (including apprentices, trainees, watch persons and guards) and a certified payroll from each Subcontractor engaged on work during the preceding weekly payroll period.

Certified payrolls shall contain work class, hours worked, wage rate, payroll taxes and withholdings. Certified payrolls shall be annotated by race and gender, and shall be submitted on Form WH-347 or Form HC-231-1 for Federal-Aid contracts, and on HC-231-1 for non Federal-Aid contracts. At the Contractor's option, computer printed payroll records, which supply the required data and certifications may be used.

D. Training. An apprentice is defined as an individual who is enrolled in an apprenticeship training program that is registered with the NYS Department of Labor. A trainee is defined as an individual who is enrolled in an On-the-Job Training (OJT) program that is approved by the Federal Highway Administration (FHWA).

A number of sources to obtain training for apprentices/trainees are available. These include:

- A NYSDOL-approved apprenticeship program sponsored by a union or a temporary project level agreement with a union which has a NYSDOL approved apprenticeship program.
- A NYSDOL-approved apprenticeship program sponsored by a contractor.
- A NYSDOL-approved apprenticeship program sponsored by a contractor signatory with an apprenticeship sponsor consortium for certain services.
- An FHWA-approved OJT program (where applicable).

Approved OJT Programs are currently limited to apprenticeable occupations as determined by NYSDOL or USDOL. A list of approved OJT programs can be found in the On-the-Job Training and Apprenticeship Program Construction Catalogue which is available through the Department's Office of Equal Opportunity Development and Compliance.

Training under Training Special Provisions, if required, will be shown in the contract documents. In order to fulfill training requirements required under Training Special Provisions and/or §102-11 *Equal Employment Opportunity Requirements*, training should begin as early as possible during a construction contract. The Department recommends that all bidders have an approved apprenticeship or OJT program prior to bidding.

The Contractor shall furnish the apprentice/trainee a copy of the program to be followed in providing the training. The Contractor shall provide each apprentice/trainee with a certification showing the type and length of training satisfactorily completed.

ATTACHMENT "B"

When training is required under Training Special Provisions and/or §102-11 *Equal Employment Opportunity Requirements*, the Contractor shall designate to the Engineer, at the preconstruction meeting, a person (or persons) from its existing workforce as the Trainer and Training Coordinator for any apprentice(s)/ trainee(s).

The Trainer shall:

1. Be located on the contract site generally on a daily basis; and
2. Be responsible for the day-to-day supervision and training of persons on the contract; and
3. Be responsible for the preparation and submission of a monthly training progress report, after consultation with designated apprentices/trainees.

The Training Coordinator shall:

1. Be knowledgeable about the contract and the Apprenticeship/OJT programs to be used; and
2. Be responsible for ensuring on-the-job orientation of apprentice/trainees; and
3. Be responsible for ensuring meaningful and effective training for the duration of training.

E. Public Notices. Before commencing any work on the site, the Contractor shall provide a satisfactory weather resistant surface, and post, in a location accessible to all workers, a copy of the NYSDOL schedules of prevailing wages and supplements for this contract, a copy of all redeterminations of such schedules for the contract, the Workers' Compensation Law notice, required safety notices, and all other notices required by law to be posted at the site. The Contractor shall maintain such notices in a legible manner and shall replace any notice or schedule which is damaged, defaced, illegible or removed for any reason. The Notices shall be maintained until all work on the site is complete.

F. Federal-Aid Requirements. No procedures or requirement shall be imposed by any state which will operate to discriminate against the employment of labor from any other state, possession or territory of the United States, in the construction of a Federal-Aid project. The selection of labor to be employed by the Contractor on any Federal-Aid project shall be of its choosing.

The Contractor shall not use convict labor unless performed by convicts who are on parole, supervised release, or probation for construction, maintenance or any other purpose at the site or within the contract limits of any Federal-Aid highway construction project from the time of contract award or the start of work on force account until final acceptance of the work by the Department.

NON-ASSIGNMENT OF AGREEMENT

In accordance with Section 138 of the State Finance Law, the Contractor agrees not to assign, transfer, convey, sublet or otherwise dispose of this agreement or any part thereof, or of its right, title or interest therein or its power to execute such agreement to any person, company or corporation without the previous consent in writing of the City and of the Commissioner of the Department of Design and Construction and any attempts to assign the agreement without the City's written consent are null and void.

No further Text on This Page

BID DEPOSIT

Accompanying this proposal is a bid bond, certified check or bank cashier's check for the specified amount of deposit required. In the event this proposal is accepted by the Department of Transportation and the undersigned shall fail to execute the contract and in all respects comply with the provisions of Section 38 of the Highway Law, as amended, or where applicable, Section 30 of the Canal Law, as amended, the moneys represented by such bid bond, certified check or Bank cashier's check shall be regarded as liquidated damages and shall be forfeited and become the property of the State of New York; otherwise to be returned to the depositor in accordance with the provisions of said Section 38 of the Highway Law, as amended, or where applicable with Section 30 of the Canal Law, as amended.

On acceptance of this proposal for said work the undersigned does or do hereby bind herself/himself or itself/themselves to enter into written contract, within ten days of date of notice of award, with the said Department of Transportation, and comply in all respects with § 38(6) of the Highway Law, as amended, or where applicable with §30 (7) of the Canal Law, as amended, in relation to security for the faithful performance of the terms of said contract.

**NOTICE TO ALL PROSPECTIVE BIDDERS
FEDERAL-AID CONTRACTS****ASSURANCE OF NON-DISCRIMINATION**

The New York State Department of Transportation, in accordance with Title VI of the Civil Rights Act of 1964, 78 Stat. 252, 42 U.S.C. 2000d to 2000d-4 and Title 49, Code of Federal Regulations, Department of Transportation, Subtitle A, Office of the Secretary, Part 21, Nondiscrimination in Federally-assisted programs of the Department of Transportation and Title 23 Code of Federal Regulations, Part 200, Title VI Program and Related Statutes, as amended, issued pursuant to such Acts, hereby notifies all bidders that it will affirmatively ensure that in any contract entered into pursuant to this advertisement, disadvantaged business enterprises will be afforded full opportunity to submit bids in response to this invitation and will not be discriminated against on the grounds of race, color, national origin, sex, age, disability/handicap and income status in consideration for an award.

1/17/79
5/1/79
6/3/81
5/9/85

L8/3/2010

SUBCONTRACTS

The attention of the Contractor is directed to the requirement that the standard contract clauses, as set forth in the Proposal and in the Labor Compliance Manual (Federal-aid Construction, Appendix D-2, 3) must be physically incorporated in all subcontracts.

Copies of the Labor Compliance Manual referred to above may be examined in the office of the Regional Director.

Rev. 2/27/70
4/20/72
8/30/73
12/7/76

ATTACHMENT "C"

APPENDIX A-1 SUPPLEMENTAL TITLE VI PROVISIONS (CIVIL RIGHTS ACT)

(To be included in all contracts)

During the performance of this contract, the contractor, for itself, its assignees and successors in interest (hereinafter referred to as the "contractor") agrees as follows:

- (1) Compliance with Regulations: The contractor shall comply with the Regulation relative to nondiscrimination in Federally assisted programs of the Department of Transportation of the United States, Title 49, Code of Federal Regulations, Part 21, and the Federal Highway Administration (hereinafter "FHWA") Title 23, Code of Federal Regulations, Part 200 as they may be amended from time to time, (hereinafter referred to as the Regulations), which are herein incorporated by reference and made a part of this contract.
- (2) Nondiscrimination: The Contractor, with regard to the work performed by it during the contract, shall not discriminate on the grounds of race, religion, age, color, sex or national origin, sex, age, and disability/handicap in the selection and retention of subcontractors, including procurements of materials and leases of equipment. The contractor shall not participate either directly or indirectly in the discrimination prohibited by 49 CFR, section 21.5 of the Regulations, including employment practices when the contract covers a program set forth in Appendix B of the Regulations.
- (3) Solicitations for Subcontractors, Including Procurements of Materials and Equipment: In all solicitations either by competitive bidding or negotiation made by the contractor for work to be performed under a subcontract, including procurements of materials or leases of equipment, each potential subcontractor or supplier shall be notified by the contractor of the contractor's obligations under this contract and the Regulations relative to nondiscrimination on the grounds of race, color, or national origin, sex, age, and disability/handicap.
- (4) Information and Reports: The contractor shall provide all information and reports required by the Regulations or directives issued pursuant thereto, and shall permit access to its books, records, accounts, other sources of information, and its facilities as may be determined by NYSDOT or the FHWA to be pertinent to ascertain compliance with such Regulations, orders and instructions. Where any information required of a contractor is in the exclusive possession of another who fails or refuses to furnish this information the contractor shall so certify to NYSDOT's Office of Civil Rights or FHWA, as appropriate, and shall set forth what efforts it has made to obtain the information.
- (5) Sanctions for Noncompliance: In the event of the contractor's noncompliance with the nondiscrimination provisions of this contract, NYSDOT shall impose such contract sanctions as it or the FHWA may determine to be appropriate, including, but not limited to:
 - a) Withholding of payments to the contractor under the contract until the contractor complies; and/or
 - b) Cancellation, termination or suspension of the contract, in whole or in part.
- (6) Incorporation of Provisions: The contractor shall include the provisions of paragraphs (1) through (6) in every subcontract, including procurements of materials and leases of equipment, unless exempt by the Regulations, or directives issued pursuant thereto.

ATTACHMENT "C"

The contractor shall take such action with respect to any subcontractor procurement as NYSDOT or the FHWA may direct as a means of enforcing such provisions including sanctions for non-compliance: Provided, however, that in the event a contractor becomes involved in, or is threatened with, litigation with a subcontractor or supplier as a result of such direction, the contractor may request NYSDOT to enter into such litigation to protect the interests of NYSDOT, and, in addition, the contractor may request the United States to enter into such litigation to protect the interests of the United States.

**PROVISIONS RELATING TO THE NEW YORK STATE LABOR LAW,
PREVAILING WAGES, AND THE USE OF CONVICT LABOR AND
MATERIALS ON FEDERAL & STATE CONTRACTS**

GENERAL PROVISIONS. All projects funded with Federal aid and let to contract in New York State shall conform to the provisions of the New York State Labor Law, except that in accordance with the authorization in Article 4, Section 85 of the New York State Highway Law, any provisions of the above referenced Labor Law which are in conflict with the following enumerated mandatory Federal Aid highway construction compliance requirements, as contained in Section 635 of the Code of Federal Regulations, Title 23-Highways, and other Federal legislation, rules, and regulations, as referenced below, are superseded:

CONVICT LABOR. No convict labor, unless performed by convicts who are on parole, supervised release, or probation, shall be employed in construction or used for maintenance or any other purposes at the site or within the limits of any Federal Aid highway construction project from the time of award of the contract or the start of work on force account until final acceptance of the work by the Owner.

SELECTION OF LABOR. No procedures or requirements shall be imposed by any state or municipal subdivision thereof which will operate to discriminate against the employment of labor from any other state, possession, or territory of the United States, in the construction of a Federal Aid project. The selection of labor to be employed by the Contractor on any Federal Aid project shall be of his/her own choosing.

WAGE RATES ON FEDERAL AID PROJECTS. Attention is directed to the statutory provisions governing the prevailing rates of wages for workmen, mechanics, and laborers who are employed on this project. Section 220 of the New York State Labor Law, as amended, requires that the wages paid for a legal day's work shall be not less than the rate of wages plus the supplements prevailing at the time the work is performed, the current schedules of which shall be included in the contract documents. Such schedules may be amended or supplemented from time to time, and such amendments or supplements shall be forwarded to the Contractor.

The Federal Aid Highway Act of 1968 provides for the payment of wages at rates not less than those determined in accordance with the Davis-Bacon Act (40 USC, Section 276-a), the schedule of which shall also be included in the contract documents.

On-site materials suppliers, in addition to all subcontractors, are subject to the provisions of the Davis-Bacon Act. This will not necessarily be construed as causing the on-site material suppliers to be classified as subcontractors as part of the 50% limitation on the subcontracting of this project.

In case of a variance between (1) the schedules of prevailing rates of wages and supplements as determined under Section 220 of the New York State Labor Law, and (2) the schedule of rates of wages as determined pursuant to the Davis-Bacon Act, the Contractor shall accept and use the schedule or schedules that establish the higher rate of wages as the minimum for the workmen who are employed on the project.

CONSTRUCTION BY FEDERAL AGENCIES. When construction on Federal Aid highways is being performed by any Federal agency under its procedures and by Federal contract, the labor standards relating to direct federal contracts shall be applicable.

NON-DISCRIMINATION. Employment shall be provided without regard to race, color, religion, sex, or national origin.

CONVICT-PRODUCED MATERIALS. The use of convict-produced materials on any Federal or Federally-assisted contract must comply with the following requirements:

a. Materials produced by convict labor may only be incorporated in a Federal Aid highway construction project if such materials have been:

1. Produced by convicts who are on parole, supervised release, or probation from a prison; or
2. Produced in a qualified prison facility and the cumulative annual production amount of such materials for use in Federal Aid highway construction does not exceed the amount of such materials produced in such facility for use in Federal Aid highway construction during the 12-month period ending July 1, 1987.

b. "Qualified prison facility" means any prison facility in which convicts, during the 12-month period ending July 1, 1997, produced materials for use in Federal Aid highway construction projects.

c. Standard State and Federal Aid contract procedures may be used to assure compliance with the requirements of this paragraph.

FEDERAL WAGE RATES

>

General Decision Number: NY140003 10/10/2014 NY3

Superseded General Decision Number: NY20130003

State: New York

Construction Types: Building, Heavy, Highway and Residential

Counties: Bronx, Kings, New York, Queens and Richmond
Counties in New York.

BUILDING & RESIDENTIAL CONSTRUCTION PROJECTS (includes single family homes and apartments up to and including 4 stories),
HEAVY AND HIGHWAY CONSTRUCTION PROJECTS

Modification Number	Publication Date
0	01/03/2014
1	01/17/2014
2	01/24/2014
3	03/07/2014
4	04/04/2014
5	06/06/2014
6	06/20/2014
7	06/27/2014
8	07/04/2014
9	07/11/2014
10	07/18/2014
11	07/25/2014
12	08/15/2014
13	08/22/2014
14	08/29/2014
15	09/19/2014
16	10/10/2014

ASBE0012-001 12/30/2013

	Rates	Fringes
Asbestos Workers/Insulator Includes application of all insulating materials, protective coverings, coatings and finishes to all types of mechanical systems.....	\$ 64.73	30.44
HAZARDOUS MATERIAL HANDLER.....	\$ 40.00	10.75

BOIL0005-001 01/01/2013

	Rates	Fringes
BOILERMAKER.....	\$ 49.47	33%+22.87+a

FOOTNOTE:

a. PAID HOLIDAYS: New Year's Day, Thanksgiving Day, Memorial Day, Independence Day, Labor Day and Good Friday, Friday after Thanksgiving, Christmas Eve Day and New Year's Eve

BRNY0001-001 07/01/2013

	Rates	Fringes
BRICKLAYER.....	\$ 49.09	22.93
MASON - STONE.....	\$ 55.56	26.75

BRNY0001-002 07/01/2014

	Rates	Fringes
Pointer, cleaner and caulker.....	\$ 40.78	27.57

BRNY0004-001 07/01/2014

	Rates	Fringes
MARBLE MASON.....	\$ 55.85	29.73

BRNY0007-001 07/01/2014

	Rates	Fringes
TERRAZZO FINISHER.....	\$ 47.28	32.16
TERRAZZO WORKER/SETTER.....	\$ 48.88	32.18

BRNY0020-001 07/01/2014

	Rates	Fringes
MARBLE FINISHER.....	\$ 44.54	29.31

BRNY0024-001 07/01/2014

	Rates	Fringes
BRICKLAYER		
MARBLE POLISHERS.....	\$ 38.96	23.00

BRNY0052-001 06/01/2014

	Rates	Fringes
Tile Layer.....	\$ 52.58	30.63

BRNY0088-001 06/01/2014

	Rates	Fringes
TILE FINISHER.....	\$ 40.78	27.86

CARP0001-009 07/01/2014

	Rates	Fringes
--	-------	---------

CARPENTER

Carpenters & Soft floor
layers.....\$ 49.88 42.97

CARP0740-001 07/01/2014

	Rates	Fringes
MILLWRIGHT.....	\$ 48.44	49.83

CARP1456-004 07/01/2014

	Rates	Fringes
Dock Builder & Piledrivermen DOCKBUILDERS.....	\$ 48.35	45.07

CARP1456-005 07/01/2014

	Rates	Fringes
Diver Tender.....	\$ 43.45	45.07
Diver.....	\$ 61.30	45.07

CARP1536-001 07/01/2014

	Rates	Fringes
Carpenters: TIMBERMEN.....	\$ 44.33	44.34

ELEC0003-001 05/14/2014

	Rates	Fringes
ELECTRICIAN Electricians.....	\$ 53.00	27.06
Jobbing, and maintenance and repair work.....	\$ 25.30	15.13+a

PAID HOLIDAYS:

a. New Years Day, Martin Luther King, Jr.'s Birthday,
Washington's Birthday, Memorial Day, Independence Day,
Labor Day, Columbus Day, Election Day, Thanksgiving Day,
the day after Thanksgiving Day, and Christmas Day

ELEC1049-001 03/30/2014

QUEENS COUNTY

	Rates	Fringes
Line Construction (Substation and Switching structures pipe type cable installation and maintenance jobs or projects; Railroad electrical		

distribution/transmission
 systems maintenance (when
 work is not performed by
 railroad employees) Overhead
 and Underground
 transmission/distribution
 line work. Fiber optic,
 telephone cable and equipment)

Groundman.....	\$ 29.71	18.9
Heavy Equipment Operator....	\$ 39.62	21.55
Lineman and Cable Splicer...	\$ 49.52	24.28
Tree Trimmer.....	\$ 23.06	28.5%+9.75

ELEV0001-002 03/17/2013

	Rates	Fringes
ELEVATOR MECHANIC		
Elevator Constructor.....	\$ 57.01	27.605+a+b
Modernization and Repair....	\$ 45.14	27.455+a+b

FOOTNOTE:

a. PAID HOLIDAYS: New Year's Day, Good Friday, President's Day, Memorial Day, Independence Day, Labor Day, Columbus Day, Veteran's Day, Thanksgiving Day, Friday after Thanksgiving, and Christmas Day.

b. PAID VACATION: An employee who has worked less than 5 years shall receive vacation pay credit on the basis of 4% of his hourly rate for all hours worked; an employee who has worked 5 to 15 years shall receive vacation pay credit on the basis of 6% of his hourly rate for all hours worked; an employee who has worked 15 or more years shall receive vacation pay credit on the basis of 8% of his hourly rate for all hours worked.

ENGI0014-001 07/01/2013

	Rates	Fringes
Pavement equipment operator		
Asphalt Plants.....	\$ 54.17	28.65+a
Asphalt roller.....	\$ 64.04	28.65+a
Asphalt spreader.....	\$ 65.76	28.65+a
Power Equipment Operator (HEAVY & HIGHWAY)		
GROUP 1.....	\$ 85.00	28.65
GROUP 10.....	\$ 61.53	28.65
GROUP 11.....	\$ 57.46	28.65
GROUP 12.....	\$ 58.74	28.65
GROUP 13.....	\$ 59.21	28.65
GROUP 14.....	\$ 44.63	28.65
GROUP 15.....	\$ 41.44	28.65
GROUP 2.....	\$ 70.10	28.65
GROUP 3.....	\$ 72.34	28.65
GROUP 4.....	\$ 70.63	28.65
GROUP 5.....	\$ 69.23	28.65
GROUP 6.....	\$ 66.45	28.65

GROUP 7.....	\$ 67.70	28.65
GROUP 8.....	\$ 65.76	28.65
GROUP 9.....	\$ 64.34	28.65
Steel erector		
Compressors, Welding		
Machines.....	\$ 41.84	28.65
Cranes, Hydraulic Cranes,		
2 drum derricks,		
Forklifts, Boom Trucks.....	\$ 70.50	28.65
Three drum derricks.....	\$ 73.37	28.65
Utility Laborer		
Horizontal Boring Rig.....	\$ 62.53	28.65
Off shift compressors.....	\$ 51.93	28.65
Utility Compressors.....	\$ 41.18	28.65

POWER EQUIPMENT OPERATOR CLASSIFICATIONS

GROUP 1: Tower crane

GROUP 2: Backhoes, power shovel, Hydraulic clam shells, moles and machines of a similar type

GROUP 3: Mine hoists and crane, etc. used as mine hoists

GROUP 4: Gradalls, keystones, cranes (with digging buckets), bridge cranes, trenching machines, vermeer cutter and machines of a similar nature

GROUP 5: Piledrivers, derrick boats, tunnel shovels

GROUP 6: All drills, and machines of a similar nature

GROUP 7: Back filling machines, cranes, mucking machines, dual drum pavers

GROUP 8: Mixers (concrete w/loading attachments), concrete pavers, cableways, land derricks, power house (low pressure units), concrete pumps

GROUP 9: Concrete plants, well drilling machines, stone crushers double drum hoist, power house (other than above)

GROUP 10: Concrete mixers

GROUP 11: Elevators

GROUP 12: Concrete breaking machine, Hoists (single drum), load masters, locomotive and dinkies over 10 tons

GROUP 13: Vibratory console

GROUP 14: Compressors (portable 3 or more in battery), tugger machine (caissons), well point pumps, chum drill

GROUP 15: Boilers, (high pressure, compressors (portable, single, or 2 in battery, not over 100' apart), pumps (river cofferdam and welding machines (except where arc is operated by members of local 15) push button machines, all engines irrespective of power (power pac) used to drive auxilliary equipment, air, hydraulic etc.

PREMIUMS ON CRANES (Crawler or Truck):

100' to 149' boom - add .50
 150' to 249' boom - add .75
 250' to 349' boom - add 1.00
 350' to 450' boom - add 1.50

Premiums for Cranes on Steel Erection:

100' to 149' boom - add 1.75
 150' to 249' boom - add 2.00
 250' to 349' boom - add 2.25
 350' to 450' boom - add 2.75
 Tower crane - add 2.00

FOOTNOTE:

a. Paid Holidays: New Year's Day; Lincoln's Birthday; Washington's Birthday; Memorial Day; Independence Day; Labor Day; Veterans Day; Columbus Day; Election Day; Thanksgiving Day; and Christmas Day; provided the employee works one day the payroll week in which the holiday occurs.

 ENGI0014-002 07/01/2013

	Rates	Fringes
Power Equipment Operator		
BUILDING & RESIDENTIAL		
GROUP 1.....	\$ 65.83	28.65+a
GROUP 2.....	\$ 69.74	28.65+a
GROUP 3.....	\$ 63.58	28.65+a
GROUP 4.....	\$ 57.82	28.65+a
GROUP 5.....	\$ 43.28	28.65+a

POWER EQUIPMENT OPERATORS CLASSIFICATIONS

GROUP 1: Double drum

GROUP 2: Stone derrick, cranes, hydraulic cranes, boom trucks

GROUP 3: 4 pole Hoist, Single Drum Hoists

GROUP 4: Fork lift, house cars, plaster (platform machine), plaster bucket, concrete pump and all other equipment used for hoisting material

GROUP 5: Compressors, welding machines (cutting concrete work), paint spraying, sand blasting, pumps (with the exclusion of concrete pumps), house car (settlement basis only), all engines irrespective of power (power pac) used to drive auxiliary equipment, air, hydraulic, etc., boilers

Premiums for Cranes:

100'-149' boom - add 1.75
 150'-249' boom - add 2.00
 250'-349' boom - add 2.25
 350'-450' boom - add 2.75
 Tower cranes add 2.00

FOOTNOTE:

a. PAID HOLIDAYS: New Year's Day, Lincoln's Birthday, Memorial Day, Independence Day, Labor Day, Veteran's Day, Columbus Day, Election Day, Thanksgiving Day, and Christmas Day, provided the employee works one day in the payroll week in which the holiday occurs

 IRON0040-002 07/01/2014

BRONX, NEW YORK, RICHMOND

	Rates	Fringes
IRONWORKER, STRUCTURAL.....	\$ 47.75	47.77

 IRON0046-003 07/01/2014

	Rates	Fringes
IRONWORKER METALLIC LATHERS AND REINFORCING IRONWORKERS.....	\$ 40.60	30.56

 IRON0197-001 06/01/2013

	Rates	Fringes
IRONWORKER STONE DERRICKMAN.....	\$ 41.00	36.57

 IRON0361-002 07/01/2014

KINGS, QUEENS

	Rates	Fringes
Ironworkers: (STRUCTURAL).....	\$ 47.75	47.77

 IRON0580-001 07/01/2014

	Rates	Fringes
IRONWORKER, ORNAMENTAL.....	\$ 42.70	44.35

 LABO0006-001 07/01/2013

	Rates	Fringes
LABORER (Cement and Concrete Workers).....	\$ 42.38	20.52

 LABO0029-001 07/01/2013

	Rates	Fringes
Laborers: Heavy Blasters (hydraulic trac		

drill).....\$ 41.30	29.10
Blasters.....\$ 40.55	29.10
Hydraulic Trac Drill.....\$ 29.92	29.10
Jackhammers, Chippers, Spaders, Concrete Breakers, All Other Pneumatic Tools, Walk Behind Self-Propelled Hydraulic Asphalt and Concrete Breaker.....\$ 34.64	29.10
Powder Carriers.....\$ 31.08	29.10
Wagon; Airtrac; Quarry Bar Drill Runners.....\$ 35.07	28.00

LABO0078-001 02/01/2013

	Rates	Fringes
LABORERS		
BUILDING CONSTRUCTION		
ASBESTOS (Removal, Abatement, Encapsulation or Decontamination of asbestos); LEAD; & HAZARDOUS WASTE LABORERS (Hazardous Waste, Hazardous Materials, Biochemical and Mold Remediation, HVAC, Duct Cleaning, Re-spray Fireproofing, etc).....\$ 35.90		
		14.75

LABO0079-001 07/01/2014

	Rates	Fringes
Laborers Building Construction		
Demolition Laborers		
Tier A.....\$ 37.02		23.53
Tier B.....\$ 25.92		17.56
Mason Tenders.....\$ 38.05		24.35

CLASSIFICATIONS

TIER A: Responsible for the removal of all interior petitions and structural petitions that can consist of sheet rock, block or masonry. Also, all structural slab openings for ducts, mechanical, shafts, elevators, slab openings and exterior walls where the building is not being completely demolished.

TIER B: Responsible for shoveling of debris into containers, pushing containers from the inside to the outside of the building.

LABO0147-001 07/01/2013

Rates	Fringes
-------	---------

LABORERS (FREE AIR & TUNNEL).....\$ 52.23 37.23

Maintenance Men, Inside Muck Lock Tenders, Pump Men, Electricians, Cement Finishers, Caulkers, Hydraulic Men, Shield Men, Monorail Operators, Motor Men, Conveyor Men, Powder Carriers, Pan Men, Riggers, Chuck Tenders, Track Men Painters, Nippers, Brakemen, Cable Men, Hose Men, Grout Men, Gravel Men, Form Workers, Concrete Workers, Tunnel Laborers, Mole Nipper (one (1) Mole Sipper per Working Shaft per Shift for up to and including Two (2) Moles

LABO0731-001 07/01/2014

	Rates	Fringes
LABORER		
Building, Heavy and Residential Construction		
LABORER: (Asbestos, Lead, Hazardous Waste Removal (including soil)/CEMENT/CONCRETE.....\$ 39.85	\$ 39.85	34.78
UTILITY LABORER.....\$ 39.70	\$ 39.70	34.78

Paid Holidays: Labor Day and Thanksgiving Day

LABO1010-001 07/01/2011

	Rates	Fringes
Laborers:		
HIGHWAY CONSTRUCTION		
Fence Installer & Repairer.\$ 38.34	\$ 38.34	30.25
FORMSETTERS.....\$ 42.21	\$ 42.21	30.25
LABORERS.....\$ 38.34	\$ 38.34	30.25
Landscape Planting & Maintenance.....\$ 38.34	\$ 38.34	30.25
Maintenance Safety Surface.\$ 38.34	\$ 38.34	30.25
Slurry/Sealcoater/Play Equipment Installer.....\$ 38.34	\$ 38.34	30.25
Small Equipment Operator (Not Operating Engineer)...\$ 38.34	\$ 38.34	30.25
Small Power Tools Operator.\$ 38.34	\$ 38.34	30.25

FOOTNOTES:

a. PAID HOLIDAYS: Memorial Day, Fourth of July, Labor Day, Columbus Day, Election Day and Thanksgiving Day, provided the employee has worked one (1) day in the calendar week in which the said holiday occurs.

LABO1010-002 07/01/2011

	Rates	Fringes
Laborers-Asphalt Construction:		
Micro Paver.....\$ 44.86	\$ 44.86	30.25
Raker.....\$ 44.37	\$ 44.37	30.25

Screedperson.....	\$ 44.86	30.25
Shoveler (Production Paving Only).....	\$ 41.08	30.25
Small Equipment Operator (Asphalt).....	\$ 41.08	30.25

PAIN0009-001 05/01/2014

	Rates	Fringes
GLAZIER.....	\$ 42.50	26.59
PAINTER		
Painters, Drywall Finishers, Lead Abatement Worker.....	\$ 41.75	20.87
Spray, Scaffold and Sandblasting.....	\$ 46.75	21.87

* PAIN0806-001 10/01/2014

	Rates	Fringes
Painters:		
Structural Steel and Bridge.	\$ 48.75	35.63

PAIN1974-001 12/26/2012

	Rates	Fringes
Painters:		
Drywall Tapers/Pointers.....	\$ 43.82	22.01

PLAS0262-001 02/01/2012

	Rates	Fringes
PLASTERER.....	\$ 40.78	26.80

PLAS0262-002 02/01/2012

KINGS AND QUEENS COUNTIES

	Rates	Fringes
PLASTERER.....	\$ 40.78	26.80

PLAS0780-001 07/01/2014

	Rates	Fringes
CEMENT MASON/CONCRETE FINISHER...	\$ 45.88	39.70

PLUM0001-001 07/01/2014

	Rates	Fringes
PLUMBER		
MECHANICAL EQUIPMENT AND SERVICE		
Any repair and/or		

replacement of the
 present plumbing system
 that does not change the
 existing roughing.....\$ 38.27 12.56
 PLUMBERS:.....\$ 65.27 25.50

 PLUM0638-001 06/27/2012

	Rates	Fringes
PLUMBER		
SERVICE FITTERS.....	\$ 26.30	2.55
SPRINKLER FITTERS, STEAMFITTERS.....	\$ 51.25	49.54

Service Fitter work shall consist of all repair, service and maintenance work on domestic, commercial and industrial refrigeration, air conditioning and air cooling, stoker and oil burner apparatus and heating apparatus etc., including but not exclusively the charging, evacuation, leak testing and assembling for all machines for domestic, commercial and industrial refrigeration, air conditioning and heating apparatus. Also, work shall include adjusting, including capacity adjustments, checking and repairing or replacement of all controls and start up of all machines and repairing all defects that may develop on any system for domestic, commercial and industrial refrigeration and all air conditioning, air cooling, stoker and oil burner apparatus and heating apparatus regardless of size or type.

 ROOF0008-003 07/01/2014

	Rates	Fringes
ROOFER.....	\$ 40.70	25.14

 SHEE0028-002 07/31/2014

	Rates	Fringes
SHEET METAL WORKER		
BUILDING CONSTRUCTION.....	\$ 50.91	36.70
RESIDENTIAL CONSTRUCTION....	\$ 27.22	16.48

 TEAM0282-001 07/01/2014

	Rates	Fringes
TRUCK DRIVER		
Asphalt.....	\$ 39.34	41.6025+a
Euclids & Turnapulls.....	\$ 38.875	41.6025+a
High Rise.....	\$ 47.01	41.6025+a

FOOTNOTES:

PAID HOLIDAYS: New Year's Day, Presidents' Day, Memorial Day, Independence Day, Labor Day, Columbus Day, Election Day, Veterans' Day (Armistice Day), Thanksgiving Day, Day after Thanksgiving and Christmas Day. Employees working two (2)

days in the calendar week in which a holiday falls are to be paid for such holiday, provided that they share each remaining workday during such calendar week.

WELDERS - Receive rate prescribed for craft performing operation to which welding is incidental.

Unlisted classifications needed for work not included within the scope of the classifications listed may be added after award only as provided in the labor standards contract clauses (29CFR 5.5 (a) (1) (ii)).

The body of each wage determination lists the classification and wage rates that have been found to be prevailing for the cited type(s) of construction in the area covered by the wage determination. The classifications are listed in alphabetical order of "identifiers" that indicate whether the particular rate is union or non-union.

Union Identifiers

An identifier enclosed in dotted lines beginning with characters other than "SU" denotes that the union classification and rate have found to be prevailing for that classification. Example: PLUM0198-005 07/01/2011. The first four letters, PLUM, indicate the international union and the four-digit number, 0198, that follows indicates the local union number or district council number where applicable, i.e., Plumbers Local 0198. The next number, 005 in the example, is an internal number used in processing the wage determination. The date, 07/01/2011, following these characters is the effective date of the most current negotiated rate/collective bargaining agreement which would be July 1, 2011 in the above example.

Union prevailing wage rates will be updated to reflect any changes in the collective bargaining agreements governing the rates.

0000/9999: weighted union wage rates will be published annually each January.

Non-Union Identifiers

Classifications listed under an "SU" identifier were derived from survey data by computing average rates and are not union rates; however, the data used in computing these rates may

include both union and non-union data. Example: SULA2004-007 5/13/2010. SU indicates the rates are not union majority rates, LA indicates the State of Louisiana; 2004 is the year of the survey; and 007 is an internal number used in producing the wage determination. A 1993 or later date, 5/13/2010, indicates the classifications and rates under that identifier were issued as a General Wage Determination on that date.

Survey wage rates will remain in effect and will not change until a new survey is conducted.

WAGE DETERMINATION APPEALS PROCESS

1.) Has there been an initial decision in the matter? This can be:

- * an existing published wage determination
- * a survey underlying a wage determination
- * a Wage and Hour Division letter setting forth a position on a wage determination matter
- * a conformance (additional classification and rate) ruling

On survey related matters, initial contact, including requests for summaries of surveys, should be with the Wage and Hour Regional Office for the area in which the survey was conducted because those Regional Offices have responsibility for the Davis-Bacon survey program. If the response from this initial contact is not satisfactory, then the process described in 2.) and 3.) should be followed.

With regard to any other matter not yet ripe for the formal process described here, initial contact should be with the Branch of Construction Wage Determinations. Write to:

Branch of Construction Wage Determinations
Wage and Hour Division
U.S. Department of Labor
200 Constitution Avenue, N.W.
Washington, DC 20210

2.) If the answer to the question in 1.) is yes, then an interested party (those affected by the action) can request review and reconsideration from the Wage and Hour Administrator (See 29 CFR Part 1.8 and 29 CFR Part 7). Write to:

Wage and Hour Administrator
U.S. Department of Labor
200 Constitution Avenue, N.W.
Washington, DC 20210

The request should be accompanied by a full statement of the interested party's position and by any information (wage payment data, project description, area practice material, etc.) that the requestor considers relevant to the issue.

3.) If the decision of the Administrator is not favorable, an interested party may appeal directly to the Administrative

Review Board (formerly the Wage Appeals Board). Write to:

Administrative Review Board
U.S. Department of Labor
200 Constitution Avenue, N.W.
Washington, DC 20210

4.) All decisions by the Administrative Review Board are final.

=====
END OF GENERAL DECISION

"BUY AMERICA" REQUIREMENTS & WAIVERS

GENERAL BUY AMERICA BID REQUIREMENTS AND DEFINITION. In accordance with New York State Department of Transportation Official Order No. 1511 establishing consistency for application of Section 146 of the State Finance Law, and Section 165 of the U. S. Surface Transportation Act of 1982, as amended, the Bidder must submit a bid based on permanently incorporating only domestic steel and/or iron in the construction of this contract.

The Bidder may also submit a bid based upon being allowed to permanently incorporate foreign steel and/or iron into the work of the contract. If the Bidder chooses to submit such a bid, the Bidder should purchase an additional proposal for this contract and legibly print the following in ink on the proposal cover and at the bottom of the proposal sheet which contains the phrase "Total gross sum written in words": TOTAL BID BASED UPON USING FOREIGN STEEL AND/OR IRON.

When bids are submitted based upon domestic and foreign steel and/or iron, both bids are to be submitted in the same envelope.

To qualify as domestic, all manufacturing processes (including the fabrication of any product containing steel and/or iron) must have been performed in the United States. To further define the coverage, a domestic product is a manufactured steel and/or iron construction material that was produced in one of the 50 States, the District of Columbia, Puerto Rico, or in the territories and possessions of the United States. Raw material used in the steel and/or iron may be imported. All manufacturing processes to produce steel and/or iron products must occur domestically. Raw materials are materials such as iron ore, limestone, waste products, etc., which are used in the manufacturing process to produce the steel and/or iron products. Waste products would include scrap; i.e., steel and/or iron no longer useful in its present form from old automobiles, machinery, pipe, railroad tracks, and the like. Also, steel and/or iron trimmings from mills or product manufacturing are considered waste. Extracting, crushing, and handling the raw material which is customary to prepare them for transporting are exempt from Buy America.

AWARD OF CONTRACT. Award of this contract will be made to the lowest bidder who submits the lowest total bid based upon furnishing domestic steel and/or iron unless such total bid exceeds the lowest total bid based upon furnishing foreign steel and/or iron by more than 25 percent, in which case award will be made to the lowest responsible bidder based upon furnishing foreign steel and/or iron.

CONTROL OF MATERIALS. All items, regardless of origin, shall comply with their individual specification requirements. In the event the contract is awarded based upon using only domestic steel and/or iron, the Contractor must supply only domestic steel and/or iron and will be paid the domestic steel and/or iron bid prices. The Contractor will be responsible for ensuring that the domestic steel and/or iron is supplied in conformance with the above referenced laws. Such responsibility extends to informing all affected subcontractors and material suppliers of these specific requirements and ascertaining that steel and/or iron being supplied is in conformance with the standard specifications.

ATTACHMENT "E"

In the event that the contract is awarded based upon being allowed to permanently incorporate foreign steel and/or iron in the work, the Contractor may supply either domestic or foreign steel and/or iron and will be paid the foreign steel and/or iron bid prices. If the contract is awarded based upon the domestic steel and/or iron bid, the Contractor may permanently incorporate in the construction of this contract a minimal amount of foreign steel and/or iron if the combined cost of such materials does not exceed one-tenth of one percent (0.1 percent) of the total contract cost or \$2,500.00, whichever is greater. The combined cost of foreign steel and/or iron will be that shown to be the value of the steel and/or iron products as they are delivered to the project.

BUY AMERICA WAIVERS. In addition to the award of a bid based on foreign steel and/or iron materials, waivers to the Buy America requirement may be requested by the State to the Division Federal Highway Administration if it can be demonstrated that the use of domestic steel and/or iron materials would be inconsistent with the public interest, such materials and products are not produced in the United States in sufficient and reasonably available quantities and of satisfactory quality provided one or more of the above requirements are met, the Contractor may submit a request for a waiver to the Engineer. The request shall include copies of all documentation verifying the unavailability of the material or product, and/or justification of the application for a waiver. For Federally Aided contracts, final approval of the Buy America Waiver request will be made by the Division Federal Highway Administration and concurred with by the Director, Construction Division. For non-Federally Aided contracts, upon final approval of the affected Department program areas, notification and approval of the Buy America Waiver request will be made by the Director, Construction Division.

Note: The following is a list of materials or products which have been granted waivers or exclusions from the "BUY AMERICA" provisions:

1. Hollow 'I'-shaped steel extrusions

CERTIFICATIONS AND TRACKING OF FOREIGN STEEL/IRON. In order to ensure compliance with this contract requirement, all manufacture's certifications for steel and/or iron and items including steel and/or iron must contain a statement of domestic origin, and material suppliers must certify that what they provide is the same material certified by the manufacturer. If the material or product certification does not properly identify conformance to the specification the product will be rejected and must be removed from the project site. If however the manufacturer and/or material supplier requests to leave the product in place and provide a revised certification only, the revised certification must be accompanied with a letter of explanation to the satisfaction of the Resident Engineer. The explanation shall indicate the basis for using the revised certification rather than the original supplied. The letter shall also include corrective action to assure that future certifications will be representative of the material or product supplied. The letter must be signed by a company representative that can legally bind the firm.

If the Contractor proposes to use foreign steel/iron in small amounts under the threshold, the amount allowed will be based on the material price to the Contractor, as verified by invoice and approved by the Resident Engineer. The amount is cumulative for the entire contract, so subsequent requests will have to be added to any previous requests before comparison to the allowable threshold.

The "Buy America" contract specification does not apply to iron or steel that is to be used for temporary means which will be removed during or at the end of the project.

DEFINITIONS:

Steel - Steel material of any type, including welding rod.

Iron - Iron material of any type, including cast and ductile iron, but not pig iron.

Domestic - The 50 States, the District of Columbia, Puerto Rico and territories/possessions of the US.

Foreign - Any location other than those defined as Domestic.

Manufacturing Processes - Steel and/or iron manufacturing processes must be domestic; e.g. manufacture, fabrication, grinding, drilling, welding, finishing and coating of steel. Ore, scrap, and pig iron may be foreign or domestic; however, transformation into steel and/or iron and all subsequent processes and fabrication must be domestic. The fabrication of composite items using domestic steel (e.g. casting reinforced concrete box culvert using reinforcing cut and bent to final shapes) is not considered a manufacturing process, and the composite item is acceptable.

Fabricated Product Containing Steel and/or Iron - Items, products or materials containing any amount of steel and/or iron materials; e.g., a metal pipe may be steel or iron, a reinforced concrete pipe contains steel, a prestressed beam contains steel, iron castings are iron, a steel beam is steel and steel laminated bridge bearings contain steel.

(NO TEXT ON THIS PAGE)

EQUAL EMPLOYMENT OPPORTUNITY REQUIREMENTS

**[SEE SECTION 102-11 OF THE
NEW YORK STATE
DEPARTMENT OF TRANSPORTATION STANDARD SPECIFICATIONS]**

GOALS FOR MINORITY PARTICIPATION IN THE CONSTRUCTION INDUSTRY

COUNTY	% GOAL	COUNTY	% GOAL	COUNTY	% GOAL
Albany	3.2	Herkimer	2.1	Richmond	*
Allegany	6.3	Jefferson	2.5	Rockland	22.6
Broome	1.1	Kings	*	St Lawrence	2.5
Bronx	*	Lewis	2.5	Saratoga	3.2
Cattaraugus	6.3	Livingston	5.3	Schenectady	3.2
Cayuga	2.5	Madison	3.8	Schoharie	2.6
Chautauqua	6.3	Monroe	5.3	Schuyler	1.2
Chemung	2.2	Montgomery	3.2	Seneca	5.9
Chenango	1.2	Nassau	5.8	Steuben	1.2
Clinton	2.6	New York	*	Suffolk	5.8
Columbia	2.6	Niagara	7.7	Sullivan	17.0
Cortland	2.5	Oneida	2.1	Tioga	1.1
Delaware	1.2	Onondaga	3.8	Tompkins	1.2
Dutchess	6.4	Ontario	5.3	Ulster	17.0
Erie	7.7	Orange	17.0	Warren	2.6
Essex	2.6	Orleans	5.3	Washington	2.6
Franklin	2.5	Oswego	3.8	Wayne	5.3
Fulton	2.6	Otsego	1.2	Westchester	22.6
Genesee	5.9	Putnam	22.6	Wyoming	6.3
Greene	2.6	Queens	*	Yates	5.9
Hamilton	2.6	Rensselaer	3.2		

* The following goal ranges are applicable to the indicated trades in the counties of Bronx, Kings, New York, Queens, and Richmond:

Electricians.....	9.0 to 10.2
Carpenters.....	27.6 to 32.0
Steam Filters.....	2.2 to 13.5
Metal Lathers.....	26.0 to 28.6
Operating Engineers.....	25.6 to 26.0
Plumbers.....	12.0 to 14.5
Iron Workers (Structural).....	25.9 to 32.0
Elevator Constructors.....	5.5 to 6.5
Bricklayers.....	13.4 to 15.5
Asbestos Workers.....	22.8 to 28.0
Roofers.....	6.3 to 7.5
Iron Workers (Ornamental).....	22.4 to 23.0
Cement Masons.....	23.0 to 27.0
Glaziers.....	16.0 to 20.0
Plasterers.....	15.8 to 18.0
Teamsters.....	22.0 to 22.5
Boilermakers.....	13.0 to 15.5
All Others.....	16.4 to 17.5

GOALS FOR WOMEN

Female Goals -6.9%

Goals for the utilization of women by Federal and Federally assisted construction contractors were last published on April 7, 1978 (43 CFR 4988, 149000). That April 7, 1978 publication included a 6.9% goal for the period from April 1, 1980 until March 31, 1981. Pursuant to 41 CFR 60-4.6, the 6.9% goal for female utilization is extended until further notice

THESE MUST BE INCLUDED IN EACH BID ROPOSAL REGARDLESS OF WHOSE SPECIFICATIONS ARE USED.

NO TEXT

ATTACHMENT "H"

**GOALS FOR DISADVANTAGED/MINORITY/WOMEN'S BUSINESS ENTERPRISE
(D/M/WBE) PARTICIPATION**

The Department has established the following utilization goal(s) for this contract, expressed as a percentage of the total contract bid amount. For clarification of Disadvantaged Business Enterprise (DBE) Utilization, Minority Business Enterprise (MBE) Utilization or Women's Business Enterprise (WBE) Utilization requirements refer to §102-12 *D/M/WBE Utilization* of the Standard Specifications.

Disadvantaged Business Enterprise (DBE) Utilization Goal	<u> 5 </u> % (Federal-Aid Only)
Minority Business Enterprise (MBE) Utilization Goal	<u> 0 </u> % (Non Federal-Aid Only)
Women's Business Enterprise (WBE) Utilization Goal	<u> 0 </u> % (Non Federal-Aid Only)

Directories and/or Information related to the current certification status of Disadvantaged Business Enterprises can be obtained from the NYS Unified Certification Program website at:
<http://biznet.nysucp.net>

Direct questions concerning Disadvantaged Business Enterprise Utilization to:

NYS Department of Transportation
Office of Construction
50 Wolf Road Pod 51
Albany, New York 12232
(518) 457-6472

Direct questions concerning Disadvantaged Business Enterprise Certification to:

NYS Department of Transportation
Contract Audit Bureau
DBE Certification
50 Wolf Road, 6th Floor
Avenue F, 1st Street
Albany, New York 12232
(518) 457-3180

Directories and/or information related to the current certification status of Minority and Women's Business Enterprises, can be obtained by contacting the:

Empire State Development Corporation
Office of Minority and Women's Business Development
30 S. Pearl Street
Albany, NY 12245
(518) 292-5250
<http://www.empire.state.ny.us/MWBE.html>

**DISADVANTAGED BUSINESS ENTERPRISE REQUIREMENTS
FOR FEDERAL AID CONTRACTS**

**[SEE SECTION 102-12 OF THE
NEW YORK STATE
DEPARTMENT OF TRANSPORTATION STANDARD SPECIFICATIONS]**

Contract Requirements

REQUIREMENTS REGARDING TRAINING IN FEDERAL AID CONTRACTS TRAINING SPECIAL PROVISION

GENERAL. The primary objective of this Training Special Provision is to provide training opportunities to minority and disadvantaged¹ persons and women in construction trades for two purposes:

1. To maintain a pool of qualified minority and disadvantaged persons and women to replace those journeyworkers² who, to the natural course of events, will leave the workforce; and
2. To provide minority and disadvantaged persons and women as indentured apprentices or trainees in those geographic areas where shortages in minority and women journeyworkers are recognized because the Contractor's inability to meet the Equal Employment Opportunity (EEO) goals set forth in this contract.

This work shall consist of the employment and meaningful and effective training of minority and disadvantaged persons and women in training programs approved by the N.Y.S. Department of Transportation leading to their qualifications as journeyworkers in the skilled trades required in highway construction. This Training Special Provision supplements the Equal Employment Opportunity requirements included elsewhere in this Proposal entitled either "Standard Federal Equal Employment Opportunity Construction Contract Specifications (Executive Order 11246) or "Equal Employment Opportunity Requirements." Each of the foregoing prescribe specific percentage goals for utilization of minorities and women in the performance of work for the geographic area location of the Contract.

Each contract which contains this Training Special Provision shall require the training of at least one minority or woman indentured apprentice or trainee. Such individual shall be either approved or selected by the Owner with concurrence by the Department of Transportation. Other than this initial training obligation, to be undertaken and provided by the Contractor, no additional training obligations will exist under this Training Special Provision unless the goals for minority and women employment and training in the skilled workforce (exclusive of laborers) are not continuously met on the contract and generally distributed amongst the trades. In the five counties of New York City, the goals specified for each trade are applicable. Whenever the goals are not met, additional minority and/or women indentured apprentices and/or trainees will be assigned or approved in numbers necessary to meet the goals. Data necessary to determine if goals are being met will be provided on Contractor and Subcontractor Monthly Employment Utilization Reports (Form AAP 33LL) submitted by the Contractor on a monthly basis to the Engineer-in-Charge of construction contract, or other agent of the Owner responsible for administering the contract, or other forms approved by the Department of Transportation.

The data will be verified by the visual observance of the Engineer-in-Charge, or designated project inspectors, or other agent of the Owner, and hours of employment reported on Contractor and Subcontractor certified weekly payrolls. The number of minority and women indentured apprentices and trainees required to be trained under this Item shall not exceed the equivalent of 12 1/2% of the total journeyworker workforce on the contract (counted in hours worked), i.e., no more than 1 in 8 of the skilled workforce is required to be a minority or woman indentured apprentice or trainee. This limitation applies regardless of minority or women representation in the trades. However, this limit on required training in no way absolves the Contractor of the responsibility to comply with the EEO contract requirements.

¹ Disadvantaged means a person who is either. (a) a member of a family the receives public assistance, or (b) a member of a family whose income during the previous six (6) months or an annualized basis, was such that (1) the family would have qualified for public assistance, if it had applied for such assistance; or (2) it does not exceed the poverty level. NOTE: The name, address, and social security number of candidates to be trained under the disadvantaged criteria must be submitted to the Owner accompanied by related economic documentation for approval prior to commencing training.

² Journeyworker means a person who is capable of performing all the duties within a trade or a given work classification of a trade approval prior to commencing training, subject to concurrence by the Department of Transportation.

Contract Requirements

REQUIREMENTS REGARDING TRAINING ON FEDERAL AID CONTRACTS

PRECONSTRUCTION MEETING. Before the Contractor will be allowed to begin work, the Contractor shall attend a Preconstruction Meeting and shall submit for the Owner's use and acceptance, a Manpower and Training Utilization Schedule (Form AAP 35LL) which shall be correlated to the Contractor's work schedule. The Schedule shall include at least the following information:

1. A work schedule for the entire contract,
2. An estimate of the work force required to conform to the work schedule on a monthly basis including an estimate of the work force in each trade and/or work classification projected to be used,
3. Separate estimates of the number of minority and women indentured apprentices or trainees that would be required in each skilled trade to meet the contract EEO employment goals for that trade assuming no minority or women journeyworkers in the workforce,
4. The approved training programs to be used and the proposed starting dates for training in each trade and/or work classification,
5. An estimate of the availability of minority and women journeyworkers in numbers sufficient to meet the EEO contract goals, and
6. Any proposal by the Contractor to use trainees or indentured apprentices to make up for anticipated EEO goal shortfalls. Such proposals shall include the name and craft of any individual proposed by the Contractor as the required trainee or indentured apprentice. In the case of an indentured apprentice, evidence of indentureship and registration of the approved apprenticeship program must be included.

No contract work may be undertaken until the Owner has accepted the Schedule and obtained the concurrence of the Department of Transportation. The Contractor shall submit a revised Manpower and Training Utilization Schedule at such times as major changes in the contract work schedule or a significant workforce buildup occurs which substantially affect the previously submitted Schedule.

RECRUITMENT. Although the training requirements of this Training Special Provision are not intended, and shall not be used to discriminate against any applicant for training, whether a member of a protected class or not, it is recognized that non-minority males have traditionally been and continue to be trained, either formally or on-the-job in an informal manner, for in the trades utilized in construction work. Therefore, until such time that representative numbers of minorities and women complete training and their utilization as journeyworkers is demonstrated to the extent of the participation goals set forth in the Department of Transportation's construction contracts, training required under this Training Special Provision will be primarily limited to minorities, women, and disadvantaged individuals.

Thus, the Contractor shall demonstrate compliance with the intent of this Training Special provision by affording the Owner, with the concurrence of the Department of Transportation's appropriate Regional Compliance Specialist (RCS), the opportunity to:

1. First, approve the use of a minority or woman indentured apprentice known to the Contractor through an existing Joint Apprenticeship Training Program, or
2. Second, provide a partially-trained minority or woman trainee who is currently enrolled in a New York State Department of Transportation approved training program, or
3. Third, work cooperatively with the Contractor in recruitment of new minority or women trainees, when needed.

In conformance with the foregoing, the Contractor should submit a Department of Transportation Form AAP-17, Request for Personnel, to the Owner at the Preconstruction Meeting, and the Owner should seek concurrence of that from Department of Transportation's Regional Compliance Specialist. The Contractor is responsible for ensuring that on-the-job orientation for approved indentured apprentices or assigned trainees is provided to such individuals within their first month of employment.

Contract Requirements

WORK HISTORY. No individual shall be employed as a trainee or indentured apprentice in any trade and/or work classification in which such person has successfully completed a training course providing journeyworker status in the same trade or work classification, or in which such person has been gainfully employed as a journeyworker by virtue of informal on-the-job training. Detection of individuals in the above categories may be accomplished by including appropriate questions on employee application forms, inquiries to the Department of Transportation Regional Compliance Specialist, checking personal references, or by other suitable means. Regardless of the method used, the Contractor shall document the findings for each indentured apprentice or trainee provided training under this requirement. A copy of the findings shall be given to the Owner's Engineer or agent in charge of the project, who shall request concurrence of the Department of Transportation. In the case of indentured apprentices, evidence of indentureship in a registered approved apprenticeship program shall also be provided.

SUBCONTRACTING. In the event the Contractor subcontracts a portion of the contract work, the Contractor shall ensure that the requirements of this Training Special Provision are physically incorporated into such subcontracts to ensure that the workforce utilized by the Subcontractor meets the goals for minority and women employment and training, either independently or in combination with the Contractor's workforce. The Contractor must determine the hours of training, if any, and in which trade or work classifications, minority or women indentured apprentices or trainees are to be trained by the Subcontractor(s). However, the Contractor shall retain the primary responsibility for meeting the training requirements of this Training Special Provision. Subcontractors are herewith advised that disregard of these requirements may result in the Department of Transportation either rescinding approval or disapproving their use on subsequent contracts let by the Department of Transportation or on contracts let by other agencies under agreement to the Department of Transportation.

TRAINING AND APPRENTICESHIP PROGRAMS. The minimum length, type of training, and rate of pay for the trade or the work classification of the trade will be specified in the training program approved or sanctioned by the New York State Department of Transportation with the concurrence of the Federal Highway Administration. Both of these agencies shall approve or sanction a training program if it meets the Equal Employment Opportunity obligation of the Contractor and qualifies the trainee for journeyworker status in the trade or work classification concerned by the end of the training period. Furthermore apprenticeship programs registered with the U. S. Department of Labor, Office of Manpower Development, Apprentice Training Section, and training programs approved, but not necessarily sponsored, by the U. S. Department of Labor, Manpower Administration, Bureau of Apprenticeship and Training, shall also be considered acceptable provided they are administered in a manner consistent with the Equal Employment Opportunity obligations of New York State Department of Transportation construction contracts. A copy of the training programs approved by the NYSDOT will be made available by the NYSDOT upon request by the Owner or the Contractor. The Contractor shall provide a copy of the approved apprenticeship or training program to the indentured apprentice or trainee.

Where training is to be provided under this Training Special Provision, the Contractor shall obtain acceptance or approval of the training or apprenticeship program to be used, and the starting time for training, prior to commencing training. The Contractor shall provide on-the-job training directed toward developing journeyworkers in the trade, or work classification(s) of the trade, involved. To the extent that the work involved on the contract permits, such training should include all phases and facets of a trade, or work classification of a trade, to satisfy usual construction industry requirements for continued or future employment therein. Additionally, the Contractor shall provide a minimum of 144 hours per calendar year of related classroom training at an approved facility for each individual so enrolled, in accordance with Article 23 of the New York State Labor Law, Section 815.3.

WAGES. Indentured apprentices will be paid at least 60 percent of the appropriate prevailing wage rate specified in the contract for the same trade or work classification for which they are being trained for the first half of the training period, 75 percent for the third quarter of the training period, and 90 percent for the last quarter of the training period. Trainees will be paid the appropriate prevailing wage specified in the contract for the same trade or work classification for which they are being trained.

Indentured apprentices shall be paid fringe benefits in accordance with the provisions of the apprenticeship program. If the apprenticeship program does not specify fringe benefits apprentices must be paid the full amount of fringe benefits listed on the wage determinations for the applicable classification. On-the-job (OJT) trainees shall be paid fringe benefits in accordance with the provisions of the prevailing wage rates.

If the trainee program does not mention fringe benefits trainees shall be paid the full amount of fringe benefits listed on the wage determinations unless the Administrator of Wage and Hour Division determines that there is an

Contract Requirements

apprenticeship program associated with the corresponding journeyworker wage rate on the wage determination which provides for less than full benefits for apprentices.

DURATION OF TRAINING. Once an indentured apprentice is approved or a trainee is assigned to the contract under this Training Special Provision, that individual shall be trained in the designated trade throughout the duration of the contract whenever such trade is in use on the contract until the trainee or indentured apprentice has completed the approved training program. Where training is provided under a multi-phase apprenticeship or training program, it is expected that training will be provided continually through all phases to the extent that opportunities for such training exist in the work under contract. Upon satisfactory completion of a phase of training under a multi-phase apprenticeship or training program, if training in the remaining phases is not available and work in the completed phase is available, the minority or woman indentured apprentice or trainee shall continue employment, and be compensated at the prevailing journeyworker wage rate for such work. Hours of employment as a journeyworker described above will not be credited toward training hours required by the approved training or apprenticeship program.

A trainee may be terminated at any time during training for excessive absenteeism, lack of punctuality accident-proneness, lack of interest, poor attitude and continued failure to conduct his/herself in a professional manner. However, termination will not occur prior to proper counseling, documentation, and notification in writing to the Owner's Engineer or agent in charge of the project, and to the Department of Transportation's Regional Compliance Specialist, and subsequently the concurrence of the Owner's engineer or agent and the NYSDOT Regional Compliance Specialist, with that termination.

REQUIRED RECORDS. The Contractor shall provide each minority or woman trained under this provision with a certification showing the type and length of training satisfactorily completed. In addition, the Contractor shall keep records on the job site indicating the nature and hours of training provided to each trainee or indentured apprentice documenting performance under this Training Special Provision to the Owner's Engineer or agent in charge of the project and to the Department of Transportation's Regional Compliance Specialist Form AAP-42a, Training Report will be submitted once the trainee or indentured apprentice commences training, completes training, or is terminated and each December 31st that individual is in training. Form AAP 26LL, Monthly Training Progress Report, will be submitted every month after the individual commences training. No measurement will be made of training provided to indentured apprentices or trainees for whom no work history has been provided to the Owner's Engineer or agent in charge of the project. In addition, no measurement will be made of the training provided to apprentices for whom no evidence of indentureship in a registered program has been provided to the Owner's Engineer or agent in charge of the project.

NO PAYMENT FOR TRAINING. No payment will be made to the Contractor for the training required by this Training Special Provision. The required training is a labor cost which is included in the unit prices bid by the Contractor for the items of work comprising the contract.

LISTS OF OJT & REGISTERED APPRENTICESHIP PROGRAMS. Effective April 1, 1992, the New York State Department of Transportation commenced a demonstration program in NYSDOT Regions 2, 3, 5, and 11 requiring the exclusive use of apprenticeship training to fulfill the Training Special Provision and supplement EEO goal attainment. The remaining NYSDOT Regions, contractors will be allowed to use on-the-job training (OJT) programs during the period of the demonstration project. However, only OJT programs for crafts that have been deemed as apprenticeable occupations will be approved. In order to ease the transition from OJT to apprenticeship, it is required that all OJT will participants receive related classroom instruction.

It is the policy of the New York State Department of Transportation to afford equal employment opportunity to traditionally socially and economically disadvantaged persons by providing training opportunities to minority and disadvantaged persons and women to improve their potential for construction employment. NYSDOT, therefore, provides training as a contract requirement on selected construction contracts, including those let by other agencies and local governments under an agreement with NYSDOT.

When OJT is to be provided under this Training Special Provision, the Contractor shall obtain acceptance from the Owner and NYSDOT for the OJT Program to be utilized and the starting time frame for training, prior to commencing training. Accordingly, the following is a listing of OJT programs which have been approved by the NYSDOT and the Federal Highway Administration (FHWA) for utilization in NYSDOT Regions 1, 4, 6, 7, 8, and 10.

NOTE: A contractor in these Regions may opt to use either OJT or apprenticeship programs. However, the use of apprenticeship programs is strongly encouraged.

Contract Requirements

**FOR LISTS OF CURRENTLY APPROVED APPRENTICESHIP PROGRAMS
SEE THE FOLLOWING
NEW YORK STATE
DEPARTMENT OF LABOR's WEB SITE:**

<http://www.labor.ny.gov/apprenticeship/sponsor/index.asp>

NO TEXT

CHANGED CONDITIONS AND DISPUTED WORK PROVISIONS:

It is the goal of the Sponsor to resolve disputes that may arise under the contract in a timely, just and fair manner consistent with the terms of the contract. Towards this goal, the Sponsor is specifying the dispute resolution and disputed work provisions of this Section. This dispute resolution process may be undertaken at any time from the contract award to the submission of the final estimate for payment by the Sponsor. The process recognizes and will take into consideration the risks and controls inherent in construction which the Contractor or the Sponsor have agreed to assume pursuant to the terms of the contract.

If the Contractor considers its disputes unresolved after following the requirements of this Section then at any time prior to the submission of the final agreement for payment to the Sponsor, the Contractor may request in writing a meeting with the Sponsor, or its designated representative, to review any outstanding dispute or items of a dispute that have not been previously resolved to the satisfaction of the Contractor through the dispute resolution process. If the contractor fails to comply with the requirements of this section, any claim of the Contractor with respect thereto shall be deemed waived.

A. TIME RELATED DISPUTES. Whenever the Contractor believes that it is or will be entitled to additional compensation for time related disputes, whether due to delay, extra work, disputed work, breach of contract, or other causes, the Contractor shall follow the procedures set forth in this Section. All subcontracts, supply or equipment contracts shall incorporate these provisions of Dispute Resolution and Disputed Work Provisions. If such subcontracts or supply or equipment contracts do not have similar provisions, then the Sponsor's payments to the Contractor for such subcontract or supply or equipment work shall be limited to only that which are provided by the provisions of this Section as if it were in effect for such subcontract or supply or equipment contract.

1.

a. The term 'dispute' shall mean a matter of contract performance or contract compensation, including granting of extensions of time, in which there is or may be disagreement between the Contractor and the Sponsor and which may involve adjustment of contract items or the addition of new items to the contract, extension of time for performance and/or adjustments in compensation necessitated by the resolution of such disagreement.

b. The term 'time related dispute' shall mean any dispute arising from any event not within the Contractor's control, performance, action, force, or factor which affects the scheduled time of performance depicted in the Contractor's most recent Sponsor approved progress schedule submitted to the Sponsor. This Subsection is intended to cover all such events which include termination, major deductions or increases to quantities of work, Contingencies, Extra Work, Deductions, and suspension of work and cancellation of contract, Right to Suspend Work and Cancel Contract, as well as actions, forces or factors, whether they be termed 'delay', 'disruption', 'interference', 'inefficiencies', 'impedance', 'hindrance', 'acceleration', or otherwise. This subsection shall cover all such applicable events under Differing Site Conditions, Suspensions of Work, and Significant Changes in the Character of the Work Provisions. Notwithstanding the foregoing, for time related compensation requests, the Sponsor will compensate the Contractor for only those instances arising out of the issuance by the Sponsor of a stop work order relative to a substantial portion of the work, or arising out of the unavailability of critical rights of way parcels, either of which are determined by the Sponsor to significantly affect the scheduled completion of the work.

2. Strict compliance with the notice provisions of this Section and compliance with the record keeping provisions of this section and Extra, Force Account Work, Dispute

ATTACHMENT "K"

Compensation and Record keeping, shall be an essential precedent condition under the contract provisions to any recovery of time related damages by the Contractor whether it be under the contract provisions, court actions and proceedings or otherwise.

3. Except for situations that come within the terms of Differing Site Conditions, Suspensions of Work, Significant Changes in the Character of the Work Provisions, subsection 2, Suspensions of Work, within ten work days after the Contractor has knowledge or should have had knowledge of an event, matter or occasion, that will result in time related damages, the Contractor must provide the Engineer with written notice of a dispute for time related damages.

The Sponsor shall have no liability and no adjustment will be made for any time related damages which accrued more than ten work days prior to the filing of such a notice with the Engineer. Failure of the Contractor to give such written notice in a timely fashion will be grounds for denial of the dispute and the Sponsor does not have to show prejudice to its interest before such denial is made. In the event the Contractor fails to provide the required written notice within the ten work day period and the Contractor demonstrates justifiable excuse or cause as determined by the Sponsor for not providing the required written notice, then said 10 day notice period may be lengthened but only if the Contractor has maintained and submits the specified records set forth in these provisions and the Sponsor has knowledge of the matter or occasion that may result in time related damages. In the event the Contractor fails to maintain and submit such specified records, or fails to demonstrate justifiable excuse or cause if such notice is not given, or demonstrates such justifiable excuse or cause but fails to maintain and continue to maintain and submit such specified records, the Contractor hereby agrees to waive the dispute for compensation, notwithstanding the fact that the Sponsor may have actual notice of the facts and circumstances which comprise such dispute and is not prejudiced by said failure.

As directed by the Engineer, the work shall continue during the pendency of the dispute. The Engineer shall make the initial determination in writing on the dispute and the Contractor, if it considers the issue unresolved, shall promptly notify, within ten (10) work days after receipt of the Engineer's decision, notify the Sponsor, in writing with copies to the Engineer of its contentions relative to the dispute, indicating the substance of previous communication on the issue with the Engineer and its rebuttal of his or her previous findings or determinations. The Sponsor, or its designee, shall make a finding thereon and notify the Contractor of same in writing.

Adjustments of contract items, or adjustments to the time of performance, or the addition of new items to the contract necessitated by such dispute determination may be made until the time the final agreement is submitted for payment to the Sponsor, provided that the requirements of this Section are complied with.

4. If time related damages are presumed to have been incurred and after giving the Sponsor notice of a dispute for time related damages, the Contractor must keep daily records of all labor, material, and equipment costs and hours incurred for the affected operations. These daily records must identify each operation affected and the specific locations where work is affected. On a <weekly basis,= beginning the week following the date of giving notice of a dispute for time related damages, the Contractor shall meet with the Engineer and present the daily records for the preceding week. If the Engineer disagrees with the accuracy, applicability, or reasonableness of any portion of the Contractor's submission, he/she shall promptly notify the Contractor who shall correct its records. If there is a dispute as to records, the Contractor must follow the requirements of this specification, Part (C). The dispute shall first be submitted to the Regional Director and if unresolved will be submitted in writing to the Sponsor or his/her

ATTACHMENT "K"

designee whose decision shall be final and conclusive subject to the Contractor's right to assert a claim in New York State Court of Claims. Lack of substantial compliance with the requirements to attend weekly meetings or present its records will constitute a waiver by the Contractor of said dispute for time related damages.

5. After giving notice of a dispute for time related damages, the Contractor shall prepare and submit to the Engineer, if requested, weekly written reports until complete resolution of the dispute, which shall be available at the next scheduled job meeting, providing the following information:

- a. Potential effect to the Contractor's schedule caused by the time related dispute;
- b. Identification of all operations that have been affected or delayed, or are or may be affected or delayed;
- c. Explanation of how the Sponsor's act or omission affected or delayed each operation, and estimation of how much more time is required to complete the project;
- d. Itemization of all extra costs being incurred, including:
 - (1) An explanation as to how those extra costs relate to the effect or delay and how they are being calculated and measured.
 - (2) Identification of all project employees for whom costs are being compiled.
 - (3) Identification of all manufacturers' numbers of all items of equipment for which costs are being compiled.

6. In addition, after submitting the required notice specified in this section, the contractor shall complete its dispute submission by complying with Extra Force Account Work, Dispute Compensation and Record keeping, Part (E), Required Content of Dispute Submission, when such information is ascertainable by the contractor and Part (F), Required Certification of Disputes.

B. ACCELERATION DISPUTES. The Contractor may not maintain a dispute for costs associated with acceleration of the work unless the Sponsor has given prior express written direction by the Engineer to the Contractor to accelerate its effort. The Contractor shall always have the basic obligation to complete the work in the time frames set forth in the contract. For purposes of this Subsection, lack of express written direction on the part of the Sponsor shall never be construed as assent.

If the Contractor does accelerate its work efforts pursuant to a written order or express written approval by the Sponsor, the Contractor shall be compensated for its effort, in the same manner and as limited by Extra Force Account Work, Dispute Compensation and Record keeping, Part (D). The Sponsor, in determining whether or not any compensation under this Section is warranted, will evaluate the facts and circumstances which led to the acceleration to determine whether they were in the Contractor's control.

If the Contractor is claiming a <constructive acceleration,= it must follow the requirements of this section, Part (A).

C. DISPUTED WORK. If the Contractor is of the opinion that any work ordered by the Engineer to be done as contract work is extra work and not contract work, or that any order of the Engineer exceeds the work requirements of the provisions of the contract, the Contractor shall promptly, within ten work days of receipt of the order or direction, notify the Engineer in writing of its contentions thereto. The Contractor must progress the work as required and ordered. In the meantime, the Contractor, if it considers the issue unresolved, shall promptly,

ATTACHMENT "K"

within ten work days of receipt of the Engineer's written decision, notify the Sponsor in writing with copies to the Engineer, of its contentions relative to the dispute, indicating the substance of previous communication on the issue with the Engineer and its rebuttal of their previous findings. The Sponsor, or its designated representative, shall make a finding thereon and notify the Contractor of same in writing. If such work is determined by the Sponsor or its designee to be extra work pursuant to the provisions of this Section, compensation will be made pursuant to Extra Force Account Work, Dispute Compensation and Record keeping, Part B. In addition, after submitting the required notice specified in this section, the contractor shall complete its dispute submission by complying with Extra Force Account Work, Dispute Compensation and Record keeping, Part (E), Required Content of Dispute Submission, when such information is ascertainable by the contractor and Part (F), Required Certification of Disputes. This subsection shall cover all such applicable extra work under Differing Site Conditions, Suspensions of Work, Significant Changes in the Character of the Work Provisions. During the progress of such disputed work, the Contractor and Engineer shall keep daily records and make reports of all labor, material and equipment used in connection with such work and the cost thereof as specified in Extra Force Account Work, Dispute Compensation and Record keeping, Part (C), Force Account Reports.

If the Sponsor or its designated representative determines that the work in question is contract work and not extra work, or that the order complained of is proper, he/she shall again direct the Contractor to continue the disputed work and the Contractor must promptly comply. The Contractor's right to pursue a dispute under this Section for extra compensation or damages will not be affected in any way by the Contractor's complying with the directions of the Sponsor or Engineer to proceed with the work, provided the Contractor continues to keep and furnish the Engineer with Force Account Reports as specified in Extra Force Account Work, Dispute Compensation and Record keeping, Part (C).

If the Sponsor, or its designated representative, determines that such work is extra work and not contract work, or that the order complained of is not proper, then the Sponsor or his/her designated representative shall have prepared, if necessary, an order on contract covering such work as soon as is practical after the determination is made. Payment will be made for such work via agreed price or force account pursuant to Extra Force Account Work, Dispute Compensation and Record keeping, Part (B), New Item Charges. The Sponsor, or its designee, will notify the Contractor in writing of the date upon which the Sponsor has approved the order on contract. Performance of work until receipt of the order on contract by the Contractor shall be considered disputed work. The Contractor must progress the work of the contract, including the work covered by any such order on contract, as directed by the Engineer. Adjustments to contract items, or adjustments to the time of performance, or the addition of new items to the contract necessitated by such determination may be made up until the time the final agreement is submitted for payment to the Sponsor, provided that all the requirements of Extra Force Account Work, Dispute Compensation and Record keeping are complied with. In addition, documented, additional, actual and reasonable costs incurred by the Contractor pursuant to following a written order to perform work (that was subsequently contained in an order on contract which was disapproved) will be considered as reimbursable. This work will be considered disputed work for which the Contractor will be compensated. Eligibility for compensation shall cease upon notification of the order on contract's disapproval. Failure by the Contractor to promptly notify, in writing, the Engineer and the Sponsor of its contentions relative to any dispute or to maintain and furnish force account reports for disputed work shall constitute a waiver of the disputed work claim.

D. **AUDITING OF RECORDS.** The Contractor who has filed a dispute must have the following records available for audit at any time following the filing of such dispute, whether or not such dispute is part of a suit pending in the courts of this State. If a dispute is filed on behalf

ATTACHMENT "K"

of a subcontractor or supplier, such subcontractor or supplier must also have substantially the following records available for audit any time following the filing of such dispute, whether or not such dispute is part of a suit pending in the courts of this State. The audit may be performed by employees of the Sponsor or by an independent auditor appointed by the Sponsor. The audit may begin on ten days' notice to the Contractor, subcontractor, or supplier as is appropriate. The Contractor, subcontractor, or supplier shall cooperate with the auditors. The Sponsor will maintain the audit, its backup, reports, schedules and conclusions as confidential material. Failure of the Contractor, subcontractor, or supplier to maintain and retain sufficient records shall constitute a waiver of that portion of such dispute that cannot be verified and shall bar recovery thereunder.

Without limiting the generality of the foregoing, the auditors shall have available to them and the Contractor agrees to provide access to substantially the following documents:

1. Daily time sheets, job superintendent diaries or log sheets and foreman's daily reports.
2. Union agreements and reports, if any.
3. Insurance policies, welfare and benefits records or plans for union and non-union personnel.
4. Payroll register.
5. Individual employee earnings records.
6. Payroll tax returns.
7. Material invoices, purchase orders, and all material and supply acquisition contracts.
8. Material cost distribution work sheet.
9. Equipment records (list of company equipment, rates, depreciation schedules, daily equipment reports or logs, fueling logs or records, equipment lease purchase agreements, and equipment purchase invoices).
10. Vendor rental agreements, subcontractor invoices, agreements and back charge records.
11. Subcontractor payment certificates.
12. Canceled checks (payroll and vendors).
13. Job cost ledger or report.
14. Job payroll ledger, petty cash journal and supporting vouchers.
15. General ledger, general journal (if used), and all subsidiary ledgers and journals together with all supporting documentation pertinent to entries made in these ledgers and journals.
16. Cash receipts, cash disbursements journal, and purchase journal.
17. Audited and unaudited financial statements for all years reflecting the operation on this project.

ATTACHMENT "K"

18. Depreciation records on all company equipment whether such records are maintained by the company involved, its accountant, or others.

19. If a source other than depreciation records is used to develop costs for the Contractor's internal purposes in establishing the actual cost of owning and operating equipment, all such other source documents.

20. All documents which reflect the Contractor's actual overhead during the years this Project was being performed.

21. All documents related to the preparation of the Contractor's bid including the final calculations on which the bid was based.

22. All documents which relate to each and every dispute together with all documents which support the amount of damages as to each dispute.

23. Work sheets used to prepare the dispute establishing the cost components for items of the dispute including, but not limited to, labor, benefits, insurance, materials, equipment, subcontractors, and all documents which establish the time periods, individuals involved, the hours and the rates for the individuals.

In the event the Contractor fails to substantially furnish the above required reports and accounting records, such failure shall constitute a waiver of the dispute for payment other than for payment at contract unit prices for the work performed.

CONTRACTOR'S RESPONSIBILITY FOR WORK. The Contractor is responsible for carrying out the provisions of the contract at all times, regardless of whether an authorized inspector is present or not. Any work or item that is, at any time, found to be out of specification or not in compliance with the plans shall remain the responsibility of the Contractor and shall be subject to such corrective measures that are approved in writing by the Engineer.

A. CONTRACT ITEM CHARGES. When an order-on-contract provides for similar items of work or materials which increase or decrease the itemized quantity provided for in the primary contract, the price to be paid therefor shall not exceed the unit bid price in the primary contract for such items.

B. NEW ITEM CHARGES.

1. **Agreed Prices.** Agreed prices for new items of work or materials may be incorporated in the order-on-contract as the Sponsor may deem them to be just and fair and beneficial to the Sponsor. These prices must be supported by a complete price analysis in the order-on-contract or, by reference to average bid prices for similar type and quantity of work from other recent contracts. The price analysis will be based on an estimated breakdown of charges listed in the following paragraph 2. "Force Account Charges," unless some other basis is approved by the Sponsor.

2. **Force Account Charges**

3. **Contractor Charges.** Where there are no applicable unit prices for extra work ordered and agreed prices cannot be readily established or substantiated, the Contractor shall be paid the actual and reasonable cost of the following:

(1) **Necessary Materials** (including transportation to the site.) Materials is defined to include all products incorporated in the temporary or permanent work. The following items consumed in

ATTACHMENT "K"

progressing the work are also considered to be materials for which reimbursement with an allowance for profit and overhead will be made. These are oxygen, acetylene, propane, welding rods, grinding wheels, and saw blades. Separate reimbursement will not be made for all other products which may be consumed in progressing the work and reimbursement for these items is considered to be included in the reimbursement for overhead. Material used, if acquired by direct purchase, must be documented by bills or acceptable invoices. All prices on used material incorporated in either temporary or permanent work shall be billed at a fair value, less than the original cost when new. A reasonable salvage credit shall be given for substantial salvageable material recovered. Salvage value of substantial material recovered shall be determined by the Engineer-in-Charge in coordination with the Contractor.

(2) Necessary labor costs including supplemental benefit payments. Each class of labor shall be billed separately at actual payroll rates. Average rates based on different classes of labor will not be accepted.

(3) Necessary payroll taxes and insurance payments and other such reasonable charges that are paid by the Contractor pursuant to existing written agreements with its employees and/or labor organizations.

(4) Sales taxes, if any, required to be paid on materials not permanently incorporated into the work under the order-on-contract.

(5) Equipment, truck and plant rentals, other than small tools. The Contractor shall be reimbursed for the number of hours that the equipment truck or plant is actually used on a specified force account job. Equipment used by the Contractor shall be specifically described by the manufacturer, model number and date of manufacture and be of suitable size and suitable capacity required for the work to be performed. In the event the Contractor elects to use equipment of a higher rental rate than the equipment suitable for the work, payment will be made at the rate applicable to the suitable equipment. The equipment actually used and the suitable equipment upon which the rental rate is based will be recorded as a part of the record for force account work. The Engineer shall determine the suitability of the equipment. If there is a differential in the rate of pay of the operator of oversize or higher rate equipment, the rate paid for the operator will likewise be related to the suitable equipment.

(a) Contractor Owned Equipment, Trucks and Plant -- Contractor shall be reimbursed for its ownership costs and for its operating costs for self owned equipment at the rates listed in the Rental Rate Blue Book published by the Dataquest, Inc. applied in the following manner as modified by the 'Rate Adjustment Table'.

[1.0] Ownership Costs -- It is mutually understood that the rates for ownership costs reimburse the Contractor for all nonoperating costs of owning the equipment, truck or plant including depreciation on the original purchase, insurance, applicable taxes, interest on investment, storage, overhead, repairs, moving the equipment onto and away from the project or work site, and profit. Reimbursement will be made for the hours of actual use as described below:

[1.1] Less than 8 hours of actual use, the product of the actual number of hours used or fraction thereof multiplied by the hourly rate, or the daily rate, whichever is less.

[1.2] Between 8 hours and 40 hours of actual use, the product of the actual number of hours used divided by 8 multiplied by the daily rate, or the weekly rate, whichever is less.

ATTACHMENT "K"

[1.3] Between 40 and 176 hours of actual use, the product of the actual number of hours used divided by 40 multiplied by the weekly rate, or the monthly rate, whichever is less.

[1.4] Over 176 hours of actual use, the product of the actual number of hours used divided by 176 multiplied by the monthly rate.

[2.0] Operating Costs -- the rate for operating costs includes fuel, lubricants, other operating expendables, and preventative and field maintenance. Operating cost does not include the operator's wages. The Contractor shall be reimbursed the product of the number of hours of actual use multiplied by the Estimated Operating Cost/Hour.

[3.0] The rates used shall be those in effect at the time the force account work is done as reflected in the then current publication of the Rental Rate Blue Book. When force account type analysis are used to establish agreed prices in accordance with Section B.1 above, the rates used shall be those in effect when the agreed price is developed by the Contractor and submitted to the Engineer-in-Charge.

[4.0] The geographic Area Adjustment Factor shown on the map at the beginning of each section of the Rental Rate Blue Book shall not be applied to the equipment rates subsequently listed in each section, and shall not be used as a basis for payment.

[5.0] In the event that a rate is not established in the Rental Rate Blue Book for Construction Equipment for a particular piece of equipment, truck or plant, the Owner shall establish rates for ownership costs and operating costs for that piece of equipment, truck or plant that is consistent with its cost and expected life.

(b) Rented Equipment, Trucks and Plant --

[1.0] In the event that the Contractor does not own a specific type of equipment and must obtain it by rental, it shall be paid the actual rental rate for the equipment for the time that the equipment is used to accomplish the work or is required by the Engineer-in-Charge to be present, not to exceed the adjusted rental rate in the Rental Rate Blue Book, plus the reasonable cost of moving the equipment onto and away from the project site.

[2.0] The Contractor shall also be reimbursed for the operating cost of the equipment unless reflected in the rental price. Such operating cost shall be determined in the same manner as specified for Contractor Owned Equipment above.

[3.0] In the event that area practice dictates the rental of fully manned or fueled and maintained equipment, truck or plants, payment will be made on the basis of an invoice for the rental of the fully manned, fueled and/or maintained equipment, trucks or plants including all costs incidental to its use, including costs of moving to and from the site, provided the rate is substantiated by area practice.

(c) Maximum Amount Payable -- The maximum amount of reimbursement for the ownership costs of Contractor owned or the rental cost of rented equipment, trucks or plant is limited to the original purchase price of the equipment, truck or plant for any force account work as listed in the Green Guide for Construction Equipment published by the Dataquest, Inc. In the specific event when the ownership or rental reimbursement is limited by the original purchase price, the Contractor shall, nevertheless, be reimbursed for the Operating Cost/Hour for each hour of actual use.

ATTACHMENT "K"

(6) Profit and Overhead. Profit and overhead cost shall be computed at 20 percent of the following:

(a) Total Direct Labor Cost (actual hours worked multiplied by the basic hourly wage rate) plus supplemental benefits payments, payroll taxes, insurance payments and other labor related fringe benefits payments, payroll taxes, insurance payments and other related fringe benefit payments as defined in (2) and (3) above, but not including the overtime additive payments. Profit and overhead shall not be paid on the premium portion of overtime.

(b) Total Cost of Materials as defined in (1) above including the cost of transportation to the project site.

(7) Overhead shall be defined to include the following:

(a) Premium on bond;

(b) Premium on insurance required by the owner other than Workers Compensation Insurance, premium on public liability and property damage insurance, unemployment insurance, Federal old-age benefits, other payroll taxes and such reasonable charges that are paid by the Contractor pursuant to written agreement with its employee;

(c) All salary and expenses of executive officers, supervising officers or supervising employees;

(d) All clerical or stenographic employees;

(e) All charges for minor equipment such as small tools, including shovels, picks, axes, saws, bars, sledges, lanterns, jacks, cables, pails, wrenches, etc, and other miscellaneous supplies and services;

(f) All drafting room accessories such as paper, tracing cloth, reproduction costs, etc.

(2) Subcontractor Charges. When the work is performed by a subcontractor, the Contractor shall be paid the actual and reasonable cost of such subcontracted work as outlined above in items (1) through (5) under a. Contractor Charges, but profit and overhead shall be figured at (25%) unless some other basis is approved by the Owner.

(3) Service Charges. When work is performed by, or a fee is paid to, a service provider, the contractor shall be paid the actual cost of the service fee plus a maximum five percent (5%) for contract supervision, overhead and profit. This 5% shall be applied once to the service fee regardless of who makes direct payments to the service provider.

H. FORCE ACCOUNT REPORT. Payment for force account work will be made on the basis of the following reports.

1. The Contractor will deliver to the Engineer-in-Charge a daily summary of FORCE ACCOUNT WORK done on the contract. This summary on 8 2" x 11" paper will be delivered to the Engineer-in-Charge not later than closing time on the day following that for which the work is reported.

The summary shall contain:

a. A list of materials used indicating the amount and nature of each material. The cost (if known) should also be included. This must be documented later by proper receipts.

ATTACHMENT "K"

- b. A list of equipment used indicating the number of hours used and the kind, type, and size of equipment.
 - c. A list of personnel by name, including the hours worked, and labor classification at which they were used on the force account work and the location by station or station of the work proposed.
 - d. A statement of the work accomplished by force account for that day.
 - e. This summary will be dated and signed by the Contractor's authorized representative and the Engineer-in-Charge.
 - f. The contract number and other identification as well as the name of the Contractor shall appear on the statement.
 - g. The Engineer-in-Charge will make any notations, remarks or comments on this form that may assist in final payments.
2. Within 5 calendar days after the end of each pay period, the Contractor shall deliver to the Engineer-in-Charge a FORCE ACCOUNT SUMMARY OF LABOR used on the work which shall include the name, hourly rate of pay, hours worked, fringe benefits, and/or other items as shown on the actual payroll.
3. On completion of the specific force account work, the Contractor shall within 10 calendar days, deliver to the Engineer-in-Charge a Force Account Summation wherein all materials, equipment, and labor charges are shown and totaled together with such other expenditures as are concerned with the force account item. This summation shall be dated and signed by the Contractor's authorized representative and the Engineer-in-Charge.
4. In the event the contractor fails to deliver the required force account documentation to the EIC within the time period specified in subsection c, of these General specifications, and as a result the Order-on-Contract for the force account work is not fully approved at the date of final acceptance, the number of calendar days of the time period between final acceptance and the issuance of this force account Order-on-Contract, attributable to the Contractor's late force account submissions will extend the required payment data by an equal period of time.

D. TIME RELATED DISPUTE COMPENSATION.

1. As limited by Differing Site Conditions, Suspensions of Work, Significant Changes in the Character of the Work Provisions, the following elements of damage, and only the following elements, will be recoverable by the Contractor as <time related dispute damages= provided that they are actual and reasonable:
- a. Documented additional or escalated job site labor expenses;
 - b. Documented additional or escalated costs for materials;
 - c. Documented additional or escalated equipment costs less appropriate credits, as such are determined in accordance with this Section;
 - d. Documented costs of extended job-site overhead (field costs, including field supervision); job-site overhead would include job superintendent, office engineer and clerical staff, but would not include working foremen;

ATTACHMENT "K"

e. An additional 10 percent of the total of items a, b, c and d for home office overhead and 10% for profit thereon except for the differing site conditions or significant change in character of the work clauses (Differing Site Conditions, Suspensions of Work, Significant Changes in the Character of the Work Provisions, Part (A) (1) and (3)) apply, no anticipated profits shall be allowed and where the suspension of work clause (Part (A) (2)) applies, no profit or anticipated profits shall be allowed;

f. Documented additional or escalated insurance and bond costs;

g. When the work is performed by a subcontractor, the Contractor shall be paid the actual and reasonable cost of such subcontracted work as outlined above in paragraphs 1(a) through 1(d) and the Contractor's main office overhead and profit shall be figured at 15% and 10% respectively, except for where the differing site conditions or significant change in character of the work clauses ('10.06 (A) (1) and (3)) apply, no anticipated profits shall be allowed and where the suspension of work clause ('10.06 (A) (2)) applies, no profit or anticipated profits shall be allowed;

h. The phrase <additional expenses= shall include expenses above or below those normally incurred in the performance of the work, less any appropriate credit. The phrase <escalation expenses= shall include unanticipated higher or lower costs and expenses attributable, with appropriate credits, to the performance of work or portions of work in a different time period than that which was indicated on the Owner approved progress schedule.

2. Equipment, truck or plant rentals, other than small tools:

a. Equipment used by the Contractor shall be specifically described by the manufacturer, model number and date of manufacture and be of suitable size and capacity required for the work to be performed. In the event the Contractor elects to use equipment of a higher cost than the equipment suitable for the work, payment will be made at the actual cost rate applicable to the suitable equipment unless otherwise provided for in this section. The Engineer shall determine the suitability of equipment.

For purposes of computing Contractor's self-owned equipment, truck or plant costs, the rate used shall be based on the rate listed in the Rental Rate Blue Book published by Dataquest, Inc., with the appropriate adjustments noted in this specification, Part (B) (2).

b. In the event that a rate is not established in the Rental Rate Blue Book for Construction Equipment for a particular piece of equipment, truck or plant, the Owner shall establish a rate for ownership costs and operating costs for that piece of equipment, truck or plant that is consistent with its cost and expected life.

c. The Contractor shall be reimbursed for its operating costs for self-owned equipment based on actual cost data. Operating costs shall include fuel, lubricants, other operating expendables and preventive and field maintenance. Operating costs do not include the operator's wages. In the event, after documented and demonstrated due diligence, actual operating costs are not ascertainable, then the Contractor will be compensated utilizing not more than 50% of the operating costs set forth in the <Rental Rate Blue Book= and the Contractor shall be reimbursed the product of the number of hours of actual use multiplied by the operating cost per hour.

d. The rate for idle equipment and stand-by equipment, shall be based upon the rate of depreciation specified in the Contractor's books and records, or 50% of the rate set forth in the <Rental Rate Blue Book,= published by Dataquest, Inc. with the appropriate adjustments noted

ATTACHMENT "K"

in this specification, whichever is greater. In the event the equipment is fully depreciated, the Sponsor will pay the actual ownership costs based upon Sponsor audit of the Contractor's books and records.

e. The maximum amount of reimbursement for the ownership costs of Contractor owned or the rental cost of rented equipment, trucks or plant is limited to the original purchase price of the equipment, truck or plant as listed in the Green Guide for Construction Equipment published by the Dataquest, Inc. In the specific event when the ownership or rental reimbursement is limited by the original purchase price, the Contractor shall, nevertheless, be reimbursed for the operating cost per hour for each hour of actual use.

f. For purposes of rented equipment, the provisions of this specification, Part (B), New Item Charges, are controlling.

3. The parties agree that, in any dispute for time related damages, the Sponsor will have no liability for the following items and the Contractor further agrees it shall make no claim for the following items:

- a. Profit, in excess of that provided in this specification, Part (D) (1)(e) and (g);
- b. Loss of anticipated or unanticipated profit;
- c. Labor inefficiencies and loss of productivity;

d. Home office overhead in excess of that provided in this specification, Part (D) (1)(e) and (g);

e. Consequential damages, including but not limited to interest on monies in dispute, including interest which is paid on such monies, loss of bonding capacity, bidding opportunities, or interest on retainage or investment, or any resultant insolvency;

f. Indirect costs or expenses of any nature;

g. Direct or indirect costs attributable to performance of work where the Contractor, because of situations or conditions within its control, has not progressed in a manner satisfactory to the Engineer.

h. Attorneys fees, or claims preparation expenses.

4. **REMEDIES EXCLUSIVE:** With respect to time related dispute compensation provisions, the parties agree that the Sponsor shall have no liability to the Contractor for expenses, costs, or items of damage other than those which are specifically identified as payable under this specification, Part D. In the event any legal action is instituted against the Sponsor by the Contractor on account of any such dispute for additional compensation, whether on account of time related dispute, delay, acceleration, breach of contract, or otherwise, the Contractor agrees that the Sponsor's liability will be limited to those items which are specifically identified as compensable under this specification, Part D. The Contractor further agrees to make no claim for expenses other than those which are specifically identified as compensable under this specification, Part (D). Nothing in this Section is intended to create any liability of the Sponsor not existing at common law or pursuant to the terms of this contract or to prevent the Contractor from filing a claim in a court of law.

E. REQUIRED CONTENT OF DISPUTE SUBMISSION. All disputes must be submitted in writing to the Engineer, and must be in sufficient detail to enable the Engineer to ascertain the basis and the amount of each dispute. If requested and as a minimum, the following information must be provided when such information is ascertainable by the Contractor:

1. TIME RELATED DISPUTE SUBMISSIONS.

- a. A description of the operations that were delayed, the reasons for the delay, how they were delayed, including the report of all scheduling experts or other consultants, if any.
- b. An as-built chart, <Critical Path Method= scheme or other diagram or chart depicting in graphic form how the operations were or are presumed to be adversely affected.
- c. The date on which actions resulting in the dispute occurred or conditions resulting in the dispute became evident.
- d. A copy of the notice of dispute required as per Dispute Resolution and Disputed Work Provisions, Part (A)(3) for the specific dispute by the Contractor.
- e. To the extent known, the name, function, and activity of each Sponsor official, or employee or agent, involved in, or knowledgeable about facts that gave rise to such dispute.
- f. The name, function, and activity of each Contractor or subcontractor official, or employee, involved in, or knowledgeable about facts that gave rise to such dispute.
- g. The identification of any pertinent documents, and the substance of any material oral communication relating to such dispute.
- h. A statement as to whether the additional compensation or extension of time if requested is based on the provisions of the contract or is an alleged breach of contract.
- i. The amount of additional compensation sought and a breakdown of that amount into the categories specified as payable under this specification, Part (D) above.
- j. If an extension of time is also requested, the specific days for which it is sought and the basis for such request as determined by an analysis of the construction progress schedule.

2. FOR OTHER DISPUTES INCLUDING ACCELERATION DISPUTES.

- a. A detailed factual statement of the dispute providing all necessary dates, locations and items of work affected by the dispute.
- b. The date on which actions resulting in the dispute occurred or conditions resulting in the dispute became evident.
- c. A copy of the <notice of dispute= required for the specific dispute by the contract pursuant to Dispute Resolution and Disputed Work Provisions, Parts (B) or (C).
- d. The name, function, and activity of each Sponsor official or employee or agent involved in, or knowledgeable about facts that gave rise to such dispute.
- e. The name, function and activity of each Contractor or subcontractor official, employee or agent involved in or knowledgeable about facts that gave rise to such dispute.
- f. The specific provisions of the contract which support the dispute and a statement of the reasons why such provisions support the dispute.

ATTACHMENT "K"

g. The identification of any pertinent documents and the substance of any material oral communications relating to such dispute.

h. A statement as to whether the additional compensation or extension of time requested is based on the provisions of the contract or an alleged breach of contract.

i. If an extension of time is also requested, the specific days for which it is sought and the basis for such request as determined by an analysis of the construction schedule.

j. The amount of additional compensation sought and a breakdown of that amount shall conform to the requirements of this specification, Part (B) except for acceleration disputes which shall conform to the requirements and categories specified in Part (D) above.

F. REQUIRED CERTIFICATION OF DISPUTES. When submitting any dispute over \$50,000, the Contractor must certify in writing, under oath and in accordance with the formalities required by the contract, as to the following:

1. That supportive data is accurate and complete to the Contractor's best knowledge and belief;
2. That the amount of the dispute and the dispute itself accurately reflects what the Contractor in good faith believes to be the Sponsor's liability;
3. If the Contractor is an individual, the certification shall be executed by that individual. If the Contractor is not an individual, the certification shall be executed by:
 - (1) Senior company official in charge at the Contractor's plant or location involved;

or

- (2) An officer or general partner of the Contractor having overall responsibility for the conduct of the Contractor's affairs.

CONTRACTOR'S COST RECORDS. The Contractor shall maintain records of all required payrolls, and of the details that comprise its total cost pursuant to any and all records maintained pursuant to Dispute Resolution and Disputed Work Provisions and Extra Force Account Work, Dispute Compensation and Recordkeeping, and it shall, at any time within six years following the date of final payment of the project, make such records available, upon request therefor, to the Sponsor for review and audit, if deemed necessary by the Sponsor. In case all or a part of such records are not made so available, the Contractor understands and agrees that any items not supported by reason of such unavailability of the records shall be disallowed, or if payment therefor has already been made, the Contractor shall, upon demand in writing by the Sponsor, refund to the Sponsor the amount so disallowed.

DIFFERING SITE CONDITIONS, SUSPENSIONS OF WORK, SIGNIFICANT CHANGES IN THE CHARACTER OF THE WORK PROVISIONS.

The following provisions shall apply to this contract:

(1) Differing site conditions.

(i) During the progress of the work, if subsurface or latent physical conditions are encountered at the site differing materially from those indicated in the contract or if unknown physical conditions of an unusual nature, differing materially from those ordinarily encountered and generally recognized as inherent in the work provided for in the contract, are encountered at the site, the party discovering such conditions shall promptly notify the other party in writing of the specific differing conditions before the site is disturbed and before the affected work is performed.

(ii) Upon written notification, the Engineer will investigate the conditions and if it is determined that the conditions materially differ and cause an increase or decrease in the cost or time required for the performance of any work under the contract, an adjustment, excluding anticipated profits, will be made and the contract modified in writing accordingly. The Engineer will notify the Contractor of the determination whether or not an adjustment of the contract is warranted.

(iii) No contract adjustment which results in a benefit to the Contractor will be allowed unless the Contractor has provided the required written notice.

(v) The aforesaid differing site condition clause (Part (A) (1)) shall be governed by the notice provisions set forth above, and the recordkeeping and other requirements of Dispute Resolution and Disputed Work Provisions, and additional compensation via order on contract(s), if any, shall be made pursuant to Extra Force Account Work, Dispute Compensation and Recordkeeping, Part (B), New Item Charges, 1 (Agreed Price) or 2 (Force Account Charges) and E. Required Content of Dispute Submission (2) and F, Required Certification of Dispute. However, the equipment compensation provisions shall be governed and controlled by the provisions of Part (D) (2).

(2) Suspensions of work ordered by the Engineer.

(i) If the performance of all or any portion of the work is suspended or delayed by the Engineer in writing for an unreasonable period of time (not originally anticipated, customary, or inherent to the construction industry) and the Contractor believes that additional compensation and/or contract time is due as a result of such suspension or delay, the Contractor shall submit to the Engineer in writing a request for adjustment within 7 calendar days of receipt of the notice to resume work. The request shall set forth the reasons and support for such adjustment. The record keeping requirements of Section 10.02 must be complied with in connection with any requests for reimbursement.

(ii) Upon receipt, the Engineer will evaluate the Contractor's request. If the Engineer agrees that the cost and/or time required for the performance of the contract has increased as a result of such suspension and the suspension was caused by conditions beyond the control of and not the fault of the Contractor, its suppliers, or subcontractors at any approved tier, and not caused by weather, the Engineer will make an adjustment (excluding profit) and modify the contract in writing accordingly. The Contractor will be notified of the Engineer's determination whether or not an adjustment of the contract is warranted.

ATTACHMENT "K"

(iii) No contract adjustment will be allowed unless the Contractor has submitted the request for adjustment within the time prescribed.

(iv) No contract adjustment will be allowed under this clause to the extent that performance would have been suspended or delayed by any other cause, or for which an adjustment is provided for or excluded under any other term or condition of this contract.

(v) The aforesaid suspension of work clause (Part (A)(2)) shall be governed by the notice provisions set forth above, and the recordkeeping and other requirements of Dispute Resolution and Disputed Work Provisions, and additional compensation via order on contract(s), if any, shall be made pursuant to Extra Force Account Work, Dispute Compensation and Recordkeeping, Part (D), Time Related Dispute Compensation, E., Required Content of Dispute Submission and F, Required Certification of Dispute.

(3) Significant changes in the character of work.

(i) The Engineer reserves the right to make, in writing, at any time during the work, such changes in quantities and such alterations in the work as are necessary to satisfactorily complete the project. Such changes in quantities and alterations shall not invalidate the contract nor release the surety, and the Contractor agrees to perform the work as altered.

(ii) If the alterations or changes in quantities significantly change the character of the work under the contract, whether such alterations or changes are in themselves significant changes to the character of the work, or by affecting other work, cause such other work to become significantly different in character, an adjustment excluding anticipated profit, will be made to the contract. The basis for the adjustment shall be agreed upon prior to the performance of the work. If a basis cannot be agreed upon, then an adjustment will be made either for or against the Contractor in such amount as the Engineer may determine to be fair and equitable.

(iii) If the alterations or changes in quantities do not significantly change the character of the work to be performed under the contract, the altered work will be paid for as provided elsewhere in the contract.

(iv) The term <significant change= shall be construed to apply only to the following circumstances:

(A) When the character of the work as altered differs materially in kind or nature from that involved or included in the original proposed construction; or

(B) When a major item of work, as defined elsewhere in the contract, is increased in excess of 125 percent or decreased below 75 percent of the original contract quantity. Any allowance for an increase in quantity shall apply only to that portion in excess of 125 percent of original contract item quantity, or in case of a decrease below 75 percent, to the actual amount of work performed.

(C) The term "major item" of work shall mean any item for which the original bid price multiplied by the original contract quantity exceeds \$50,000 or 2% of the total contract bid price, whichever is less.

(D) Certain items of work may be <fixed quantity= items. That is, payment will be restricted to the quantity stated in the Estimate of Quantities. If, during the progress of the work the stated quantity is determined to be in error, the terms of Dispute Resolution and Disputed Work Provisions, Part (3)(iv) (B) shall apply with the following alterations:

ATTACHMENT "K"

1. The major item of work requirement shall not apply.

2. Significant change shall be defined as an actual quantity in excess of 125 percent of the stated quantity, or less than 75 percent of the stated quantity.

(v) The aforesaid significant change in character of work clause (Part (A)(3)) shall be governed by the notice, recordkeeping and other requirements of Dispute Resolution and Disputed Work Provisions, and additional compensation via order on contract(s) shall be made for time related costs, if any, pursuant to Extra Force Account Work, Dispute Compensation and Recordkeeping, Parts (D) and (E) and (F) and for increased costs, if any, pursuant to Part (B), New Item Charges, 1 (Agreed Price) or 2 (Force Account Charges) and E (2), Required Content of Dispute Submission and F, Required Certification of Dispute, but, the equipment compensation shall be governed and controlled by the provisions of Part (D) (2).

(vi) In respect to the aforesaid significant changes in the character of work clause (this specification, Part (A) (3)), the contractor or the sponsor, as the case may be, must make written notification to the other party of the existence of the 'significant change'. This notice shall be given in a timely manner with respect to the date that either party had, or should have had, knowledge of an event, matter, occurrence of work order which results in a significant change in the work. If the affected work is in progress, notice shall be given within 3 days of knowledge of the change. If the affected work is not in progress, notice shall be given within 10 days of knowledge of the change. The timely issuance of a notice of 'significant change' shall be a necessary requirement for consideration of contract alterations as provided in this section.

B. If the Sponsor determines that as a result of the aforesaid differing site condition, suspension of work clauses and significant change in the character of work clauses, that an adjustment in the contract price is warranted, the Sponsor shall first attempt to arrive at an agreed price with the contract. If unsuccessful, the Sponsor may make such adjustments to the contract as is determined to be fair and equitable utilizing Owner estimates. Commencing with the issuance of notice, and through the date of agreement between the Sponsor and the contractor, all work subject to these provisions shall be treated as Disputed Work, with daily recordkeeping in accordance with the provisions of Dispute Resolution and Disputed Work Provisions.

C. If any of the notice or other provisions of this specification, Part (A) are in conflict with any other of the provisions of the Standard Specifications, then the provisions of this specification, Part (A) shall prevail and take precedence and be of force over and against any said conflicting provision of said contract.

D. Solely for purposes of the aforesaid specification, Parts (A)(1),(2) and (3), and solely for purposes of disputes as to records pursuant to Dispute Resolution and Disputed Work Provisions, Part (A)(4), the Engineer shall be the Engineer-in-Charge.

CONTRACTOR INITIATED VALUE ENGINEERING CHANGE PROPOSAL
(CIVEC)

A. Purpose and Scope

The term "proposal" as used in this Subsection is construed to mean a Contractor Initiated Value Engineering Change (CIVEC) Proposal submitted by the Contractor for changing the Plans, Specifications, or other requirements of the Contract. The Value Engineering Change Proposal shall conform with the following:

It is the intent of this provision to share with the Contractor any cost savings which may be generated on this Contract as the result of CIVEC proposals offered by the Contractor and approved by the Department. The purpose is to encourage the use of the Contractor's ingenuity and experience in arriving at a lower cost alternative with any time-saving construction methods other than those reflected in the Contract Documents, by the sharing of savings resulting therefrom. The proposals contemplated are those that could produce a savings to the Department, without, in the sole judgment of the Deputy Chief Engineer, impairing the essential functions and characteristics of the Project or a portion of the Work involved. They include, but are not limited to: safety, service, life, stage construction, economy of operation, ease of maintenance and desired appearance.

B. Submittal of CIVEC Proposal

The Contractor may submit a CIVEC only after Award of the Contract. The CIVEC may be accepted within 30 (thirty) days after Award of Contract and should be approved by the New York State Department of Transportation.

B-1. Submittal of Initial CIVEC Proposal

An initial proposal is required for all CIVEC proposals and shall outline the general technical concepts associated with the proposal and the estimated savings which will result. The initial proposal will be reviewed by the Department and, if found to be conceptually acceptable, approval to submit a Final Proposal will be granted by the Department. A finding of "conceptual acceptability" of the initial proposal however, in no way obligates the Department to approve the final proposal. Further, the Contractor shall have no claim against the City as a result of the rejection of any such initial or final proposal.

B-2. Submittal of Final CIVEC Proposal

At a minimum, the following materials and information shall be submitted with each CIVEC proposal, plus any additional information requested by the Department.

- a) A statement that the CIVEC is submitted as the "Final Value Engineering Change Proposal," as per Department approval of the Initial CIVEC Proposal.
- b) A description of the difference between the existing contract requirements and the proposed change, and the comparative advantages of each, including considerations of service life, economy of operation, ease of maintenance, desired appearance and safety.
- c) Complete plans and specifications showing the proposed revisions relative to the original contract features and requirements.
- d) A complete cost analysis indicating the Final Estimate costs and quantities to be replaced by the CIVEC proposal, the new costs and quantities generated by the CIVEC proposal, and the cost effects of the proposed changes on operational, maintenance and other considerations.
- e) Pursuant to Article 25 of the Agreement, Value Engineering Change Proposals are considered Change Orders, therefore, a statement of the time, by which adopting of the proposal must be executed so as to obtain the maximum benefit during the remainder of the Contract, is required. The date must be selected to allow the Department ample time for review and processing of the Change Order, but without affecting the Contractor's schedule. Should the Department find that insufficient time is available for review and processing, it may reject the CIVEC proposal solely on such basis. If the Department fails to respond by the date specified, the Contractor shall consider the CIVEC proposal rejected unless otherwise notified in writing by the Department; and shall in any event have no claims against the City as a result thereof.
- f) A statement as to the effect the CIVEC proposal will have on the time for completion of the contract.
- g) A description of any previous use or testing of the CIVEC proposal on another Department project, indicate the date, contract number and the action taken by the Department.

C. Conditions

CIVEC proposals will not be considered in determining the lowest responsible bidder. CIVEC proposals will only be considered after award, and only when all of the following conditions are met:

1. The Contractor is cautioned not to base any bid prices on the anticipated approval of the CIVEC proposal and to recognize that such proposal may be rejected and that the Contractor will thus, be required to complete the Contract in accordance with the plans and specifications bid.
2. All CIVEC proposals, whether or not approved by the Department for use in this contract, apply only to the on-going Contract or Contracts referenced in the CIVEC proposal and become the property of the Department without restriction as may otherwise be imposed by the Contractor, on their use and disclosure. The Department shall have the right to use, duplicate and disclose in whole or in part any data necessary for the utilization of the proposal. The Department retains the right to utilize any accepted CIVEC proposal or part thereof, on any subsequent project without any obligation to the Contractor submitting the same.
3. If the Department already has under consideration certain revisions to the Contract or has approved certain changes in specifications or standards for general use which are then subsequently incorporated in a CIVEC proposal submitted by the Contractor, the Department shall reject the Contractor's proposal and proceed with such revisions if it so desires without any obligation to the Contractor.
4. The Contractor shall have no claim against the City for any costs or delays incidental to the Department's rejection or approval of a CIVEC proposal, including but not limited to development costs, anticipated profits, or increased material and labor costs resulting from delays in the review of such CIVEC proposal.
5. The Department shall be the sole judge as to whether a CIVEC proposal qualifies for consideration and evaluation. It may reject, at will, any CIVEC proposal that requires excessive time or costs for review, evaluation and/or investigations, or which is not consistent with the Department's design policies and basic design criteria for the project; as well as, for any other reason the Department deems appropriate, without explanation.

ATTACHMENT "L"

6. The Engineer may reject all or any portion of the work performed pursuant to an approved CIVEC proposal if it is believed that unsatisfactory results are being obtained. The Engineer may direct the removal of such rejected work and require the Contractor to proceed in accordance with the original Contract requirements without reimbursement for any work performed under the CIVEC proposal, or for its removal. Where modifications to the CIVEC are approved in order to adjust to field or other conditions, reimbursement will be limited to the total amount payable for the work at the Contract bid prices as if it were constructed in accordance with the original Contract requirements. Such rejection or limitation of reimbursement shall not constitute the basis of any claim against the City for delay or for any other costs.
7. The CIVEC proposal shall not be experimental in nature but shall have been proven to the Department's satisfaction under similar or acceptable conditions on another Department project or at another location acceptable to the Department.
8. CIVEC Proposals shall be considered only if equivalent options are not already provided in the Contract documents.
9. The savings generated by the CIVEC proposal must be of sufficient significance, in the sole judgment of the Department, to warrant review and processing.
10. A CIVEC proposal changing the types and or thickness of the pavement structure will not be considered.
11. If additional information is deemed necessary by the Engineer to evaluate the CIVEC proposal, this information must be provided in a timely manner to allow sufficient time for review. Failure to do so will result in rejection of the CIVEC proposal. Such additional information should include but not be limited to design changes, field investigation and survey results, design computations, and field change sheets.
12. No changes to the work shall be considered as CIVEC eligible, if they are the result of design errors or omissions which would have needed correction notwithstanding any CIVEC provision in the specification; even if the need for such correction is first brought to the Engineer's attention by the Contractor.

D. Payment

If the CIVEC proposal is accepted by the Department, the changes and payments will be made in accordance with the applicable sections of the Procurement Policy Board (PPB) Rules and this contract. Reimbursement to the Contractor shall be made as follows:

1. The changes will be incorporated into the original Contract proposal as submitted by the Contractor via changes in the quantity of unit bid items, changes in the amounts of lump sum items and new agreed priced items, as appropriate.
2. The cost of the revised work as determined from the aforementioned changes in quantities, or new items will be paid directly. In addition to such payment, the Department will pay to the Contractor, via a separate item, 50 percent of the savings to the Department as reflected by the difference between the above payment and the cost of the related construction required by the original Contract plans and specifications computed at Contract bid prices.
3. The Contractor's costs for development, design and implementation of the CIVEC proposal are not eligible for reimbursement.
4. **The Contractor may submit CIVEC proposals on behalf of an approved subcontract, provided that reimbursement is made by the Department to the Contractor and that the terms of the pass through to the subcontractor are satisfactorily negotiated and accepted by the Contractor and Subcontractor before the CIVEC proposal is submitted to the Department. Subcontractors may not otherwise submit a CIVEC proposal, except through the prime Contractor.**

NO TEXT

ITEMIZED PROPOSAL**To the State Department of Transportation:**

In submitting this bid the undersigned declares to be the only person or persons interested in the said bid; that it is made without any connection with any person making another bid for the same contract; that the bid is in all respects fair and without collusion, fraud or mental reservation; and that no official of the State, or any person in the employ of the State is directly or indirectly interested in said bid or in the supplies or work to which it relates, or in any portion of the profits thereof.

The undersigned also hereby declares to have carefully examined the plans, specifications and form of contract, and to have personally inspected the actual location of the work together with the local sources of supply, to be satisfied as to all the quantities and conditions, and understands that in signing this proposal waives all right to plead any misunderstanding regarding the same.

The undersigned further understands and agrees to furnish and provide for the respective item price bid all the necessary material, machinery, implements, tools, labor services and other items of whatever nature, and to do and perform all the work necessary under the aforesaid conditions, to complete the improvement of the aforementioned project in accordance with the plans and specifications for said improvement, which plans and specifications it is agreed are a part of this proposal, and to accept in full compensation therefore the amount of the summation of the products of the approximate quantities multiplied by the unit prices bid. This summation will hereinafter be referred to as the gross sum bid.

The undersigned further agrees to accept the aforesaid unit bid prices as compensations for any additions or deductions caused by variation in quantities due to more accurate measurement, and for use in the computation of the value of the work performed for monthly estimates.

The undersigned further agrees that at any time during the progress of work the State adds, alters or omits portions of the work it shall so perform such work and accept compensation in accordance with the Standard Specifications.

The undersigned further understands and agrees not to start any work until the contract agreement is signed by the Commissioner or the Commissioner's duly authorized representative. In case the undersigned voluntarily undertakes to start work, other than that expressly prohibited in this Subsection, after the contract agreement is signed by the Commissioner but prior to approval by the State Comptroller, the undersigned does so entirely at its own risk and without obligation or responsibility on the part of the State unless and until the awarded contract becomes effective pursuant to Section 112 of the State Finance Law by approval of the State Comptroller and filing in the Office of the State Comptroller; and hereby agrees and warrants that, as a prerequisite to the start of any such voluntary work, accepts, assumes and undertakes all of the provisions of this proposal and of the plans and specifications of the proposed contract, including all of the provisions and responsibilities thereof relative to (1) damage, indemnification and holding the State harmless as set forth in said contract documents, and (2) actually furnishing in advance of any contract operations, the required insurance policies of each and every kind and amount as called for in said contract documents, particularly with relation to workers compensation and liability insurance policies as set forth in the related specifications; and also agrees and warrants that all of such policies will be in force and effect on the date of the start of any such contract operations, whether or not the contract documents have been executed and filed as aforesaid. In no event shall the undersigned start any contract work which involves a disturbance of the contract site prior to execution of the contract by the Comptroller.

UNITED STATES DEPARTMENT OF TRANSPORTATION HOTLINE

Persons with knowledge of bid collusion (i.e. contractors, suppliers, workpersons, etc.), or other questionable contract related practices (inadequate materials, poor workmanship, theft of materials, etc.), are encouraged to report such activities by calling the **U.S. D.O.T. HOTLINE**. The **HOTLINE** number is 1-800-424-9071 and calls will be answered from 8:00 A.M. to 5:00 P.M. EST, Monday through Friday.

This **HOTLINE** is under the direction of the U.S.D.O.T.'s Inspector General. All information will be treated confidentially and the caller's anonymity will be respected.

NEW YORK STATE INSPECTOR GENERAL HOTLINE

Reports of New York State Governmental Misconduct may be made in strict confidence to the New York State Inspector General on the Toll Free Statewide **HOTLINE** or by writing to the Office of the Inspector General. The Toll Free Statewide **HOTLINE** telephone number is 1-800-367-4448 and calls will be answered between 8:00 A.M. and 4:30 P.M., Monday through Friday. The address of the Office of the State Inspector General is the State Capital, Executive Chamber, Albany, New York 12224.

ATTACHMENT "P"

PROMPT PAYMENTS BY THE CONTRACTOR. In accordance with Section 139-f(2) of the State Finance Law, the Contractor shall pay each Subcontractor and materialman for the value of work performed pursuant to contract no later than seven (7) calendar days from the receipt of each payment the Contractor receives from NYC Department of Design and Construction (NYCDDC). Payment by the Contractor to Subcontractors or materialmen shall reflect the quantities or percentage of work completed by the Subcontractor or materials furnished by the materialmen, and paid by NYCDDC; and such payment shall be based upon the actual conditions of the subcontract or purchase order. The Contractor shall not hold any retainage, but may deduct an amount necessary to satisfy any claims, liens or judgments against a Subcontractor or materialman which have not been fully discharged.

The Contractor shall maintain an accounting system acceptable to the NYCDDC to track payments made by the City to the Contractor and payments made by the Contractor to each Subcontractor, Manufacturer, Fabricator or Material Supplier by item and by date.

CIVIL RIGHTS MONITORING AND REPORTING.

SEE SECTION 105-21 OF THE
NEW YORK STATE
DEPARTMENT OF TRANSPORTATION STANDARD SPECIFICATIONS

The Contractor shall use the current version of NYS Department of Transportation approved Construction Civil Rights Reporting Software (EBO) which is available at the following website:

<https://ebo.dot.ny.gov>

The software is free. Prime contractors, vendors (subcontractors, suppliers, etc.), and agency compliance staff will have access to the software. The prime contractor shall be required to print reports from EBO for submission to the Resident Engineer each month, not later than the 15th of the following month. Data shall be current through the end of the last full payroll week for that month, or as otherwise approved by the Engineer to coordinate with contract payment submittals.

**APPENDIX 2
IRAN DIVESTMENT ACT**

As a result of the Iran Divestment Act of 2012 (Act), Chapter 1 of the 2012 Laws of New York, a new provision has been added to the State Finance Law (SFL), § 165-a, effective April 12, 2012. Under the Act, the Commissioner of the Office of General Services (OGS) will be developing a list (prohibited entities list) of "persons" who are engaged in "investment activities in Iran" (both are defined terms in the law). Pursuant to SFL § 165-a(3)(b), the initial list is expected to be issued no later than 120 days after the Act's effective date, at which time it will be posted on the OGS website.

By entering into this Contract, Contractor (or any assignee) certifies that once the prohibited entities list is posted on the OGS website, it will not utilize on such Contract any subcontractor that is identified on the prohibited entities list. Additionally, Contractor agrees that after the list is posted on the OGS website, should it seek to renew or extend the Contract, it will be required to certify at the time the Contract is renewed or extended that it is not included on the prohibited entities list. Contractor also agrees that any proposed Assignee of the Contract will be required to certify that it is not on the prohibited entities list before the New York State Department of Transportation (NYSDOT) may approve a request for Assignment of Contract

During the term of the Contract, should NYSDOT receive information that a person is in violation of the above-referenced certification, NYSDOT will offer the person an opportunity to respond. If the person fails to demonstrate that it has ceased its engagement in the investment which is in violation of the Act within 90 days after the determination of such violation, then NYSDOT shall take such action as may be appropriate including, but not limited to, imposing sanctions, seeking compliance, recovering damages, or declaring the Contractor in default.

NYSDOT reserves the right to reject any request for assignment for an entity that appears on the prohibited entities list prior to the award of a contract, and to pursue a responsibility review with respect to any entity that is awarded a contract and appears on the prohibited entities list after contract award.

ATTACH TO CONTRACT DOCUMENTS

**THE CITY OF NEW YORK
DEPARTMENT OF DESIGN AND CONSTRUCTION
INFRASTRUCTURE DIVISION
BUREAU OF DESIGN**

PROJECT ID: HWPEDSF1

**MULTI-SITE PEDESTRIAN SAFETY
WHICH INCLUDES THE FOLLOWING INTERSECTIONS:**

**31ST STREET AND 39TH AVENUE
31ST STREET AND 36TH AVENUE
31ST STREET AND BROADWAY**

**INCLUDING BUS BULBOUTS, CURB EXTENSIONS, BUS PADS,
PEDESTRIAN RAMPS, CATCH BASINS, PAVEMENT MARKINGS,
STREET LIGHTING, AND TRAFFIC SIGNAL WORK**

**Together With All Work Incidental Thereto
BOROUGH OF QUEENS**

ADDENDUM NO. 3

DATED: October 14, 2014

This Addendum is issued for the purpose of amending the requirements of the contract documents and is hereby made part of said contract documents to the same extent as if it was originally included therein.

The Standard Sewer And Water Main Specifications of the Department of Environmental Protection (dated July 1, 2014), Sewer Design Standards of the Department of Environmental Protection (dated (September 2007) Revised January 2009), Water Main Standard Drawings of the Department of Environmental Protection (latest revisions), Specifications For Trunk Main Work of the Department of Environmental Protection (dated July 2014) and the Standard Highway Specifications (Volumes I and II) of the Department of Transportation (dated November 1, 2010) of The City of New York, shall be included as part of the contract documents. These said specifications and standard drawings are hereby revised under the following section headings:

- A. NOTICE TO BIDDERS**
- B. AMENDMENTS TO THE STANDARD HIGHWAY SPECIFICATIONS**
- C. AMENDMENTS TO THE STANDARD SEWER AND WATER MAIN SPECIFICATIONS**
- D. AMENDMENTS TO THE SPECIFICATIONS FOR TRUNK MAIN WORK**

A. NOTICE TO BIDDERS

- (1) (A) The Contractor is advised that copies of the Standard Sewer And Water Main Specifications (dated July 1, 2014), Sewer Design Standards (dated (September 2007) Revised January 2009), Specifications For Trunk Main Work (dated July 2014) and Water Main Standard Drawings (latest revisions) are available to all prospective bidders at no cost upon presentation of receipt of purchase of Bid Package at the following location:

Department of Design and Construction
Division of Infrastructure
Design Services, Specifications, 3rd Floor
30-30 Thomson Avenue
Long Island City, NY 11101

- (B) The Contractor is advised that copies of the Standard Highway Specifications (Volume I and II) (dated November 1, 2010), Standard Highway Details of Construction (latest revisions), Division of Street Lighting Specifications (latest revisions), Division of Street Lighting Standard Drawings (latest revisions), Standard Specifications for Traffic Signals (latest revisions), and Standard Drawings for Traffic Signals (latest revisions) are available to all prospective bidders for a fee at the following location:

Department of Transportation
55 Water Street, Ground Floor
New York City, NY 10041

- (2) The Contractor is notified that a Notice To Proceed (NTP) date will be issued for work to commence within twenty-one (21) to thirty (30) days of Contract Registration.
- (3) The Contractor shall furnish, install, maintain and subsequently remove temporary Protective Tree Barriers. Protective Tree Barriers shall be Type B, unless otherwise directed by the Engineer, and shall be constructed and installed as shown on the Protective Tree Barrier sketch in Department Of Transportation, Standard Highway Details Of Construction, Drawing No. H-1046A, as directed by the Engineer, and in accordance with Department of Parks and Recreation requirements.
- (4) All utility locations and invert elevations are not guaranteed, nor is there any guarantee that all existing utilities, whether functional or abandoned within the project area are shown.
- (5) All existing house connections shall be maintained and supported during construction. The Contractor shall replace any existing house connection damaged as a result of the Contractor's construction operations as ordered by the Engineer at no cost to the City.
- (6) The Contractor is advised that any City owned light poles, traffic signals, street name signs, traffic signs and encumbrances including, but not limited to, underground conduit displaced as the result of the installation of the new sewers, water mains, catch basins, catch basin connections and appurtenances shall be replaced in kind and as directed by the Engineer. The cost of such work shall be deemed included in the prices bid for all items of work under this contract.
- (7) The Contractor is notified that Victaulic Style 77 Coupling is no longer acceptable for use in any steel water main work. All reference to Victaulic Style 77 Coupling within the Standard Sewer And Water Main Specifications of the Department of Environmental Protection (dated July 1, 2014), the Water Main Standard Drawings of the Department of Environmental Protection (latest revisions), the Specifications For Trunk Main Work (dated July 2014), and the contract drawings, shall be replaced with Bolted Split-Sleeve Restrained Coupling.
- (8) The Contractor is notified that wherever the Item No. "6.52" and words "flagger", "flagperson" and "flagman" are used in the contract documents and drawings it shall mean the Item No. "6.52 CG" and the words "Crossing Guard", respectively.

- (9) The Contractor is notified that the fuel cost per gallon used in the formula under **Sub-Article 26.2.8** of the Standard Construction Contract for **Extra Work** will be derived from the fuel price index for the United States East Coast published weekly by the United States Energy Information Administration ("USEIA"), and available on its website at <http://www.eia.gov/petroleum/gasdiesel/> . The USEIA published cost per gallon for the applicable fuel on the East Coast for the week in which the first day of each calendar quarter during the contract term occurs (i.e., January 1st, April 1st, July 1st and September 1st) will be used in the reimbursement formula for all **Extra Work** invoiced that was performed during that calendar quarter. Should the USEIA stop publishing this fuel price index, the fuel cost per gallon will be determined by reference to a substitute index to be agreed upon by the Contractor and the City.
- (10) The Contractor is responsible for any damage to the existing street and traffic signal equipment, including underground conduits and the safety of both pedestrian and vehicular traffic for the duration of the contract.

Should any conduits, cables or foundations need repair due to the Contractor's negligent operations during construction, all work shall be performed according to NYCDOT Bureau of Traffic's Standard Drawings and Specifications at the sole expense of the Contractor.

It is the Contractor's responsibility to secure an approved electrical contractor to perform all traffic signal work (if any). For list of approved electrical contractors, contact Mr. Michael R. LeFosse of New York City Department of Transportation at (718) 786-2236.

B. AMENDMENTS TO THE STANDARD HIGHWAY SPECIFICATIONS

(NO TEXT)

C. AMENDMENTS TO THE STANDARD SEWER AND WATER MAIN SPECIFICATIONS

- (1) **Refer** to **Subsection 10.15 - Notice To Utility Companies, Etc., To Remove Structures Occupying Place Of Sewers, Water Mains Or Appurtenances**, Page I-11:

Add the following to **Subsection 10.15**:

- (1) CONSOLIDATED EDISON COMPANY OF NEW YORK (CON EDISON)

There are CON EDISON facilities in the area of construction. The Contractor shall notify CON EDISON at least seventy-two (72) hours prior to the start of construction by contacting Ms. Theresa Kong at (212) 460-4834 or Mr. Noel Leon at (718) 275-2852.

- (2) VERIZON

There are VERIZON facilities in the area of construction. The Contractor shall notify VERIZON at least seventy-two (72) hours prior to the start of construction by contacting Mr. Michael Fitzpatrick at (718) 977-8142.

- (3) TIME WARNER CABLE OF NEW YORK CITY

There are TIME WARNER CABLE facilities in the area of construction. The Contractor shall notify TIME WARNER CABLE at least seventy-two (72) hours prior to the start of construction by contacting Mr. Mark Larm at (917) 335-9181.

- (4) NATIONAL GRID

There are NATIONAL GRID facilities in the area of construction. The Contractor shall notify NATIONAL GRID at least seventy-two (72) hours prior to the start of construction by contacting Mr. Neville Jacobs Jr. at (718) 963-5612.

- (2) **Refer** to **Subsection 10.21 - Contractor To Notify City Departments**, Page I-13:

Add the following to **Subsection 10.21**:

- (1) N.Y.C. D.E.P., BUREAU OF WATER AND SEWERS OPERATIONS

The Contractor shall notify Mr. James Garin, P.E., Director, Engineering at the Department of Environmental Protection, 59-17 Junction Blvd., 3rd floor low rise, Corona N.Y. 11368, at least thirty (30) days prior to the start of construction.

- (2) NEW YORK CITY FIRE DEPARTMENT

The Contractor shall notify the Bureau of Fire Communications at least thirty (30) days prior to the start of construction by contacting Mr. Cleanthis Meimaroglou at (718) 999-1719.

- (3) N.Y.C. DEPARTMENT OF TRANSPORTATION

The Contractor shall notify Mr. Steve Galgano, P.E. Chief of Signal/Street Lighting Operations, 34-02 Queens Blvd., Long Island City, N.Y. 11101 at (718) 786-3550, at least seventy-two (72) hours prior to the start of construction.

- (4) N.Y.C. DEPARTMENT OF PARKS AND RECREATION

The Contractor shall notify the Parks Department at least seventy-two (72) hours prior to the start of construction by contacting Mr. James Cruickshank at (718) 965-7739.

- (5) N.Y.C. TRANSIT AUTHORITY

The Contractor is advised that bus routes as well as bus stops, within the scope of this project may be affected during construction operations. The Contractor shall notify the Transit Authority at least two (2) weeks prior to the start of construction, in order to make the necessary arrangements.

Arrangements shall be made through:

Ms. Sarah Wyss
Director Of Short Range, Bus Service Planning (SRB)
New York City Transit
2 Broadway, 17th Floor
New York, N.Y. 10004
Telephone No. (646) 252-5517
sarah.wyss@nyct.com

- (3) **Refer** to **Subsection 10.30 - Contractor To Provide For Traffic**, Page I-15:
Add the following to **Subsection 10.30**:

(1) Traffic Stipulations:

The Contractor shall refer to Traffic Stipulations identified in the maintenance of traffic requirements under Highway Contract No. HWPEDSF1.

- (4) **Refer** to **Subsection 71.41.4 - Specific Pavement Restoration Provisions**, Page VII-67:
Add the following to **Subsection 71.41.4**:

(E) Specific Pavement Restoration Provisions:

- (1) Highway and roadway reconstruction shall be accomplished and paid for in accordance with Highway Construction Plans, Details and Specifications for Highway Project ID. HWPEDSF1.

D. AMENDMENTS TO THE SPECIFICATIONS FOR TRUNK MAIN WORK

- 1) **Refer to Part 1 – Furnishing And Delivering Steel Pipes And Appurtenances 30 Inches In Diameter And Larger, Paragraph 13. Special Fittings:, Page 5;**
Add the following to Paragraph 13:

The steel reducer shall have a length of seven (7) feet for every twelve (12) inches reduction in diameter.

END OF ADDENDUM NO. 3
This Addendum consists of seven (7) pages.

NO TEXT ON THIS PAGE

THE CITY OF NEW YORK
DEPARTMENT OF DESIGN AND CONSTRUCTION
INFRASTRUCTURE DIVISION
BUREAU OF DESIGN

PROJECT ID: HWPEDSF1

MULTI-SITE PEDESTRIAN SAFETY
WHICH INCLUDES THE FOLLOWING INTERSECTIONS:

31ST STREET AND 39TH AVENUE
31ST STREET AND 36TH AVENUE
31ST STREET AND BROADWAY

INCLUDING BUS BULBOUTS, CURB EXTENSIONS, BUS PADS,
PEDESTRIAN RAMPS, CATCH BASINS, PAVEMENT MARKINGS,
STREET LIGHTING, AND TRAFFIC SIGNAL WORK

Together With All Work Incidental Thereto

BOROUGH OF QUEENS
CITY OF NEW YORK

ADDENDUM NO.4

DATED: October 14, 2014

THIS ADDENDUM IS HEREBY MADE A PART OF THE CONTRACT DOCUMENTS

1. The Contractor shall be responsible for compliance with all the provisions of the following Sections and Schedules, which are hereby made a part of the original contract documents:
 - A. "SECTION U: Additional Contract Requirements Applying to Work Performed in the Presence of Privately Owned Utility Facilities" (Pages A4-3 through A4-13)
 - B. Schedule U-1 (Page A4-14)
 - C. Schedule U-2 (one for each Utility Company) (Pages A4-15 through A4-35)
 - D. Section U-3 Page A4-36 (as per the Private Utilities reference document for SECTION U called "CET SPECIFICATIONS AND SKETCHES", dated November 2010), Test Pits, Pages (A4-37 through A4-46) in this Addendum; and,
 - E. Utility drawings (7 Sheets), consisting of:
 - * Overhead Condition Report (3 Sheets), (Con Edison)
 - * Conduits and Ducts Occupancy Plate (1 Sheet), (Con Edison)
 - * Low Tension Main and Service Plate (1 Sheet), (Con Edison)
 - * Gas Main and Service Plate (1 Sheet), (Con Edison)
 - * CET-700 (1 Sheet), (Con Edison)attached to the Plans.
2. Each facility operator shall provide inspectors at the work site to inspect methods of interference work, verify quantities and items of Utility Work, and coordinate all phases of the facility operator operations.

3. In addition, the following statements are made to provide clarification of various paragraphs under Section U:
- A. Section U, ¶4, requires the Contractor to immediately commence negotiations with each Company for an Interference Agreement under which the Company will compensate the Contractor for any Interference Work which the Company does not elect to perform with its own forces or by specialty contractors retained by the Company. Thus the Contractor is on notice that its work under the Contract may be affected by Interference Work performed by (a) the Contractor pursuant to a separate Interference Agreement with the Company, (b) the Company, or (c) partly by each.
 - B. Section U, ¶2, informs the Contractor that the duration of the Contract as shown in Schedule A includes the time which may be necessary for the Contractor to perform the necessary Interference Work.
 - C. The Contractor is hereby informed that the duration of the Contract as shown in Schedule A includes the time which may be necessary for the Company to perform whatever portion of the Interference Work which the Company elects to perform with its own forces or by specialty contractors retained by the Company.
 - D. Section U informs the Contractor that the City has entered into a Utility Agreement with the Companies regarding interferences to the City work in this Contract created by the facilities owned and/or operated by such Companies. Pursuant to this Addendum, a sample of the Utility Agreement letter as executed by the Companies is annexed on page A4-13, as an Exhibit to the Contract. Signed copies of those Utility Agreement letters are on file with NYCDDC.
 - E. The City has no contract with any of the Companies for work on or adjacent to the site of work under this Contract, and the Companies are not "Other Contractors" as defined for the purposes of this Contract. The Contractor is reminded, however, that pursuant to Section U, ¶4, the City will not compensate the Contractor for any direct and/or indirect costs related to Interference Work, regardless of whether such Interference Work is covered by an Interference Agreement between the Contractor and the Company or is performed by the Company using its own forces or by specialty contractors retained by the Company.
 - F. Section U, ¶14, provides that the provisions of Section U are material provisions of the Contract and that the Contractor's failure to comply with the procedures set forth in Section U are sufficient for the Commissioner to declare the Contractor in default pursuant to Article 48 of the Contract. Pursuant to this Addendum, the Contractor is informed that the Performance Bond required of the Contractor pursuant to the Contract is not deemed to guarantee performance of any of the Interference Work.

Section U: Additional Contract Requirements Applicable to Work Performed in the Presence of Privately Owned Utility Facilities

The Contractor is hereby notified that pursuant to the law and franchise agreements issued by the City, certain private utility and public service companies named in Schedule U-1 ("the Companies") own and/or operate surface and/or subsurface facilities within the limits of this contract. The existence of these facilities impacts the productivity of the City work called for in the contract. In order to improve coordination of the City construction with the private utility facilities owned and/or operated by the Companies named in Schedule U-1, Article 1.06.30 of the Standard Highway Specifications of the New York City Department of Transportation, Dated November 1, 2010; and Articles 10.15 through 10.18 of the General Provisions of the Standard Sewer and Water Main Specifications of the New York City Department of Environmental Protection, dated July 1, 2014; as applicable, are amended and will be implemented as follows:

1. Pre-engineering:

The anticipated scopes of private utility facilities interferences and anticipated work items and specifications are included in this contract. The locations of these interferences are indicated on the plans and/or listed in the specifications for this contract, and a schedule of estimated quantities by type of interference expected to be encountered within the limits of this project area have been listed on Schedule U-2. In addition, in Section U-3 the Companies have provided standard details and methods for supporting, protecting, relocating, and/or working around their facilities when they are in interference with City contract work.

2. Means and methods for City work:

- a) The Contractor is hereby notified that the utility interferences identified on the plans and/or listed in the Specifications to be known conditions which may impact the performance of, and/or interferes with, City work. The contractor will be required to perform such utility work as directed by the Resident Engineer in order to clear all utility interferences from the project site as required for satisfactory completion of City work within specified contract schedule.
- b) In areas serviced by overhead electric system, the contractor understands and by bidding for this contract agrees that he/she has reviewed the section 'U' package and that he/she will be required to perform the public work in the presence of energized electrical overhead lines and appurtenances located in areas adjacent and/or within the

project area. As a consequence he/she will select means and method of construction appropriate to maintain the safety clearances required or as permitted by contract specifications (e.g. "CET 350 – Overhead Accommodation Protection of Overhead Facilities, Poles, and Appurtenances") in order to avoid damaging the insulation or shielding of these lines and also to prevent knocking them down. The duration of the contract as shown in Schedule A thus includes the time which may be necessary for the Contractor to remove, repair, protect, support, shift, relocate, temporarily remove and replace, work around and/or work in the presence of the Companies' facilities ("Interference Work") as described on the plans and/or specifications of the contract during the progress of the City work.

3. *Field inspection prior to construction:*

Prior to the start of any contract work in areas serviced by overhead electric lines, and after the award to the apparent low bidder for this contract, the contractor must request a field walk of the project area along with the operator of the overhead electrical facilities and the DDC Engineer-In-Charge. At that time the facility operator, pursuant to contract specification (e.g. "CET 350 – Overhead Accommodation Protection of Overhead Facilities, Poles, and Appurtenances") will confirm the type and condition of the overhead electrical lines and the sufficiency of their insulating properties with respect to the means and methods proposed by the contractor. The contractor must be prepared to describe in enough details his/her proposed means and methods of construction operations in order to anticipate the likelihood that electric lines insulation would be cut or otherwise compromised. Also such details will allow the facility operator to anticipate the need for added insulation and/or shielding of non-insulated lines.

4. *Compensation for interference work:*

Compensation for Interference Work is a matter of adjustment between the Contractor and each private utility company located within the limits of the project area and whose utility facilities are affected by City contract work. In particular, the City will not compensate the Contractor for any direct and/or indirect costs related to Interference Work, including, but not limited to, lost profit, increased overhead, or any other impact costs. Upon receipt of a Notice of Award from the City, the Contractor shall immediately commence negotiations with each of the Companies concerning the manner in which and the price for which the Contractor, through its own forces or by others hired by it, will perform and be paid by the Company for all necessary Interference Work as defined above that the Company(ies) choose(s) not to

perform with its(their) own forces or by specialty Contractors hired by it (them) (as per "Interference Agreement"). (Specialty contractors' work is limited to (i) insulation installation and removal, (ii) live gas and steam work, (iii) cleanup and disposal of hazardous materials, (iv) splicing live electrical and telecommunications facilities, and (v) work not traditionally performed by general construction contractors.

5. *Interference Agreement:*

1. The Companies have provided estimate of the quantity of each of the types of interferences expected to be encountered in the contract in Schedule U-2. Although the parties may negotiate an Interference Agreement in any format or manner they deem fit, the Contractor is hereby advised that the Companies have indicated to the City that they will agree to compensate the Contractor on a unit price basis according to the Quantity and Types of Interferences expected to be encountered on this Contract as stated in Schedule U-2.
2. Furthermore, in Section U-3, standard unit work measurement and payment provisions are specified and shall apply only if the Contractor and affected Utility companies enters into a unit price based Interference Agreement, otherwise the unit of work measurement, and payment provisions set forth in Section U-3 shall not apply. The Contractor shall notify the City upon concluding an Interference Agreement with each of the Companies, which shall be binding and final once concluded.

6. *City contract work to continue without Interference Agreement :*

If, prior to the start of construction, as directed by the City's Order to work / Notice To Proceed (OTW/ NTP) date any of the Companies and the Contractor have not concluded an Interference Agreement as described above, then the City construction will proceed as ordered and the Contractor will be directed by the Resident Engineer to perform the City work on Time, Material and Equipment basis (T&M) as specified in standard City contract agreement Article 26.2. T&M records will include identification of types of utility facilities interfering with City work, utility facility owners, specifying the nature and quantity of any materials, plant and equipment furnished or used in connection with the performance of such work and crew size, such as: name and number of each worker employed on such work. T&M records will also indicate the hours of active time, standby time and idle time. The Company (ies) and the Contractor will maintain separate records of the actual quantity and cost of labor, materials, and equipment expended, and will provide copies of this information to the other party on a daily basis for reconciliation. These T&M records along with cost evaluations will be

submitted daily to the Resident Engineer for review and approval. The total cost of City work will be based on quantity of work performed multiplied by unit price contract bid items. The total interference cost will be calculated as the difference between the total T&M cost and total cost for City work. The Resident Engineer will conduct a monthly reconciliation session of the daily T&M records with the affected Company (ies) and contractor. If the contractor and affected utility companies cannot reconcile their T&M records, by the last day of each month, then the Resident Engineer will submit the approved City's T&M records along with total cost evaluations to the DDC Director of Construction who will review these records and recommend approval and validity certification by the DDC Deputy Commissioner.

1. Copies of the DDC approved and certified T&M records will then be transmitted by the DDC to the contractor and the utility companies. These certified records may be used by the contractor for compensation claims against the responsible private facility owners, or may be used by any party as supporting documentation in dispute regarding compensation for performing Interference Work as identified in Schedule U-2. The contractor will be required to perform City work while invoices are submitted by the contractor to the Utility companies for payment within 30 days, or while compensation disputes between contractor and affected company (ies) are submitted to Binding Arbitration process described in Paragraph 10.
2. All issues related to utility work and/ or delays due to compensation disputes or claims against utility companies are not allowable as justification for granting contract time extensions. The City may assess liquidated damages specified in the contract for net overall delays suffered by City contract work as a result of utility issues, disputes and claims.
3. The standard City contract dispute resolution process specified in Article 27 "Presentation of disputes to Commissioner", of the standard City contract agreement is not applicable to any disputes related to utility work and/ or compensation for such work or claim against utility companies. Utility work issues, disputes and claims may only be submitted to Binding Arbitration process described in Paragraph 10.
4. The contractor will notify the Resident Engineer when utility capital work not specified in Schedule U2 and/ or for utility work that require the intervention of company utility specialty crews causes excessive contractor's labor and equipment standby or idleness and, thereby jeopardizing the City project schedule. The Resident Engineer will submit the facts to the DDC Director of construction who will recommend to the Deputy

Commissioner regarding the issuance of a "48 hours notice" to the concerned utility company as authorized by the New York City administrative Code Section 19-143 and/or Section 24-521 as applicable.

5. Utility delays caused by utility capital work not listed in Schedule U2 and/ or by unavailability of utility specialty crews cannot be discounted for earning any contractual bonus when such bonus clause is included in a contract. However, if such specified bonus is not earned or disallowed by the City or if the City assesses specified liquidated damages as a result of such excessive delays, the contractor may seek damages from the responsible utility company (ies).

7. *Extra utility work with Utility Agreement:*

If during construction the Contractor encounters utility facilities interferences or utility scope of work that it believes is not covered by the Interference Agreement as described above, then the Contractor shall immediately notify the Company in writing, with a copy to the City, describing the nature and location of the extra work in question. The Company then has five (5) business days to investigate the conditions and then:

1. Advise the Contractor and the City in writing that no interference with its facilities exists at the location in question, and hence that the Contractor may proceed with City work without providing for any impact from Company facilities;
2. Advise the Contractor and the City in writing that the Interference Agreement negotiated pursuant to Paragraph (6), above, provides for the scope of work encountered, specifying the exact unit items and/or terms of the agreement that cover the work;
3. Advise the Contractor and the City in writing that it intends to perform the necessary utility Work with company forces or with its own contractor including, but not limited to, relocating its facility out of the way of the proposed City work. In this case, the Company shall provide a written schedule for the performance of the utility work it proposes to perform, which shall be subject to approval by the City based on its impact to the Contractor's currently approved progress schedule. Upon approval of the Company's schedule by the City, the Contractor shall provide access to the worksite to the Company and/or any contractors hired by it to perform this utility work. If necessary, the City may grant a contract time extension for delays caused by the performance of such utility work by the company.

4. Reasonably specify in writing the scope of work to be performed by the Contractor on behalf of the Company that is not covered under the Interference Agreement negotiated pursuant to Paragraph (6), including, but not limited to, relocating, supporting, and/or protecting the Company's facilities, and/or shifting the City facility if approved by the Resident Engineer, and/or otherwise changing its operations to work in the presence of the Company's facilities. Should the Company elect this option, it must adequately define and provide an initial price offer for the work required to be performed.

8. *Means and Methods for utility work:*

Upon receipt of the Company's determination pursuant to paragraphs 7.2, or 7.4, above, the Contractor shall determine reasonable means and methods of performing the work defined by the Company. These means and methods are subject to approval of the Company, which shall not be unreasonably withheld. If, however, the Company objects to the Contractor's proposed means and methods then it shall define an alternate method of construction. Upon receipt of the Company's approval or its proposed alternate method of construction, the Contractor shall commence performance of the work defined by the Company as soon as possible, and shall perform the work in a good, workmanlike, and efficient manner, using the means and methods approved by the Company, in order to permit the City work to proceed in the most expeditious manner possible, but without imposing unreasonable and/or unnecessary costs on the Company. It is expressly understood by all parties that the City's rights pursuant to Article 4 of the Contract apply to Utility Work performed pursuant to this section.

9. *Disputed utility work covered by a utility agreement:*

The City Work will continue as described in paragraph 6 above. In the event of any dispute between the Company (ies) and the Contractor regarding any issue related to the performance of, or payment for, utility work, including, but not limited to, any indirect or impact costs incurred by the Contractor due to the Utility Work and/or to the existence of facilities owned or operated by the Company (ies) on the line of the work. The Company (ies) and the Contractor hereby agree to submit to each other a "Final Offer," in writing, by certified mail. Each party shall then have three business days to consider each other's Final Offer. In the event that neither party accepts the other's Final Offer within those three days, the Company (ies) and the Contractor agree to immediately submit the dispute to binding arbitration as described in Paragraph 10. During the pendency of any arbitration, the Company (ies) and the Contractor shall maintain separate records of the actual quantity and cost of labor, materials, and equipment expended, and to provide copies of this information to the other party on a daily

basis for reconciliation. Any and all disagreement with the records maintained and provided by the other, must be documented in writing to all parties. However, these records are solely for the benefit of presentation to the arbitrator, whose decision may not necessarily be based on these records and in any event is final. Both parties should be aware that the City will not confirm or deny the accuracy of any records maintained by either party for Utility work performed pursuant to a Utility Agreement. While the arbitration is pending, the Company shall pay the Contractor on a monthly basis, based on the price offered by the Company to the Contractor for the performance of the work.

10. Arbitration of utility work:

The arbitration of the issues described above shall be conducted pursuant to the Construction Industry Arbitration Rules of the American Arbitration Association (hereinafter "the Rules" and "AAA") in effect on the date the arbitration is initiated except as set forth herein. The arbitration award shall be final and binding upon the parties to the arbitration and judgment upon the award may be entered in a court having jurisdiction.

- (a) Once an arbitrator(s) has been appointed by the AAA, the arbitration shall be scheduled as promptly as possible given the arbitrator(s) and the parties' schedules.
- (b) No later than seven days prior to the first arbitration hearing, Company and Contractor shall submit to the arbitrator(s), and to each other, a summary of each party's respective position and such other information as is deemed appropriate, along with a copy of each party's Final Offer as specified in paragraph 9.
- (c) The arbitration shall be conducted and concluded in two days.
- (d) On the morning of the first day of the arbitration, Contractor and/or representatives shall have 3 ½ hrs to make a presentation of its claim to the arbitrator. During its presentation, Contractor shall not be permitted to produce any documents or cost records which have not already been provided to the Company. Contractor shall be permitted to produce any analysis or description of its claim which has been prepared for the purpose of its presentation.
- (e) After lunch, Company and/or its representatives shall have two hours to ask Contractor questions about its claim and its presentation. Thereafter the arbitrator(s) shall have two hours to ask Contractor questions about its claim and its presentation.
- (f) On the morning of the second day of the arbitration, Company and/or its representatives shall have 3 ½ hours to make a presentation of its claim to the arbitrator. During its presentation, the Company shall not be permitted to produce any documents or cost

records which have not already been provided to the Contractor. The Company shall be permitted to produce any analysis or description of its claim which has been prepared for the purpose of its presentation.

- (g) After lunch, Contractor and/or its representatives shall have two hours to ask Company questions about its claim and its presentation. Thereafter the arbitrator(s) shall have two hours to ask Company questions about its claim and its presentation.
- (h) Subject to the above time limitations, the arbitrator(s) may conduct the arbitration in such manner as the arbitrator(s) deems reasonable.
- (i) The arbitrator(s) shall then have one week to select in writing, as the arbitrator ('s) award, that party's Final Offer which appears to be more reasonable, based on the presentations at the arbitration hearings.
- (j) The arbitrator shall have no discretion to grant an award other than one of the two Final Offers submitted by the parties.
- (k) Any award for work that has already been performed shall be paid on the 7th day after receipt of the arbitrator's decision, or on the 30th day after completion of the work, whichever is later. Payment for work not yet completed at the time of the arbitrator's decision shall be paid within 30 days of completion of work. Interest shall accrue from the date payment is due at the rate of 9% per annum. Either party may cause judgment to be entered in accordance with the arbitrator(s) decision in a court in the State of New York, County of New York.
- (l) The arbitrator's fees and any other costs of the arbitration shall be initially shared equally by Company and Contractor. The non-prevailing party shall then pay all arbitrator's fees and costs of the arbitration and shall reimburse the prevailing party for its share of such fees and costs theretofore paid.
- (m) The parties may, at any time, settle any matter submitted to arbitration.

11. Order-out waiver:

The Contractor and all subcontractors hired by it, if an Interference Agreement is executed as specified between the concerned parties, agree to waive any rights they may have, if any, under law, contract or otherwise to compel the City to assert any right the City may have, including the issuance of any directives required under the New York City Administrative Code, Section 19-143 and Section 24-521, to require any or all of the Companies to maintain, repair, replace, protect, support, shift, alter, relocate, and/or remove utility facilities in connection with the work to be performed under this contract. However, nothing in this section shall preclude the City from exercising its rights under the Law to issue such a directive to the Company.

12. Cost of insurance:

Each of the named Companies, at their option and if an Interference Agreement is executed as specified between the concerned parties, may be named as an additional insured on all insurance policies required to be maintained under this contract. In the event that a Company opts to be so named as an additional insured, the actual incremental cost, if any, to the Contractor of providing such insurance coverage shall be borne by that Company. The Contractor shall provide a written statement from its insurance provider documenting the actual cost of this added coverage to the Company. Under no circumstances shall the cost of insurance coverage on behalf of any Company be borne by the City. Nothing in this paragraph shall be interpreted to imply the City's acceptance of any additional responsibility or liability for any matter related to the performance of Utility Work. In particular, the Company and the Contractor bear joint and full responsibility to ensure that any Utility Work performed by the Contractor is in compliance with all applicable government and Company regulations.

13. Cost of utility interference work:

The Companies, by virtue of a prior agreement with the City, have agreed to perform their obligations described in this section. It is expressly understood that the cost of Utility Work shall not be a charge against the City, but shall be a matter for adjustment between the Contractor and the Company or Companies concerned. The City and the Contractor agree that the Companies are third party beneficiaries of this section of the contract, if a Utility Agreement is executed between the contractor and utility company (ies). The provisions of this section shall govern in all cases where Company property interferes with or is about to be disturbed by the City work, notwithstanding any other provision of the Contract, except for Natural Gas transmission/distribution facilities covered subject to the Gas Facility Cost Allocation Act (GFCAA) and covered separately in this contract.

14. Default declaration:

The Contractor agrees that the provisions of this section are material provisions of the contract, and that the Contractor's failure to comply with the procedures set forth above are sufficient for the Commissioner to declare the Contractor in default pursuant to Article 48 of the Contract.

15. NYS Labor Law:

The Contractor is hereby advised that New York State Labor Law applies to public work. The work described in this Section U of the contract performed by utility company (ies) with their own forces or vendors hired by such company (ies) is not public work.

16. Facility operators:

The insurance requirements in Paragraph 12 of this Section U apply to: (i) additional Companies, if any, who were not named in Schedule "A" but which have executed a Utility Agreement with the contractor for utility work; and (ii) additional coverage, if any, paid for by Utility Companies whose utility facilities are located within the project limits, that they may require for the utility work pursuant to an utility agreement between the contractor and such utility companies.

[End]

"STANDARD UTILITY LETTER OF AGREEMENT"

(Name)
Deputy Commissioner, Infrastructure Division
Department of Design and Construction
30-30 Thomson Avenue
Long Island City, NY 11101

RE: City Work Performed in the Presence of Private Utility Facilities
Project No: _____

Dear (Name):

This letter is to certify that _____, has requested the inclusion of the attached "Section U: Additional contract requirements applying to work performed in the presence of privately owned utility." The company agrees to abide by the terms of this Section U and to submit a schedule listing the scope of work, including the items and estimated quantities, and types of utility facilities to be supported and protected at the company's own expenses due to interferences with the Public work.

Sincerely,

By: Authorized Company Representative

Title

NOTARY PUBLIC

CERTIFIED AS TO FORM
AND LEGAL AUTHORITY:

By: _____

SCHEDULE U-1

HWPEDSF1

MULTI-SITE PEDESTRIAN SAFETY

SCHEDULE U-1

LISTING OF COMPANIES NAMED FOR THIS CONTRACT

COMPANY NAME

CONTACT NAME

CONTACT TELEPHONE

CON EDISON

THERESA KONG

212-460-4834

VERIZON

AUBREY MAKHANLAL

718-977-8173

TIME WARNER

JOHN PIAZZA

718-888-4261

**SCHEDULE U-2
FOR INFORMATION ONLY
ENGINEER'S ESTIMATE OF QUANTITY AND TYPES OF INTERFERENCE
FOR CONSOLIDATED EDISON
HWPEDSF1
PEDESTRIAN SAFETY 1**

CET ITEM	DESCRIPTION	UNITS	ESTIMATED QUANTITY
CET 803.2	LINE CUT BY PNEUMATIC TOOLS IN LIEU OF SAW CUT ASSOCIATED W/ ROADWAY REMOVAL (ASPHALT & CONCRETE)	LF	3
CET 1012V	12" VERTICAL OR ROLLED WATER MAIN OFFSET	EA	8

(Revision 1) 9/22/2014
April 18, 2014

**CON EDISON SCOPE OF WORK
SUPPORT AND PROTECTION
HWPEDSF1
PEDESTRIAN SAFETY 1**

CET 100.1 UTILITIES CROSSING TRENCH FOR CATCH BASIN CHUTE CONNECT. AND/OR TESTPIT (TYPE .1) EA

At the following locations:

- 2' N/S/C 39th Ave. and 23' W/W/C 31st St.
- 10' N/S/C 39th Ave. and 21' W/W/C 31st St.
- 24' N/N/C 39th Ave. and 5' W/E/C 31st St.
- 33' N/N/C 36th Ave. and E/C 31st St.
- 24' N/N/C 36th Ave. and 15' W/E/C 31st St.
- 95' S/S/C Broadway and 2' W/E/C 31st St.
- 16' S/N/C 36th Ave. and 25' E/W/C 31st St.

Total Quantity for CET 100.1 = 7

CET 100.2 UTILITIES CROSSING TRENCH FOR CATCH BASIN CHUTE CONNECT. AND/OR TESTPIT (TYPE .2) EA

At the following locations:

- 3' S/N/C 39th Ave. and 6' E/W/C 31st St.
- 3' S/N/C 39th Ave. and 23' W/E/C 31st St.
- 12' S/N/C 36th Ave. and 17' E/W/C 31st St.
- 108' N/N/C 36th Ave. and 15' E/W/C 31st St.
- 19' S/S/C Broadway and 5' E/W/C 31st St.
- 97' N/N/C Broadway and 17' E/W/C 31st St.
- 4' S/N/C Broadway and 32' E/E/C 31st St.

Total Quantity for CET 100.2 = 7

CET 100.3 UTILITIES CROSSING TRENCH FOR CATCH BASIN CHUTE CONNECT. AND/OR TESTPIT (TYPE .3) EA

At the following locations:

- 91' N/N/C 39th Ave. and 15' E/W/C 31st St.
- 2' S/N/C 36th Ave. and 1' E/W/C 31st St.
- 33' N/N/C 36th Ave. and E/C 31st St.

Total Quantity for CET 100.3 = 3

(Revision 1) 9/22/2014

April 18, 2014

**CON EDISON SCOPE OF WORK
SUPPORT AND PROTECTION
HWPEDSF1
PEDESTRIAN SAFETY 1**

- CET 108.1** UTILITIES CROSSING TRENCH FOR WATERMAIN UP TO AND INCL. 12" DIAMETER (TYPE .1) EA
- At the following locations:*
- 47' N/N/C 39th Ave. and 8' EW/C 31st St.
 - 66' N/N/C 39th Ave. and 8' EW/C 31st St.
 - 82' N/N/C 39th Ave. and 8' EW/C 31st St.
 - 85' N/N/C 39th Ave. and 8' EW/C 31st St.
 - 16' S/S/C 36th Ave. and 8' EW/C 31st St.
 - 7' S/N/C 36th Ave. and 22' EW/C 31st St.
 - 44' N/N/C 36th Ave. and 8' EW/C 31st St.
 - 90' N/N/C 36th Ave. and 8' EW/C 31st St.
 - 101' N/N/C 36th Ave. and 8' EW/C 31st St.
 - 105' N/N/C 36th Ave. and 8' EW/C 31st St.
 - 118' N/N/C 36th Ave. and 8' EW/C 31st St.
 - 6' S/N/C 36th Ave. and 26' E/E/C 31st St.
 - 17' N/S/C Broadway and 8' EW/C 31st St.
 - 10' S/N/C Broadway and 8' EW/C 31st St.
- AS ENCOUNTERED AND DIRECTED BY A CON EDISON REPRESENTATIVE
- Total Quantity for CET 108.1 = 14**
-
- CET 108.2** UTILITIES CROSSING TRENCH FOR WATERMAIN UP TO AND INCL. 12" DIAMETER (TYPE .2) EA
- At the following locations:*
- 7' S/N/C 36th Ave. and 17' EW/C 31st St.
 - 25' N/N/C 36th Ave. and 8' EW/C 31st St.
 - 7' S/N/C Broadway and 5' EW/C 31st St.
 - 5' S/N/C Broadway and 8' EW/C 31st St.
 - 39' N/N/C Broadway and 8' EW/C 31st St.
- Total Quantity for CET 108.2 = 5**
-
- CET 200.1** EXTRA DEPTH EXCAVATION OF CATCH BASIN CHUTE CONNECTIONS (INVERT DEPTH 4'-6" TO 5' FOR TYPE 2 OR UP TO 5'-6 FOR TYPE 3) LF
- At the following locations:*
- N/C 36th Ave. and 1' EW/C 31st St.
 - 19' S/S/C Broadway and 5' EW/C 31st St.
 - 95' S/S/C Broadway and E/C 31st St.
- Total Quantity for CET 200.1 = 86**

(Revision 1) 9/22/2014
April 18, 2014

**CON EDISON SCOPE OF WORK
SUPPORT AND PROTECTION
HWPEDSF1
PEDESTRIAN SAFETY 1**

CET 200.2 **EXTRA DEPTH EXCAVATION OF CATCH BASIN CHUTE CONNECTIONS (INVERT DEPTH 5' TO 6' FOR TYPE 2 OR > 5'-6" TO 6'-6" FOR TYPE 3)** **LF**

At the following locations:

- 3' S/N/C 39th Ave. and W/C 31st St.
- 91' N/N/C 39th Ave. and W/C 31st St.
- 95' N/N/C Broadway and W/C 31st St.
- N/C Broadway and 35' E/E/C 31st St.
- 33' N/N/C 36th Ave. and E/C 31st St.

Total Quantity for CET 200.2 = 141

CET 225.1A **INSTALLATION AND REMOVAL OF CATCH BASINS WITH UTILITY INTERFERENCES** **EA**

At the following locations:

- 3' S/N/C 39th Ave. and W/C 31st St.
- 2' S/N/C 36th Ave. and 1' E/W/C 31st St.

Total Quantity for CET 225.1A = 2

CET 225.1B **INSTALLATION OF CATCH BASINS WITH UTILITY INTERFERENCES** **EA**

At the following locations:

- 2' N/S/C 39th Ave. and 23' W/W/C 31st St.
- 105' N/N/C 36th Ave. and 2' E/W/C 31st St.
- 19' S/S/C Broadway and 5' E/W/C 31st St.
- N/C Broadway and 35' E/E/C 31st St.
- 2' N/S/C Broadway and 21' E/E/C 31st St.
- 95' S/S/C Broadway and E/C 31st St.

Total Quantity for CET 225.1B = 6

CET 225.1C **REMOVAL OF CATCH BASINS WITH UTILITY INTERFERENCES** **EA**

At the following locations:

- 2' S/N/C Broadway and 9' E/E/C 31st St.

Total Quantity for CET 225.1C = 1

(Revision 1) 9/22/2014
April 18, 2014

**CON EDISON SCOPE OF WORK
SUPPORT AND PROTECTION
HWPEDSF1
PEDESTRIAN SAFETY 1**

CET 300	SPECIAL CARE EXCAVATION AND BACKFILING <i>At the following locations:</i> 10' N/S/C 39th Ave. and 21' W/W/C 31st St. 85' N/N/C 39th Ave. and 1' E/W/C 31st St. 85' N/N/C 39th Ave. and 30' E/W/C 31st St. 8' S/N/C 36th Ave. and 17' E/W/C 31st St. 33' N/N/C 36th Ave. and E/C 31st St. 6' S/N/C 36th Ave. and 20' W/E/C 31st St. 2' N/S/C Broadway and 8' E/W/C 31st St. 104' N/N/C Broadway and 30' E/W/C 31st St. 22' S/N/C Broadway and 16' E/E/C 31st St. Total Quantity for CET 300 = 36	CY
CET 302	FIELD COATING OF OIL-O-STATIC FEEDER PIPES <i>At the following locations:</i> 14' N/S/C 36th Ave. and 8' E/W/C 31st St. Total Quantity for CET 302 = 3	LF
CET 303	FURNISH, DELIVER AND INSTALL 3/8" CLEAN SAND BACKFILL <i>At the following locations:</i> 14' N/S/C 36th Ave. and 8' E/W/C 31st St. Total Quantity for CET 303 = 1	CY
CET 304 A	FURNISH, DELIVER AND INSTALL CONCRETE ROAD BASE <i>At the following locations:</i> 2' N/S/C 39th Ave. and 23' W/W/C 31st St. 3' S/N/C 39th Ave. and 23' W/E/C 31st St. 2' S/N/C 36th Ave. and 1' E/W/C 31st St. 19' S/S/C Broadway and 5' E/W/C 31st St. AS ENCOUNTERED AND DIRECTED BY A CON EDISON REPRESENTATIVE Total Quantity for CET 304 A = 12	CY

(Revision 1) 9/22/2014
April 18, 2014

VERIZON

For Information Only

MARCH 2014

**HWPEDSF1- Multi-Site Pedestrian Safety
Borough of Queens**

Schedule U-2: Scope of Work for CET items

CET 100.1

**UTILITIES CROSSING TRENCH FOR CATCH BASIN CHUTE CONNECTIONS
AND/OR TEST PITS (TYPE .1)**

@ THE FOLLOWING LOCATIONS

NEC OF INT OF 31ST ST & 39TH AVE

QTY(EA)

2

CET 100.1

TOTAL

2

CET 100.2

**UTILITIES CROSSING TRENCH FOR CATCH BASIN CHUTE CONNECTIONS
AND/OR TEST PITS (TYPE .2)**

@ THE FOLLOWING LOCATIONS

NEC OF INT OF 31ST ST & 39TH AVE

QTY(EA)

2

NWC OF INT OF 31ST ST & 39TH AVE, ON 39TH AVE

1

NEC OF INT OF 31ST ST & 36TH AVE

1

E SIDE OF 31ST ST BTWN 34TH AVE & BROADWAY

1

CET 100.2

TOTAL

5

CET 100.3

**UTILITIES CROSSING TRENCH FOR CATCH BASIN CHUTE CONNECTIONS
AND/OR TEST PITS (TYPE .3)**

@ THE FOLLOWING LOCATIONS

AS ENCOUNTERED & DIRECTED BY THE VERIZON FIELD REPRESENTATIVE

QTY(EA)

1

CET 100.3

TOTAL

1

CET 100.4

**UTILITIES CROSSING TRENCH FOR CATCH BASIN CHUTE CONNECTIONS
AND/OR TEST PITS (TYPE .4)**

@ THE FOLLOWING LOCATIONS

NEC OF INT OF 31ST ST & BROADWAY, ON BROADWAY

QTY(EA)

1

CET 100.4

TOTAL

1

CET 108.1

**UTILITIES CROSSING TRENCH FOR WATER MAIN UP TO AND INCLUDING
12" DIAMETER (TYPE .1)**

**HWPEDSF1- Multi-Site Pedestrian Safety
Borough of Queens**

Schedule U-2: Scope of Work for CET items

@ THE FOLLOWING LOCATIONS		QTY(EA)
NWC OF INT OF 31ST ST & 39TH AVE		1
W SIDE OF 31ST ST BTWN 39TH AVE & 38TH AVE		2
SWC OF INT OF 31ST ST & 36TH AVE		1
CET 108.1	TOTAL	4

CET 108.2

**UTILITIES CROSSING TRENCH FOR WATER MAIN UP TO AND INCLUDING
12" DIAMETER (TYPE .2)**

@ THE FOLLOWING LOCATIONS		QTY(EA)
NWC OF INT OF 31ST ST & 39TH AVE		1
NWC OF INT OF 31ST ST & BROADWAY		1
CET 108.2	TOTAL	2

CET 200

EXTRA DEPTH EXCAVATION OF CATCH BASIN CHUTE CONNECTION PIPES

@ THE FOLLOWING LOCATIONS		QTY(LF)
NEC OF INT OF 31ST ST & BROADWAY, ON BROADWAY		26
CET 200	TOTAL	26

CET 225.1B

INSTALLATION OF CATCH BASINS WITH UTILITY INTERFERENCES

@ THE FOLLOWING LOCATIONS		QTY(EA)
INT OF 31ST ST & 39TH AVE, ON 39TH AVE		1
W SIDE OF 31ST ST BTWN 39TH AVE & 38TH AVE		1
NEC OF INT OF 31ST ST & BROADWAY, ON BROADWAY		1
CET 225.1B	TOTAL	3

CET 400

TEST PITS FOR UTILITY FACILITIES

@ THE FOLLOWING LOCATIONS		QTY(CY)
AS ENCOUNTERED & DIRECTED BY THE VERIZON FIELD REPRESENTATIVE		10
CET 400	TOTAL	10

CET 401

TRENCH EXCAVATION FOR ADJUSTMENT OF UTILITY FACILITIES

**HWPEDSF1- Multi-Site Pedestrian Safety
Borough of Queens**

Schedule U-2: Scope of Work for CET items

@ THE FOLLOWING LOCATIONS		QTY(CY)
N SIDE OF BROADWAY BTWN 31ST ST & 30TH ST		69
N SIDE OF BROADWAY BTWN 31ST ST & 32ND ST		15
CET 401	TOTAL	84

CET 402T.2
**EXISTING NON-CONCRETE ENCASED TELECOMMUNICATION CONDUITS
PLACED IN FINAL POSITION WITHOUT CONCRETE ENCASEMENT**

@ THE FOLLOWING LOCATIONS		QTY(LF)
N SIDE OF BROADWAY BTWN 31ST ST & 30TH ST		558
N SIDE OF BROADWAY BTWN 31ST ST & 32ND ST		30
CET 402T.2	TOTAL	588

CET 402T.V2A
**EXISTING VACANT NON-CONCRETE ENCASED TELECOMMUNICATION
CONDUITS PLACED IN FINAL POSITION WITHOUT CONCRETE ENCASEMENT**

@ THE FOLLOWING LOCATIONS		QTY(LF)
AS ENCOUNTERED & DIRECTED BY THE VERIZON FIELD REPRESENTATIVE		10
CET 402T.V2A	TOTAL	10

CET 500
**REMOVAL OF ABANDONED UTILITY CONDUITS
(NON-CONCRETE ENCASED)**

@ THE FOLLOWING LOCATIONS		QTY(LF)
AS ENCOUNTERED & DIRECTED BY THE VERIZON FIELD REPRESENTATIVE		20
CET 500	TOTAL	20

CET 700
**SPECIAL MODIFICATION OF WORK METHODS TO ACCOMMODATE/PROTECT
UNDERGROUND FACILITIES WITH LIMITED COVER**

@ THE FOLLOWING LOCATIONS		QTY(CY)
AS ENCOUNTERED & DIRECTED BY THE VERIZON FIELD REPRESENTATIVE		65
CET 700	TOTAL	65

VERIZON

For Information Only

MARCH 2014

**HWPEDSF1- Multi-Site Pedestrian Safety
Borough of Queens**

Schedule U-2: Scope of Work for CET items

CET 8.02A

**SPECIAL MODIFICATION OF WORK METHODS FOR INSTALLATION OF NEW
SIDEWALK**

@ THE FOLLOWING LOCATIONS		QTY(SF)
SWC OF INT OF 31ST ST & 36TH AVE		36
E SIDE OF 31ST ST BTWN 37TH AVE & 36TH AVE		283
NEC OF INT OF 31ST ST & BROADWAY		100
CET 8.02A	TOTAL	419

CET 8.02B

SPECIAL MODIFICATION OF WORK METHODS FOR INSTALLATION OF NEW CURB

@ THE FOLLOWING LOCATIONS		QTY(LF)
NWC OF INT OF 31ST ST & 39TH AVE		10
SWC OF INT OF 31ST ST & 36TH AVE		15
E SIDE OF 31ST ST BTWN 37TH AVE & 36TH AVE		10
NEC OF INT OF 31ST ST & BROADWAY		15
CET 8.02B	TOTAL	50



NEW YORK CITY DEPARTMENT OF
DESIGN + CONSTRUCTION

**INFRASTRUCTURE DIVISION
BUREAU OF DESIGN**

VOLUME 3 OF 3

PROJECT ID: HWPEDSF1

MULTI-SITE PEDESTRIAN SAFETY

**HWPEDSF1- Multi-Site Pedestrian Safety
Borough of Queens**

Schedule U-2: Scope of Work for CET items

CET 8.02A

**SPECIAL MODIFICATION OF WORK METHODS FOR INSTALLATION OF NEW
SIDEWALK**

@ THE FOLLOWING LOCATIONS

	QTY(SF)
SWC OF INT OF 31ST ST & 36TH AVE	36
E SIDE OF 31ST ST BTWN 37TH AVE & 36TH AVE	28
NEC OF INT OF 31ST ST & BROADWAY	100
CET 8.02A	TOTAL 419

CET 8.02B

SPECIAL MODIFICATION OF WORK METHODS FOR INSTALLATION OF NEW CURB

@ THE FOLLOWING LOCATIONS

	QTY(LF)
NWC OF INT OF 31ST ST & 39TH AVE	10
SWC OF INT OF 31ST ST & 36TH AVE	15
E SIDE OF 31ST ST BTWN 37TH AVE & 36TH AVE	10
NEC OF INT OF 31ST ST & BROADWAY	15
CET 8.02B	TOTAL 50

FOR INFORMATION ONLY
ENGINEER'S ESTIMATE OF QUANTITIES AND TYPES OF INTERFERENCE
TIME WARNER CABLE OF NEW YORK CITY
HWPEDSF1
Multi-Site Pedestrian Safety
Borough of Queens

CET ITEM	DESCRIPTION	UNITS	ESTIMATED QUANTITY
350	OVERHEAD ACCOMMODATION, PROTECTION OF OVERHEAD FACILITIES, POLES & APPURTENANCES	LS	1

**TIME WARNER CABLE
SUPPORT & PROTECTION.
HWPEDSF1
Multi-Site Pedestrian Safety
Borough of Queens**

CET 350	OVERHEAD ACCOMMODATION, PROTECTION OF OVERHEAD FACILITIES, POLES & APPURTENANCES	LS
	At the following locations:	
	AS ENCOUNTERED	1

Total quantity for CET 350 1

SECTION U-3

(NO TEXT IN THIS SECTION)

TEST PITS

- (1) THESE TEST PITS DETAIL EXISTING CONDITIONS (AS OF BID DATE) OF UTILITIES AND OTHER SUBSURFACE FACILITIES AT LOCATIONS AS SHOWN ON THE TEST PIT LOCATIONS PLAN OF THE CONTRACT DRAWINGS.
- (2) DEPTHS OF FACILITIES ARE FROM EXISTING ROADWAY AND SIDEWALK ELEVATIONS AS SHOWN, OFFSETS ARE FROM EXISTING CURB, PROPERTY AND BUILDING LINES, AS SHOWN.
- (3) RELEVANT ITEMS ARE NOTED ON EACH TEST PIT DIAGRAM.

(NO TEXT IN THIS SECTION)



JOB NO: HWPEDSF1

TEST PIT # 1

PREPARED BY: R. TENNEY

DATE: 4/11/2014

CHECKED BY: N. LEON

DATE: 4/14/2014

JOB NAME: PEDESTRIAN SAFETY 1

LOCATION: 6" N/S/C 39 AVE &

PURPOSE: LOCATE FACILITIES

21' W/W/C 31 ST

DATE OF EXCAVATION: 4/4/2014

CONTRACT SHEET NO: 17 OF X



39 AVENUE

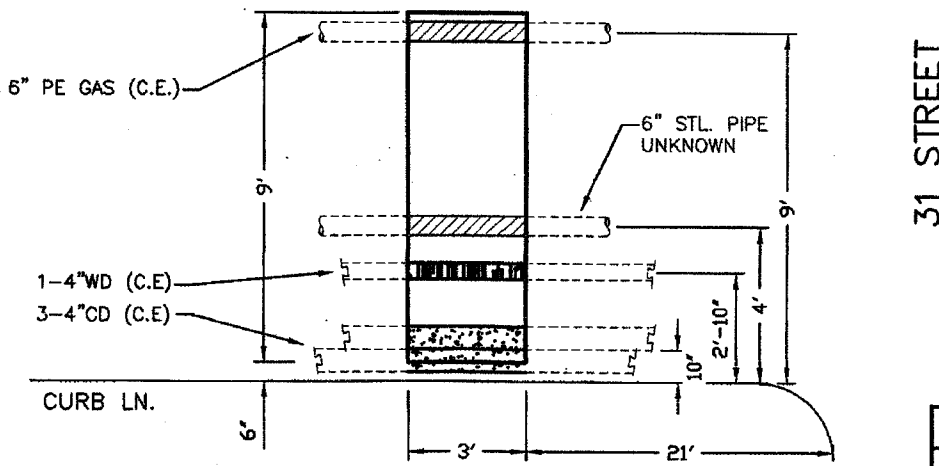

PLAN

N.T.S.

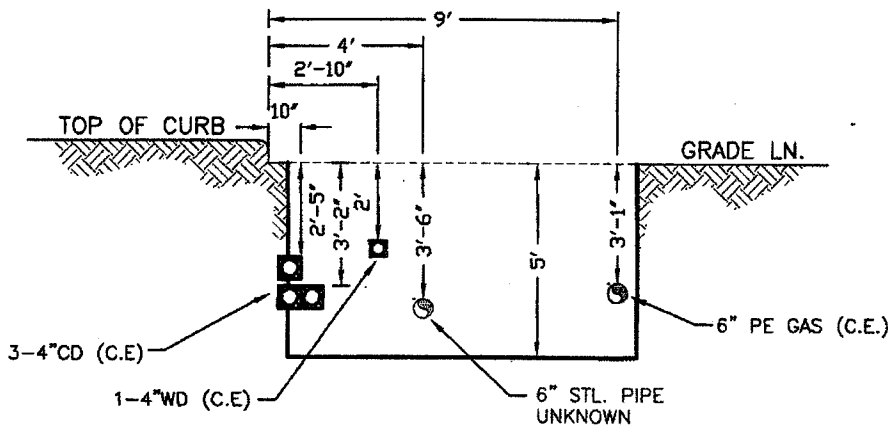

PROFILE - LOOKING WEST

N.T.S.



JOB NO: HWPEDSF1

TEST PIT # 2

PREPARED BY: R. TENNEY

DATE: 4/11/2014

CHECKED BY: N. LEON

DATE: 4/11/2014

JOB NAME: PEDESTRIAN SAFETY 1

LOCATION: 6" S/N/C 39 AVE &

PURPOSE: LOCATE FACILITIES

21' W/W/C 31 ST

DATE OF EXCAVATION: 4/4/2014

CONTRACT SHEET NO: 17 OF X



31 STREET

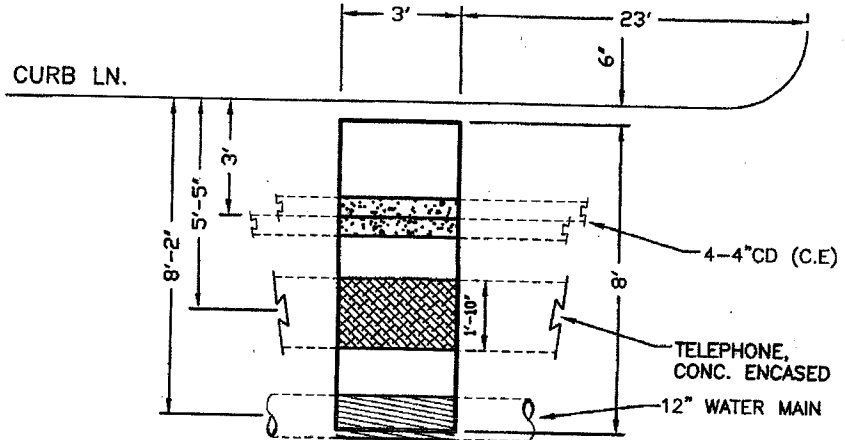

39 AVENUE

PLAN

N.T.S.

CET

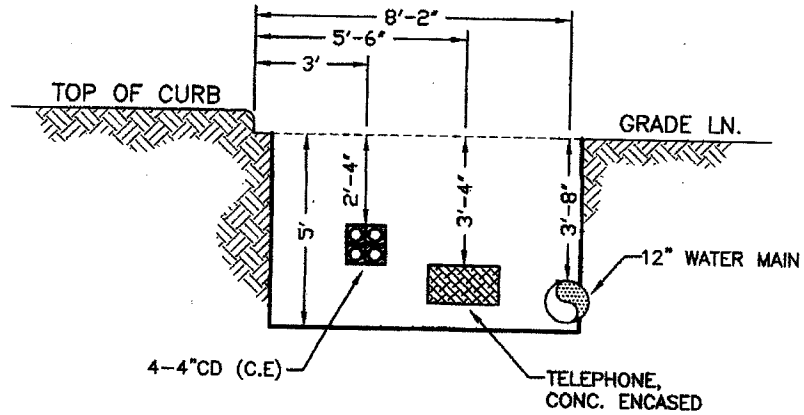

PROFILE - LOOKING EAST

N.T.S.



JOB NO: HWPEDSF1

TEST PIT # 7

PREPARED BY: R. TENNEY

DATE: 4/15/2014

CHECKED BY: N. LEON

DATE: 4/16/2014

JOB NAME: PEDESTRIAN SAFETY 1

LOCATION: 6" S/N/C 36 AVE &

PURPOSE: LOCATE FACILITIES

23' W/W/C 31 ST

DATE OF EXCAVATION: 4/4/2014

CONTRACT SHEET NO: 8 OF X

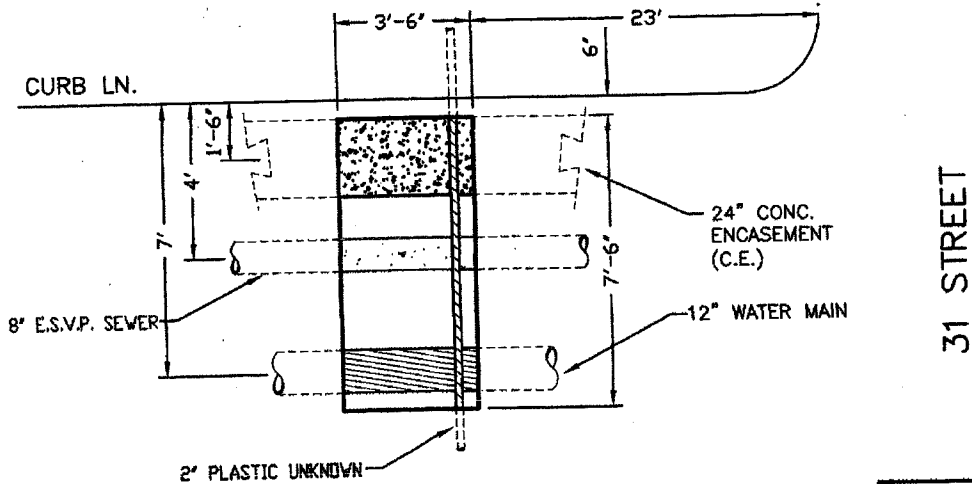

**36 AVENUE
PLAN**

N.T.S.

CET

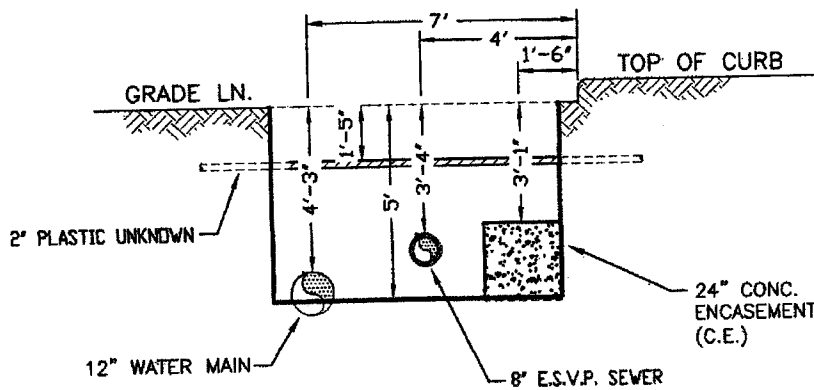

PROFILE - LOOKING WEST

N.T.S.



JOB NO: HWPEDSF1

TEST PIT # 9

PREPARED BY: R. TENNEY

DATE: 4/17/2014

CHECKED BY: N. LEON

DATE: 4/17/2014

JOB NAME: PEDESTRIAN SAFETY 1

LOCATION: 29' N/N/C 36 AVE &

PURPOSE: LOCATE FACILITIES

2' W/E/C 31 ST

DATE OF EXCAVATION: 4/7/2014

CONTRACT SHEET NO: 18 OF X

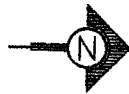

31 STREET

36 AVENUE

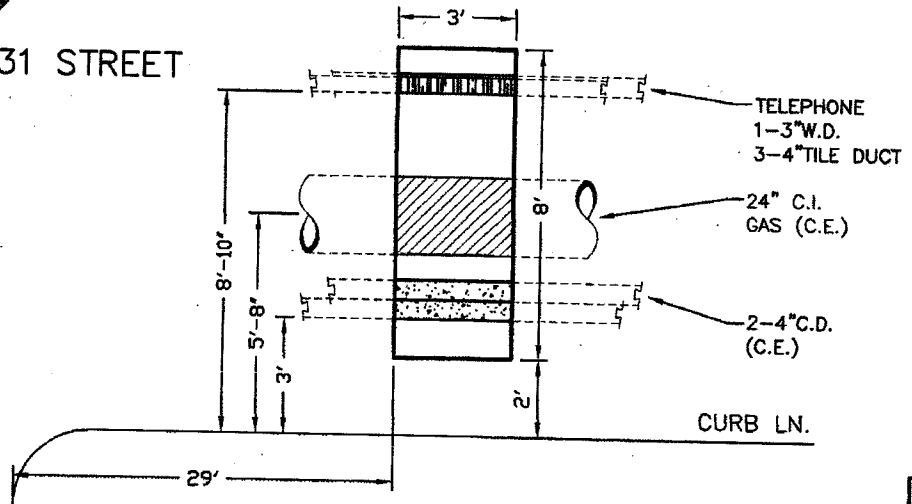

PLAN

N.T.S.

CET

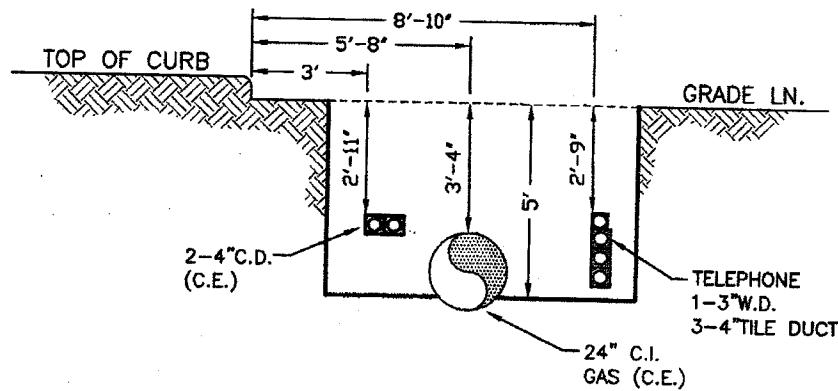

PROFILE - LOOKING SOUTH

N.T.S.



JOB NO: HWPEDSF1

TEST PIT # 13

PREPARED BY: R. TENNEY

DATE: 4/4/2014

CHECKED BY: N. LEON

DATE: 4/4/2014

JOB NAME: PEDESTRIAN SAFETY 1

LOCATION: 1'6" S/N/C BROADWAY &

PURPOSE: LOCATE FACILITIES

32' E/E/C 31 ST

DATE OF EXCAVATION: 3/26/2014

CONTRACT SHEET NO: 19 OF X

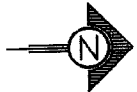

31 STREET

BROADWAY

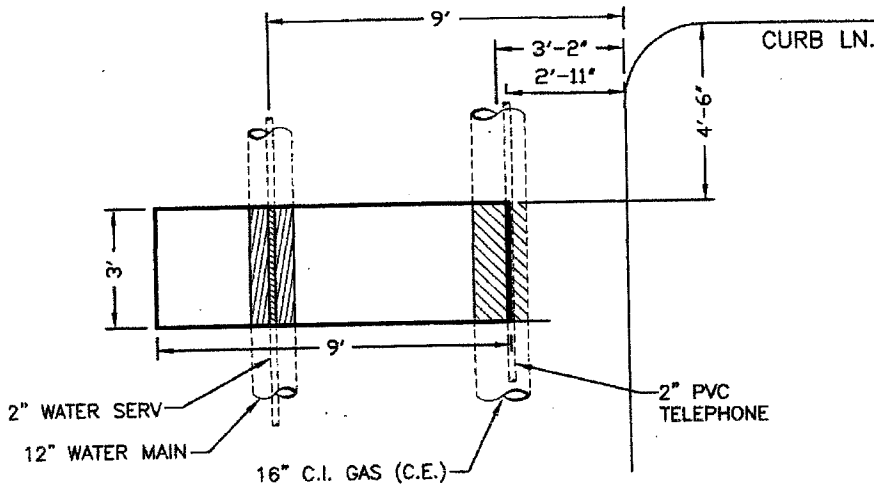

CET

PLAN
N.T.S.

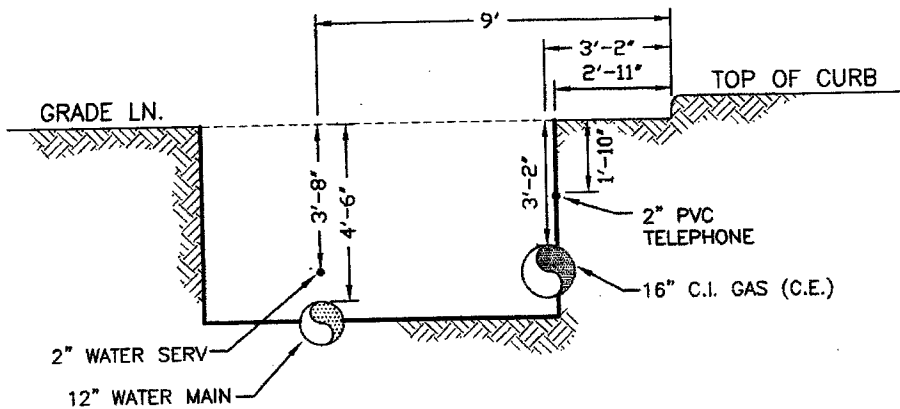

PROFILE - LOOKING WEST
N.T.S.



JOB NO: HWPEDSF1
PREPARED BY: R. TENNEY
CHECKED BY: N. LEON

TEST PIT # 15
DATE: 4/4/2014
DATE: 4/4/2014

JOB NAME: PEDESTRIAN SAFETY 1
PURPOSE: LOCATE FACILITES
DATE OF EXCAVATION: 3/26/2014

LOCATION: 92' S/S/C BROADWAY &
1' W/E/C 31 ST
CONTRACT SHEET NO: 19 OF X



31 STREET

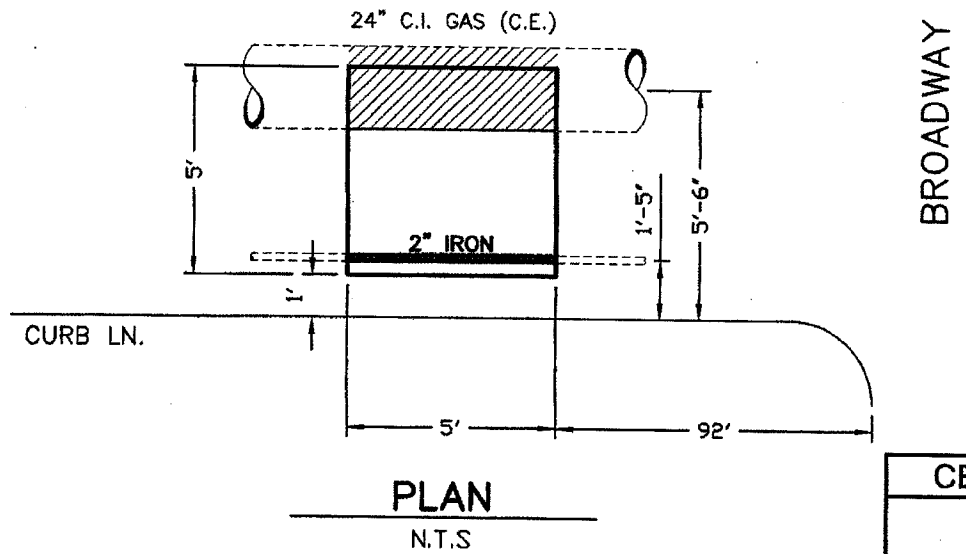

BROADWAY

CET

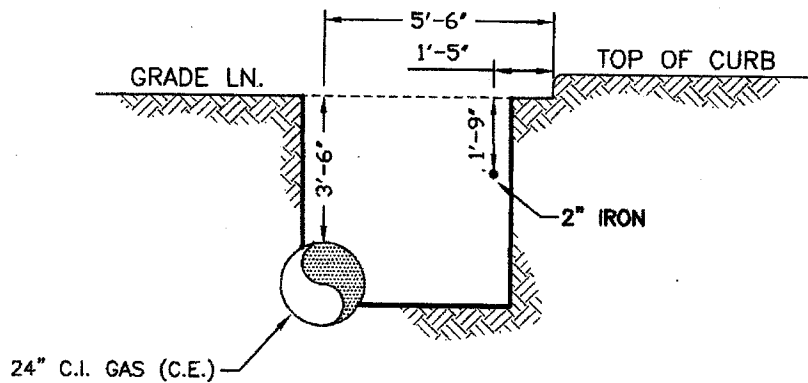



SHEET NO. 1 OF 1

JOB: PEDESTRIAN SAFETY, QUEENS PREPARED BY: ANDREW MATARAZZO DATE: 03-10-14

JOB NO: HWPEDSF1 CHECKED BY: LIAM MADDEN DATE: 03-11-14

TEST PIT #1 LOCATION: AT THE INTERSECTION OF 39TH AVENUE AND 31ST STREET
PURPOSE: LOCATE UTILITIES

TRENCH DIMENSIONS
10'-0" X 4'-6" X 3'-0"

39TH AVENUE

31ST STREET

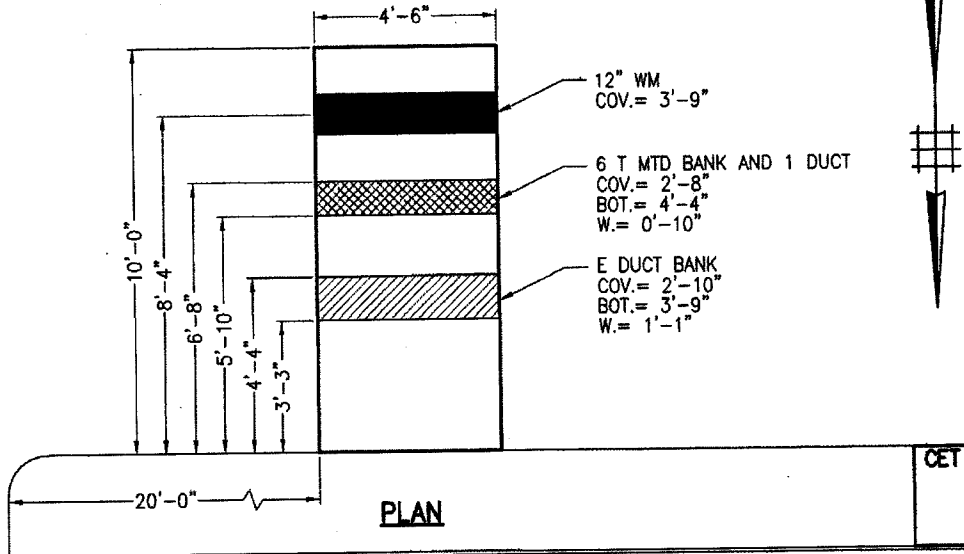

PLAN

SIDEWALK

CURB

ROADWAY

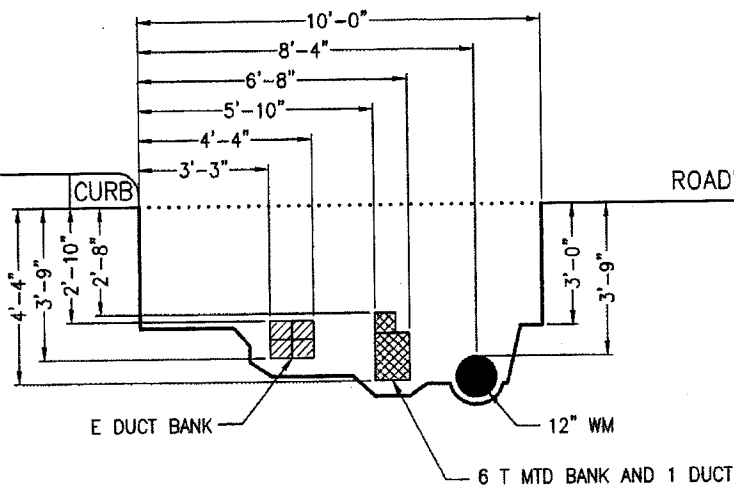

SECTION LOOKING EAST



SHEET NO. 1 OF 1

JOB: PEDESTRIAN SAFETY, QUEENS PREPARED BY: ANDREW MATARAZZO DATE: 03-10-14

JOB NO: HWPEDSF1 CHECKED BY: LIAM MADDEN DATE: 03-11-14

TEST PIT #2 LOCATION: AT THE INTERSECTION OF BROADWAY AND 31ST STREET
PURPOSE: LOCATE UTILITIES STREET

TRENCH DIMENSIONS
10'-0" X 5'-0" X 5'-0"

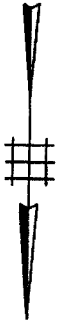
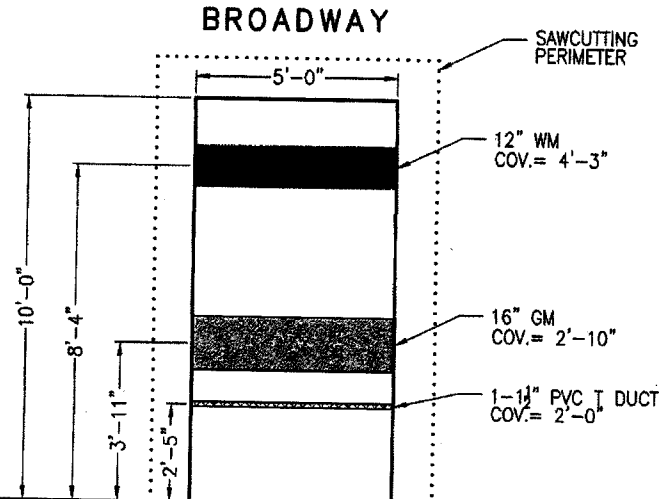

31ST STREET

PLAN

CET ITEM

25'-0"

SIDEWALK

CURB

ROADWAY

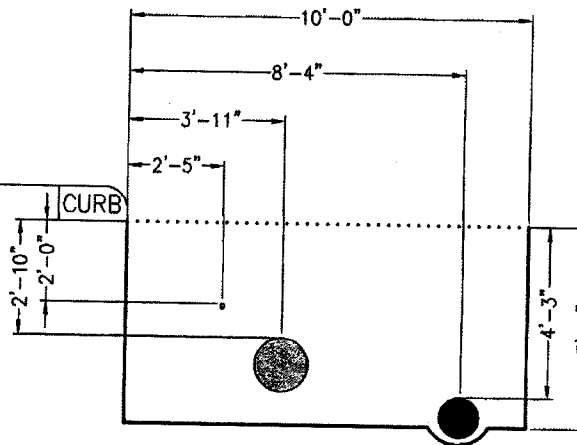

SECTION LOOKING EAST



JOB: PEDESTRIAN SAFETY, QUEENS PREPARED BY: ANDREW MATARAZZO DATE: 03-10-14

JOB NO: HWPEDSF1 CHECKED BY: LIAM MADDEN DATE: 03-11-14

TEST PIT #3 LOCATION: 55'-0" WEST OF INTERSECTION OF BROADWAY AND 31ST STREET
PURPOSE: LOCATE UTILITIES

TRENCH DIMENSIONS
10'-0" X 5'-0" X 4'-0"

SAWCUTTING PERIMETER

BROADWAY

31ST STREET

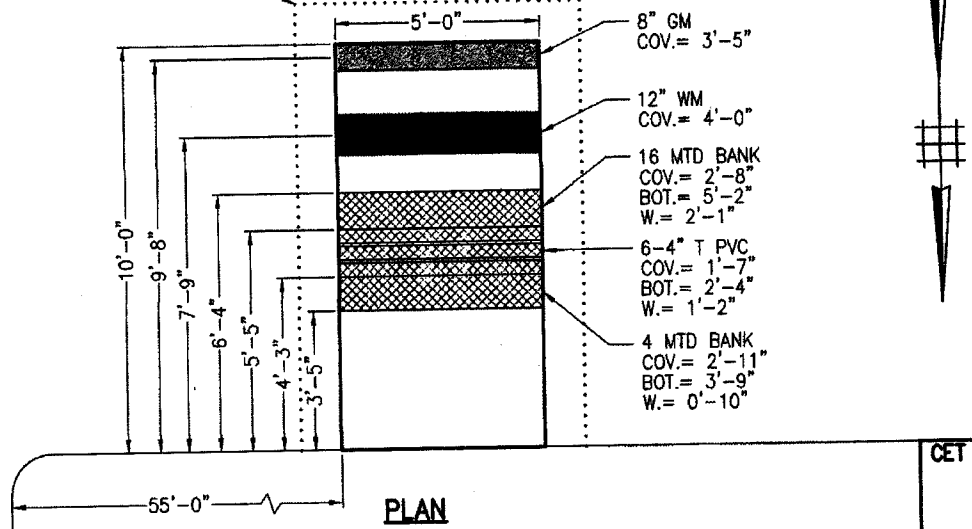

PLAN

SIDEWALK

CURB

ROADWAY

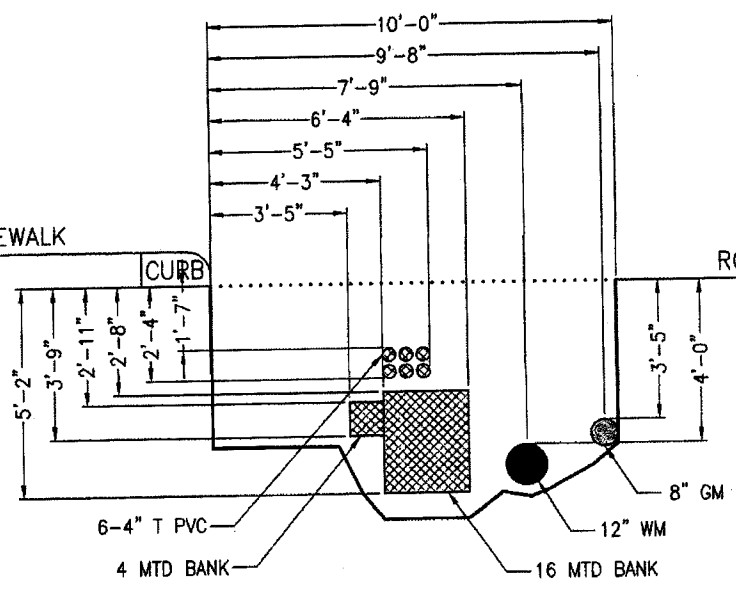

SECTION LOOKING EAST

END OF ADDENDUM No.4
This Addendum consists of Forty-Seven (47) pages
And Seven (7) sheets of Contract Drawings

NO TEXT THIS PAGE





NEW YORK CITY DEPARTMENT OF
DESIGN + CONSTRUCTION

**INFRASTRUCTURE DIVISION
BUREAU OF DESIGN**

VOLUME 3 OF 3

PROJECT ID: HWPEDSF1

MULTI-SITE PEDESTRIAN SAFETY
WHICH INCLUDES THE FOLLOWING INTERSECTIONS:

31ST STREET AND 39TH AVENUE
31ST STREET AND 36TH AVENUE
31ST STREET AND BROADWAY

INCLUDING BUS BULBOUTS, CURB EXTENSIONS, BUS PADS,
PEDESTRIAN RAMPS, CATCH BASINS, PAVEMENT MARKINS,
STREET LIGHTING, AND TRAFFIC SIGNAL WORK

Together With All Work Incidental Thereto
BOROUGH OF QUEENS
CITY OF NEW YORK

Contractor.

Dated _____, 20____
